

2024

DUCTED & CASSETTE AIR CONDITIONER



LG Electronics

www.lge.com/au
<http://partner.lge.com/au/index.lge>

Distributed by

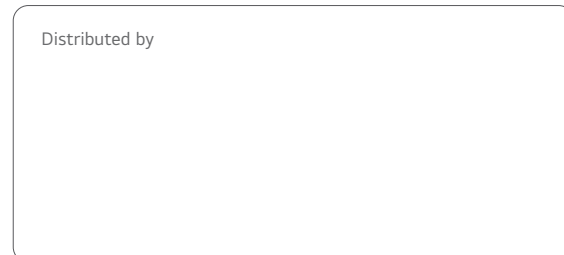

CONTENTS

INTRODUCTION 04

Highlights of LG Single Split
Line-up & Feature Overview



INDOOR UNIT 16

Ceiling Concealed Ducted
High Static Splittable Ducted
Ceiling Mounted Cassette

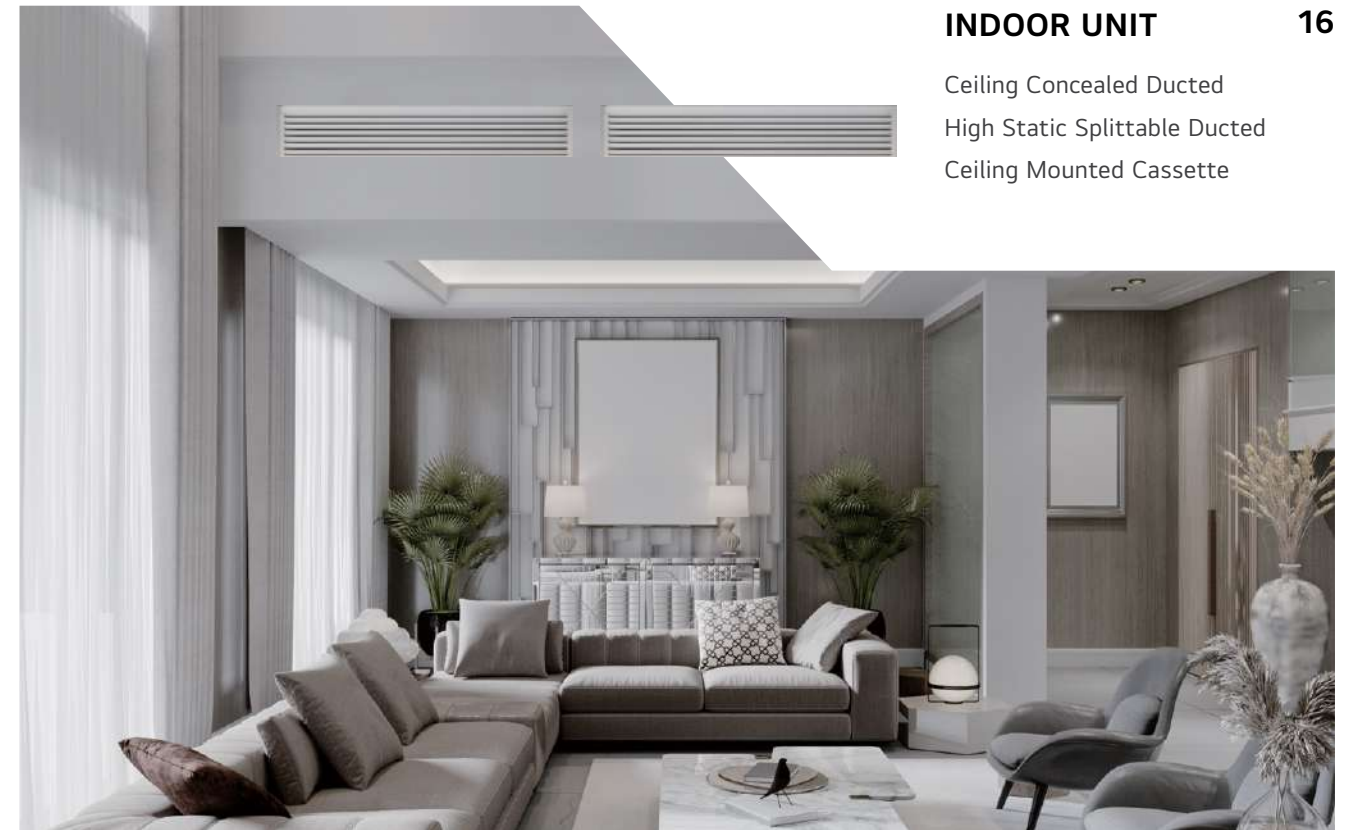

KEY FEATURES 08

High Performance
Comfortable Environment
Convenient Control System



ThinQ

In just a few quick steps, control all your LG ThinQ enabled LG devices from your smartphone or via your voice for the truly connected home experience.



HIGHLIGHTS OF LG SINGLE SPLIT

R1 Compressor™

R1 Compressor is one that combines high-efficiency and the simple compressing structure.

- Assuring Higher Durability
- Lower Noise
- Lower Vibration
- Improve Reliability & Performance

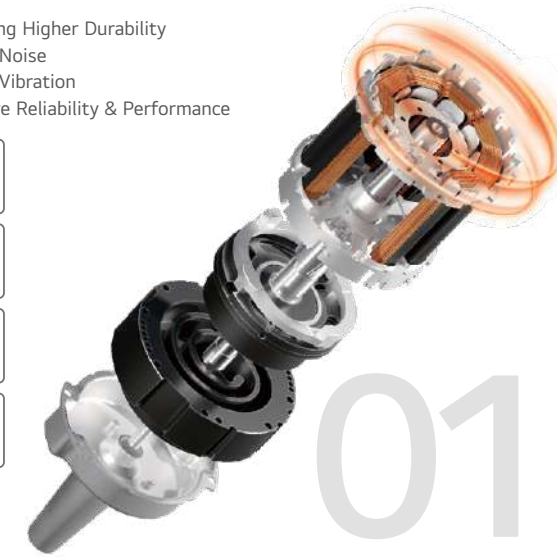

01

Twin Rotary Inverter Compressor

Twin Rotary Inverter Compressor consists of stable and optimized structures with low vibration and low noise characteristic

- Twin Rotor
- Refrigerant Cycle Optimization
- Surface Coating
- Concentric Motor



02

Black Fin

Longer Lifespan, Lower Maintenance Costs

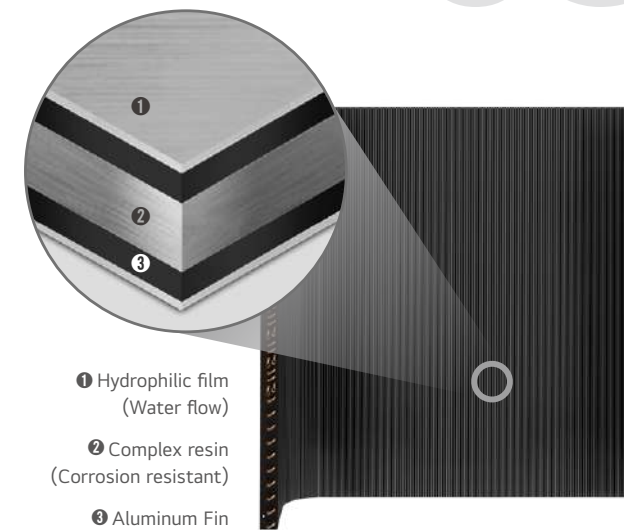

03

Drain Pump

LG's low to mid-static ducted units have a built in drain pump.

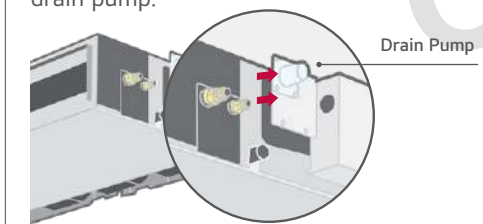

04

Short Depth for Flexible Installation

Short depth of Low-Static ducted help to give a flexibility for limited space of ceiling in apartment.

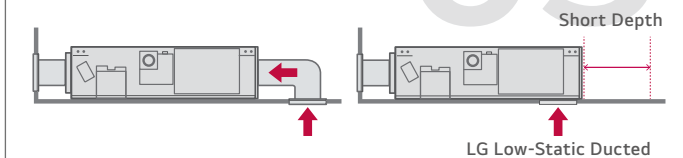

05

AUTO External Static Pressure + Zone Control (On/Off)

High Static Ducted unit can control airflow depending on the number of opening dampers. (Plug & Play (24V) PBZD80)

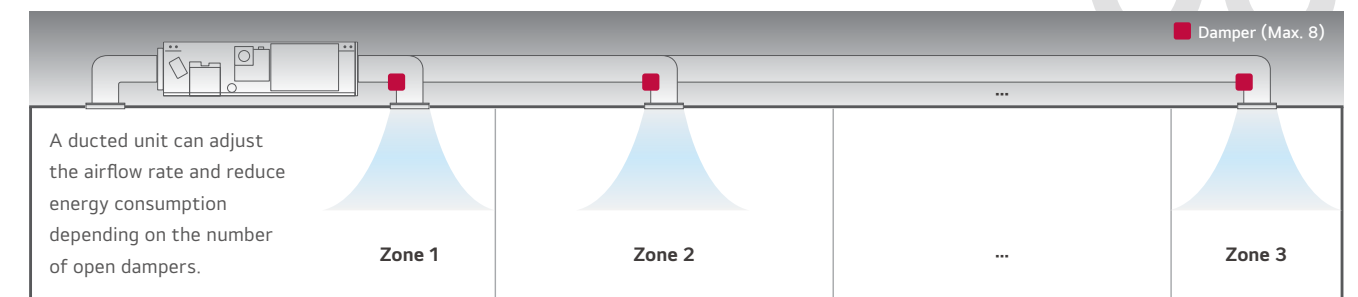

06



SINGLE SPLIT									
Refrigerant	Cooling kW	kBTu/h	Outdoor Unit		Ceiling Mounted Cassette	Ceiling Concealed Ducted			
			1ph	3ph		Low Static	Mid Static	High Static	High Static Splittable (1ph / 3ph)
R32	2.5	9	 • UU25WR2			 • UBN25L5			
	3.4	12	 • UU35WR2			 • UBN35L5			
	5.0	18	 • UU50WR2			 • UBN50L6			
	6.8	24	 • UU70WR2		 • UTN70PB		 • UMN70M1		
	8.5	30	 • UU85WR3		 • UTN85PB		 • UMN85M1	 • UHN85B7	 • UHN85M2S (1ph)
	9.5 ~ 10.5	36	 • UU100WR3	 • UU100WR3L	 • UTN100MA		 • UMN100M2	 • UHN100B7	 • UHN100M2S (1ph / 3ph)
	12.3 ~ 12.5	42	 • UU125WR3	 • UU125WR3L	 • UTN125MA		 • UMN125M2	 • UHN125B7	 • UHN125M3S (1ph / 3ph)
	13.8 ~ 14	48	 • UU140WR3	 • UU140WR3L	 • UTN140MA		 • UMN140M3		 • UHN140M3S (1ph / 3ph)
	15 ~ 15.2	55	 • UU150WR3	 • UU150WR3L				 • UHN150B7	 • UHN150M3S (1ph / 3ph)
	R410A	18.0	62		 • B62AWYU7L6			 • B62AWYN9L6 (3ph)	
20.0		70		 • B70AWYU7L6			 • B70AWYN9L6 (3ph)		

CATEGORY	DUCTED											
	CASSETTE											
	R32							R410A				
Cooling kW	2.5	3.4	5.0	6.8	8.5	9.5-10.5	12.3-12.5	13.8-14	15-15.2	18.0	20.0	
High Performance & Reliability	Inverter Scroll									•	•	
	R1 Compressor						•	•	•	•		
	Twin Rotary Compressor	•	•	•	•	•						
	Corrosion resistance Black Fin	•	•	•	•	•	•	•	•	•		
	Gold Fin										•	•
	Long Pipe Installation	•	•	•	•	•	•	•	•	•	•	•
Convenient Control System	LG ThinQ*	•	•	•	•	•	•	•	•	•	•	
	Easy control (PI-485 Connection)	•	•	•	•	•	•	•	•	•	•	
	Wi Fi Optional Accessory	•	•	•	•	•	•	•	•	•	•	
	Mobile LG MV Optional Accessory	•	•	•	•	•	•	•	•	•	•	
	Zone Control** (Open/Close) Optional Accessory				•	•	•	•	•	•	•	
	Drain Pump In built Low-Mid static	•	•	•	•	•	•	•				
	Drain Pump Optional Accessory High Static					•	•	•	•	•	•	
	Auto ESP Setting Mid- High static				•	•	•	•	•	•	•	
	Comfort Cooling with Humidity sensor***				•	•	•	•	•			
	Night Operation			•	•	•	•	•	•			
Additional Application	Synchro function^						•	•	•	•		
	UV nano Filter Box+				•	•	•	•	•			
Quality Air	Air Purification kit++				•	•	•	•	•			
	Humidity sensing+	•	•	•	•	•	•	•	•	•	•	
Convenient Feature	Floor Sensing++				•	•	•	•	•			
	Human Detect sensing++				•	•	•	•	•			
	Dual Sensing+++	•	•	•	•	•	•	•	•	•	•	

* Available with LG Wi-Fi modem (PWFMD200) and it should be connected to the indoor unit
 ** With controller PREMTB101 / PREMTA000
 *** Available only for Ceiling Mounted cassette (840 x 840)
 + Available except for Wall Mounted Unit.
 ++ Cassette Optional Accessory needed
 ***** Weekly program is available with wired remote controller

+++ Cassette embeded feature, Ducted PREMTB101 / PREMTA000 needed
 ^ Outdoor unit based, refer page 19

R1 Compressor™

R1 Compressor is one that combines high-efficiency, low sound characteristics of the scroll and the simple compressing structure of the rotary compressor. This technology enables a highly efficient compact model.

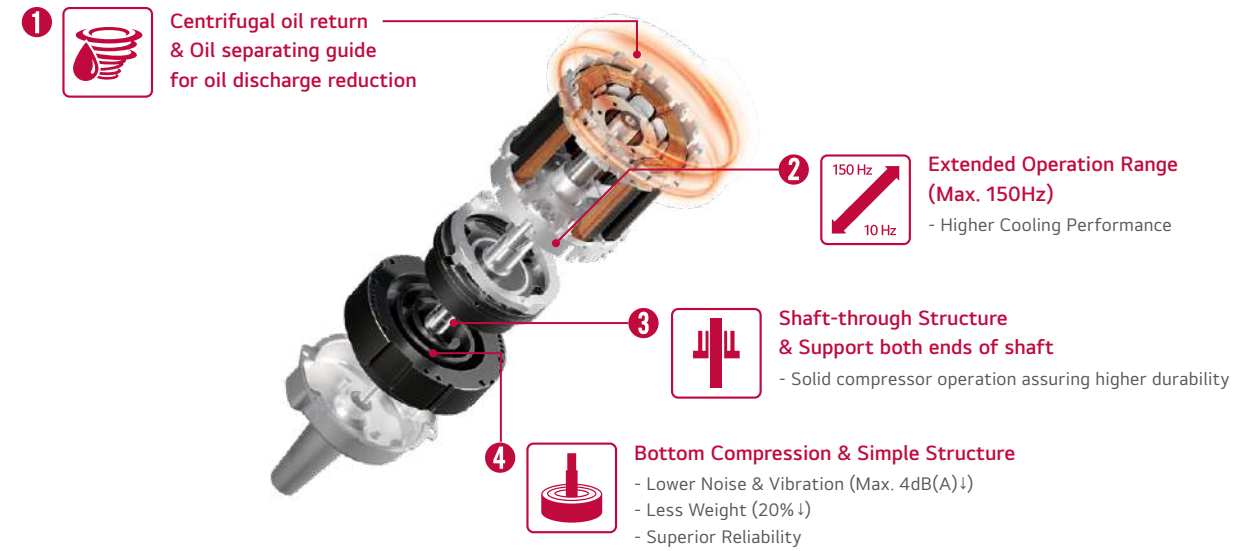

Conventional Compressor

Scroll
High efficiency / Low sound (Continuous compression, but complex structure)

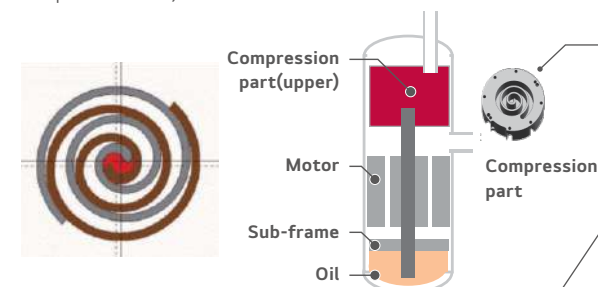

Rotary : Simple structure (Compression per 1 rotation)

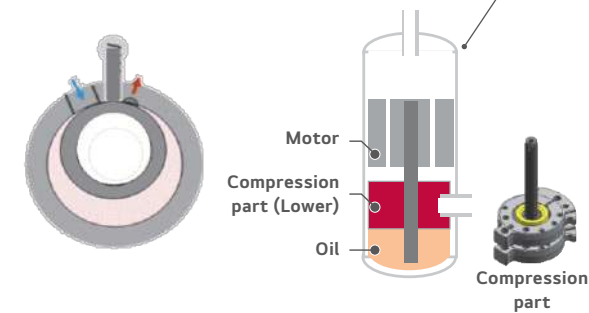

R1 Compressor™

Revolutionary Scroll
High efficiency / Stable & Simple Structure

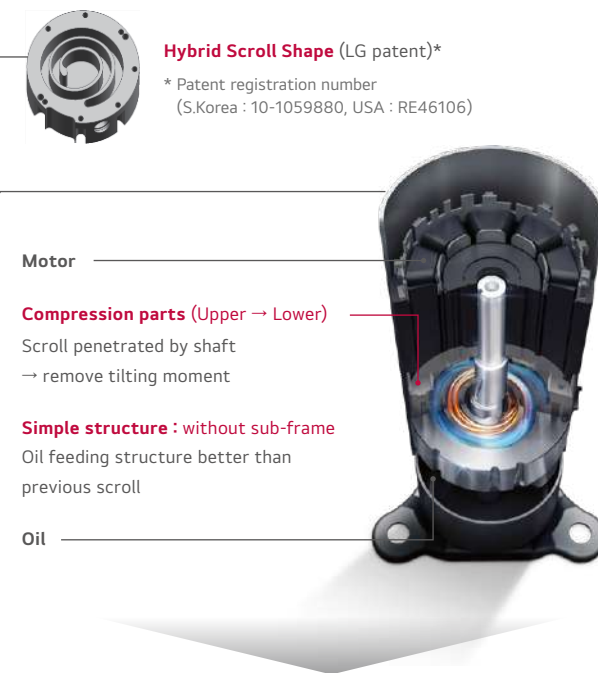

Extended operation (Max. 150Hz)
Low noise & Vibration (Max. 4dB(A)↓)
Less weight (20%↓)

Twin Rotary Inverter Compressor

Twin Rotary Inverter Compressor consists of stable and optimised structures with low vibration and low noise characteristic



Twin Rotor

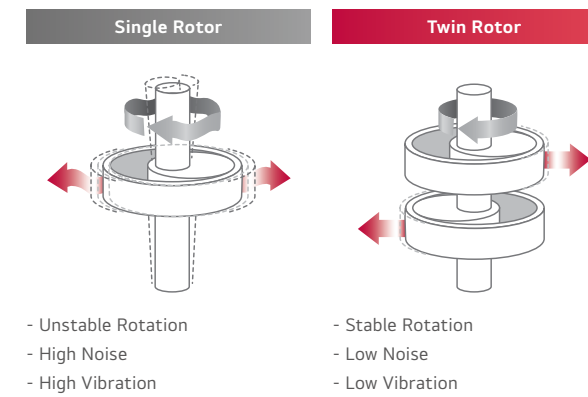

Refrigerant Cycle Optimization

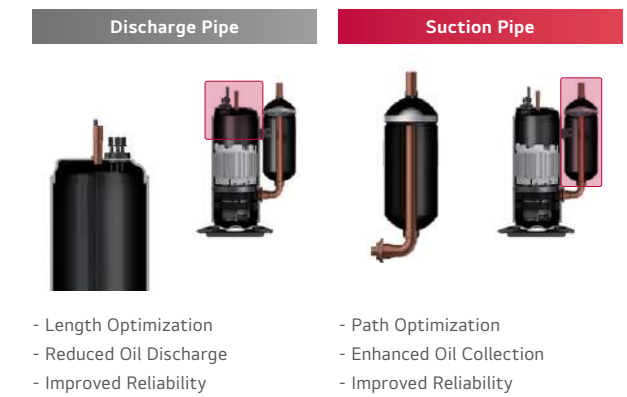

Surface Coating

- High Abrasion Resistance

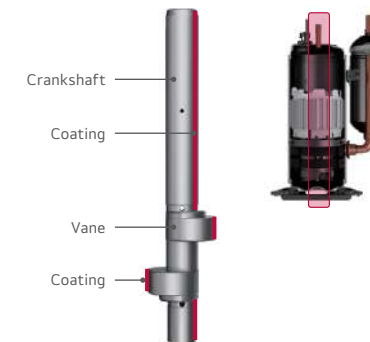

Concentric Motor

- Increased Stator Cavity
- Improved Oil Path Area
- Reduced Calorific Value



Quick & Reliable Operation

Through pressure and temperature sensing, the desired indoor temperature can be reached more rapidly.

- Quick response due to sensing with ready for operation.
- Target performance point is reached while avoiding compressor damage from liquid compression or oil shortage.

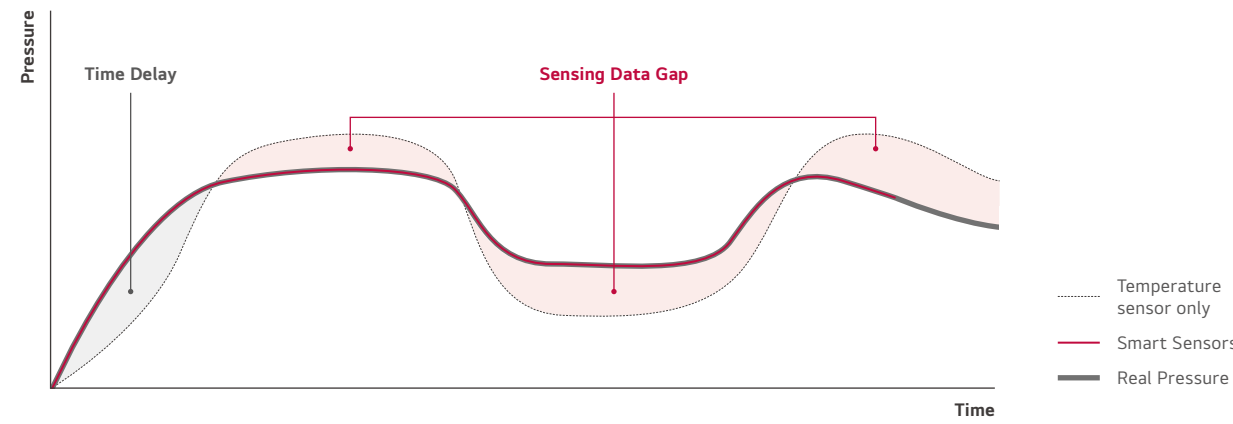
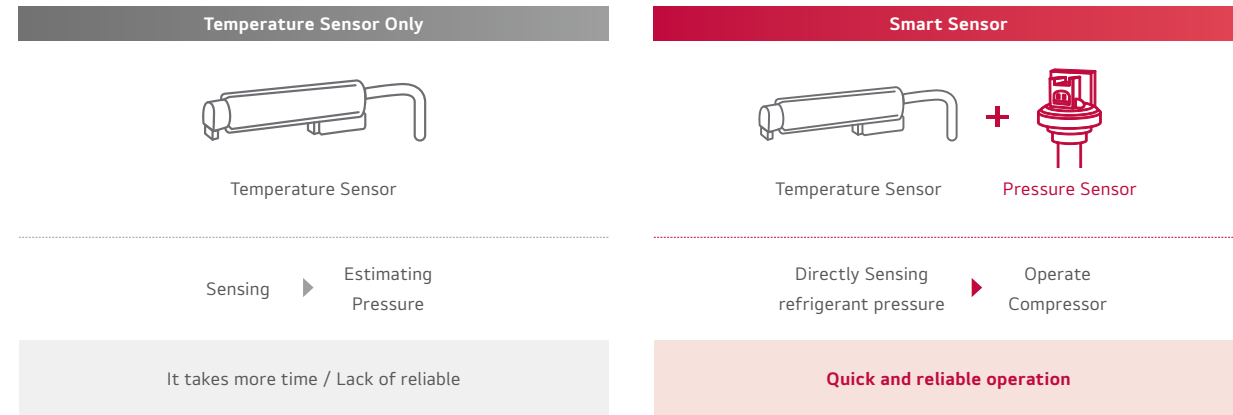

- With pressure sensing, the desired temperature is achieved in 30% less time in cooling and 44% in heating.

Corrosion Resistance Black Fin

The black coating with enhanced epoxy resin is applied for strong protection from various corrosive external conditions such as salt contamination and air pollution including fumes from factories.

Longer Lifespan, Lower Maintenance Costs

Hydrophilic film (Water flow)

The Hydrophilic coating minimizes moisture buildup on the fin.

Complex resin (Corrosion resistant)

The Black coating provides strong protection from corrosion.

Aluminum fin

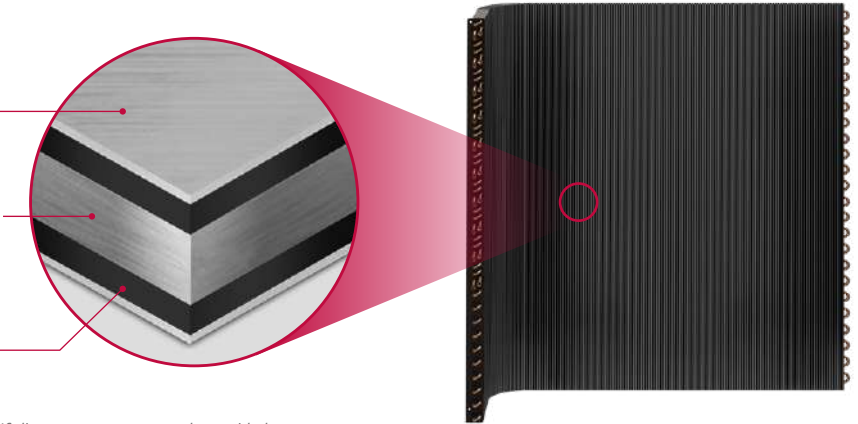

- ※ Direct exposure to sea wind must be avoided. If direct exposure cannot be avoided, then a solid windbreak such as concrete (150% Width & Height) must be built 70cm distance from the outdoor unit.
- ※ Periodic cleaning of the dust or salt particles on the heat exchange is necessary. Clean with water at least once every 6 months.

Verified Protection



- ※ Verification of corrosion resistance performance
- Test Method B of ISO21207
- ASTM B117 / ISO 9227 (10,000 hours)

Long Pipe Installation

Maximum pipe length up to 85m and elevation length up to 30m provides flexibility for various conditions and easy installation.

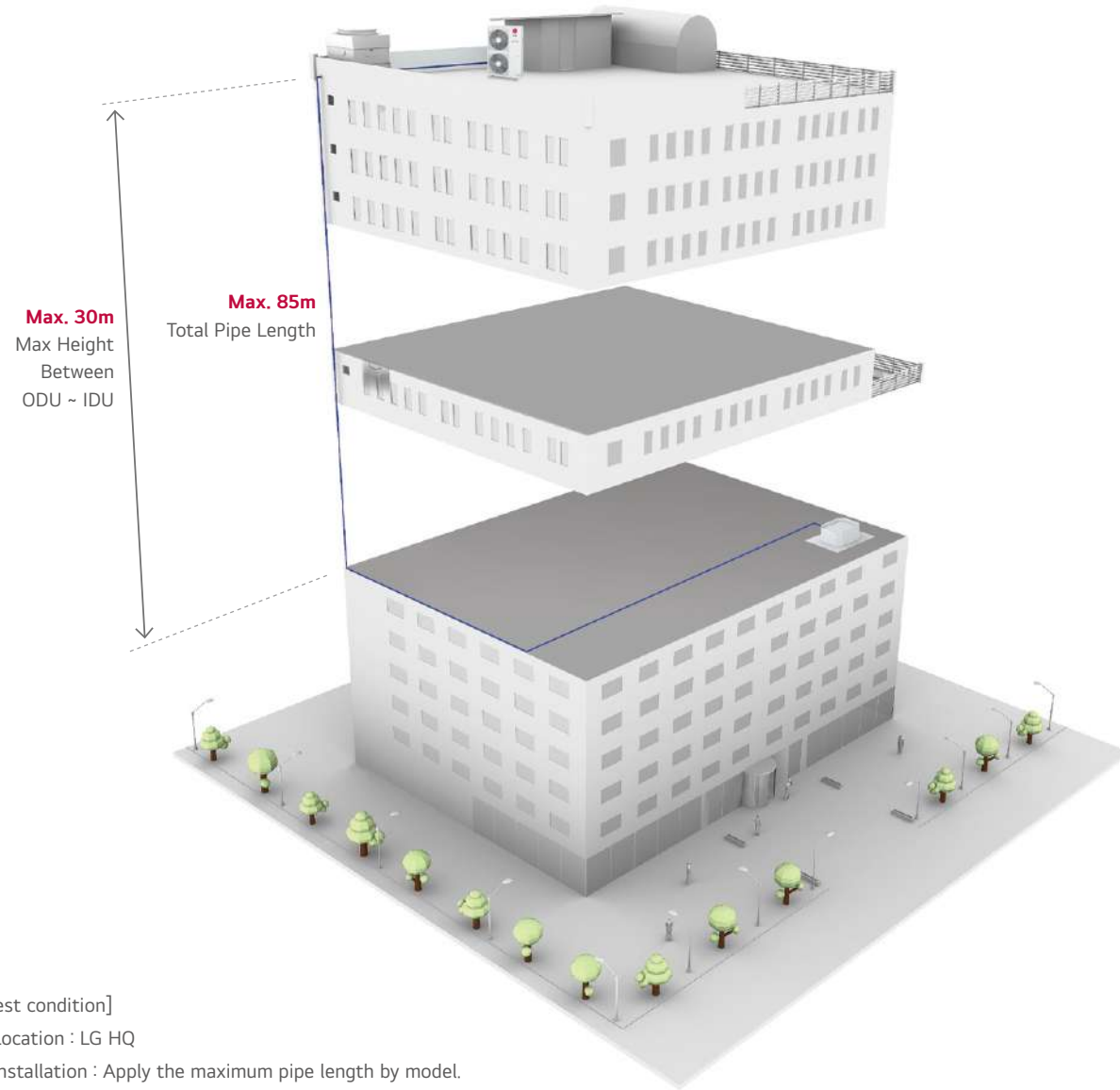

[Test condition]

- Location : LG HQ
- Installation : Apply the maximum pipe length by model.
- Period : 3 month (Checking oil level in real time)
- No use U-Trap

Capacity (kW)	2.5	3.5	5.0	7.0	8.5	10.0	12.5	14.0	15.0
Maximum pipe length	30 m	30 m	30 m	50 m	50 m	85 m	85 m	85 m	85 m
Maximum Height Difference (ODU-IDU)	30 m	30 m	30 m	30 m	30 m	30 m	30 m	30 m	30 m

Night Operation

Night Operation can reduce noise levels at night time by simply setting the dip switch on the PCB of the outdoor unit.

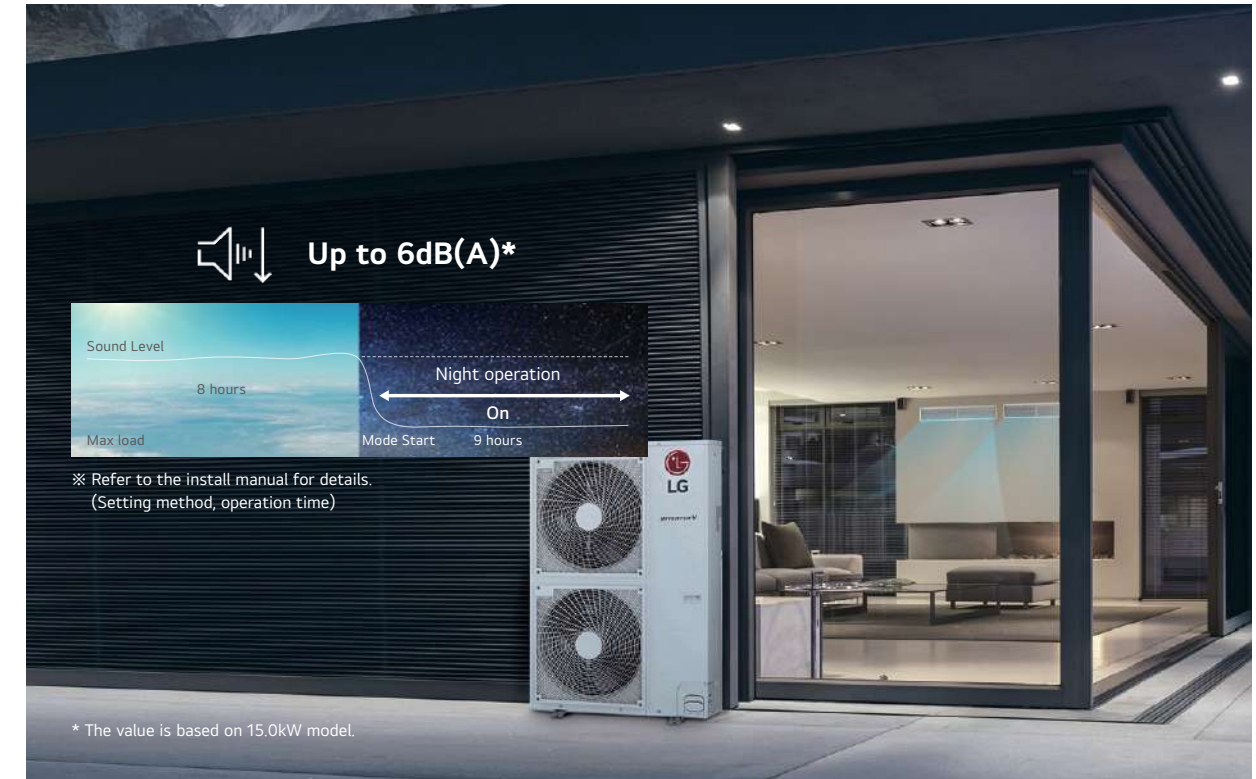

Easy Control (Central Controller)

PI-485 is a gateway device that provides communication between LG Outdoor Units and LG central controllers such as ACP, AC Smart.

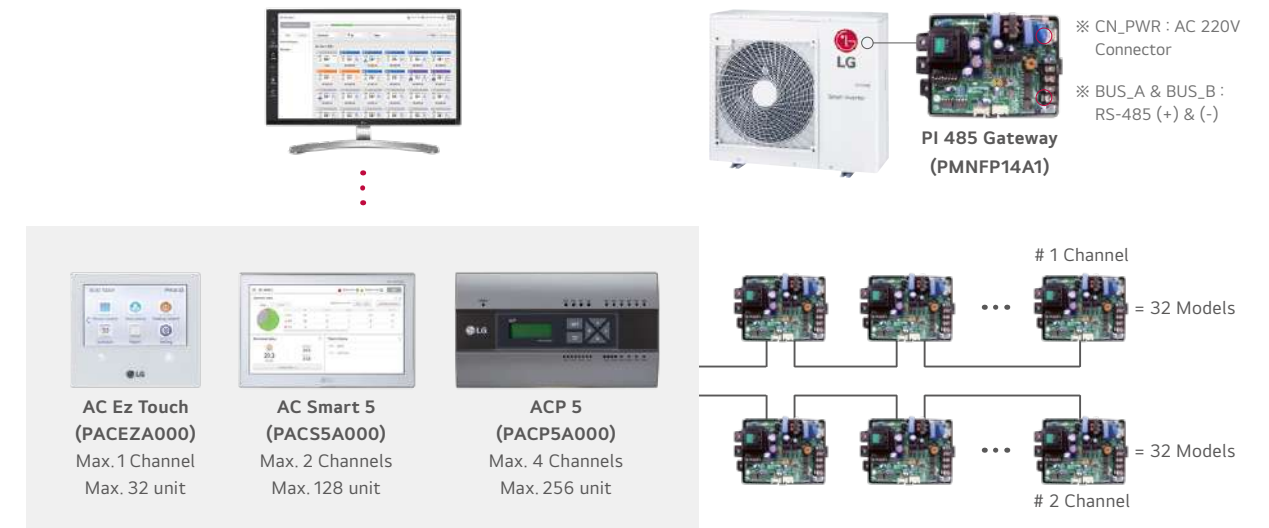

ThinQ™

Users can control air conditioners using compatible Android or iOS-enabled smartphones and voice commands via Google Assistant and Amazon Alexa.#

Download on the App Store

GET IT ON Google Play

Controlling & Monitoring

Reservation

Energy Monitoring

Access your air conditioner anytime and from anywhere

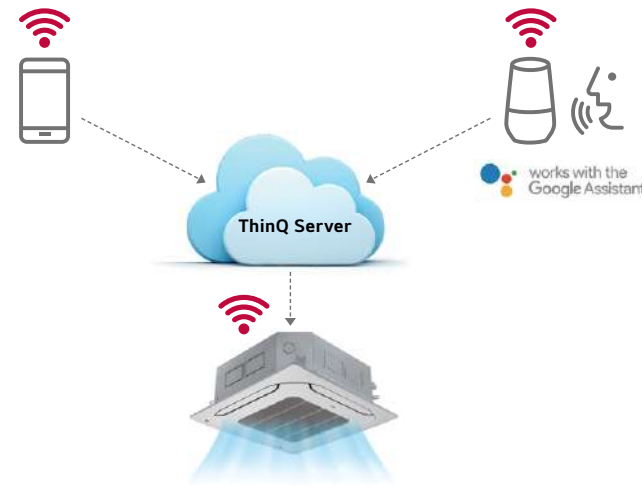

Simple operation for various functions

- Air Purify*
- Current temperature*
- Set fan speed*
- On / Off*
- Set temperature*
- Vane Control
- Mode Selection*

* This functions are used by Google Assistant*

Search "ThinQ" on Google or Apple store then download the app.
 ※ Wi-Fi modem (PWFMD200) is required. (sold separately)
 ※ For our policy of continuous ThinQ App improvement, specification, design and features are subject to change without prior notice.
 ※ LG ThinQ app available on Android or iOS smartphones. Compatible smartphone with Android 4.1.2 (Jellybean) or later or iOS 9 or later required for LG ThinQ app.

Product registration using LG Smart ThinQ, Google Assistant, Amazon Alexa™ apps required. Google or Amazon Accounts (as applicable) needed. Internet connection, data usage charges and conditions apply. Controlling devices and features requires compatible smart devices not included with the product. Google is a trademark of Google LLC. Amazon, Alexa and all related logos are trademarks of Amazon.com Inc. or its affiliates.

Mobile LGMV

LGMV(Monitoring View) helps engineers to inspect and monitor air conditioning unit easily.



Cycle Monitoring

Diagnosis

Installation

Smart Management

Error Indicator

Contents	
01	Air temperature sensor of indoor unit
02	Inlet pipe temperature sensor of indoor unit
03	Communication error : Wired Remote Controller ↔ Indoor Unit
⋮	

A technician not only can check the cycle information with diagrams & graph, but also check easily the error status (Troubleshooting guide) and take action immediately.

- ※ Search "Mobile LGMV" on Google or Apple store then download the app.
- ※ LGMV Module is required by option.

Trouble Diagnosis (Black Box Function)

The operation status is recorded until a malfunction occurs.

Service engineer can analyze the malfunction cause more easily during maintenance.

Traditional Diagnosis

Service engineer has to look for many causes of failure one by one.

Too much effort is required to diagnose the source of trouble

LG Black Box Function

Service engineer can diagnose malfunction causes using recorded data.

Save time & improve accuracy of malfunction diagnosis

The operation status has been recorded up to 3minutes before failure.

Service engineer can check recorded data through smartphone when Wi-Fi module is installed in outdoor unit.

CEILING CONCEALED DUCTED

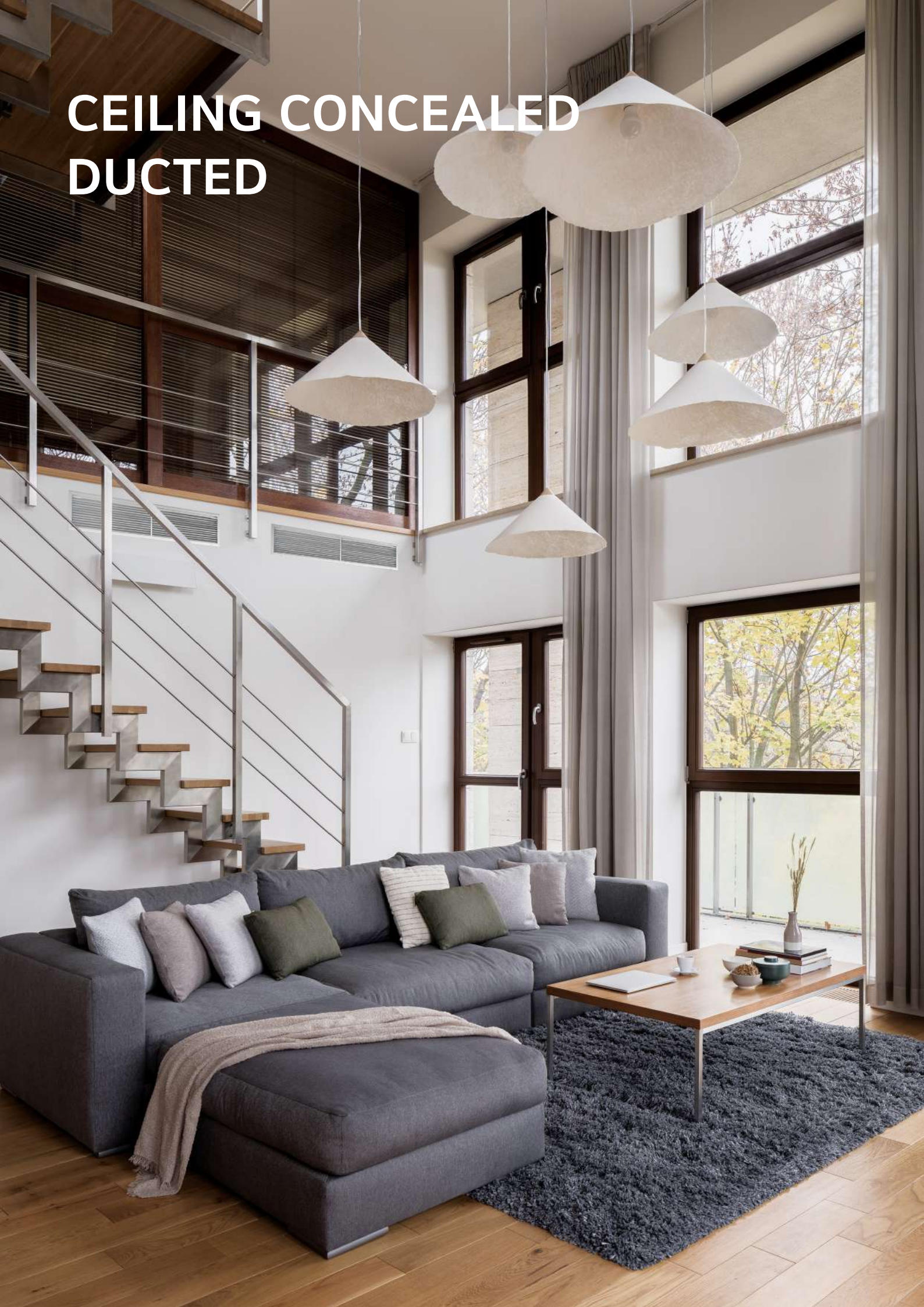

UVnano™ Filter Box (Optional Accessory*)

LG UVnano Filter Box can effectively create a safe indoor environment by trapping and removing various harmful substances such as Ultrafine dust, bacteria and viruses in the form of droplets.

* Sold separately, only applicable to Mid Static UMN models

Air Purification Operation

Air Supply

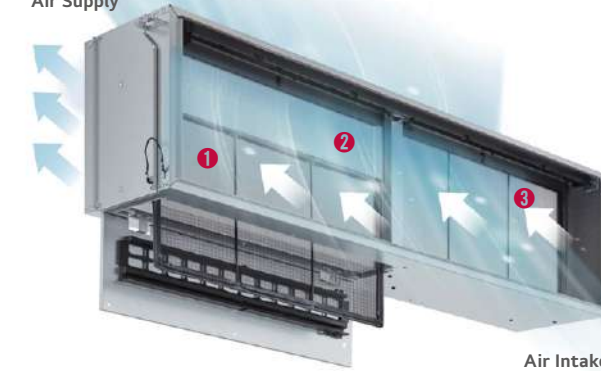

Step 1

Pre-Filter

- Trap large particles
- Fine dust
- Bacteria
- Viruses in the form of droplets



Step 2

UVnano

- Sterilize bacteria and viruses parasitized on bacteria up to 99.99%¹⁾ by irradiating ultraviolet rays



Step 3

ePM₁ 65% Filter

- Trap particles as small as 0.3µm in size²⁾



- 1) Based on TÜV Rheinland test conducted according to LG test method in compliance with ISO 20743, removing 99.99 of percent of Staphylococcus aureus, Staphylococcus epidermidis, and Klebsiella pneumoniae after being exposed to UV LED lights for 4 hours (Tested Models : PBM13M3UA0, PBM13M2UA0, PBM13M1UA0)
- 2) Based on KCL (Korea Conformity Laboratories) test conducted in compliance with ISO 16890

Certificate



Certified Test Report

The built-in UV LED module of tested model (PBM13M3UA0) has over 99.99% sterilization performance on average to bacteria at measuring points of the Pre-Filter under the proposed test condition.

※ Tested by TUV Rheinland Standard

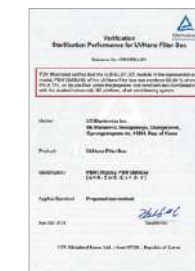

Certified Test Report

The built-in UV LED module of tested model (PBM13M3UA0) has 99.99% sterilization performance to virus (Phi X 174) at measuring points of the Pre-Filter under the proposed test condition.

※ Tested by TUV Rheinland Standard

ePM₁ 65% Filter

ePM₁ 65% Filtering capability rating in accordance with ISO 16890

Certified Test Report

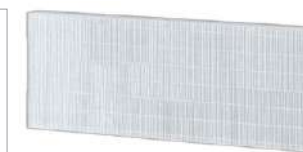

KCL 한국건설생활환경시험연구원
Korea Conformity Laboratories



Comparison of Filter Classes

Filter Class	ISO 16890 (Average Efficiency)				ASHRAE52.2 Filter Rating
	ePM ₁	ePM _{2.5}	ePM ₁₀	Coarse	
G1	-	-	-	-	MERV 1 - 4
G2	-	-	-	30% - 50%	MERV 1 - 4
G3	-	-	-	45% - 65%	MERV 5
G4	-	-	-	60% - 85%	MERV 6 - 8
M5	5% - 35%	10% - 45%	40% - 70%	80% - 95%	MERV 8 - 10
M6	10% - 40%	20% - 50%	45% - 80%	> 90%	MERV 9 - 13
F7	40% - 65%	50% - 75%	80% - 90%	> 95%	MERV 13 - 14
F8	65% - 90%	75% - 95%	90% - 100%	> 95%	MERV 14 - 15
F9	80% - 90%	85% - 95%	90% - 100%	> 95%	MERV 16

** Tested by KCL (Korea Conformity Laboratories)

※ ISO 16890 Standard provides lab evaluation procedures which more realistically simulate actual operating conditions, replacing EN 779 Standard's filter classes G1-F9 by a classification system based on particulate groups PM1, PM2.5 and PM10.

※ Unlike EN 779 Standard which specifies Filter Classes, ISO 16890 Standard classifies according to Filter Groups, evaluating a filter's performance by its arrestance of particles from 0.3µm to 10µm in size. Filter Group PM1 comprises particulate sizes ≤ 1.0µm, PM2.5 includes particulates sizes ≤ 2.5µm and PM10 covers particulate sizes ≤ 10µm.

※ Minimum efficiency is defined as the efficiency achieved following electrostatic discharge of the filter before testing.

※ Average efficiency is calculated by averaging the filter's efficiencies in the untreated state (before electrostatic discharge) and in the discharged state.

Auto E.S.P. (External Static Pressure) Setting

E.S.P. control function enables control of air volume easily with a remote controller. The BLDC motor can control fan speed and air volume.

Set RPM by simple touch on remote control to change airflow



※ ESP Setting guide (Wired Remote Controller) :
 - PREMTB100 : Menu → Setting → Installer → ESP setting
 - PREMTB001 : Button click → 03 : XX → ESP setting

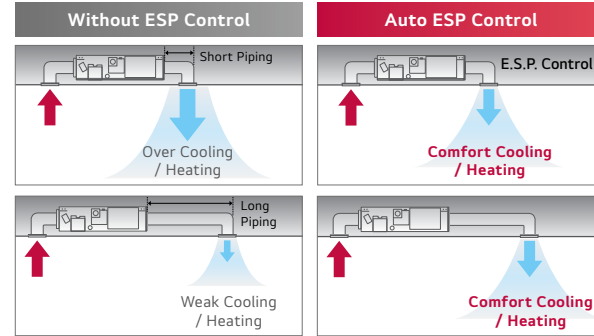

※ Wired remote controller is necessary.

AUTO External Static Pressure + Zone Control (On/Off)

LG's high static ducted unit does step control (High-Mid-Low Speed) to supply airflow rate to each zone depending on the number of open dampers.

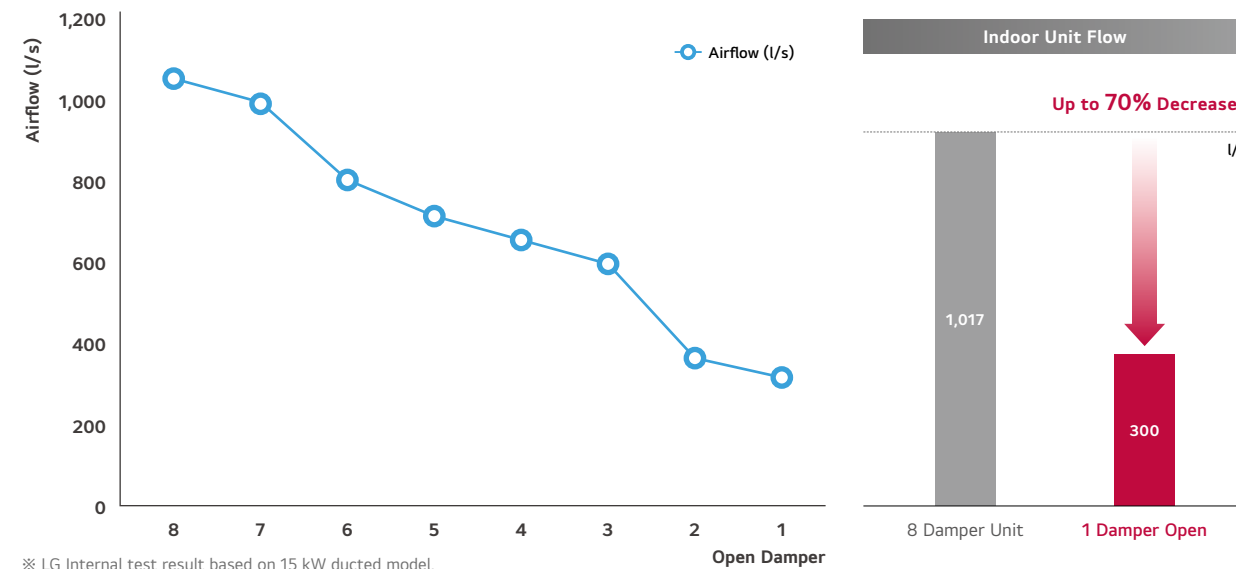
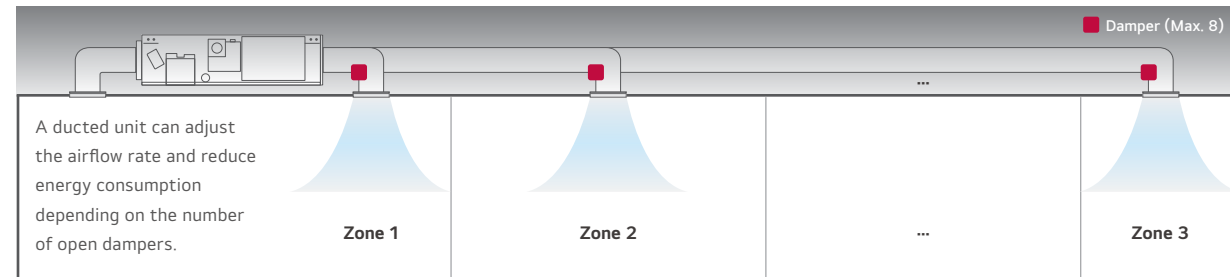

※ LG Internal test result based on 15 kW ducted model.
 - Temperature: 35/24 °C (Outdoor), 27/19 °C (Indoor)

Operation for Multiple Rooms

Using a spiral duct (rigid or flexible type) and stream chamber, it is possible to operate cooling / heating for several rooms simultaneously. Also, zone control is available with zone controller accessory. (PBZC80, PBZD80)

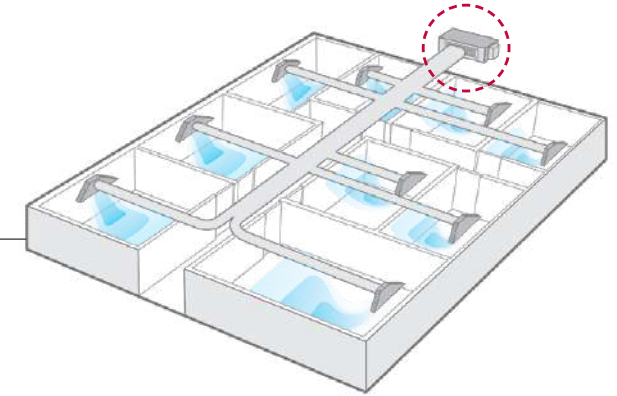

Zone Control Features

- Zone Control upto 8 Zone with PRETB100, PREMTB101
- Auto control of fan speed and On / Off operation

Synchro Function

Maximum 4 indoor units can be combined by using a branch kit and setting dip switch for one outdoor unit. It can be easily applied to various sites.

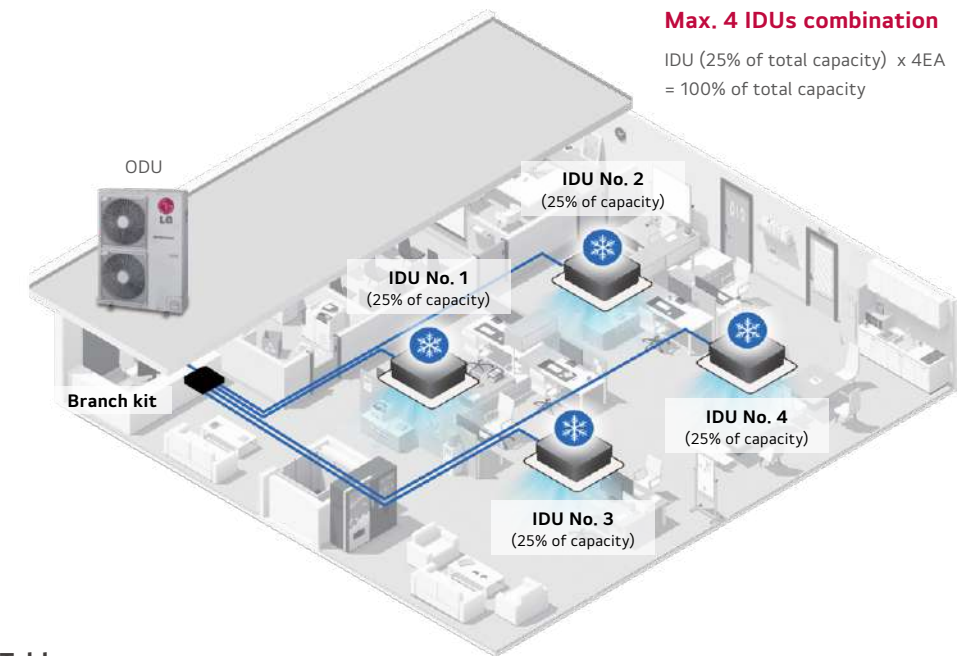

Synchro Combination Table

	Possible combination of indoor units					
	Synchro					
	Duo		Trio		Quartet	
IDU : Indoor unit ODU : Outdoor unit BD : Branch distributor unit REMO : Wired remote controller						
Capacity (kW)	Cassette	Ducted	Cassette	Ducted	Cassette	Ducted
10 / 12.5 / 14 / 15	UTN70PB * 2	UBN50L6 * 2		UBN35L5 * 3		UNB35L5 * 4
		UMN70M1 * 2		UBN50L6 * 3		
Applied Accessories	BD unit		BD unit		BD unit	
	PMUB11A		PMUB111A		PMUB1111A	
	Controller**					
	PREMTA000, PREMTB101, PREMTB001					

Note
 ** When using synchro operation,
 • Do not use wireless remote controller.
 • Use only one wired remote controller in the indoor units.

High Head Drain Pump

High head drain pump automatically drains water up to a height of 700mm of drain-head height. It provides the perfect solution for draining of water.

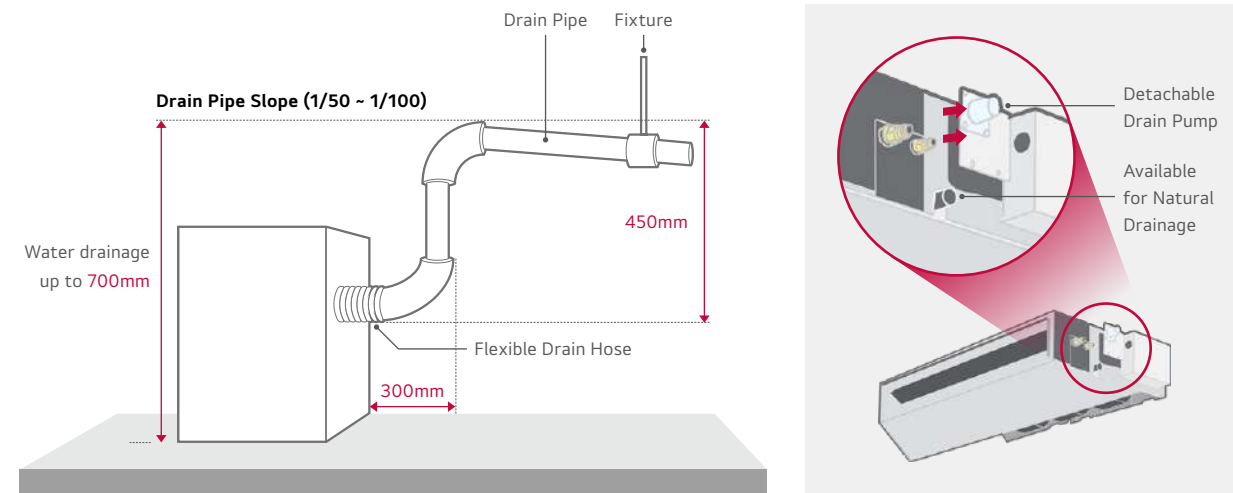

※ High Static Models : Accessory (ABDP7 / PBDP9) / Low to Mid Static Included
 ※ Required by option for high static pressure models.

Two Thermistors Control

The indoor temperature can be checked using the thermistors in the remote controller as well as from the indoor unit. There may be a significant difference between ceiling and floor air temperature. Two thermistors can optimised indoor air temperature for a more comfortable environment.

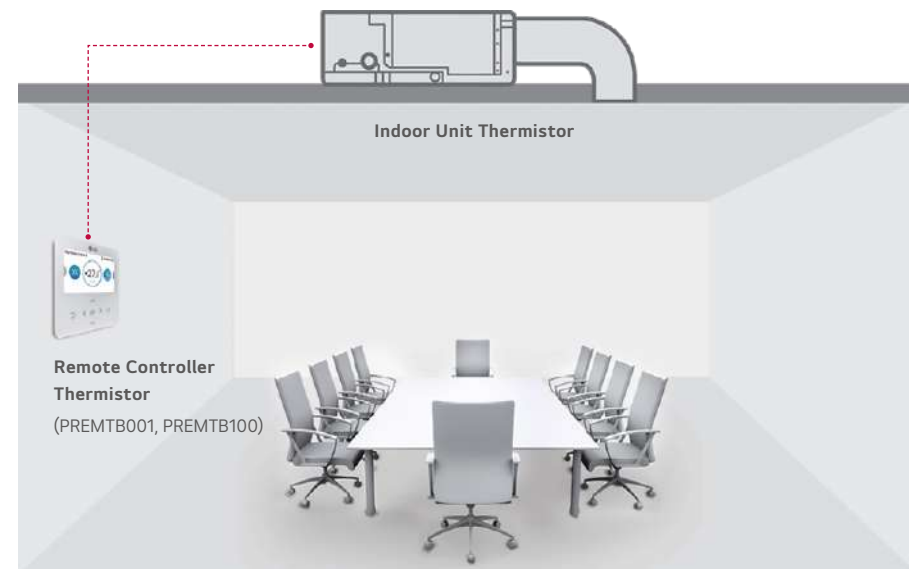

Compares temperatures sensed from different positions, and automatically selects the optimum temperature for users.

Flexible Installation (Low Static Pressure Model)

Standard Inverter low static ducted allows the air intake at the rear or bottom under installation condition.

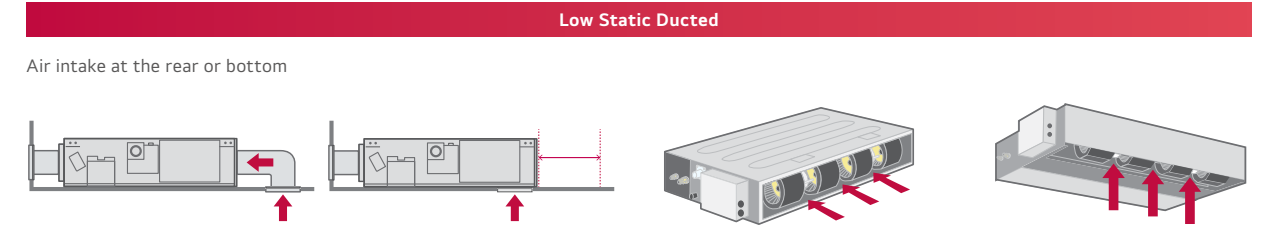

Easy Service & Maintenance (Low to Mid Static Pressure model)

Users are not required to disassemble the whole panel for maintenance; since panel is divided into 2 components; one for heat exchanger and the other for fan / motor. The user can easily detach and re-attach the filter in the available limited space.

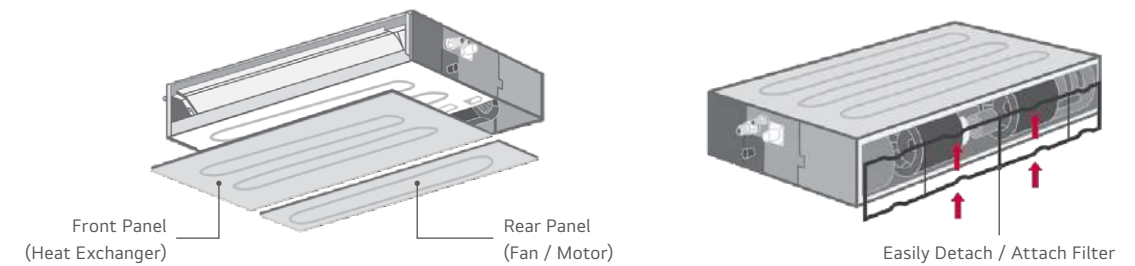

Quiet Operation (Low Static Pressure Model)

The noise level of low static ducts have been reduced, even though ESP has been increased.

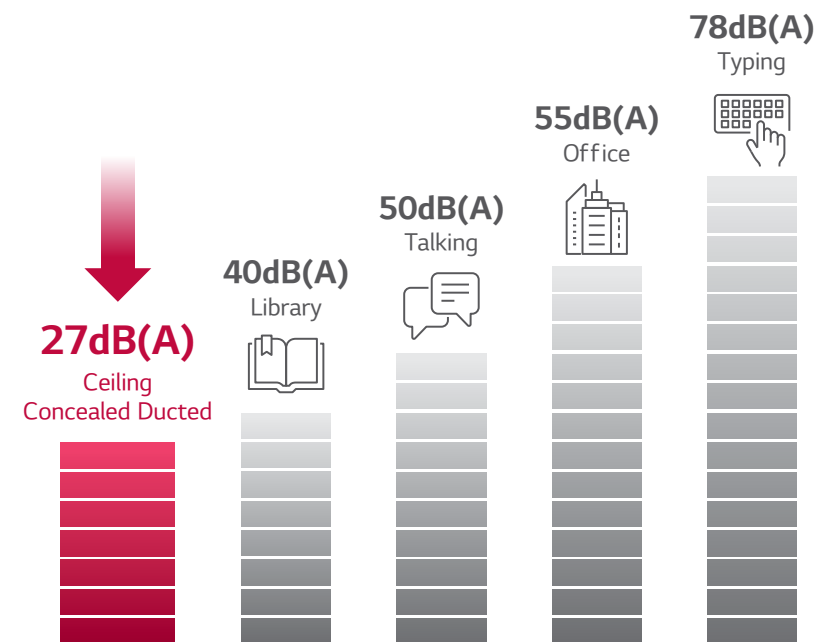

Sound Pressure (High / Medium / Low)	
Model	dB(A)
UBN25	35 / 30 / 27
UBN35	35 / 30 / 27
UBN50	34 / 31 / 29

LOW STATIC

UBN25L5 / UBN35L5 /
UBN50L6



UU25WR2 /
UU35WR2



UU50WR2



CATEGORY		INDOOR	UBN25L5	UBN35L5	UBN50L6
		OUTDOOR	UU25WR2	UU35WR2	UU50WR2
COMBINATIONAL SPECIFICATION		UNIT			
Cooling Capacity	Rated ²⁾	kW	2.50	3.40	5.00
	Min - Max	kW	1.50 - 3.20	1.50 - 4.70	2.00 - 5.80
Heating Capacity	Rated ²⁾	kW	3.20	4.00	5.80
	Min - Max	kW	1.80 - 4.00	1.80 - 4.90	2.30 - 6.70
AEER			3.640	3.343	3.658
ACOP			4.173	3.647	3.264
Rated Current	Cooling	A	3.00	4.70	7.40
	Heating	A	3.30	4.80	8.30
Full Load Amps		A	10.0	10.0	16.0
Air Flow Rate	Rated	L/s	192	192	250
Air Flow Rate	Min - Max	L/s	107 - 248	107 - 248	133 - 250
External Static Pressure	Min - Max	Pa	0 - 49	0 - 49	0 - 49
Indoor	Net (W x H x D)	mm	900 x 190 x 460	900 x 190 x 460	1,100 x 190 x 460
	Net Weight	kg	18	18.0	20.9
	Cooling ((SH)/H/M/L)	dB(A)	- / 35.0 / 30.0 / 27.0	- / 35.0 / 30.0 / 27.0	- / 34.0 / 31.0 / 29.0
Outdoor	Net (W x H x D)	mm	770 x 545 x 288	770 x 545 x 288	870 x 650 x 330
	Net Weight	kg	33.3	33.3	45.0
	Cooling / Heating (@ 1.5 m height)	dB(A)	49.0 / 52.0	49.0 / 52.0	47.0 / 52.0
Power Supply		Ø, Hz, V	1, 50 Hz, 220-240 V	1, 50 Hz, 220-240 V	1, 50 Hz, 220-240 V
Compressor	Type	-	Twin Rotary	Twin Rotary	Twin Rotary
	Motor Type	-	BLDC	BLDC	BLDC
Heat Exchanger	Fin Type	-	Wide Louver Plus	Wide Louver Plus	Wide Louver Plus
	Corrosion Protection (Coating)	-	Black 2	Black 2	Black 2
Refrigerant	Type	-	R32	R32	R32
	Pre-charge Length	m	7.5	7.5	7.5
Pipe size	Liquid	mm(inch)	Ø6.35 (1/4)	Ø6.35 (1/4)	Ø6.35 (1/4)
	Gas	mm(inch)	Ø9.52 (3/8)	Ø9.52 (3/8)	Ø12.7 (1/2)
	Drain Pipe (Drain Pump) OD/ID	mm(inch)	Ø32 (1-1/4) / 26 (1-1/32)	Ø32 (1-1/4) / 26 (1-1/32)	Ø32 (1-1/4) / 26 (1-1/32)
Piping Length	IDU - ODU (Rated / Max / Min)	m	7.5 / 30 / 5.0	7.5 / 30 / 5.0	7.5 / 30 / 5.0
Maximum Height Difference	IDU - ODU (Max)	m	30	30	30
Supply Air Opening	H x W, Flange (Discharge)	mm	148 x 860	148 x 860	148 x 1062
Return Air Opening	H x W, Flangeless	mm	190 x 807	190 x 807	190 x 1,007
Continuous Operation	Cooling	°C (DB)	-15 ~ 48	-15 ~ 48	-15 ~ 48
	Heating	°C (WB)	-18 ~ 18	-18 ~ 18	-18 ~ 18
Wi-Fi Compatible ⁴⁾			Optional	Optional	Optional

- Note:
- Specifications are correct at the time of printing and may be changed without notice.
 - Capacities are based on following conditions.
 - Cooling: Indoor Temp 29°C DB / 19°C WB, Outdoor Temp 35°C DB / 24°C WB
 - Heating: Indoor Temp 20°C DB, Outdoor Temp 7°C DB / 6°C WB
 - This product contains fluorinated greenhouse gases. (R32)
 - (Sold separately) Dongle required for Wi-Fi Connectivity. Internet connection required.

MID STATIC

UMN70M1 / UMN85M1



UU70WR2 /
UU85WR3



CATEGORY		INDOOR	UMN70M1	UMN85M1
		OUTDOOR	UU70WR2	UU85WR3
COMBINATIONAL SPECIFICATION		UNIT		
Cooling Capacity	Rated ²⁾	kW	6.80	8.00
	Min - Max	kW	2.70 - 8.00	3.10 - 9.00
Heating Capacity	Rated ²⁾	kW	7.50	9.00
	Min - Max	kW	3.00 - 9.00	3.60 - 10.10
AEER			3.451	3.448
ACOP			3.275	3.383
Rated Current	Cooling	A	8.70	9.90
	Heating	A	10.10	11.70
Full Load Amps		A	17.0	17.0
Air Flow Rate	Rated	L/s	300	367
Air Flow Rate	Min - Max	L/s	193 - 390	240 - 477
External Static Pressure	Min - Max	Pa	20 - 147	25 - 147
Indoor	Net (W x H x D)	mm	900 x 270 x 700	900 x 270 x 700
	Net Weight	kg	24.0	25.0
	Cooling ((SH)/H/M/L)	dB(A)	- / 35.0 / 34.0 / 32.0	- / 37.0 / 35.0 / 34.0
Outdoor	Net (W x H x D)	mm	950 x 834 x 330	950 x 834 x 330
	Net Weight	kg	59.0	59.0
	Cooling / Heating (@ 1.5 m height)	dB(A)	48.0 / 52.0	50.0 / 52.0
Power Supply		Ø, Hz, V	1, 50 Hz, 220-240 V	1, 50 Hz, 220-240 V
Compressor	Type	-	Twin Rotary	Twin Rotary
	Motor Type	-	BLDC	BLDC
Heat Exchanger	Fin Type	-	Wide Louver Plus	Wide Louver Plus
	Corrosion Protection (Coating)	-	Black 2	Black 2
Refrigerant	Type	-	R32	R32
	Pre-charge Length	m	10	10
Pipe size	Liquid	mm(inch)	Ø9.52 (3/8)	Ø9.52 (3/8)
	Gas	mm(inch)	Ø15.88 (5/8)	Ø15.88 (5/8)
	Drain Pipe (Drain Pump) OD/ID	mm(inch)	Ø32 (1-1/4) / 26 (1-1/32)	Ø32 (1-1/4) / 26 (1-1/32)
Piping Length	IDU - ODU (Rated / Max / Min)	m	7.5 / 50 / 5.0	7.5 / 50 / 5.0
Maximum Height Difference	IDU - ODU (Max)	m	30	30
Supply Air Opening	H x W, Flange (Discharge)	mm	200 x 857	200 x 857
Return Air Opening	H x W, Flangeless	mm	231 x 849	231 x 849
Continuous Operation	Cooling	°C (DB)	-15 ~ 48	-15 ~ 48
	Heating	°C (WB)	-18 ~ 18	-18 ~ 18
Wi-Fi Compatible ⁴⁾			Optional	Optional

- Note:
- Specifications are correct at the time of printing and may be changed without notice.
 - Capacities are based on following conditions.
 - Cooling: Indoor Temp 29°C DB / 19°C WB, Outdoor Temp 35°C DB / 24°C WB
 - Heating: Indoor Temp 20°C DB, Outdoor Temp 7°C DB / 6°C WB
 - This product contains fluorinated greenhouse gases. (R32)
 - (Sold separately) Dongle required for Wi-Fi Connectivity. Internet connection required.

MID STATIC

UMN100M2 / UMN125M2 / UMN140M3



UU100WR3 / UU125WR3 / UU140WR3



CATEGORY		INDOOR	UMN100M2	UMN125M2	UMN140M3
		OUTDOOR	UU100WR3	UU125WR3	UU140WR3
COMBINATIONAL SPECIFICATION		UNIT			
Cooling Capacity	Rated ²⁾	kW	9.50	12.30	13.80
	Min - Max	kW	3.80 - 12.54	4.80 - 14.04	5.40 - 15.68
Heating Capacity	Rated ²⁾	kW	10.80	13.50	15.50
	Min - Max	kW	4.30 - 13.39	5.40 - 15.80	6.20 - 17.52
AEER			3.724	3.416	3.209
ACOP			3.829	3.561	3.554
Rated Current	Cooling	A	11.10	15.30	19.00
	Heating	A	12.60	16.40	18.40
Full Load Amps		A	17.0	28.0	28.0
Air Flow Rate	Rated	L/s	533	633	667
Air Flow Rate	Min - Max	L/s	320 - 693	373 - 823	373 - 867
External Static Pressure	Min - Max	Pa	39 - 147	49 - 147	39 - 147
Indoor	Net (W x H x D)	mm	1,250 x 270 x 700	1,250 x 270 x 700	1,250 x 360 x 700
	Net Weight	kg	36.5	36.5	41.0
	Cooling ((SH)/H/M/L)	dB(A)	- / 36.0 / 34.0 / 33.0	- / 38.0 / 36.0 / 34.0	- / 39.0 / 38.0 / 36.0
Outdoor	Net (W x H x D)	mm	950 x 1,380 x 330	950 x 1,380 x 330	950 x 1,380 x 330
	Net Weight	kg	89.0	89.0	89.0
	Cooling / Heating (@ 1.5 m height)	dB(A)	50.0 / 50.0	51.0 / 52.0	52.0 / 53.0
Power Supply		Ø, Hz, V	1, 50 Hz, 220-240 V	1, 50 Hz, 220-240 V	1, 50 Hz, 220-240 V
Compressor	Type	-	Inverter Scroll	Inverter Scroll	Inverter Scroll
	Motor Type	-	BLDC	BLDC	BLDC
Heat Exchanger	Fin Type	-	Wide Louver Plus	Wide Louver Plus	Wide Louver Plus
	Corrosion Protection (Coating)	-	Black 2	Black 2	Black 2
Refrigerant	Type	-	R32	R32	R32
	Pre-charge Length	m	20	20	20
Pipe size	Liquid	mm(inch)	Ø9.52 (3/8)	Ø9.52 (3/8)	Ø9.52 (3/8)
	Gas	mm(inch)	Ø15.88 (5/8)	Ø15.88 (5/8)	Ø15.88 (5/8)
	Drain Pipe (Drain Pump) OD/ID	mm(inch)	Ø32 (1-1/4) / 26 (1-1/32)	Ø32 (1-1/4) / 26 (1-1/32)	Ø32 (1-1/4) / 26 (1-1/32)
Piping Length	IDU - ODU (Rated / Max / Min)	m	7.5 / 85.0 / 5.0	7.5 / 85.0 / 5.0	7.5 / 85.0 / 5.0
Maximum Height Difference	IDU - ODU (Max)	m	30	30	30
Supply Air Opening	H x W, Flange (Discharge)	mm	197 x 1,206	197 x 1,206	291 x 1,206
Return Air Opening	H x W, Flangeless	mm	230 x 1,205	230 x 1,205	320 x 1,205
Continuous Operation	Cooling	°C (DB)	-15 - 48	-15 - 48	-15 - 48
	Heating	°C (WB)	-18 - 18	-18 - 18	-18 - 18
Wi-Fi Compatible ⁴⁾			Optional	Optional	Optional

Note:
 1. Specifications are correct at the time of printing and may be changed without notice.
 2. Capacities are based on following conditions.
 • Cooling: Indoor Temp 29°C DB / 19°C WB, Outdoor Temp 35°C DB / 24°C WB
 • Heating: Indoor Temp 20°C DB, Outdoor Temp 7°C DB / 6°C WB
 3. This product contains fluorinated greenhouse gases. (R32)
 4. (Sold separately) Dongle required for Wi-Fi Connectivity. Internet connection required.

HIGH STATIC

UHN85B7 / UHN100B7



UU85WR3

UU100WR3



CATEGORY		INDOOR	UHN85B7	UHN100B7
		OUTDOOR	UU85WR3	UU100WR3
COMBINATIONAL SPECIFICATION		UNIT		
Cooling Capacity	Rated ²⁾	kW	8.80	10.50
	Min - Max	kW	2.50 - 9.60	3.20 - 13.00
Heating Capacity	Rated ²⁾	kW	9.40	13.00
	Min - Max	kW	2.70 - 11.10	3.40 - 13.70
AEER			3.384	3.749
ACOP			4.017	4.126
Rated Current	Cooling	A	11.40	12.20
	Heating	A	10.30	13.80
Full Load Amps		A	17.0	29.0
Air Flow Rate	Rated	L/s	533	700
Air Flow Rate	Min - Max	L/s	267 - 693	373 - 910
External Static Pressure	Min - Max	Pa	50 - 200	50 - 200
Indoor	Net (W x H x D)	mm	1,320 x 400 x 534	1,320 x 400 x 534
	Net Weight	kg	47.6	47.6
	Cooling ((SH)/H/M/L)	dB(A)	- / 41.0 / 40.0 / 39.0	- / 43.0 / 41.0 / 40.0
Outdoor	Net (W x H x D)	mm	950 x 834 x 330	950 x 1,380 x 330
	Net Weight	kg	59.0	89.0
	Cooling / Heating (@ 1.5 m height)	dB(A)	51.0 / 52.0	53.0 / 54.0
Power Supply		Ø, Hz, V	1, 50 Hz, 220-240 V	1, 50 Hz, 220-240 V
Compressor	Type	-	Twin Rotary	Inverter Scroll
	Motor Type	-	BLDC	BLDC
Heat Exchanger	Fin Type	-	Wide Louver Plus	Wide Louver Plus
	Corrosion Protection (Coating)	-	Black 2	Black 2
Refrigerant	Type	-	R32	R32
	Pre-charge Length	m	10	20
Pipe size	Liquid	mm(inch)	Ø9.52 (3/8)	Ø9.52 (3/8)
	Gas	mm(inch)	Ø15.88 (5/8)	Ø15.88 (5/8)
	Drain Pipe (Drain Pump) OD/ID	mm(inch)	Ø32 (1-1/4) / 25 (31/32)	Ø32 (1-1/4) / 25 (31/32)
Piping Length	IDU - ODU (Rated / Max / Min)	m	7.5 / 50 / 5.0	7.5 / 85 / 5.0
Maximum Height Difference	IDU - ODU (Max)	m	30	30
Supply Air Opening	H x W, Flange (Discharge)	mm	287 x 840	287 x 840
Return Air Opening	H x W, Flange	mm	317 x 1,172	317 x 1,172
Continuous Operation	Cooling	°C (DB)	-15 - 48	-15 - 48
	Heating	°C (WB)	-18 - 18	-18 - 18
Wi-Fi Compatible ⁴⁾			Optional	Optional

Note:
 1. Specifications are correct at the time of printing and may be changed without notice.
 2. Capacities are based on following conditions.
 • Cooling: Indoor Temp 29°C DB / 19°C WB, Outdoor Temp 35°C DB / 24°C WB
 • Heating: Indoor Temp 20°C DB, Outdoor Temp 7°C DB / 6°C WB
 3. This product contains fluorinated greenhouse gases. (R32)
 4. (Sold separately) Dongle required for Wi-Fi Connectivity. Internet connection required.

HIGH STATIC

UHN125B7 / UHN150B7



UU125WR3 /
UU150WR3



CATEGORY	INDOOR		UHN125B7	UHN150B7
	OUTDOOR		UU125WR3	UU150WR3
COMBINATIONAL SPECIFICATION		UNIT		
Cooling Capacity	Rated ²⁾	kW	12.50	15.00
	Min - Max	kW	4.00 - 14.80	4.80 - 15.80
Heating Capacity	Rated ²⁾	kW	15.00	17.00
	Min - Max	kW	4.00 - 16.50	4.80 - 18.00
AEER			3.679	3.228
ACOP			3.899	3.596
Rated Current	Cooling	A	14.90	20.40
	Heating	A	16.90	20.80
Full Load Amps		A	29.0	29.0
Air Flow Rate	Rated	L/s	833	1000
Air Flow Rate	Min - Max	L/s	480 - 1,083	533 - 1,300
External Static Pressure	Min - Max	Pa	60 - 200	60 - 200
Indoor	Net (W x H x D)	mm	1,320 x 400 x 534	1,320 x 400 x 534
	Net Weight	kg	50.6	50.6
	Cooling ((SH)/H/M/L)	dB(A)	- / 44.0 / 42.0 / 41.0	- / 45.0 / 44.0 / 42.0
Outdoor	Net (W x H x D)	mm	950 x 1,380 x 330	950 x 1,380 x 330
	Net Weight	kg	89.0	89.0
	Cooling / Heating (@ 1.5 m height)	dB(A)	53.0 / 54.0	54.0 / 56.0
Power Supply		Ø, Hz, V	1, 50 Hz, 220-240 V	1, 50 Hz, 220-240 V
Compressor	Type	-	Inverter Scroll	Inverter Scroll
	Motor Type	-	BLDC	BLDC
Heat Exchanger	Fin Type	-	Wide Louver Plus	Wide Louver Plus
	Corrosion Protection (Coating)	-	Black 2	Black 2
Refrigerant	Type	-	R32	R32
	Pre-charge Length	m	20	20
Pipe size	Liquid	mm(inch)	Ø9.52 (3/8)	Ø9.52 (3/8)
	Gas	mm(inch)	Ø15.88 (5/8)	Ø15.88 (5/8)
	Drain Pipe (Drain Pump) OD/ID	mm(inch)	Ø32 (1-1/4) / 25 (31/32)	Ø32 (1-1/4) / 25 (31/32)
Piping Length	IDU - ODU (Rated / Max / Min)	m	7.5 / 85 / 5.0	7.5 / 85 / 5.0
Maximum Height Difference	IDU - ODU (Max)	m	30	30
Supply Air Opening	H x W, Flange (Discharge)	mm	287 x 840	287 x 840
Return Air Opening	H x W, Flange	mm	317 x 1,172	317 x 1,172
Continuous Operation	Cooling	°C (DB)	-15 - 48	-15 - 48
	Heating	°C (WB)	-18 - 18	-18 - 18
Wi-Fi Compatible ⁴⁾			Optional	Optional

- Note:
- Specifications are correct at the time of printing and may be changed without notice.
 - Capacities are based on following conditions.
 - Cooling: Indoor Temp 29°C DB / 19°C WB, Outdoor Temp 35°C DB / 24°C WB
 - Heating: Indoor Temp 20°C DB, Outdoor Temp 7°C DB / 6°C WB
 - This product contains fluorinated greenhouse gases. (R32)
 - (Sold separately) Dongle required for Wi-Fi Connectivity. Internet connection required.

HIGH STATIC

B62AWYN9L6 / B70AWYN9L6



B62AWYU7L6 /
B70AWYU7L6



CATEGORY	INDOOR		B62AWYN9L6	B70AWYN9L6
	OUTDOOR		B62AWYU7L6	B70AWYU7L6
COMBINATIONAL SPECIFICATION		UNIT		
Rated Capacity ²⁾	Cooling	kW	18	20
	Heating	kW	20.6	22.6
Rated Power Input	Cooling	kW	5.47	6.47
	Heating	kW	5.49	6.19
AEER	Cooling		3.29 (EER)	3.09 (EER)
	Heating		3.75 (COP)	3.65 (COP)
Rated Current	Cooling	A	9.3	10.9
	Heating	A	9.6	10.5
Full Load Amps		A	24	24
Air Flow Rate		L/s	1,067 - 1,333	1,067 - 1,333
External Static Pressure		Pa	59 - 176	59 - 176
Indoor	Sound Level at 1.5 m	Pressure dB(A)	43.0 / 41.0 / 40.0	43.0 / 41.0 / 40.0
	Dimensions	mm	1,563 x 458 x 791	1,563 x 458 x 791
	Weight	kg	92.7	92.7
Outdoor	Sound Level at 1.5 m	Pressure dB(A)	59 / 60	59 / 60
	Sound Power Level	dB(A)	71	71
	Dimensions	mm	1,090 x 1,625 x 380	1,090 x 1,625 x 380
	Weight	kg	139	139
Power Supply		Ø, Hz, V	380-415, 3, 50	380-415, 3, 50
Circuit Breaker		A	30	30
Compressor Type			Hermetically Sealed Scroll	Hermetically Sealed Scroll
Heat Exchanger	Type		Wide Louver Plus	Wide Louver Plus
	Corrosion Protection (Coating)		Gold	Gold
Refrigerant ³⁾	Type		R410A	R410A
	Pre-charge Length	m	15	15
Pipe size	Liquid	mm(inch)	Ø12.7 (1/2)	Ø12.7 (1/2)
	Gas	mm(inch)	Ø22.2 (7/8)	Ø22.2 (7/8)
	Drain OD/ID (Drain Pump)	mm	Ø32 / 25	Ø32 / 25
Max. Piping Length		m	75	75
Max. Height Difference	ODU - IDU	m	30	30
Supply Air Opening	H x W, Flange (Discharge)	mm	286 x 1,044	286 x 1,044
Return Air Opening	H x W, Flange	mm	392 x 1,368	392 x 1,368
Continuous Operation	Cooling	°C (DB)	-15 - 48	-15 - 48
	Heating	°C (WB)	-15 - 48	-15 - 48
Wi-Fi Compatible ⁴⁾			Optional	Optional

- Note:
- Specifications are correct at the time of printing and may be changed without notice.
 - Capacities are based on following conditions.
 - Cooling: Indoor Temp 29°C DB / 19°C WB, Outdoor Temp 35°C DB / 24°C WB
 - Heating: Indoor Temp 20°C DB, Outdoor Temp 7°C DB / 6°C WB
 - This product contains fluorinated greenhouse gases. (R32)
 - (Sold separately) Dongle required for Wi-Fi Connectivity. Internet connection required.

HIGH STATIC SPLITTABLE DUCTED



Lighter & Splittable Structure

LG Splittable indoor units comprise three key components. Its comparatively lightweight structure allows for easy transportation during installation.

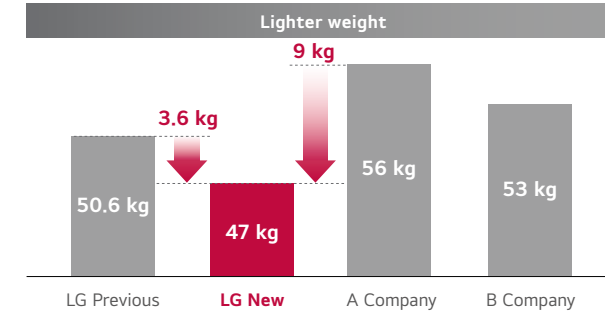
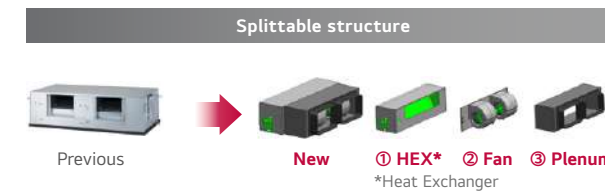

※ Based on 15.5 kW

Less people, Save cost



Built-in Return Plenum

The LG Splittable Ducted indoor unit has a built-in plenum which helps to reduce extra costs on installation as no customised plenum needs to be made by the installer. The LG Splittable unit is simple to handle in tight spaces as the unit can be easily disassembled and reassembled in the roof cavity.

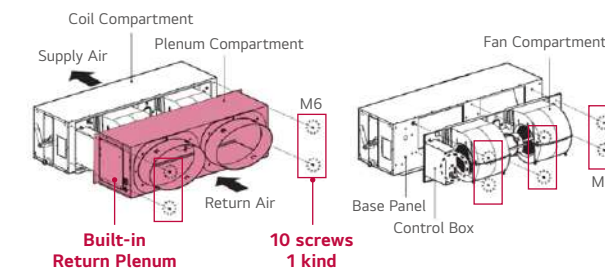

Less screws, Save time

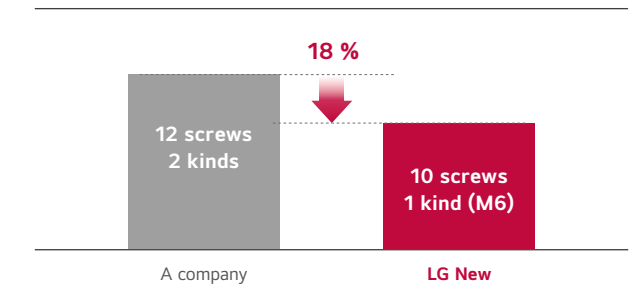

Compact Height

LG Splittable Ducted indoor unit can be installed into low height roofs. The unit height of < 360 mm is designed to fit comfortably into tighter roof spaces.

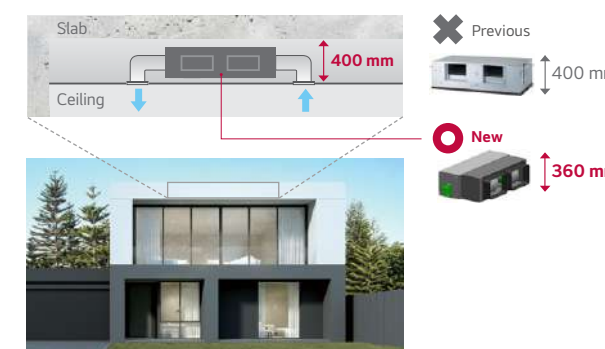

※ Based on 15.5 kW

Height comparison

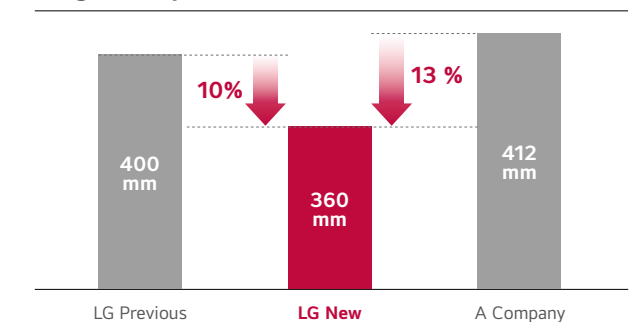

HIGH STATIC SPLITTABLE

UHN85M2S / UHN100M2S

UU85WR3 / UU100WR3 /
UU100WR3L

CATEGORY		INDOOR	UHN85M2S	UHN100M2S	UHN100M2S
		OUTDOOR	UU85WR3	UU100WR3	UU100WR3L
COMBINATIONAL SPECIFICATION		UNIT			
Cooling Capacity	Rated ²⁾	kW	8.5	10.5	10.5
	Min - Max	kW	2.55 - 9.3	4.2 - 13	4.2 - 13
Heating Capacity	Rated ²⁾	kW	10	13	13
	Min - Max	kW	2.87 - 11	5.2 - 13.9	5.2 - 13.9
AEER			3.364	3.75	3.75
ACOP			3.667	4.00	4.00
Rated Current	Cooling	A	11.2	12.2	4.3
	Heating	A	12.0	14.2	4.9
Full Load Amps		A	17.0	29.0	14.0
Air Flow Rate	Rated	L/s	583	700	700
Air Flow Rate	Min - Max	L/s	305 - 815	377 - 893	377 - 893
External Static Pressure	Min - Max	Pa	39 - 137	39 - 137	39 - 137
Indoor	Net (W x H x D)	mm	1,250 x 270 x 820	1,250 x 270 x 820	1,250 x 270 x 820
	Net Weight	kg	42	42	42
	Cooling ((SH)/H/M/L)	dB(A)	- / 42.0 / 40.0 / 38.0	- / 45.0 / 43.0 / 41.0	- / 45.0 / 43.0 / 41.0
Outdoor	Net (W x H x D)	mm	950 x 834 x 330	950 x 1,380 x 330	950 x 1,380 x 330
	Net Weight	kg	59.0	89.0	89.0
	Cooling / Heating (@ 1.5 m height)	dB(A)	51 / 52	50 / 50	50 / 50
Power Supply		Ø, Hz, V	1, 50 Hz 220-240 V	1, 50 Hz 220-240 V-	3, 50 Hz 380-415 V 3N-
Compressor	Type	-	Twin Rotary	Inverter Scroll	Inverter Scroll
	Motor Type	-	BLDC	BLDC	BLDC
Heat Exchanger	Fin Type	-	Wide Louver Plus	Wide Louver Plus	Wide Louver Plus
	Corrosion Protection (Coating)	-	Black 2	Black 2	Black 2
Refrigerant	Type	-	R32	R32	R32
	Pre-charge Length	m	10	20	20
Pipe size	Liquid	mm(inch)	Ø9.52 (3/8)	Ø9.52 (3/8)	Ø9.52 (3/8)
	Gas	mm(inch)	Ø15.88 (5/8)	Ø15.88 (5/8)	Ø15.88 (5/8)
	Drain Pipe (Drain Pump) OD/ID	mm(inch)	Ø32 (1-1/4) / 26 (1-1/32)	Ø32 (1-1/4) / 26 (1-1/32)	Ø32 (1-1/4) / 26 (1-1/32)
Piping Length	IDU - ODU (Rated / Max / Min)	m	7.5 / 50 / 5.0	7.5 / 85 / 5.0	7.5 / 85 / 5.0
Maximum Height Difference	IDU - ODU (Max)	m	30	30	30
Air Vent	Return (Oval)	mm	2 x 400	2 x 400	2 x 400
	Supply (W x H, Flange)	mm	1,148 x 245	1,148 x 245	1,148 x 245
Continuous Operation	Cooling	°C (DB)	-15 - 48	-15 - 48	-15 - 48
	Heating	°C (WB)	-18 - 18	-18 - 18	-18 - 18
Wi-Fi Compatible ⁴⁾			Optional	Optional	Optional

Note:

- Specifications are correct at the time of printing and may be changed without notice.
- Capacities are based on following conditions.
 - Cooling: Indoor Temp 29°C DB / 19°C WB, Outdoor Temp 35°C DB / 24°C WB
 - Heating: Indoor Temp 20°C DB, Outdoor Temp 7°C DB / 6°C WB
- This product contains fluorinated greenhouse gases. (R32)
- (Sold separately) Dongle required for Wi-Fi Connectivity. Internet connection required.

HIGH STATIC SPLITTABLE

UHN125M3S

UU125WR3 /
UU125WR3L

CATEGORY		INDOOR	UHN125M3S	UHN125M3S
		OUTDOOR	UU125WR3	UU125WR3L
COMBINATIONAL SPECIFICATION		UNIT		
Cooling Capacity	Rated ²⁾	kW	12.5	12.5
	Min - Max	kW	5.1 - 14.3	5.1 - 14.3
Heating Capacity	Rated ²⁾	kW	15	15
	Min - Max	kW	6 - 16.2	6 - 16.2
AEER			3.68	3.68
ACOP			3.95	3.95
Rated Current	Cooling	A	14.9	5.1
	Heating	A	16.9	5.7
Full Load Amps		A	29.0	14.0
Air Flow Rate	Rated	L/s	833	833
Air Flow Rate	Min - Max	L/s	425 - 1,035	425 - 1,035
External Static Pressure	Min - Max	Pa	49 - 157	49 - 157
Indoor	Net (W x H x D)	mm	1,250 x 360 x 820	1,250 x 360 x 820
	Net Weight	kg	47	47
	Cooling ((SH)/H/M/L)	dB(A)	- / 44.0 / 42.0 / 41.0	- / 44.0 / 42.0 / 41.0
Outdoor	Net (W x H x D)	mm	950 x 1,380 x 330	950 x 1,380 x 330
	Net Weight	kg	89.0	89.0
	Cooling / Heating (@ 1.5 m height)	dB(A)	51 / 52	51 / 52
Power Supply		Ø, Hz, V	1, 50 Hz 220-240 V	3, 50 Hz 380-415 V
Compressor	Type	-	Inverter Scroll	Inverter Scroll
	Motor Type	-	BLDC	BLDC
Heat Exchanger	Fin Type	-	Wide Louver Plus	Wide Louver Plus
	Corrosion Protection (Coating)	-	Black 2	Black 2
Refrigerant	Type	-	R32	R32
	Pre-charge Length	m	20	20
Pipe size	Liquid	mm(inch)	Ø9.52 (3/8)	Ø9.52 (3/8)
	Gas	mm(inch)	Ø15.88 (5/8)	Ø15.88 (5/8)
	Drain Pipe (Drain Pump) OD/ID	mm(inch)	Ø32 (1-1/4) / 26 (1-1/32)	Ø32 (1-1/4) / 26 (1-1/32)
Piping Length	IDU - ODU (Rated / Max / Min)	m	7.5 / 85 / 5.0	7.5 / 85 / 5.0
Maximum Height Difference	IDU - ODU (Max)	m	30	30
Air Vent	Return (Oval)	mm	2 x 400	2 x 400
	Supply (W x H, Flange)	mm	1,148 x 292	1,148 x 292
Continuous Operation	Cooling	°C (DB)	-15 - 48	-15 - 48
	Heating	°C (WB)	-18 - 18	-18 - 18
Wi-Fi Compatible ⁴⁾			Optional	Optional

Note:

- Specifications are correct at the time of printing and may be changed without notice.
- Capacities are based on following conditions.
 - Cooling: Indoor Temp 29°C DB / 19°C WB, Outdoor Temp 35°C DB / 24°C WB
 - Heating: Indoor Temp 20°C DB, Outdoor Temp 7°C DB / 6°C WB
- This product contains fluorinated greenhouse gases. (R32)
- (Sold separately) Dongle required for Wi-Fi Connectivity. Internet connection required.

HIGH STATIC SPLITTABLE

UHN140M3S

UU140WR3 /
UU140WR3L

CATEGORY		INDOOR	UHN140M3S	UHN140M3S
		OUTDOOR	UU140WR3	UU140WR3L
COMBINATIONAL SPECIFICATION		UNIT		
Cooling Capacity	Rated ²⁾	kW	14	14
	Min - Max	kW	5.6 - 15.7	5.6 - 15.7
Heating Capacity	Rated ²⁾	kW	16.5	16.5
	Min - Max	kW	6.6 - 17	6.6 - 17
AEER			3.22	3.22
ACOP			3.71	3.71
Rated Current	Cooling	A	19.1	6.7
	Heating	A	19.5	6.8
Full Load Amps		A	29.0	14.0
Air Flow Rate	Rated	L/s	900	900
Air Flow Rate	Min - Max	L/s	468 - 1,073	468 - 1,073
External Static Pressure	Min - Max	Pa	49 - 157	49 - 157
Indoor	Net (W x H x D)	mm	1,250 x 360 x 820	1,250 x 360 x 820
	Net Weight	kg	47	47
	Cooling ((SH)/H/M/L)	dB(A)	45.0 / 44.0 / 42.0	45.0 / 44.0 / 42.0
Outdoor	Net (W x H x D)	mm	950 x 1,380 x 330	950 x 1,380 x 330
	Net Weight	kg	89.0	89.0
	Cooling / Heating (@ 1.5 m height)	dB(A)	52 / 53	52 / 53
Power Supply		Ø, Hz, V	1, 50 Hz 220-240 V	3, 50 Hz 380-415 V
Compressor	Type	-	Inverter Scroll	Inverter Scroll
	Motor Type	-	BLDC	BLDC
Heat Exchanger	Fin Type	-	Wide Louver Plus	Wide Louver Plus
	Corrosion Protection (Coating)	-	Black 2	Black 2
Refrigerant	Type	-	R32	R32
	Pre-charge Length	m	20	20
Pipe size	Liquid	mm(inch)	Ø9.52 (3/8)	Ø9.52 (3/8)
	Gas	mm(inch)	Ø15.88 (5/8)	Ø15.88 (5/8)
	Drain Pipe (Drain Pump) OD/ID	mm(inch)	Ø32 (1-1/4) / 26 (1-1/32)	Ø32 (1-1/4) / 26 (1-1/32)
Piping Length	IDU - ODU (Rated / Max / Min)	m	7.5 / 85 / 5.0	7.5 / 85 / 5.0
Maximum Height Difference	IDU - ODU (Max)	m	30	30
Air Vent	Return (Oval)	mm	2 x 400	2 x 400
	Supply (W x H, Flange)	mm	1,148 x 292	1,148 x 292
Continuous Operation	Cooling	°C (DB)	-15 ~ 48	-15 ~ 48
	Heating	°C (WB)	-18 ~ 18	-18 ~ 18
Wi-Fi Compatible ⁴⁾			Optional	Optional

Note:

- Specifications are correct at the time of printing and may be changed without notice.
- Capacities are based on following conditions.
 - Cooling: Indoor Temp 29°C DB / 19°C WB, Outdoor Temp 35°C DB / 24°C WB
 - Heating: Indoor Temp 20°C DB, Outdoor Temp 7°C DB / 6°C WB
- This product contains fluorinated greenhouse gases. (R32)
- (Sold separately) Dongle required for Wi-Fi Connectivity. Internet connection required.

HIGH STATIC SPLITTABLE

UHN150M3S

UU150WR3 /
UU150WR3L

CATEGORY		INDOOR	UHN150M3S	UHN150M3S
		OUTDOOR	UU150WR3	UU150WR3L
COMBINATIONAL SPECIFICATION		UNIT		
Cooling Capacity	Rated ²⁾	kW	15.2	15.2
	Min - Max	kW	6.1 - 16.4	6.1 - 16.4
Heating Capacity	Rated ²⁾	kW	18	18
	Min - Max	kW	7.2 - 18.3	7.2 - 18.3
AEER			3.27	3.27
ACOP			3.64	3.64
Rated Current	Cooling	A	20.4	6.9
	Heating	A	21.7	7.6
Full Load Amps		A	29.0	14.0
Air Flow Rate	Rated	L/s	950	950
Air Flow Rate	Min - Max	L/s	495 - 1,123	495 - 1,123
External Static Pressure	Min - Max	Pa	49 - 157	49 - 157
Indoor	Net (W x H x D)	mm	1,250 x 360 x 820	1,250 x 360 x 820
	Net Weight	kg	47	47
	Cooling ((SH)/H/M/L)	dB(A)	- / 46.0 / 44.0 / 42.0	- / 46.0 / 44.0 / 42.0
Outdoor	Net (W x H x D)	mm	950 x 1,380 x 330	950 x 1,380 x 330
	Net Weight	kg	89.0	89.0
	Cooling / Heating (@ 1.5 m height)	dB(A)	54 / 56	54 / 56
Power Supply		Ø, Hz, V	1, 50 Hz 220-240 V	3, 50 Hz 380-415 V
Compressor	Type	-	Inverter Scroll	Inverter Scroll
	Motor Type	-	BLDC	BLDC
Heat Exchanger	Fin Type	-	Wide Louver Plus	Wide Louver Plus
	Corrosion Protection (Coating)	-	Black 2	Black 2
Refrigerant	Type	-	R32	R32
	Pre-charge Length	m	20	20
Pipe size	Liquid	mm(inch)	Ø9.52 (3/8)	Ø9.52 (3/8)
	Gas	mm(inch)	Ø15.88 (5/8)	Ø15.88 (5/8)
	Drain Pipe (Drain Pump) OD/ID	mm(inch)	Ø32 (1-1/4) / 26 (1-1/32)	Ø32 (1-1/4) / 26 (1-1/32)
Piping Length	IDU - ODU (Rated / Max / Min)	m	7.5 / 85 / 5.0	7.5 / 85 / 5.0
Maximum Height Difference	IDU - ODU (Max)	m	30	30
Air Vent	Return (Oval)	mm	2 x 400	2 x 400
	Supply (W x H, Flange)	mm	1,148 x 292	1,148 x 292
Continuous Operation	Cooling	°C (DB)	-15 ~ 48	-15 ~ 48
	Heating	°C (WB)	-18 ~ 18	-18 ~ 18
Wi-Fi Compatible ⁴⁾			Optional	Optional

Note:

- Specifications are correct at the time of printing and may be changed without notice.
- Capacities are based on following conditions.
 - Cooling: Indoor Temp 29°C DB / 19°C WB, Outdoor Temp 35°C DB / 24°C WB
 - Heating: Indoor Temp 20°C DB, Outdoor Temp 7°C DB / 6°C WB
- This product contains fluorinated greenhouse gases. (R32)
- (Sold separately) Dongle required for Wi-Fi Connectivity. Internet connection required.

CEILING MOUNTED CASSETTE



Dual Sensing Control (Dry Summer)

During a dry summer season, the system senses the low humidity levels and decreases the operating ratio to increase humidity for a more comfortable environment and energy efficient operation.

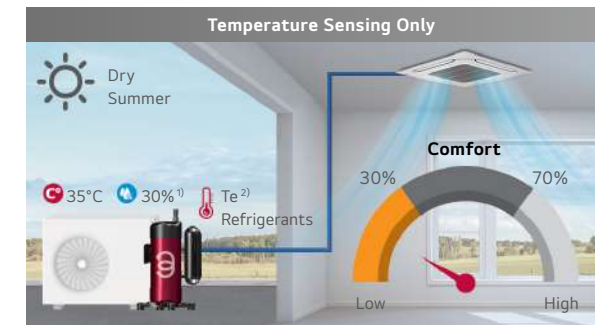

- **Uncomfortable Environment**
Excessive latent heat elimination regardless of humidity
- **Waste Energy**
Eliminate latent heat unnecessarily

※ Humidity Condition : Low (<30%), Standard (30 - 70%)
1) Indoor Condition 2) Evaporation Temperature

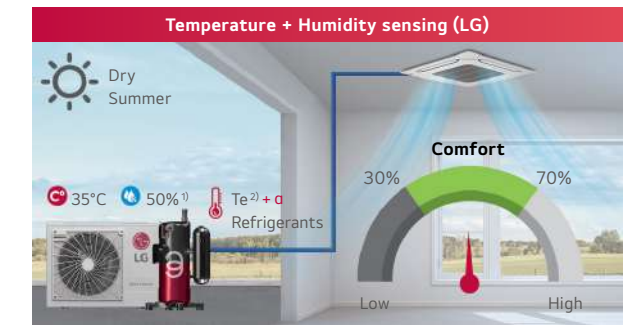

- **Comfortable Environment**
By making the room less dry
- **Increased Energy Efficiency**
Provide optimized cooling and save energy considering humidity

Dual Sensing Control (Wet Summer)

During a wet summer season, the system senses the high humidity levels and increases the operating ratio to rapidly decrease humidity for a more comfortable indoor environment.

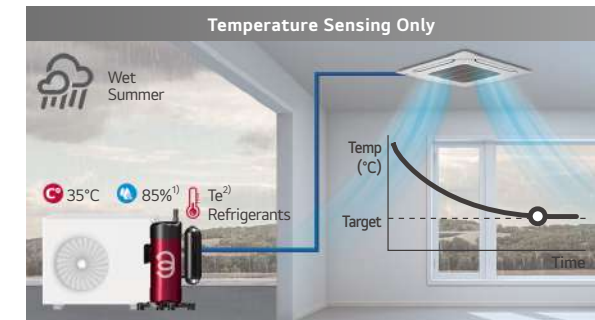

- **Uncomfortable Environment**
General latent heat elimination regardless of humidity
- 1) Indoor Condition 2) Evaporation Temperature

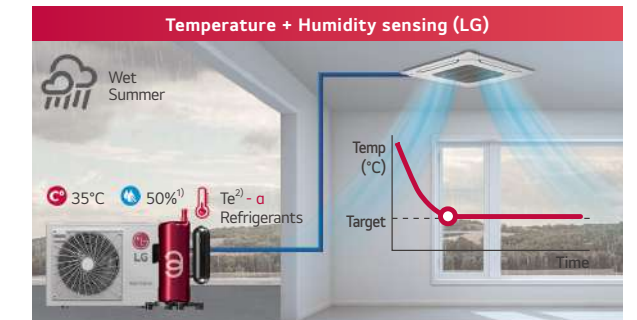

- **Comfortable Environment**
Quick latent heat elimination with humidity sensors

Human Detection (Optional Accessory)

Indoor unit senses human presence to switch on or off after a selected time to help reduce running costs. Time can be set to 30, 60 or 90 min, turning off if human presence is not detected in that time. This feature requires human detection sensor to be installed (optional) PTVSAA0.

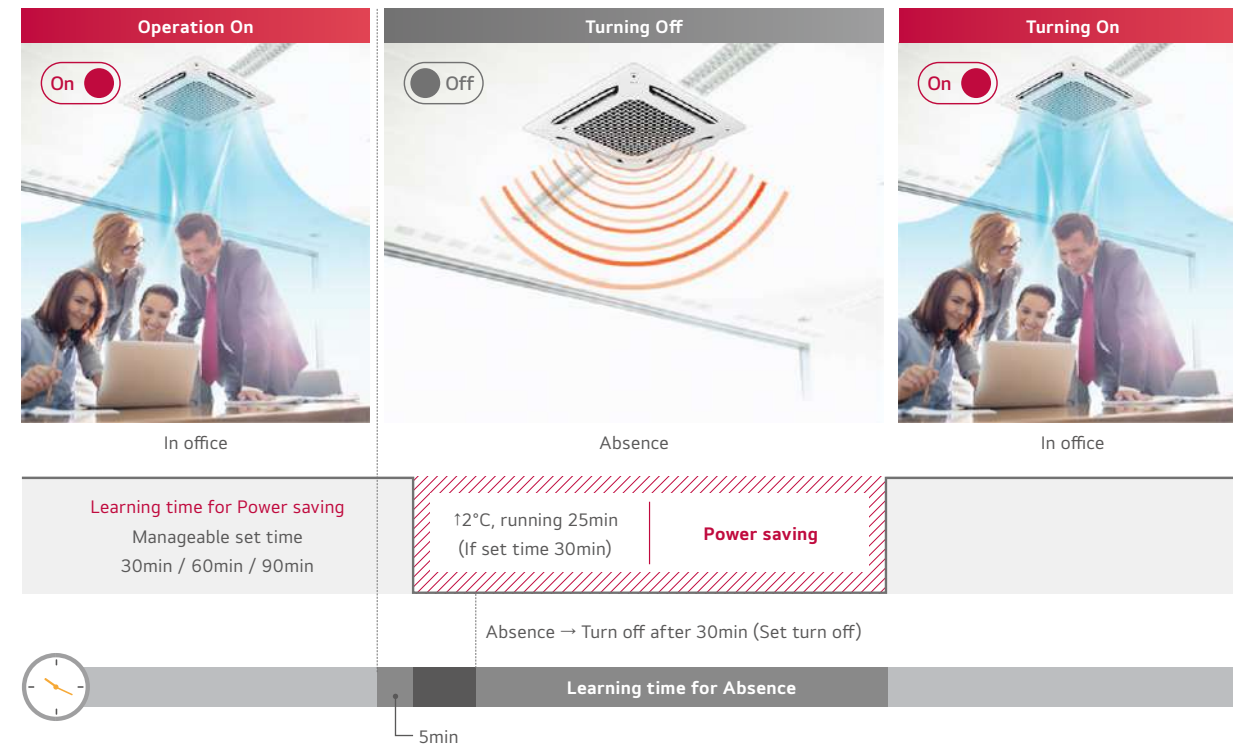

※ Data Based on actual test of LG, single product 2 hours measurement result. (Cooling 26 °C, strong wind)

Stylish Design Panel & Compact Size

New 4 way cassette panel adapted a unibody shape that matches with the ceiling.

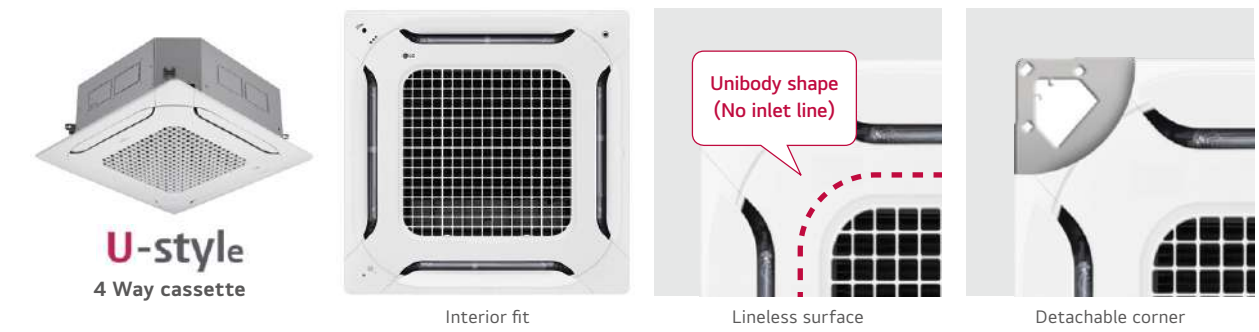

Slim & compact design not only saves space but also reduces installation costs. It's designed to suit most of building designs and fit into various spaces.



Convenient Panel Installation

The detachable corner design makes it easy to adjust the hanger during installation and to check for leakages in the drain connection pipe. And it is easy to install the panel to the body, using the button type panel design.

Detachable Corner Design

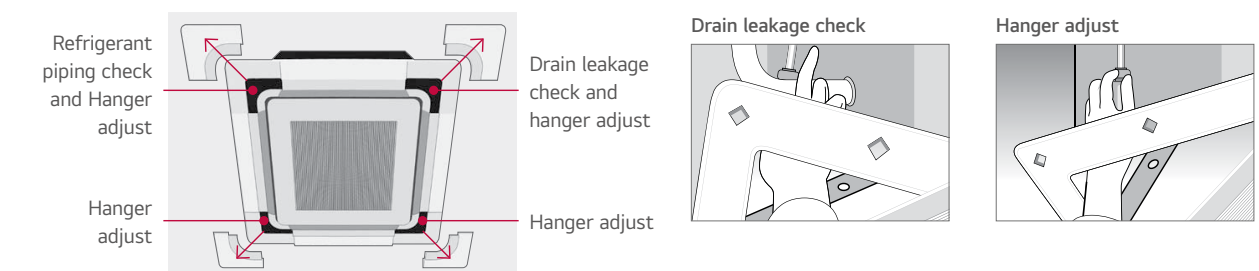

One Push Panel

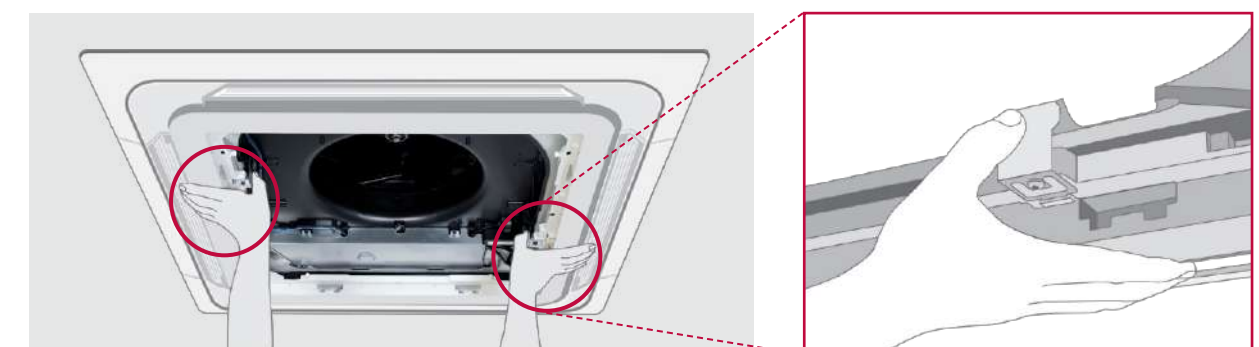

4 Way Air Flow with New Dual Vane Design

New 4 Way dual vane design that promotes comfortable and convenient airflow.



New Types of Wind Solutions

Indirect Wind



Direct Wind



6 Air Flow Modes

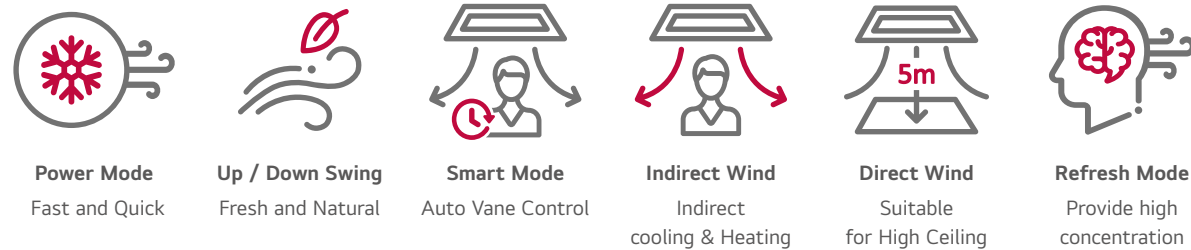

Colour

Color enhancement allows cassette to blend in to most interior ceiling spaces.

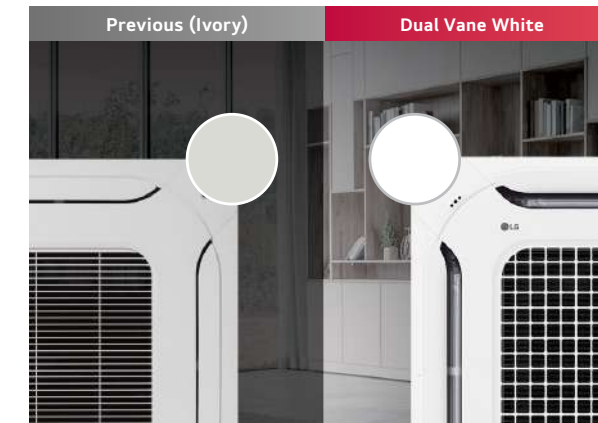

Wide Design

Bigger inlet and outlet make faster cooling / heating airflow.

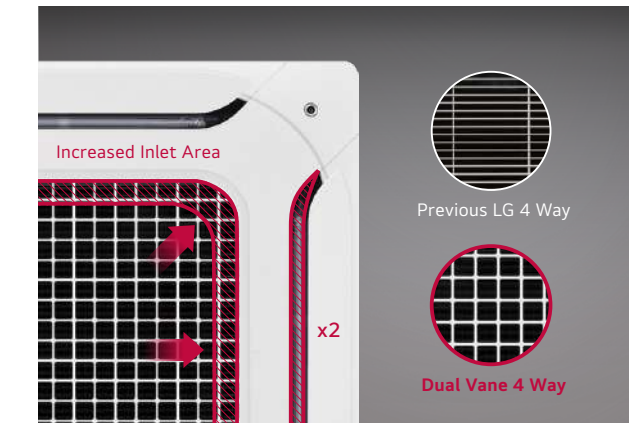

Full 3D Turbo Fan

3D Turbo fan decreases air resistance, to create powerful outlet flow.



High Efficiency Heat Exchanger (HEX)

Highly integrated heat exchanger is applied to increase cooling and heating efficiency.

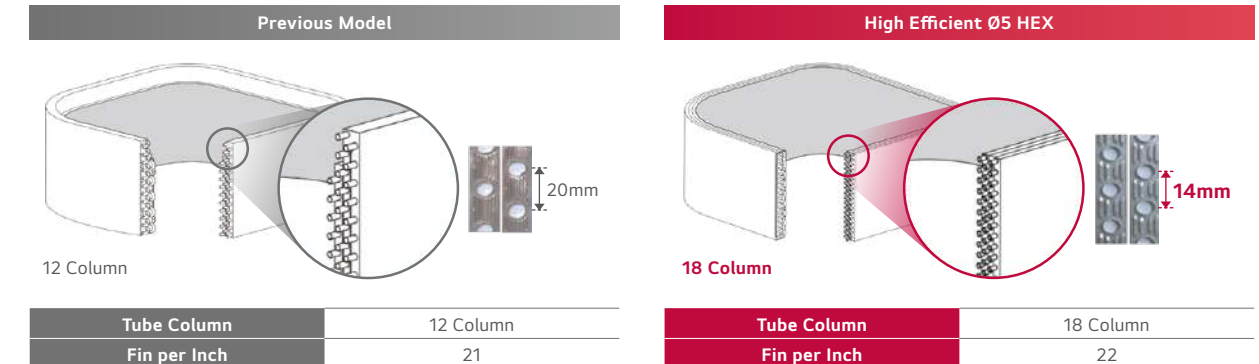

※ This specification can be different as per each model.

Sensor Reads Temperature from Ceiling to Floor for Heating (Optional Accessory)

IDU provides the human oriented room temperature with sensing floor and calculating by floor and ceiling temperature by thermopile sensor.

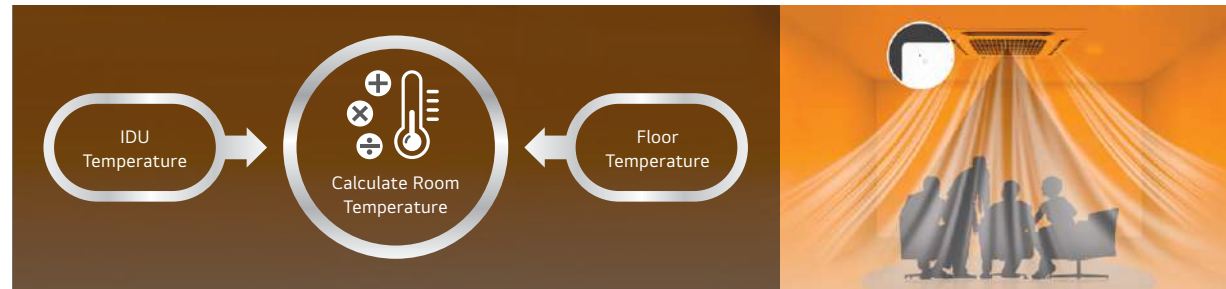

※ Available only for products with floor temperature sensor.

Human Detecting Direct / Indirect Airflow (Optional Accessory)

Human Detecting function can provide users favourite airflow.

Comfort Indirect



Follow User Direct



Direct Wind

Wind can reach up to 5m with plenty air volume. (@ 0.5ms)

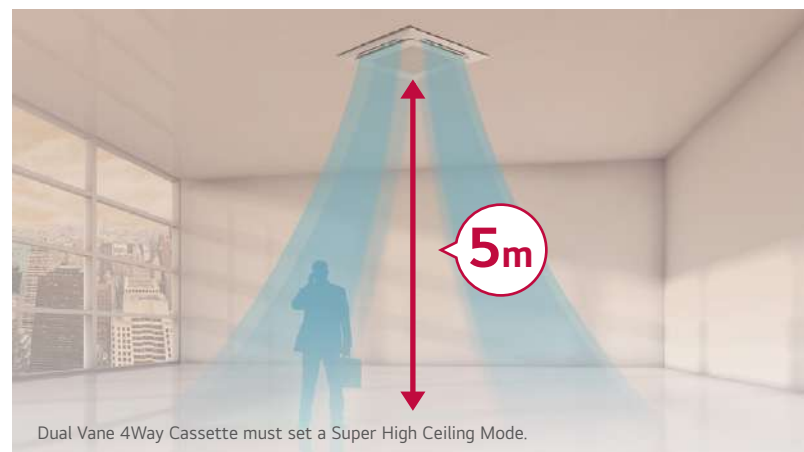

Recommended direct wind reach

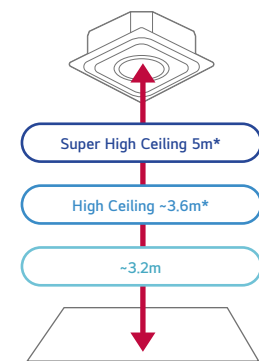

* Settings are required in installer mode.

Various Display of Air Purification (Optional Accessory)

Wi-Fi functionality for remote access for indoor unit control and air quality status display with LG ThinQ App.*

Smart indicator

Shows quality of Indoor air in real time

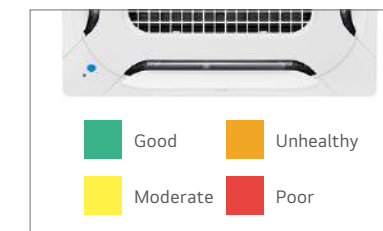

Remote controller

Display Air Quality Status and Fine Dust Concentration



Mobile

Whenever & Wherever Check and Control Air status



Pairing ThinQ*

Anywhere! Anytime! Can connect to IDU with ThinQ*

- ① Monitoring Air status : Easy to check indoor air status
 - Microfine dust / Ultra fine dust / Fine dust
 - Day / Week / Month / Yearly
- ② Mobile Remote Control : Remote control by using mobile phone
 - Control Mode / Temperature / Air flow etc.
- ③ Display Power Consumption : Check power consumption of A/C
 - Check energy display
 - Set target energy consumption level



※ For our policy of continuous improvement, specification, design and features are subject to change without prior notice.

LG ThinQ*

* LG ThinQ app available on Android or iOS smartphones. Compatible smartphone with Android 4.1.2 (Jellybean) or later or iOS 9 or later required for LG ThinQ app. Phone and Home Wi-Fi Data connection and product registration on the ThinQ app required. Smart features and voice assistant product may vary by country and model. Check with your local retailer or LG for service availability. Features and services may be changed by LG without notice. Google, Google Play, Google Home and all related logos are trademarks of Google LLC. Voice-enabled smart speaker device is not included.

Convenient and Powerful Air Purification (Optional Accessory)

Easy to manage air purifying system with one-touch air cleaning filter.

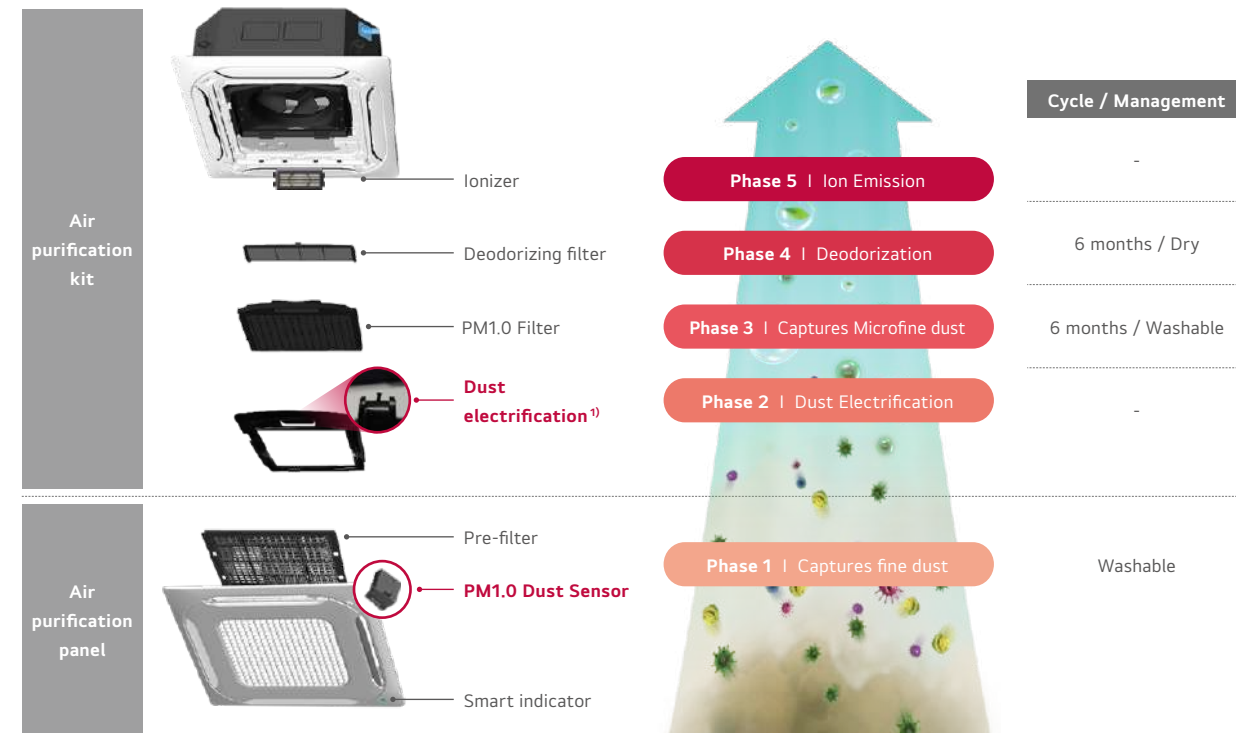

1) Electrical diffusion makes dust electrification.

CAC Certification?

The Korea Air Cleaning Association strictly tests the air cleaning function of air conditioner products and provide certification to the product that give credibility to consumers.



The Korea Air Cleaning Association

Air Purification Technology

5-Steps air cleaning process removes invisible, ultra fine dust, odor and germs to ensure a clean and healthy living environment

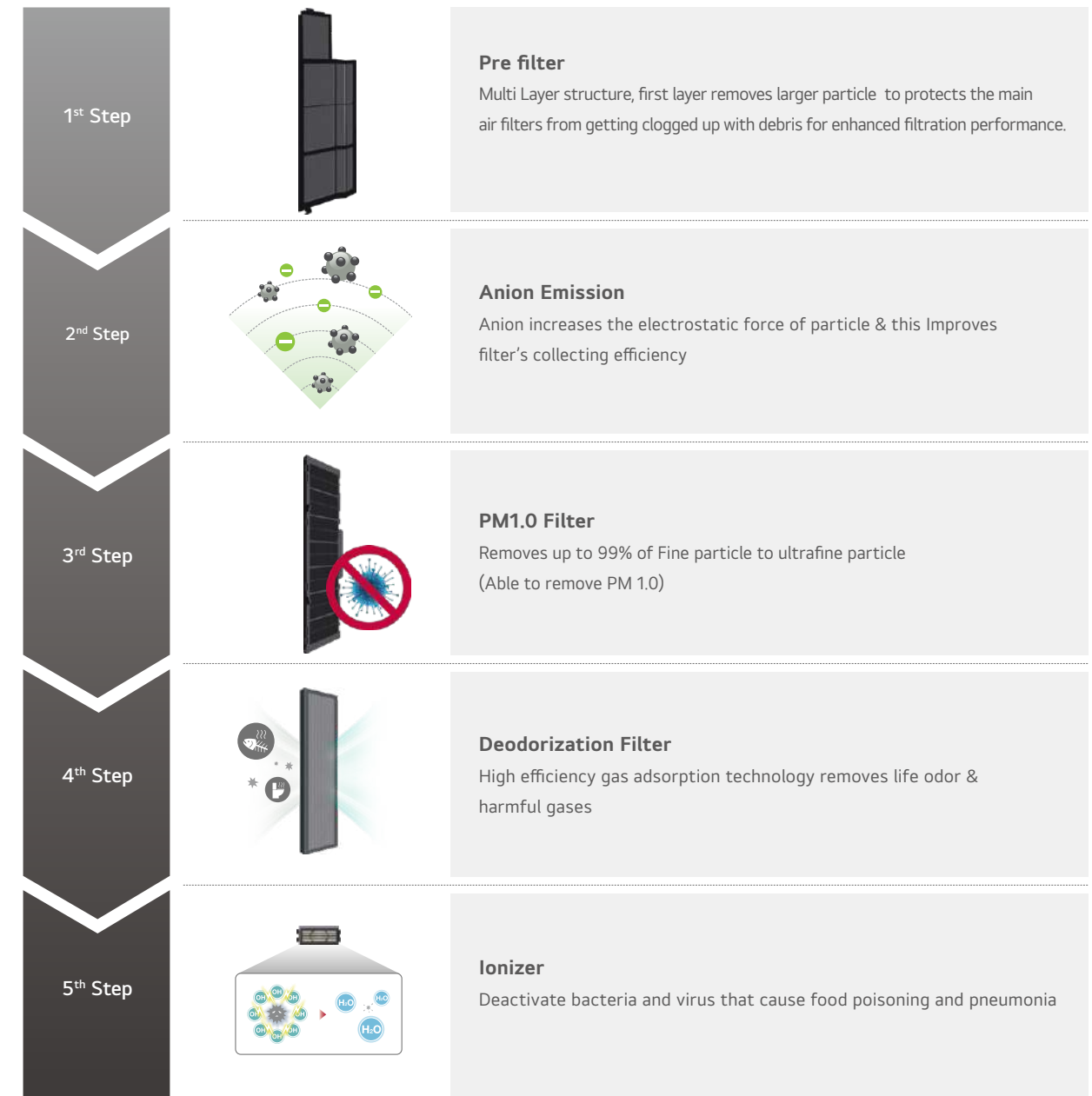

UTN70PB / UTN85PB



UU70WR2 /
UU85WR3



CATEGORY		INDOOR	UTN70PB	UTN85PB
		OUTDOOR	UU70WR2	UU85WR3
COMBINATIONAL SPECIFICATION		UNIT		
Cooling Capacity	Rated ²⁾	kW	6.80	8.00
	Min - Max	kW	2.70 - 8.00	3.20 - 9.20
Heating Capacity	Rated ²⁾	kW	7.50	8.90
	Min - Max	kW	3.00 - 9.00	3.60 - 10.10
AEER			3.493	3.243
ACOP			3.794	3.375
Rated Current	Cooling	A	8.60	10.90
	Heating	A	8.70	11.60
Full Load Amps		A	16.0	17.0
Air Flow Rate	Rated	L/s	283	317
Air Flow Rate	Min - Max	L/s	173 - 368	207 - 412
External Static Pressure	Min - Max	Pa		
Indoor	Net (W x H x D)	mm	840 x 204 x 840	840 x 204 x 840
	Net Weight	kg	21.1	21.1
	Cooling ((SH)/H/M/L)	dB(A)	- / 38.0 / 36.0 / 34.0	- / 40.0 / 37.0 / 35.0
Outdoor	Net (W x H x D)	mm	950 x 834 x 330	950 x 834 x 330
	Net Weight	kg	59.0	59.0
	Cooling / Heating (@ 1.5 m height)	dB(A)	48.0 / 52.0	50.0 / 52.0
Power Supply		∅, Hz, V	1, 50 Hz, 220-240 V	1, 50 Hz, 220-240 V
Compressor	Type	-	Twin Rotary	Twin Rotary
	Motor Type	-	BLDC	BLDC
Heat Exchanger	Fin Type	-	Wide Louver Plus	Wide Louver Plus
	Corrosion Protection (Coating)	-	Black 2	Black 2
Refrigerant	Type	-	R32	R32
	Pre-charge Length	m	10	10
Pipe size	Liquid	mm(inch)	∅9.52 (3/8)	∅9.52 (3/8)
	Gas	mm(inch)	∅15.88 (5/8)	∅15.88 (5/8)
	Drain Pipe (Drain Pump) OD/ID	mm(inch)	∅32 (1-1/4) / 25 (31/32)	∅32 (1-1/4) / 25 (31/32)
Piping Length	IDU - ODU (Rated / Max / Min)	m	7.5 / 50.0 / 5.0	7.5 / 50.0 / 5.0
Maximum Height Difference	IDU - ODU (Max)	m	30	30
Supply Air Opening	L x W	mm	64.3 x 577	64.3 x 577
Return Air Opening	L x W	mm	563 x 563	563 x 563
Continuous Operation	Cooling	°C (DB)	-15 - 48	-15 - 48
	Heating	°C (WB)	-18 - 18	-18 - 18
Wi-Fi Compatible ⁴⁾			Optional	Optional

Note:
 1. Specifications are correct at the time of printing and may be changed without notice.
 2. Capacities are based on following conditions.
 • Cooling: Indoor Temp 29°C DB / 19°C WB, Outdoor Temp 35°C DB / 24°C WB
 • Heating: Indoor Temp 20°C DB, Outdoor Temp 7°C DB / 6°C WB
 3. This product contains fluorinated greenhouse gases. (R32)
 4. (Sold separately) Dongle required for Wi-Fi Connectivity. Internet connection required.

UTN100MA / UTN125MA /
UTN140MA



UU100WR3 / UU125WR3 /
UU140WR3



CATEGORY		INDOOR	UTN100MA	UTN125MA	UTN140MA
		OUTDOOR	UU100WR3	UU125WR3	UU140WR3
COMBINATIONAL SPECIFICATION		UNIT			
Cooling Capacity	Rated ²⁾	kW	9.50	12.30	13.60
	Min - Max	kW	3.80 - 12.54	4.80 - 14.16	5.40 - 15.68
Heating Capacity	Rated ²⁾	kW	10.80	13.50	15.50
	Min - Max	kW	4.30 - 13.39	5.40 - 15.80	6.20 - 17.52
AEER			4.111	3.660	3.162
ACOP			4.354	3.791	3.506
Rated Current	Cooling	A	10.10	14.60	18.70
	Heating	A	10.70	15.00	19.00
Full Load Amps		A	17.0	28.0	28.0
Air Flow Rate	Rated	L/s	458	458	500
Air Flow Rate	Min - Max	L/s	300 - 595	300 - 595	333 - 650
External Static Pressure	Min - Max	Pa			
Indoor	Net (W x H x D)	mm	840 x 288 x 840	840 x 288 x 840	840 x 288 x 840
	Net Weight	kg	25.3	25.3	25.3
	Cooling ((SH)/H/M/L)	dB(A)	- / 44.0 / 42.0 / 41.0	- / 44.0 / 42.0 / 41.0	- / 46.0 / 44.0 / 42.0
Outdoor	Net (W x H x D)	mm	950 x 1,380 x 330	950 x 1,380 x 330	950 x 1,380 x 330
	Net Weight	kg	89.0	89.0	89.0
	Cooling / Heating (@ 1.5 m height)	dB(A)	50.0 / 50.0	51.0 / 52.0	52.0 / 53.0
Power Supply		∅, Hz, V	1, 50 Hz, 220-240 V	1, 50 Hz, 220-240 V	1, 50 Hz, 220-240 V
Compressor	Type	-	Inverter Scroll	Inverter Scroll	Inverter Scroll
	Motor Type	-	BLDC	BLDC	BLDC
Heat Exchanger	Fin Type	-	Wide Louver Plus	Wide Louver Plus	Wide Louver Plus
	Corrosion Protection (Coating)	-	Black 2	Black 2	Black 2
Refrigerant	Type	-	R32	R32	R32
	Pre-charge Length	m	20	20	20
Pipe size	Liquid	mm(inch)	∅9.52 (3/8)	∅9.52 (3/8)	∅9.52 (3/8)
	Gas	mm(inch)	∅15.88 (5/8)	∅15.88 (5/8)	∅15.88 (5/8)
	Drain Pipe (Drain Pump) OD/ID	mm(inch)	∅32 (1-1/4) / 25 (31/32)	∅32 (1-1/4) / 25 (31/32)	∅32 (1-1/4) / 25 (31/32)
Piping Length	IDU - ODU (Rated / Max / Min)	m	7.5 / 85 / 5.0	7.5 / 85 / 5.0	7.5 / 85 / 5.0
Maximum Height Difference	IDU - ODU (Max)	m	30	30	30
Supply Air Opening	L x W	mm	64.3 x 590	64.3 x 590	64.3 x 590
Return Air Opening	L x W	mm	563 x 563	563 x 563	563 x 563
Continuous Operation	Cooling	°C (DB)	-15 - 48	-15 - 48	-15 - 48
	Heating	°C (WB)	-18 - 18	-18 - 18	-18 - 18
Wi-Fi Compatible ⁴⁾			Optional	Optional	Optional

Note:
 1. Specifications are correct at the time of printing and may be changed without notice.
 2. Capacities are based on following conditions.
 • Cooling: Indoor Temp 29°C DB / 19°C WB, Outdoor Temp 35°C DB / 24°C WB
 • Heating: Indoor Temp 20°C DB, Outdoor Temp 7°C DB / 6°C WB
 3. This product contains fluorinated greenhouse gases. (R32)
 4. (Sold separately) Dongle required for Wi-Fi Connectivity. Internet connection required.

