

LG

MULTI V 5

Heat Pump 380-415V + 380V
R410A(50Hz/60Hz)
0CVV0-02K(Replaces 0CVV0-02J)

TOTAL HVAC SOLUTION PROVIDER

ENGINEERING PRODUCT DATA BOOK

MULTI VTM **5**

General Information

Outdoor Units

Installation of Outdoor Units

Special Guide









Control System

MULTI V™ **5**

General Information

- 1. Model Line-up & External Appearance**
- 2. Combination of Outdoor Units**
- 3. Nomenclature**
- 4. Indoor Unit and Outdoor Unit Capacity Index**

1. Model Line-up & External Appearance

CHASSIS	Model Name	Model
UXA	ARUN080LLS5 A(C)RUN100LLS5 A(C)RUN120LLS5 A(C)RUN140LLS5	
UXB	A(C)RUN160LLS5 A(C)RUN180LLS5 A(C)RUN200LLS5 A(C)RUN220LLS5 A(C)RUN240LLS5 A(C)RUN260LLS5	
UXB UXA	A(C)RUN280LLS5 A(C)RUN300LLS5 A(C)RUN320LLS5 A(C)RUN340LLS5 A(C)RUN360LLS5 A(C)RUN380LLS5 A(C)RUN400LLS5	
UXB UXB	A(C)RUN420LLS5 A(C)RUN440LLS5 A(C)RUN460LLS5 A(C)RUN480LLS5 A(C)RUN500LLS5 A(C)RUN520LLS5	
UXB UXB UXA	A(C)RUN540LLS5 A(C)RUN560LLS5 A(C)RUN580LLS5 A(C)RUN600LLS5 A(C)RUN620LLS5 A(C)RUN640LLS5 A(C)RUN660LLS5	
UXB UXB UXB	A(C)RUN680LLS5 A(C)RUN700LLS5 A(C)RUN720LLS5 A(C)RUN740LLS5 A(C)RUN760LLS5 A(C)RUN780LLS5	
UXB UXB UXB UXA	A(C)RUN800LLS5 A(C)RUN820LLS5 A(C)RUN840LLS5 A(C)RUN860LLS5 A(C)RUN880LLS5 A(C)RUN900LLS5 A(C)RUN920LLS5	
UXB UXB UXB UXB	A(C)RUN940LLS5 A(C)RUN960LLS5 A(C)RUN980LLS5 A(C)RUN1000LLS5 A(C)RUN1020LLS5 A(C)RUN1040LLS5	

2. Combination of Outdoor Units

Model Name	Number of Units	Module(HP)									
		8	10	12	14	16	18	20	22	24	26
ARUN080LLS5	1	1									
A(C)RUN100LLS5	1		1								
A(C)RUN120LLS5	1			1							
A(C)RUN140LLS5	1				1						
A(C)RUN160LLS5	1					1					
A(C)RUN180LLS5	1						1				
A(C)RUN200LLS5	1							1			
A(C)RUN220LLS5	1								1		
A(C)RUN240LLS5	1									1	
A(C)RUN260LLS5	1										1
A(C)RUN280LLS5	2			1		1					
A(C)RUN300LLS5	2			1			1				
A(C)RUN320LLS5	2			1				1			
A(C)RUN340LLS5	2			1					1		
A(C)RUN360LLS5	2			1						1	
A(C)RUN380LLS5	2			1							1
A(C)RUN400LLS5	2				1						1
A(C)RUN420LLS5	2					1					1
A(C)RUN440LLS5	2						1				1
A(C)RUN460LLS5	2							1			1
A(C)RUN480LLS5	2								1		1
A(C)RUN500LLS5	2									1	1
A(C)RUN520LLS5	2										2
A(C)RUN540LLS5	3			1		1					1
A(C)RUN560LLS5	3			1			1				1
A(C)RUN580LLS5	3			1				1			1
A(C)RUN600LLS5	3			1					1		1
A(C)RUN620LLS5	3			1						1	1
A(C)RUN640LLS5	3			1							2
A(C)RUN660LLS5	3				1						2
A(C)RUN680LLS5	3					1					2
A(C)RUN700LLS5	3						1				2
A(C)RUN720LLS5	3							1			2
A(C)RUN740LLS5	3								1		2
A(C)RUN760LLS5	3									1	2
A(C)RUN780LLS5	3										3
A(C)RUN800LLS5	4			1		1					2
A(C)RUN820LLS5	4			1			1				2
A(C)RUN840LLS5	4			1				1			2
A(C)RUN860LLS5	4			1					1		2
A(C)RUN880LLS5	4			1						1	2
A(C)RUN900LLS5	4			1							3
A(C)RUN920LLS5	4				1						3
A(C)RUN940LLS5	4					1					3
A(C)RUN960LLS5	4						1				3
A(C)RUN980LLS5	4							1			3
A(C)RUN1000LLS5	4								1		3
A(C)RUN1020LLS5	4									1	3
A(C)RUN1040LLS5	4										4

3. Nomenclature

Model Name	ARU	N	100	L	L	S	5
	CRU	N	100	L	L	S	5
No.	1	2	3	4	5	6	7

No.	Signification
1	Multi V System with Outdoor Unit using R410A ARU, CRU: Global line-up
2	Combination of Inverter Type and Cooling Only, Heat Pump or Heat Recovery N : Inverter, Heat Pump
3	Total Cooling capacity in Horse Power(HP) unit EX) 8HP → '080' 10HP → '100'
4	Electrical Ratings L : 3Ø, 380-415 V, 50 Hz / 3Ø, 380V, 60 Hz
5	Air Discharge Type L : Top Discharge Pro H/P (380V)
6	Efficiency S : Standard
7	Serial Number

4. Indoor Unit and Outdoor Unit Capacity Index

4.1 Indoor Unit Selection

See the indoor unit capacity tables for given Indoor and Outdoor temperature

Select the unit whose capacity is the nearest to or bigger than given load.

Note

Individual Indoor Unit capacity is subject to change by combination. Actual capacity has to be calculated according to the combination by using Outdoor unit capacity table.

4.2 Outdoor Unit Selection

Allowable combinations are indicated below. In general, outdoor unit can be selected depending on the location of the unit, zoning and usage of the rooms.

The indoor and outdoor unit combination is determined by comparing the sum of indoor unit capacity index with each Outdoor Unit. It is recommended to be the nearest to 100% combination ratio or to be smaller than that. Refer the table below. To manage cooling/heating load properly, it's better to be selected the bigger capacity outdoor unit rather than the nearest, if the installation space is large enough.

■ Allowable Total Capacity Index Table of Combined Indoor Units

Outdoor Unit Capacity(HP)	Indoor Unit Combination Ratio										
	50%	60%	70%	80%	90%	100%	110%	120%	130%	160%	200%
8	11.2	13.4	15.7	17.9	20.2	22.4	24.6	26.9	29.1	35.8	44.8
10	14.0	16.8	19.6	22.4	25.2	28.0	30.8	33.6	36.4	44.8	56.0
12	16.8	20.2	23.5	26.9	30.2	33.6	37.0	40.3	43.7	53.8	67.2
14	19.6	23.5	27.4	31.4	35.3	39.2	43.1	47.0	51.0	62.7	78.4
16	22.4	26.9	31.4	35.8	40.3	44.8	49.3	53.8	58.2	71.7	89.6
18	25.2	30.2	35.3	40.3	45.4	50.4	55.4	60.5	65.5	80.6	100.8
20	28.0	33.6	39.2	44.8	50.4	56.0	61.6	67.2	72.8	89.6	112.0
22	30.8	37.0	43.1	49.3	55.4	61.6	67.8	73.9	80.1	98.6	123.2
24	33.6	40.3	47.0	53.8	60.5	67.2	73.9	80.6	87.4	107.5	134.4
26	36.4	43.7	51.0	58.2	65.5	72.8	80.1	87.4	94.6	116.5	145.6
28	39.2	47.0	54.9	62.7	70.6	78.4	86.2	94.1	101.9	125.4	-
30	42.0	50.4	58.8	67.2	75.6	84.0	92.4	100.8	109.2	134.4	-
32	44.8	53.8	62.7	71.7	80.6	89.6	98.6	107.5	116.5	143.4	-
34	47.6	57.1	66.6	76.2	85.7	95.2	104.7	114.2	123.8	152.3	-
36	50.4	60.5	70.6	80.6	90.7	100.8	110.9	121.0	131.0	161.3	-
38	53.2	63.8	74.5	85.1	95.8	106.4	117.0	127.7	138.3	170.2	-
40	56.0	67.2	78.4	89.6	100.8	112.0	123.2	134.4	145.6	179.2	-
42	58.8	70.6	82.3	94.1	105.8	117.6	129.4	141.1	152.9	188.2	-
44	61.6	73.9	86.2	98.6	110.9	123.2	135.5	147.8	160.2	197.1	-
46	64.4	77.3	90.2	103.0	115.9	128.8	141.7	154.6	167.4	206.1	-
48	67.2	80.6	94.1	107.5	121.0	134.4	147.8	161.3	174.7	215.0	-
50	70.0	84.0	98.0	112.0	126.0	140.0	154.0	168.0	182.0	224.0	-
52	72.8	87.4	101.9	116.5	131.0	145.6	160.2	174.7	189.3	233.0	-
54	75.6	90.7	105.8	121.0	136.1	151.2	166.3	181.4	196.6	-	-
56	78.4	94.1	109.8	125.4	141.1	156.8	172.5	188.2	203.8	-	-
58	81.2	97.4	113.7	129.9	146.2	162.4	178.6	194.9	211.1	-	-
60	84.0	100.8	117.6	134.4	151.2	168.0	184.8	201.6	218.4	-	-
62	86.8	104.2	121.5	138.9	156.2	173.6	191.0	208.3	225.7	-	-
64	89.6	107.5	125.4	143.4	161.3	179.2	197.1	215.0	233.0	-	-
66	92.4	110.9	129.4	147.8	166.3	184.8	203.3	221.8	240.2	-	-
68	95.2	114.2	133.3	152.3	171.4	190.4	209.4	228.5	247.5	-	-

4. Indoor Unit and Outdoor Unit Capacity Index

Outdoor Unit Capacity(HP)	Indoor Unit Combination Ratio										
	50%	60%	70%	80%	90%	100%	110%	120%	130%	160%	200%
70	98.0	117.6	137.2	156.8	176.4	196.0	215.6	235.2	254.8	-	-
72	100.8	121.0	141.1	161.3	181.4	201.6	221.8	241.9	262.1	-	-
74	103.6	124.3	145.0	165.8	186.5	207.2	227.9	248.6	269.4	-	-
76	106.4	127.7	149.0	170.2	191.5	212.8	234.1	255.4	276.6	-	-
78	109.2	131.0	152.9	174.7	196.6	218.4	240.2	262.1	283.9	-	-
80	112.0	134.4	156.8	179.2	201.6	224.0	246.4	268.8	291.2	-	-
82	114.8	137.8	160.7	183.7	206.6	229.6	252.6	275.5	298.5	-	-
84	117.6	141.1	164.6	188.2	211.7	235.2	258.7	282.2	305.8	-	-
86	120.4	144.5	168.6	192.6	216.7	240.8	264.9	289.0	313.0	-	-
88	123.2	147.8	172.5	197.1	221.8	246.4	271.0	295.7	320.3	-	-
90	126.0	151.2	176.4	201.6	226.8	252.0	277.2	302.4	327.6	-	-
92	128.8	154.6	180.3	206.1	231.8	257.6	283.4	309.1	334.9	-	-
94	131.6	157.9	184.2	210.6	236.9	263.2	289.5	315.8	342.2	-	-
96	134.4	161.3	188.2	215.0	241.9	268.8	295.7	322.6	349.4	-	-
98	137.2	164.6	192.1	219.5	247.0	274.4	301.8	329.3	356.7	-	-
100	140.0	168.0	196.0	224.0	252.0	280.0	308.0	336.0	364.0	-	-
102	142.8	171.4	199.9	228.5	257.0	285.6	314.2	342.7	371.3	-	-
104	145.6	174.7	203.8	233.0	262.1	291.2	320.3	349.4	378.6	-	-

* Capacity Index is same as the capacity(kW).

INDOOR UNIT CAPACITY INDEX

Unit Capacity (Btu/h)	5k	7k	9k	12k	15k	18k	21k	24k	28k	30k	36k	42k	48k	54k	60k	76k	96k
Capacity Index	1.6	2.2	2.8	3.6	4.5	5.6	6.2	7.1	8.2	9.0	10.6	12.3	14.1	15.8	17.5	22.4	28.0

* Capacity Index is same as the capacity(kW).

CAUTION

◆ Combination Ratio(50~200%)

Number of Outdoor units	Combination Ratio
Single Unit	200%
Two Units combination	160%
Three or more Units combination	130%

Notes:

- We can guarantee the operation only within 130% Combination Ratio.**
If you want to connect more than 130% combination Ratio, please contact us and discuss the requirement.
- In case that operating indoor units ratio to rated capacity of outdoor unit is more than 130%, the airflow should be operated as low step in the all indoor units.**

MULTI V™ 5

Outdoor Units

- 1. Specifications**
- 2. Dimensions**
- 3. Piping Diagrams**
- 4. Wiring Diagrams**
- 5. Field Wiring**
- 6. Electric Characteristics**
- 7. Capacity Tables**
- 8. Capacity Correction Factor**
- 9. Operation Limits**
- 10. Sound Levels**
- 11. Accessories**

1. Specifications

HP			8	10
Model Name	Combination Unit		ARUN080LLS5	A(C)RUN100LLS5
	Independent Unit		ARUN080LLS5	A(C)RUN100LLS5
Capacity	Cooling(Rated)	kW	22.4	28.0
		kcal/h	19,300	24,100
		Btu/h	76,400	95,500
	Heating(Rated)	kW	22.4	28.0
		kcal/h	19,300	24,100
		Btu/h	76,400	95,500
Input (Rated)	Cooling	kW	5.10	6.80
	Heating	kW	5.03	7.07
EER (Rated)			4.39	4.12
COP (Rated)			4.45	3.96
Power Factor	Rated	-	0.93	0.93
Exterior	Casing Color		Morning Gray / Dawn Gray	Morning Gray / Dawn Gray
	RAL code		RAL 7038 / RAL 7037	RAL 7038 / RAL 7037
Heat Exchanger			Wide Louver Plus	Wide Louver Plus
Compressor	Type		Hermetically Sealed Scroll	Hermetically Sealed Scroll
	Piston Displacement	cm ³ /rev	43.8	43.8
	Number of Revolution	rev/min	3,600	3,600
	Motor Output × Number	W × No.	4,200	4,200
	Starting Method		Inverter	Inverter
	Oil Type		FW68D(PVE)	FW68D(PVE)
Fan	Type		Propeller fan	Propeller fan
	Motor Output × Number	W	1,200	1,200
	Air Flow Rate(High)	m ³ /min	240	240
		ft ³ /min	8,476	8,476
	Drive		DC INVERTER	DC INVERTER
	Discharge	Side / Top	TOP	TOP
Pipe Connections	Liquid Pipe	mm(inch)	9.52(3/8)	9.52(3/8)
	Gas Pipe	mm(inch)	19.05(3/4)	22.2(7/8)
Dimensions(W × H × D)	mm		(930 × 1,690 × 760)	(930 × 1,690 × 760)
	inch		(36-5/8 × 66-17/32 × 29-29/32)	(36-5/8 × 66-17/32 × 29-29/32)
Weight	Net	kg	167	167
		lbs	368	368
	Shipping	kg	179	179
		lbs	395	395
Sound Pressure Level	Cooling	dB(A)	58.0	58.0
	Heating	dB(A)	59.0	59.0
Sound Power Level	Cooling	dB(A)	78.0	78.0
	Heating	dB(A)	79.0	79.0

Note

- Due to our policy of innovation some specifications may be changed without notification.
- Wiring cable size must comply with the applicable local and national codes. And "Electric characteristics" chapter should be considered for electrical work and design. Especially the power cable and circuit breaker should be selected in accordance with that.
- Power factor could vary less than ±1% according to the operating conditions.
- Sound pressure level is measured on the rated condition in the anechoic rooms by ISO 3745 standard.
Sound power level is measured on the rated condition in the reverberation rooms by ISO 9614 standard.
Therefore, these values can be increased owing to ambient conditions during operation.
- Sound values of combination model are calculated values based on sound results of independent models.
Sound values can be increased owing to ambient or installation conditions during operation.
Sound values of system [dB(A)] = 10^{log} [10^{A1}(A1/10)+ ... +10^{An}(An/10)] , A1~An means sound values of independent models.
- Performances are based on the following conditions :
 - *Cooling : Indoor Ambient Temp. 27°CDB / 19°CWB, Outdoor Ambient Temp. 35°CDB / 24°CWB
 - *Heating : Indoor Ambient Temp. 20°CDB / 15°CWB, Outdoor Ambient Temp. 7°CDB / 6°CWB
 - Interconnected Pipe Length is 7.5m and difference of Elevation (Outdoor ~ Indoor Unit) is 0m.
- *** : The number in parentheses means maximum connectable indoor units in accordance with outdoor units combination (160~200%).
The recommended ratio is 130%.
- This product contains Fluorinated greenhouse gases.(R410A, GWP(Global warming potential) = 2,087.5)

1. Specifications

HP		8	10
Model Name	Combination Unit	ARUN080LLS5	A(C)RUN100LLS5
	Independent Unit	ARUN080LLS5	A(C)RUN100LLS5
Protection Devices	High pressure protection	High pressure sensor / High pressure switch	
	Compressor/Fan	Over-heat protection / Fan driver overload protector	
	Inverter	Over-heat protection / Over-current protection	
Communication Cable		No. × mm ² (VCTF-SB)	2C × 1.0 ~ 1.5
Refrigerant	Refrigerant name		R410A
	Precharged Amount	kg	4.7
		lbs	10.4
	GWP		2087.5
	TCO ₂ eq		9.8
Control		Electronic Expansion Valve	
Power Supply		∅, V, Hz	380~415, 3, 50
			380, 3, 60
Number of maximum connectable indoor units***			13(20)
			16(25)

Note

- Due to our policy of innovation some specifications may be changed without notification.
- Wiring cable size must comply with the applicable local and national codes. And "Electric characteristics" chapter should be considered for electrical work and design. Especially the power cable and circuit breaker should be selected in accordance with that.
- Power factor could vary less than ±1% according to the operating conditions.
- Sound pressure level is measured on the rated condition in the anechoic rooms by ISO 3745 standard.
Sound power level is measured on the rated condition in the reverberation rooms by ISO 9614 standard.
Therefore, these values can be increased owing to ambient conditions during operation.
- Sound values of combination model are calculated values based on sound results of independent models.
Sound values can be increased owing to ambient or installation conditions during operation.
Sound values of system [dB(A)] = $10 \cdot \log [10^{A1/10} + \dots + 10^{An/10}]$, A1~An means sound values of independent models.
- Performances are based on the following conditions :
 - *Cooling : Indoor Ambient Temp. 27°CDB / 19°CWB, Outdoor Ambient Temp. 35°CDB / 24°CWB
 - *Heating : Indoor Ambient Temp. 20°CDB / 15°CWB, Outdoor Ambient Temp. 7°CDB / 6°CWB
 - Interconnected Pipe Length is 7.5m and difference of Elevation (Outdoor ~ Indoor Unit) is 0m.
- *** : The number in parentheses means maximum connectable indoor units in accordance with outdoor units combination (160~200%).
The recommended ratio is 130%.
- This product contains Fluorinated greenhouse gases.(R410A, GWP(Global warming potential) = 2,087.5)

1. Specifications

HP			12	14
Model Name	Combination Unit		A(C)RUN120LLS5	A(C)RUN140LLS5
	Independent Unit		A(C)RUN120LLS5	A(C)RUN140LLS5
Capacity	Cooling(Rated)	kW	33.6	39.2
		kcal/h	28,900	33,700
		Btu/h	114,600	133,800
	Heating(Rated)	kW	33.6	39.2
		kcal/h	28,900	33,700
		Btu/h	114,600	133,800
Input (Rated)	Cooling	kW	8.90	10.60
	Heating	kW	9.10	11.60
EER (Rated)			3.78	3.70
COP (Rated)			3.69	3.38
Power Factor	Rated	-	0.93	0.93
Exterior	Casing Color		Morning Gray / Dawn Gray	Morning Gray / Dawn Gray
	RAL code		RAL 7038 / RAL 7037	RAL 7038 / RAL 7037
Heat Exchanger			Wide Louver Plus	Wide Louver Plus
Compressor	Type		Hermetically Sealed Scroll	Hermetically Sealed Scroll
	Piston Displacement	cm ³ /rev	62.1	62.1
	Number of Revolution	rev/min	3,600	3,600
	Motor Output × Number	W × No.	5,300	5,300
	Starting Method		Inverter	Inverter
Oil Type		FW68D(PVE)	FW68D(PVE)	
Fan	Type		Propeller fan	Propeller fan
	Motor Output × Number	W	1,200	1,200
	Air Flow Rate(High)	m ³ /min	240	240
		ft ³ /min	8,476	8,476
	Drive		DC INVERTER	DC INVERTER
Discharge		Side / Top	TOP	
Pipe Connections	Liquid Pipe	mm(inch)	12.7(1/2)	12.7(1/2)
	Gas Pipe	mm(inch)	28.58(1-1/8)	28.58(1-1/8)
Dimensions(W × H × D)	mm		(930 × 1,690 × 760)	(930 × 1,690 × 760)
	inch		(36-5/8 × 66-17/32 × 29-29/32)	(36-5/8 × 66-17/32 × 29-29/32)
Weight	Net	kg	172	184
		lbs	373	401
	Shipping	kg	184	196
		lbs	406	432
Sound Pressure Level	Cooling	dB(A)	59.0	60.0
	Heating	dB(A)	60.0	61.0
Sound Power Level	Cooling	dB(A)	79.0	82.0
	Heating	dB(A)	80.0	83.0

Note

- Due to our policy of innovation some specifications may be changed without notification.
- Wiring cable size must comply with the applicable local and national codes. And "Electric characteristics" chapter should be considered for electrical work and design. Especially the power cable and circuit breaker should be selected in accordance with that.
- Power factor could vary less than ±1% according to the operating conditions.
- Sound pressure level is measured on the rated condition in the anechoic rooms by ISO 3745 standard.
Sound power level is measured on the rated condition in the reverberation rooms by ISO 9614 standard.
Therefore, these values can be increased owing to ambient conditions during operation.
- Sound values of combination model are calculated values based on sound results of independent models.
Sound values can be increased owing to ambient or installation conditions during operation.
Sound values of system [dB(A)] = 10^{log} [10^{A1}(A1/10)+ ... +10^{An}(An/10)] , A1~An means sound values of independent models.
- Performances are based on the following conditions :
 - *Cooling : Indoor Ambient Temp. 27°CDB / 19°CWB, Outdoor Ambient Temp. 35°CDB / 24°CWB
 - *Heating : Indoor Ambient Temp. 20°CDB / 15°CWB, Outdoor Ambient Temp. 7°CDB / 6°CWB
 - Interconnected Pipe Length is 7.5m and difference of Elevation (Outdoor ~ Indoor Unit) is 0m.
- *** : The number in parentheses means maximum connectable indoor units in accordance with outdoor units combination (160~200%).
The recommended ratio is 130%.
- This product contains Fluorinated greenhouse gases.(R410A, GWP(Global warming potential) = 2,087.5)

1. Specifications

HP		12	14
Model Name	Combination Unit	A(C)RUN120LLS5	A(C)RUN140LLS5
	Independent Unit	A(C)RUN120LLS5	A(C)RUN140LLS5
Protection Devices	High pressure protection	High pressure sensor / High pressure switch	
	Compressor/Fan	Over-heat protection / Fan driver overload protector	
	Inverter	Over-heat protection / Over-current protection	
Communication Cable		No. × mm ² (VCTF-SB)	2C × 1.0 ~ 1.5
Refrigerant	Refrigerant name		R410A
	Precharged Amount	kg	4.7
		lbs	10.4
	GWP		2087.5
	TCO ₂ eq		9.8
Control		Electronic Expansion Valve	
Power Supply		∅, V, Hz	380~415, 3, 50
			380, 3, 60
Number of maximum connectable indoor units***			20(30)
			23(35)

Note

- Due to our policy of innovation some specifications may be changed without notification.
- Wiring cable size must comply with the applicable local and national codes. And "Electric characteristics" chapter should be considered for electrical work and design. Especially the power cable and circuit breaker should be selected in accordance with that.
- Power factor could vary less than ±1% according to the operating conditions.
- Sound pressure level is measured on the rated condition in the anechoic rooms by ISO 3745 standard.
Sound power level is measured on the rated condition in the reverberation rooms by ISO 9614 standard.
Therefore, these values can be increased owing to ambient conditions during operation.
- Sound values of combination model are calculated values based on sound results of independent models.
Sound values can be increased owing to ambient or installation conditions during operation.
Sound values of system [dB(A)] = $10 \cdot \log [10^{A1/10} + \dots + 10^{An/10}]$, A1~An means sound values of independent models.
- Performances are based on the following conditions :
 - *Cooling : Indoor Ambient Temp. 27°CDB / 19°CWB, Outdoor Ambient Temp. 35°CDB / 24°CWB
 - *Heating : Indoor Ambient Temp. 20°CDB / 15°CWB, Outdoor Ambient Temp. 7°CDB / 6°CWB
 - Interconnected Pipe Length is 7.5m and difference of Elevation (Outdoor ~ Indoor Unit) is 0m.
- *** : The number in parentheses means maximum connectable indoor units in accordance with outdoor units combination (160~200%).
The recommended ratio is 130%.
- This product contains Fluorinated greenhouse gases.(R410A, GWP(Global warming potential) = 2,087.5)

1. Specifications

HP			16	18
Model Name	Combination Unit		A(C)RUN160LLS5	A(C)RUN180LLS5
	Independent Unit		A(C)RUN160LLS5	A(C)RUN180LLS5
Capacity	Cooling(Rated)	kW	44.8	50.4
		kcal/h	38,500	43,300
		Btu/h	152,900	172,000
	Heating(Rated)	kW	44.8	50.4
		kcal/h	38,500	43,300
		Btu/h	152,900	172,000
Input (Rated)	Cooling	kW	11.90	12.30
	Heating	kW	12.10	12.10
EER (Rated)			3.76	4.10
COP (Rated)			3.70	4.17
Power Factor	Rated	-	0.93	0.93
Exterior	Casing Color		Morning Gray / Dawn Gray	Morning Gray / Dawn Gray
	RAL code		RAL 7038 / RAL 7037	RAL 7038 / RAL 7037
Heat Exchanger			Wide Louver Plus	Wide Louver Plus
Compressor	Type		Hermetically Sealed Scroll	Hermetically Sealed Scroll
	Piston Displacement	cm ³ /rev	62.1	87.6
	Number of Revolution	rev/min	3,600	3,600
	Motor Output × Number	W × No.	5,300	7,500
	Starting Method		Inverter	Inverter
	Oil Type		FW68D(PVE)	FW68D(PVE)
Fan	Type		Propeller fan	Propeller fan
	Motor Output × Number	W	900 × 2	900 × 2
	Air Flow Rate(High)	m ³ /min	320	320
		ft ³ /min	11,301	11,301
	Drive		DC INVERTER	DC INVERTER
	Discharge	Side / Top	TOP	TOP
Pipe Connections	Liquid Pipe	mm(inch)	12.7(1/2)	15.88(5/8)
	Gas Pipe	mm(inch)	28.58(1-1/8)	28.58(1-1/8)
Dimensions(W × H × D)	mm		(1,240 × 1,690 × 760)	(1,240 × 1,690 × 760)
	inch		(48-13/16 × 66-17/32 × 29-29/32)	(48-13/16 × 66-17/32 × 29-29/32)
Weight	Net	kg	205	230
		lbs	448	492
	Shipping	kg	222	247
		lbs	489	545
Sound Pressure Level	Cooling	dB(A)	60.5	62.0
	Heating	dB(A)	61.5	64.5
Sound Power Level	Cooling	dB(A)	83.0	85.0
	Heating	dB(A)	85.0	86.0

Note

- Due to our policy of innovation some specifications may be changed without notification.
- Wiring cable size must comply with the applicable local and national codes. And "Electric characteristics" chapter should be considered for electrical work and design. Especially the power cable and circuit breaker should be selected in accordance with that.
- Power factor could vary less than ±1% according to the operating conditions.
- Sound pressure level is measured on the rated condition in the anechoic rooms by ISO 3745 standard.
Sound power level is measured on the rated condition in the reverberation rooms by ISO 9614 standard.
Therefore, these values can be increased owing to ambient conditions during operation.
- Sound values of combination model are calculated values based on sound results of independent models.
Sound values can be increased owing to ambient or installation conditions during operation.
Sound values of system [dB(A)] = 10^{log} [10^{A1/10}+ ... +10^{An/10}], A1~An means sound values of independent models.
- Performances are based on the following conditions :
 - *Cooling : Indoor Ambient Temp. 27°CDB / 19°CWB, Outdoor Ambient Temp. 35°CDB / 24°CWB
 - *Heating : Indoor Ambient Temp. 20°CDB / 15°CWB, Outdoor Ambient Temp. 7°CDB / 6°CWB
 - Interconnected Pipe Length is 7.5m and difference of Elevation (Outdoor ~ Indoor Unit) is 0m.
- *** : The number in parentheses means maximum connectable indoor units in accordance with outdoor units combination (160~200%).
The recommended ratio is 130%.
- This product contains Fluorinated greenhouse gases.(R410A, GWP(Global warming potential) = 2,087.5)

1. Specifications

HP		16	18
Model Name	Combination Unit	A(C)RUN160LLS5	A(C)RUN180LLS5
	Independent Unit	A(C)RUN160LLS5	A(C)RUN180LLS5
Protection Devices	High pressure protection	High pressure sensor / High pressure switch	
	Compressor/Fan	Over-heat protection / Fan driver overload protector	
	Inverter	Over-heat protection / Over-current protection	
Communication Cable		No. × mm ² (VCTF-SB)	2C × 1.0 ~ 1.5
Refrigerant	Refrigerant name		R410A
	Precharged Amount	kg	6.5
		lbs	14.3
	GWP		2087.5
	TCO ₂ eq		13.6
Control		Electronic Expansion Valve	
Power Supply		∅, V, Hz	380~415, 3, 50
			380, 3, 60
Number of maximum connectable indoor units***			26(40)
			29(45)

Note

- Due to our policy of innovation some specifications may be changed without notification.
- Wiring cable size must comply with the applicable local and national codes. And "Electric characteristics" chapter should be considered for electrical work and design. Especially the power cable and circuit breaker should be selected in accordance with that.
- Power factor could vary less than ±1% according to the operating conditions.
- Sound pressure level is measured on the rated condition in the anechoic rooms by ISO 3745 standard.
Sound power level is measured on the rated condition in the reverberation rooms by ISO 9614 standard.
Therefore, these values can be increased owing to ambient conditions during operation.
- Sound values of combination model are calculated values based on sound results of independent models.
Sound values can be increased owing to ambient or installation conditions during operation.
Sound values of system [dB(A)] = $10 \cdot \log [10^{A1/10} + \dots + 10^{An/10}]$, A1~An means sound values of independent models.
- Performances are based on the following conditions :
 - *Cooling : Indoor Ambient Temp. 27°CDB / 19°CWB, Outdoor Ambient Temp. 35°CDB / 24°CWB
 - *Heating : Indoor Ambient Temp. 20°CDB / 15°CWB, Outdoor Ambient Temp. 7°CDB / 6°CWB
 - Interconnected Pipe Length is 7.5m and difference of Elevation (Outdoor ~ Indoor Unit) is 0m.
- *** : The number in parentheses means maximum connectable indoor units in accordance with outdoor units combination (160~200%).
The recommended ratio is 130%.
- This product contains Fluorinated greenhouse gases.(R410A, GWP(Global warming potential) = 2,087.5)

1. Specifications

HP			20	22
Model Name	Combination Unit		A(C)RUN200LLS5	A(C)RUN220LLS5
	Independent Unit		A(C)RUN200LLS5	A(C)RUN220LLS5
Capacity	Cooling(Rated)	kW	56.0	61.6
		kcal/h	48,200	53,000
		Btu/h	191,100	210,200
	Heating(Rated)	kW	56.0	61.6
		kcal/h	48,200	53,000
		Btu/h	191,100	210,200
Input (Rated)	Cooling	kW	14.10	16.80
	Heating	kW	14.50	17.80
EER (Rated)			3.97	3.67
COP (Rated)			3.86	3.46
Power Factor	Rated	-	0.93	0.93
Exterior	Casing Color		Morning Gray / Dawn Gray	Morning Gray / Dawn Gray
	RAL code		RAL 7038 / RAL 7037	RAL 7038 / RAL 7037
Heat Exchanger			Wide Louver Plus	Wide Louver Plus
Compressor	Type		Hermetically Sealed Scroll	Hermetically Sealed Scroll
	Piston Displacement	cm ³ /rev	87.6	87.6
	Number of Revolution	rev/min	3,600	3,600
	Motor Output × Number	W × No.	7,500	7,500
	Starting Method		Inverter	Inverter
	Oil Type		FW68D(PVE)	FW68D(PVE)
Fan	Type		Propeller fan	Propeller fan
	Motor Output × Number	W	900 × 2	900 × 2
	Air Flow Rate(High)	m ³ /min	320	320
		ft ³ /min	11,301	11,301
	Drive		DC INVERTER	DC INVERTER
	Discharge	Side / Top	TOP	TOP
Pipe Connections	Liquid Pipe	mm(inch)	15.88(5/8)	15.88(5/8)
	Gas Pipe	mm(inch)	28.58(1-1/8)	28.58(1-1/8)
Dimensions(W × H × D)	mm		(1,240 × 1,690 × 760)	(1,240 × 1,690 × 760)
	inch		(48-13/16 × 66-17/32 × 29-29/32)	(48-13/16 × 66-17/32 × 29-29/32)
Weight	Net	kg	230	230
		lbs	492	492
	Shipping	kg	247	247
		lbs	545	545
Sound Pressure Level	Cooling	dB(A)	63.0	64.0
	Heating	dB(A)	66.0	67.0
Sound Power Level	Cooling	dB(A)	86.0	87.0
	Heating	dB(A)	89.0	90.0

Note

- Due to our policy of innovation some specifications may be changed without notification.
- Wiring cable size must comply with the applicable local and national codes. And "Electric characteristics" chapter should be considered for electrical work and design. Especially the power cable and circuit breaker should be selected in accordance with that.
- Power factor could vary less than ±1% according to the operating conditions.
- Sound pressure level is measured on the rated condition in the anechoic rooms by ISO 3745 standard.
Sound power level is measured on the rated condition in the reverberation rooms by ISO 9614 standard.
Therefore, these values can be increased owing to ambient conditions during operation.
- Sound values of combination model are calculated values based on sound results of independent models.
Sound values can be increased owing to ambient or installation conditions during operation.
Sound values of system [dB(A)] = 10^{log} [10^{A1/10}+ ... +10^{An/10}], A1~An means sound values of independent models.
- Performances are based on the following conditions :
 - *Cooling : Indoor Ambient Temp. 27°CDB / 19°CWB, Outdoor Ambient Temp. 35°CDB / 24°CWB
 - *Heating : Indoor Ambient Temp. 20°CDB / 15°CWB, Outdoor Ambient Temp. 7°CDB / 6°CWB
 - Interconnected Pipe Length is 7.5m and difference of Elevation (Outdoor ~ Indoor Unit) is 0m.
- *** : The number in parentheses means maximum connectable indoor units in accordance with outdoor units combination (160~200%).
The recommended ratio is 130%.
- This product contains Fluorinated greenhouse gases.(R410A, GWP(Global warming potential) = 2,087.5)

1. Specifications

HP		20	22
Model Name	Combination Unit	A(C)RUN200LLS5	A(C)RUN220LLS5
	Independent Unit	A(C)RUN200LLS5	A(C)RUN220LLS5
Protection Devices	High pressure protection	High pressure sensor / High pressure switch	
	Compressor/Fan	Over-heat protection / Fan driver overload protector	
	Inverter	Over-heat protection / Over-current protection	
Communication Cable		No. × mm ² (VCTF-SB)	2C × 1.0 ~ 1.5
Refrigerant	Refrigerant name		R410A
	Precharged Amount	kg	7.5
		lbs	16.5
	GWP		2087.5
	TCO ₂ eq		15.7
Control		Electronic Expansion Valve	
Power Supply		∅, V, Hz	380~415, 3, 50
			380, 3, 60
Number of maximum connectable indoor units***			32(50)
			35(56)

Note

- Due to our policy of innovation some specifications may be changed without notification.
- Wiring cable size must comply with the applicable local and national codes. And "Electric characteristics" chapter should be considered for electrical work and design. Especially the power cable and circuit breaker should be selected in accordance with that.
- Power factor could vary less than ±1% according to the operating conditions.
- Sound pressure level is measured on the rated condition in the anechoic rooms by ISO 3745 standard.
Sound power level is measured on the rated condition in the reverberation rooms by ISO 9614 standard.
Therefore, these values can be increased owing to ambient conditions during operation.
- Sound values of combination model are calculated values based on sound results of independent models.
Sound values can be increased owing to ambient or installation conditions during operation.
Sound values of system [dB(A)] = $10 \cdot \log [10^{A1/10} + \dots + 10^{An/10}]$, A1~An means sound values of independent models.
- Performances are based on the following conditions :
 - *Cooling : Indoor Ambient Temp. 27°CDB / 19°CWB, Outdoor Ambient Temp. 35°CDB / 24°CWB
 - *Heating : Indoor Ambient Temp. 20°CDB / 15°CWB, Outdoor Ambient Temp. 7°CDB / 6°CWB
 - Interconnected Pipe Length is 7.5m and difference of Elevation (Outdoor ~ Indoor Unit) is 0m.
- *** : The number in parentheses means maximum connectable indoor units in accordance with outdoor units combination (160~200%).
The recommended ratio is 130%.
- This product contains Fluorinated greenhouse gases.(R410A, GWP(Global warming potential) = 2,087.5)

1. Specifications

HP			24	26
Model Name	Combination Unit		A(C)RUN240LLS5	A(C)RUN260LLS5
	Independent Unit		A(C)RUN240LLS5	A(C)RUN260LLS5
Capacity	Cooling(Rated)	kW	67.2	72.8
		kcal/h	57,800	62,600
		Btu/h	229,300	248,400
	Heating(Rated)	kW	67.2	72.8
		kcal/h	57,800	62,600
		Btu/h	229,300	248,400
Input (Rated)	Cooling	kW	18.20	20.80
	Heating	kW	17.90	20.50
EER (Rated)			3.69	3.50
COP (Rated)			3.75	3.55
Power Factor	Rated	-	0.93	0.93
Exterior	Casing Color		Morning Gray / Dawn Gray	Morning Gray / Dawn Gray
	RAL code		RAL 7038 / RAL 7037	RAL 7038 / RAL 7037
Heat Exchanger			Wide Louver Plus	Wide Louver Plus
Compressor	Type		Hermetically Sealed Scroll	Hermetically Sealed Scroll
	Piston Displacement	cm ³ /rev	62.1 × 2	62.1 × 2
	Number of Revolution	rev/min	3,600 × 2	3,600 × 2
	Motor Output × Number	W × No.	5,300 × 2	5,300 × 2
	Starting Method		Inverter	Inverter
Oil Type		FW68D(PVE)	FW68D(PVE)	
Fan	Type		Propeller fan	Propeller fan
	Motor Output × Number	W	900 × 2	900 × 2
	Air Flow Rate(High)	m ³ /min	320	320
		ft ³ /min	11,301	11,301
	Drive		DC INVERTER	DC INVERTER
Discharge		Side / Top	TOP	
Pipe Connections	Liquid Pipe	mm(inch)	15.88(5/8)	19.05(3/4)
	Gas Pipe	mm(inch)	34.9(1-3/8)	34.9(1-3/8)
Dimensions(W × H × D)		mm	(1,240 × 1,690 × 760)	(1,240 × 1,690 × 760)
		inch	(48-13/16 × 66-17/32 × 29-29/32)	(48-13/16 × 66-17/32 × 29-29/32)
Weight	Net	kg	268	268
		lbs	580	580
	Shipping	kg	285	285
		lbs	628	628
Sound Pressure Level	Cooling	dB(A)	65.0	65.0
	Heating	dB(A)	67.0	67.0
Sound Power Level	Cooling	dB(A)	88.0	88.0
	Heating	dB(A)	90.0	90.0

Note

- Due to our policy of innovation some specifications may be changed without notification.
- Wiring cable size must comply with the applicable local and national codes. And "Electric characteristics" chapter should be considered for electrical work and design. Especially the power cable and circuit breaker should be selected in accordance with that.
- Power factor could vary less than ±1% according to the operating conditions.
- Sound pressure level is measured on the rated condition in the anechoic rooms by ISO 3745 standard.
Sound power level is measured on the rated condition in the reverberation rooms by ISO 9614 standard.
Therefore, these values can be increased owing to ambient conditions during operation.
- Sound values of combination model are calculated values based on sound results of independent models.
Sound values can be increased owing to ambient or installation conditions during operation.
Sound values of system [dB(A)] = 10^{log} [10^{A1}(A1/10)+ ... +10^{An}(An/10)] , A1~An means sound values of independent models.
- Performances are based on the following conditions :
 - *Cooling : Indoor Ambient Temp. 27°CDB / 19°CWB, Outdoor Ambient Temp. 35°CDB / 24°CWB
 - *Heating : Indoor Ambient Temp. 20°CDB / 15°CWB, Outdoor Ambient Temp. 7°CDB / 6°CWB
 - Interconnected Pipe Length is 7.5m and difference of Elevation (Outdoor ~ Indoor Unit) is 0m.
- *** : The number in parentheses means maximum connectable indoor units in accordance with outdoor units combination (160~200%).
The recommended ratio is 130%.
- This product contains Fluorinated greenhouse gases.(R410A, GWP(Global warming potential) = 2,087.5)

1. Specifications

HP		24	26
Model Name	Combination Unit	A(C)RUN240LLS5	A(C)RUN260LLS5
	Independent Unit	A(C)RUN240LLS5	A(C)RUN260LLS5
Protection Devices	High pressure protection	High pressure sensor / High pressure switch	
	Compressor/Fan	Over-heat protection / Fan driver overload protector	
	Inverter	Over-heat protection / Over-current protection	
Communication Cable	No. × mm ² (VCTF-SB)	2C × 1.0 ~ 1.5	2C × 1.0 ~ 1.5
Refrigerant	Refrigerant name	R410A	R410A
	Precharged Amount	kg	11
		lbs	24.3
	GWP	2087.5	2087.5
	TCO ₂ eq	23.0	23.0
Control	Electronic Expansion Valve	Electronic Expansion Valve	
Power Supply	∅, V, Hz	380~415, 3, 50	380~415, 3, 50
		380, 3, 60	380, 3, 60
Number of maximum connectable indoor units***		39(61)	42(64)
Note			
1. Due to our policy of innovation some specifications may be changed without notification.			
2. Wiring cable size must comply with the applicable local and national codes. And "Electric characteristics" chapter should be considered for electrical work and design. Especially the power cable and circuit breaker should be selected in accordance with that.			
3. Power factor could vary less than ±1% according to the operating conditions.			
4. Sound pressure level is measured on the rated condition in the anechoic rooms by ISO 3745 standard. Sound power level is measured on the rated condition in the reverberation rooms by ISO 9614 standard. Therefore, these values can be increased owing to ambient conditions during operation.			
5. Sound values of combination model are calculated values based on sound results of independent models. Sound values can be increased owing to ambient or installation conditions during operation. Sound values of system [dB(A)] = 10*log [10 ^{A1/10} + ... +10 ^{An/10}] , A1~An means sound values of independent models.			
6. Performances are based on the following conditions : • *Cooling : Indoor Ambient Temp. 27°CDB / 19°CWB, Outdoor Ambient Temp. 35°CDB / 24°CWB • *Heating : Indoor Ambient Temp. 20°CDB / 15°CWB, Outdoor Ambient Temp. 7°CDB / 6°CWB • Interconnected Pipe Length is 7.5m and difference of Elevation (Outdoor ~ Indoor Unit) is 0m.			
7. *** : The number in parentheses means maximum connectable indoor units in accordance with outdoor units combination (160~200%). The recommended ratio is 130%.			
8. This product contains Fluorinated greenhouse gases.(R410A, GWP(Global warming potential) = 2,087.5)			

1. Specifications

HP			28	30
Model Name	Combination Unit		A(C)RUN280LLS5	A(C)RUN300LLS5
	Independent Unit		A(C)RUN160LLS5	A(C)RUN180LLS5
			A(C)RUN120LLS5	A(C)RUN120LLS5
Capacity	Cooling(Rated)	kW	78.4	84.0
		kcal/h	67,400	72,200
		Btu/h	267,500	286,600
	Heating(Rated)	kW	78.4	84.0
		kcal/h	67,400	72,200
		Btu/h	267,500	286,600
Input (Rated)	Cooling	kW	20.8	21.2
	Heating	kW	21.2	21.2
EER (Rated)			3.77	3.96
COP (Rated)			3.70	3.96
Power Factor	Rated	-	0.93	0.93
Exterior	Casing Color		Morning Gray / Dawn Gray	Morning Gray / Dawn Gray
	RAL code		RAL 7038 / RAL 7037	RAL 7038 / RAL 7037
Heat Exchanger			Wide Louver Plus	Wide Louver Plus
Compressor	Type		Hermetically Sealed Scroll	Hermetically Sealed Scroll
	Piston Displacement	cm ³ /rev	62.1 × 2	(87.6 × 1) + (62.1)
	Number of Revolution	rev/min	3,600 × 2	3,600 × 2
	Motor Output × Number	W × No.	5,300 × 2	(7,500 × 1) + (5,300 × 1)
	Starting Method		Inverter	Inverter
Oil Type		FW68D(PVE)	FW68D(PVE)	
Fan	Type		Propeller fan	Propeller fan
	Motor Output × Number	W	(900 × 2) + (1,200 × 1)	(900 × 2) + (1,200 × 1)
	Air Flow Rate(High)	m ³ /min	(320 × 1) + (240 × 1)	(320 × 1) + (240 × 1)
		ft ³ /min	(11,301 × 1) + (8,476 × 1)	(11,301 × 1) + (8,476 × 1)
	Drive		DC INVERTER	DC INVERTER
Discharge		Side / Top	TOP	
Pipe Connections	Liquid Pipe	mm(inch)	19.05(3/4)	19.05(3/4)
	Gas Pipe	mm(inch)	34.9(1-3/8)	34.9(1-3/8)
Dimensions(W × H × D)		mm	(1,240 × 1,690 × 760) × 1 + (930 × 1,690 × 760) × 1	(1,240 × 1,690 × 760) × 1 + (930 × 1,690 × 760) × 1
		inch	(48-13/16 × 66-17/32 × 29-29/32) × 1 + (36-5/8 × 66-17/32 × 29-29/32) × 1	(48-13/16 × 66-17/32 × 29-29/32) × 1 + (36-5/8 × 66-17/32 × 29-29/32) × 1
Weight	Net	kg	(205) + (172)	(230) + (172)
		lbs	(448) + (373)	(492) + (373)
	Shipping	kg	(222) + (184)	(247) + (184)
		lbs	(489) + (406)	(545) + (406)
Sound Pressure Level	Cooling	dB(A)	62.8	63.8
	Heating	dB(A)	63.8	65.8
Sound Power Level	Cooling	dB(A)	84.5	86.0
	Heating	dB(A)	86.2	87.0

Note

- Due to our policy of innovation some specifications may be changed without notification.
- Wiring cable size must comply with the applicable local and national codes. And "Electric characteristics" chapter should be considered for electrical work and design. Especially the power cable and circuit breaker should be selected in accordance with that.
- Power factor could vary less than ±1% according to the operating conditions.
- Sound pressure level is measured on the rated condition in the anechoic rooms by ISO 3745 standard.
Sound power level is measured on the rated condition in the reverberation rooms by ISO 9614 standard.
Therefore, these values can be increased owing to ambient conditions during operation.
- Sound values of combination model are calculated values based on sound results of independent models.
Sound values can be increased owing to ambient or installation conditions during operation.
Sound values of system [dB(A)] = 10*log [10^{A1}/10 + ... + 10^{An}/10], A1~An means sound values of independent models.
- Performances are based on the following conditions :
 - *Cooling : Indoor Ambient Temp. 27°CDB / 19°CWB, Outdoor Ambient Temp. 35°CDB / 24°CWB
 - *Heating : Indoor Ambient Temp. 20°CDB / 15°CWB, Outdoor Ambient Temp. 7°CDB / 6°CWB
 - Interconnected Pipe Length is 7.5m and difference of Elevation (Outdoor ~ Indoor Unit) is 0m.
- *** : The number in parentheses means maximum connectable indoor units in accordance with outdoor units combination (160~200%).
The recommended ratio is 130%.
- This product contains Fluorinated greenhouse gases.(R410A, GWP(Global warming potential) = 2,087.5)

1. Specifications

HP		28	30	
Model Name	Combination Unit	A(C)RUN280LLS5	A(C)RUN300LLS5	
	Independent Unit	A(C)RUN160LLS5	A(C)RUN180LLS5	
		A(C)RUN120LLS5	A(C)RUN120LLS5	
Protection Devices	High pressure protection	High pressure sensor / High pressure switch		
	Compressor/Fan	Over-heat protection / Fan driver overload protector		
	Inverter	Over-heat protection / Over-current protection		
Communication Cable	No. × mm ² (VCTF-SB)	2C × 1.0 ~ 1.5	2C × 1.0 ~ 1.5	
Refrigerant	Refrigerant name	R410A		
	Precharged Amount	kg	11.2	12.2
		lbs	24.7	26.9
	GWP	2087.5		
	TCO ₂ eq	23.4		
Control	Electronic Expansion Valve			
Power Supply	∅, V, Hz	380~415, 3, 50	380~415, 3, 50	
		380, 3, 60	380, 3, 60	
Number of maximum connectable indoor units***		45(56)	49(60)	

Note

- Due to our policy of innovation some specifications may be changed without notification.
- Wiring cable size must comply with the applicable local and national codes. And "Electric characteristics" chapter should be considered for electrical work and design. Especially the power cable and circuit breaker should be selected in accordance with that.
- Power factor could vary less than ±1% according to the operating conditions.
- Sound pressure level is measured on the rated condition in the anechoic rooms by ISO 3745 standard.
Sound power level is measured on the rated condition in the reverberation rooms by ISO 9614 standard.
Therefore, these values can be increased owing to ambient conditions during operation.
- Sound values of combination model are calculated values based on sound results of independent models.
Sound values can be increased owing to ambient or installation conditions during operation.
Sound values of system [dB(A)] = $10 \cdot \log [10^{A_1/10} + \dots + 10^{A_n/10}]$, A₁~A_n means sound values of independent models.
- Performances are based on the following conditions :
 - *Cooling : Indoor Ambient Temp. 27°CDB / 19°CWB, Outdoor Ambient Temp. 35°CDB / 24°CWB
 - *Heating : Indoor Ambient Temp. 20°CDB / 15°CWB, Outdoor Ambient Temp. 7°CDB / 6°CWB
 - Interconnected Pipe Length is 7.5m and difference of Elevation (Outdoor ~ Indoor Unit) is 0m.
- *** : The number in parentheses means maximum connectable indoor units in accordance with outdoor units combination (160~200%).
The recommended ratio is 130%.
- This product contains Fluorinated greenhouse gases.(R410A, GWP(Global warming potential) = 2,087.5)

1. Specifications

HP			32	34
Model Name	Combination Unit		A(C)RUN320LLS5	A(C)RUN340LLS5
	Independent Unit		A(C)RUN200LLS5	A(C)RUN220LLS5
			A(C)RUN120LLS5	A(C)RUN120LLS5
Capacity	Cooling(Rated)	kW	89.6	95.2
		kcal/h	77,100	81,900
		Btu/h	305,700	324,800
	Heating(Rated)	kW	89.6	95.2
		kcal/h	77,100	81,900
		Btu/h	305,700	324,800
Input (Rated)	Cooling	kW	23.0	25.7
	Heating	kW	23.6	26.9
EER (Rated)			3.90	3.70
COP (Rated)			3.80	3.54
Power Factor	Rated	-	0.93	0.93
Exterior	Casing Color		Morning Gray / Dawn Gray	Morning Gray / Dawn Gray
	RAL code		RAL 7038 / RAL 7037	RAL 7038 / RAL 7037
Heat Exchanger			Wide Louver Plus	Wide Louver Plus
Compressor	Type		Hermetically Sealed Scroll	Hermetically Sealed Scroll
	Piston Displacement	cm ³ /rev	(87.6 x 1) + (62.1)	(87.6 x 1) + (62.1)
	Number of Revolution	rev/min	3,600 × 2	3,600 × 2
	Motor Output × Number	W × No.	(7,500 x 1) + (5,300 x 1)	(7,500 x 1) + (5,300 x 1)
	Starting Method		Inverter	Inverter
Oil Type		FW68D(PVE)	FW68D(PVE)	
Fan	Type		Propeller fan	Propeller fan
	Motor Output × Number	W	(900 × 2) + (1,200 x 1)	(900 × 2) + (1,200 x 1)
	Air Flow Rate(High)	m ³ /min	(320 x 1) + (240 x 1)	(320 x 1) + (240 x 1)
		ft ³ /min	(11,301 x 1) + (8,476 x 1)	(11,301 x 1) + (8,476 x 1)
	Drive		DC INVERTER	DC INVERTER
Discharge		Side / Top	TOP	
Pipe Connections	Liquid Pipe	mm(inch)	19.05(3/4)	19.05(3/4)
	Gas Pipe	mm(inch)	34.9(1-3/8)	34.9(1-3/8)
Dimensions(W × H × D)		mm	(1,240 × 1,690 × 760) x 1 + (930 × 1,690 × 760) x 1	(1,240 × 1,690 × 760) x 1 + (930 × 1,690 × 760) x 1
		inch	(48-13/16 × 66-17/32 × 29-29/32) x 1 + (36-5/8 × 66-17/32 × 29-29/32) x 1	(48-13/16 × 66-17/32 × 29-29/32) x 1 + (36-5/8 × 66-17/32 × 29-29/32) x 1
Weight	Net	kg	(230) + (172)	(230) + (172)
		lbs	(492) + (373)	(492) + (373)
	Shipping	kg	(247) + (184)	(247) + (184)
		lbs	(545) + (406)	(545) + (406)
Sound Pressure Level	Cooling	dB(A)	64.5	65.2
	Heating	dB(A)	67.0	67.8
Sound Power Level	Cooling	dB(A)	86.8	87.6
	Heating	dB(A)	89.5	90.4

Note

- Due to our policy of innovation some specifications may be changed without notification.
- Wiring cable size must comply with the applicable local and national codes. And "Electric characteristics" chapter should be considered for electrical work and design. Especially the power cable and circuit breaker should be selected in accordance with that.
- Power factor could vary less than ±1% according to the operating conditions.
- Sound pressure level is measured on the rated condition in the anechoic rooms by ISO 3745 standard.
Sound power level is measured on the rated condition in the reverberation rooms by ISO 9614 standard.
Therefore, these values can be increased owing to ambient conditions during operation.
- Sound values of combination model are calculated values based on sound results of independent models.
Sound values can be increased owing to ambient or installation conditions during operation.
Sound values of system [dB(A)] = 10*log [10^{A1}/10 + ... + 10^{An}/10], A1~An means sound values of independent models.
- Performances are based on the following conditions :
 - *Cooling : Indoor Ambient Temp. 27°CDB / 19°CWB, Outdoor Ambient Temp. 35°CDB / 24°CWB
 - *Heating : Indoor Ambient Temp. 20°CDB / 15°CWB, Outdoor Ambient Temp. 7°CDB / 6°CWB
 - Interconnected Pipe Length is 7.5m and difference of Elevation (Outdoor ~ Indoor Unit) is 0m.
- *** : The number in parentheses means maximum connectable indoor units in accordance with outdoor units combination (160~200%).
The recommended ratio is 130%.
- This product contains Fluorinated greenhouse gases.(R410A, GWP(Global warming potential) = 2,087.5)

1. Specifications

HP		32		34		
Model Name	Combination Unit		A(C)RUN320LLS5		A(C)RUN340LLS5	
	Independent Unit	A(C)RUN200LLS5		A(C)RUN220LLS5		
		A(C)RUN120LLS5		A(C)RUN120LLS5		
Protection Devices	High pressure protection		High pressure sensor / High pressure switch			
	Compressor/Fan		Over-heat protection / Fan driver overload protector			
	Inverter		Over-heat protection / Over-current protection			
Communication Cable		No. × mm ² (VCTF-SB)	2C × 1.0 ~ 1.5		2C × 1.0 ~ 1.5	
Refrigerant	Refrigerant name		R410A		R410A	
	Precharged Amount	kg	12.2		12.2	
		lbs	26.9		26.9	
	GWP		2087.5		2087.5	
	TCO ₂ eq		25.5		25.5	
Control		Electronic Expansion Valve		Electronic Expansion Valve		
Power Supply		∅, V, Hz	380~415, 3, 50		380~415, 3, 50	
			380, 3, 60		380, 3, 60	
Number of maximum connectable indoor units***			52(64)		55(64)	
Note						
1. Due to our policy of innovation some specifications may be changed without notification.						
2. Wiring cable size must comply with the applicable local and national codes. And "Electric characteristics" chapter should be considered for electrical work and design. Especially the power cable and circuit breaker should be selected in accordance with that.						
3. Power factor could vary less than ±1% according to the operating conditions.						
4. Sound pressure level is measured on the rated condition in the anechoic rooms by ISO 3745 standard. Sound power level is measured on the rated condition in the reverberation rooms by ISO 9614 standard. Therefore, these values can be increased owing to ambient conditions during operation.						
5. Sound values of combination model are calculated values based on sound results of independent models. Sound values can be increased owing to ambient or installation conditions during operation. Sound values of system [dB(A)] = 10*log [10 ^{A1} (A1/10)+ ... +10 ^{An} (An/10)] , A1~An means sound values of independent models.						
6. Performances are based on the following conditions : • *Cooling : Indoor Ambient Temp. 27°CDB / 19°CWB, Outdoor Ambient Temp. 35°CDB / 24°CWB • *Heating : Indoor Ambient Temp. 20°CDB / 15°CWB, Outdoor Ambient Temp. 7°CDB / 6°CWB • Interconnected Pipe Length is 7.5m and difference of Elevation (Outdoor ~ Indoor Unit) is 0m.						
7. *** : The number in parentheses means maximum connectable indoor units in accordance with outdoor units combination (160~200%). The recommended ratio is 130%.						
8. This product contains Fluorinated greenhouse gases.(R410A, GWP(Global warming potential) = 2,087.5)						

1. Specifications

HP			36	38
Model Name	Combination Unit		A(C)RUN360LLS5	A(C)RUN380LLS5
	Independent Unit		A(C)RUN240LLS5	A(C)RUN260LLS5
			A(C)RUN120LLS5	A(C)RUN120LLS5
Capacity	Cooling(Rated)	kW	100.8	106.4
		kcal/h	86,700	91,500
		Btu/h	343,900	363,000
	Heating(Rated)	kW	100.8	106.4
		kcal/h	86,700	91,500
		Btu/h	343,900	363,000
Input (Rated)	Cooling	kW	27.1	29.7
	Heating	kW	27.0	29.6
EER (Rated)			3.72	3.58
COP (Rated)			3.73	3.59
Power Factor	Rated	-	0.93	0.93
Exterior	Casing Color		Morning Gray / Dawn Gray	Morning Gray / Dawn Gray
	RAL code		RAL 7038 / RAL 7037	RAL 7038 / RAL 7037
Heat Exchanger			Wide Louver Plus	Wide Louver Plus
Compressor	Type		Hermetically Sealed Scroll	Hermetically Sealed Scroll
	Piston Displacement	cm ³ /rev	62.1 × 3	62.1 × 3
	Number of Revolution	rev/min	3,600 × 3	3,600 × 3
	Motor Output × Number	W × No.	5,300 × 3	5,300 × 3
	Starting Method		Inverter	Inverter
	Oil Type		FW68D(PVE)	FW68D(PVE)
Fan	Type		Propeller fan	Propeller fan
	Motor Output × Number	W	(900 × 2) + (1,200 × 1)	(900 × 2) + (1,200 × 1)
	Air Flow Rate(High)	m ³ /min	(320 × 1) + (240 × 1)	(320 × 1) + (240 × 1)
		ft ³ /min	(11,301 × 1) + (8,476 × 1)	(11,301 × 1) + (8,476 × 1)
	Drive		DC INVERTER	DC INVERTER
Discharge		Side / Top	TOP	
Pipe Connections	Liquid Pipe	mm(inch)	19.05(3/4)	19.05(3/4)
	Gas Pipe	mm(inch)	41.3(1-5/8)	41.3(1-5/8)
Dimensions(W × H × D)		mm	(1,240 × 1,690 × 760) × 1 + (930 × 1,690 × 760) × 1	(1,240 × 1,690 × 760) × 1 + (930 × 1,690 × 760) × 1
		inch	(48-13/16 × 66-17/32 × 29-29/32) × 1 + (36-5/8 × 66-17/32 × 29-29/32) × 1	(48-13/16 × 66-17/32 × 29-29/32) × 1 + (36-5/8 × 66-17/32 × 29-29/32) × 1
Weight	Net	kg	(268) + (172)	(268) + (172)
		lbs	(580) + (373)	(580) + (373)
	Shipping	kg	(285) + (184)	(285) + (184)
		lbs	(628) + (406)	(628) + (406)
Sound Pressure Level	Cooling	dB(A)	66.0	66.0
	Heating	dB(A)	67.8	67.8
Sound Power Level	Cooling	dB(A)	88.5	88.5
	Heating	dB(A)	90.4	90.4

Note

- Due to our policy of innovation some specifications may be changed without notification.
- Wiring cable size must comply with the applicable local and national codes. And "Electric characteristics" chapter should be considered for electrical work and design. Especially the power cable and circuit breaker should be selected in accordance with that.
- Power factor could vary less than ±1% according to the operating conditions.
- Sound pressure level is measured on the rated condition in the anechoic rooms by ISO 3745 standard.
Sound power level is measured on the rated condition in the reverberation rooms by ISO 9614 standard.
Therefore, these values can be increased owing to ambient conditions during operation.
- Sound values of combination model are calculated values based on sound results of independent models.
Sound values can be increased owing to ambient or installation conditions during operation.
Sound values of system [dB(A)] = 10*log [10^{A1}/10 + ... + 10^{An}/10], A1~An means sound values of independent models.
- Performances are based on the following conditions :
 - *Cooling : Indoor Ambient Temp. 27°CDB / 19°CWB, Outdoor Ambient Temp. 35°CDB / 24°CWB
 - *Heating : Indoor Ambient Temp. 20°CDB / 15°CWB, Outdoor Ambient Temp. 7°CDB / 6°CWB
 - Interconnected Pipe Length is 7.5m and difference of Elevation (Outdoor ~ Indoor Unit) is 0m.
- *** : The number in parentheses means maximum connectable indoor units in accordance with outdoor units combination (160~200%).
The recommended ratio is 130%.
- This product contains Fluorinated greenhouse gases.(R410A, GWP(Global warming potential) = 2,087.5)

1. Specifications

HP		36	38
Model Name	Combination Unit	A(C)RUN360LLS5	A(C)RUN380LLS5
	Independent Unit	A(C)RUN240LLS5	A(C)RUN260LLS5
		A(C)RUN120LLS5	A(C)RUN120LLS5
Protection Devices	High pressure protection	High pressure sensor / High pressure switch	
	Compressor/Fan	Over-heat protection / Fan driver overload protector	
	Inverter	Over-heat protection / Over-current protection	
Communication Cable		No. × mm ² (VCTF-SB)	2C × 1.0 ~ 1.5
Refrigerant	Refrigerant name		R410A
	Precharged Amount	kg	15.7
		lbs	34.6
	GWP		2087.5
	TCO ₂ eq		32.8
Control		Electronic Expansion Valve	Electronic Expansion Valve
Power Supply		∅, V, Hz	380~415, 3, 50
			380, 3, 60
Number of maximum connectable indoor units***			58(64)
			61(64)
Note			
1. Due to our policy of innovation some specifications may be changed without notification.			
2. Wiring cable size must comply with the applicable local and national codes. And "Electric characteristics" chapter should be considered for electrical work and design. Especially the power cable and circuit breaker should be selected in accordance with that.			
3. Power factor could vary less than ±1% according to the operating conditions.			
4. Sound pressure level is measured on the rated condition in the anechoic rooms by ISO 3745 standard. Sound power level is measured on the rated condition in the reverberation rooms by ISO 9614 standard. Therefore, these values can be increased owing to ambient conditions during operation.			
5. Sound values of combination model are calculated values based on sound results of independent models. Sound values can be increased owing to ambient or installation conditions during operation. Sound values of system [dB(A)] = 10*log [10 ^{A1/10} + ... +10 ^{An/10}], A1~An means sound values of independent models.			
6. Performances are based on the following conditions : • *Cooling : Indoor Ambient Temp. 27°CDB / 19°CWB, Outdoor Ambient Temp. 35°CDB / 24°CWB • *Heating : Indoor Ambient Temp. 20°CDB / 15°CWB, Outdoor Ambient Temp. 7°CDB / 6°CWB • Interconnected Pipe Length is 7.5m and difference of Elevation (Outdoor ~ Indoor Unit) is 0m.			
7. *** : The number in parentheses means maximum connectable indoor units in accordance with outdoor units combination (160~200%). The recommended ratio is 130%.			
8. This product contains Fluorinated greenhouse gases.(R410A, GWP(Global warming potential) = 2,087.5)			

1. Specifications

HP			40	42
Model Name	Combination Unit		A(C)RUN400LLS5	A(C)RUN420LLS5
	Independent Unit		A(C)RUN260LLS5	A(C)RUN260LLS5
			A(C)RUN140LLS5	A(C)RUN160LLS5
Capacity	Cooling(Rated)	kW	112.0	117.6
		kcal/h	96,300	101,100
		Btu/h	382,200	401,300
	Heating(Rated)	kW	112.0	117.6
		kcal/h	96,300	101,100
		Btu/h	382,200	401,300
Input (Rated)	Cooling	kW	31.4	32.7
	Heating	kW	32.1	32.6
EER (Rated)			3.57	3.60
COP (Rated)			3.49	3.61
Power Factor	Rated	-	0.93	0.93
Exterior	Casing Color		Morning Gray / Dawn Gray	Morning Gray / Dawn Gray
	RAL code		RAL 7038 / RAL 7037	RAL 7038 / RAL 7037
Heat Exchanger			Wide Louver Plus	Wide Louver Plus
Compressor	Type		Hermetically Sealed Scroll	Hermetically Sealed Scroll
	Piston Displacement	cm ³ /rev	62.1 × 3	62.1 × 3
	Number of Revolution	rev/min	3,600 × 3	3,600 × 3
	Motor Output × Number	W × No.	5,300 × 3	5,300 × 3
	Starting Method		Inverter	Inverter
Oil Type			FW68D(PVE)	FW68D(PVE)
Fan	Type		Propeller fan	Propeller fan
	Motor Output × Number	W	(900 × 2) + (1,200 × 1)	900 × 4
	Air Flow Rate(High)	m ³ /min	(320 × 1) + (240 × 1)	320 × 2
		ft ³ /min	(11,301 × 1) + (8,476 × 1)	11,301 × 2
	Drive		DC INVERTER	DC INVERTER
Discharge		Side / Top	TOP	
Pipe Connections	Liquid Pipe	mm(inch)	19.05(3/4)	19.05(3/4)
	Gas Pipe	mm(inch)	41.3(1-5/8)	41.3(1-5/8)
Dimensions(W × H × D)		mm	(1,240 × 1,690 × 760) × 1 + (930 × 1,690 × 760) × 1	(1,240 × 1,690 × 760) × 2
		inch	(48-13/16 × 66-17/32 × 29-29/32) × 1 + (36-5/8 × 66-17/32 × 29-29/32) × 1	(48-13/16 × 66-17/32 × 29-29/32) × 2
Weight	Net	kg	(268) + (184)	(268) + (205)
		lbs	(580) + (401)	(580) + (448)
	Shipping	kg	(285) + (196)	(285) + (222)
		lbs	(628) + (432)	(628) + (489)
Sound Pressure Level	Cooling	dB(A)	66.2	66.3
	Heating	dB(A)	68.0	68.1
Sound Power Level	Cooling	dB(A)	89.0	89.2
	Heating	dB(A)	90.8	91.2

Note

- Due to our policy of innovation some specifications may be changed without notification.
- Wiring cable size must comply with the applicable local and national codes. And "Electric characteristics" chapter should be considered for electrical work and design. Especially the power cable and circuit breaker should be selected in accordance with that.
- Power factor could vary less than ±1% according to the operating conditions.
- Sound pressure level is measured on the rated condition in the anechoic rooms by ISO 3745 standard.
Sound power level is measured on the rated condition in the reverberation rooms by ISO 9614 standard.
Therefore, these values can be increased owing to ambient conditions during operation.
- Sound values of combination model are calculated values based on sound results of independent models.
Sound values can be increased owing to ambient or installation conditions during operation.
Sound values of system [dB(A)] = 10*log [10^{A1}/10 + ... + 10^{An}/10], A1~An means sound values of independent models.
- Performances are based on the following conditions :
 - *Cooling : Indoor Ambient Temp. 27°CDB / 19°CWB, Outdoor Ambient Temp. 35°CDB / 24°CWB
 - *Heating : Indoor Ambient Temp. 20°CDB / 15°CWB, Outdoor Ambient Temp. 7°CDB / 6°CWB
 - Interconnected Pipe Length is 7.5m and difference of Elevation (Outdoor ~ Indoor Unit) is 0m.
- *** : The number in parentheses means maximum connectable indoor units in accordance with outdoor units combination (160~200%).
The recommended ratio is 130%.
- This product contains Fluorinated greenhouse gases.(R410A, GWP(Global warming potential) = 2,087.5)

1. Specifications

HP		40	42	
Model Name	Combination Unit	A(C)RUN400LLS5	A(C)RUN420LLS5	
	Independent Unit	A(C)RUN260LLS5	A(C)RUN260LLS5	
		A(C)RUN140LLS5	A(C)RUN160LLS5	
Protection Devices	High pressure protection	High pressure sensor / High pressure switch		
	Compressor/Fan	Over-heat protection / Fan driver overload protector		
	Inverter	Over-heat protection / Over-current protection		
Communication Cable	No. × mm ² (VCTF-SB)	2C × 1.0 ~ 1.5	2C × 1.0 ~ 1.5	
Refrigerant	Refrigerant name	R410A		
	Precharged Amount	kg	18.5	17.5
		lbs	40.8	38.6
	GWP	2087.5		
	TCO ₂ eq	38.6		
Control	Electronic Expansion Valve			
Power Supply	∅, V, Hz	380~415, 3, 50	380~415, 3, 50	
		380, 3, 60	380, 3, 60	
Number of maximum connectable indoor units***		64	64	

Note

- Due to our policy of innovation some specifications may be changed without notification.
- Wiring cable size must comply with the applicable local and national codes. And "Electric characteristics" chapter should be considered for electrical work and design. Especially the power cable and circuit breaker should be selected in accordance with that.
- Power factor could vary less than ±1% according to the operating conditions.
- Sound pressure level is measured on the rated condition in the anechoic rooms by ISO 3745 standard.
Sound power level is measured on the rated condition in the reverberation rooms by ISO 9614 standard.
Therefore, these values can be increased owing to ambient conditions during operation.
- Sound values of combination model are calculated values based on sound results of independent models.
Sound values can be increased owing to ambient or installation conditions during operation.
Sound values of system [dB(A)] = $10 \cdot \log [10^{A1/10} + \dots + 10^{An/10}]$, A1~An means sound values of independent models.
- Performances are based on the following conditions :
 - *Cooling : Indoor Ambient Temp. 27°CDB / 19°CWB, Outdoor Ambient Temp. 35°CDB / 24°CWB
 - *Heating : Indoor Ambient Temp. 20°CDB / 15°CWB, Outdoor Ambient Temp. 7°CDB / 6°CWB
 - Interconnected Pipe Length is 7.5m and difference of Elevation (Outdoor ~ Indoor Unit) is 0m.
- *** : The number in parentheses means maximum connectable indoor units in accordance with outdoor units combination (160~200%).
The recommended ratio is 130%.
- This product contains Fluorinated greenhouse gases.(R410A, GWP(Global warming potential) = 2,087.5)

1. Specifications

HP			44	46
Model Name	Combination Unit		A(C)RUN440LLS5	A(C)RUN460LLS5
	Independent Unit		A(C)RUN260LLS5	A(C)RUN260LLS5
			A(C)RUN180LLS5	A(C)RUN200LLS5
Capacity	Cooling(Rated)	kW	123.2	128.8
		kcal/h	105,900	110,800
		Btu/h	420,400	439,500
	Heating(Rated)	kW	123.2	128.8
		kcal/h	105,900	110,800
		Btu/h	420,400	439,500
Input (Rated)	Cooling	kW	33.1	34.9
	Heating	kW	32.6	35.0
EER (Rated)			3.72	3.69
COP (Rated)			3.78	3.68
Power Factor	Rated	-	0.93	0.93
Exterior	Casing Color		Morning Gray / Dawn Gray	Morning Gray / Dawn Gray
	RAL code		RAL 7038 / RAL 7037	RAL 7038 / RAL 7037
Heat Exchanger			Wide Louver Plus	Wide Louver Plus
Compressor	Type		Hermetically Sealed Scroll	Hermetically Sealed Scroll
	Piston Displacement	cm ³ /rev	(62.1 x 2) + (87.6)	(62.1 x 2) + (87.6)
	Number of Revolution	rev/min	3,600 x 3	3,600 x 3
	Motor Output x Number	W x No.	(5,300 x 2) + (7,500 x 1)	(5,300 x 2) + (7,500 x 1)
	Starting Method		Inverter	Inverter
Oil Type		FW68D(PVE)	FW68D(PVE)	
Fan	Type		Propeller fan	Propeller fan
	Motor Output x Number	W	900 x 4	900 x 4
	Air Flow Rate(High)	m ³ /min	320 x 2	320 x 2
		ft ³ /min	11,301 x 2	11,301 x 2
	Drive		DC INVERTER	DC INVERTER
Discharge		Side / Top	TOP	
Pipe Connections	Liquid Pipe	mm(inch)	19.05(3/4)	19.05(3/4)
	Gas Pipe	mm(inch)	41.3(1-5/8)	41.3(1-5/8)
Dimensions(W x H x D)		mm	(1,240 x 1,690 x 760) x 2	(1,240 x 1,690 x 760) x 2
		inch	(48-13/16 x 66-17/32 x 29-29/32) x 2	(48-13/16 x 66-17/32 x 29-29/32) x 2
Weight	Net	kg	(268) + (230)	(268) + (230)
		lbs	(580) + (492)	(580) + (492)
	Shipping	kg	(285) + (247)	(285) + (247)
		lbs	(628) + (545)	(628) + (545)
Sound Pressure Level	Cooling	dB(A)	66.8	67.1
	Heating	dB(A)	68.9	69.5
Sound Power Level	Cooling	dB(A)	89.8	90.1
	Heating	dB(A)	91.5	92.5

Note

- Due to our policy of innovation some specifications may be changed without notification.
- Wiring cable size must comply with the applicable local and national codes. And "Electric characteristics" chapter should be considered for electrical work and design. Especially the power cable and circuit breaker should be selected in accordance with that.
- Power factor could vary less than $\pm 1\%$ according to the operating conditions.
- Sound pressure level is measured on the rated condition in the anechoic rooms by ISO 3745 standard.
Sound power level is measured on the rated condition in the reverberation rooms by ISO 9614 standard.
Therefore, these values can be increased owing to ambient conditions during operation.
- Sound values of combination model are calculated values based on sound results of independent models.
Sound values can be increased owing to ambient or installation conditions during operation.
Sound values of system $[dB(A)] = 10 \cdot \log [10^{A_1/10} + \dots + 10^{A_n/10}]$, A₁~A_n means sound values of independent models.
- Performances are based on the following conditions :
 - *Cooling : Indoor Ambient Temp. 27°CDB / 19°CWB, Outdoor Ambient Temp. 35°CDB / 24°CWB
 - *Heating : Indoor Ambient Temp. 20°CDB / 15°CWB, Outdoor Ambient Temp. 7°CDB / 6°CWB
 - Interconnected Pipe Length is 7.5m and difference of Elevation (Outdoor ~ Indoor Unit) is 0m.
- *** : The number in parentheses means maximum connectable indoor units in accordance with outdoor units combination (160~200%).
The recommended ratio is 130%.
- This product contains Fluorinated greenhouse gases.(R410A, GWP(Global warming potential) = 2,087.5)

1. Specifications

HP		44	46
Model Name	Combination Unit	A(C)RUN440LLS5	A(C)RUN460LLS5
	Independent Unit	A(C)RUN260LLS5	A(C)RUN260LLS5
		A(C)RUN180LLS5	A(C)RUN200LLS5
Protection Devices	High pressure protection	High pressure sensor / High pressure switch	
	Compressor/Fan	Over-heat protection / Fan driver overload protector	
	Inverter	Over-heat protection / Over-current protection	
Communication Cable	No. × mm ² (VCTF-SB)	2C × 1.0 ~ 1.5	2C × 1.0 ~ 1.5
Refrigerant	Refrigerant name	R410A	
	Precharged Amount	kg	18.5
		lbs	40.8
	GWP	2087.5	
	TCO ₂ eq	38.6	
Control	Electronic Expansion Valve		
Power Supply	∅, V, Hz	380~415, 3, 50	380~415, 3, 50
		380, 3, 60	380, 3, 60
Number of maximum connectable indoor units***		64	64
Note			
<p>1. Due to our policy of innovation some specifications may be changed without notification.</p> <p>2. Wiring cable size must comply with the applicable local and national codes. And "Electric characteristics" chapter should be considered for electrical work and design. Especially the power cable and circuit breaker should be selected in accordance with that.</p> <p>3. Power factor could vary less than ±1% according to the operating conditions.</p> <p>4. Sound pressure level is measured on the rated condition in the anechoic rooms by ISO 3745 standard. Sound power level is measured on the rated condition in the reverberation rooms by ISO 9614 standard. Therefore, these values can be increased owing to ambient conditions during operation.</p> <p>5. Sound values of combination model are calculated values based on sound results of independent models. Sound values can be increased owing to ambient or installation conditions during operation. Sound values of system [dB(A)] = 10*log [10^{A1/10}+ ... +10^{An/10}], A1~An means sound values of independent models.</p> <p>6. Performances are based on the following conditions : <ul style="list-style-type: none"> • *Cooling : Indoor Ambient Temp. 27°CDB / 19°CWB, Outdoor Ambient Temp. 35°CDB / 24°CWB • *Heating : Indoor Ambient Temp. 20°CDB / 15°CWB, Outdoor Ambient Temp. 7°CDB / 6°CWB • Interconnected Pipe Length is 7.5m and difference of Elevation (Outdoor ~ Indoor Unit) is 0m. </p> <p>7. *** : The number in parentheses means maximum connectable indoor units in accordance with outdoor units combination (160~200%). The recommended ratio is 130%.</p> <p>8. This product contains Fluorinated greenhouse gases.(R410A, GWP(Global warming potential) = 2,087.5)</p>			

1. Specifications

HP			48	50
Model Name	Combination Unit		A(C)RUN480LLS5	A(C)RUN500LLS5
	Independent Unit		A(C)RUN260LLS5	A(C)RUN260LLS5
			A(C)RUN220LLS5	A(C)RUN240LLS5
Capacity	Cooling(Rated)	kW	134.4	140.0
		kcal/h	115,600	120,400
		Btu/h	458,600	477,700
	Heating(Rated)	kW	134.4	140.0
		kcal/h	115,600	120,400
		Btu/h	458,600	477,700
Input (Rated)	Cooling	kW	37.6	39.0
	Heating	kW	38.3	38.4
EER (Rated)			3.57	3.59
COP (Rated)			3.51	3.65
Power Factor	Rated	-	0.93	0.93
Exterior	Casing Color		Morning Gray / Dawn Gray	Morning Gray / Dawn Gray
	RAL code		RAL 7038 / RAL 7037	RAL 7038 / RAL 7037
Heat Exchanger			Wide Louver Plus	Wide Louver Plus
Compressor	Type		Hermetically Sealed Scroll	Hermetically Sealed Scroll
	Piston Displacement	cm ³ /rev	(62.1 × 2) + (87.6)	62.1 × 4
	Number of Revolution	rev/min	3,600 × 3	3,600 × 4
	Motor Output × Number	W × No.	(5,300 × 2) + (7,500 × 1)	5,300 × 4
	Starting Method		Inverter	Inverter
Oil Type		FW68D(PVE)	FW68D(PVE)	
Fan	Type		Propeller fan	Propeller fan
	Motor Output × Number	W	900 × 4	900 × 4
	Air Flow Rate(High)	m ³ /min	320 × 2	320 × 2
		ft ³ /min	11,301 × 2	11,301 × 2
	Drive		DC INVERTER	DC INVERTER
Discharge		Side / Top	TOP	
Pipe Connections	Liquid Pipe	mm(inch)	19.05(3/4)	19.05(3/4)
	Gas Pipe	mm(inch)	41.3(1-5/8)	41.3(1-5/8)
Dimensions(W × H × D)		mm	(1,240 × 1,690 × 760) × 2	(1,240 × 1,690 × 760) × 2
		inch	(48-13/16 × 66-17/32 × 29-29/32) × 2	(48-13/16 × 66-17/32 × 29-29/32) × 2
Weight	Net	kg	(268) + (230)	(268) + (268)
		lbs	(580) + (492)	(580) + (580)
	Shipping	kg	(285) + (247)	(285) + (285)
		lbs	(628) + (545)	(628) + (628)
Sound Pressure Level	Cooling	dB(A)	67.5	68.0
	Heating	dB(A)	70.0	70.0
Sound Power Level	Cooling	dB(A)	90.5	91.0
	Heating	dB(A)	93.0	93.0

Note

- Due to our policy of innovation some specifications may be changed without notification.
- Wiring cable size must comply with the applicable local and national codes. And "Electric characteristics" chapter should be considered for electrical work and design. Especially the power cable and circuit breaker should be selected in accordance with that.
- Power factor could vary less than ±1% according to the operating conditions.
- Sound pressure level is measured on the rated condition in the anechoic rooms by ISO 3745 standard.
Sound power level is measured on the rated condition in the reverberation rooms by ISO 9614 standard.
Therefore, these values can be increased owing to ambient conditions during operation.
- Sound values of combination model are calculated values based on sound results of independent models.
Sound values can be increased owing to ambient or installation conditions during operation.
Sound values of system [dB(A)] = 10^{log} [10^{A1}(A1/10)+ ... +10^{An}(An/10)] , A1~An means sound values of independent models.
- Performances are based on the following conditions :
 - *Cooling : Indoor Ambient Temp. 27°CDB / 19°CWB, Outdoor Ambient Temp. 35°CDB / 24°CWB
 - *Heating : Indoor Ambient Temp. 20°CDB / 15°CWB, Outdoor Ambient Temp. 7°CDB / 6°CWB
 - Interconnected Pipe Length is 7.5m and difference of Elevation (Outdoor ~ Indoor Unit) is 0m.
- *** : The number in parentheses means maximum connectable indoor units in accordance with outdoor units combination (160~200%).
The recommended ratio is 130%.
- This product contains Fluorinated greenhouse gases.(R410A, GWP(Global warming potential) = 2,087.5)

1. Specifications

HP		48	50	
Model Name	Combination Unit	A(C)RUN480LLS5	A(C)RUN500LLS5	
	Independent Unit	A(C)RUN260LLS5	A(C)RUN260LLS5	
		A(C)RUN220LLS5	A(C)RUN240LLS5	
Protection Devices	High pressure protection	High pressure sensor / High pressure switch		
	Compressor/Fan	Over-heat protection / Fan driver overload protector		
	Inverter	Over-heat protection / Over-current protection		
Communication Cable	No. × mm ² (VCTF-SB)	2C × 1.0 ~ 1.5	2C × 1.0 ~ 1.5	
Refrigerant	Refrigerant name	R410A		
	Precharged Amount	kg	18.5	22.0
		lbs	40.8	48.5
	GWP	2087.5		
	TCO ₂ eq	38.6		
Control	Electronic Expansion Valve			
Power Supply	∅, V, Hz	380~415, 3, 50	380~415, 3, 50	
		380, 3, 60	380, 3, 60	
Number of maximum connectable indoor units***		64	64	

Note

- Due to our policy of innovation some specifications may be changed without notification.
- Wiring cable size must comply with the applicable local and national codes. And "Electric characteristics" chapter should be considered for electrical work and design. Especially the power cable and circuit breaker should be selected in accordance with that.
- Power factor could vary less than ±1% according to the operating conditions.
- Sound pressure level is measured on the rated condition in the anechoic rooms by ISO 3745 standard.
Sound power level is measured on the rated condition in the reverberation rooms by ISO 9614 standard.
Therefore, these values can be increased owing to ambient conditions during operation.
- Sound values of combination model are calculated values based on sound results of independent models.
Sound values can be increased owing to ambient or installation conditions during operation.
Sound values of system [dB(A)] = $10 \cdot \log [10^{A1/10} + \dots + 10^{An/10}]$, A1~An means sound values of independent models.
- Performances are based on the following conditions :
 - *Cooling : Indoor Ambient Temp. 27°CDB / 19°CWB, Outdoor Ambient Temp. 35°CDB / 24°CWB
 - *Heating : Indoor Ambient Temp. 20°CDB / 15°CWB, Outdoor Ambient Temp. 7°CDB / 6°CWB
 - Interconnected Pipe Length is 7.5m and difference of Elevation (Outdoor ~ Indoor Unit) is 0m.
- *** : The number in parentheses means maximum connectable indoor units in accordance with outdoor units combination (160~200%).
The recommended ratio is 130%.
- This product contains Fluorinated greenhouse gases.(R410A, GWP(Global warming potential) = 2,087.5)

1. Specifications

HP			52	54
Model Name	Combination Unit		A(C)RUN520LLS5	A(C)RUN540LLS5
	Independent Unit		A(C)RUN260LLS5	A(C)RUN260LLS5
			A(C)RUN260LLS5	A(C)RUN160LLS5
				A(C)RUN120LLS5
Capacity	Cooling(Rated)	kW	145.6	151.2
		kcal/h	125,200	130,000
		Btu/h	496,800	515,900
	Heating(Rated)	kW	145.6	151.2
		kcal/h	125,200	130,000
		Btu/h	496,800	515,900
Input (Rated)	Cooling	kW	41.6	41.6
	Heating	kW	41.0	41.7
EER (Rated)			3.50	3.63
COP (Rated)			3.55	3.63
Power Factor	Rated	-	0.93	0.93
Exterior	Casing Color		Morning Gray / Dawn Gray	Morning Gray / Dawn Gray
	RAL code		RAL 7038 / RAL 7037	RAL 7038 / RAL 7037
Heat Exchanger			Wide Louver Plus	Wide Louver Plus
Compressor	Type		Hermetically Sealed Scroll	Hermetically Sealed Scroll
	Piston Displacement	cm ³ /rev	62.1 × 4	62.1 × 4
	Number of Revolution	rev/min	3,600 × 4	3,600 × 4
	Motor Output × Number	W × No.	5,300 × 4	5,300 × 4
	Starting Method		Inverter	Inverter
Oil Type			FW68D(PVE)	FW68D(PVE)
Fan	Type		Propeller fan	Propeller fan
	Motor Output × Number	W	900 × 4	(900 × 4) + (1,200 × 1)
	Air Flow Rate(High)	m ³ /min	320 × 2	(320 × 2) + (240 × 1)
		ft ³ /min	11,301 × 2	(11,301 × 2) + (8,476 × 1)
	Drive		DC INVERTER	DC INVERTER
Discharge		Side / Top	TOP	TOP
Pipe Connections	Liquid Pipe	mm(inch)	19.05(3/4)	19.05(3/4)
	Gas Pipe	mm(inch)	41.3(1-5/8)	41.3(1-5/8)
Dimensions(W × H × D)		mm	(1,240 × 1,690 × 760) × 2	(1,240 × 1,690 × 760) × 2 + (930 × 1,690 × 760) × 1
		inch	(48-13/16 × 66-17/32 × 29-29/32) × 2	(48-13/16 × 66-17/32 × 29-29/32) × 2 + (36-5/8 × 66-17/32 × 29-29/32) × 1
Weight	Net	kg	(268) + (268)	(268) + (205) + (172)
		lbs	(580) + (580)	(580) + (448) + (373)
	Shipping	kg	(285) + (285)	(285) + (222) + (184)
		lbs	(628) + (628)	(628) + (489) + (406)
Sound Pressure Level	Cooling	dB(A)	68.0	67.1
	Heating	dB(A)	70.0	68.7
Sound Power Level	Cooling	dB(A)	91.0	89.6
	Heating	dB(A)	93.0	91.5

Note

- Due to our policy of innovation some specifications may be changed without notification.
- Wiring cable size must comply with the applicable local and national codes. And "Electric characteristics" chapter should be considered for electrical work and design. Especially the power cable and circuit breaker should be selected in accordance with that.
- Power factor could vary less than ±1% according to the operating conditions.
- Sound pressure level is measured on the rated condition in the anechoic rooms by ISO 3745 standard.
Sound power level is measured on the rated condition in the reverberation rooms by ISO 9614 standard.
Therefore, these values can be increased owing to ambient conditions during operation.
- Sound values of combination model are calculated values based on sound results of independent models.
Sound values can be increased owing to ambient or installation conditions during operation.
Sound values of system [dB(A)] = 10*log [10^{A1}/10 + ... + 10^{An}/10], A1~An means sound values of independent models.
- Performances are based on the following conditions :
 - *Cooling : Indoor Ambient Temp. 27°CDB / 19°CWB, Outdoor Ambient Temp. 35°CDB / 24°CWB
 - *Heating : Indoor Ambient Temp. 20°CDB / 15°CWB, Outdoor Ambient Temp. 7°CDB / 6°CWB
 - Interconnected Pipe Length is 7.5m and difference of Elevation (Outdoor ~ Indoor Unit) is 0m.
- *** : The number in parentheses means maximum connectable indoor units in accordance with outdoor units combination (160~200%).
The recommended ratio is 130%.
- This product contains Fluorinated greenhouse gases.(R410A, GWP(Global warming potential) = 2,087.5)

1. Specifications

HP		52	54
Model Name	Combination Unit	A(C)RUN520LLS5	A(C)RUN540LLS5
	Independent Unit	A(C)RUN260LLS5	A(C)RUN260LLS5
		A(C)RUN260LLS5	A(C)RUN160LLS5
			A(C)RUN120LLS5
Protection Devices	High pressure protection	High pressure sensor / High pressure switch	
	Compressor/Fan	Over-heat protection / Fan driver overload protector	
	Inverter	Over-heat protection / Over-current protection	
Communication Cable		No. × mm ² (VCTF-SB)	2C × 1.0 ~ 1.5
Refrigerant	Refrigerant name		R410A
	Precharged Amount	kg	22.0
		lbs	48.5
	GWP		2087.5
	TCO ₂ eq		45.9
Control		Electronic Expansion Valve	
Power Supply		∅, V, Hz	380~415, 3, 50
			380, 3, 60
Number of maximum connectable indoor units***			64

Note

- Due to our policy of innovation some specifications may be changed without notification.
- Wiring cable size must comply with the applicable local and national codes. And "Electric characteristics" chapter should be considered for electrical work and design. Especially the power cable and circuit breaker should be selected in accordance with that.
- Power factor could vary less than ±1% according to the operating conditions.
- Sound pressure level is measured on the rated condition in the anechoic rooms by ISO 3745 standard.
Sound power level is measured on the rated condition in the reverberation rooms by ISO 9614 standard.
Therefore, these values can be increased owing to ambient conditions during operation.
- Sound values of combination model are calculated values based on sound results of independent models.
Sound values can be increased owing to ambient or installation conditions during operation.
Sound values of system [dB(A)] = $10 \cdot \log [10^{A1/10} + \dots + 10^{An/10}]$, A1~An means sound values of independent models.
- Performances are based on the following conditions :
 - *Cooling : Indoor Ambient Temp. 27°CDB / 19°CWB, Outdoor Ambient Temp. 35°CDB / 24°CWB
 - *Heating : Indoor Ambient Temp. 20°CDB / 15°CWB, Outdoor Ambient Temp. 7°CDB / 6°CWB
 - Interconnected Pipe Length is 7.5m and difference of Elevation (Outdoor ~ Indoor Unit) is 0m.
- *** : The number in parentheses means maximum connectable indoor units in accordance with outdoor units combination (160~200%).
The recommended ratio is 130%.
- This product contains Fluorinated greenhouse gases.(R410A, GWP(Global warming potential) = 2,087.5)

1. Specifications

HP			56	58
Model Name	Combination Unit		A(C)RUN560LLS5	A(C)RUN580LLS5
	Independent Unit		A(C)RUN260LLS5	A(C)RUN260LLS5
			A(C)RUN180LLS5	A(C)RUN200LLS5
			A(C)RUN120LLS5	A(C)RUN120LLS5
Capacity	Cooling(Rated)	kW	156.8	162.4
		kcal/h	134,800	139,700
		Btu/h	535,000	554,100
	Heating(Rated)	kW	156.8	162.4
		kcal/h	134,800	139,700
		Btu/h	535,000	554,100
Input (Rated)	Cooling	kW	42.0	43.8
	Heating	kW	41.7	44.1
EER (Rated)			3.73	3.71
COP (Rated)			3.76	3.68
Power Factor	Rated	-	0.93	0.93
Exterior	Casing Color		Morning Gray / Dawn Gray	Morning Gray / Dawn Gray
	RAL code		RAL 7038 / RAL 7037	RAL 7038 / RAL 7037
Heat Exchanger			Wide Louver Plus	Wide Louver Plus
Compressor	Type		Hermetically Sealed Scroll	Hermetically Sealed Scroll
	Piston Displacement	cm ³ /rev	(62.1 x 3) + (87.6)	(62.1 x 3) + (87.6)
	Number of Revolution	rev/min	3,600 x 4	3,600 x 4
	Motor Output x Number	W x No.	(5,300 x 3) + (7,500 x 1)	(5,300 x 3) + (7,500 x 1)
	Starting Method		Inverter	Inverter
Oil Type		FW68D(PVE)	FW68D(PVE)	
Fan	Type		Propeller fan	Propeller fan
	Motor Output x Number	W	(900 x 4) + (1,200 x 1)	(900 x 4) + (1,200 x 1)
	Air Flow Rate(High)	m ³ /min	(320 x 2) + (240 x 1)	(320 x 2) + (240 x 1)
		ft ³ /min	(11,301 x 2) + (8,476 x 1)	(11,301 x 2) + (8,476 x 1)
	Drive		DC INVERTER	DC INVERTER
Discharge		Side / Top	TOP	
Pipe Connections	Liquid Pipe	mm(inch)	19.05(3/4)	19.05(3/4)
	Gas Pipe	mm(inch)	41.3(1-5/8)	41.3(1-5/8)
Dimensions(W x H x D)		mm	(1,240 x 1,690 x 760) x 2 + (930 x 1,690 x 760) x 1	(1,240 x 1,690 x 760) x 2 + (930 x 1,690 x 760) x 1
		inch	(48-13/16 x 66-17/32 x 29-29/32) x 2 + (36-5/8 x 66-17/32 x 29-29/32) x 1	(48-13/16 x 66-17/32 x 29-29/32) x 2 + (36-5/8 x 66-17/32 x 29-29/32) x 1
Weight	Net	kg	(268) + (230) + (172)	(268) + (230) + (172)
		lbs	(580) + (492) + (373)	(580) + (492) + (373)
	Shipping	kg	(285) + (247) + (184)	(285) + (247) + (184)
		lbs	(628) + (545) + (406)	(628) + (545) + (406)
Sound Pressure Level	Cooling	dB(A)	67.4	67.7
	Heating	dB(A)	69.5	70.0
Sound Power Level	Cooling	dB(A)	90.1	90.4
	Heating	dB(A)	91.8	92.8

Note

- Due to our policy of innovation some specifications may be changed without notification.
- Wiring cable size must comply with the applicable local and national codes. And "Electric characteristics" chapter should be considered for electrical work and design. Especially the power cable and circuit breaker should be selected in accordance with that.
- Power factor could vary less than $\pm 1\%$ according to the operating conditions.
- Sound pressure level is measured on the rated condition in the anechoic rooms by ISO 3745 standard.
Sound power level is measured on the rated condition in the reverberation rooms by ISO 9614 standard.
Therefore, these values can be increased owing to ambient conditions during operation.
- Sound values of combination model are calculated values based on sound results of independent models.
Sound values can be increased owing to ambient or installation conditions during operation.
Sound values of system [dB(A)] = $10 \cdot \log [10^{A1/10} + \dots + 10^{An/10}]$, A1~An means sound values of independent models.
- Performances are based on the following conditions :
 - *Cooling : Indoor Ambient Temp. 27°CDB / 19°CWB, Outdoor Ambient Temp. 35°CDB / 24°CWB
 - *Heating : Indoor Ambient Temp. 20°CDB / 15°CWB, Outdoor Ambient Temp. 7°CDB / 6°CWB
 - Interconnected Pipe Length is 7.5m and difference of Elevation (Outdoor ~ Indoor Unit) is 0m.
- *** : The number in parentheses means maximum connectable indoor units in accordance with outdoor units combination (160~200%).
The recommended ratio is 130%.
- This product contains Fluorinated greenhouse gases.(R410A, GWP(Global warming potential) = 2,087.5)

1. Specifications

HP		56	58
Model Name	Combination Unit	A(C)RUN560LLS5	A(C)RUN580LLS5
	Independent Unit	A(C)RUN260LLS5	A(C)RUN260LLS5
		A(C)RUN180LLS5	A(C)RUN200LLS5
		A(C)RUN120LLS5	A(C)RUN120LLS5
Protection Devices	High pressure protection	High pressure sensor / High pressure switch	
	Compressor/Fan	Over-heat protection / Fan driver overload protector	
	Inverter	Over-heat protection / Over-current protection	
Communication Cable	No. × mm ² (VCTF-SB)	2C × 1.0 ~ 1.5	2C × 1.0 ~ 1.5
Refrigerant	Refrigerant name	R410A	
	Precharged Amount	kg	23.2
		lbs	51.1
	GWP	2087.5	
	TCO ₂ eq	48.4	
Control	Electronic Expansion Valve		
Power Supply	∅, V, Hz	380~415, 3, 50	380~415, 3, 50
		380, 3, 60	380, 3, 60
Number of maximum connectable indoor units***		64	64

Note

- Due to our policy of innovation some specifications may be changed without notification.
- Wiring cable size must comply with the applicable local and national codes. And "Electric characteristics" chapter should be considered for electrical work and design. Especially the power cable and circuit breaker should be selected in accordance with that.
- Power factor could vary less than ±1% according to the operating conditions.
- Sound pressure level is measured on the rated condition in the anechoic rooms by ISO 3745 standard.
Sound power level is measured on the rated condition in the reverberation rooms by ISO 9614 standard.
Therefore, these values can be increased owing to ambient conditions during operation.
- Sound values of combination model are calculated values based on sound results of independent models.
Sound values can be increased owing to ambient or installation conditions during operation.
Sound values of system [dB(A)] = $10 \cdot \log [10^{A1/10} + \dots + 10^{An/10}]$, A1~An means sound values of independent models.
- Performances are based on the following conditions :
 - *Cooling : Indoor Ambient Temp. 27°CDB / 19°CWB, Outdoor Ambient Temp. 35°CDB / 24°CWB
 - *Heating : Indoor Ambient Temp. 20°CDB / 15°CWB, Outdoor Ambient Temp. 7°CDB / 6°CWB
 - Interconnected Pipe Length is 7.5m and difference of Elevation (Outdoor ~ Indoor Unit) is 0m.
- *** : The number in parentheses means maximum connectable indoor units in accordance with outdoor units combination (160~200%).
The recommended ratio is 130%.
- This product contains Fluorinated greenhouse gases.(R410A, GWP(Global warming potential) = 2,087.5)

1. Specifications

HP			60	62
Model Name	Combination Unit		A(C)RUN600LLS5	A(C)RUN620LLS5
	Independent Unit		A(C)RUN260LLS5	A(C)RUN260LLS5
			A(C)RUN220LLS5	A(C)RUN240LLS5
			A(C)RUN120LLS5	A(C)RUN120LLS5
Capacity	Cooling(Rated)	kW	168.0	173.6
		kcal/h	144,500	149,300
		Btu/h	573,200	592,300
	Heating(Rated)	kW	168.0	173.6
		kcal/h	144,500	149,300
		Btu/h	573,200	592,300
Input (Rated)	Cooling	kW	46.5	47.9
	Heating	kW	47.4	47.5
EER (Rated)			3.61	3.62
COP (Rated)			3.54	3.65
Power Factor	Rated	-	0.93	0.93
Exterior	Casing Color		Morning Gray / Dawn Gray	Morning Gray / Dawn Gray
	RAL code		RAL 7038 / RAL 7037	RAL 7038 / RAL 7037
Heat Exchanger			Wide Louver Plus	Wide Louver Plus
Compressor	Type		Hermetically Sealed Scroll	Hermetically Sealed Scroll
	Piston Displacement	cm ³ /rev	(62.1 × 3) + (87.6)	62.1 × 5
	Number of Revolution	rev/min	3,600 × 4	3,600 × 5
	Motor Output × Number	W × No.	(5,300 × 3) + (7,500 × 1)	5,300 × 5
	Starting Method		Inverter	Inverter
Oil Type		FW68D(PVE)	FW68D(PVE)	
Fan	Type		Propeller fan	Propeller fan
	Motor Output × Number	W	(900 × 4) + (1,200 × 1)	(900 × 4) + (1,200 × 1)
	Air Flow Rate(High)	m ³ /min	(320 × 2) + (240 × 1)	(320 × 2) + (240 × 1)
		ft ³ /min	(11,301 × 2) + (8,476 × 1)	(11,301 × 2) + (8,476 × 1)
	Drive		DC INVERTER	DC INVERTER
Discharge		Side / Top	TOP	
Pipe Connections	Liquid Pipe	mm(inch)	19.05(3/4)	22.2(7/8)
	Gas Pipe	mm(inch)	41.3(1-5/8)	41.3(1-5/8)
Dimensions(W × H × D)		mm	(1,240 × 1,690 × 760) × 2 + (930 × 1,690 × 760) × 1	(1,240 × 1,690 × 760) × 2 + (930 × 1,690 × 760) × 1
		inch	(48-13/16 × 66-17/32 × 29-29/32) × 2 + (36-5/8 × 66-17/32 × 29-29/32) × 1	(48-13/16 × 66-17/32 × 29-29/32) × 2 + (36-5/8 × 66-17/32 × 29-29/32) × 1
Weight	Net	kg	(268) + (230) + (172)	(268) + (268) + (172)
		lbs	(580) + (492) + (373)	(580) + (580) + (373)
	Shipping	kg	(285) + (247) + (184)	(285) + (285) + (184)
		lbs	(628) + (545) + (406)	(628) + (628) + (406)
Sound Pressure Level	Cooling	dB(A)	68.1	68.5
	Heating	dB(A)	70.4	70.4
Sound Power Level	Cooling	dB(A)	90.8	91.3
	Heating	dB(A)	93.2	93.2

Note

- Due to our policy of innovation some specifications may be changed without notification.
- Wiring cable size must comply with the applicable local and national codes. And "Electric characteristics" chapter should be considered for electrical work and design. Especially the power cable and circuit breaker should be selected in accordance with that.
- Power factor could vary less than ±1% according to the operating conditions.
- Sound pressure level is measured on the rated condition in the anechoic rooms by ISO 3745 standard.
Sound power level is measured on the rated condition in the reverberation rooms by ISO 9614 standard.
Therefore, these values can be increased owing to ambient conditions during operation.
- Sound values of combination model are calculated values based on sound results of independent models.
Sound values can be increased owing to ambient or installation conditions during operation.
Sound values of system [dB(A)] = 10*log [10^{A1}/10 + ... + 10^{An}/10], A1~An means sound values of independent models.
- Performances are based on the following conditions :
 - *Cooling : Indoor Ambient Temp. 27°CDB / 19°CWB, Outdoor Ambient Temp. 35°CDB / 24°CWB
 - *Heating : Indoor Ambient Temp. 20°CDB / 15°CWB, Outdoor Ambient Temp. 7°CDB / 6°CWB
 - Interconnected Pipe Length is 7.5m and difference of Elevation (Outdoor ~ Indoor Unit) is 0m.
- *** : The number in parentheses means maximum connectable indoor units in accordance with outdoor units combination (160~200%).
The recommended ratio is 130%.
- This product contains Fluorinated greenhouse gases.(R410A, GWP(Global warming potential) = 2,087.5)

1. Specifications

HP		60	62
Model Name	Combination Unit	A(C)RUN600LLS5	A(C)RUN620LLS5
	Independent Unit	A(C)RUN260LLS5	A(C)RUN260LLS5
		A(C)RUN220LLS5	A(C)RUN240LLS5
		A(C)RUN120LLS5	A(C)RUN120LLS5
Protection Devices	High pressure protection	High pressure sensor / High pressure switch	
	Compressor/Fan	Over-heat protection / Fan driver overload protector	
	Inverter	Over-heat protection / Over-current protection	
Communication Cable		No. × mm ² (VCTF-SB)	2C × 1.0 ~ 1.5
Refrigerant	Refrigerant name		R410A
	Precharged Amount	kg	23.2
		lbs	51.1
	GWP		2087.5
	TCO ₂ eq		48.4
Control		Electronic Expansion Valve	Electronic Expansion Valve
Power Supply		∅, V, Hz	380~415, 3, 50
			380, 3, 60
Number of maximum connectable indoor units***			64
			64
Note			
1. Due to our policy of innovation some specifications may be changed without notification.			
2. Wiring cable size must comply with the applicable local and national codes. And "Electric characteristics" chapter should be considered for electrical work and design. Especially the power cable and circuit breaker should be selected in accordance with that.			
3. Power factor could vary less than ±1% according to the operating conditions.			
4. Sound pressure level is measured on the rated condition in the anechoic rooms by ISO 3745 standard. Sound power level is measured on the rated condition in the reverberation rooms by ISO 9614 standard. Therefore, these values can be increased owing to ambient conditions during operation.			
5. Sound values of combination model are calculated values based on sound results of independent models. Sound values can be increased owing to ambient or installation conditions during operation. Sound values of system [dB(A)] = 10*log [10 ^{A1/10} + ... +10 ^{An/10}], A1~An means sound values of independent models.			
6. Performances are based on the following conditions : • *Cooling : Indoor Ambient Temp. 27°CDB / 19°CWB, Outdoor Ambient Temp. 35°CDB / 24°CWB • *Heating : Indoor Ambient Temp. 20°CDB / 15°CWB, Outdoor Ambient Temp. 7°CDB / 6°CWB • Interconnected Pipe Length is 7.5m and difference of Elevation (Outdoor ~ Indoor Unit) is 0m.			
7. *** : The number in parentheses means maximum connectable indoor units in accordance with outdoor units combination (160~200%). The recommended ratio is 130%.			
8. This product contains Fluorinated greenhouse gases.(R410A, GWP(Global warming potential) = 2,087.5)			

1. Specifications

HP			64	66
Model Name	Combination Unit		A(C)RUN640LLS5	A(C)RUN660LLS5
	Independent Unit		A(C)RUN260LLS5	A(C)RUN260LLS5
			A(C)RUN260LLS5	A(C)RUN260LLS5
			A(C)RUN120LLS5	A(C)RUN140LLS5
Capacity	Cooling(Rated)	kW	179.2	184.8
		kcal/h	154,100	158,900
		Btu/h	611,400	630,600
	Heating(Rated)	kW	179.2	184.8
		kcal/h	154,100	158,900
		Btu/h	611,400	630,600
Input (Rated)	Cooling	kW	50.5	52.2
	Heating	kW	50.1	52.6
EER (Rated)			3.55	3.54
COP (Rated)			3.58	3.51
Power Factor	Rated	-	0.93	0.93
Exterior	Casing Color		Morning Gray / Dawn Gray	Morning Gray / Dawn Gray
	RAL code		RAL 7038 / RAL 7037	RAL 7038 / RAL 7037
Heat Exchanger			Wide Louver Plus	Wide Louver Plus
Compressor	Type		Hermetically Sealed Scroll	Hermetically Sealed Scroll
	Piston Displacement	cm ³ /rev	62.1 × 5	62.1 × 5
	Number of Revolution	rev/min	3,600 × 5	3,600 × 5
	Motor Output × Number	W × No.	5,300 × 5	5,300 × 5
	Starting Method		Inverter	Inverter
Oil Type		FW68D(PVE)	FW68D(PVE)	
Fan	Type		Propeller fan	Propeller fan
	Motor Output × Number	W	(900 × 4) + (1,200 × 1)	(900 × 4) + (1,200 × 1)
	Air Flow Rate(High)	m ³ /min	(320 × 2) + (240 × 1)	(320 × 2) + (240 × 1)
		ft ³ /min	(11,301 × 2) + (8,476 × 1)	(11,301 × 2) + (8,476 × 1)
	Drive		DC INVERTER	DC INVERTER
Discharge		Side / Top	TOP	
Pipe Connections	Liquid Pipe	mm(inch)	22.2(7/8)	22.2(7/8)
	Gas Pipe	mm(inch)	41.3(1-5/8)	53.98(2-1/8)
Dimensions(W × H × D)		mm	(1,240 × 1,690 × 760) × 2 + (930 × 1,690 × 760) × 1	(1,240 × 1,690 × 760) × 2 + (930 × 1,690 × 760) × 1
		inch	(48-13/16 × 66-17/32 × 29-29/32) × 2 + (36-5/8 × 66-17/32 × 29-29/32) × 1	(48-13/16 × 66-17/32 × 29-29/32) × 2 + (36-5/8 × 66-17/32 × 29-29/32) × 1
Weight	Net	kg	(268) + (268) + (172)	(268) + (268) + (184)
		lbs	(580) + (580) + (373)	(580) + (580) + (401)
	Shipping	kg	(285) + (285) + (184)	(285) + (285) + (196)
		lbs	(628) + (628) + (406)	(628) + (628) + (432)
Sound Pressure Level	Cooling	dB(A)	68.5	68.6
	Heating	dB(A)	70.4	70.5
Sound Power Level	Cooling	dB(A)	91.3	91.5
	Heating	dB(A)	93.2	93.4

Note

- Due to our policy of innovation some specifications may be changed without notification.
- Wiring cable size must comply with the applicable local and national codes. And "Electric characteristics" chapter should be considered for electrical work and design. Especially the power cable and circuit breaker should be selected in accordance with that.
- Power factor could vary less than ±1% according to the operating conditions.
- Sound pressure level is measured on the rated condition in the anechoic rooms by ISO 3745 standard.
Sound power level is measured on the rated condition in the reverberation rooms by ISO 9614 standard.
Therefore, these values can be increased owing to ambient conditions during operation.
- Sound values of combination model are calculated values based on sound results of independent models.
Sound values can be increased owing to ambient or installation conditions during operation.
Sound values of system [dB(A)] = 10*log [10^{A1}/10 + ... + 10^{An}/10], A1~An means sound values of independent models.
- Performances are based on the following conditions :
 - *Cooling : Indoor Ambient Temp. 27°CDB / 19°CWB, Outdoor Ambient Temp. 35°CDB / 24°CWB
 - *Heating : Indoor Ambient Temp. 20°CDB / 15°CWB, Outdoor Ambient Temp. 7°CDB / 6°CWB
 - Interconnected Pipe Length is 7.5m and difference of Elevation (Outdoor ~ Indoor Unit) is 0m.
- *** : The number in parentheses means maximum connectable indoor units in accordance with outdoor units combination (160~200%).
The recommended ratio is 130%.
- This product contains Fluorinated greenhouse gases.(R410A, GWP(Global warming potential) = 2,087.5)

1. Specifications

HP		64	66	
Model Name	Combination Unit	A(C)RUN640LLS5	A(C)RUN660LLS5	
	Independent Unit	A(C)RUN260LLS5	A(C)RUN260LLS5	
		A(C)RUN260LLS5	A(C)RUN260LLS5	
		A(C)RUN120LLS5	A(C)RUN140LLS5	
Protection Devices	High pressure protection	High pressure sensor / High pressure switch		
	Compressor/Fan	Over-heat protection / Fan driver overload protector		
	Inverter	Over-heat protection / Over-current protection		
Communication Cable	No. × mm ² (VCTF-SB)	2C × 1.0 ~ 1.5	2C × 1.0 ~ 1.5	
Refrigerant	Refrigerant name	R410A		
	Precharged Amount	kg	26.7	29.5
		lbs	58.9	65.0
	GWP	2087.5		
	TCO ₂ eq	55.7		
Control	Electronic Expansion Valve			
Power Supply	∅, V, Hz	380~415, 3, 50	380~415, 3, 50	
		380, 3, 60	380, 3, 60	
Number of maximum connectable indoor units***		64	64	

Note

- Due to our policy of innovation some specifications may be changed without notification.
- Wiring cable size must comply with the applicable local and national codes. And "Electric characteristics" chapter should be considered for electrical work and design. Especially the power cable and circuit breaker should be selected in accordance with that.
- Power factor could vary less than ±1% according to the operating conditions.
- Sound pressure level is measured on the rated condition in the anechoic rooms by ISO 3745 standard.
Sound power level is measured on the rated condition in the reverberation rooms by ISO 9614 standard.
Therefore, these values can be increased owing to ambient conditions during operation.
- Sound values of combination model are calculated values based on sound results of independent models.
Sound values can be increased owing to ambient or installation conditions during operation.
Sound values of system [dB(A)] = $10 \cdot \log [10^{A1/10} + \dots + 10^{An/10}]$, A1~An means sound values of independent models.
- Performances are based on the following conditions :
 - *Cooling : Indoor Ambient Temp. 27°CDB / 19°CWB, Outdoor Ambient Temp. 35°CDB / 24°CWB
 - *Heating : Indoor Ambient Temp. 20°CDB / 15°CWB, Outdoor Ambient Temp. 7°CDB / 6°CWB
 - Interconnected Pipe Length is 7.5m and difference of Elevation (Outdoor ~ Indoor Unit) is 0m.
- *** : The number in parentheses means maximum connectable indoor units in accordance with outdoor units combination (160~200%).
The recommended ratio is 130%.
- This product contains Fluorinated greenhouse gases.(R410A, GWP(Global warming potential) = 2,087.5)

1. Specifications

HP			68	70
Model Name	Combination Unit		A(C)RUN680LLS5	A(C)RUN700LLS5
	Independent Unit		A(C)RUN260LLS5	A(C)RUN260LLS5
			A(C)RUN260LLS5	A(C)RUN260LLS5
			A(C)RUN160LLS5	A(C)RUN180LLS5
Capacity	Cooling(Rated)	kW	190.4	196.0
		kcal/h	163,700	168,500
		Btu/h	649,700	668,800
	Heating(Rated)	kW	190.4	196.0
		kcal/h	163,700	168,500
		Btu/h	649,700	668,800
Input (Rated)	Cooling	kW	53.5	53.9
	Heating	kW	53.1	53.1
EER (Rated)			3.56	3.64
COP (Rated)			3.59	3.69
Power Factor	Rated	-	0.93	0.93
Exterior	Casing Color		Morning Gray / Dawn Gray	Morning Gray / Dawn Gray
	RAL code		RAL 7038 / RAL 7037	RAL 7038 / RAL 7037
Heat Exchanger			Wide Louver Plus	Wide Louver Plus
Compressor	Type		Hermetically Sealed Scroll	Hermetically Sealed Scroll
	Piston Displacement	cm ³ /rev	62.1 × 5	(62.1 × 4) + (87.6)
	Number of Revolution	rev/min	3,600 × 5	3,600 × 5
	Motor Output × Number	W × No.	5,300 × 5	(5,300 × 4) + (7,500 × 1)
	Starting Method		Inverter	Inverter
Oil Type		FW68D(PVE)	FW68D(PVE)	
Fan	Type		Propeller fan	Propeller fan
	Motor Output × Number	W	900 × 6	900 × 6
	Air Flow Rate(High)	m ³ /min	320 × 3	320 × 3
		ft ³ /min	11,301 × 3	11,301 × 3
	Drive		DC INVERTER	DC INVERTER
Discharge		Side / Top	TOP	
Pipe Connections	Liquid Pipe	mm(inch)	22.2(7/8)	22.2(7/8)
	Gas Pipe	mm(inch)	53.98(2-1/8)	53.98(2-1/8)
Dimensions(W × H × D)		mm	(1,240 × 1,690 × 760) × 3	(1,240 × 1,690 × 760) × 3
		inch	(48-13/16 × 66-17/32 × 29-29/32) × 3	(48-13/16 × 66-17/32 × 29-29/32) × 3
Weight	Net	kg	(268) + (268) + (205)	(268) + (268) + (230)
		lbs	(580) + (580) + (448)	(580) + (580) + (492)
	Shipping	kg	(285) + (285) + (222)	(285) + (285) + (247)
		lbs	(628) + (628) + (489)	(628) + (628) + (545)
Sound Pressure Level	Cooling	dB(A)	68.7	69.0
	Heating	dB(A)	70.6	71.1
Sound Power Level	Cooling	dB(A)	91.6	92.0
	Heating	dB(A)	93.6	93.8

Note

- Due to our policy of innovation some specifications may be changed without notification.
- Wiring cable size must comply with the applicable local and national codes. And "Electric characteristics" chapter should be considered for electrical work and design. Especially the power cable and circuit breaker should be selected in accordance with that.
- Power factor could vary less than ±1% according to the operating conditions.
- Sound pressure level is measured on the rated condition in the anechoic rooms by ISO 3745 standard.
Sound power level is measured on the rated condition in the reverberation rooms by ISO 9614 standard.
Therefore, these values can be increased owing to ambient conditions during operation.
- Sound values of combination model are calculated values based on sound results of independent models.
Sound values can be increased owing to ambient or installation conditions during operation.
Sound values of system [dB(A)] = 10*log [10^{A1}(A1/10)+ ... +10^{An}(An/10)] , A1~An means sound values of independent models.
- Performances are based on the following conditions :
 - *Cooling : Indoor Ambient Temp. 27°CDB / 19°CWB, Outdoor Ambient Temp. 35°CDB / 24°CWB
 - *Heating : Indoor Ambient Temp. 20°CDB / 15°CWB, Outdoor Ambient Temp. 7°CDB / 6°CWB
 - Interconnected Pipe Length is 7.5m and difference of Elevation (Outdoor ~ Indoor Unit) is 0m.
- *** : The number in parentheses means maximum connectable indoor units in accordance with outdoor units combination (160~200%).
The recommended ratio is 130%.
- This product contains Fluorinated greenhouse gases.(R410A, GWP(Global warming potential) = 2,087.5)

1. Specifications

HP		68	70	
Model Name	Combination Unit	A(C)RUN680LLS5	A(C)RUN700LLS5	
	Independent Unit	A(C)RUN260LLS5	A(C)RUN260LLS5	
		A(C)RUN260LLS5	A(C)RUN260LLS5	
		A(C)RUN160LLS5	A(C)RUN180LLS5	
Protection Devices	High pressure protection	High pressure sensor / High pressure switch		
	Compressor/Fan	Over-heat protection / Fan driver overload protector		
	Inverter	Over-heat protection / Over-current protection		
Communication Cable	No. × mm ² (VCTF-SB)	2C × 1.0 ~ 1.5	2C × 1.0 ~ 1.5	
Refrigerant	Refrigerant name	R410A		
	Precharged Amount	kg	28.5	29.5
		lbs	62.8	65.0
	GWP	2087.5		
	TCO ₂ eq	59.5		
Control	Electronic Expansion Valve			
Power Supply	∅, V, Hz	380~415, 3, 50	380~415, 3, 50	
Number of maximum connectable indoor units***		380, 3, 60	380, 3, 60	
		64	64	

Note

- Due to our policy of innovation some specifications may be changed without notification.
- Wiring cable size must comply with the applicable local and national codes. And "Electric characteristics" chapter should be considered for electrical work and design. Especially the power cable and circuit breaker should be selected in accordance with that.
- Power factor could vary less than ±1% according to the operating conditions.
- Sound pressure level is measured on the rated condition in the anechoic rooms by ISO 3745 standard.
Sound power level is measured on the rated condition in the reverberation rooms by ISO 9614 standard.
Therefore, these values can be increased owing to ambient conditions during operation.
- Sound values of combination model are calculated values based on sound results of independent models.
Sound values can be increased owing to ambient or installation conditions during operation.
Sound values of system [dB(A)] = $10 \cdot \log [10^{A1/10} + \dots + 10^{An/10}]$, A1~An means sound values of independent models.
- Performances are based on the following conditions :
 - *Cooling : Indoor Ambient Temp. 27°CDB / 19°CWB, Outdoor Ambient Temp. 35°CDB / 24°CWB
 - *Heating : Indoor Ambient Temp. 20°CDB / 15°CWB, Outdoor Ambient Temp. 7°CDB / 6°CWB
 - Interconnected Pipe Length is 7.5m and difference of Elevation (Outdoor ~ Indoor Unit) is 0m.
- *** : The number in parentheses means maximum connectable indoor units in accordance with outdoor units combination (160~200%).
The recommended ratio is 130%.
- This product contains Fluorinated greenhouse gases.(R410A, GWP(Global warming potential) = 2,087.5)

1. Specifications

HP			72	74
Model Name	Combination Unit		A(C)RUN720LLS5	A(C)RUN740LLS5
	Independent Unit		A(C)RUN260LLS5	A(C)RUN260LLS5
			A(C)RUN260LLS5	A(C)RUN260LLS5
			A(C)RUN200LLS5	A(C)RUN220LLS5
Capacity	Cooling(Rated)	kW	201.6	207.2
		kcal/h	173,400	178,200
		Btu/h	687,900	707,000
	Heating(Rated)	kW	201.6	207.2
		kcal/h	173,400	178,200
		Btu/h	687,900	707,000
Input (Rated)	Cooling	kW	55.7	58.4
	Heating	kW	55.5	58.8
EER (Rated)			3.62	3.55
COP (Rated)			3.63	3.52
Power Factor	Rated	-	0.93	0.93
Exterior	Casing Color		Morning Gray / Dawn Gray	Morning Gray / Dawn Gray
	RAL code		RAL 7038 / RAL 7037	RAL 7038 / RAL 7037
Heat Exchanger			Wide Louver Plus	Wide Louver Plus
Compressor	Type		Hermetically Sealed Scroll	Hermetically Sealed Scroll
	Piston Displacement	cm ³ /rev	(62.1 x 4) + (87.6)	(62.1 x 4) + (87.6)
	Number of Revolution	rev/min	3,600 x 5	3,600 x 5
	Motor Output x Number	W x No.	(5,300 x 4) + (7,500 x 1)	(5,300 x 4) + (7,500 x 1)
	Starting Method		Inverter	Inverter
	Oil Type		FW68D(PVE)	FW68D(PVE)
Fan	Type		Propeller fan	Propeller fan
	Motor Output x Number	W	900 x 6	900 x 6
	Air Flow Rate(High)	m ³ /min	320 x 3	320 x 3
		ft ³ /min	11,301 x 3	11,301 x 3
	Drive		DC INVERTER	DC INVERTER
	Discharge	Side / Top	TOP	TOP
Pipe Connections	Liquid Pipe	mm(inch)	22.2(7/8)	22.2(7/8)
	Gas Pipe	mm(inch)	53.98(2-1/8)	53.98(2-1/8)
Dimensions(W x H x D)		mm	(1,240 x 1,690 x 760) x 3	(1,240 x 1,690 x 760) x 3
		inch	(48-13/16 x 66-17/32 x 29-29/32) x 3	(48-13/16 x 66-17/32 x 29-29/32) x 3
Weight	Net	kg	(268) + (268) + (230)	(268) + (268) + (230)
		lbs	(580) + (580) + (492)	(580) + (580) + (492)
	Shipping	kg	(285) + (285) + (247)	(285) + (285) + (247)
		lbs	(628) + (628) + (545)	(628) + (628) + (545)
Sound Pressure Level	Cooling	dB(A)	69.2	69.5
	Heating	dB(A)	71.5	71.8
Sound Power Level	Cooling	dB(A)	92.2	92.5
	Heating	dB(A)	94.5	94.8

Note

- Due to our policy of innovation some specifications may be changed without notification.
- Wiring cable size must comply with the applicable local and national codes. And "Electric characteristics" chapter should be considered for electrical work and design. Especially the power cable and circuit breaker should be selected in accordance with that.
- Power factor could vary less than ±1% according to the operating conditions.
- Sound pressure level is measured on the rated condition in the anechoic rooms by ISO 3745 standard.
Sound power level is measured on the rated condition in the reverberation rooms by ISO 9614 standard.
Therefore, these values can be increased owing to ambient conditions during operation.
- Sound values of combination model are calculated values based on sound results of independent models.
Sound values can be increased owing to ambient or installation conditions during operation.
Sound values of system [dB(A)] = 10*log [10^{A1}(A1/10)+ ... +10^{An}(An/10)] , A1~An means sound values of independent models.
- Performances are based on the following conditions :
 - *Cooling : Indoor Ambient Temp. 27°CDB / 19°CWB, Outdoor Ambient Temp. 35°CDB / 24°CWB
 - *Heating : Indoor Ambient Temp. 20°CDB / 15°CWB, Outdoor Ambient Temp. 7°CDB / 6°CWB
 - Interconnected Pipe Length is 7.5m and difference of Elevation (Outdoor ~ Indoor Unit) is 0m.
- *** : The number in parentheses means maximum connectable indoor units in accordance with outdoor units combination (160~200%).
The recommended ratio is 130%.
- This product contains Fluorinated greenhouse gases.(R410A, GWP(Global warming potential) = 2,087.5)

1. Specifications

HP		72	74
Model Name	Combination Unit	A(C)RUN720LLS5	A(C)RUN740LLS5
	Independent Unit	A(C)RUN260LLS5	A(C)RUN260LLS5
		A(C)RUN260LLS5	A(C)RUN260LLS5
		A(C)RUN200LLS5	A(C)RUN220LLS5
Protection Devices	High pressure protection	High pressure sensor / High pressure switch	
	Compressor/Fan	Over-heat protection / Fan driver overload protector	
	Inverter	Over-heat protection / Over-current protection	
Communication Cable	No. × mm ² (VCTF-SB)	2C × 1.0 ~ 1.5	2C × 1.0 ~ 1.5
Refrigerant	Refrigerant name	R410A	
	Precharged Amount	kg	29.5
		lbs	65.0
	GWP	2087.5	
	TCO ₂ eq	61.6	
Control	Electronic Expansion Valve		
Power Supply	∅, V, Hz	380~415, 3, 50	380~415, 3, 50
Number of maximum connectable indoor units***		380, 3, 60	380, 3, 60
		64	64

Note

- Due to our policy of innovation some specifications may be changed without notification.
- Wiring cable size must comply with the applicable local and national codes. And "Electric characteristics" chapter should be considered for electrical work and design. Especially the power cable and circuit breaker should be selected in accordance with that.
- Power factor could vary less than ±1% according to the operating conditions.
- Sound pressure level is measured on the rated condition in the anechoic rooms by ISO 3745 standard.
Sound power level is measured on the rated condition in the reverberation rooms by ISO 9614 standard.
Therefore, these values can be increased owing to ambient conditions during operation.
- Sound values of combination model are calculated values based on sound results of independent models.
Sound values can be increased owing to ambient or installation conditions during operation.
Sound values of system [dB(A)] = $10 \cdot \log [10^{A1/10} + \dots + 10^{An/10}]$, A1~An means sound values of independent models.
- Performances are based on the following conditions :
 - *Cooling : Indoor Ambient Temp. 27°CDB / 19°CWB, Outdoor Ambient Temp. 35°CDB / 24°CWB
 - *Heating : Indoor Ambient Temp. 20°CDB / 15°CWB, Outdoor Ambient Temp. 7°CDB / 6°CWB
 - Interconnected Pipe Length is 7.5m and difference of Elevation (Outdoor ~ Indoor Unit) is 0m.
- *** : The number in parentheses means maximum connectable indoor units in accordance with outdoor units combination (160~200%).
The recommended ratio is 130%.
- This product contains Fluorinated greenhouse gases.(R410A, GWP(Global warming potential) = 2,087.5)

1. Specifications

HP			76	78
Model Name	Combination Unit		A(C)RUN760LLS5	A(C)RUN780LLS5
	Independent Unit		A(C)RUN260LLS5	A(C)RUN260LLS5
			A(C)RUN260LLS5	A(C)RUN260LLS5
			A(C)RUN240LLS5	A(C)RUN260LLS5
Capacity	Cooling(Rated)	kW	212.8	218.4
		kcal/h	183,000	187,800
		Btu/h	726,100	745,200
	Heating(Rated)	kW	212.8	218.4
		kcal/h	183,000	187,800
		Btu/h	726,100	745,200
Input (Rated)	Cooling	kW	59.8	62.4
	Heating	kW	58.9	61.5
EER (Rated)			3.56	3.50
COP (Rated)			3.61	3.55
Power Factor	Rated	-	0.93	0.93
Exterior	Casing Color		Morning Gray / Dawn Gray	Morning Gray / Dawn Gray
	RAL code		RAL 7038 / RAL 7037	RAL 7038 / RAL 7037
Heat Exchanger			Wide Louver Plus	Wide Louver Plus
Compressor	Type		Hermetically Sealed Scroll	Hermetically Sealed Scroll
	Piston Displacement	cm ³ /rev	62.1 × 6	62.1 × 6
	Number of Revolution	rev/min	3,600 × 6	3,600 × 6
	Motor Output × Number	W × No.	5,300 × 6	5,300 × 6
	Starting Method		Inverter	Inverter
Oil Type		FW68D(PVE)	FW68D(PVE)	
Fan	Type		Propeller fan	Propeller fan
	Motor Output × Number	W	900 × 6	900 × 6
	Air Flow Rate(High)	m ³ /min	320 × 3	320 × 3
		ft ³ /min	11,301 × 3	11,301 × 3
	Drive		DC INVERTER	DC INVERTER
Discharge		Side / Top	TOP	
Pipe Connections	Liquid Pipe	mm(inch)	22.2(7/8)	22.2(7/8)
	Gas Pipe	mm(inch)	53.98(2-1/8)	53.98(2-1/8)
Dimensions(W × H × D)		mm	(1,240 × 1,690 × 760) × 3	(1,240 × 1,690 × 760) × 3
		inch	(48-13/16 × 66-17/32 × 29-29/32) × 3	(48-13/16 × 66-17/32 × 29-29/32) × 3
Weight	Net	kg	(268) + (268) + (268)	(268) + (268) + (268)
		lbs	(580) + (580) + (580)	(580) + (580) + (580)
	Shipping	kg	(285) + (285) + (285)	(285) + (285) + (285)
		lbs	(628) + (628) + (628)	(628) + (628) + (628)
Sound Pressure Level	Cooling	dB(A)	69.8	69.8
	Heating	dB(A)	71.8	71.8
Sound Power Level	Cooling	dB(A)	92.8	92.8
	Heating	dB(A)	94.8	94.8

Note

- Due to our policy of innovation some specifications may be changed without notification.
- Wiring cable size must comply with the applicable local and national codes. And "Electric characteristics" chapter should be considered for electrical work and design. Especially the power cable and circuit breaker should be selected in accordance with that.
- Power factor could vary less than ±1% according to the operating conditions.
- Sound pressure level is measured on the rated condition in the anechoic rooms by ISO 3745 standard.
Sound power level is measured on the rated condition in the reverberation rooms by ISO 9614 standard.
Therefore, these values can be increased owing to ambient conditions during operation.
- Sound values of combination model are calculated values based on sound results of independent models.
Sound values can be increased owing to ambient or installation conditions during operation.
Sound values of system [dB(A)] = 10*log [10^{A1}(A1/10)+ ... +10^{An}(An/10)] , A1~An means sound values of independent models.
- Performances are based on the following conditions :
 - *Cooling : Indoor Ambient Temp. 27°CDB / 19°CWB, Outdoor Ambient Temp. 35°CDB / 24°CWB
 - *Heating : Indoor Ambient Temp. 20°CDB / 15°CWB, Outdoor Ambient Temp. 7°CDB / 6°CWB
 - Interconnected Pipe Length is 7.5m and difference of Elevation (Outdoor ~ Indoor Unit) is 0m.
- *** : The number in parentheses means maximum connectable indoor units in accordance with outdoor units combination (160~200%).
The recommended ratio is 130%.
- This product contains Fluorinated greenhouse gases.(R410A, GWP(Global warming potential) = 2,087.5)

1. Specifications

HP		76	78
Model Name	Combination Unit	A(C)RUN760LLS5	A(C)RUN780LLS5
	Independent Unit	A(C)RUN260LLS5	A(C)RUN260LLS5
		A(C)RUN260LLS5	A(C)RUN260LLS5
		A(C)RUN240LLS5	A(C)RUN260LLS5
Protection Devices	High pressure protection	High pressure sensor / High pressure switch	
	Compressor/Fan	Over-heat protection / Fan driver overload protector	
	Inverter	Over-heat protection / Over-current protection	
Communication Cable		No. × mm ² (VCTF-SB)	2C × 1.0 ~ 1.5
Refrigerant	Refrigerant name		R410A
	Precharged Amount	kg	33.0
		lbs	72.8
	GWP		2087.5
	TCO ₂ eq		68.9
Control		Electronic Expansion Valve	
Power Supply		∅, V, Hz	380~415, 3, 50
			380, 3, 60
Number of maximum connectable indoor units***			64

Note

- Due to our policy of innovation some specifications may be changed without notification.
- Wiring cable size must comply with the applicable local and national codes. And "Electric characteristics" chapter should be considered for electrical work and design. Especially the power cable and circuit breaker should be selected in accordance with that.
- Power factor could vary less than ±1% according to the operating conditions.
- Sound pressure level is measured on the rated condition in the anechoic rooms by ISO 3745 standard.
Sound power level is measured on the rated condition in the reverberation rooms by ISO 9614 standard.
Therefore, these values can be increased owing to ambient conditions during operation.
- Sound values of combination model are calculated values based on sound results of independent models.
Sound values can be increased owing to ambient or installation conditions during operation.
Sound values of system [dB(A)] = $10 \cdot \log [10^{A1/10} + \dots + 10^{An/10}]$, A1~An means sound values of independent models.
- Performances are based on the following conditions :
 - *Cooling : Indoor Ambient Temp. 27°CDB / 19°CWB, Outdoor Ambient Temp. 35°CDB / 24°CWB
 - *Heating : Indoor Ambient Temp. 20°CDB / 15°CWB, Outdoor Ambient Temp. 7°CDB / 6°CWB
 - Interconnected Pipe Length is 7.5m and difference of Elevation (Outdoor ~ Indoor Unit) is 0m.
- *** : The number in parentheses means maximum connectable indoor units in accordance with outdoor units combination (160~200%).
The recommended ratio is 130%.
- This product contains Fluorinated greenhouse gases.(R410A, GWP(Global warming potential) = 2,087.5)

1. Specifications

HP			80	82
Model Name	Combination Unit		A(C)RUN800LLS5	A(C)RUN820LLS5
	Independent Unit		A(C)RUN260LLS5	A(C)RUN260LLS5
			A(C)RUN260LLS5	A(C)RUN260LLS5
			A(C)RUN160LLS5	A(C)RUN180LLS5
			A(C)RUN120LLS5	A(C)RUN120LLS5
Capacity	Cooling(Rated)	kW	224.0	229.6
		kcal/h	192,600	197,400
		Btu/h	764,300	783,400
	Heating(Rated)	kW	224.0	229.6
		kcal/h	192,600	197,400
		Btu/h	764,300	783,400
Input (Rated)	Cooling	kW	62.4	62.8
	Heating	kW	62.2	62.2
EER (Rated)			3.59	3.66
COP (Rated)			3.60	3.69
Power Factor	Rated	-	0.93	0.93
Exterior	Casing Color		Morning Gray / Dawn Gray	Morning Gray / Dawn Gray
	RAL code		RAL 7038 / RAL 7037	RAL 7038 / RAL 7037
Heat Exchanger			Wide Louver Plus	Wide Louver Plus
Compressor	Type		Hermetically Sealed Scroll	Hermetically Sealed Scroll
	Piston Displacement	cm ³ /rev	62.1 × 6	(62.1 × 5) + (87.6)
	Number of Revolution	rev/min	3,600 × 6	3,600 × 6
	Motor Output × Number	W × No.	5,300 × 6	(5,300 × 5) + (7,500 × 1)
	Starting Method		Inverter	Inverter
Oil Type		FW68D(PVE)	FW68D(PVE)	
Fan	Type		Propeller fan	Propeller fan
	Motor Output × Number	W	(900 × 6) + (1,200 × 1)	(900 × 6) + (1,200 × 1)
	Air Flow Rate(High)	m ³ /min	(320 × 3) + (240 × 1)	(320 × 3) + (240 × 1)
		ft ³ /min	(11,301 × 3) + (8,476 × 1)	(11,301 × 3) + (8,476 × 1)
	Drive		DC INVERTER	DC INVERTER
Pipe Connections	Liquid Pipe	mm(inch)	22.2(7/8)	22.2(7/8)
	Gas Pipe	mm(inch)	53.98(2-1/8)	53.98(2-1/8)
Dimensions(W × H × D)		mm	(1,240 × 1,690 × 760) × 3 + (930 × 1,690 × 760) × 1	(1,240 × 1,690 × 760) × 3 + (930 × 1,690 × 760) × 1
		inch	(48-13/16 × 66-17/32 × 29-29/32) × 3 + (36-5/8 × 66-17/32 × 29-29/32) × 1	(48-13/16 × 66-17/32 × 29-29/32) × 3 + (36-5/8 × 66-17/32 × 29-29/32) × 1
Weight	Net	kg	(268) + (268) + (205) + (172)	(268) + (268) + (230) + (172)
		lbs	(580) + (580) + (448) + (373)	(580) + (580) + (492) + (373)
	Shipping	kg	(285) + (285) + (222) + (184)	(285) + (285) + (247) + (184)
		lbs	(628) + (628) + (489) + (406)	(628) + (628) + (545) + (406)
Sound Pressure Level	Cooling	dB(A)	69.2	69.4
	Heating	dB(A)	70.9	71.4
Sound Power Level	Cooling	dB(A)	91.9	92.2
	Heating	dB(A)	93.8	94.0

Note

- Due to our policy of innovation some specifications may be changed without notification.
- Wiring cable size must comply with the applicable local and national codes. And "Electric characteristics" chapter should be considered for electrical work and design. Especially the power cable and circuit breaker should be selected in accordance with that.
- Power factor could vary less than ±1% according to the operating conditions.
- Sound pressure level is measured on the rated condition in the anechoic rooms by ISO 3745 standard.
Sound power level is measured on the rated condition in the reverberation rooms by ISO 9614 standard.
Therefore, these values can be increased owing to ambient conditions during operation.
- Sound values of combination model are calculated values based on sound results of independent models.
Sound values can be increased owing to ambient or installation conditions during operation.
Sound values of system [dB(A)] = 10*log [10^{A1}/10 + ... + 10^{An}/10], A1~An means sound values of independent models.
- Performances are based on the following conditions :
 - *Cooling : Indoor Ambient Temp. 27°CDB / 19°CWB, Outdoor Ambient Temp. 35°CDB / 24°CWB
 - *Heating : Indoor Ambient Temp. 20°CDB / 15°CWB, Outdoor Ambient Temp. 7°CDB / 6°CWB
 - Interconnected Pipe Length is 7.5m and difference of Elevation (Outdoor ~ Indoor Unit) is 0m.
- *** : The number in parentheses means maximum connectable indoor units in accordance with outdoor units combination (160~200%).
The recommended ratio is 130%.
- This product contains Fluorinated greenhouse gases.(R410A, GWP(Global warming potential) = 2,087.5)

1. Specifications

HP		80	82
Model Name	Combination Unit	A(C)RUN800LLS5	A(C)RUN820LLS5
	Independent Unit	A(C)RUN260LLS5	A(C)RUN260LLS5
		A(C)RUN260LLS5	A(C)RUN260LLS5
		A(C)RUN160LLS5	A(C)RUN180LLS5
		A(C)RUN120LLS5	A(C)RUN120LLS5
Protection Devices	High pressure protection	High pressure sensor / High pressure switch	
	Compressor/Fan	Over-heat protection / Fan driver overload protector	
	Inverter	Over-heat protection / Over-current protection	
Communication Cable		No. × mm ² (VCTF-SB)	2C × 1.0 ~ 1.5
Refrigerant	Refrigerant name		R410A
	Precharged Amount	kg	33.2
		lbs	73.2
	GWP		2087.5
	TCO ₂ eq		69.3
Control		Electronic Expansion Valve	
Power Supply		∅, V, Hz	380~415, 3, 50
			380, 3, 60
Number of maximum connectable indoor units***			64

Note

- Due to our policy of innovation some specifications may be changed without notification.
- Wiring cable size must comply with the applicable local and national codes. And "Electric characteristics" chapter should be considered for electrical work and design. Especially the power cable and circuit breaker should be selected in accordance with that.
- Power factor could vary less than ±1% according to the operating conditions.
- Sound pressure level is measured on the rated condition in the anechoic rooms by ISO 3745 standard.
Sound power level is measured on the rated condition in the reverberation rooms by ISO 9614 standard.
Therefore, these values can be increased owing to ambient conditions during operation.
- Sound values of combination model are calculated values based on sound results of independent models.
Sound values can be increased owing to ambient or installation conditions during operation.
Sound values of system [dB(A)] = $10 \cdot \log [10^{A1/10} + \dots + 10^{An/10}]$, A1~An means sound values of independent models.
- Performances are based on the following conditions :
 - *Cooling : Indoor Ambient Temp. 27°CDB / 19°CWB, Outdoor Ambient Temp. 35°CDB / 24°CWB
 - *Heating : Indoor Ambient Temp. 20°CDB / 15°CWB, Outdoor Ambient Temp. 7°CDB / 6°CWB
 - Interconnected Pipe Length is 7.5m and difference of Elevation (Outdoor ~ Indoor Unit) is 0m.
- *** : The number in parentheses means maximum connectable indoor units in accordance with outdoor units combination (160~200%).
The recommended ratio is 130%.
- This product contains Fluorinated greenhouse gases.(R410A, GWP(Global warming potential) = 2,087.5)

1. Specifications

HP			84	86
Model Name	Combination Unit		A(C)RUN840LLS5	A(C)RUN860LLS5
	Independent Unit		A(C)RUN260LLS5	A(C)RUN260LLS5
			A(C)RUN260LLS5	A(C)RUN260LLS5
			A(C)RUN200LLS5	A(C)RUN220LLS5
			A(C)RUN120LLS5	A(C)RUN120LLS5
Capacity	Cooling(Rated)	kW	235.2	240.8
		kcal/h	202,300	207,100
		Btu/h	802,500	821,600
	Heating(Rated)	kW	235.2	240.8
		kcal/h	202,300	207,100
		Btu/h	802,500	821,600
Input (Rated)	Cooling	kW	64.6	67.3
	Heating	kW	64.6	67.9
EER (Rated)			3.64	3.58
COP (Rated)			3.64	3.55
Power Factor	Rated	-	0.93	0.93
Exterior	Casing Color		Morning Gray / Dawn Gray	Morning Gray / Dawn Gray
	RAL code		RAL 7038 / RAL 7037	RAL 7038 / RAL 7037
Heat Exchanger			Wide Louver Plus	Wide Louver Plus
Compressor	Type		Hermetically Sealed Scroll	Hermetically Sealed Scroll
	Piston Displacement	cm ³ /rev	(62.1 x 5) + (87.6)	(62.1 x 5) + (87.6)
	Number of Revolution	rev/min	3,600 x 6	3,600 x 6
	Motor Output x Number	W x No.	(5,300 x 5) + (7,500 x 1)	(5,300 x 5) + (7,500 x 1)
	Starting Method		Inverter	Inverter
Oil Type		FW68D(PVE)	FW68D(PVE)	
Fan	Type		Propeller fan	Propeller fan
	Motor Output x Number	W	(900 x 6) + (1,200 x 1)	(900 x 6) + (1,200 x 1)
	Air Flow Rate(High)	m ³ /min	(320 x 3) + (240 x 1)	(320 x 3) + (240 x 1)
		ft ³ /min	(11,301 x 3) + (8,476 x 1)	(11,301 x 3) + (8,476 x 1)
	Drive		DC INVERTER	DC INVERTER
Discharge		Side / Top	TOP	TOP
Pipe Connections	Liquid Pipe	mm(inch)	22.2(7/8)	22.2(7/8)
	Gas Pipe	mm(inch)	53.98(2-1/8)	53.98(2-1/8)
Dimensions(W x H x D)		mm	(1,240 x 1,690 x 760) x 3 + (930 x 1,690 x 760) x 1	(1,240 x 1,690 x 760) x 3 + (930 x 1,690 x 760) x 1
		inch	(48-13/16 x 66-17/32 x 29-29/32) x 3 + (36-5/8 x 66-17/32 x 29-29/32) x 1	(48-13/16 x 66-17/32 x 29-29/32) x 3 + (36-5/8 x 66-17/32 x 29-29/32) x 1
Weight	Net	kg	(268) + (268) + (230) + (172)	(268) + (268) + (230) + (172)
		lbs	(580) + (580) + (492) + (373)	(580) + (580) + (492) + (373)
	Shipping	kg	(285) + (285) + (247) + (184)	(285) + (285) + (247) + (184)
		lbs	(628) + (628) + (545) + (406)	(628) + (628) + (545) + (406)
Sound Pressure Level	Cooling	dB(A)	69.6	69.8
	Heating	dB(A)	71.8	72.1
Sound Power Level	Cooling	dB(A)	92.4	92.7
	Heating	dB(A)	94.6	94.9

Note

- Due to our policy of innovation some specifications may be changed without notification.
- Wiring cable size must comply with the applicable local and national codes. And "Electric characteristics" chapter should be considered for electrical work and design. Especially the power cable and circuit breaker should be selected in accordance with that.
- Power factor could vary less than ±1% according to the operating conditions.
- Sound pressure level is measured on the rated condition in the anechoic rooms by ISO 3745 standard.
Sound power level is measured on the rated condition in the reverberation rooms by ISO 9614 standard.
Therefore, these values can be increased owing to ambient conditions during operation.
- Sound values of combination model are calculated values based on sound results of independent models.
Sound values can be increased owing to ambient or installation conditions during operation.
Sound values of system [dB(A)] = 10*log [10^{A1}/10 + ... + 10^{An}/10], A1~An means sound values of independent models.
- Performances are based on the following conditions :
 - *Cooling : Indoor Ambient Temp. 27°CDB / 19°CWB, Outdoor Ambient Temp. 35°CDB / 24°CWB
 - *Heating : Indoor Ambient Temp. 20°CDB / 15°CWB, Outdoor Ambient Temp. 7°CDB / 6°CWB
 - Interconnected Pipe Length is 7.5m and difference of Elevation (Outdoor ~ Indoor Unit) is 0m.
- *** : The number in parentheses means maximum connectable indoor units in accordance with outdoor units combination (160~200%).
The recommended ratio is 130%.
- This product contains Fluorinated greenhouse gases.(R410A, GWP(Global warming potential) = 2,087.5)

1. Specifications

HP		84	86
Model Name	Combination Unit	A(C)RUN840LLS5	A(C)RUN860LLS5
	Independent Unit	A(C)RUN260LLS5	A(C)RUN260LLS5
		A(C)RUN260LLS5	A(C)RUN260LLS5
		A(C)RUN200LLS5	A(C)RUN220LLS5
		A(C)RUN120LLS5	A(C)RUN120LLS5
Protection Devices	High pressure protection	High pressure sensor / High pressure switch	
	Compressor/Fan	Over-heat protection / Fan driver overload protector	
	Inverter	Over-heat protection / Over-current protection	
Communication Cable		No. × mm ² (VCTF-SB)	2C × 1.0 ~ 1.5
Refrigerant	Refrigerant name		R410A
	Precharged Amount	kg	34.2
		lbs	75.4
	GWP		2087.5
	TCO ₂ eq		71.4
Control		Electronic Expansion Valve	
Power Supply		∅, V, Hz	380~415, 3, 50
			380, 3, 60
Number of maximum connectable indoor units***			64

Note

- Due to our policy of innovation some specifications may be changed without notification.
- Wiring cable size must comply with the applicable local and national codes. And "Electric characteristics" chapter should be considered for electrical work and design. Especially the power cable and circuit breaker should be selected in accordance with that.
- Power factor could vary less than ±1% according to the operating conditions.
- Sound pressure level is measured on the rated condition in the anechoic rooms by ISO 3745 standard.
Sound power level is measured on the rated condition in the reverberation rooms by ISO 9614 standard.
Therefore, these values can be increased owing to ambient conditions during operation.
- Sound values of combination model are calculated values based on sound results of independent models.
Sound values can be increased owing to ambient or installation conditions during operation.
Sound values of system [dB(A)] = 10*log [10^{A1/10}+ ... +10^{An/10}], A1~An means sound values of independent models.
- Performances are based on the following conditions :
 - *Cooling : Indoor Ambient Temp. 27°CDB / 19°CWB, Outdoor Ambient Temp. 35°CDB / 24°CWB
 - *Heating : Indoor Ambient Temp. 20°CDB / 15°CWB, Outdoor Ambient Temp. 7°CDB / 6°CWB
 - Interconnected Pipe Length is 7.5m and difference of Elevation (Outdoor ~ Indoor Unit) is 0m.
- *** : The number in parentheses means maximum connectable indoor units in accordance with outdoor units combination (160~200%).
The recommended ratio is 130%.
- This product contains Fluorinated greenhouse gases.(R410A, GWP(Global warming potential) = 2,087.5)

1. Specifications

HP			88	90
Model Name	Combination Unit		A(C)RUN880LLS5	A(C)RUN900LLS5
	Independent Unit		A(C)RUN260LLS5	A(C)RUN260LLS5
			A(C)RUN260LLS5	A(C)RUN260LLS5
			A(C)RUN240LLS5	A(C)RUN260LLS5
			A(C)RUN120LLS5	A(C)RUN120LLS5
Capacity	Cooling(Rated)	kW	246.4	252.0
		kcal/h	211,900	216,700
		Btu/h	840,700	859,800
	Heating(Rated)	kW	246.4	252.0
		kcal/h	211,900	216,700
		Btu/h	840,700	859,800
Input (Rated)	Cooling	kW	68.7	71.3
	Heating	kW	68.0	70.6
EER (Rated)			3.59	3.53
COP (Rated)			3.62	3.57
Power Factor	Rated	-	0.93	0.93
Exterior	Casing Color		Morning Gray / Dawn Gray	Morning Gray / Dawn Gray
	RAL code		RAL 7038 / RAL 7037	RAL 7038 / RAL 7037
Heat Exchanger			Wide Louver Plus	Wide Louver Plus
Compressor	Type		Hermetically Sealed Scroll	Hermetically Sealed Scroll
	Piston Displacement	cm ³ /rev	62.1 × 7	62.1 × 7
	Number of Revolution	rev/min	3,600 × 7	3,600 × 7
	Motor Output × Number	W × No.	5,300 × 7	5,300 × 7
	Starting Method		Inverter	Inverter
Oil Type		FW68D(PVE)	FW68D(PVE)	
Fan	Type		Propeller fan	Propeller fan
	Motor Output × Number	W	(900 × 6) + (1,200 × 1)	(900 × 6) + (1,200 × 1)
	Air Flow Rate(High)	m ³ /min	(320 × 3) + (240 × 1)	(320 × 3) + (240 × 1)
		ft ³ /min	(11,301 × 3) + (8,476 × 1)	(11,301 × 3) + (8,476 × 1)
	Drive		DC INVERTER	DC INVERTER
Discharge		Side / Top	TOP	
Pipe Connections	Liquid Pipe	mm(inch)	22.2(7/8)	22.2(7/8)
	Gas Pipe	mm(inch)	53.98(2-1/8)	53.98(2-1/8)
Dimensions(W × H × D)		mm	(1,240 × 1,690 × 760) × 3 + (930 × 1,690 × 760) × 1	(1,240 × 1,690 × 760) × 3 + (930 × 1,690 × 760) × 1
		inch	(48-13/16 × 66-17/32 × 29-29/32) × 3 + (36-5/8 × 66-17/32 × 29-29/32) × 1	(48-13/16 × 66-17/32 × 29-29/32) × 3 + (36-5/8 × 66-17/32 × 29-29/32) × 1
Weight	Net	kg	(268) + (268) + (268) + (172)	(268) + (268) + (268) + (172)
		lbs	(580) + (580) + (580) + (373)	(580) + (580) + (580) + (373)
	Shipping	kg	(285) + (285) + (285) + (184)	(285) + (285) + (285) + (184)
		lbs	(628) + (628) + (628) + (406)	(628) + (628) + (628) + (406)
Sound Pressure Level	Cooling	dB(A)	70.1	70.1
	Heating	dB(A)	72.1	72.1
Sound Power Level	Cooling	dB(A)	92.9	92.9
	Heating	dB(A)	94.9	94.9

Note

- Due to our policy of innovation some specifications may be changed without notification.
- Wiring cable size must comply with the applicable local and national codes. And "Electric characteristics" chapter should be considered for electrical work and design. Especially the power cable and circuit breaker should be selected in accordance with that.
- Power factor could vary less than ±1% according to the operating conditions.
- Sound pressure level is measured on the rated condition in the anechoic rooms by ISO 3745 standard.
Sound power level is measured on the rated condition in the reverberation rooms by ISO 9614 standard.
Therefore, these values can be increased owing to ambient conditions during operation.
- Sound values of combination model are calculated values based on sound results of independent models.
Sound values can be increased owing to ambient or installation conditions during operation.
Sound values of system [dB(A)] = 10*log [10^{A1}/10 + ... + 10^{An}/10], A1~An means sound values of independent models.
- Performances are based on the following conditions :
 - *Cooling : Indoor Ambient Temp. 27°CDB / 19°CWB, Outdoor Ambient Temp. 35°CDB / 24°CWB
 - *Heating : Indoor Ambient Temp. 20°CDB / 15°CWB, Outdoor Ambient Temp. 7°CDB / 6°CWB
 - Interconnected Pipe Length is 7.5m and difference of Elevation (Outdoor ~ Indoor Unit) is 0m.
- *** : The number in parentheses means maximum connectable indoor units in accordance with outdoor units combination (160~200%).
The recommended ratio is 130%.
- This product contains Fluorinated greenhouse gases.(R410A, GWP(Global warming potential) = 2,087.5)

1. Specifications

HP		88	90
Model Name	Combination Unit	A(C)RUN880LLS5	A(C)RUN900LLS5
	Independent Unit	A(C)RUN260LLS5	A(C)RUN260LLS5
		A(C)RUN260LLS5	A(C)RUN260LLS5
		A(C)RUN240LLS5	A(C)RUN260LLS5
		A(C)RUN120LLS5	A(C)RUN120LLS5
Protection Devices	High pressure protection	High pressure sensor / High pressure switch	
	Compressor/Fan	Over-heat protection / Fan driver overload protector	
	Inverter	Over-heat protection / Over-current protection	
Communication Cable		No. × mm ² (VCTF-SB)	2C × 1.0 ~ 1.5
Refrigerant	Refrigerant name		R410A
	Precharged Amount	kg	37.7
		lbs	83.1
	GWP		2087.5
	TCO ₂ eq		78.7
Control		Electronic Expansion Valve	Electronic Expansion Valve
Power Supply		∅, V, Hz	380~415, 3, 50
			380, 3, 60
Number of maximum connectable indoor units***			64

Note

- Due to our policy of innovation some specifications may be changed without notification.
- Wiring cable size must comply with the applicable local and national codes. And "Electric characteristics" chapter should be considered for electrical work and design. Especially the power cable and circuit breaker should be selected in accordance with that.
- Power factor could vary less than ±1% according to the operating conditions.
- Sound pressure level is measured on the rated condition in the anechoic rooms by ISO 3745 standard.
Sound power level is measured on the rated condition in the reverberation rooms by ISO 9614 standard.
Therefore, these values can be increased owing to ambient conditions during operation.
- Sound values of combination model are calculated values based on sound results of independent models.
Sound values can be increased owing to ambient or installation conditions during operation.
Sound values of system [dB(A)] = $10 \cdot \log [10^{A1/10} + \dots + 10^{An/10}]$, A1~An means sound values of independent models.
- Performances are based on the following conditions :
 - *Cooling : Indoor Ambient Temp. 27°CDB / 19°CWB, Outdoor Ambient Temp. 35°CDB / 24°CWB
 - *Heating : Indoor Ambient Temp. 20°CDB / 15°CWB, Outdoor Ambient Temp. 7°CDB / 6°CWB
 - Interconnected Pipe Length is 7.5m and difference of Elevation (Outdoor ~ Indoor Unit) is 0m.
- *** : The number in parentheses means maximum connectable indoor units in accordance with outdoor units combination (160~200%).
The recommended ratio is 130%.
- This product contains Fluorinated greenhouse gases.(R410A, GWP(Global warming potential) = 2,087.5)

1. Specifications

HP			92	94
Model Name	Combination Unit		A(C)RUN920LLS5	A(C)RUN940LLS5
	Independent Unit		A(C)RUN260LLS5	A(C)RUN260LLS5
			A(C)RUN260LLS5	A(C)RUN260LLS5
			A(C)RUN260LLS5	A(C)RUN260LLS5
			A(C)RUN140LLS5	A(C)RUN160LLS5
Capacity	Cooling(Rated)	kW	257.6	263.2
		kcal/h	221,500	226,300
		Btu/h	879,000	898,100
	Heating(Rated)	kW	257.6	263.2
		kcal/h	221,500	226,300
		Btu/h	879,000	898,100
Input (Rated)	Cooling	kW	73.0	74.3
	Heating	kW	73.1	73.6
EER (Rated)			3.53	3.54
COP (Rated)			3.52	3.58
Power Factor	Rated	-	0.93	0.93
Exterior	Casing Color		Morning Gray / Dawn Gray	Morning Gray / Dawn Gray
	RAL code		RAL 7038 / RAL 7037	RAL 7038 / RAL 7037
Heat Exchanger			Wide Louver Plus	Wide Louver Plus
Compressor	Type		Hermetically Sealed Scroll	Hermetically Sealed Scroll
	Piston Displacement	cm ³ /rev	62.1 × 7	62.1 × 7
	Number of Revolution	rev/min	3,600 × 7	3,600 × 7
	Motor Output × Number	W × No.	5,300 × 7	5,300 × 7
	Starting Method		Inverter	Inverter
Oil Type		FW68D(PVE)	FW68D(PVE)	
Fan	Type		Propeller fan	Propeller fan
	Motor Output × Number	W	(900 × 6) + (1,200 × 1)	900 × 8
	Air Flow Rate(High)	m ³ /min	(320 × 3) + (240 × 1)	320 × 4
		ft ³ /min	(11,301 × 3) + (8,476 × 1)	11,301 × 4
	Drive		DC INVERTER	DC INVERTER
Discharge		Side / Top	TOP	
Pipe Connections	Liquid Pipe	mm(inch)	22.2(7/8)	22.2(7/8)
	Gas Pipe	mm(inch)	53.98(2-1/8)	53.98(2-1/8)
Dimensions(W × H × D)		mm	(1,240 × 1,690 × 760) × 3 + (930 × 1,690 × 760) × 1	(1,240 × 1,690 × 760) × 4
		inch	(48-13/16 × 66-17/32 × 29-29/32) × 3 + (36-5/8 × 66-17/32 × 29-29/32) × 1	(48-13/16 × 66-17/32 × 29-29/32) × 4
Weight	Net	kg	(268) + (268) + (268) + (184)	(268) + (268) + (268) + (205)
		lbs	(580) + (580) + (580) + (401)	(580) + (580) + (580) + (448)
	Shipping	kg	(285) + (285) + (285) + (196)	(285) + (285) + (285) + (222)
		lbs	(628) + (628) + (628) + (432)	(628) + (628) + (628) + (489)
Sound Pressure Level	Cooling	dB(A)	70.2	70.3
	Heating	dB(A)	72.1	72.2
Sound Power Level	Cooling	dB(A)	93.1	93.2
	Heating	dB(A)	95.1	95.2

Note

- Due to our policy of innovation some specifications may be changed without notification.
- Wiring cable size must comply with the applicable local and national codes. And "Electric characteristics" chapter should be considered for electrical work and design. Especially the power cable and circuit breaker should be selected in accordance with that.
- Power factor could vary less than ±1% according to the operating conditions.
- Sound pressure level is measured on the rated condition in the anechoic rooms by ISO 3745 standard.
Sound power level is measured on the rated condition in the reverberation rooms by ISO 9614 standard.
Therefore, these values can be increased owing to ambient conditions during operation.
- Sound values of combination model are calculated values based on sound results of independent models.
Sound values can be increased owing to ambient or installation conditions during operation.
Sound values of system [dB(A)] = 10*log [10^{A1}/10 + ... + 10^{An}/10], A1~An means sound values of independent models.
- Performances are based on the following conditions :
 - *Cooling : Indoor Ambient Temp. 27°CDB / 19°CWB, Outdoor Ambient Temp. 35°CDB / 24°CWB
 - *Heating : Indoor Ambient Temp. 20°CDB / 15°CWB, Outdoor Ambient Temp. 7°CDB / 6°CWB
 - Interconnected Pipe Length is 7.5m and difference of Elevation (Outdoor ~ Indoor Unit) is 0m.
- *** : The number in parentheses means maximum connectable indoor units in accordance with outdoor units combination (160~200%).
The recommended ratio is 130%.
- This product contains Fluorinated greenhouse gases.(R410A, GWP(Global warming potential) = 2,087.5)

1. Specifications

HP		92	94
Model Name	Combination Unit	A(C)RUN920LLS5	A(C)RUN940LLS5
	Independent Unit	A(C)RUN260LLS5	A(C)RUN260LLS5
		A(C)RUN260LLS5	A(C)RUN260LLS5
		A(C)RUN260LLS5	A(C)RUN260LLS5
		A(C)RUN140LLS5	A(C)RUN160LLS5
Protection Devices	High pressure protection	High pressure sensor / High pressure switch	
	Compressor/Fan	Over-heat protection / Fan driver overload protector	
	Inverter	Over-heat protection / Over-current protection	
Communication Cable		No. × mm ² (VCTF-SB)	2C × 1.0 ~ 1.5
Refrigerant	Refrigerant name		R410A
	Precharged Amount	kg	40.5
		lbs	89.3
	GWP		2087.5
	TCO ₂ eq		84.5
Control		Electronic Expansion Valve	Electronic Expansion Valve
Power Supply		∅, V, Hz	380~415, 3, 50
			380, 3, 60
Number of maximum connectable indoor units***			64
			64
Note			
1. Due to our policy of innovation some specifications may be changed without notification.			
2. Wiring cable size must comply with the applicable local and national codes. And "Electric characteristics" chapter should be considered for electrical work and design. Especially the power cable and circuit breaker should be selected in accordance with that.			
3. Power factor could vary less than ±1% according to the operating conditions.			
4. Sound pressure level is measured on the rated condition in the anechoic rooms by ISO 3745 standard. Sound power level is measured on the rated condition in the reverberation rooms by ISO 9614 standard. Therefore, these values can be increased owing to ambient conditions during operation.			
5. Sound values of combination model are calculated values based on sound results of independent models. Sound values can be increased owing to ambient or installation conditions during operation. Sound values of system [dB(A)] = 10*log [10 ^{A1/10} + ... +10 ^{An/10}], A1~An means sound values of independent models.			
6. Performances are based on the following conditions : • *Cooling : Indoor Ambient Temp. 27°CDB / 19°CWB, Outdoor Ambient Temp. 35°CDB / 24°CWB • *Heating : Indoor Ambient Temp. 20°CDB / 15°CWB, Outdoor Ambient Temp. 7°CDB / 6°CWB • Interconnected Pipe Length is 7.5m and difference of Elevation (Outdoor ~ Indoor Unit) is 0m.			
7. *** : The number in parentheses means maximum connectable indoor units in accordance with outdoor units combination (160~200%). The recommended ratio is 130%.			
8. This product contains Fluorinated greenhouse gases.(R410A, GWP(Global warming potential) = 2,087.5)			

1. Specifications

HP			96	98
Model Name	Combination Unit		A(C)RUN960LLS5	A(C)RUN980LLS5
	Independent Unit		A(C)RUN260LLS5	A(C)RUN260LLS5
			A(C)RUN260LLS5	A(C)RUN260LLS5
			A(C)RUN260LLS5	A(C)RUN260LLS5
			A(C)RUN180LLS5	A(C)RUN200LLS5
Capacity	Cooling(Rated)	kW	268.8	274.4
		kcal/h	231,100	236,000
		Btu/h	917,200	936,300
	Heating(Rated)	kW	268.8	274.4
		kcal/h	231,100	236,000
		Btu/h	917,200	936,300
Input (Rated)	Cooling	kW	74.7	76.5
	Heating	kW	73.6	76.0
EER (Rated)			3.60	3.59
COP (Rated)			3.65	3.61
Power Factor	Rated	-	0.93	0.93
Exterior	Casing Color		Morning Gray / Dawn Gray	Morning Gray / Dawn Gray
	RAL code		RAL 7038 / RAL 7037	RAL 7038 / RAL 7037
Heat Exchanger			Wide Louver Plus	Wide Louver Plus
Compressor	Type		Hermetically Sealed Scroll	Hermetically Sealed Scroll
	Piston Displacement	cm ³ /rev	(62.1 x 6) + (87.6)	(62.1 x 6) + (87.6)
	Number of Revolution	rev/min	3,600 x 7	3,600 x 7
	Motor Output x Number	W x No.	(5,300 x 6) + (7,500 x 1)	(5,300 x 6) + (7,500 x 1)
	Starting Method		Inverter	Inverter
Oil Type		FW68D(PVE)	FW68D(PVE)	
Fan	Type		Propeller fan	Propeller fan
	Motor Output x Number	W	900 x 8	900 x 8
	Air Flow Rate(High)	m ³ /min	320 x 4	320 x 4
		ft ³ /min	11,301 x 4	11,301 x 4
	Drive		DC INVERTER	DC INVERTER
Discharge		Side / Top	TOP	
Pipe Connections	Liquid Pipe	mm(inch)	22.2(7/8)	22.2(7/8)
	Gas Pipe	mm(inch)	53.98(2-1/8)	53.98(2-1/8)
Dimensions(W x H x D)		mm	(1,240 x 1,690 x 760) x 4	(1,240 x 1,690 x 760) x 4
		inch	(48-13/16 x 66-17/32 x 29-29/32) x 4	(48-13/16 x 66-17/32 x 29-29/32) x 4
Weight	Net	kg	(268) + (268) + (268) + (230)	(268) + (268) + (268) + (230)
		lbs	(580) + (580) + (580) + (492)	(580) + (580) + (580) + (492)
	Shipping	kg	(285) + (285) + (285) + (247)	(285) + (285) + (285) + (247)
		lbs	(628) + (628) + (628) + (545)	(628) + (628) + (628) + (545)
Sound Pressure Level	Cooling	dB(A)	70.4	70.6
	Heating	dB(A)	72.5	72.8
Sound Power Level	Cooling	dB(A)	93.4	93.6
	Heating	dB(A)	95.3	95.8

Note

- Due to our policy of innovation some specifications may be changed without notification.
- Wiring cable size must comply with the applicable local and national codes. And "Electric characteristics" chapter should be considered for electrical work and design. Especially the power cable and circuit breaker should be selected in accordance with that.
- Power factor could vary less than $\pm 1\%$ according to the operating conditions.
- Sound pressure level is measured on the rated condition in the anechoic rooms by ISO 3745 standard.
Sound power level is measured on the rated condition in the reverberation rooms by ISO 9614 standard.
Therefore, these values can be increased owing to ambient conditions during operation.
- Sound values of combination model are calculated values based on sound results of independent models.
Sound values can be increased owing to ambient or installation conditions during operation.
Sound values of system [dB(A)] = $10 \times \log [10^{(A1/10)} + \dots + 10^{(An/10)}]$, A1~An means sound values of independent models.
- Performances are based on the following conditions :
 - *Cooling : Indoor Ambient Temp. 27°CDB / 19°CWB, Outdoor Ambient Temp. 35°CDB / 24°CWB
 - *Heating : Indoor Ambient Temp. 20°CDB / 15°CWB, Outdoor Ambient Temp. 7°CDB / 6°CWB
 - Interconnected Pipe Length is 7.5m and difference of Elevation (Outdoor ~ Indoor Unit) is 0m.
- *** : The number in parentheses means maximum connectable indoor units in accordance with outdoor units combination (160~200%).
The recommended ratio is 130%.
- This product contains Fluorinated greenhouse gases.(R410A, GWP(Global warming potential) = 2,087.5)

1. Specifications

HP		96	98
Model Name	Combination Unit	A(C)RUN960LLS5	A(C)RUN980LLS5
	Independent Unit	A(C)RUN260LLS5	A(C)RUN260LLS5
		A(C)RUN260LLS5	A(C)RUN260LLS5
		A(C)RUN260LLS5	A(C)RUN260LLS5
		A(C)RUN180LLS5	A(C)RUN200LLS5
Protection Devices	High pressure protection	High pressure sensor / High pressure switch	
	Compressor/Fan	Over-heat protection / Fan driver overload protector	
	Inverter	Over-heat protection / Over-current protection	
Communication Cable		No. × mm ² (VCTF-SB)	2C × 1.0 ~ 1.5
Refrigerant	Refrigerant name		R410A
	Precharged Amount	kg	40.5
		lbs	89.3
	GWP		2087.5
	TCO ₂ eq		84.5
Control		Electronic Expansion Valve	
Power Supply		∅, V, Hz	380~415, 3, 50
			380, 3, 60
Number of maximum connectable indoor units***			64

Note

- Due to our policy of innovation some specifications may be changed without notification.
- Wiring cable size must comply with the applicable local and national codes. And "Electric characteristics" chapter should be considered for electrical work and design. Especially the power cable and circuit breaker should be selected in accordance with that.
- Power factor could vary less than ±1% according to the operating conditions.
- Sound pressure level is measured on the rated condition in the anechoic rooms by ISO 3745 standard.
Sound power level is measured on the rated condition in the reverberation rooms by ISO 9614 standard.
Therefore, these values can be increased owing to ambient conditions during operation.
- Sound values of combination model are calculated values based on sound results of independent models.
Sound values can be increased owing to ambient or installation conditions during operation.
Sound values of system [dB(A)] = $10 \cdot \log [10^{A1/10} + \dots + 10^{An/10}]$, A1~An means sound values of independent models.
- Performances are based on the following conditions :
 - *Cooling : Indoor Ambient Temp. 27°CDB / 19°CWB, Outdoor Ambient Temp. 35°CDB / 24°CWB
 - *Heating : Indoor Ambient Temp. 20°CDB / 15°CWB, Outdoor Ambient Temp. 7°CDB / 6°CWB
 - Interconnected Pipe Length is 7.5m and difference of Elevation (Outdoor ~ Indoor Unit) is 0m.
- *** : The number in parentheses means maximum connectable indoor units in accordance with outdoor units combination (160~200%).
The recommended ratio is 130%.
- This product contains Fluorinated greenhouse gases.(R410A, GWP(Global warming potential) = 2,087.5)

1. Specifications

HP			100	102
Model Name	Combination Unit		A(C)RUN1000LLS5	A(C)RUN1020LLS5
	Independent Unit		A(C)RUN260LLS5	A(C)RUN260LLS5
			A(C)RUN260LLS5	A(C)RUN260LLS5
			A(C)RUN260LLS5	A(C)RUN260LLS5
			A(C)RUN220LLS5	A(C)RUN240LLS5
Capacity	Cooling(Rated)	kW	280.0	285.6
		kcal/h	240,800	245,600
		Btu/h	955,400	974,500
	Heating(Rated)	kW	280.0	285.6
		kcal/h	240,800	245,600
		Btu/h	955,400	974,500
Input (Rated)	Cooling	kW	79.2	80.6
	Heating	kW	79.3	79.4
EER (Rated)			3.54	3.54
COP (Rated)			3.53	3.60
Power Factor	Rated	-	0.93	0.93
Exterior	Casing Color		Morning Gray / Dawn Gray	Morning Gray / Dawn Gray
	RAL code		RAL 7038 / RAL 7037	RAL 7038 / RAL 7037
Heat Exchanger			Wide Louver Plus	Wide Louver Plus
Compressor	Type		Hermetically Sealed Scroll	Hermetically Sealed Scroll
	Piston Displacement	cm ³ /rev	(62.1 x 6) + (87.6)	62.1 x 8
	Number of Revolution	rev/min	3,600 x 7	3,600 x 8
	Motor Output x Number	W x No.	(5,300 x 6) + (7,500 x 1)	5,300 x 8
	Starting Method		Inverter	Inverter
Oil Type		FW68D(PVE)	FW68D(PVE)	
Fan	Type		Propeller fan	Propeller fan
	Motor Output x Number	W	900 x 8	900 x 8
	Air Flow Rate(High)	m ³ /min	320 x 4	320 x 4
		ft ³ /min	11,301 x 4	11,301 x 4
	Drive		DC INVERTER	DC INVERTER
Discharge		Side / Top	TOP	
Pipe Connections	Liquid Pipe	mm(inch)	22.2(7/8)	22.2(7/8)
	Gas Pipe	mm(inch)	53.98(2-1/8)	53.98(2-1/8)
Dimensions(W x H x D)		mm	(1,240 x 1,690 x 760) x 4	(1,240 x 1,690 x 760) x 4
		inch	(48-13/16 x 66-17/32 x 29-29/32) x 4	(48-13/16 x 66-17/32 x 29-29/32) x 4
Weight	Net	kg	(268) + (268) + (268) + (230)	(268) + (268) + (268) + (268)
		lbs	(580) + (580) + (580) + (492)	(580) + (580) + (580) + (580)
	Shipping	kg	(285) + (285) + (285) + (247)	(285) + (285) + (285) + (285)
		lbs	(628) + (628) + (628) + (545)	(628) + (628) + (628) + (628)
Sound Pressure Level	Cooling	dB(A)	70.8	71.0
	Heating	dB(A)	73.0	73.0
Sound Power Level	Cooling	dB(A)	93.8	94.0
	Heating	dB(A)	96.0	96.0

Note

- Due to our policy of innovation some specifications may be changed without notification.
- Wiring cable size must comply with the applicable local and national codes. And "Electric characteristics" chapter should be considered for electrical work and design. Especially the power cable and circuit breaker should be selected in accordance with that.
- Power factor could vary less than ±1% according to the operating conditions.
- Sound pressure level is measured on the rated condition in the anechoic rooms by ISO 3745 standard.
Sound power level is measured on the rated condition in the reverberation rooms by ISO 9614 standard.
Therefore, these values can be increased owing to ambient conditions during operation.
- Sound values of combination model are calculated values based on sound results of independent models.
Sound values can be increased owing to ambient or installation conditions during operation.
Sound values of system [dB(A)] = 10*log [10^{A1}(A1/10)+ ... +10^{An}(An/10)] , A1~An means sound values of independent models.
- Performances are based on the following conditions :
 - *Cooling : Indoor Ambient Temp. 27°CDB / 19°CWB, Outdoor Ambient Temp. 35°CDB / 24°CWB
 - *Heating : Indoor Ambient Temp. 20°CDB / 15°CWB, Outdoor Ambient Temp. 7°CDB / 6°CWB
 - Interconnected Pipe Length is 7.5m and difference of Elevation (Outdoor ~ Indoor Unit) is 0m.
- *** : The number in parentheses means maximum connectable indoor units in accordance with outdoor units combination (160~200%).
The recommended ratio is 130%.
- This product contains Fluorinated greenhouse gases.(R410A, GWP(Global warming potential) = 2,087.5)

1. Specifications

HP		100	102
Model Name	Combination Unit	A(C)RUN1000LLS5	A(C)RUN1020LLS5
	Independent Unit	A(C)RUN260LLS5	A(C)RUN260LLS5
		A(C)RUN260LLS5	A(C)RUN260LLS5
		A(C)RUN260LLS5	A(C)RUN260LLS5
		A(C)RUN220LLS5	A(C)RUN240LLS5
Protection Devices	High pressure protection	High pressure sensor / High pressure switch	
	Compressor/Fan	Over-heat protection / Fan driver overload protector	
	Inverter	Over-heat protection / Over-current protection	
Communication Cable		No. × mm ² (VCTF-SB)	2C × 1.0 ~ 1.5
Refrigerant	Refrigerant name		R410A
	Precharged Amount	kg	40.5
		lbs	89.3
	GWP		2087.5
	TCO ₂ eq		84.5
Control		Electronic Expansion Valve	
Power Supply		∅, V, Hz	380~415, 3, 50
			380, 3, 60
Number of maximum connectable indoor units***			64

Note

- Due to our policy of innovation some specifications may be changed without notification.
- Wiring cable size must comply with the applicable local and national codes. And "Electric characteristics" chapter should be considered for electrical work and design. Especially the power cable and circuit breaker should be selected in accordance with that.
- Power factor could vary less than ±1% according to the operating conditions.
- Sound pressure level is measured on the rated condition in the anechoic rooms by ISO 3745 standard.
Sound power level is measured on the rated condition in the reverberation rooms by ISO 9614 standard.
Therefore, these values can be increased owing to ambient conditions during operation.
- Sound values of combination model are calculated values based on sound results of independent models.
Sound values can be increased owing to ambient or installation conditions during operation.
Sound values of system [dB(A)] = $10 \cdot \log [10^{A1/10} + \dots + 10^{An/10}]$, A1~An means sound values of independent models.
- Performances are based on the following conditions :
 - *Cooling : Indoor Ambient Temp. 27°CDB / 19°CWB, Outdoor Ambient Temp. 35°CDB / 24°CWB
 - *Heating : Indoor Ambient Temp. 20°CDB / 15°CWB, Outdoor Ambient Temp. 7°CDB / 6°CWB
 - Interconnected Pipe Length is 7.5m and difference of Elevation (Outdoor ~ Indoor Unit) is 0m.
- *** : The number in parentheses means maximum connectable indoor units in accordance with outdoor units combination (160~200%).
The recommended ratio is 130%.
- This product contains Fluorinated greenhouse gases.(R410A, GWP(Global warming potential) = 2,087.5)

1. Specifications

HP			104
Model Name	Combination Unit		A(C)RUN1040LLS5
	Independent Unit		A(C)RUN260LLS5
			A(C)RUN260LLS5
			A(C)RUN260LLS5
			A(C)RUN260LLS5
Capacity	Cooling(Rated)	kW	291.2
		kcal/h	250,400
		Btu/h	993,600
	Heating(Rated)	kW	291.2
		kcal/h	250,400
		Btu/h	993,600
Input (Rated)	Cooling	kW	83.2
	Heating	kW	82.0
EER (Rated)			3.50
COP (Rated)			3.55
Power Factor	Rated	-	0.93
Exterior	Casing Color		Morning Gray / Dawn Gray
	RAL code		RAL 7038 / RAL 7037
Heat Exchanger			Wide Louver Plus
Compressor	Type		Hermetically Sealed Scroll
	Piston Displacement	cm ³ /rev	62.1 × 8
	Number of Revolution	rev/min	3,600 × 8
	Motor Output × Number	W × No.	5,300 × 8
	Starting Method		Inverter
Oil Type		FW68D(PVE)	
Fan	Type		Propeller fan
	Motor Output × Number	W	900 × 8
	Air Flow Rate(High)	m ³ /min	320 × 4
		ft ³ /min	11,301 × 4
	Drive		DC INVERTER
Discharge		Side / Top	
Pipe Connections	Liquid Pipe	mm(inch)	22.2(7/8)
	Gas Pipe	mm(inch)	53.98(2-1/8)
Dimensions(W × H × D)	mm		(1,240 × 1,690 × 760) × 4
	inch		(48-13/16 × 66-17/32 × 29-29/32) × 4
Weight	Net	kg	(268) + (268) + (268) + (268)
		lbs	(580) + (580) + (580) + (580)
	Shipping	kg	(285) + (285) + (285) + (285)
		lbs	(628) + (628) + (628) + (628)
Sound Pressure Level	Cooling	dB(A)	71.0
	Heating	dB(A)	73.0
Sound Power Level	Cooling	dB(A)	94.0
	Heating	dB(A)	96.0

Note

- Due to our policy of innovation some specifications may be changed without notification.
- Wiring cable size must comply with the applicable local and national codes. And "Electric characteristics" chapter should be considered for electrical work and design. Especially the power cable and circuit breaker should be selected in accordance with that.
- Power factor could vary less than ±1% according to the operating conditions.
- Sound pressure level is measured on the rated condition in the anechoic rooms by ISO 3745 standard.
Sound power level is measured on the rated condition in the reverberation rooms by ISO 9614 standard.
Therefore, these values can be increased owing to ambient conditions during operation.
- Sound values of combination model are calculated values based on sound results of independent models.
Sound values can be increased owing to ambient or installation conditions during operation.
Sound values of system [dB(A)] = 10*log [10^{A1}(A1/10)+ ... +10^{An}(An/10)] , A1~An means sound values of independent models.
- Performances are based on the following conditions :
 - *Cooling : Indoor Ambient Temp. 27°CDB / 19°CWB, Outdoor Ambient Temp. 35°CDB / 24°CWB
 - *Heating : Indoor Ambient Temp. 20°CDB / 15°CWB, Outdoor Ambient Temp. 7°CDB / 6°CWB
 - Interconnected Pipe Length is 7.5m and difference of Elevation (Outdoor ~ Indoor Unit) is 0m.
- *** : The number in parentheses means maximum connectable indoor units in accordance with outdoor units combination (160~200%).
The recommended ratio is 130%.
- This product contains Fluorinated greenhouse gases.(R410A, GWP(Global warming potential) = 2,087.5)

1. Specifications

HP		104	
Model Name	Combination Unit		A(C)RUN1040LLS5
	Independent Unit		A(C)RUN260LLS5
			A(C)RUN260LLS5
			A(C)RUN260LLS5
			A(C)RUN260LLS5
Protection Devices	High pressure protection		High pressure sensor / High pressure switch
	Compressor/Fan		Over-heat protection / Fan driver overload protector
	Inverter		Over-heat protection / Over-current protection
Communication Cable		No. × mm ² (VCTF-SB)	2C × 1.0 ~ 1.5
Refrigerant	Refrigerant name		R410A
	Precharged Amount	kg	44.0
		lbs	97.0
	GWP		2087.5
	TCO ₂ eq		91.9
Control		Electronic Expansion Valve	
Power Supply		∅, V, Hz	380~415, 3, 50
			380, 3, 60
Number of maximum connectable indoor units***			64
Note			
<ol style="list-style-type: none"> Due to our policy of innovation some specifications may be changed without notification. Wiring cable size must comply with the applicable local and national codes. And "Electric characteristics" chapter should be considered for electrical work and design. Especially the power cable and circuit breaker should be selected in accordance with that. Power factor could vary less than ±1% according to the operating conditions. Sound pressure level is measured on the rated condition in the anechoic rooms by ISO 3745 standard. Sound power level is measured on the rated condition in the reverberation rooms by ISO 9614 standard. Therefore, these values can be increased owing to ambient conditions during operation. Sound values of combination model are calculated values based on sound results of independent models. Sound values can be increased owing to ambient or installation conditions during operation. Sound values of system [dB(A)] = 10 * log [10^{A1/10} + ... + 10^{An/10}], A1~An means sound values of independent models. Performances are based on the following conditions : <ul style="list-style-type: none"> *Cooling : Indoor Ambient Temp. 27°CDB / 19°CWB, Outdoor Ambient Temp. 35°CDB / 24°CWB *Heating : Indoor Ambient Temp. 20°CDB / 15°CWB, Outdoor Ambient Temp. 7°CDB / 6°CWB Interconnected Pipe Length is 7.5m and difference of Elevation (Outdoor ~ Indoor Unit) is 0m. *** : The number in parentheses means maximum connectable indoor units in accordance with outdoor units combination (160~200%). The recommended ratio is 130%. This product contains Fluorinated greenhouse gases.(R410A, GWP(Global warming potential) = 2,087.5) 			

2. Dimensions

ARUN080LLS5 / A(C)RUN100LLS5 / A(C)RUN120LLS5 / A(C)RUN140LLS5

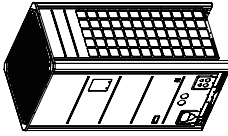
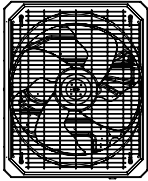
[Unit: mm]

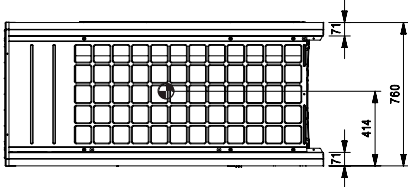
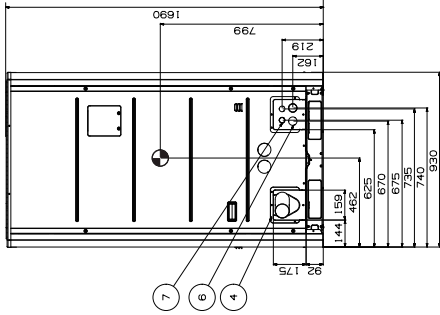
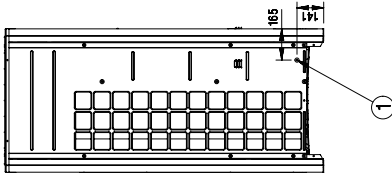
Gravity point

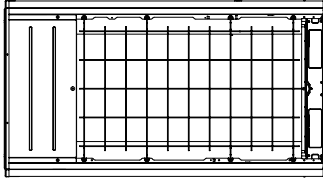
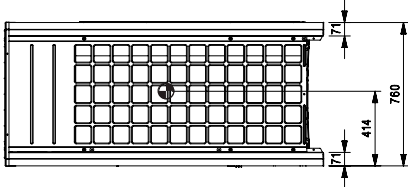
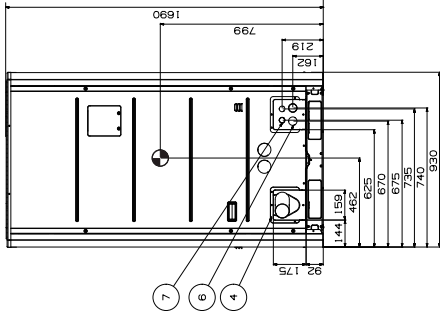
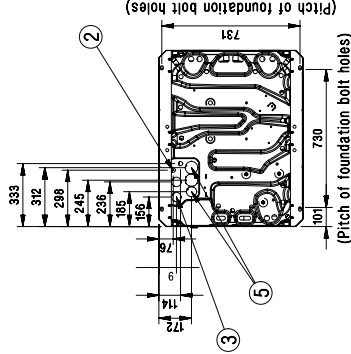
System	Heat Recovery		Heat Pump	
	Liquid pipe	High Pressure Gas pipe	Liquid pipe	Gas pipe
HP				
8	Ø 9.52 (3/8)	Ø 19.05 (3/4)	Ø 9.52 (3/8)	Ø 19.05 (3/4)
10	Ø 9.52 (3/8)	Ø 22.2 (7/8)	Ø 9.52 (3/8)	Ø 22.2 (7/8)
12	Ø 12.7 (1/2)	Ø 28.58 (1-1/8)	Ø 12.7 (1/2)	Ø 28.58 (1-1/8)
14	Ø 12.7 (1/2)	Ø 28.58 (1-1/8)	Ø 12.7 (1/2)	Ø 28.58 (1-1/8)

No.	Part Name	Description
7	Wire routing hole(front)	2- Ø 30
6	Power cord routing hole(front)	2- Ø 45
5	Pipe routing hole(bottom)	2- Ø 66, Ø 53.88
4	Pipe routing hole(front)	-
3	Power cord routing hole(bottom)	2- Ø 50
2	Wire routing hole(bottom)	2- Ø 22.2
1	Leakage test hole(side)	Ø 22.2
	No.	Description

Note

- Unit should be installed in compliance with the installation manual in the product box.
- Unit should be grounded in accordance with the local regulations or applicable national codes.
- All electrical components and materials to be supplied from the site must comply with the local regulations or international codes.
- Electrical characteristics chapter should be considered for electrical work and design. Especially the power cable and circuit breaker should be selected in accordance with that.

2. Dimensions

A(C)RUN160LLS5 / A(C)RUN180LLS5 / A(C)RUN200LLS5 / A(C)RUN220LLS5
 A(C)RUN240LLS5 / A(C)RUN260LLS5

[Unit: mm]
 Gravity point

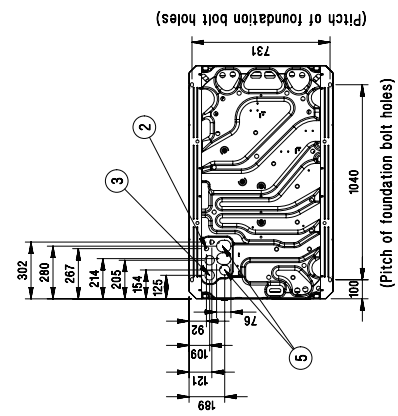
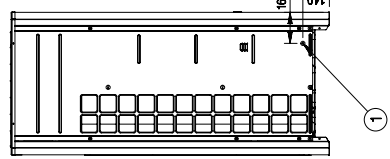
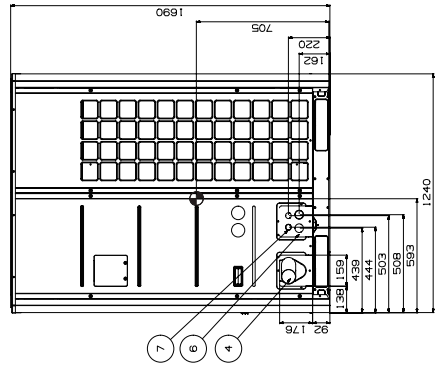
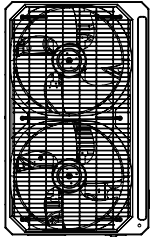
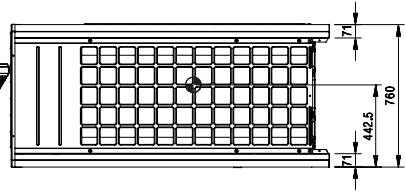
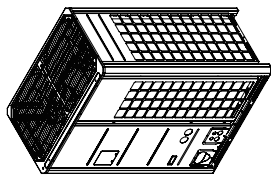

Note

1. Unit should be installed in compliance with the installation manual in the product box.
2. Unit should be grounded in accordance with the local regulations or applicable national codes.
3. All electrical components and materials to be supplied from the site must comply with the local regulations or international codes.
4. Electrical characteristics chapter should be considered for electrical work and design. Especially the power cable and circuit breaker should be selected in accordance with that.

System	Heat Recovery			Heat Pump	
	Liquid pipe	Low Pressure Gas pipe	High Pressure Gas pipe	Liquid pipe	Gas pipe
HP					
16	∅ 12.7 (1/2)	∅ 28.58 (1-1/8)	∅ 22.2 (7/8)	∅ 12.7 (1/2)	∅ 28.58 (1-1/8)
18-20	∅ 15.88 (5/8)	∅ 28.58 (1-1/8)	∅ 22.2 (7/8)	∅ 15.88 (5/8)	∅ 28.58 (1-1/8)
22	∅ 15.88 (5/8)	∅ 28.58 (1-1/8)	∅ 28.58 (1-1/8)	∅ 15.88 (5/8)	∅ 28.58 (1-1/8)
24	∅ 15.88 (5/8)	∅ 34.9 (1-3/8)	∅ 28.58 (1-1/8)	∅ 15.88 (5/8)	∅ 34.9 (1-3/8)
26-34	∅ 19.05 (3/4)	∅ 34.9 (1-3/8)	∅ 28.58 (1-1/8)	∅ 19.05 (3/4)	∅ 34.9 (1-3/8)
36	∅ 19.05 (3/4)	∅ 41.3 (1-5/8)	∅ 28.58 (1-1/8)	∅ 19.05 (3/4)	∅ 41.3 (1-5/8)
38-40	∅ 19.05 (3/4)	∅ 41.3 (1-5/8)	∅ 28.58 (1-1/8)	∅ 19.05 (3/4)	∅ 41.3 (1-5/8)
42-60	∅ 19.05 (3/4)	∅ 41.3 (1-5/8)	∅ 34.9 (1-3/8)	∅ 19.05 (3/4)	∅ 41.3 (1-5/8)
62-64	∅ 22.2 (7/8)	∅ 41.3 (1-5/8)	∅ 34.9 (1-3/8)	∅ 22.2 (7/8)	∅ 41.3 (1-5/8)
66-96	∅ 22.2 (7/8)	∅ 53.98 (2-1/8)	∅ 41.3 (1-5/8)	∅ 22.2 (7/8)	∅ 53.98 (2-1/8)

No.	Part Name	Description
7	Wire routing hole(front)	2- ∅ 30
6	Power cord routing hole(front)	2- ∅ 45
5	Pipe routing hole(bottom)	2- ∅ 66, ∅ 53.88
4	Pipe routing hole(front)	-
3	Power cord routing hole(bottom)	2- ∅ 50
2	Wire routing hole(bottom)	2- ∅ 22.2
1	Leakage test hole(side)	∅ 22.2

3. Piping Diagrams

3.1 8 / 10 / 12 / 14 (1 Comp)

■ Cooling Operation

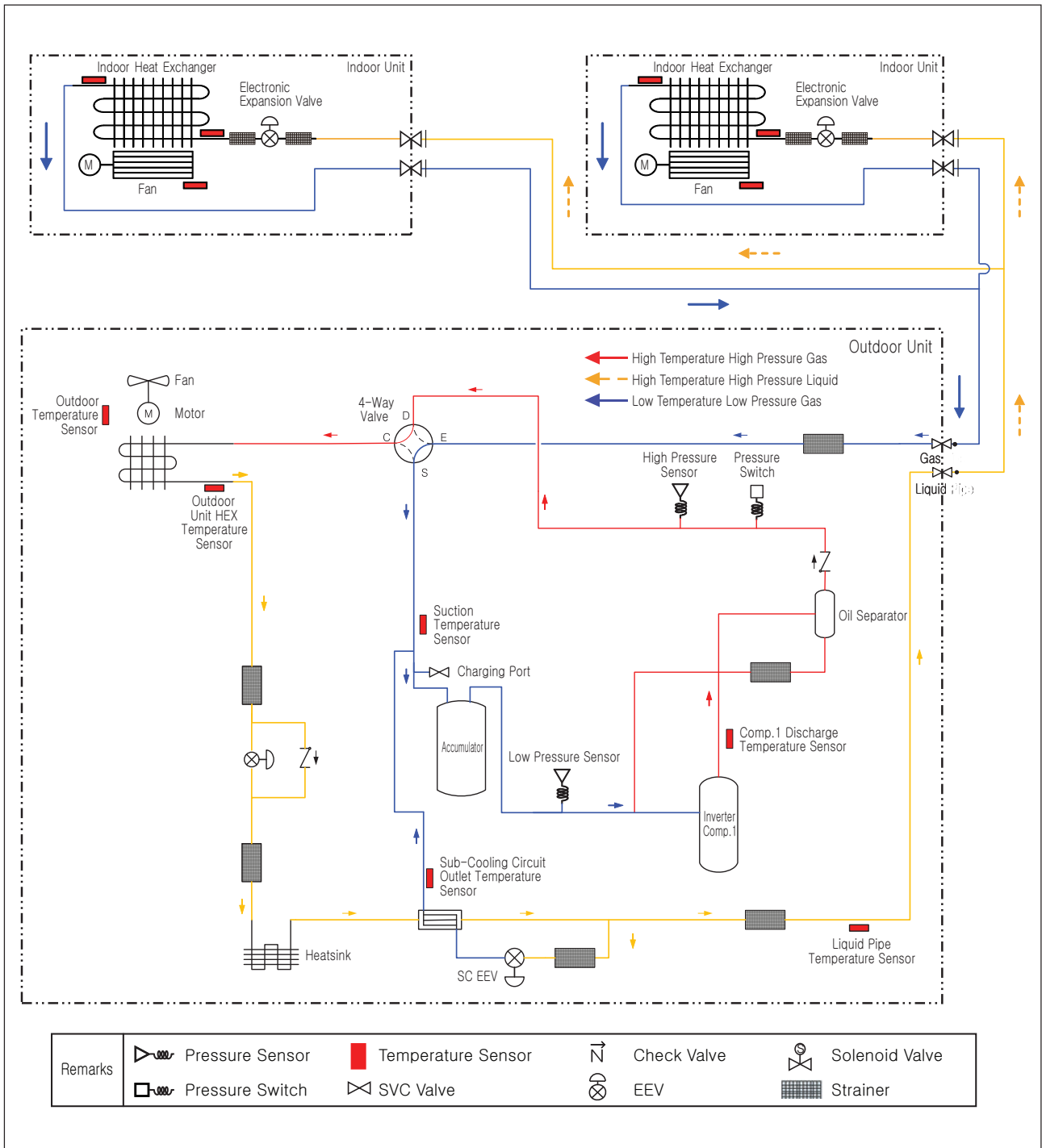

3. Piping Diagrams

■ Heating Operation

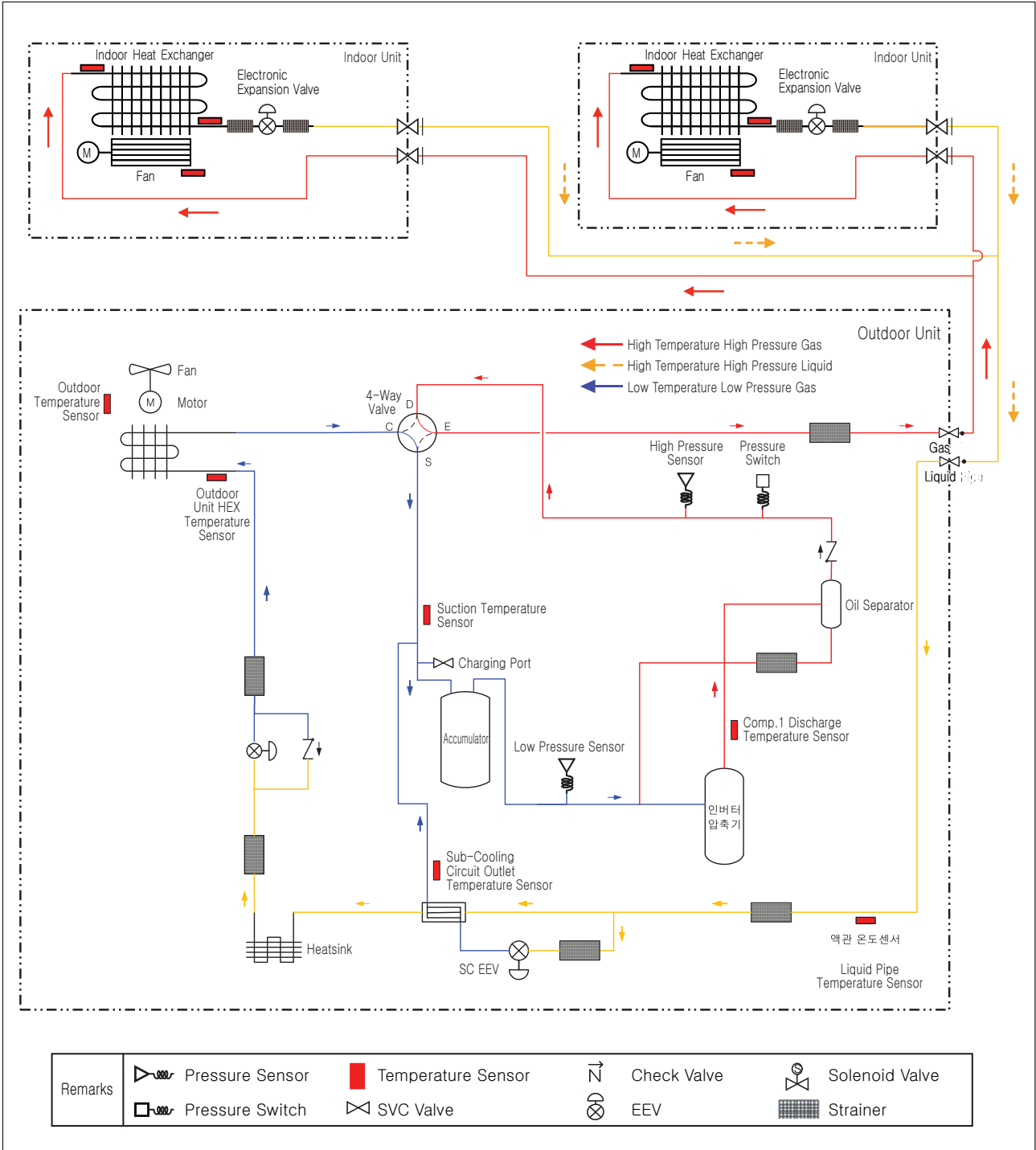

3. Piping Diagrams

Oil Return/ Defrost Operation

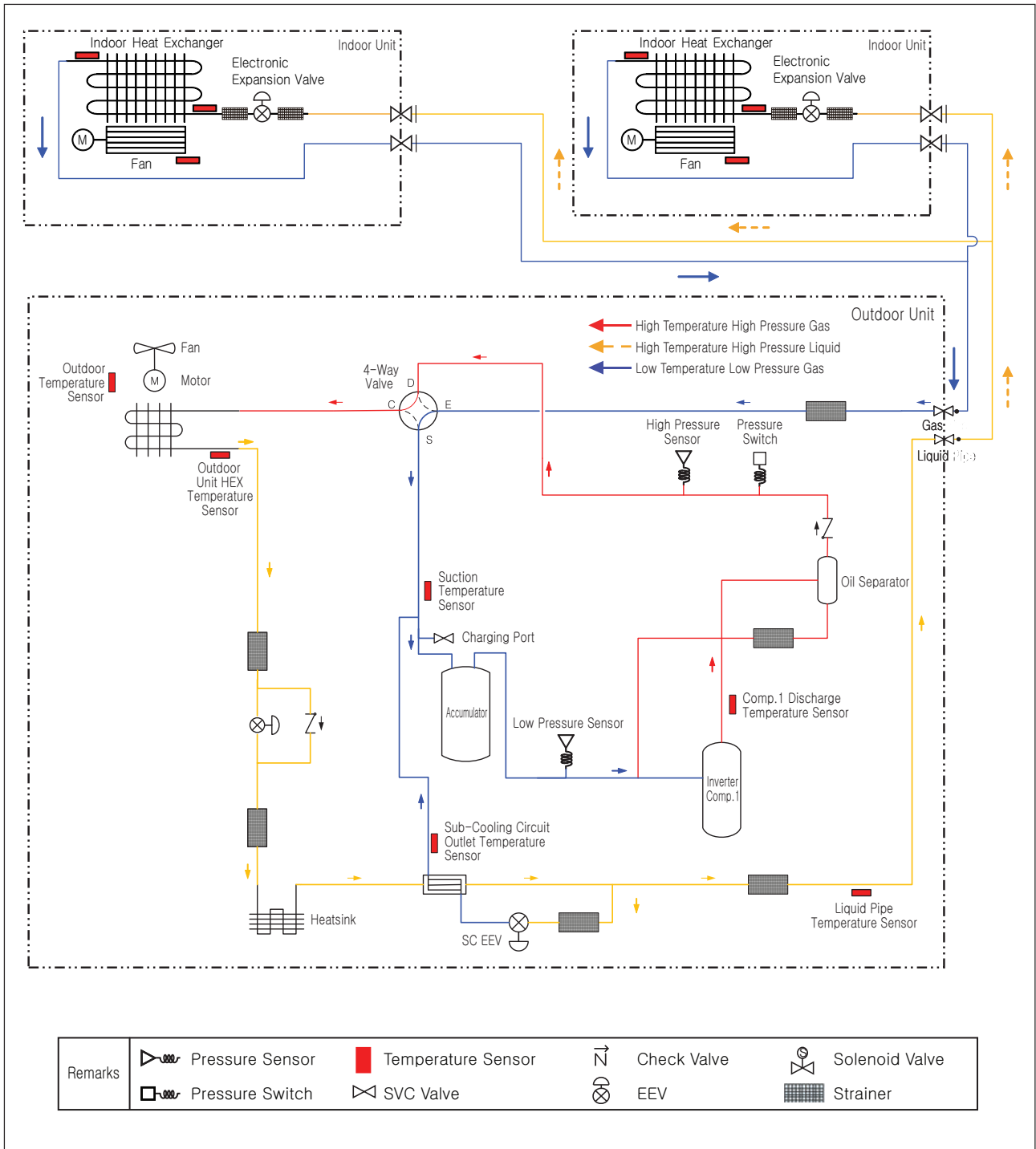

3. Piping Diagrams

3.2 16 / 18 / 20 / 22 (1 Comp)

■ Cooling Operation

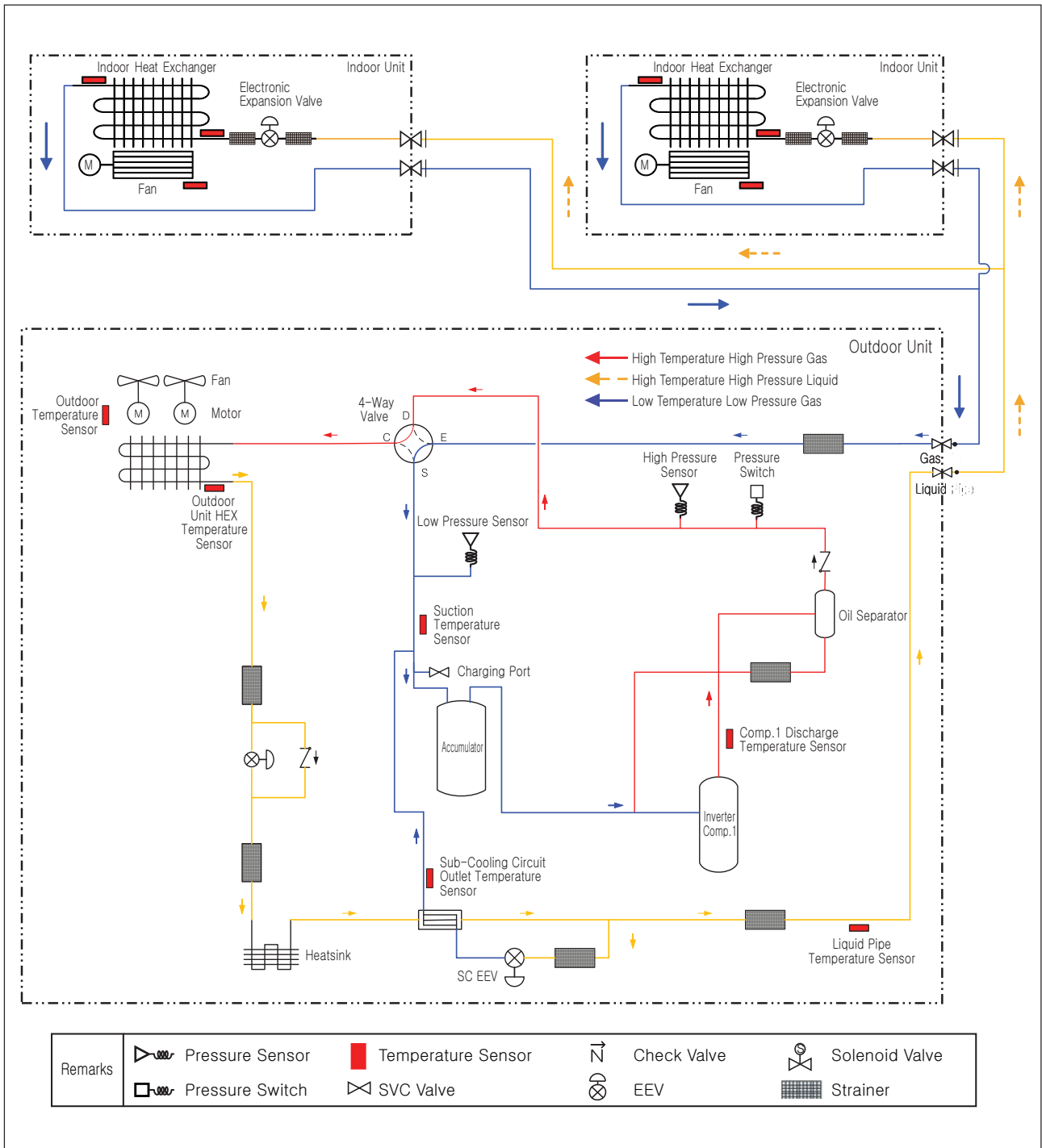

3. Piping Diagrams

■ Heating Operation

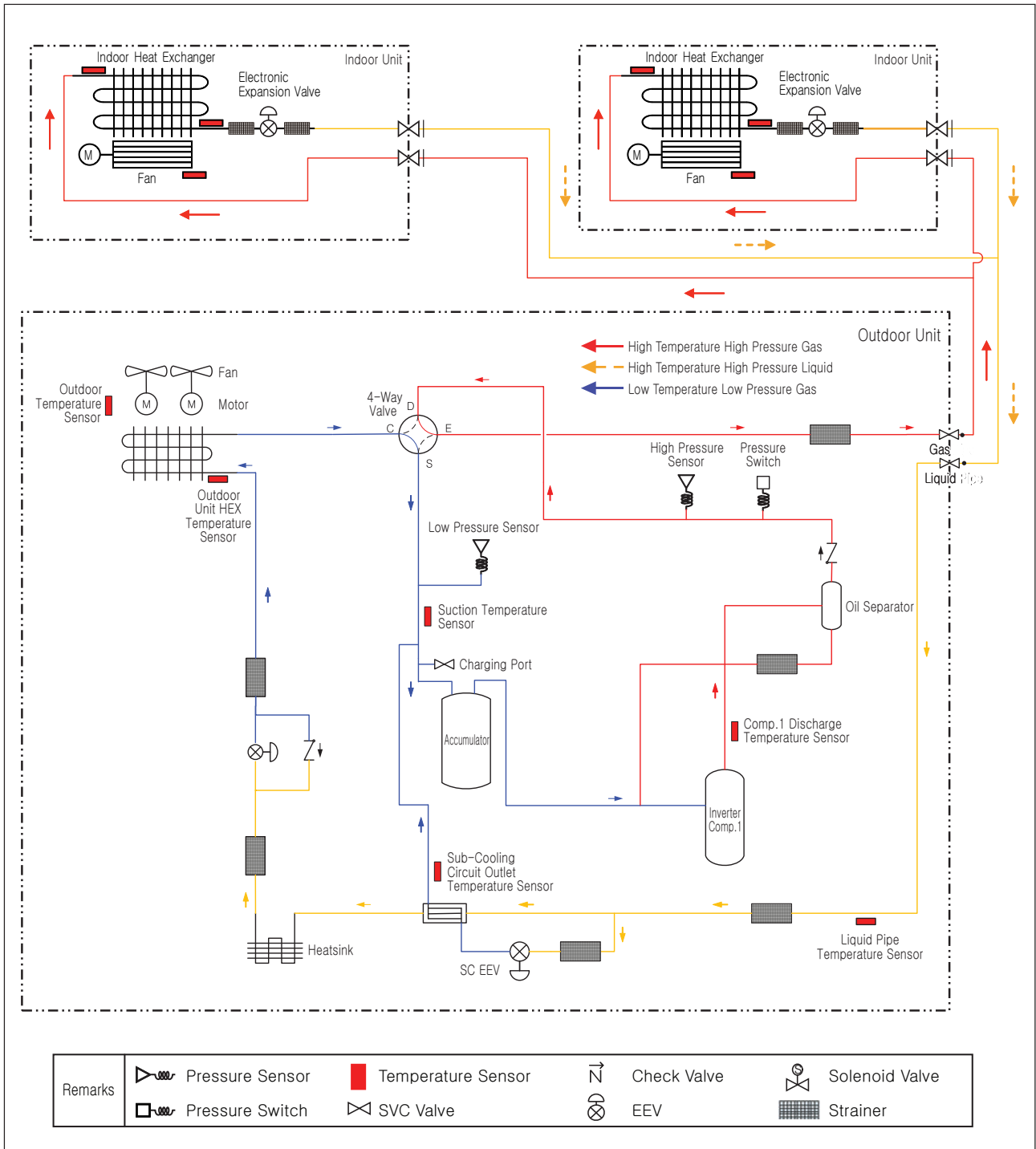

3. Piping Diagrams

Oil Return/ Defrost Operation

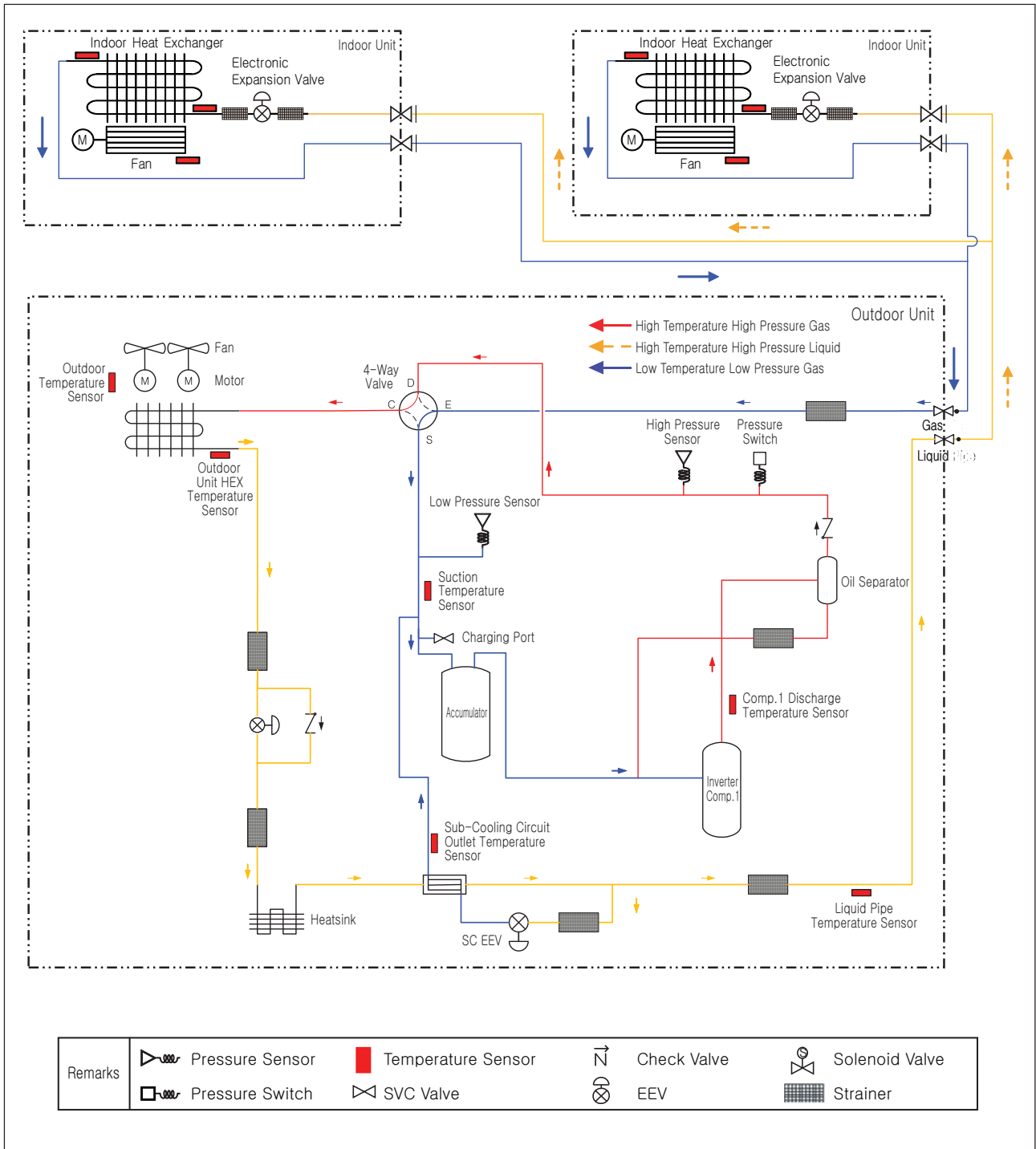

3. Piping Diagrams

3.3 24 / 26 (2 Comp)

■ Cooling Operation

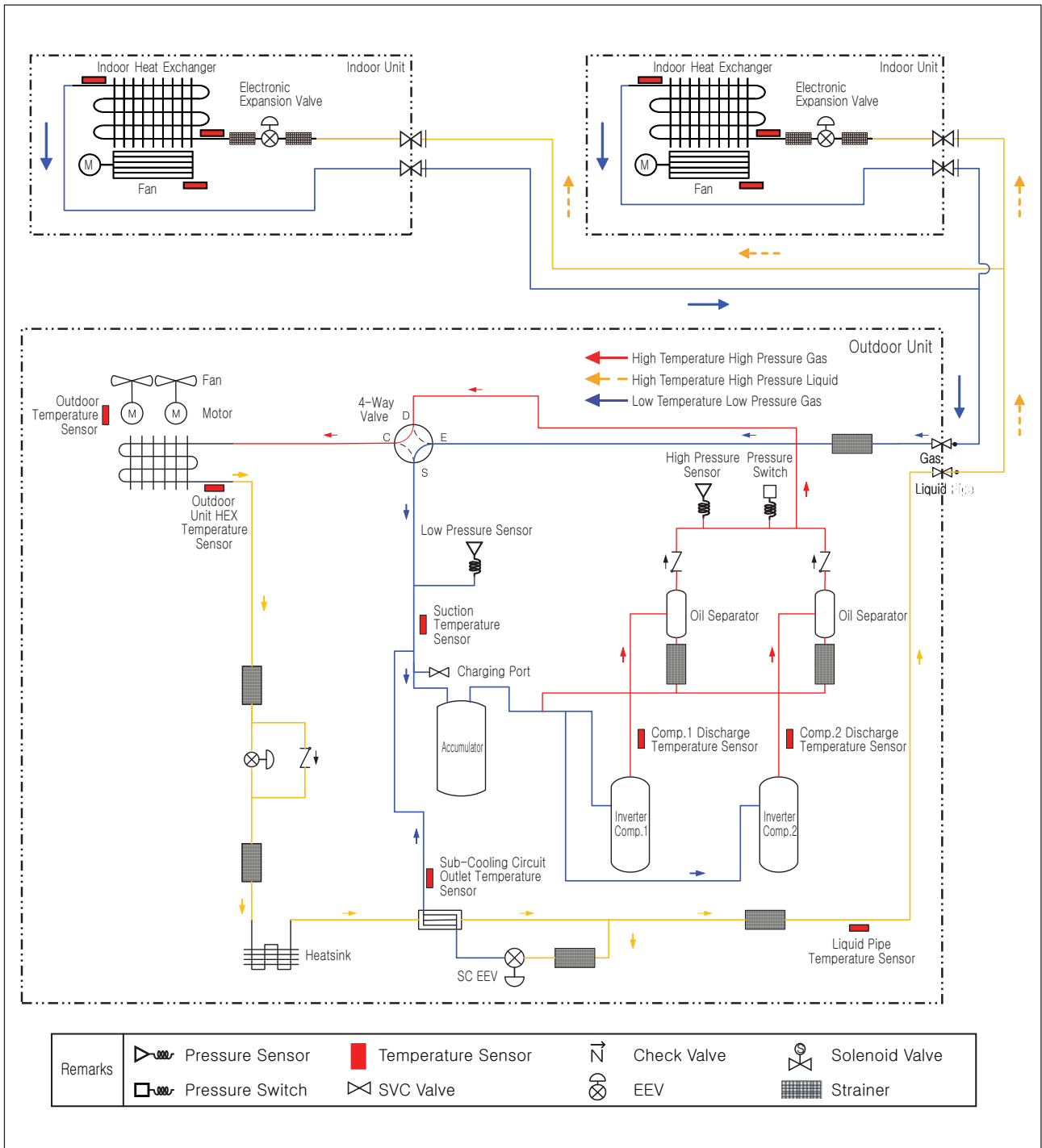

3. Piping Diagrams

■ Heating Operation

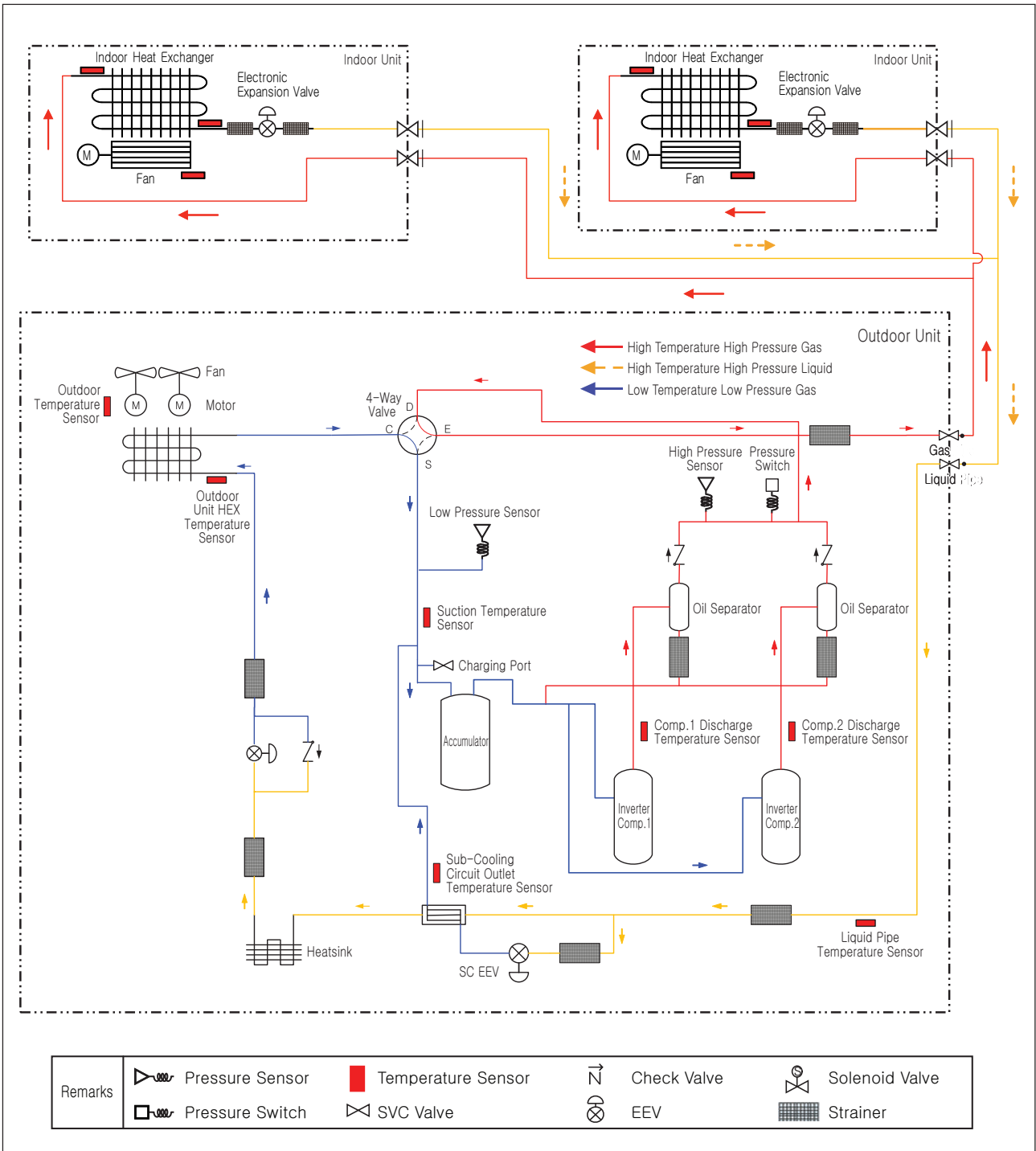

3. Piping Diagrams

Oil Return/ Defrost Operation

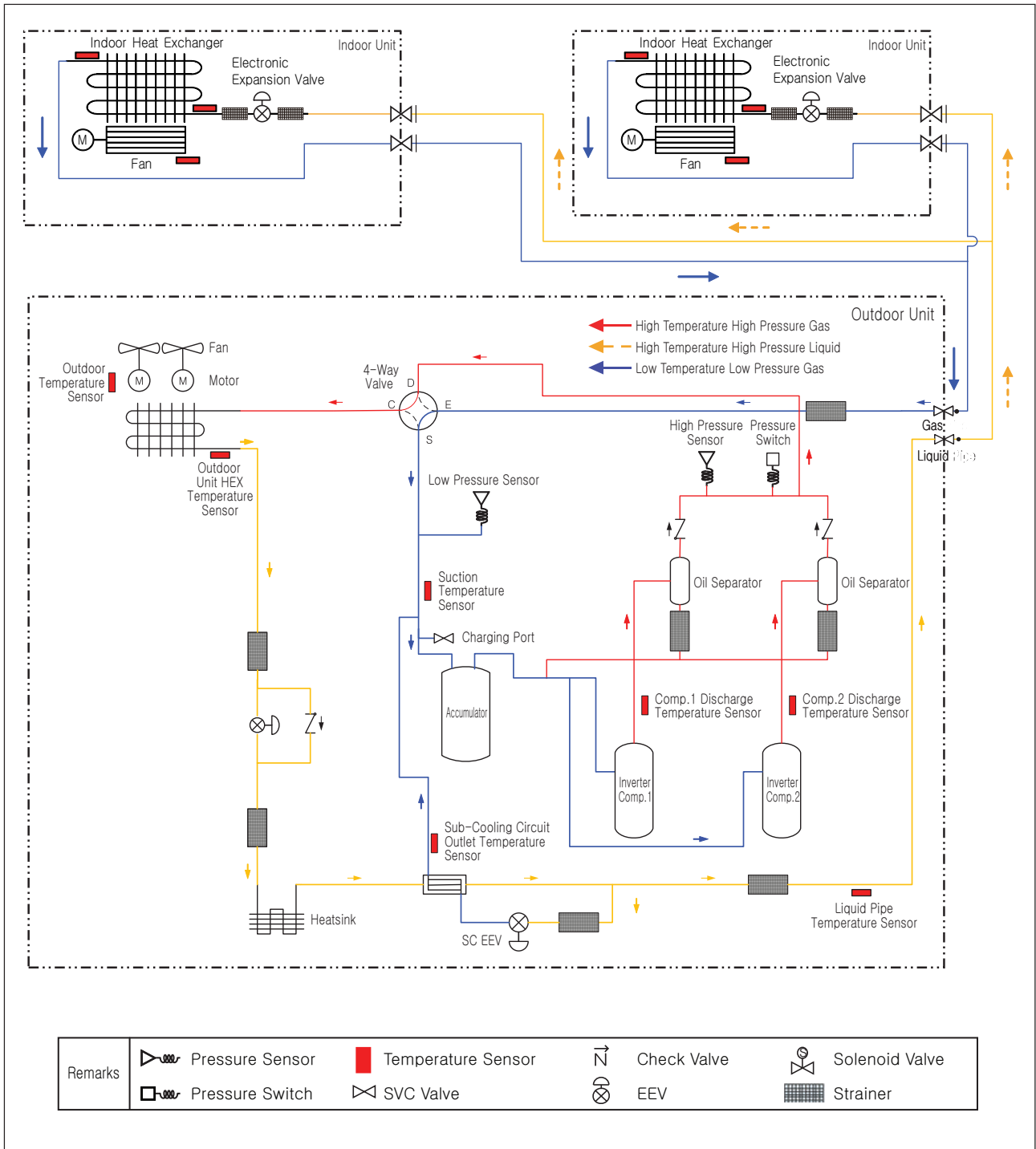

4. Wiring Diagrams

4.1 8 / 10 HP (UXA, 1 Comp)

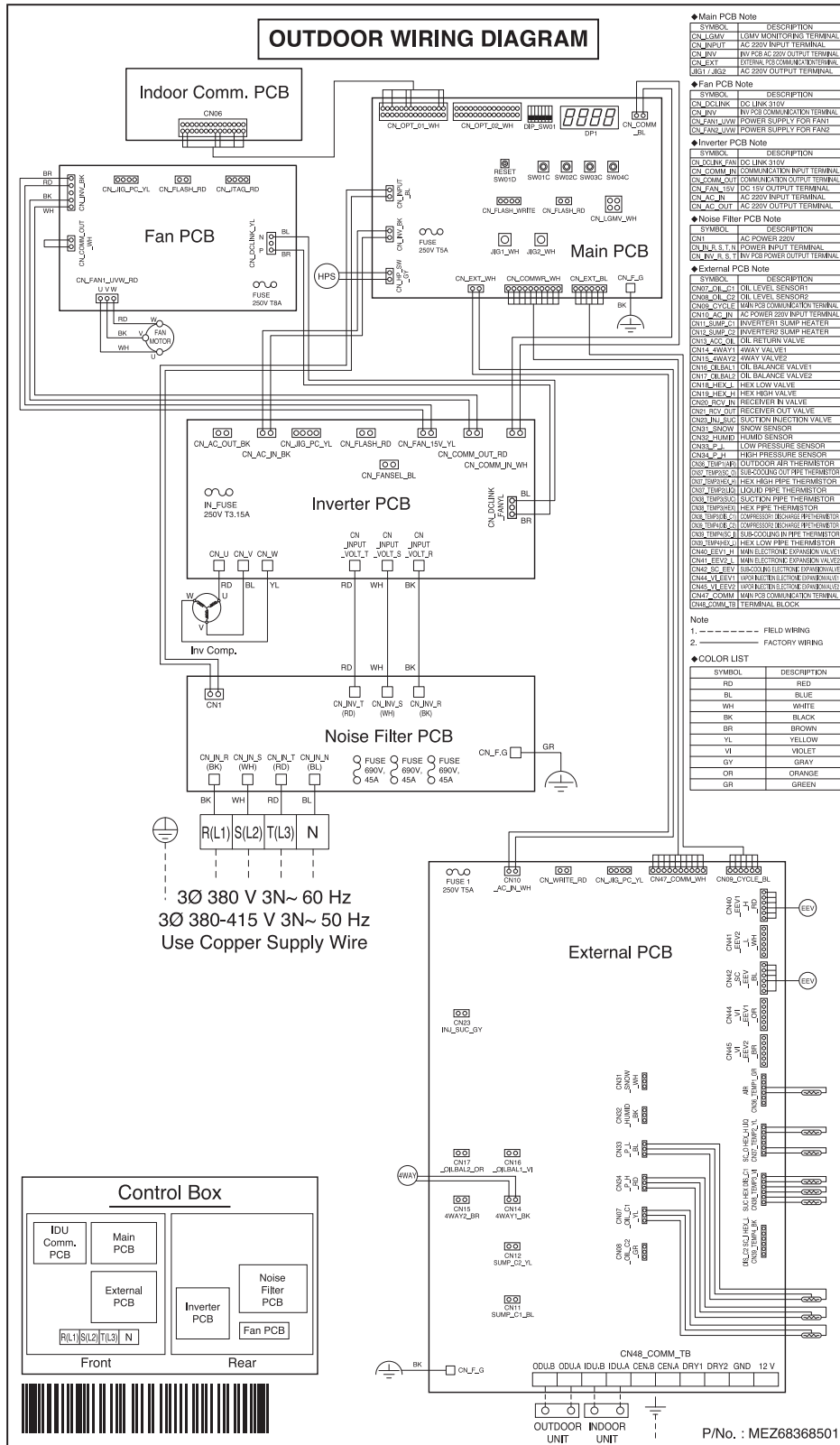

4. Wiring Diagrams

4.2 12 / 14 HP (UXA, 1 Comp)

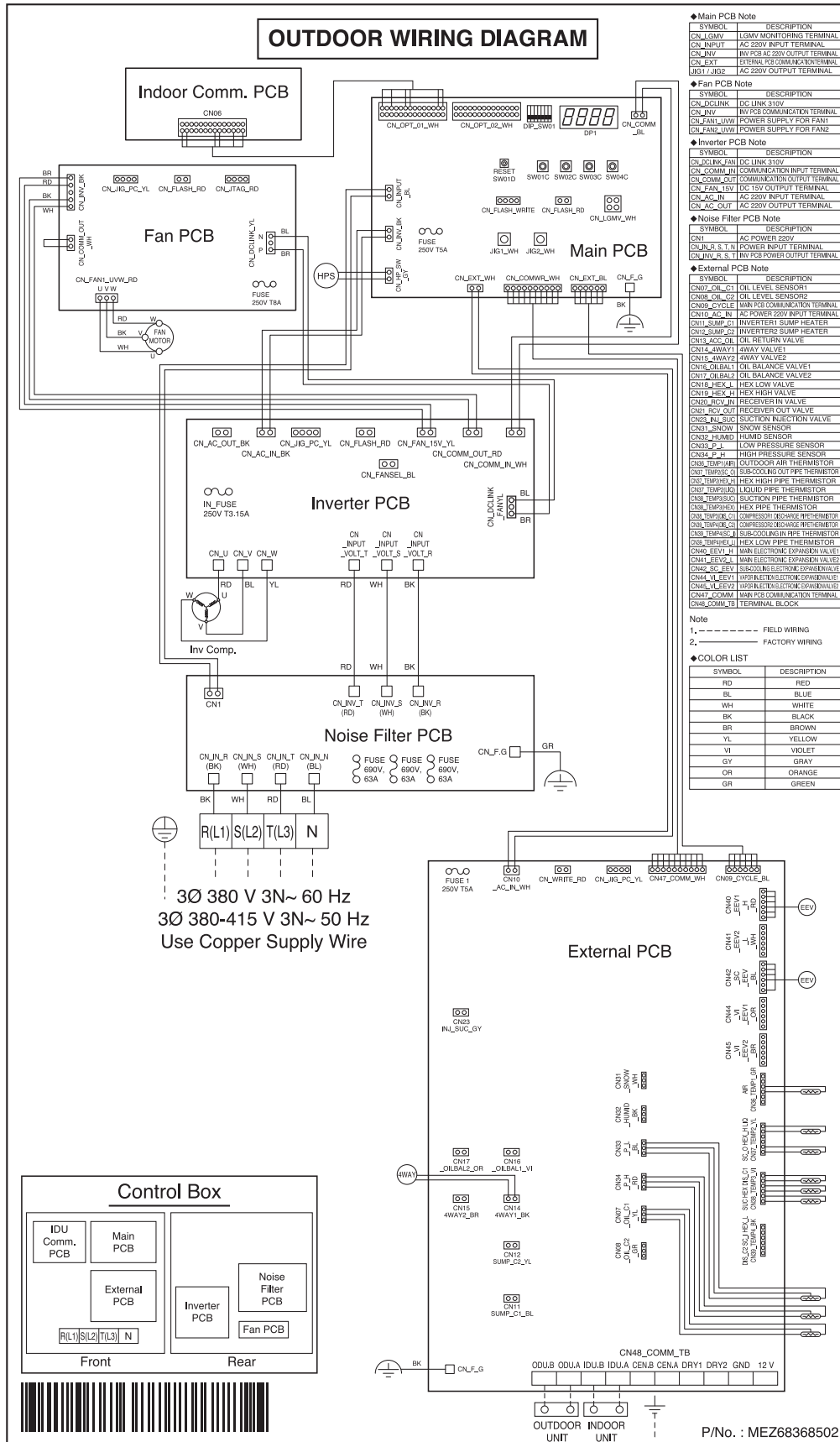

5. Field Wiring

Example Connection of Communication Cable

Single Outdoor Unit

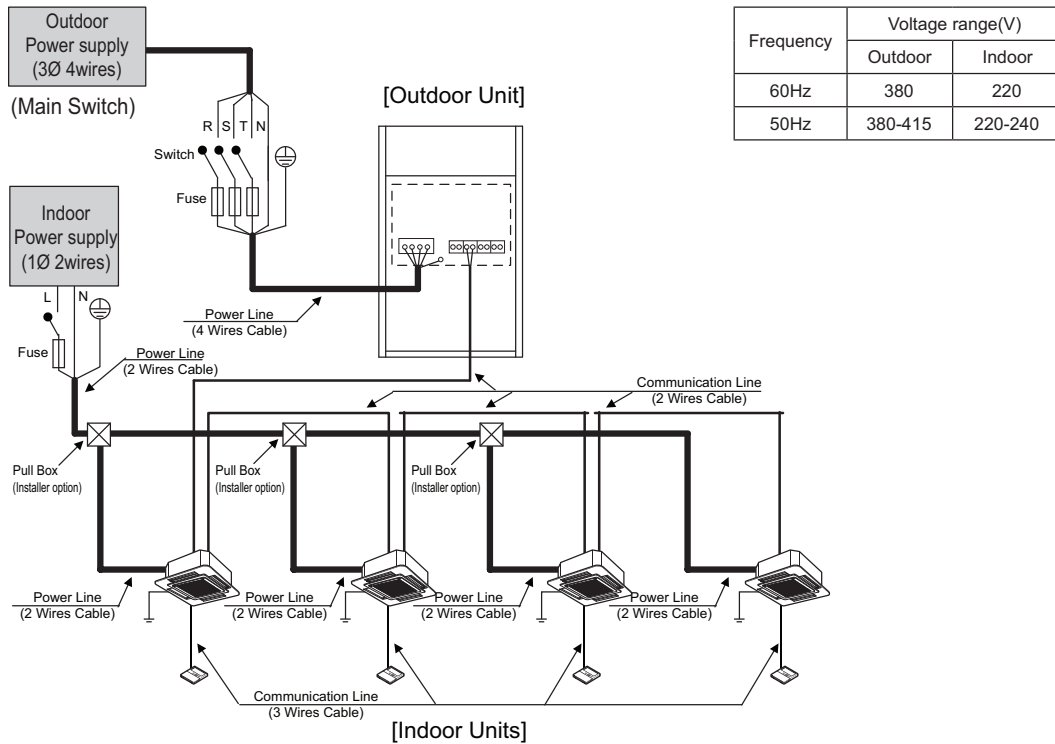

WARNING

- Installation site must require attachment of an earth leakage breaker. If no earth leakage breaker is installed, it may cause an electric shock.
- Indoor Unit ground Lines are required for preventing electrical shock accident during current leakage, Communication disorder by noise effect and motor current leakage (without connection to pipe).
- Don't install an individual switch or electrical outlet to disconnect each of indoor unit separately from the power supply.
If individual power supply is necessary for each indoor unit, IPM (Independent Power Module) should be applied at each indoor unit. (optional)
- Install the main switch that can interrupt all the power sources in an integrated manner because this system consists of the equipment utilizing the multiple power sources.
- If there exists the possibility of reversed phase, lose phase, momentary blackout or the power goes on and off while the product is operating, attach a reversed phase protection circuit locally.
Running the product in reversed phase may break the compressor and other parts.

Between Indoor and Master Outdoor unit

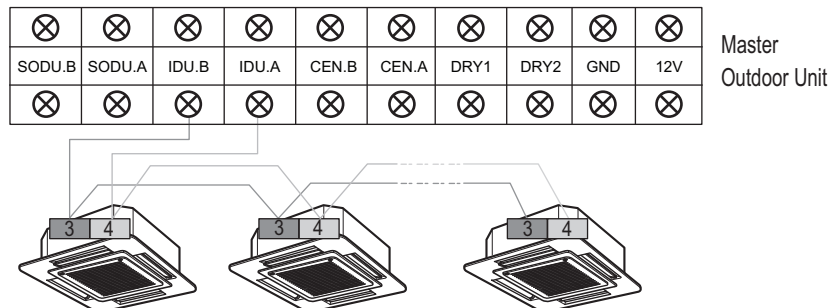

The GND terminal at the main PCB is a '-' terminal for day contact, it is not the point to make ground connection.

5. Field Wiring

Series Outdoor Unit

When the power source is connected In series between the units.

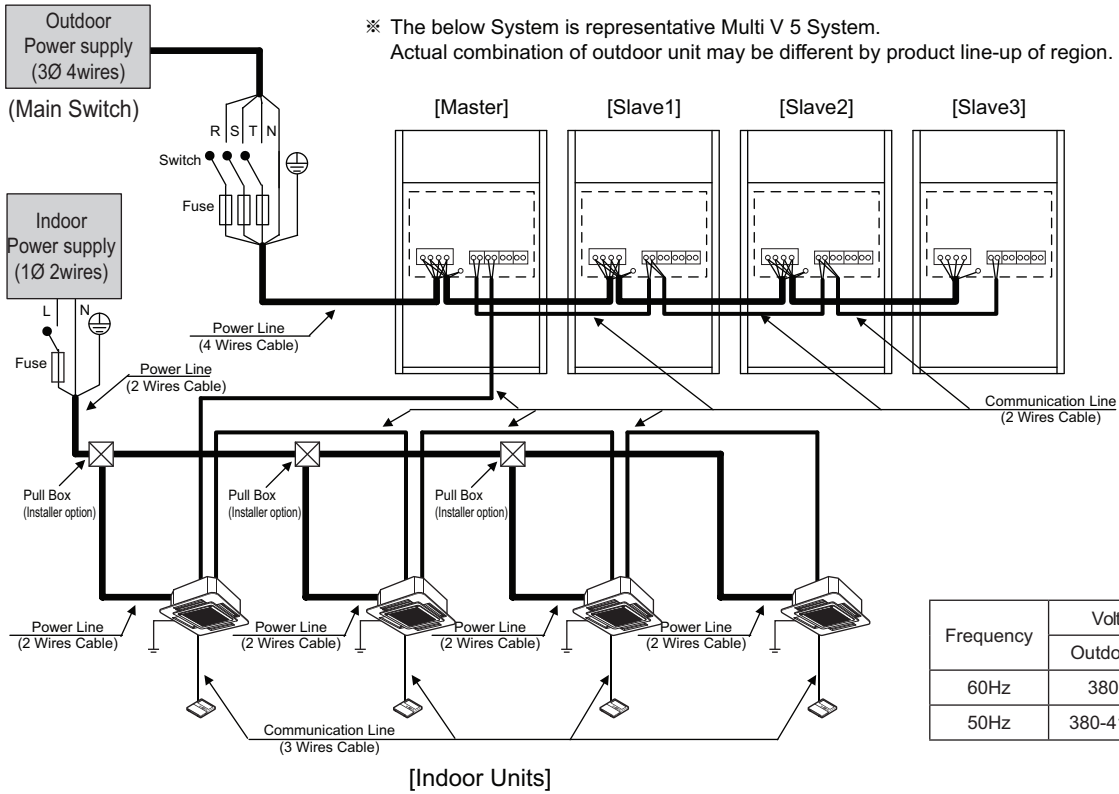

WARNING

When the total capacity is over than 68Hp, do not use single power source for connecting series units. The First terminal block could be burnt out.

When the power source is supplied to Each outdoor unit individually.

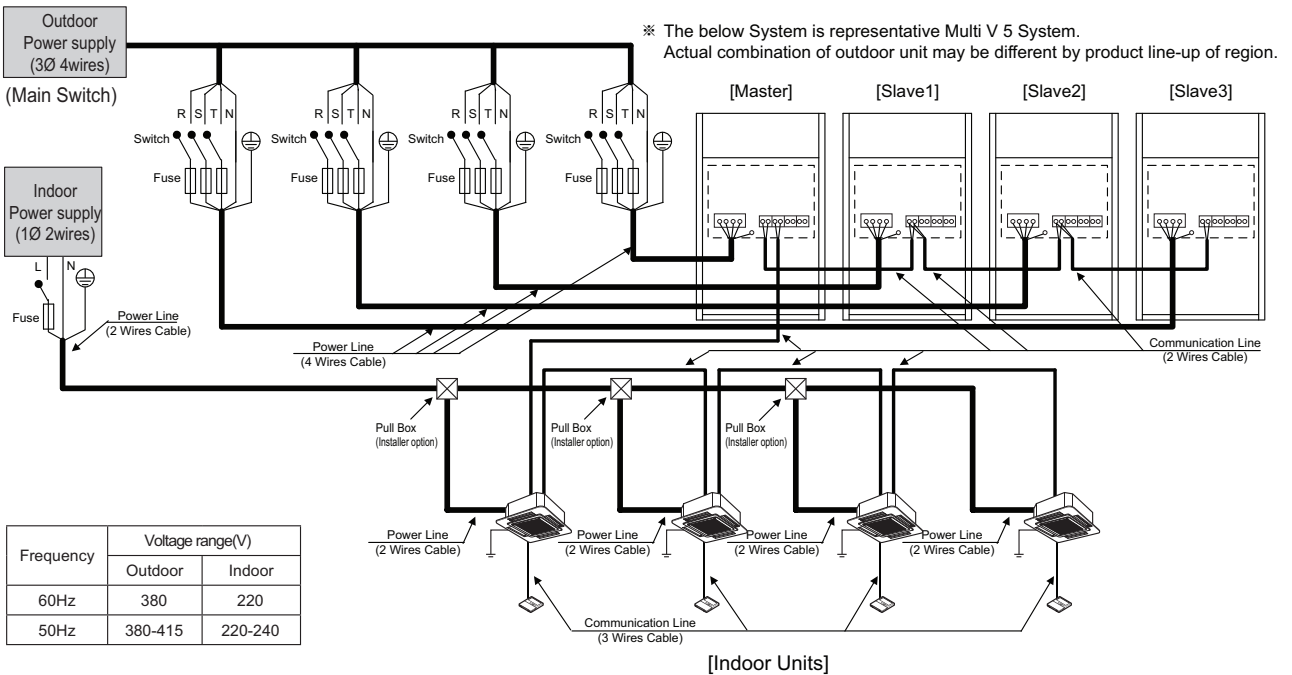

5. Field Wiring

⚠ WARNING

- Installation site must require attachment of an earth leakage breaker. If no earth leakage breaker is installed, it may cause an electric shock.
- Indoor Unit ground Lines are required for preventing electrical shock accident during current leakage, Communication disorder by noise effect and motor current leakage (without connection to pipe).
- Don't install an individual switch or electrical outlet to disconnect each of indoor unit separately from the power supply.
If individual power supply is necessary for each indoor unit, IPM (Independent Power Module) should be applied at each indoor unit. (optional)
- Install the main switch that can interrupt all the power sources in an integrated manner because this system consists of the equipment utilizing the multiple power sources.
- If there exists the possibility of reversed phase, lose phase, momentary blackout or the power goes on and off while the product is operating, attach a reversed phase protection circuit locally.
Running the product in reversed phase may break the compressor and other parts.

◆ Between Indoor and Master Outdoor unit

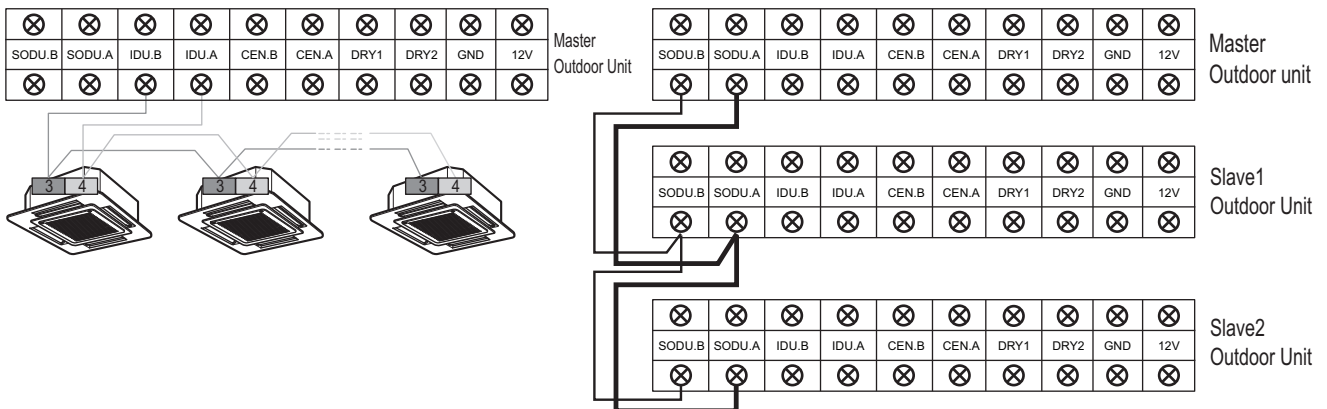

The GND terminal at the main PCB is a 'L' terminal for dry contact. It is not the point to make ground connection.

- Make sure that terminal number of master and slave outdoor units are matched.(A-A,B-B)

■ Example Connection of Communication Cable

- Connection of communication cable must be installed like below figure between indoor unit to outdoor unit.
- Abnormal operation can be caused by communication defect, when connection of communication cable is installed like below figure.

BUS Type

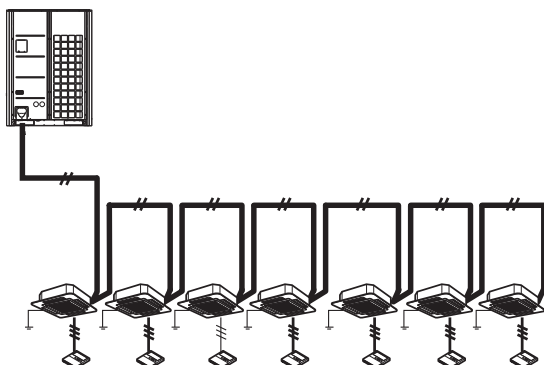

STAR Type

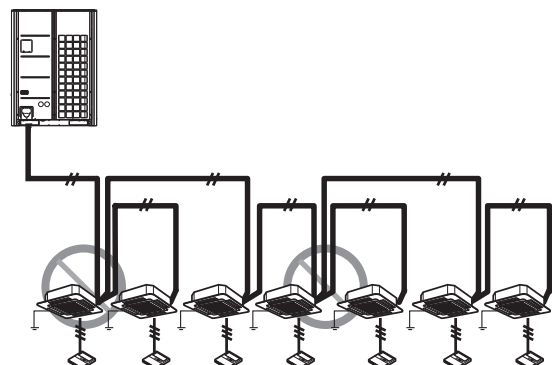

6. Electric Characteristics

■ Wiring of Main Power Supply and Equipment Capacity

1. Use a separate power supply for the Outdoor Unit and Indoor Unit.
2. Bear in mind ambient conditions (ambient temperature, direct sunlight, rain liquid, etc.) when proceeding with the wiring and connections
3. The wire size is the minimum value for metal conduit wiring. The power cord size should be 1 rank thicker taking into account the line voltage drops. Make sure the power-supply voltage does not drop more than 10%.
4. Specific wiring requirements should adhere to the wiring regulations of the region.
5. Power supply cords of parts of appliances for outdoor use should not be lighter than polychloroprene sheathed flexible cord (design 60245 IEC57).
6. Don't install an individual switch or electrical outlet to disconnect each of indoor unit separately from the power supply.

WARNING

- Follow ordinance of local regulation for technical standard related to electrical equipment, wiring regulations and guidance of each electric power company.
- Make sure to use specified wires for connections so that no external force is imparted to terminal connections. If connections are not fixed firmly, it may cause heating or fire.
- Make sure to use the appropriate type of overcurrent protection switch. Note that generated overcurrent may include some amount of direct current.
- Installation site must require attachment of an earth leakage breaker. If no earth leakage breaker is installed, it may cause an electric shock.

CAUTION

- Do not use anything other than breaker and fuse with correct capacity. Using fuse and wire or copper wire with too large capacity may cause a malfunction of unit or fire.
-

6. Electric Characteristics

■ 50Hz

Model	Unit			Power Supply			COMP			OFM	
	Hz	Volts	Voltage-range	MCA	TOCA	MFA	MSC	RLA (Cooling)	RLA(Heating)	kW	FLA
8 HP	50	380-415	Min.:342, Max.:456	19.3	20.0	20	4.3	5.8	5.7	1.2	2.5
10 HP	50	380-415	Min.:342, Max.:456	23.3	24.0	25	4.3	8.6	9.1	1.2	2.5
12 HP	50	380-415	Min.:342, Max.:456	25.5	28.0	32	5.9	12.0	12.4	1.2	2.5
14 HP	50	380-415	Min.:342, Max.:456	26.1	29.0	32	5.9	14.8	16.5	1.2	2.5
16 HP	50	380-415	Min.:342, Max.:456	27.3	30.0	32	5.9	16.9	17.3	1.8	2.5
18 HP	50	380-415	Min.:342, Max.:456	31.8	35.0	35	7.5	17.6	17.3	1.8	2.5
20 HP	50	380-415	Min.:342, Max.:456	35.5	39.0	40	7.5	20.5	21.2	1.8	2.5
22 HP	50	380-415	Min.:342, Max.:456	37.8	42.0	45	7.5	24.9	26.6	1.8	2.5
24 HP	50	380-415	Min.:342, Max.:456	50.0	56.0	60	11.8	27.2	26.7	1.8	2.5
26 HP	50	380-415	Min.:342, Max.:456	54.5	60.0	60	11.8	31.5	31.0	1.8	2.5
28 HP	50	380-415	Min.:342, Max.:456	52.7	58.0	60	11.8	29.0	29.6	3.0	5.0
30 HP	50	380-415	Min.:342, Max.:456	57.3	63.0	63	13.4	29.6	29.6	3.0	5.0
32 HP	50	380-415	Min.:342, Max.:456	60.9	67.0	70	13.4	32.6	33.6	3.0	5.0
34 HP	50	380-415	Min.:342, Max.:456	61.8	68.0	70	13.4	36.9	39.0	3.0	5.0
36 HP	50	380-415	Min.:342, Max.:456	76.4	84.0	80	17.7	39.3	39.1	3.0	5.0
38 HP	50	380-415	Min.:342, Max.:456	80.0	88.0	90	17.7	43.5	43.4	3.0	5.0
40 HP	50	380-415	Min.:342, Max.:456	80.9	89.0	90	17.7	46.3	47.4	3.0	5.0
42 HP	50	380-415	Min.:342, Max.:456	81.8	90.0	90	17.7	48.4	48.3	3.6	5.0
44 HP	50	380-415	Min.:342, Max.:456	86.4	95.0	100	19.3	49.1	48.3	3.6	5.0
46 HP	50	380-415	Min.:342, Max.:456	88.4	99.0	100	19.3	52.0	52.2	3.6	5.0
48 HP	50	380-415	Min.:342, Max.:456	92.7	102.0	110	19.3	56.4	57.6	3.6	5.0
50 HP	50	380-415	Min.:342, Max.:456	105.0	116.0	125	23.6	58.7	57.7	3.6	5.0
52 HP	50	380-415	Min.:342, Max.:456	109.1	120.0	125	23.6	63.0	62.0	3.6	5.0
54 HP	50	380-415	Min.:342, Max.:456	107.3	118.0	125	23.6	60.5	60.6	4.8	7.5
56 HP	50	380-415	Min.:342, Max.:456	110.8	123.0	125	25.2	61.1	60.6	4.8	7.5
58 HP	50	380-415	Min.:342, Max.:456	115.5	127.0	150	25.2	64.1	64.5	4.8	7.5
60 HP	50	380-415	Min.:342, Max.:456	117.6	130.0	150	25.2	68.5	69.9	4.8	7.5
62 HP	50	380-415	Min.:342, Max.:456	127.0	141.0	150	29.5	70.7	69.9	4.8	7.5
64 HP	50	380-415	Min.:342, Max.:456	134.5	148.0	150	29.5	75.0	74.4	4.8	7.5
66 HP	50	380-415	Min.:342, Max.:456	134.2	149.0	150	29.5	77.8	78.4	4.8	7.5
68 HP	50	380-415	Min.:342, Max.:456	136.4	150.0	150	29.5	79.9	79.3	5.4	7.5
70 HP	50	380-415	Min.:342, Max.:456	140.9	155.0	150	31.1	80.6	79.3	5.4	7.5
72 HP	50	380-415	Min.:342, Max.:456	143.2	159.0	175	31.1	83.5	83.2	5.4	7.5
74 HP	50	380-415	Min.:342, Max.:456	146.6	162.0	175	31.1	87.9	88.6	5.4	7.5
76 HP	50	380-415	Min.:342, Max.:456	160.0	176.0	175	35.4	90.2	88.7	5.4	7.5
78 HP	50	380-415	Min.:342, Max.:456	163.6	180.0	200	35.4	94.4	93.0	5.4	7.5
80 HP	50	380-415	Min.:342, Max.:456	161.8	178.0	200	35.4	91.9	91.6	6.6	10.0
82 HP	50	380-415	Min.:342, Max.:456	166.4	183.0	200	37.0	92.6	91.6	6.6	10.0
84 HP	50	380-415	Min.:342, Max.:456	168.5	187.0	200	37.0	95.5	95.5	6.6	10.0
86 HP	50	380-415	Min.:342, Max.:456	171.2	190.0	200	37.0	100.0	100.9	6.6	10.0
88 HP	50	380-415	Min.:342, Max.:456	185.5	204.0	200	41.3	102.2	101.1	6.6	10.0
90 HP	50	380-415	Min.:342, Max.:456	189.1	208.0	200	41.3	106.5	105.3	6.6	10.0
92 HP	50	380-415	Min.:342, Max.:456	188.2	207.0	200	42.9	109.3	109.5	7.2	10.0
94 HP	50	380-415	Min.:342, Max.:456	190.9	210.0	200	41.3	111.4	110.3	7.2	10.0
96 HP	50	380-415	Min.:342, Max.:456	195.5	215.0	250	42.9	112.0	110.3	7.2	10.0

Note

1. Voltage supplied to the unit terminals should be within the minimum and maximum range.
2. Maximum allowable voltage unbalance between phase is 2%.
3. MSC means the Max. current during the starting of compressor.
4. MSC and RLA are measured as the compressor only test condition.
5. OFM are measured as the outdoor unit test condition.
6. TOCA means the total over current value of each outdoor unit.
7. Select the wire size based on the larger value among MCA or TOCA.
8. MFA is recommended fuse amps.
9. TOCA is minimum required amperes for selecting the circuit breaker and ground fault circuit interrupter. Please select the circuit breaker size equal or greater than TOCA.
All installation site must require attachment of an earth leakage breaker.[Circuit breaker type is ELCB (Earth Leakage Circuit Breaker)].
10. Select the electrical equipment of combination unit according to the electrical characteristics of individual unit.

Symbols

- MCA** : Minimum Circuit Amperes (A)
TOCA : Total Over Current Amperes (A)
MFA : Maximum Fuse Amperes (A)
MSC : Maximum Starting Current (A)
RLA : Rated Load Amperes (A)
OFM : Outdoor Fan Motor
kW : Fan Motor rated output (kW)
FLA : Full Load Amperes (A)

6. Electric Characteristics

Model	Unit			Power Supply			COMP			OFM	
	Hz	Volts	Voltage-range	MCA	TOCA	MFA	MSC	RLA (Cooling)	RLA(Heating)	kW	FLA
98 HP	50	380-415	Min.:342, Max.:456	199.1	219.0	250	42.9	115.0	114.2	7.2	10.0
100 HP	50	380-415	Min.:342, Max.:456	201.8	222.0	250	42.9	119.4	119.6	7.2	10.0
102 HP	50	380-415	Min.:342, Max.:456	214.5	236.0	250	47.2	121.7	119.7	7.2	10.0
104 HP	50	380-415	Min.:342, Max.:456	218.2	240.0	250	47.2	125.9	124.0	7.2	10.0

Note

1. Voltage supplied to the unit terminals should be within the minimum and maximum range.
2. Maximum allowable voltage unbalance between phase is 2%.
3. MSC means the Max. current during the starting of compressor.
4. MSC and RLA are measured as the compressor only test condition.
5. OFM are measured as the outdoor unit test condition.
6. TOCA means the total over current value of each outdoor unit.
7. Select the wire size based on the larger value among MCA or TOCA.
8. MFA is recommended fuse amps.
9. TOCA is minimum required amperes for selecting the circuit breaker and ground fault circuit interrupter. Please select the circuit breaker size equal or greater than TOCA. All installation site must require attachment of an earth leakage breaker.[Circuit breaker type is ELCB (Earth Leakage Circuit Breaker)].
10. Select the electrical equipment of combination unit according to the electrical characteristics of individual unit.

Symbols

- MCA** : Minimum Circuit Amperes (A)
TOCA : Total Over Current Amperes (A)
MFA : Maximum Fuse Amperes (A)
MSC : Maximum Starting Current (A)
RLA : Rated Load Amperes (A)
OFM : Outdoor Fan Motor
kW : Fan Motor rated output (kW)
FLA : Full Load Amperes (A)

6. Electric Characteristics

■ 60Hz

Model	Unit			Power Supply			COMP			OFM	
	Hz	Volts	Voltage-range	MCA	TOCA	MFA	MSC	RLA (Cooling)	RLA(Heating)	kW	FLA
8 HP	60	380	Min.:342, Max.:418	19.3	20.0	20	4.3	5.8	5.7	1.2	2.5
10 HP	60	380	Min.:342, Max.:418	23.3	24.0	25	4.3	8.6	9.1	1.2	2.5
12 HP	60	380	Min.:342, Max.:418	25.5	28.0	32	5.9	12.0	12.4	1.2	2.5
14 HP	60	380	Min.:342, Max.:418	26.1	29.0	32	5.9	14.8	16.5	1.2	2.5
16 HP	60	380	Min.:342, Max.:418	27.3	30.0	32	5.9	16.9	17.3	1.8	2.5
18 HP	60	380	Min.:342, Max.:418	31.8	35.0	35	7.5	17.6	17.3	1.8	2.5
20 HP	60	380	Min.:342, Max.:418	35.5	39.0	40	7.5	20.5	21.2	1.8	2.5
22 HP	60	380	Min.:342, Max.:418	37.8	42.0	45	7.5	24.9	26.6	1.8	2.5
24 HP	60	380	Min.:342, Max.:418	50.0	56.0	60	11.8	27.2	26.7	1.8	2.5
26 HP	60	380	Min.:342, Max.:418	54.5	60.0	60	11.8	31.5	31.0	1.8	2.5
28 HP	60	380	Min.:342, Max.:418	52.7	58.0	60	11.8	29.0	29.6	3.0	5.0
30 HP	60	380	Min.:342, Max.:418	57.3	63.0	63	13.4	29.6	29.6	3.0	5.0
32 HP	60	380	Min.:342, Max.:418	60.9	67.0	70	13.4	32.6	33.6	3.0	5.0
34 HP	60	380	Min.:342, Max.:418	61.8	68.0	70	13.4	36.9	39.0	3.0	5.0
36 HP	60	380	Min.:342, Max.:418	76.4	84.0	80	17.7	39.3	39.1	3.0	5.0
38 HP	60	380	Min.:342, Max.:418	80.0	88.0	90	17.7	43.5	43.4	3.0	5.0
40 HP	60	380	Min.:342, Max.:418	80.9	89.0	90	17.7	46.3	47.4	3.0	5.0
42 HP	60	380	Min.:342, Max.:418	81.8	90.0	90	17.7	48.4	48.3	3.6	5.0
44 HP	60	380	Min.:342, Max.:418	86.4	95.0	100	19.3	49.1	48.3	3.6	5.0
46 HP	60	380	Min.:342, Max.:418	88.4	99.0	100	19.3	52.0	52.2	3.6	5.0
48 HP	60	380	Min.:342, Max.:418	92.7	102.0	110	19.3	56.4	57.6	3.6	5.0
50 HP	60	380	Min.:342, Max.:418	105.0	116.0	125	23.6	58.7	57.7	3.6	5.0
52 HP	60	380	Min.:342, Max.:418	109.1	120.0	125	23.6	63.0	62.0	3.6	5.0
54 HP	60	380	Min.:342, Max.:418	107.3	118.0	125	23.6	60.5	60.6	4.8	7.5
56 HP	60	380	Min.:342, Max.:418	110.8	123.0	125	25.2	61.1	60.6	4.8	7.5
58 HP	60	380	Min.:342, Max.:418	115.5	127.0	150	25.2	64.1	64.5	4.8	7.5
60 HP	60	380	Min.:342, Max.:418	117.6	130.0	150	25.2	68.5	69.9	4.8	7.5
62 HP	60	380	Min.:342, Max.:418	127.0	141.0	150	29.5	70.7	69.9	4.8	7.5
64 HP	60	380	Min.:342, Max.:418	134.5	148.0	150	29.5	75.0	74.4	4.8	7.5
66 HP	60	380	Min.:342, Max.:418	134.2	149.0	150	29.5	77.8	78.4	4.8	7.5
68 HP	60	380	Min.:342, Max.:418	136.4	150.0	150	29.5	79.9	79.3	5.4	7.5
70 HP	60	380	Min.:342, Max.:418	140.9	155.0	150	31.1	80.6	79.3	5.4	7.5
72 HP	60	380	Min.:342, Max.:418	143.2	159.0	175	31.1	83.5	83.2	5.4	7.5
74 HP	60	380	Min.:342, Max.:418	146.6	162.0	175	31.1	87.9	88.6	5.4	7.5
76 HP	60	380	Min.:342, Max.:418	160.0	176.0	175	35.4	90.2	88.7	5.4	7.5
78 HP	60	380	Min.:342, Max.:418	163.6	180.0	200	35.4	94.4	93.0	5.4	7.5
80 HP	60	380	Min.:342, Max.:418	161.8	178.0	200	35.4	91.9	91.6	6.6	10.0
82 HP	60	380	Min.:342, Max.:418	166.4	183.0	200	37.0	92.6	91.6	6.6	10.0
84 HP	60	380	Min.:342, Max.:418	168.5	187.0	200	37.0	95.5	95.5	6.6	10.0
86 HP	60	380	Min.:342, Max.:418	171.2	190.0	200	37.0	100.0	100.9	6.6	10.0
88 HP	60	380	Min.:342, Max.:418	185.5	204.0	200	41.3	102.2	101.1	6.6	10.0
90 HP	60	380	Min.:342, Max.:418	189.1	208.0	200	41.3	106.5	105.3	6.6	10.0
92 HP	60	380	Min.:342, Max.:418	188.2	207.0	200	42.9	109.3	109.5	7.2	10.0
94 HP	60	380	Min.:342, Max.:418	190.9	210.0	200	41.3	111.4	110.2	7.2	10.0
96 HP	60	380	Min.:342, Max.:418	195.5	215.0	250	42.9	112.0	110.2	7.2	10.0

Note

1. Voltage supplied to the unit terminals should be within the minimum and maximum range.
2. Maximum allowable voltage unbalance between phase is 2%.
3. MSC means the Max. current during the starting of compressor.
4. MSC and RLA are measured as the compressor only test condition.
5. OFM are measured as the outdoor unit test condition.
6. TOCA means the total over current value of each outdoor unit.
7. Select the wire size based on the larger value among MCA or TOCA.
8. MFA is recommended fuse amps.
9. TOCA is minimum required amperes for selecting the circuit breaker and ground fault circuit interrupter. Please select the circuit breaker size equal or greater than TOCA.
All installation site must require attachment of an earth leakage breaker.[Circuit breaker type is ELCB (Earth Leakage Circuit Breaker)].
10. Select the electrical equipment of combination unit according to the electrical characteristics of individual unit.

Symbols

- MCA** : Minimum Circuit Amperes (A)
TOCA : Total Over Current Amperes (A)
MFA : Maximum Fuse Amperes (A)
MSC : Maximum Starting Current (A)
RLA : Rated Load Amperes (A)
OFM : Outdoor Fan Motor
kW : Fan Motor rated output (kW)
FLA : Full Load Amperes (A)

6. Electric Characteristics

Model	Unit			Power Supply			COMP			OFM	
	Hz	Volts	Voltage-range	MCA	TOCA	MFA	MSC	RLA (Cooling)	RLA(Heating)	kW	FLA
98 HP	60	380	Min.:342, Max.:418	199.1	219.0	250	42.9	115.0	114.2	7.2	10.0
100 HP	60	380	Min.:342, Max.:418	201.8	222.0	250	42.9	119.4	119.6	7.2	10.0
102 HP	60	380	Min.:342, Max.:418	214.5	236.0	250	47.2	121.7	119.7	7.2	10.0
104 HP	60	380	Min.:342, Max.:418	218.2	240.0	250	47.2	125.9	124.0	7.2	10.0

Note

1. Voltage supplied to the unit terminals should be within the minimum and maximum range.
2. Maximum allowable voltage unbalance between phase is 2%.
3. MSC means the Max. current during the starting of compressor.
4. MSC and RLA are measured as the compressor only test condition.
5. OFM are measured as the outdoor unit test condition.
6. TOCA means the total over current value of each outdoor unit.
7. Select the wire size based on the larger value among MCA or TOCA.
8. MFA is recommended fuse amps.
9. TOCA is minimum required amperes for selecting the circuit breaker and ground fault circuit interrupter. Please select the circuit breaker size equal or greater than TOCA. All installation site must require attachment of an earth leakage breaker.[Circuit breaker type is ELCB (Earth Leakage Circuit Breaker)].
10. Select the electrical equipment of combination unit according to the electrical characteristics of individual unit.

Symbols

- MCA** : Minimum Circuit Amperes (A)
TOCA : Total Over Current Amperes (A)
MFA : Maximum Fuse Amperes (A)
MSC : Maximum Starting Current (A)
RLA : Rated Load Amperes (A)
OFM : Outdoor Fan Motor
kW : Fan Motor rated output (kW)
FLA : Full Load Amperes (A)

7. Capacity Tables

7.1 Capacity Tables_Cooling

7.1.1 Single Unit

◆ ARUN080LLS5

Combination (%)	Outdoor air temp (°C DB)	Indoor air temp. (DB/WB, °C)												Cooling Capacity(8HP)	
		20		23		26		27		28		30		32	
		14	PI	16	PI	18	PI	19	PI	20	PI	22	PI	24	PI
130	10	22.2	2.16	26.4	2.64	28.3	3.07	29.1	3.13	29.9	3.15	31.4	3.18	32.2	3.19
	12	22.2	2.22	26.4	2.74	28.3	3.19	29.1	3.21	29.9	3.24	31.4	3.27	32.2	3.29
	14	22.2	2.29	26.4	2.84	28.3	3.31	29.1	3.34	29.9	3.36	31.4	3.39	32.2	3.42
	16	22.2	2.37	26.4	2.94	28.3	3.46	29.1	3.49	29.9	3.52	31.4	3.55	32.2	3.58
	18	22.2	2.47	26.4	3.11	28.3	3.62	29.1	3.70	29.9	3.73	31.4	3.77	32.2	3.79
	20	22.2	2.58	26.4	3.31	28.3	3.80	29.1	4.07	29.9	4.10	30.9	4.14	31.7	4.17
	21	22.2	2.65	26.4	3.43	28.3	3.88	29.1	4.31	29.9	4.34	30.8	4.38	31.6	4.41
	23	22.2	2.85	26.4	3.60	28.3	4.08	29.1	4.75	29.6	4.79	30.3	4.84	31.1	4.87
	25	22.2	3.04	26.4	3.81	28.3	4.36	28.8	5.27	29.1	5.31	29.9	5.36	30.8	5.40
	27	22.2	3.25	26.4	4.07	28.0	4.65	28.3	5.80	28.8	5.85	29.6	5.91	30.3	5.95
	29	22.2	3.46	26.4	4.36	27.5	5.00	27.9	6.38	28.3	6.41	29.1	6.47	29.9	6.50
	31	22.2	3.70	26.3	4.59	27.1	5.32	27.5	6.35	27.9	6.39	28.7	6.44	29.5	6.47
	33	22.2	3.94	25.9	4.86	26.7	5.70	27.1	6.29	27.5	6.33	28.3	6.38	29.0	6.41
	35	22.2	4.20	25.4	5.09	26.2	6.18	26.7	6.21	27.1	6.25	27.9	6.30	28.7	6.33
	37	22.2	4.48	25.1	5.34	25.9	6.10	26.2	6.13	26.7	6.16	27.4	6.22	28.2	6.24
	39	22.2	4.77	24.6	5.62	25.4	6.01	25.9	6.04	26.2	6.08	27.1	6.14	27.9	6.16
	41	21.6	5.06	23.6	5.90	24.4	5.93	24.8	5.96	25.2	6.00	26.0	6.05	26.7	6.08
	43	21.1	5.34	22.6	5.82	23.4	5.85	23.8	5.88	24.2	5.92	25.0	5.97	25.7	5.99
46	19.8	5.71	20.6	5.70	21.4	5.73	21.7	5.76	22.2	5.79	22.9	5.84	23.5	5.87	
48	17.5	5.55	17.9	5.57	18.6	5.58	18.9	5.60	19.3	5.64	19.9	5.68	20.5	5.70	
120	10	20.1	1.95	23.9	2.39	26.1	2.84	26.9	3.06	27.7	3.11	29.2	3.13	29.9	3.15
	12	20.1	2.00	23.9	2.47	26.1	2.95	26.9	3.13	27.7	3.23	29.2	3.27	29.9	3.29
	14	20.1	2.07	23.9	2.55	26.1	3.07	26.9	3.25	27.7	3.35	29.2	3.40	29.9	3.42
	16	20.1	2.14	23.9	2.66	26.1	3.19	26.9	3.37	27.7	3.50	29.2	3.54	29.9	3.57
	18	20.1	2.23	23.9	2.77	26.1	3.32	26.9	3.55	27.7	3.68	29.2	3.72	29.9	3.75
	20	20.1	2.31	23.9	2.94	26.1	3.49	26.9	3.73	27.7	3.88	29.2	3.93	29.9	3.96
	21	20.1	2.38	23.9	3.05	26.1	3.59	26.9	3.84	27.7	4.00	29.2	4.05	29.9	4.09
	23	20.1	2.55	23.9	3.26	26.1	3.85	26.9	4.08	27.7	4.27	29.2	4.31	29.9	4.35
	25	20.1	2.72	23.9	3.49	26.1	4.06	26.9	4.35	27.7	4.58	28.8	4.62	29.5	4.65
	27	20.1	2.90	23.9	3.74	26.1	4.32	26.9	4.65	27.7	4.92	28.4	4.95	29.1	4.99
	29	20.1	3.10	23.9	3.99	26.1	4.55	26.9	4.98	27.2	5.24	27.9	5.32	28.7	5.36
	31	20.1	3.30	23.9	4.26	26.1	4.78	26.5	5.33	26.9	5.62	27.6	5.72	28.3	5.77
	33	20.1	3.51	23.9	4.54	25.7	5.06	26.1	5.79	26.4	6.04	27.1	6.11	27.9	6.16
	35	20.1	3.74	23.9	4.84	25.3	5.35	25.6	6.38	26.1	6.41	26.8	6.43	27.5	6.48
	37	20.1	4.02	23.9	5.11	24.9	5.71	25.3	6.24	25.6	6.27	26.4	6.29	27.1	6.34
	39	20.1	4.33	23.8	5.40	24.5	6.05	24.8	6.11	25.2	6.14	26.0	6.16	26.7	6.21
	41	19.6	4.63	22.7	5.69	23.5	5.93	23.8	5.98	24.2	6.01	24.9	6.03	25.6	6.08
	43	19.1	4.95	21.8	5.61	22.6	5.80	22.9	5.86	23.2	5.89	23.9	5.90	24.6	5.95
46	17.9	5.32	19.9	5.47	20.6	5.62	20.9	5.66	21.2	5.69	21.9	5.71	22.5	5.75	
48	15.8	5.21	17.3	5.37	17.9	5.51	18.2	5.54	18.4	5.56	19.0	5.58	19.6	5.60	
110	10	18.0	1.75	21.4	2.13	24.0	2.53	24.6	2.74	26.2	2.95	26.8	3.03	28.6	3.09
	12	18.0	1.81	21.4	2.21	24.0	2.64	24.6	2.82	26.2	3.06	26.8	3.16	28.6	3.24
	14	18.0	1.86	21.4	2.31	24.0	2.76	24.6	2.96	26.2	3.22	26.8	3.31	28.6	3.38
	16	18.0	1.93	21.4	2.39	24.0	2.87	24.6	3.09	26.2	3.37	26.8	3.46	28.6	3.52
	18	18.0	2.00	21.4	2.49	24.0	3.04	24.6	3.25	26.2	3.55	26.8	3.62	28.6	3.69
	20	18.0	2.07	21.4	2.61	24.0	3.22	24.6	3.40	26.2	3.72	26.8	3.81	28.6	3.88
	21	18.0	2.12	21.4	2.69	24.0	3.31	24.6	3.49	26.2	3.83	26.8	3.92	28.6	3.98
	23	18.0	2.25	21.4	2.88	24.0	3.49	24.6	3.69	26.2	4.04	26.8	4.13	28.6	4.20
	25	18.0	2.41	21.4	3.08	24.0	3.69	24.6	3.90	26.2	4.27	26.8	4.33	28.3	4.42
	27	18.0	2.57	21.4	3.29	24.0	3.90	24.6	4.13	26.2	4.46	26.8	4.56	27.8	4.64
	29	18.0	2.75	21.4	3.51	24.0	4.12	24.6	4.37	26.2	4.71	26.8	4.80	27.5	4.87
	31	18.0	2.92	21.4	3.75	24.0	4.35	24.6	4.63	25.8	4.95	26.5	5.05	27.1	5.10
	33	18.0	3.12	21.4	3.99	24.0	4.60	24.6	4.91	25.4	5.23	26.0	5.32	26.7	5.35
	35	18.0	3.31	21.4	4.26	24.0	4.85	24.6	5.20	25.0	5.52	25.6	5.57	26.3	5.60
	37	18.0	3.51	21.4	4.52	24.0	5.12	24.3	5.51	24.6	5.82	25.2	5.84	25.9	5.86
	39	18.0	3.78	21.4	4.80	23.5	5.41	23.9	5.89	24.2	6.11	24.8	6.12	25.5	6.13
	41	17.5	4.06	20.9	5.09	22.5	5.70	22.9	6.38	23.2	6.38	23.8	6.43	24.4	6.48
	43	17.1	4.26	20.4	5.30	21.6	6.05	21.9	6.12	22.2	6.10	22.9	6.14	23.4	6.15
46	16.0	4.16	19.1	5.11	19.7	5.74	20.0	5.74	20.3	5.79	20.9	5.82	21.4	5.84	
48	14.2	4.04	16.6	4.93	17.1	5.46	17.4	5.50	17.6	5.52	18.2	5.54	18.7	5.56	

Note

1. TC: Total Capacity(kW), PI : Power Input(kW, Comp. + Outdoor fan motor)
2. Capacity tables show the average value of conditions which may occur.

7. Capacity Tables

Combination (%)	Outdoor air temp (°C DB)	Indoor air temp. (DB/WB, °C)														Cooling Capacity(8HP)	
		20		23		26		27		28		30		32		TC	PI
		14		16		18		19		20		22		24			
		TC	PI	TC	PI	TC	PI	TC	PI	TC	PI	TC	PI	TC	PI		
100	10	15.1	1.58	18.0	1.92	21.0	2.27	22.4	2.46	23.8	2.64	26.4	2.94	27.0	2.96	2.96	
	12	15.1	1.63	18.0	1.99	21.0	2.35	22.4	2.52	23.8	2.72	26.4	3.10	27.0	3.13	3.13	
	14	15.1	1.68	18.0	2.07	21.0	2.45	22.4	2.63	23.8	2.84	26.4	3.27	27.0	3.30	3.30	
	16	15.1	1.73	18.0	2.14	21.0	2.55	22.4	2.76	23.8	2.99	26.4	3.43	27.0	3.47	3.47	
	18	15.1	1.78	18.0	2.22	21.0	2.65	22.4	2.89	23.8	3.17	26.4	3.62	27.0	3.65	3.65	
	20	15.1	1.84	18.0	2.31	21.0	2.81	22.4	3.10	23.8	3.40	26.4	3.79	27.0	3.82	3.82	
	21	15.1	1.88	18.0	2.36	21.0	2.90	22.4	3.20	23.8	3.52	26.4	3.88	27.0	3.91	3.91	
	23	15.1	1.99	18.0	2.53	21.0	3.12	22.4	3.44	23.8	3.77	26.4	4.06	27.0	4.10	4.10	
	25	15.1	2.12	18.0	2.69	21.0	3.33	22.4	3.68	23.8	4.04	26.4	4.24	26.8	4.27	4.27	
	27	15.1	2.26	18.0	2.87	21.0	3.56	22.4	3.93	23.8	4.29	25.9	4.44	26.5	4.47	4.47	
	29	15.1	2.41	18.0	3.07	21.0	3.80	22.4	4.20	23.8	4.54	25.4	4.61	26.1	4.65	4.65	
	31	15.1	2.57	18.0	3.27	21.0	4.05	22.4	4.48	23.8	4.77	25.1	4.79	25.7	4.83	4.83	
	33	15.1	2.73	18.0	3.48	21.0	4.33	22.4	4.78	23.8	4.95	24.7	4.97	25.3	5.01	5.01	
	35	15.1	2.90	18.0	3.71	21.0	4.61	22.4	5.10	23.5	5.13	24.2	5.15	24.8	5.19	5.19	
	37	15.1	3.11	18.0	3.98	21.0	4.88	22.4	5.34	23.1	5.37	23.8	5.39	24.3	5.44	5.44	
	39	15.1	3.33	18.0	4.27	21.0	5.17	22.4	5.60	22.7	5.63	23.4	5.65	23.9	5.70	5.70	
	41	14.9	3.56	17.7	4.57	20.6	5.46	21.5	5.87	22.0	5.89	22.5	5.91	23.2	5.96	5.96	
	43	14.4	3.77	17.1	4.84	19.9	5.72	20.6	6.09	20.8	6.11	21.5	6.13	22.1	6.19	6.19	
46	13.5	4.05	16.0	5.22	18.7	6.07	18.8	6.38	19.0	6.39	19.6	6.41	20.2	6.47	6.47		
48	11.9	3.50	14.2	4.51	16.1	5.19	16.4	5.41	16.5	5.43	17.1	5.44	17.5	5.48	5.48		
90	10	13.6	1.33	16.2	1.60	18.9	1.89	20.2	2.03	21.4	2.19	24.1	2.45	26.7	2.73	2.73	
	12	13.6	1.35	16.2	1.63	18.9	1.92	20.2	2.08	21.4	2.24	24.1	2.50	26.7	2.77	2.77	
	14	13.6	1.37	16.2	1.66	18.9	1.96	20.2	2.12	21.4	2.28	24.1	2.55	26.7	2.83	2.83	
	16	13.6	1.40	16.2	1.69	18.9	2.00	20.2	2.16	21.4	2.32	24.1	2.60	26.7	2.88	2.88	
	18	13.6	1.42	16.2	1.72	18.9	2.03	20.2	2.21	21.4	2.37	24.1	2.65	26.7	3.02	3.02	
	20	13.6	1.45	16.2	1.76	18.9	2.08	20.2	2.25	21.4	2.46	24.1	2.84	26.7	3.17	3.17	
	21	13.6	1.46	16.2	1.77	18.9	2.12	20.2	2.32	21.4	2.55	24.1	2.89	26.7	3.24	3.24	
	23	13.6	1.50	16.2	1.85	18.9	2.26	20.2	2.49	21.4	2.73	24.1	3.06	26.4	3.39	3.39	
	25	13.6	1.57	16.2	1.97	18.9	2.42	20.2	2.66	21.4	2.92	24.1	3.27	26.0	3.54	3.54	
	27	13.6	1.68	16.2	2.10	18.9	2.58	20.2	2.84	21.4	3.12	24.1	3.48	25.6	3.70	3.70	
	29	13.6	1.77	16.2	2.24	18.9	2.76	20.2	3.04	21.4	3.33	24.1	3.69	25.2	3.85	3.85	
	31	13.6	1.89	16.2	2.39	18.9	2.94	20.2	3.24	21.4	3.55	24.1	3.87	24.8	4.00	4.00	
	33	13.6	2.01	16.2	2.54	18.9	3.14	20.2	3.45	21.4	3.77	24.1	4.06	24.4	4.15	4.15	
	35	13.6	2.13	16.2	2.70	18.9	3.33	20.2	3.68	21.4	4.00	23.7	4.29	24.1	4.39	4.39	
	37	13.6	2.26	16.2	2.87	18.9	3.56	20.2	3.91	21.4	4.22	23.3	4.48	23.7	4.58	4.58	
	39	13.6	2.40	16.2	3.05	18.9	3.76	20.2	4.16	21.4	4.44	22.9	4.73	23.3	4.78	4.78	
	41	13.3	2.68	15.8	3.38	18.4	4.13	19.6	4.55	20.9	4.79	21.9	4.98	22.3	5.10	5.10	
	43	12.9	2.89	15.4	3.65	17.9	4.51	19.2	4.90	20.4	5.14	21.0	5.33	21.4	5.40	5.40	
46	12.1	3.26	14.5	4.16	16.8	5.14	18.0	5.55	18.5	5.71	19.2	5.86	19.6	5.86	5.86		
48	10.7	2.85	12.8	3.64	14.9	4.50	15.9	4.84	16.1	4.92	16.7	5.04	17.0	5.05	5.05		
80	10	12.1	1.13	14.4	1.36	16.7	1.59	17.9	1.72	19.1	1.85	21.4	2.10	23.8	2.29	2.29	
	12	12.1	1.15	14.4	1.37	16.7	1.63	17.9	1.75	19.1	1.88	21.4	2.14	23.8	2.33	2.33	
	14	12.1	1.17	14.4	1.41	16.7	1.65	17.9	1.78	19.1	1.91	21.4	2.18	23.8	2.38	2.38	
	16	12.1	1.19	14.4	1.43	16.7	1.68	17.9	1.81	19.1	1.95	21.4	2.23	23.8	2.42	2.42	
	18	12.1	1.21	14.4	1.45	16.7	1.71	17.9	1.85	19.1	1.99	21.4	2.27	23.8	2.47	2.47	
	20	12.1	1.23	14.4	1.48	16.7	1.75	17.9	1.88	19.1	2.03	21.4	2.36	23.8	2.62	2.62	
	21	12.1	1.24	14.4	1.50	16.7	1.77	17.9	1.91	19.1	2.07	21.4	2.43	23.8	2.69	2.69	
	23	12.1	1.26	14.4	1.52	16.7	1.85	17.9	2.03	19.1	2.21	21.4	2.57	23.8	2.82	2.82	
	25	12.1	1.31	14.4	1.63	16.7	1.98	17.9	2.17	19.1	2.37	21.4	2.75	23.8	3.02	3.02	
	27	12.1	1.39	14.4	1.73	16.7	2.11	17.9	2.32	19.1	2.53	21.4	2.92	23.8	3.18	3.18	
	29	12.1	1.48	14.4	1.85	16.7	2.25	17.9	2.47	19.1	2.70	21.4	3.13	23.8	3.40	3.40	
	31	12.1	1.57	14.4	1.96	16.7	2.40	17.9	2.63	19.1	2.87	21.4	3.32	23.8	3.57	3.57	
	33	12.1	1.66	14.4	2.09	16.7	2.55	17.9	2.80	19.1	3.06	21.4	3.50	23.8	3.74	3.74	
	35	12.1	1.77	14.4	2.21	16.7	2.72	17.9	2.98	19.1	3.27	21.4	3.71	23.5	3.88	3.88	
	37	12.1	1.87	14.4	2.35	16.7	2.88	17.9	3.17	19.1	3.47	21.4	3.91	23.1	4.06	4.06	
	39	12.1	1.98	14.4	2.49	16.7	3.08	17.9	3.41	19.1	3.73	21.4	4.13	22.7	4.28	4.28	
	41	11.8	2.19	14.0	2.76	16.3	3.38	17.5	3.74	18.6	4.10	20.9	4.60	21.8	4.74	4.74	
	43	11.5	2.41	13.7	3.01	15.9	3.69	17.0	4.07	18.2	4.48	20.4	4.92	20.9	5.08	5.08	
46	10.8	2.68	12.8	3.39	14.9	4.16	16.0	4.54	17.0	5.05	18.6	5.37	19.1	5.46	5.46		
48	9.5	2.34	11.3	2.96	13.2	3.64	14.1	3.96	15.1	4.42	16.2	4.65	16.6	4.70	4.70		

Note

1. TC: Total Capacity(kW), PI : Power Input(kW, Comp. + Outdoor fan motor)
2. Capacity tables show the average value of conditions which may occur.

7. Capacity Tables

Combination (%)	Outdoor air temp (°C DB)	Indoor air temp. (DB/WB, °C)														Cooling Capacity(8HP)	
		20		23		26		27		28		30		32		TC	PI
		14		16		18		19		20		22		24			
		TC	PI	TC	PI	TC	PI	TC	PI	TC	PI	TC	PI	TC	PI		
70	10	10.6	1.01	12.6	1.20	14.6	1.39	15.7	1.50	16.7	1.60	18.7	1.82	20.8	2.04		
	12	10.6	1.02	12.6	1.21	14.6	1.42	15.7	1.52	16.7	1.63	18.7	1.85	20.8	2.08		
	14	10.6	1.04	12.6	1.23	14.6	1.44	15.7	1.55	16.7	1.66	18.7	1.89	20.8	2.11		
	16	10.6	1.05	12.6	1.25	14.6	1.47	15.7	1.58	16.7	1.69	18.7	1.93	20.8	2.16		
	18	10.6	1.07	12.6	1.28	14.6	1.50	15.7	1.61	16.7	1.72	18.7	1.96	20.8	2.20		
	20	10.6	1.09	12.6	1.30	14.6	1.52	15.7	1.64	16.7	1.76	18.7	2.00	20.8	2.28		
	21	10.6	1.10	12.6	1.31	14.6	1.54	15.7	1.66	16.7	1.78	18.7	2.04	20.8	2.33		
	23	10.6	1.12	12.6	1.34	14.6	1.57	15.7	1.71	16.7	1.86	18.7	2.18	20.8	2.46		
	25	10.6	1.13	12.6	1.39	14.6	1.67	15.7	1.83	16.7	1.99	18.7	2.33	20.8	2.58		
	27	10.6	1.20	12.6	1.48	14.6	1.78	15.7	1.94	16.7	2.12	18.7	2.49	20.8	2.74		
	29	10.6	1.28	12.6	1.57	14.6	1.89	15.7	2.07	16.7	2.26	18.7	2.65	20.8	2.94		
	31	10.6	1.36	12.6	1.67	14.6	2.02	15.7	2.21	16.7	2.41	18.7	2.83	20.8	3.12		
	33	10.6	1.43	12.6	1.77	14.6	2.15	15.7	2.35	16.7	2.56	18.7	3.01	20.8	3.32		
	35	10.6	1.51	12.6	1.89	14.6	2.28	15.7	2.50	16.7	2.73	18.7	3.21	20.8	3.52		
	37	10.6	1.61	12.6	2.00	14.6	2.42	15.7	2.65	16.7	2.90	18.7	3.42	20.8	3.71		
	39	10.6	1.71	12.6	2.13	14.6	2.59	15.7	2.86	16.7	3.13	18.7	3.66	20.8	4.00		
	41	10.3	1.89	12.3	2.33	14.3	2.84	15.3	3.13	16.3	3.41	18.2	4.01	20.3	4.32		
	43	10.0	2.06	12.0	2.54	13.9	3.10	14.9	3.42	15.9	3.72	17.8	4.39	19.8	4.67		
46	9.4	2.28	11.3	2.86	13.0	3.49	14.0	3.80	14.9	4.19	16.7	4.95	18.5	5.20			
48	8.3	1.99	10.0	2.50	11.5	3.06	12.4	3.33	13.2	3.67	14.7	4.33	16.4	4.50			
60	10	9.0	0.88	10.8	1.03	12.6	1.20	13.4	1.29	14.3	1.37	16.1	1.55	17.8	1.73		
	12	9.0	0.90	10.8	1.05	12.6	1.22	13.4	1.30	14.3	1.39	16.1	1.58	17.8	1.77		
	14	9.0	0.90	10.8	1.06	12.6	1.24	13.4	1.33	14.3	1.42	16.1	1.61	17.8	1.80		
	16	9.0	0.92	10.8	1.09	12.6	1.26	13.4	1.35	14.3	1.45	16.1	1.64	17.8	1.83		
	18	9.0	0.94	10.8	1.10	12.6	1.28	13.4	1.38	14.3	1.47	16.1	1.66	17.8	1.87		
	20	9.0	0.95	10.8	1.12	12.6	1.30	13.4	1.40	14.3	1.50	16.1	1.69	17.8	1.91		
	21	9.0	0.96	10.8	1.13	12.6	1.32	13.4	1.42	14.3	1.51	16.1	1.72	17.8	1.93		
	23	9.0	0.98	10.8	1.15	12.6	1.34	13.4	1.44	14.3	1.54	16.1	1.78	17.8	2.05		
	25	9.0	0.99	10.8	1.18	12.6	1.39	13.4	1.51	14.3	1.64	16.1	1.90	17.8	2.19		
	27	9.0	1.02	10.8	1.24	12.6	1.48	13.4	1.61	14.3	1.74	16.1	2.02	17.8	2.33		
	29	9.0	1.09	10.8	1.32	12.6	1.58	13.4	1.71	14.3	1.85	16.1	2.16	17.8	2.49		
	31	9.0	1.15	10.8	1.40	12.6	1.67	13.4	1.82	14.3	1.97	16.1	2.30	17.8	2.65		
	33	9.0	1.22	10.8	1.48	12.6	1.77	13.4	1.93	14.3	2.10	16.1	2.45	17.8	2.83		
	35	9.0	1.29	10.8	1.58	12.6	1.89	13.4	2.05	14.3	2.23	16.1	2.61	17.8	3.01		
	37	9.0	1.36	10.8	1.66	12.6	2.00	13.4	2.18	14.3	2.37	16.1	2.77	17.8	3.20		
	39	9.0	1.45	10.8	1.77	12.6	2.16	13.4	2.34	14.3	2.55	16.1	2.97	17.8	3.43		
	41	8.8	1.57	10.5	1.94	12.2	2.34	13.1	2.56	14.0	2.76	15.7	3.26	17.4	3.72		
	43	8.6	1.70	10.3	2.11	11.9	2.55	12.8	2.79	13.6	3.01	15.3	3.55	17.0	4.07		
46	8.1	1.91	9.6	2.37	11.2	2.87	12.0	3.13	12.8	3.39	14.3	4.00	15.9	4.63			
48	7.1	1.66	8.5	2.07	9.9	2.51	10.6	2.74	11.3	2.96	12.7	3.50	14.1	4.05			
50	10	7.6	0.77	9.0	0.89	10.5	1.01	11.2	1.08	11.9	1.15	13.4	1.29	14.9	1.44		
	12	7.6	0.77	9.0	0.90	10.5	1.02	11.2	1.10	11.9	1.17	13.4	1.31	14.9	1.46		
	14	7.6	0.78	9.0	0.91	10.5	1.04	11.2	1.11	11.9	1.19	13.4	1.33	14.9	1.48		
	16	7.6	0.80	9.0	0.93	10.5	1.06	11.2	1.14	11.9	1.20	13.4	1.36	14.9	1.51		
	18	7.6	0.81	9.0	0.94	10.5	1.07	11.2	1.15	11.9	1.23	13.4	1.38	14.9	1.54		
	20	7.6	0.81	9.0	0.95	10.5	1.10	11.2	1.17	11.9	1.25	13.4	1.40	14.9	1.57		
	21	7.6	0.82	9.0	0.96	10.5	1.11	11.2	1.19	11.9	1.26	13.4	1.42	14.9	1.59		
	23	7.6	0.84	9.0	0.98	10.5	1.12	11.2	1.20	11.9	1.28	13.4	1.44	14.9	1.62		
	25	7.6	0.85	9.0	0.99	10.5	1.15	11.2	1.23	11.9	1.32	13.4	1.52	14.9	1.73		
	27	7.6	0.86	9.0	1.02	10.5	1.21	11.2	1.31	11.9	1.40	13.4	1.62	14.9	1.85		
	29	7.6	0.91	9.0	1.09	10.5	1.28	11.2	1.39	11.9	1.49	13.4	1.72	14.9	1.96		
	31	7.6	0.96	9.0	1.15	10.5	1.36	11.2	1.47	11.9	1.59	13.4	1.83	14.9	2.09		
	33	7.6	1.02	9.0	1.22	10.5	1.44	11.2	1.56	11.9	1.69	13.4	1.94	14.9	2.23		
	35	7.6	1.07	9.0	1.29	10.5	1.52	11.2	1.65	11.9	1.78	13.4	2.06	14.9	2.36		
	37	7.6	1.14	9.0	1.36	10.5	1.61	11.2	1.75	11.9	1.89	13.4	2.19	14.9	2.51		
	39	7.6	1.21	9.0	1.46	10.5	1.73	11.2	1.88	11.9	2.03	13.4	2.34	14.9	2.71		
	41	7.4	1.31	8.8	1.58	10.2	1.89	10.9	2.04	11.6	2.19	13.0	2.56	14.5	2.94		
	43	7.2	1.43	8.6	1.72	10.0	2.06	10.6	2.22	11.3	2.39	12.7	2.79	14.1	3.21		
46	6.7	1.60	8.1	1.93	9.3	2.31	10.0	2.50	10.6	2.68	11.9	3.14	13.3	3.61			
48	6.0	1.39	7.1	1.68	8.3	2.01	8.8	2.18	9.4	2.34	10.5	2.75	11.7	3.16			

Note

1. TC: Total Capacity(kW), PI : Power Input(kW, Comp. + Outdoor fan motor)
2. Capacity tables show the average value of conditions which may occur.

7. Capacity Tables

◆ A(C)RUN100LLS5

Combination (%)	Outdoor air temp (°C DB)	Indoor air temp. (DB/WB, °C)														Cooling Capacity(10HP)	
		20		23		26		27		28		30		32		TC	PI
		14		16		18		19		20		22		24			
		TC	PI	TC	PI	TC	PI	TC	PI	TC	PI	TC	PI	TC	PI		
130	10	27.7	2.88	33.0	3.53	35.4	4.09	36.4	4.17	37.4	4.21	39.2	4.24	40.2	4.26		
	12	27.7	2.96	33.0	3.65	35.4	4.26	36.4	4.29	37.4	4.32	39.2	4.35	40.2	4.39		
	14	27.7	3.06	33.0	3.78	35.4	4.42	36.4	4.45	37.4	4.49	39.2	4.52	40.2	4.56		
	16	27.7	3.17	33.0	3.92	35.4	4.62	36.4	4.66	37.4	4.70	39.2	4.74	40.2	4.78		
	18	27.7	3.30	33.0	4.14	35.4	4.83	36.4	4.93	37.4	4.97	39.2	5.02	40.2	5.06		
	20	27.7	3.45	33.0	4.41	35.4	5.07	36.4	5.13	37.4	5.17	38.7	5.22	39.7	5.26		
	21	27.7	3.54	33.0	4.57	35.4	5.17	36.4	5.24	37.4	5.28	38.4	5.33	39.5	5.37		
	23	27.7	3.79	33.0	4.81	35.4	5.44	36.4	5.51	37.0	5.55	37.9	5.60	38.9	5.64		
	25	27.7	4.05	33.0	5.08	35.4	5.81	36.0	5.88	36.4	5.92	37.4	5.97	38.4	6.01		
	27	27.7	4.34	33.0	5.43	35.0	6.19	35.4	6.26	36.0	6.30	37.0	6.35	37.9	6.39		
	29	27.7	4.62	33.0	5.81	34.4	6.67	34.9	6.74	35.4	6.78	36.4	6.83	37.4	6.87		
	31	27.7	4.93	32.9	6.12	33.8	7.09	34.4	7.16	34.9	7.20	35.8	7.25	36.9	7.29		
	33	27.7	5.25	32.4	6.48	33.4	7.60	33.9	7.67	34.4	7.71	35.4	7.76	36.3	7.80		
	35	27.7	5.60	31.8	6.79	32.8	8.24	33.4	8.31	33.9	8.35	34.8	8.40	35.8	8.44		
	37	27.7	5.97	31.3	7.12	32.4	8.13	32.8	8.20	33.4	8.24	34.3	8.29	35.3	8.33		
	39	27.7	6.36	30.8	7.50	31.8	8.02	32.4	8.09	32.8	8.13	33.8	8.18	34.8	8.22		
	41	27.0	6.75	29.5	7.87	30.5	7.91	31.0	7.98	31.6	8.02	32.5	8.07	33.4	8.11		
	43	26.4	7.11	28.3	7.76	29.3	7.80	29.7	7.87	30.3	7.91	31.2	7.96	32.1	7.99		
46	24.7	7.62	25.8	7.60	26.7	7.64	27.1	7.68	27.7	7.72	28.6	7.79	29.4	7.82			
48	21.8	7.40	22.4	7.43	23.2	7.44	23.6	7.46	24.1	7.53	24.9	7.57	25.6	7.60			
120	10	25.1	2.59	29.8	3.18	32.6	3.78	33.6	4.09	34.6	4.15	36.5	4.17	37.4	4.20		
	12	25.1	2.67	29.8	3.29	32.6	3.93	33.6	4.17	34.6	4.30	36.5	4.36	37.4	4.39		
	14	25.1	2.76	29.8	3.40	32.6	4.09	33.6	4.33	34.6	4.46	36.5	4.53	37.4	4.56		
	16	25.1	2.86	29.8	3.54	32.6	4.25	33.6	4.49	34.6	4.67	36.5	4.73	37.4	4.76		
	18	25.1	2.97	29.8	3.70	32.6	4.42	33.6	4.73	34.6	4.91	36.5	4.96	37.4	5.00		
	20	25.1	3.08	29.8	3.92	32.6	4.66	33.6	4.98	34.6	5.17	36.5	5.24	37.4	5.28		
	21	25.1	3.17	29.8	4.06	32.6	4.79	33.6	5.12	34.6	5.34	36.5	5.41	37.4	5.45		
	23	25.1	3.39	29.8	4.35	32.6	5.13	33.6	5.44	34.6	5.69	36.5	5.75	37.4	5.79		
	25	25.1	3.63	29.8	4.66	32.6	5.41	33.6	5.80	34.6	6.10	36.0	6.15	36.9	6.20		
	27	25.1	3.87	29.8	4.98	32.6	5.76	33.6	6.20	34.6	6.56	35.5	6.60	36.4	6.66		
	29	25.1	4.13	29.8	5.32	32.6	6.06	33.6	6.64	34.0	6.99	34.9	7.10	35.9	7.15		
	31	25.1	4.40	29.8	5.68	32.6	6.37	33.2	7.11	33.6	7.50	34.5	7.63	35.4	7.69		
	33	25.1	4.68	29.8	6.05	32.2	6.74	32.6	7.72	33.0	8.05	33.9	8.14	34.8	8.21		
	35	25.1	4.98	29.8	6.45	31.6	7.14	32.1	8.50	32.6	8.54	33.5	8.57	34.4	8.64		
	37	25.1	5.36	29.8	6.81	31.2	7.61	31.6	8.32	32.1	8.36	32.9	8.39	33.8	8.45		
	39	25.1	5.77	29.7	7.20	30.6	8.07	31.1	8.15	31.5	8.19	32.5	8.22	33.4	8.28		
	41	24.5	6.18	28.4	7.58	29.4	7.91	29.8	7.98	30.2	8.02	31.1	8.04	32.0	8.11		
	43	23.8	6.59	27.2	7.47	28.2	7.73	28.6	7.81	29.0	7.85	29.9	7.87	30.7	7.93		
46	22.3	7.09	24.8	7.30	25.7	7.49	26.1	7.55	26.5	7.59	27.3	7.61	28.1	7.67			
48	19.8	6.95	21.6	7.17	22.4	7.34	22.7	7.39	23.1	7.41	23.8	7.44	24.5	7.47			
110	10	22.5	2.33	26.8	2.85	29.9	3.38	30.8	3.66	32.7	3.94	33.5	4.05	35.8	4.11		
	12	22.5	2.41	26.8	2.94	29.9	3.52	30.8	3.76	32.7	4.08	33.5	4.22	35.8	4.31		
	14	22.5	2.48	26.8	3.07	29.9	3.68	30.8	3.95	32.7	4.29	33.5	4.41	35.8	4.51		
	16	22.5	2.57	26.8	3.19	29.9	3.83	30.8	4.12	32.7	4.49	33.5	4.61	35.8	4.69		
	18	22.5	2.67	26.8	3.32	29.9	4.05	30.8	4.34	32.7	4.73	33.5	4.83	35.8	4.92		
	20	22.5	2.76	26.8	3.48	29.9	4.30	30.8	4.54	32.7	4.96	33.5	5.09	35.8	5.17		
	21	22.5	2.82	26.8	3.59	29.9	4.41	30.8	4.66	32.7	5.10	33.5	5.23	35.8	5.31		
	23	22.5	3.01	26.8	3.85	29.9	4.65	30.8	4.92	32.7	5.39	33.5	5.51	35.8	5.60		
	25	22.5	3.21	26.8	4.10	29.9	4.92	30.8	5.20	32.7	5.70	33.5	5.78	35.3	5.89		
	27	22.5	3.43	26.8	4.39	29.9	5.19	30.8	5.50	32.7	5.95	33.5	6.08	34.8	6.19		
	29	22.5	3.66	26.8	4.68	29.9	5.49	30.8	5.83	32.7	6.29	33.5	6.39	34.4	6.49		
	31	22.5	3.90	26.8	4.99	29.9	5.80	30.8	6.18	32.2	6.60	33.1	6.73	33.8	6.80		
	33	22.5	4.15	26.8	5.32	29.9	6.13	30.8	6.54	31.8	6.97	32.5	7.09	33.4	7.13		
	35	22.5	4.41	26.8	5.68	29.9	6.47	30.8	6.93	31.2	7.36	32.0	7.43	32.9	7.47		
	37	22.5	4.68	26.8	6.03	29.9	6.83	30.4	7.35	30.7	7.76	31.6	7.79	32.3	7.81		
	39	22.5	5.04	26.8	6.40	29.4	7.21	29.8	7.86	30.3	8.15	31.0	8.16	31.9	8.17		
	41	21.9	5.41	26.1	6.78	28.1	7.60	28.6	8.50	28.9	8.50	29.8	8.57	30.5	8.64		
	43	21.4	5.68	25.5	7.06	27.0	8.06	27.4	8.15	27.8	8.14	28.6	8.18	29.3	8.20		
46	20.0	5.54	23.9	6.82	24.6	7.65	25.0	7.65	25.4	7.72	26.1	7.76	26.8	7.78			
48	17.7	5.38	20.7	6.57	21.4	7.28	21.8	7.33	22.0	7.36	22.7	7.39	23.3	7.41			

Note

1. TC: Total Capacity(kW), PI: Power Input(kW, Comp. + Outdoor fan motor)
2. Capacity tables show the average value of conditions which may occur.

7. Capacity Tables

		Cooling Capacity(10HP)													
Combination (%)	Outdoor air temp (°C DB)	Indoor air temp. (DB/WB, °C)													
		20		23		26		27		28		30		32	
		14	16	18	19	20	22	24	TC	PI	TC	PI	TC	PI	
100	10	18.9	2.10	22.5	2.55	26.2	3.03	28.0	3.27	29.8	3.52	33.0	3.92	33.8	3.95
	12	18.9	2.17	22.5	2.66	26.2	3.13	28.0	3.36	29.8	3.63	33.0	4.13	33.8	4.17
	14	18.9	2.24	22.5	2.77	26.2	3.27	28.0	3.51	29.8	3.79	33.0	4.36	33.8	4.40
	16	18.9	2.31	22.5	2.86	26.2	3.40	28.0	3.68	29.8	3.99	33.0	4.57	33.8	4.63
	18	18.9	2.37	22.5	2.96	26.2	3.54	28.0	3.85	29.8	4.23	33.0	4.83	33.8	4.87
	20	18.9	2.46	22.5	3.07	26.2	3.74	28.0	4.13	29.8	4.53	33.0	5.06	33.8	5.10
	21	18.9	2.51	22.5	3.15	26.2	3.87	28.0	4.27	29.8	4.70	33.0	5.17	33.8	5.22
	23	18.9	2.66	22.5	3.37	26.2	4.15	28.0	4.58	29.8	5.03	33.0	5.42	33.8	5.46
	25	18.9	2.83	22.5	3.59	26.2	4.44	28.0	4.90	29.8	5.38	33.0	5.65	33.5	5.69
	27	18.9	3.02	22.5	3.83	26.2	4.75	28.0	5.24	29.8	5.72	32.4	5.91	33.1	5.96
	29	18.9	3.21	22.5	4.09	26.2	5.07	28.0	5.60	29.8	6.05	31.8	6.15	32.6	6.20
	31	18.9	3.43	22.5	4.36	26.2	5.41	28.0	5.97	29.8	6.36	31.3	6.39	32.1	6.44
	33	18.9	3.64	22.5	4.65	26.2	5.77	28.0	6.37	29.8	6.60	30.8	6.63	31.6	6.68
	35	18.9	3.87	22.5	4.94	26.2	6.14	28.0	6.80	29.3	6.84	30.3	6.87	31.0	6.92
	37	18.9	4.15	22.5	5.30	26.2	6.51	28.0	7.12	28.9	7.16	29.7	7.19	30.4	7.25
	39	18.9	4.44	22.5	5.69	26.2	6.89	28.0	7.47	28.4	7.51	29.2	7.53	29.9	7.60
	41	18.6	4.74	22.1	6.09	25.8	7.28	26.9	7.82	27.5	7.85	28.1	7.88	29.0	7.95
	43	18.0	5.02	21.4	6.45	24.9	7.63	25.8	8.12	26.1	8.15	26.9	8.17	27.6	8.25
46	16.8	5.40	20.0	6.96	23.3	8.09	23.5	8.50	23.8	8.52	24.5	8.55	25.2	8.63	
48	14.9	4.66	17.7	6.02	20.1	6.92	20.4	7.21	20.7	7.24	21.3	7.25	21.9	7.31	
90	10	17.0	1.82	20.3	2.18	23.6	2.57	25.2	2.77	26.8	2.99	30.1	3.34	33.4	3.72
	12	17.0	1.84	20.3	2.22	23.6	2.62	25.2	2.83	26.8	3.05	30.1	3.41	33.4	3.78
	14	17.0	1.87	20.3	2.26	23.6	2.67	25.2	2.88	26.8	3.11	30.1	3.47	33.4	3.86
	16	17.0	1.90	20.3	2.31	23.6	2.73	25.2	2.94	26.8	3.16	30.1	3.54	33.4	3.92
	18	17.0	1.94	20.3	2.35	23.6	2.77	25.2	3.01	26.8	3.23	30.1	3.62	33.4	4.12
	20	17.0	1.97	20.3	2.39	23.6	2.83	25.2	3.06	26.8	3.35	30.1	3.87	33.4	4.32
	21	17.0	1.99	20.3	2.42	23.6	2.88	25.2	3.16	26.8	3.48	30.1	3.93	33.4	4.42
	23	17.0	2.04	20.3	2.52	23.6	3.09	25.2	3.40	26.8	3.72	30.1	4.17	32.9	4.63
	25	17.0	2.14	20.3	2.68	23.6	3.30	25.2	3.63	26.8	3.98	30.1	4.46	32.5	4.82
	27	17.0	2.28	20.3	2.86	23.6	3.52	25.2	3.88	26.8	4.25	30.1	4.74	32.0	5.05
	29	17.0	2.42	20.3	3.05	23.6	3.76	25.2	4.14	26.8	4.54	30.1	5.02	31.5	5.25
	31	17.0	2.57	20.3	3.25	23.6	4.01	25.2	4.41	26.8	4.85	30.1	5.27	31.0	5.46
	33	17.0	2.74	20.3	3.46	23.6	4.28	25.2	4.70	26.8	5.14	30.1	5.53	30.6	5.66
	35	17.0	2.91	20.3	3.68	23.6	4.54	25.2	5.01	26.8	5.45	29.6	5.85	30.1	5.98
	37	17.0	3.09	20.3	3.91	23.6	4.85	25.2	5.32	26.8	5.75	29.1	6.11	29.6	6.25
	39	17.0	3.27	20.3	4.16	23.6	5.13	25.2	5.67	26.8	6.05	28.6	6.44	29.1	6.52
	41	16.6	3.66	19.8	4.61	23.0	5.63	24.6	6.20	26.1	6.53	27.4	6.79	27.9	6.95
	43	16.2	3.95	19.3	4.98	22.4	6.15	23.9	6.67	25.5	7.00	26.3	7.27	26.8	7.36
46	15.1	4.44	18.1	5.67	21.0	7.01	22.4	7.57	23.1	7.78	24.0	7.98	24.5	7.99	
48	13.4	3.88	16.0	4.96	18.6	6.13	19.9	6.60	20.1	6.70	20.9	6.87	21.3	6.88	
80	10	15.1	1.56	18.0	1.88	20.9	2.21	22.4	2.38	23.9	2.55	26.8	2.91	29.7	3.16
	12	15.1	1.60	18.0	1.90	20.9	2.25	22.4	2.42	23.9	2.60	26.8	2.97	29.7	3.22
	14	15.1	1.62	18.0	1.95	20.9	2.28	22.4	2.47	23.9	2.64	26.8	3.02	29.7	3.29
	16	15.1	1.64	18.0	1.98	20.9	2.33	22.4	2.51	23.9	2.70	26.8	3.09	29.7	3.35
	18	15.1	1.67	18.0	2.01	20.9	2.37	22.4	2.55	23.9	2.75	26.8	3.14	29.7	3.42
	20	15.1	1.71	18.0	2.05	20.9	2.42	22.4	2.61	23.9	2.80	26.8	3.26	29.7	3.63
	21	15.1	1.72	18.0	2.08	20.9	2.45	22.4	2.64	23.9	2.87	26.8	3.36	29.7	3.72
	23	15.1	1.75	18.0	2.11	20.9	2.55	22.4	2.80	23.9	3.06	26.8	3.55	29.7	3.91
	25	15.1	1.81	18.0	2.25	20.9	2.74	22.4	3.00	23.9	3.28	26.8	3.80	29.7	4.18
	27	15.1	1.92	18.0	2.39	20.9	2.92	22.4	3.21	23.9	3.50	26.8	4.04	29.7	4.40
	29	15.1	2.04	18.0	2.55	20.9	3.11	22.4	3.41	23.9	3.74	26.8	4.33	29.7	4.70
	31	15.1	2.17	18.0	2.71	20.9	3.31	22.4	3.64	23.9	3.98	26.8	4.59	29.7	4.94
	33	15.1	2.30	18.0	2.89	20.9	3.53	22.4	3.88	23.9	4.24	26.8	4.84	29.7	5.18
	35	15.1	2.45	18.0	3.06	20.9	3.76	22.4	4.13	23.9	4.52	26.8	5.13	29.4	5.37
	37	15.1	2.59	18.0	3.26	20.9	3.99	22.4	4.39	23.9	4.80	26.8	5.41	28.9	5.61
	39	15.1	2.73	18.0	3.45	20.9	4.27	22.4	4.72	23.9	5.16	26.8	5.72	28.4	5.92
	41	14.7	3.02	17.5	3.82	20.4	4.68	21.8	5.17	23.3	5.67	26.1	6.37	27.2	6.56
	43	14.3	3.33	17.1	4.17	19.9	5.11	21.3	5.64	22.7	6.20	25.5	6.81	26.1	7.02
46	13.4	3.70	16.0	4.69	18.6	5.76	19.9	6.28	21.3	6.99	23.3	7.44	23.8	7.55	
48	11.9	3.23	14.2	4.10	16.5	5.04	17.6	5.48	18.8	6.12	20.2	6.44	20.7	6.50	

Note

1. TC: Total Capacity(kW), PI : Power Input(kW, Comp. + Outdoor fan motor)
2. Capacity tables show the average value of conditions which may occur.

7. Capacity Tables

Combination (%)	Outdoor air temp (°C DB)	Cooling Capacity(10HP)													
		Indoor air temp. (DB/WB, °C)													
		20		23		26		27		28		30		32	
		14	PI	16	PI	18	PI	19	PI	20	PI	22	PI	24	PI
70	10	13.2	1.41	15.8	1.68	18.3	1.95	19.6	2.10	20.9	2.25	23.4	2.56	26.0	2.86
	12	13.2	1.44	15.8	1.70	18.3	1.99	19.6	2.14	20.9	2.29	23.4	2.60	26.0	2.92
	14	13.2	1.46	15.8	1.72	18.3	2.03	19.6	2.17	20.9	2.33	23.4	2.66	26.0	2.97
	16	13.2	1.48	15.8	1.76	18.3	2.06	19.6	2.21	20.9	2.37	23.4	2.70	26.0	3.03
	18	13.2	1.50	15.8	1.79	18.3	2.10	19.6	2.26	20.9	2.41	23.4	2.75	26.0	3.09
	20	13.2	1.52	15.8	1.82	18.3	2.14	19.6	2.30	20.9	2.47	23.4	2.82	26.0	3.20
	21	13.2	1.55	15.8	1.84	18.3	2.16	19.6	2.33	20.9	2.49	23.4	2.86	26.0	3.27
	23	13.2	1.57	15.8	1.88	18.3	2.20	19.6	2.40	20.9	2.61	23.4	3.06	26.0	3.46
	25	13.2	1.59	15.8	1.95	18.3	2.35	19.6	2.57	20.9	2.79	23.4	3.27	26.0	3.62
	27	13.2	1.68	15.8	2.08	18.3	2.50	19.6	2.73	20.9	2.98	23.4	3.49	26.0	3.85
	29	13.2	1.79	15.8	2.20	18.3	2.66	19.6	2.90	20.9	3.17	23.4	3.73	26.0	4.13
	31	13.2	1.90	15.8	2.35	18.3	2.84	19.6	3.10	20.9	3.38	23.4	3.97	26.0	4.38
	33	13.2	2.01	15.8	2.48	18.3	3.02	19.6	3.29	20.9	3.59	23.4	4.23	26.0	4.66
	35	13.2	2.13	15.8	2.65	18.3	3.20	19.6	3.51	20.9	3.83	23.4	4.51	26.0	4.94
	37	13.2	2.26	15.8	2.81	18.3	3.41	19.6	3.73	20.9	4.07	23.4	4.80	26.0	5.21
	39	13.2	2.40	15.8	2.99	18.3	3.64	19.6	4.01	20.9	4.40	23.4	5.13	26.0	5.62
	41	12.9	2.65	15.4	3.28	17.8	3.99	19.1	4.40	20.4	4.78	22.8	5.64	25.3	6.06
	43	12.5	2.89	15.0	3.57	17.4	4.36	18.6	4.80	19.9	5.22	22.2	6.16	24.7	6.56
46	11.8	3.21	14.1	4.02	16.3	4.91	17.5	5.34	18.6	5.89	20.8	6.95	23.2	7.31	
48	10.4	2.80	12.4	3.51	14.4	4.29	15.4	4.67	16.5	5.15	18.4	6.08	20.5	6.33	
60	10	11.3	1.25	13.5	1.47	15.7	1.71	16.8	1.83	17.9	1.95	20.1	2.21	22.3	2.47
	12	11.3	1.28	13.5	1.49	15.7	1.73	16.8	1.86	17.9	1.98	20.1	2.24	22.3	2.52
	14	11.3	1.29	13.5	1.51	15.7	1.77	16.8	1.89	17.9	2.02	20.1	2.29	22.3	2.56
	16	11.3	1.31	13.5	1.55	15.7	1.79	16.8	1.92	17.9	2.06	20.1	2.33	22.3	2.61
	18	11.3	1.33	13.5	1.57	15.7	1.82	16.8	1.96	17.9	2.10	20.1	2.37	22.3	2.66
	20	11.3	1.36	13.5	1.59	15.7	1.86	16.8	1.99	17.9	2.13	20.1	2.41	22.3	2.72
	21	11.3	1.37	13.5	1.61	15.7	1.88	16.8	2.02	17.9	2.15	20.1	2.45	22.3	2.74
	23	11.3	1.39	13.5	1.64	15.7	1.90	16.8	2.05	17.9	2.20	20.1	2.54	22.3	2.92
	25	11.3	1.41	13.5	1.67	15.7	1.98	16.8	2.15	17.9	2.33	20.1	2.71	22.3	3.12
	27	11.3	1.46	13.5	1.77	15.7	2.11	16.8	2.29	17.9	2.48	20.1	2.88	22.3	3.33
	29	11.3	1.55	13.5	1.88	15.7	2.24	16.8	2.44	17.9	2.64	20.1	3.07	22.3	3.55
	31	11.3	1.64	13.5	1.99	15.7	2.38	16.8	2.60	17.9	2.81	20.1	3.28	22.3	3.78
	33	11.3	1.73	13.5	2.11	15.7	2.53	16.8	2.76	17.9	2.99	20.1	3.48	22.3	4.03
	35	11.3	1.83	13.5	2.24	15.7	2.69	16.8	2.93	17.9	3.18	20.1	3.71	22.3	4.28
	37	11.3	1.94	13.5	2.37	15.7	2.85	16.8	3.11	17.9	3.37	20.1	3.94	22.3	4.55
	39	11.3	2.06	13.5	2.52	15.7	3.07	16.8	3.34	17.9	3.63	20.1	4.22	22.3	4.88
	41	11.0	2.23	13.2	2.76	15.3	3.34	16.4	3.64	17.4	3.94	19.6	4.64	21.7	5.30
	43	10.7	2.43	12.8	3.00	14.9	3.64	16.0	3.97	17.0	4.29	19.1	5.06	21.2	5.79
46	10.1	2.72	12.0	3.37	14.0	4.09	15.0	4.46	15.9	4.83	17.9	5.70	19.9	6.60	
48	8.9	2.37	10.6	2.94	12.4	3.57	13.2	3.90	14.1	4.22	15.8	4.99	17.6	5.78	
50	10	9.5	1.11	11.3	1.28	13.1	1.46	14.0	1.56	14.9	1.65	16.7	1.86	18.6	2.07
	12	9.5	1.12	11.3	1.29	13.1	1.48	14.0	1.58	14.9	1.69	16.7	1.90	18.6	2.11
	14	9.5	1.13	11.3	1.32	13.1	1.50	14.0	1.61	14.9	1.71	16.7	1.92	18.6	2.14
	16	9.5	1.15	11.3	1.34	13.1	1.53	14.0	1.64	14.9	1.74	16.7	1.96	18.6	2.18
	18	9.5	1.16	11.3	1.35	13.1	1.55	14.0	1.67	14.9	1.77	16.7	1.99	18.6	2.22
	20	9.5	1.18	11.3	1.37	13.1	1.58	14.0	1.69	14.9	1.81	16.7	2.03	18.6	2.27
	21	9.5	1.19	11.3	1.39	13.1	1.60	14.0	1.71	14.9	1.82	16.7	2.05	18.6	2.29
	23	9.5	1.21	11.3	1.41	13.1	1.62	14.0	1.74	14.9	1.85	16.7	2.08	18.6	2.34
	25	9.5	1.22	11.3	1.43	13.1	1.65	14.0	1.77	14.9	1.91	16.7	2.19	18.6	2.50
	27	9.5	1.25	11.3	1.48	13.1	1.75	14.0	1.89	14.9	2.03	16.7	2.34	18.6	2.67
	29	9.5	1.32	11.3	1.57	13.1	1.85	14.0	2.00	14.9	2.15	16.7	2.48	18.6	2.83
	31	9.5	1.39	11.3	1.67	13.1	1.97	14.0	2.12	14.9	2.29	16.7	2.64	18.6	3.02
	33	9.5	1.47	11.3	1.76	13.1	2.08	14.0	2.25	14.9	2.43	16.7	2.81	18.6	3.21
	35	9.5	1.55	11.3	1.86	13.1	2.20	14.0	2.39	14.9	2.57	16.7	2.97	18.6	3.41
	37	9.5	1.64	11.3	1.97	13.1	2.33	14.0	2.53	14.9	2.73	16.7	3.17	18.6	3.62
	39	9.5	1.75	11.3	2.11	13.1	2.50	14.0	2.72	14.9	2.92	16.7	3.37	18.6	3.91
	41	9.2	1.89	11.0	2.28	12.8	2.73	13.6	2.95	14.5	3.17	16.3	3.70	18.1	4.25
	43	9.0	2.06	10.7	2.48	12.4	2.97	13.3	3.21	14.2	3.45	15.9	4.03	17.7	4.63
46	8.4	2.31	10.1	2.79	11.7	3.33	12.5	3.60	13.3	3.87	14.9	4.54	16.6	5.22	
48	7.4	2.01	8.9	2.43	10.3	2.91	11.0	3.14	11.7	3.38	13.2	3.97	14.7	4.56	

Note

1. TC: Total Capacity(kW), PI : Power Input(kW, Comp. + Outdoor fan motor)
2. Capacity tables show the average value of conditions which may occur.

7. Capacity Tables

◆ A(C)RUN120LLS5

Combination (%)	Outdoor air temp (°C DB)	Indoor air temp. (DB/WB, °C)														Cooling Capacity(12HP)	
		20		23		26		27		28		30		32		TC	PI
		14		16		18		19		20		22		24			
		TC	PI	TC	PI	TC	PI	TC	PI	TC	PI	TC	PI	TC	PI		
130	10	33.3	3.78	39.6	4.61	42.5	5.35	43.7	5.46	44.9	5.51	47.1	5.55	48.3	5.57		
	12	33.3	3.87	39.6	4.78	42.5	5.57	43.7	5.61	44.9	5.65	47.1	5.70	48.3	5.75		
	14	33.3	4.00	39.6	4.95	42.5	5.78	43.7	5.82	44.9	5.87	47.1	5.92	48.3	5.97		
	16	33.3	4.14	39.6	5.12	42.5	6.04	43.7	6.10	44.9	6.15	47.1	6.20	48.3	6.25		
	18	33.3	4.32	39.6	5.42	42.5	6.32	43.7	6.45	44.9	6.51	47.1	6.57	48.3	6.62		
	20	33.3	4.51	39.6	5.78	42.5	6.63	43.7	7.10	44.9	7.16	46.4	7.23	47.6	7.28		
	21	33.3	4.63	39.6	5.98	42.5	6.77	43.7	7.51	44.9	7.57	46.1	7.65	47.4	7.70		
	23	33.3	4.97	39.6	6.29	42.5	7.12	43.7	8.29	44.3	8.36	45.5	8.44	46.7	8.50		
	25	33.3	5.30	39.6	6.65	42.5	7.61	43.2	9.20	43.7	9.27	44.9	9.36	46.1	9.43		
	27	33.3	5.67	39.6	7.11	41.9	8.11	42.5	10.12	43.2	10.20	44.3	10.30	45.5	10.38		
	29	33.3	6.05	39.6	7.60	41.3	8.72	41.9	11.13	42.5	11.19	43.7	11.29	44.9	11.34		
	31	33.3	6.45	39.5	8.01	40.6	9.28	41.3	11.08	41.9	11.15	43.0	11.24	44.2	11.29		
	33	33.3	6.87	38.8	8.48	40.0	9.95	40.7	10.98	41.3	11.04	42.5	11.14	43.5	11.19		
	35	33.3	7.33	38.1	8.88	39.4	10.78	40.0	10.83	40.7	10.90	41.8	11.00	43.0	11.04		
	37	33.3	7.82	37.6	9.32	38.8	10.64	39.4	10.69	40.0	10.76	41.1	10.85	42.3	10.89		
	39	33.3	8.32	36.9	9.81	38.1	10.50	38.8	10.55	39.4	10.61	40.6	10.71	41.8	10.75		
	41	32.4	8.83	35.4	10.30	36.6	10.35	37.1	10.40	37.9	10.47	39.0	10.56	40.1	10.60		
	43	31.6	9.31	33.9	10.16	35.1	10.21	35.6	10.26	36.4	10.32	37.5	10.42	38.5	10.46		
46	29.6	9.97	30.9	9.95	32.1	10.00	32.6	10.05	33.3	10.11	34.3	10.20	35.2	10.24			
48	26.2	9.69	26.9	9.72	27.9	9.74	28.3	9.77	28.9	9.85	29.9	9.91	30.7	9.95			
120	10	30.1	3.40	35.8	4.16	39.1	4.95	40.3	5.35	41.5	5.43	43.8	5.45	44.8	5.50		
	12	30.1	3.49	35.8	4.31	39.1	5.15	40.3	5.46	41.5	5.63	43.8	5.70	44.8	5.75		
	14	30.1	3.61	35.8	4.45	39.1	5.36	40.3	5.67	41.5	5.84	43.8	5.93	44.8	5.97		
	16	30.1	3.74	35.8	4.63	39.1	5.56	40.3	5.88	41.5	6.11	43.8	6.19	44.8	6.23		
	18	30.1	3.88	35.8	4.84	39.1	5.79	40.3	6.19	41.5	6.42	43.8	6.50	44.8	6.55		
	20	30.1	4.03	35.8	5.13	39.1	6.10	40.3	6.51	41.5	6.76	43.8	6.85	44.8	6.91		
	21	30.1	4.15	35.8	5.32	39.1	6.27	40.3	6.71	41.5	6.99	43.8	7.08	44.8	7.13		
	23	30.1	4.44	35.8	5.69	39.1	6.72	40.3	7.13	41.5	7.45	43.8	7.52	44.8	7.58		
	25	30.1	4.75	35.8	6.10	39.1	7.08	40.3	7.60	41.5	7.99	43.2	8.05	44.3	8.12		
	27	30.1	5.07	35.8	6.52	39.1	7.54	40.3	8.12	41.5	8.58	42.6	8.64	43.6	8.71		
	29	30.1	5.40	35.8	6.96	39.1	7.93	40.3	8.68	40.8	9.15	41.9	9.29	43.1	9.36		
	31	30.1	5.76	35.8	7.43	39.1	8.34	39.8	9.30	40.3	9.81	41.4	9.99	42.4	10.07		
	33	30.1	6.13	35.8	7.92	38.6	8.82	39.1	10.10	39.7	10.54	40.7	10.66	41.8	10.74		
	35	30.1	6.52	35.8	8.44	37.9	9.34	38.5	11.13	39.1	11.18	40.2	11.21	41.2	11.30		
	37	30.1	7.01	35.8	8.91	37.4	9.96	37.9	10.89	38.5	10.95	39.5	10.98	40.6	11.07		
	39	30.1	7.55	35.7	9.42	36.7	10.56	37.3	10.67	37.8	10.72	39.0	10.75	40.1	10.84		
	41	29.3	8.09	34.1	9.92	35.3	10.35	35.8	10.44	36.3	10.50	37.3	10.53	38.4	10.61		
	43	28.6	8.63	32.7	9.78	33.8	10.12	34.3	10.22	34.8	10.27	35.8	10.30	36.9	10.38		
46	26.8	9.28	29.8	9.55	30.9	9.80	31.3	9.88	31.8	9.93	32.8	9.96	33.8	10.04			
48	23.7	9.09	25.9	9.38	26.8	9.61	27.3	9.67	27.7	9.70	28.5	9.74	29.4	9.78			
110	10	27.0	3.06	32.2	3.72	35.9	4.42	37.0	4.79	39.3	5.15	40.2	5.30	42.9	5.38		
	12	27.0	3.15	32.2	3.85	35.9	4.61	37.0	4.92	39.3	5.35	40.2	5.52	42.9	5.65		
	14	27.0	3.25	32.2	4.02	35.9	4.82	37.0	5.17	39.3	5.62	40.2	5.77	42.9	5.90		
	16	27.0	3.36	32.2	4.17	35.9	5.01	37.0	5.39	39.3	5.87	40.2	6.03	42.9	6.14		
	18	27.0	3.49	32.2	4.34	35.9	5.30	37.0	5.68	39.3	6.20	40.2	6.32	42.9	6.44		
	20	27.0	3.61	32.2	4.56	35.9	5.62	37.0	5.94	39.3	6.50	40.2	6.66	42.9	6.76		
	21	27.0	3.69	32.2	4.69	35.9	5.77	37.0	6.10	39.3	6.68	40.2	6.85	42.9	6.95		
	23	27.0	3.93	32.2	5.03	35.9	6.09	37.0	6.44	39.3	7.06	40.2	7.21	42.9	7.33		
	25	27.0	4.21	32.2	5.37	35.9	6.43	37.0	6.81	39.3	7.45	40.2	7.56	42.4	7.72		
	27	27.0	4.49	32.2	5.74	35.9	6.80	37.0	7.20	39.3	7.78	40.2	7.96	41.8	8.10		
	29	27.0	4.80	32.2	6.13	35.9	7.18	37.0	7.63	39.3	8.23	40.2	8.37	41.2	8.50		
	31	27.0	5.10	32.2	6.54	35.9	7.59	37.0	8.08	38.7	8.64	39.7	8.81	40.6	8.91		
	33	27.0	5.44	32.2	6.96	35.9	8.02	37.0	8.57	38.1	9.13	39.0	9.28	40.1	9.33		
	35	27.0	5.78	32.2	7.43	35.9	8.47	37.0	9.08	37.5	9.63	38.4	9.72	39.4	9.77		
	37	27.0	6.12	32.2	7.89	35.9	8.94	36.4	9.62	36.8	10.16	37.9	10.20	38.8	10.23		
	39	27.0	6.60	32.2	8.38	35.3	9.44	35.8	10.29	36.3	10.66	37.2	10.68	38.3	10.69		
	41	26.3	7.08	31.3	8.87	33.8	9.95	34.3	11.13	34.7	11.13	35.8	11.21	36.6	11.30		
	43	25.6	7.43	30.6	9.25	32.4	10.55	32.9	10.67	33.3	10.65	34.3	10.71	35.2	10.74		
46	24.0	7.25	28.6	8.93	29.5	10.01	30.0	10.01	30.4	10.10	31.4	10.16	32.2	10.18			
48	21.3	7.04	24.9	8.60	25.6	9.53	26.1	9.59	26.5	9.64	27.3	9.67	28.0	9.70			

Note

1. TC: Total Capacity(kW), PI: Power Input(kW, Comp. + Outdoor fan motor)
2. Capacity tables show the average value of conditions which may occur.

7. Capacity Tables

Combination (%)	Outdoor air temp (°C DB)	Cooling Capacity(12HP)													
		Indoor air temp. (DB/WB, °C)													
		20		23		26		27		28		30		32	
		14	16	18	19	20	22	24							
	TC	PI	TC	PI	TC	PI	TC	PI	TC	PI	TC	PI	TC	PI	
100	10	22.7	2.75	27.0	3.34	31.4	3.97	33.6	4.29	35.8	4.61	39.6	5.13	40.5	5.17
	12	22.7	2.84	27.0	3.48	31.4	4.10	33.6	4.40	35.8	4.75	39.6	5.40	40.5	5.46
	14	22.7	2.93	27.0	3.62	31.4	4.27	33.6	4.59	35.8	4.96	39.6	5.70	40.5	5.76
	16	22.7	3.02	27.0	3.74	31.4	4.46	33.6	4.81	35.8	5.22	39.6	5.98	40.5	6.06
	18	22.7	3.11	27.0	3.88	31.4	4.63	33.6	5.04	35.8	5.54	39.6	6.32	40.5	6.37
	20	22.7	3.22	27.0	4.02	31.4	4.90	33.6	5.40	35.8	5.93	39.6	6.62	40.5	6.67
	21	22.7	3.28	27.0	4.12	31.4	5.07	33.6	5.59	35.8	6.15	39.6	6.77	40.5	6.83
	23	22.7	3.48	27.0	4.41	31.4	5.44	33.6	6.00	35.8	6.59	39.6	7.09	40.5	7.15
	25	22.7	3.70	27.0	4.69	31.4	5.81	33.6	6.42	35.8	7.04	39.6	7.39	40.2	7.45
	27	22.7	3.95	27.0	5.02	31.4	6.21	33.6	6.86	35.8	7.49	38.9	7.74	39.7	7.80
	29	22.7	4.21	27.0	5.35	31.4	6.64	33.6	7.33	35.8	7.92	38.2	8.05	39.1	8.12
	31	22.7	4.49	27.0	5.71	31.4	7.08	33.6	7.82	35.8	8.33	37.6	8.36	38.5	8.43
	33	22.7	4.76	27.0	6.08	31.4	7.55	33.6	8.34	35.8	8.64	37.0	8.68	37.9	8.75
	35	22.7	5.07	27.0	6.47	31.4	8.04	33.6	8.90	35.2	8.95	36.3	8.99	37.2	9.06
	37	22.7	5.43	27.0	6.94	31.4	8.52	33.6	9.32	34.6	9.37	35.6	9.41	36.5	9.49
	39	22.7	5.82	27.0	7.45	31.4	9.02	33.6	9.78	34.1	9.82	35.1	9.86	35.9	9.95
	41	22.3	6.21	26.6	7.97	30.9	9.53	32.2	10.24	32.9	10.28	33.7	10.31	34.8	10.41
	43	21.6	6.57	25.7	8.45	29.9	9.99	30.9	10.63	31.3	10.66	32.2	10.70	33.1	10.80
46	20.2	7.07	24.0	9.11	28.0	10.59	28.2	11.13	28.5	11.16	29.4	11.19	30.2	11.30	
48	17.9	6.10	21.3	7.88	24.2	9.06	24.5	9.44	24.8	9.47	25.6	9.49	26.3	9.57	
90	10	20.4	2.37	24.4	2.85	28.3	3.36	30.2	3.62	32.2	3.90	36.1	4.36	40.1	4.85
	12	20.4	2.40	24.4	2.89	28.3	3.42	30.2	3.69	32.2	3.98	36.1	4.45	40.1	4.94
	14	20.4	2.44	24.4	2.95	28.3	3.49	30.2	3.77	32.2	4.06	36.1	4.53	40.1	5.04
	16	20.4	2.49	24.4	3.01	28.3	3.56	30.2	3.84	32.2	4.13	36.1	4.62	40.1	5.12
	18	20.4	2.53	24.4	3.07	28.3	3.62	30.2	3.93	32.2	4.22	36.1	4.72	40.1	5.38
	20	20.4	2.57	24.4	3.13	28.3	3.69	30.2	4.00	32.2	4.38	36.1	5.05	40.1	5.64
	21	20.4	2.60	24.4	3.16	28.3	3.77	30.2	4.13	32.2	4.54	36.1	5.14	40.1	5.77
	23	20.4	2.66	24.4	3.29	28.3	4.03	30.2	4.43	32.2	4.86	36.1	5.45	39.5	6.04
	25	20.4	2.79	24.4	3.50	28.3	4.30	30.2	4.74	32.2	5.19	36.1	5.82	39.0	6.30
	27	20.4	2.98	24.4	3.74	28.3	4.59	30.2	5.06	32.2	5.55	36.1	6.19	38.4	6.59
	29	20.4	3.16	24.4	3.98	28.3	4.91	30.2	5.41	32.2	5.93	36.1	6.56	37.8	6.86
	31	20.4	3.36	24.4	4.25	28.3	5.23	30.2	5.76	32.2	6.33	36.1	6.88	37.2	7.12
	33	20.4	3.58	24.4	4.52	28.3	5.58	30.2	6.14	32.2	6.71	36.1	7.22	36.7	7.39
	35	20.4	3.80	24.4	4.80	28.3	5.93	30.2	6.54	32.2	7.11	35.5	7.63	36.1	7.81
	37	20.4	4.03	24.4	5.10	28.3	6.33	30.2	6.95	32.2	7.51	34.9	7.98	35.5	8.16
	39	20.4	4.26	24.4	5.43	28.3	6.70	30.2	7.40	32.2	7.90	34.4	8.41	35.0	8.51
	41	19.9	4.77	23.7	6.02	27.6	7.35	29.5	8.09	31.3	8.53	32.9	8.86	33.5	9.07
	43	19.4	5.15	23.1	6.50	26.9	8.03	28.7	8.71	30.6	9.14	31.6	9.49	32.1	9.61
46	18.2	5.80	21.7	7.41	25.2	9.15	26.9	9.88	27.8	10.16	28.8	10.42	29.4	10.43	
48	16.1	5.07	19.2	6.48	22.3	8.00	23.8	8.62	24.1	8.75	25.0	8.97	25.5	8.98	
80	10	18.1	2.04	21.6	2.46	25.1	2.88	26.9	3.11	28.7	3.34	32.2	3.81	35.6	4.13
	12	18.1	2.09	21.6	2.48	25.1	2.94	26.9	3.17	28.7	3.39	32.2	3.88	35.6	4.21
	14	18.1	2.12	21.6	2.54	25.1	2.98	26.9	3.22	28.7	3.45	32.2	3.95	35.6	4.29
	16	18.1	2.14	21.6	2.58	25.1	3.04	26.9	3.28	28.7	3.52	32.2	4.03	35.6	4.38
	18	18.1	2.19	21.6	2.63	25.1	3.10	26.9	3.34	28.7	3.59	32.2	4.10	35.6	4.47
	20	18.1	2.23	21.6	2.68	25.1	3.17	26.9	3.41	28.7	3.66	32.2	4.26	35.6	4.74
	21	18.1	2.24	21.6	2.71	25.1	3.19	26.9	3.45	28.7	3.75	32.2	4.39	35.6	4.86
	23	18.1	2.29	21.6	2.75	25.1	3.34	26.9	3.66	28.7	4.00	32.2	4.64	35.6	5.10
	25	18.1	2.37	21.6	2.94	25.1	3.58	26.9	3.92	28.7	4.29	32.2	4.96	35.6	5.46
	27	18.1	2.51	21.6	3.12	25.1	3.82	26.9	4.19	28.7	4.57	32.2	5.28	35.6	5.74
	29	18.1	2.67	21.6	3.34	25.1	4.06	26.9	4.46	28.7	4.88	32.2	5.65	35.6	6.15
	31	18.1	2.84	21.6	3.54	25.1	4.33	26.9	4.76	28.7	5.20	32.2	6.00	35.6	6.45
	33	18.1	3.01	21.6	3.78	25.1	4.61	26.9	5.07	28.7	5.54	32.2	6.32	35.6	6.77
	35	18.1	3.19	21.6	4.00	25.1	4.91	26.9	5.40	28.7	5.91	32.2	6.70	35.3	7.01
	37	18.1	3.38	21.6	4.26	25.1	5.21	26.9	5.74	28.7	6.28	32.2	7.07	34.7	7.33
	39	18.1	3.57	21.6	4.50	25.1	5.57	26.9	6.17	28.7	6.74	32.2	7.47	34.1	7.73
	41	17.7	3.95	21.0	4.99	24.4	6.12	26.2	6.76	27.9	7.41	31.3	8.32	32.7	8.57
	43	17.2	4.35	20.5	5.44	23.8	6.68	25.5	7.37	27.3	8.10	30.6	8.90	31.3	9.18
46	16.1	4.84	19.2	6.13	22.3	7.52	23.9	8.20	25.5	9.14	27.9	9.71	28.6	9.87	
48	14.3	4.23	17.0	5.36	19.8	6.58	21.2	7.16	22.6	8.00	24.3	8.41	24.9	8.50	

Note

1. TC: Total Capacity(kW), PI : Power Input(kW, Comp. + Outdoor fan motor)
2. Capacity tables show the average value of conditions which may occur.

7. Capacity Tables

Combination (%)	Outdoor air temp (°C DB)	Cooling Capacity(12HP)													
		Indoor air temp. (DB/WB, °C)													
		20		23		26		27		28		30		32	
		14	16	18	19	20	22	24							
	TC	PI	TC	PI	TC	PI	TC	PI	TC	PI	TC	PI	TC	PI	
70	10	15.8	1.85	19.0	2.20	22.0	2.55	23.5	2.75	25.1	2.94	28.1	3.35	31.2	3.74
	12	15.8	1.88	19.0	2.23	22.0	2.60	23.5	2.79	25.1	3.00	28.1	3.40	31.2	3.81
	14	15.8	1.91	19.0	2.25	22.0	2.65	23.5	2.84	25.1	3.04	28.1	3.48	31.2	3.88
	16	15.8	1.93	19.0	2.30	22.0	2.69	23.5	2.90	25.1	3.10	28.1	3.54	31.2	3.97
	18	15.8	1.96	19.0	2.34	22.0	2.75	23.5	2.95	25.1	3.16	28.1	3.59	31.2	4.04
	20	15.8	1.99	19.0	2.39	22.0	2.79	23.5	3.01	25.1	3.23	28.1	3.68	31.2	4.19
	21	15.8	2.02	19.0	2.40	22.0	2.82	23.5	3.04	25.1	3.26	28.1	3.74	31.2	4.28
	23	15.8	2.05	19.0	2.46	22.0	2.88	23.5	3.14	25.1	3.42	28.1	4.00	31.2	4.52
	25	15.8	2.08	19.0	2.55	22.0	3.07	23.5	3.36	25.1	3.65	28.1	4.28	31.2	4.74
	27	15.8	2.20	19.0	2.72	22.0	3.27	23.5	3.56	25.1	3.90	28.1	4.57	31.2	5.03
	29	15.8	2.34	19.0	2.88	22.0	3.48	23.5	3.80	25.1	4.15	28.1	4.87	31.2	5.39
	31	15.8	2.49	19.0	3.07	22.0	3.71	23.5	4.06	25.1	4.42	28.1	5.19	31.2	5.72
	33	15.8	2.63	19.0	3.24	22.0	3.94	23.5	4.31	25.1	4.70	28.1	5.53	31.2	6.09
	35	15.8	2.78	19.0	3.46	22.0	4.19	23.5	4.58	25.1	5.00	28.1	5.89	31.2	6.46
	37	15.8	2.95	19.0	3.67	22.0	4.45	23.5	4.87	25.1	5.32	28.1	6.27	31.2	6.82
	39	15.8	3.14	19.0	3.91	22.0	4.76	23.5	5.24	25.1	5.75	28.1	6.71	31.2	7.35
	41	15.4	3.47	18.5	4.28	21.4	5.22	22.9	5.75	24.4	6.25	27.4	7.37	30.4	7.93
	43	15.1	3.77	18.0	4.67	20.9	5.70	22.4	6.27	23.8	6.83	26.7	8.05	29.6	8.57
46	14.1	4.19	16.9	5.25	19.6	6.42	20.9	6.99	22.3	7.70	25.0	9.08	27.8	9.56	
48	12.5	3.66	14.9	4.59	17.3	5.61	18.5	6.10	19.8	6.73	22.1	7.95	24.6	8.27	
60	10	13.6	1.64	16.2	1.92	18.8	2.23	20.2	2.40	21.5	2.55	24.1	2.89	26.8	3.23
	12	13.6	1.67	16.2	1.95	18.8	2.26	20.2	2.43	21.5	2.59	24.1	2.93	26.8	3.29
	14	13.6	1.68	16.2	1.98	18.8	2.31	20.2	2.47	21.5	2.64	24.1	2.99	26.8	3.35
	16	13.6	1.71	16.2	2.03	18.8	2.34	20.2	2.52	21.5	2.70	24.1	3.05	26.8	3.41
	18	13.6	1.74	16.2	2.06	18.8	2.38	20.2	2.56	21.5	2.74	24.1	3.10	26.8	3.49
	20	13.6	1.77	16.2	2.09	18.8	2.43	20.2	2.61	21.5	2.79	24.1	3.16	26.8	3.56
	21	13.6	1.79	16.2	2.10	18.8	2.46	20.2	2.64	21.5	2.82	24.1	3.20	26.8	3.59
	23	13.6	1.82	16.2	2.15	18.8	2.49	20.2	2.68	21.5	2.88	24.1	3.32	26.8	3.81
	25	13.6	1.85	16.2	2.19	18.8	2.59	20.2	2.82	21.5	3.05	24.1	3.55	26.8	4.08
	27	13.6	1.91	16.2	2.31	18.8	2.76	20.2	2.99	21.5	3.25	24.1	3.77	26.8	4.35
	29	13.6	2.03	16.2	2.46	18.8	2.93	20.2	3.19	21.5	3.46	24.1	4.02	26.8	4.65
	31	13.6	2.15	16.2	2.61	18.8	3.11	20.2	3.40	21.5	3.68	24.1	4.29	26.8	4.95
	33	13.6	2.26	16.2	2.76	18.8	3.31	20.2	3.61	21.5	3.92	24.1	4.56	26.8	5.27
	35	13.6	2.40	16.2	2.93	18.8	3.52	20.2	3.83	21.5	4.16	24.1	4.86	26.8	5.60
	37	13.6	2.53	16.2	3.10	18.8	3.72	20.2	4.07	21.5	4.41	24.1	5.15	26.8	5.96
	39	13.6	2.69	16.2	3.30	18.8	4.02	20.2	4.36	21.5	4.75	24.1	5.53	26.8	6.39
	41	13.2	2.92	15.8	3.61	18.4	4.37	19.6	4.77	20.9	5.15	23.5	6.07	26.1	6.94
	43	12.9	3.17	15.4	3.93	17.9	4.76	19.2	5.19	20.4	5.62	22.9	6.62	25.4	7.58
46	12.1	3.56	14.4	4.41	16.8	5.35	18.0	5.84	19.1	6.32	21.5	7.46	23.8	8.64	
48	10.7	3.10	12.8	3.85	14.8	4.68	15.9	5.10	16.9	5.52	19.0	6.53	21.1	7.56	
50	10	11.3	1.45	13.6	1.68	15.7	1.91	16.8	2.04	17.9	2.17	20.0	2.44	22.3	2.71
	12	11.3	1.46	13.6	1.69	15.7	1.94	16.8	2.07	17.9	2.21	20.0	2.49	22.3	2.76
	14	11.3	1.48	13.6	1.72	15.7	1.97	16.8	2.10	17.9	2.24	20.0	2.52	22.3	2.81
	16	11.3	1.51	13.6	1.75	15.7	2.00	16.8	2.15	17.9	2.27	20.0	2.56	22.3	2.85
	18	11.3	1.52	13.6	1.77	15.7	2.03	16.8	2.18	17.9	2.32	20.0	2.61	22.3	2.91
	20	11.3	1.54	13.6	1.80	15.7	2.07	16.8	2.21	17.9	2.36	20.0	2.65	22.3	2.97
	21	11.3	1.56	13.6	1.81	15.7	2.09	16.8	2.24	17.9	2.38	20.0	2.68	22.3	3.00
	23	11.3	1.59	13.6	1.85	15.7	2.12	16.8	2.27	17.9	2.42	20.0	2.73	22.3	3.06
	25	11.3	1.60	13.6	1.88	15.7	2.17	16.8	2.32	17.9	2.50	20.0	2.87	22.3	3.28
	27	11.3	1.63	13.6	1.94	15.7	2.29	16.8	2.47	17.9	2.65	20.0	3.06	22.3	3.49
	29	11.3	1.72	13.6	2.06	15.7	2.42	16.8	2.62	17.9	2.82	20.0	3.25	22.3	3.71
	31	11.3	1.81	13.6	2.18	15.7	2.58	16.8	2.78	17.9	3.00	20.0	3.46	22.3	3.95
	33	11.3	1.92	13.6	2.30	15.7	2.73	16.8	2.94	17.9	3.19	20.0	3.67	22.3	4.21
	35	11.3	2.03	13.6	2.44	15.7	2.88	16.8	3.13	17.9	3.37	20.0	3.89	22.3	4.47
	37	11.3	2.15	13.6	2.58	15.7	3.05	16.8	3.31	17.9	3.57	20.0	4.15	22.3	4.74
	39	11.3	2.29	13.6	2.76	15.7	3.27	16.8	3.56	17.9	3.83	20.0	4.42	22.3	5.12
	41	11.0	2.48	13.2	2.99	15.3	3.57	16.4	3.86	17.4	4.15	19.5	4.84	21.7	5.56
	43	10.8	2.70	12.9	3.25	14.9	3.89	16.0	4.20	17.0	4.52	19.0	5.28	21.2	6.07
46	10.1	3.02	12.1	3.65	14.0	4.36	15.0	4.72	15.9	5.07	17.8	5.94	19.9	6.83	
48	8.9	2.63	10.7	3.18	12.4	3.80	13.2	4.12	14.1	4.42	15.8	5.19	17.6	5.97	

Note

1. TC: Total Capacity(kW), PI : Power Input(kW, Comp. + Outdoor fan motor)
2. Capacity tables show the average value of conditions which may occur.

7. Capacity Tables

◆ A(C)RUN140LLS5

Combination (%)	Outdoor air temp (°C DB)	Indoor air temp. (DB/WB, °C)														Cooling Capacity(14HP)	
		20		23		26		27		28		30		32		TC	PI
		14		16		18		19		20		22		24			
		TC	PI	TC	PI	TC	PI	TC	PI	TC	PI	TC	PI	TC	PI		
130	10	38.8	4.50	46.2	5.50	49.6	6.38	51.0	6.50	52.4	6.56	54.9	6.61	56.3	6.63		
	12	38.8	4.61	46.2	5.69	49.6	6.64	51.0	6.68	52.4	6.73	54.9	6.79	56.3	6.85		
	14	38.8	4.76	46.2	5.90	49.6	6.89	51.0	6.94	52.4	6.99	54.9	7.05	56.3	7.11		
	16	38.8	4.94	46.2	6.10	49.6	7.20	51.0	7.26	52.4	7.32	54.9	7.39	56.3	7.44		
	18	38.8	5.14	46.2	6.46	49.6	7.53	51.0	7.69	52.4	7.75	54.9	7.83	56.3	7.88		
	20	38.8	5.37	46.2	6.88	49.6	7.90	51.0	8.46	52.4	8.52	54.1	8.61	55.5	8.67		
	21	38.8	5.51	46.2	7.12	49.6	8.06	51.0	8.95	52.4	9.02	53.8	9.11	55.2	9.17		
	23	38.8	5.91	46.2	7.49	49.6	8.48	51.0	9.87	51.7	9.95	53.0	10.05	54.4	10.12		
	25	38.8	6.32	46.2	7.92	49.6	9.06	50.4	10.95	51.0	11.04	52.4	11.15	53.8	11.23		
	27	38.8	6.76	46.2	8.47	48.9	9.66	49.6	12.06	50.4	12.15	51.7	12.27	53.0	12.36		
	29	38.8	7.20	46.2	9.05	48.1	10.39	48.8	13.25	49.6	13.33	51.0	13.45	52.4	13.50		
	31	38.8	7.68	46.1	9.54	47.3	11.05	48.1	13.19	48.8	13.27	50.2	13.39	51.6	13.45		
	33	38.8	8.19	45.3	10.10	46.7	11.85	47.5	13.07	48.1	13.15	49.6	13.27	50.8	13.32		
	35	38.8	8.73	44.5	10.58	45.9	12.84	46.7	12.90	47.5	12.98	48.8	13.10	50.2	13.15		
	37	38.8	9.31	43.9	11.10	45.3	12.67	45.9	12.73	46.7	12.81	48.0	12.92	49.4	12.98		
	39	38.8	9.91	43.1	11.69	44.5	12.50	45.3	12.56	45.9	12.64	47.3	12.75	48.8	12.80		
	41	37.8	10.52	41.3	12.27	42.7	12.33	43.3	12.39	44.2	12.47	45.5	12.58	46.7	12.63		
	43	36.9	11.09	39.6	12.10	41.0	12.16	41.6	12.22	42.4	12.30	43.7	12.41	44.9	12.45		
46	34.6	11.87	36.1	11.85	37.4	11.91	38.0	11.97	38.8	12.04	40.0	12.15	41.1	12.19			
48	30.6	11.54	31.4	11.57	32.5	11.60	33.0	11.63	33.8	11.73	34.8	11.81	35.8	11.85			
120	10	35.1	4.05	41.8	4.96	45.7	5.89	47.0	6.37	48.4	6.47	51.1	6.50	52.3	6.55		
	12	35.1	4.15	41.8	5.13	45.7	6.13	47.0	6.50	48.4	6.71	51.1	6.79	52.3	6.85		
	14	35.1	4.30	41.8	5.30	45.7	6.38	47.0	6.75	48.4	6.96	51.1	7.06	52.3	7.12		
	16	35.1	4.45	41.8	5.52	45.7	6.63	47.0	7.00	48.4	7.28	51.1	7.37	52.3	7.43		
	18	35.1	4.63	41.8	5.77	45.7	6.89	47.0	7.37	48.4	7.65	51.1	7.74	52.3	7.80		
	20	35.1	4.80	41.8	6.11	45.7	7.26	47.0	7.76	48.4	8.06	51.1	8.16	52.3	8.23		
	21	35.1	4.95	41.8	6.34	45.7	7.46	47.0	7.99	48.4	8.32	51.1	8.43	52.3	8.49		
	23	35.1	5.29	41.8	6.78	45.7	8.00	47.0	8.49	48.4	8.87	51.1	8.96	52.3	9.03		
	25	35.1	5.65	41.8	7.26	45.7	8.44	47.0	9.05	48.4	9.51	50.5	9.59	51.7	9.67		
	27	35.1	6.03	41.8	7.76	45.7	8.98	47.0	9.67	48.4	10.22	49.7	10.29	50.9	10.37		
	29	35.1	6.44	41.8	8.29	45.7	9.45	47.0	10.34	47.7	10.90	48.9	11.06	50.3	11.15		
	31	35.1	6.86	41.8	8.85	45.7	9.94	46.4	11.08	47.0	11.69	48.3	11.90	49.5	11.99		
	33	35.1	7.30	41.8	9.43	45.0	10.51	45.7	12.03	46.3	12.55	47.5	12.69	48.7	12.79		
	35	35.1	7.76	41.8	10.06	44.3	11.12	44.9	13.25	45.7	13.32	46.9	13.36	48.1	13.46		
	37	35.1	8.35	41.8	10.61	43.6	11.86	44.3	12.97	44.9	13.04	46.1	13.08	47.4	13.18		
	39	35.1	8.99	41.6	11.22	42.9	12.58	43.5	12.70	44.1	12.77	45.5	12.81	46.7	12.91		
	41	34.2	9.63	39.8	11.82	41.2	12.33	41.7	12.44	42.3	12.50	43.6	12.54	44.8	12.64		
	43	33.4	10.28	38.1	11.65	39.5	12.05	40.0	12.17	40.6	12.23	41.8	12.27	43.0	12.37		
46	31.3	11.05	34.8	11.37	36.0	11.68	36.6	11.77	37.1	11.83	38.2	11.87	39.4	11.96			
48	27.7	10.83	30.2	11.17	31.3	11.45	31.8	11.52	32.3	11.55	33.3	11.60	34.3	11.65			
110	10	31.5	3.64	37.5	4.44	41.9	5.27	43.1	5.70	45.8	6.14	46.9	6.31	50.1	6.41		
	12	31.5	3.75	37.5	4.58	41.9	5.49	43.1	5.86	45.8	6.37	46.9	6.57	50.1	6.72		
	14	31.5	3.87	37.5	4.79	41.9	5.74	43.1	6.15	45.8	6.69	46.9	6.88	50.1	7.02		
	16	31.5	4.01	37.5	4.97	41.9	5.97	43.1	6.42	45.8	7.00	46.9	7.19	50.1	7.31		
	18	31.5	4.16	37.5	5.17	41.9	6.32	43.1	6.76	45.8	7.38	46.9	7.53	50.1	7.67		
	20	31.5	4.30	37.5	5.43	41.9	6.70	43.1	7.07	45.8	7.74	46.9	7.93	50.1	8.06		
	21	31.5	4.40	37.5	5.59	41.9	6.87	43.1	7.26	45.8	7.95	46.9	8.15	50.1	8.28		
	23	31.5	4.69	37.5	5.99	41.9	7.25	43.1	7.67	45.8	8.40	46.9	8.58	50.1	8.72		
	25	31.5	5.01	37.5	6.40	41.9	7.66	43.1	8.11	45.8	8.88	46.9	9.00	49.5	9.19		
	27	31.5	5.35	37.5	6.84	41.9	8.10	43.1	8.58	45.8	9.27	46.9	9.48	48.7	9.64		
	29	31.5	5.71	37.5	7.30	41.9	8.56	43.1	9.09	45.8	9.80	46.9	9.97	48.1	10.12		
	31	31.5	6.07	37.5	7.78	41.9	9.04	43.1	9.63	45.1	10.30	46.3	10.50	47.4	10.61		
	33	31.5	6.48	37.5	8.29	41.9	9.55	43.1	10.20	44.5	10.87	45.5	11.05	46.7	11.11		
	35	31.5	6.88	37.5	8.85	41.9	10.09	43.1	10.81	43.7	11.47	44.8	11.58	46.0	11.64		
	37	31.5	7.29	37.5	9.39	41.9	10.65	42.5	11.45	43.0	12.10	44.2	12.14	45.2	12.18		
	39	31.5	7.86	37.5	9.98	41.2	11.24	41.8	12.25	42.4	12.70	43.4	12.72	44.6	12.74		
	41	30.7	8.43	36.6	10.57	39.4	11.85	40.0	13.25	40.5	13.25	41.7	13.36	42.7	13.46		
	43	29.9	8.85	35.7	11.01	37.7	12.57	38.4	12.71	38.9	12.68	40.0	12.75	41.0	12.79		
46	28.0	8.64	33.4	10.63	34.4	11.93	35.0	11.93	35.5	12.03	36.6	12.10	37.5	12.13			
48	24.8	8.39	29.0	10.24	29.9	11.35	30.5	11.42	30.9	11.48	31.8	11.51	32.7	11.56			

Note

1. TC: Total Capacity(kW), PI : Power Input(kW, Comp. + Outdoor fan motor)
2. Capacity tables show the average value of conditions which may occur.

7. Capacity Tables

Combination (%)	Outdoor air temp (°C DB)	Cooling Capacity(14HP)													
		Indoor air temp. (DB/WB, °C)													
		20		23		26		27		28		30		32	
		14	16	18	19	20	22	24							
	TC	PI	TC	PI	TC	PI	TC	PI	TC	PI	TC	PI	TC	PI	
100	10	26.5	3.28	31.5	3.98	36.7	4.72	39.2	5.10	41.7	5.49	46.3	6.11	47.3	6.15
	12	26.5	3.38	31.5	4.15	36.7	4.88	39.2	5.24	41.7	5.66	46.3	6.43	47.3	6.50
	14	26.5	3.49	31.5	4.31	36.7	5.09	39.2	5.47	41.7	5.90	46.3	6.79	47.3	6.86
	16	26.5	3.59	31.5	4.45	36.7	5.31	39.2	5.73	41.7	6.22	46.3	7.12	47.3	7.22
	18	26.5	3.70	31.5	4.62	36.7	5.51	39.2	6.01	41.7	6.60	46.3	7.52	47.3	7.59
	20	26.5	3.83	31.5	4.79	36.7	5.83	39.2	6.44	41.7	7.06	46.3	7.89	47.3	7.95
	21	26.5	3.91	31.5	4.91	36.7	6.03	39.2	6.66	41.7	7.32	46.3	8.07	47.3	8.13
	23	26.5	4.14	31.5	5.25	36.7	6.48	39.2	7.14	41.7	7.84	46.3	8.45	47.3	8.51
	25	26.5	4.40	31.5	5.59	36.7	6.92	39.2	7.64	41.7	8.39	46.3	8.81	46.9	8.88
	27	26.5	4.71	31.5	5.97	36.7	7.40	39.2	8.17	41.7	8.92	45.4	9.22	46.3	9.29
	29	26.5	5.01	31.5	6.38	36.7	7.90	39.2	8.73	41.7	9.44	44.5	9.59	45.6	9.67
	31	26.5	5.35	31.5	6.80	36.7	8.43	39.2	9.31	41.7	9.92	43.8	9.96	44.9	10.04
	33	26.5	5.67	31.5	7.24	36.7	8.99	39.2	9.94	41.7	10.29	43.1	10.33	44.2	10.42
	35	26.5	6.03	31.5	7.70	36.7	9.57	39.2	10.60	41.1	10.66	42.4	10.71	43.4	10.79
	37	26.5	6.46	31.5	8.26	36.7	10.14	39.2	11.10	40.4	11.16	41.6	11.20	42.6	11.31
	39	26.5	6.93	31.5	8.88	36.7	10.75	39.2	11.65	39.7	11.70	40.9	11.74	41.9	11.85
	41	26.0	7.39	31.0	9.49	36.1	11.35	37.6	12.19	38.4	12.24	39.3	12.28	40.6	12.40
	43	25.1	7.83	29.9	10.06	34.9	11.89	36.1	12.66	36.5	12.70	37.6	12.74	38.6	12.86
46	23.6	8.42	28.1	10.84	32.7	12.62	32.9	13.25	33.3	13.29	34.4	13.33	35.3	13.45	
48	20.8	7.27	24.8	9.38	28.2	10.79	28.6	11.24	28.9	11.28	29.9	11.30	30.7	11.39	
90	10	23.8	2.75	28.4	3.31	33.0	3.90	35.3	4.20	37.5	4.52	42.1	5.06	46.8	5.63
	12	23.8	2.79	28.4	3.36	33.0	3.97	35.3	4.29	37.5	4.63	42.1	5.16	46.8	5.73
	14	23.8	2.84	28.4	3.43	33.0	4.05	35.3	4.37	37.5	4.71	42.1	5.26	46.8	5.85
	16	23.8	2.89	28.4	3.49	33.0	4.14	35.3	4.46	37.5	4.79	42.1	5.36	46.8	5.95
	18	23.8	2.94	28.4	3.56	33.0	4.20	35.3	4.56	37.5	4.90	42.1	5.48	46.8	6.25
	20	23.8	2.99	28.4	3.63	33.0	4.29	35.3	4.64	37.5	5.08	42.1	5.87	46.8	6.55
	21	23.8	3.02	28.4	3.66	33.0	4.37	35.3	4.79	37.5	5.27	42.1	5.96	46.8	6.69
	23	23.8	3.09	28.4	3.82	33.0	4.68	35.3	5.15	37.5	5.64	42.1	6.32	46.1	7.01
	25	23.8	3.24	28.4	4.07	33.0	5.00	35.3	5.50	37.5	6.03	42.1	6.76	45.5	7.31
	27	23.8	3.46	28.4	4.34	33.0	5.33	35.3	5.87	37.5	6.45	42.1	7.19	44.8	7.65
	29	23.8	3.66	28.4	4.63	33.0	5.71	35.3	6.28	37.5	6.89	42.1	7.61	44.1	7.96
	31	23.8	3.90	28.4	4.93	33.0	6.08	35.3	6.69	37.5	7.34	42.1	7.99	43.5	8.27
	33	23.8	4.15	28.4	5.25	33.0	6.48	35.3	7.12	37.5	7.79	42.1	8.38	42.8	8.58
	35	23.8	4.41	28.4	5.57	33.0	6.89	35.3	7.60	37.5	8.26	41.4	8.86	42.1	9.06
	37	23.8	4.68	28.4	5.93	33.0	7.34	35.3	8.07	37.5	8.72	40.7	9.26	41.5	9.47
	39	23.8	4.95	28.4	6.30	33.0	7.77	35.3	8.59	37.5	9.17	40.1	9.77	40.8	9.88
	41	23.2	5.54	27.7	6.99	32.2	8.53	34.4	9.39	36.6	9.90	38.4	10.29	39.1	10.53
	43	22.6	5.98	27.0	7.55	31.4	9.32	33.5	10.11	35.7	10.61	36.8	11.02	37.5	11.15
46	21.2	6.73	25.3	8.60	29.4	10.62	31.4	11.47	32.4	11.79	33.6	12.10	34.2	12.11	
48	18.8	5.88	22.4	7.52	26.0	9.29	27.8	10.00	28.1	10.16	29.2	10.41	29.8	10.43	
80	10	21.1	2.31	25.2	2.78	29.3	3.26	31.4	3.52	33.5	3.78	37.5	4.31	41.6	4.68
	12	21.1	2.36	25.2	2.81	29.3	3.33	31.4	3.58	33.5	3.84	37.5	4.39	41.6	4.77
	14	21.1	2.39	25.2	2.88	29.3	3.37	31.4	3.65	33.5	3.90	37.5	4.47	41.6	4.86
	16	21.1	2.43	25.2	2.92	29.3	3.44	31.4	3.71	33.5	3.98	37.5	4.56	41.6	4.95
	18	21.1	2.47	25.2	2.97	29.3	3.50	31.4	3.78	33.5	4.07	37.5	4.64	41.6	5.06
	20	21.1	2.52	25.2	3.04	29.3	3.58	31.4	3.86	33.5	4.15	37.5	4.82	41.6	5.36
	21	21.1	2.54	25.2	3.07	29.3	3.62	31.4	3.90	33.5	4.24	37.5	4.97	41.6	5.50
	23	21.1	2.59	25.2	3.12	29.3	3.78	31.4	4.15	33.5	4.53	37.5	5.25	41.6	5.78
	25	21.1	2.68	25.2	3.33	29.3	4.05	31.4	4.43	33.5	4.85	37.5	5.62	41.6	6.18
	27	21.1	2.84	25.2	3.53	29.3	4.32	31.4	4.74	33.5	5.17	37.5	5.97	41.6	6.50
	29	21.1	3.02	25.2	3.78	29.3	4.60	31.4	5.05	33.5	5.53	37.5	6.40	41.6	6.96
	31	21.1	3.21	25.2	4.00	29.3	4.90	31.4	5.38	33.5	5.88	37.5	6.79	41.6	7.30
	33	21.1	3.41	25.2	4.27	29.3	5.22	31.4	5.74	33.5	6.27	37.5	7.15	41.6	7.66
	35	21.1	3.62	25.2	4.53	29.3	5.56	31.4	6.11	33.5	6.68	37.5	7.58	41.1	7.93
	37	21.1	3.82	25.2	4.82	29.3	5.90	31.4	6.49	33.5	7.10	37.5	8.00	40.5	8.30
	39	21.1	4.04	25.2	5.09	29.3	6.31	31.4	6.98	33.5	7.63	37.5	8.46	39.8	8.75
	41	20.6	4.47	24.6	5.64	28.5	6.92	30.6	7.65	32.6	8.39	36.6	9.41	38.1	9.70
	43	20.1	4.92	23.9	6.16	27.8	7.56	29.8	8.34	31.8	9.16	35.7	10.07	36.6	10.38
46	18.8	5.48	22.4	6.94	26.1	8.51	27.9	9.28	29.8	10.34	32.6	10.99	33.4	11.17	
48	16.7	4.78	19.9	6.07	23.1	7.45	24.7	8.10	26.4	9.05	28.3	9.51	29.0	9.61	

Note

1. TC: Total Capacity(kW), PI: Power Input(kW, Comp. + Outdoor fan motor)
2. Capacity tables show the average value of conditions which may occur.

7. Capacity Tables

Combination (%)	Outdoor air temp (°C DB)	Cooling Capacity(14HP)													
		Indoor air temp. (DB/WB, °C)													
		20		23		26		27		28		30		32	
		14	16	18	19	20	22	24							
70	10	18.5	2.04	22.1	2.42	25.6	2.81	27.4	3.03	29.3	3.24	32.8	3.69	36.4	4.13
	12	18.5	2.07	22.1	2.46	25.6	2.87	27.4	3.08	29.3	3.31	32.8	3.76	36.4	4.21
	14	18.5	2.10	22.1	2.49	25.6	2.92	27.4	3.13	29.3	3.36	32.8	3.84	36.4	4.29
	16	18.5	2.14	22.1	2.54	25.6	2.97	27.4	3.20	29.3	3.42	32.8	3.90	36.4	4.38
	18	18.5	2.17	22.1	2.59	25.6	3.03	27.4	3.26	29.3	3.48	32.8	3.97	36.4	4.45
	20	18.5	2.20	22.1	2.63	25.6	3.08	27.4	3.32	29.3	3.56	32.8	4.06	36.4	4.62
	21	18.5	2.23	22.1	2.65	25.6	3.12	27.4	3.36	29.3	3.60	32.8	4.13	36.4	4.72
	23	18.5	2.26	22.1	2.71	25.6	3.18	27.4	3.47	29.3	3.77	32.8	4.42	36.4	4.99
	25	18.5	2.30	22.1	2.81	25.6	3.39	27.4	3.71	29.3	4.03	32.8	4.72	36.4	5.23
	27	18.5	2.42	22.1	3.00	25.6	3.61	27.4	3.93	29.3	4.30	32.8	5.04	36.4	5.56
	29	18.5	2.59	22.1	3.18	25.6	3.84	27.4	4.19	29.3	4.58	32.8	5.38	36.4	5.95
	31	18.5	2.75	22.1	3.39	25.6	4.09	27.4	4.48	29.3	4.88	32.8	5.73	36.4	6.32
	33	18.5	2.91	22.1	3.58	25.6	4.35	27.4	4.75	29.3	5.19	32.8	6.10	36.4	6.72
	35	18.5	3.07	22.1	3.82	25.6	4.62	27.4	5.06	29.3	5.52	32.8	6.50	36.4	7.13
	37	18.5	3.26	22.1	4.05	25.6	4.91	27.4	5.38	29.3	5.88	32.8	6.92	36.4	7.52
	39	18.5	3.46	22.1	4.32	25.6	5.25	27.4	5.79	29.3	6.35	32.8	7.41	36.4	8.11
	41	18.0	3.83	21.6	4.73	25.0	5.76	26.7	6.35	28.5	6.90	31.9	8.13	35.5	8.75
	43	17.6	4.17	21.0	5.15	24.3	6.29	26.1	6.92	27.8	7.54	31.1	8.89	34.6	9.46
46	16.5	4.63	19.7	5.79	22.8	7.08	24.4	7.71	26.1	8.50	29.2	10.02	32.4	10.55	
48	14.6	4.04	17.4	5.06	20.2	6.19	21.6	6.74	23.1	7.43	25.8	8.77	28.7	9.13	
60	10	15.8	1.77	18.9	2.07	22.0	2.41	23.5	2.58	25.1	2.74	28.1	3.11	31.2	3.48
	12	15.8	1.80	18.9	2.10	22.0	2.44	23.5	2.62	25.1	2.79	28.1	3.16	31.2	3.55
	14	15.8	1.81	18.9	2.13	22.0	2.49	23.5	2.66	25.1	2.84	28.1	3.23	31.2	3.61
	16	15.8	1.85	18.9	2.18	22.0	2.52	23.5	2.71	25.1	2.90	28.1	3.29	31.2	3.67
	18	15.8	1.88	18.9	2.21	22.0	2.57	23.5	2.76	25.1	2.95	28.1	3.34	31.2	3.75
	20	15.8	1.91	18.9	2.25	22.0	2.62	23.5	2.81	25.1	3.00	28.1	3.40	31.2	3.84
	21	15.8	1.93	18.9	2.26	22.0	2.65	23.5	2.84	25.1	3.03	28.1	3.45	31.2	3.87
	23	15.8	1.96	18.9	2.31	22.0	2.68	23.5	2.89	25.1	3.10	28.1	3.58	31.2	4.11
	25	15.8	1.99	18.9	2.36	22.0	2.79	23.5	3.03	25.1	3.29	28.1	3.82	31.2	4.40
	27	15.8	2.05	18.9	2.49	22.0	2.97	23.5	3.23	25.1	3.50	28.1	4.06	31.2	4.69
	29	15.8	2.18	18.9	2.65	22.0	3.16	23.5	3.43	25.1	3.72	28.1	4.33	31.2	5.01
	31	15.8	2.31	18.9	2.81	22.0	3.35	23.5	3.66	25.1	3.96	28.1	4.62	31.2	5.33
	33	15.8	2.44	18.9	2.97	22.0	3.56	23.5	3.88	25.1	4.22	28.1	4.91	31.2	5.68
	35	15.8	2.58	18.9	3.16	22.0	3.79	23.5	4.12	25.1	4.48	28.1	5.23	31.2	6.03
	37	15.8	2.73	18.9	3.34	22.0	4.01	23.5	4.38	25.1	4.75	28.1	5.55	31.2	6.42
	39	15.8	2.90	18.9	3.55	22.0	4.33	23.5	4.70	25.1	5.11	28.1	5.95	31.2	6.88
	41	15.4	3.15	18.4	3.89	21.4	4.70	22.9	5.13	24.4	5.55	27.4	6.53	30.4	7.47
	43	15.0	3.42	18.0	4.23	20.9	5.13	22.4	5.59	23.8	6.05	26.7	7.13	29.7	8.16
46	14.1	3.83	16.8	4.75	19.6	5.77	20.9	6.29	22.3	6.81	25.1	8.04	27.8	9.30	
48	12.5	3.34	14.9	4.15	17.3	5.04	18.5	5.49	19.7	5.95	22.2	7.03	24.6	8.14	
50	10	13.2	1.52	15.8	1.76	18.3	2.00	19.6	2.15	20.9	2.28	23.4	2.57	26.0	2.85
	12	13.2	1.54	15.8	1.78	18.3	2.04	19.6	2.18	20.9	2.33	23.4	2.61	26.0	2.90
	14	13.2	1.56	15.8	1.81	18.3	2.07	19.6	2.21	20.9	2.36	23.4	2.65	26.0	2.95
	16	13.2	1.59	15.8	1.84	18.3	2.10	19.6	2.26	20.9	2.39	23.4	2.69	26.0	3.00
	18	13.2	1.60	15.8	1.86	18.3	2.13	19.6	2.29	20.9	2.44	23.4	2.74	26.0	3.06
	20	13.2	1.62	15.8	1.89	18.3	2.18	19.6	2.33	20.9	2.49	23.4	2.79	26.0	3.13
	21	13.2	1.64	15.8	1.91	18.3	2.20	19.6	2.36	20.9	2.50	23.4	2.82	26.0	3.16
	23	13.2	1.67	15.8	1.94	18.3	2.23	19.6	2.39	20.9	2.55	23.4	2.87	26.0	3.22
	25	13.2	1.68	15.8	1.97	18.3	2.28	19.6	2.44	20.9	2.63	23.4	3.01	26.0	3.45
	27	13.2	1.72	15.8	2.04	18.3	2.41	19.6	2.60	20.9	2.79	23.4	3.22	26.0	3.67
	29	13.2	1.81	15.8	2.16	18.3	2.55	19.6	2.76	20.9	2.97	23.4	3.42	26.0	3.90
	31	13.2	1.91	15.8	2.29	18.3	2.71	19.6	2.92	20.9	3.16	23.4	3.64	26.0	4.15
	33	13.2	2.02	15.8	2.42	18.3	2.87	19.6	3.09	20.9	3.35	23.4	3.86	26.0	4.43
	35	13.2	2.13	15.8	2.57	18.3	3.03	19.6	3.29	20.9	3.54	23.4	4.09	26.0	4.70
	37	13.2	2.26	15.8	2.71	18.3	3.21	19.6	3.48	20.9	3.75	23.4	4.36	26.0	4.99
	39	13.2	2.41	15.8	2.90	18.3	3.44	19.6	3.75	20.9	4.03	23.4	4.65	26.0	5.39
	41	12.9	2.61	15.4	3.14	17.9	3.76	19.1	4.06	20.3	4.36	22.8	5.09	25.4	5.85
	43	12.6	2.83	15.0	3.42	17.4	4.09	18.6	4.42	19.8	4.75	22.2	5.55	24.7	6.38
46	11.8	3.17	14.1	3.84	16.3	4.59	17.5	4.96	18.6	5.33	20.8	6.25	23.2	7.18	
48	10.4	2.77	12.5	3.35	14.4	4.00	15.4	4.33	16.4	4.65	18.4	5.46	20.5	6.28	

Note

1. TC: Total Capacity(kW), PI : Power Input(kW, Comp. + Outdoor fan motor)
2. Capacity tables show the average value of conditions which may occur.

7. Capacity Tables

◆ A(C)RUN16 OLLS5

Combination (%)	Outdoor air temp (°C DB)	Indoor air temp. (DB/WB, °C)														Cooling Capacity(16HP)	
		20		23		26		27		28		30		32		TC	PI
		14		16		18		19		20		22		24			
		TC	PI	TC	PI	TC	PI	TC	PI	TC	PI	TC	PI	TC	PI		
130	10	44.4	5.05	52.8	6.17	56.6	7.16	58.3	7.30	59.9	7.36	62.8	7.42	64.4	7.45		
	12	44.4	5.17	52.8	6.39	56.6	7.45	58.3	7.50	59.9	7.56	62.8	7.62	64.4	7.69		
	14	44.4	5.35	52.8	6.62	56.6	7.73	58.3	7.79	59.9	7.85	62.8	7.91	64.4	7.98		
	16	44.4	5.54	52.8	6.85	56.6	8.08	58.3	8.15	59.9	8.22	62.8	8.29	64.4	8.36		
	18	44.4	5.77	52.8	7.25	56.6	8.45	58.3	8.63	59.9	8.70	62.8	8.79	64.4	8.85		
	20	44.4	6.03	52.8	7.72	56.6	8.87	58.3	9.49	59.9	9.57	61.9	9.66	63.5	9.73		
	21	44.4	6.19	52.8	7.99	56.6	9.05	58.3	10.05	59.9	10.13	61.5	10.23	63.1	10.30		
	23	44.4	6.64	52.8	8.41	56.6	9.52	58.3	11.09	59.1	11.17	60.6	11.29	62.2	11.36		
	25	44.4	7.09	52.8	8.89	56.6	10.17	57.6	12.29	58.3	12.39	59.9	12.52	61.5	12.60		
	27	44.4	7.59	52.8	9.51	55.9	10.84	56.6	13.53	57.6	13.64	59.1	13.78	60.6	13.87		
	29	44.4	8.08	52.8	10.16	55.0	11.66	55.8	14.88	56.6	14.96	58.3	15.10	59.9	15.16		
	31	44.4	8.63	52.7	10.70	54.1	12.41	55.0	14.81	55.8	14.90	57.4	15.04	59.0	15.09		
	33	44.4	9.19	51.8	11.34	53.4	13.31	54.3	14.68	55.0	14.77	56.6	14.90	58.1	14.96		
	35	44.4	9.80	50.9	11.88	52.5	14.41	53.4	14.49	54.3	14.57	55.7	14.70	57.4	14.76		
	37	44.4	10.45	50.1	12.47	51.8	14.22	52.5	14.29	53.4	14.38	54.8	14.51	56.5	14.57		
	39	44.4	11.13	49.2	13.12	50.9	14.03	51.8	14.10	52.5	14.19	54.1	14.32	55.7	14.37		
	41	43.2	11.81	47.2	13.78	48.8	13.84	49.5	13.91	50.5	14.00	52.0	14.12	53.4	14.18		
	43	42.2	12.45	45.2	13.58	46.8	13.65	47.5	13.72	48.5	13.80	50.0	13.93	51.3	13.98		
	46	39.5	13.33	41.3	13.30	42.8	13.37	43.4	13.43	44.3	13.51	45.7	13.64	47.0	13.69		
48	35.0	12.96	35.8	12.99	37.2	13.02	37.8	13.06	38.6	13.17	39.8	13.25	40.9	13.31			
120	10	40.2	4.54	47.7	5.57	52.2	6.62	53.8	7.15	55.4	7.26	58.4	7.29	59.8	7.35		
	12	40.2	4.66	47.7	5.76	52.2	6.88	53.8	7.30	55.4	7.53	58.4	7.62	59.8	7.69		
	14	40.2	4.82	47.7	5.95	52.2	7.16	53.8	7.58	55.4	7.81	58.4	7.92	59.8	7.99		
	16	40.2	5.00	47.7	6.20	52.2	7.44	53.8	7.86	55.4	8.17	58.4	8.27	59.8	8.34		
	18	40.2	5.19	47.7	6.47	52.2	7.74	53.8	8.28	55.4	8.59	58.4	8.69	59.8	8.76		
	20	40.2	5.39	47.7	6.86	52.2	8.15	53.8	8.71	55.4	9.04	58.4	9.16	59.8	9.24		
	21	40.2	5.55	47.7	7.11	52.2	8.38	53.8	8.97	55.4	9.34	58.4	9.46	59.8	9.54		
	23	40.2	5.94	47.7	7.61	52.2	8.98	53.8	9.53	55.4	9.96	58.4	10.06	59.8	10.14		
	25	40.2	6.35	47.7	8.15	52.2	9.47	53.8	10.16	55.4	10.68	57.7	10.77	59.1	10.86		
	27	40.2	6.77	47.7	8.72	52.2	10.08	53.8	10.85	55.4	11.48	56.8	11.55	58.2	11.65		
	29	40.2	7.23	47.7	9.30	52.2	10.61	53.8	11.61	54.5	12.23	55.9	12.42	57.5	12.52		
	31	40.2	7.70	47.7	9.94	52.2	11.15	53.1	12.44	53.8	13.12	55.2	13.35	56.6	13.46		
	33	40.2	8.20	47.7	10.59	51.5	11.80	52.2	13.50	52.9	14.09	54.3	14.25	55.7	14.36		
	35	40.2	8.72	47.7	11.29	50.6	12.49	51.3	14.88	52.2	14.95	53.6	14.99	55.0	15.11		
	37	40.2	9.38	47.7	11.91	49.9	13.31	50.6	14.56	51.3	14.64	52.7	14.68	54.1	14.80		
	39	40.2	10.09	47.6	12.59	49.0	14.12	49.7	14.26	50.4	14.33	52.0	14.38	53.4	14.49		
	41	39.1	10.81	45.5	13.27	47.0	13.84	47.7	13.96	48.4	14.03	49.8	14.08	51.2	14.19		
	43	38.2	11.54	43.6	13.08	45.1	13.53	45.8	13.66	46.4	13.73	47.8	13.77	49.2	13.88		
	46	35.8	12.41	39.7	12.77	41.2	13.11	41.8	13.22	42.4	13.28	43.7	13.32	45.0	13.43		
48	31.6	12.15	34.5	12.54	35.8	12.85	36.3	12.93	36.9	12.97	38.0	13.02	39.2	13.08			
110	10	36.0	4.08	42.9	4.98	47.9	5.91	49.3	6.40	52.4	6.89	53.6	7.08	57.2	7.20		
	12	36.0	4.21	42.9	5.15	47.9	6.16	49.3	6.58	52.4	7.15	53.6	7.38	57.2	7.55		
	14	36.0	4.34	42.9	5.38	47.9	6.44	49.3	6.91	52.4	7.51	53.6	7.72	57.2	7.88		
	16	36.0	4.50	42.9	5.57	47.9	6.70	49.3	7.21	52.4	7.85	53.6	8.07	57.2	8.21		
	18	36.0	4.66	42.9	5.81	47.9	7.09	49.3	7.59	52.4	8.28	53.6	8.45	57.2	8.61		
	20	36.0	4.83	42.9	6.10	47.9	7.52	49.3	7.94	52.4	8.69	53.6	8.90	57.2	9.04		
	21	36.0	4.94	42.9	6.28	47.9	7.71	49.3	8.15	52.4	8.93	53.6	9.15	57.2	9.30		
	23	36.0	5.26	42.9	6.73	47.9	8.14	49.3	8.61	52.4	9.43	53.6	9.64	57.2	9.79		
	25	36.0	5.62	42.9	7.18	47.9	8.60	49.3	9.10	52.4	9.97	53.6	10.11	56.5	10.32		
	27	36.0	6.01	42.9	7.68	47.9	9.09	49.3	9.63	52.4	10.41	53.6	10.65	55.7	10.83		
	29	36.0	6.41	42.9	8.20	47.9	9.61	49.3	10.20	52.4	11.00	53.6	11.19	55.0	11.36		
	31	36.0	6.82	42.9	8.74	47.9	10.15	49.3	10.81	51.5	11.56	52.9	11.78	54.1	11.91		
	33	36.0	7.27	42.9	9.30	47.9	10.73	49.3	11.45	50.8	12.21	52.1	12.41	53.4	12.48		
	35	36.0	7.72	42.9	9.94	47.9	11.33	49.3	12.14	50.0	12.88	51.2	13.00	52.6	13.07		
	37	36.0	8.18	42.9	10.54	47.9	11.96	48.6	12.86	49.1	13.59	50.5	13.63	51.7	13.67		
	39	36.0	8.82	42.9	11.21	47.0	12.62	47.7	13.75	48.4	14.26	49.6	14.28	51.0	14.30		
	41	35.0	9.46	41.8	11.87	45.0	13.31	45.7	14.88	46.3	14.88	47.7	14.99	48.9	15.11		
	43	34.2	9.94	40.7	12.36	43.1	14.11	43.8	14.27	44.4	14.24	45.7	14.32	46.9	14.36		
	46	32.0	9.70	38.2	11.93	39.4	13.39	40.0	13.39	40.6	13.51	41.8	13.58	42.9	13.62		
48	28.3	9.42	33.2	11.50	34.2	12.74	34.8	12.83	35.3	12.89	36.4	12.92	37.3	12.98			

Note

- 1. TC: Total Capacity(kW), PI: Power Input(kW, Comp. + Outdoor fan motor)
- 2. Capacity tables show the average value of conditions which may occur.

7. Capacity Tables

Combination (%)	Outdoor air temp (°C DB)	Cooling Capacity(16HP)													
		Indoor air temp. (DB/WB, °C)													
		20		23		26		27		28		30		32	
		14	16	18	19	20	22	24	TC	PI	TC	PI	TC	PI	
100	10	30.2	3.68	36.0	4.47	41.9	5.30	44.8	5.73	47.7	6.16	52.9	6.85	54.0	6.91
	12	30.2	3.80	36.0	4.65	41.9	5.48	44.8	5.89	47.7	6.35	52.9	7.22	54.0	7.29
	14	30.2	3.92	36.0	4.84	41.9	5.71	44.8	6.14	47.7	6.63	52.9	7.63	54.0	7.70
	16	30.2	4.03	36.0	5.00	41.9	5.96	44.8	6.43	47.7	6.99	52.9	8.00	54.0	8.11
	18	30.2	4.15	36.0	5.19	41.9	6.19	44.8	6.75	47.7	7.41	52.9	8.45	54.0	8.52
	20	30.2	4.30	36.0	5.38	41.9	6.55	44.8	7.23	47.7	7.93	52.9	8.85	54.0	8.92
	21	30.2	4.39	36.0	5.51	41.9	6.77	44.8	7.47	47.7	8.22	52.9	9.05	54.0	9.13
	23	30.2	4.65	36.0	5.89	41.9	7.27	44.8	8.02	47.7	8.81	52.9	9.48	54.0	9.56
	25	30.2	4.95	36.0	6.28	41.9	7.77	44.8	8.58	47.7	9.42	52.9	9.89	53.6	9.96
	27	30.2	5.28	36.0	6.71	41.9	8.31	44.8	9.17	47.7	10.01	51.8	10.35	52.9	10.43
	29	30.2	5.62	36.0	7.16	41.9	8.87	44.8	9.80	47.7	10.60	50.9	10.77	52.1	10.85
	31	30.2	6.01	36.0	7.63	41.9	9.46	44.8	10.45	47.7	11.13	50.1	11.18	51.3	11.27
	33	30.2	6.37	36.0	8.13	41.9	10.09	44.8	11.15	47.7	11.55	49.3	11.60	50.5	11.69
	35	30.2	6.77	36.0	8.65	41.9	10.75	44.8	11.90	47.0	11.97	48.4	12.02	49.6	12.11
	37	30.2	7.25	36.0	9.28	41.9	11.39	44.8	12.47	46.2	12.53	47.5	12.58	48.6	12.69
	39	30.2	7.78	36.0	9.96	41.9	12.06	44.8	13.08	45.4	13.13	46.7	13.18	47.8	13.31
	41	29.8	8.30	35.4	10.65	41.3	12.74	43.0	13.69	43.9	13.74	45.0	13.79	46.4	13.92
	43	28.7	8.79	34.2	11.29	39.8	13.35	41.2	14.21	41.7	14.26	43.0	14.31	44.1	14.44
46	26.9	9.45	32.1	12.17	37.3	14.16	37.6	14.88	38.0	14.92	39.3	14.96	40.3	15.10	
48	23.8	8.16	28.4	10.53	32.2	12.11	32.7	12.62	33.0	12.66	34.1	12.69	35.1	12.79	
90	10	27.2	3.08	32.5	3.71	37.8	4.37	40.3	4.71	42.9	5.07	48.2	5.67	53.4	6.31
	12	27.2	3.12	32.5	3.76	37.8	4.45	40.3	4.80	42.9	5.18	48.2	5.79	53.4	6.42
	14	27.2	3.18	32.5	3.84	37.8	4.54	40.3	4.90	42.9	5.28	48.2	5.90	53.4	6.55
	16	27.2	3.23	32.5	3.92	37.8	4.63	40.3	4.99	42.9	5.37	48.2	6.01	53.4	6.66
	18	27.2	3.29	32.5	3.99	37.8	4.71	40.3	5.11	42.9	5.49	48.2	6.14	53.4	7.00
	20	27.2	3.35	32.5	4.07	37.8	4.80	40.3	5.20	42.9	5.69	48.2	6.57	53.4	7.33
	21	27.2	3.39	32.5	4.11	37.8	4.90	40.3	5.37	42.9	5.90	48.2	6.68	53.4	7.50
	23	27.2	3.46	32.5	4.28	37.8	5.24	40.3	5.77	42.9	6.32	48.2	7.08	52.7	7.86
	25	27.2	3.63	32.5	4.56	37.8	5.60	40.3	6.17	42.9	6.75	48.2	7.58	51.9	8.19
	27	27.2	3.88	32.5	4.86	37.8	5.98	40.3	6.58	42.9	7.23	48.2	8.05	51.2	8.58
	29	27.2	4.11	32.5	5.18	37.8	6.39	40.3	7.04	42.9	7.72	48.2	8.53	50.4	8.92
	31	27.2	4.37	32.5	5.52	37.8	6.81	40.3	7.49	42.9	8.23	48.2	8.96	49.7	9.27
	33	27.2	4.65	32.5	5.88	37.8	7.26	40.3	7.98	42.9	8.73	48.2	9.39	48.9	9.61
	35	27.2	4.94	32.5	6.24	37.8	7.72	40.3	8.51	42.9	9.26	47.3	9.93	48.1	10.16
	37	27.2	5.24	32.5	6.64	37.8	8.23	40.3	9.04	42.9	9.77	46.6	10.38	47.4	10.61
	39	27.2	5.55	32.5	7.06	37.8	8.71	40.3	9.62	42.9	10.27	45.8	10.94	46.6	11.07
	41	26.5	6.21	31.6	7.83	36.8	9.56	39.3	10.52	41.8	11.09	43.9	11.53	44.7	11.80
	43	25.8	6.70	30.9	8.46	35.9	10.44	38.3	11.33	40.7	11.89	42.1	12.35	42.9	12.50
46	24.2	7.54	28.9	9.64	33.6	11.90	35.9	12.85	37.0	13.21	38.4	13.56	39.1	13.57	
48	21.4	6.59	25.6	8.43	29.7	10.41	31.8	11.21	32.2	11.39	33.4	11.67	34.0	11.68	
80	10	24.2	2.59	28.8	3.12	33.4	3.66	35.8	3.94	38.2	4.23	42.9	4.83	47.5	5.24
	12	24.2	2.65	28.8	3.15	33.4	3.73	35.8	4.02	38.2	4.30	42.9	4.92	47.5	5.34
	14	24.2	2.68	28.8	3.22	33.4	3.78	35.8	4.09	38.2	4.38	42.9	5.01	47.5	5.45
	16	24.2	2.72	28.8	3.28	33.4	3.85	35.8	4.16	38.2	4.47	42.9	5.11	47.5	5.55
	18	24.2	2.77	28.8	3.33	33.4	3.93	35.8	4.23	38.2	4.56	42.9	5.20	47.5	5.67
	20	24.2	2.83	28.8	3.40	33.4	4.02	35.8	4.32	38.2	4.65	42.9	5.40	47.5	6.01
	21	24.2	2.85	28.8	3.44	33.4	4.05	35.8	4.38	38.2	4.75	42.9	5.57	47.5	6.17
	23	24.2	2.90	28.8	3.49	33.4	4.23	35.8	4.65	38.2	5.08	42.9	5.88	47.5	6.48
	25	24.2	3.01	28.8	3.73	33.4	4.54	35.8	4.97	38.2	5.44	42.9	6.30	47.5	6.92
	27	24.2	3.19	28.8	3.96	33.4	4.84	35.8	5.31	38.2	5.80	42.9	6.69	47.5	7.28
	29	24.2	3.39	28.8	4.23	33.4	5.15	35.8	5.66	38.2	6.20	42.9	7.17	47.5	7.80
	31	24.2	3.60	28.8	4.48	33.4	5.49	35.8	6.03	38.2	6.59	42.9	7.61	47.5	8.19
	33	24.2	3.82	28.8	4.79	33.4	5.85	35.8	6.43	38.2	7.02	42.9	8.02	47.5	8.58
	35	24.2	4.05	28.8	5.08	33.4	6.23	35.8	6.84	38.2	7.49	42.9	8.50	47.0	8.89
	37	24.2	4.29	28.8	5.40	33.4	6.61	35.8	7.28	38.2	7.96	42.9	8.97	46.3	9.30
	39	24.2	4.53	28.8	5.71	33.4	7.07	35.8	7.82	38.2	8.55	42.9	9.48	45.5	9.81
	41	23.5	5.01	28.1	6.33	32.6	7.76	34.9	8.57	37.3	9.40	41.8	10.55	43.6	10.87
	43	23.0	5.52	27.4	6.90	31.8	8.47	34.1	9.34	36.3	10.27	40.7	11.29	41.8	11.64
46	21.5	6.14	25.6	7.78	29.8	9.54	31.9	10.40	34.1	11.59	37.3	12.32	38.1	12.52	
48	19.0	5.36	22.7	6.80	26.3	8.35	28.2	9.08	30.1	10.15	32.4	10.66	33.1	10.78	

Note

1. TC: Total Capacity(kW), PI : Power Input(kW, Comp. + Outdoor fan motor)
2. Capacity tables show the average value of conditions which may occur.

7. Capacity Tables

Combination (%)	Outdoor air temp (°C DB)	Cooling Capacity(16HP)													
		Indoor air temp. (DB/WB, °C)													
		20		23		26		27		28		30		32	
		14	16	18	19	20	22	24							
	TC	PI	TC	PI	TC	PI	TC	PI	TC	PI	TC	PI	TC	PI	
70	10	21.1	2.29	25.3	2.72	29.3	3.15	31.4	3.40	33.4	3.64	37.4	4.14	41.6	4.63
	12	21.1	2.32	25.3	2.75	29.3	3.22	31.4	3.46	33.4	3.71	37.4	4.21	41.6	4.72
	14	21.1	2.36	25.3	2.79	29.3	3.28	31.4	3.51	33.4	3.76	37.4	4.30	41.6	4.80
	16	21.1	2.39	25.3	2.84	29.3	3.33	31.4	3.58	33.4	3.83	37.4	4.37	41.6	4.91
	18	21.1	2.43	25.3	2.90	29.3	3.40	31.4	3.65	33.4	3.91	37.4	4.45	41.6	4.99
	20	21.1	2.47	25.3	2.95	29.3	3.46	31.4	3.73	33.4	4.00	37.4	4.55	41.6	5.18
	21	21.1	2.50	25.3	2.97	29.3	3.49	31.4	3.76	33.4	4.03	37.4	4.63	41.6	5.30
	23	21.1	2.54	25.3	3.04	29.3	3.56	31.4	3.89	33.4	4.23	37.4	4.95	41.6	5.59
	25	21.1	2.57	25.3	3.15	29.3	3.80	31.4	4.16	33.4	4.52	37.4	5.29	41.6	5.86
	27	21.1	2.72	25.3	3.37	29.3	4.05	31.4	4.41	33.4	4.82	37.4	5.65	41.6	6.23
	29	21.1	2.90	25.3	3.56	29.3	4.30	31.4	4.70	33.4	5.13	37.4	6.03	41.6	6.67
	31	21.1	3.08	25.3	3.80	29.3	4.59	31.4	5.02	33.4	5.47	37.4	6.43	41.6	7.08
	33	21.1	3.26	25.3	4.01	29.3	4.88	31.4	5.33	33.4	5.82	37.4	6.84	41.6	7.54
	35	21.1	3.44	25.3	4.29	29.3	5.18	31.4	5.67	33.4	6.19	37.4	7.29	41.6	7.99
	37	21.1	3.65	25.3	4.54	29.3	5.51	31.4	6.03	33.4	6.59	37.4	7.76	41.6	8.44
	39	21.1	3.88	25.3	4.84	29.3	5.89	31.4	6.49	33.4	7.12	37.4	8.30	41.6	9.10
	41	20.6	4.29	24.6	5.30	28.5	6.46	30.6	7.12	32.6	7.74	36.5	9.12	40.5	9.81
	43	20.1	4.67	24.0	5.78	27.8	7.05	29.8	7.76	31.8	8.45	35.6	9.96	39.5	10.61
46	18.8	5.19	22.5	6.50	26.1	7.94	27.9	8.64	29.8	9.53	33.3	11.24	37.0	11.82	
48	16.6	4.53	19.9	5.67	23.1	6.94	24.7	7.55	26.3	8.33	29.5	9.83	32.8	10.23	
60	10	18.1	1.98	21.6	2.32	25.1	2.70	26.9	2.90	28.6	3.08	32.2	3.49	35.7	3.91
	12	18.1	2.02	21.6	2.36	25.1	2.74	26.9	2.93	28.6	3.13	32.2	3.55	35.7	3.98
	14	18.1	2.03	21.6	2.39	25.1	2.79	26.9	2.99	28.6	3.19	32.2	3.62	35.7	4.05
	16	18.1	2.07	21.6	2.45	25.1	2.83	26.9	3.04	28.6	3.26	32.2	3.69	35.7	4.12
	18	18.1	2.11	21.6	2.48	25.1	2.88	26.9	3.10	28.6	3.31	32.2	3.74	35.7	4.21
	20	18.1	2.14	21.6	2.52	25.1	2.93	26.9	3.15	28.6	3.37	32.2	3.82	35.7	4.30
	21	18.1	2.16	21.6	2.54	25.1	2.97	26.9	3.19	28.6	3.40	32.2	3.87	35.7	4.34
	23	18.1	2.20	21.6	2.59	25.1	3.01	26.9	3.24	28.6	3.47	32.2	4.01	35.7	4.61
	25	18.1	2.23	21.6	2.65	25.1	3.13	26.9	3.40	28.6	3.69	32.2	4.28	35.7	4.93
	27	18.1	2.30	21.6	2.79	25.1	3.33	26.9	3.62	28.6	3.92	32.2	4.55	35.7	5.26
	29	18.1	2.45	21.6	2.97	25.1	3.55	26.9	3.85	28.6	4.18	32.2	4.86	35.7	5.61
	31	18.1	2.59	21.6	3.15	25.1	3.76	26.9	4.10	28.6	4.45	32.2	5.18	35.7	5.97
	33	18.1	2.74	21.6	3.33	25.1	4.00	26.9	4.36	28.6	4.73	32.2	5.51	35.7	6.37
	35	18.1	2.90	21.6	3.55	25.1	4.25	26.9	4.63	28.6	5.02	32.2	5.87	35.7	6.77
	37	18.1	3.06	21.6	3.74	25.1	4.50	26.9	4.91	28.6	5.33	32.2	6.23	35.7	7.20
	39	18.1	3.25	21.6	3.98	25.1	4.86	26.9	5.27	28.6	5.73	32.2	6.68	35.7	7.71
	41	17.6	3.53	21.0	4.36	24.5	5.27	26.2	5.76	27.9	6.22	31.3	7.33	34.8	8.38
	43	17.2	3.83	20.5	4.75	23.9	5.75	25.5	6.27	27.2	6.79	30.6	8.00	33.9	9.16
46	16.1	4.29	19.2	5.33	22.4	6.47	23.9	7.05	25.5	7.64	28.6	9.01	31.8	10.43	
48	14.2	3.74	17.0	4.65	19.8	5.65	21.2	6.16	22.6	6.67	25.3	7.88	28.1	9.13	
50	10	15.1	1.71	18.1	1.98	21.0	2.25	22.4	2.41	23.8	2.55	26.7	2.88	29.8	3.20
	12	15.1	1.73	18.1	2.00	21.0	2.28	22.4	2.45	23.8	2.61	26.7	2.93	29.8	3.26
	14	15.1	1.75	18.1	2.03	21.0	2.32	22.4	2.48	23.8	2.64	26.7	2.97	29.8	3.31
	16	15.1	1.78	18.1	2.07	21.0	2.36	22.4	2.54	23.8	2.68	26.7	3.02	29.8	3.36
	18	15.1	1.80	18.1	2.09	21.0	2.39	22.4	2.57	23.8	2.73	26.7	3.08	29.8	3.44
	20	15.1	1.82	18.1	2.12	21.0	2.45	22.4	2.61	23.8	2.79	26.7	3.13	29.8	3.51
	21	15.1	1.83	18.1	2.14	21.0	2.46	22.4	2.64	23.8	2.81	26.7	3.17	29.8	3.54
	23	15.1	1.87	18.1	2.18	21.0	2.50	22.4	2.68	23.8	2.86	26.7	3.22	29.8	3.62
	25	15.1	1.89	18.1	2.21	21.0	2.55	22.4	2.73	23.8	2.95	26.7	3.38	29.8	3.87
	27	15.1	1.92	18.1	2.28	21.0	2.70	22.4	2.91	23.8	3.13	26.7	3.62	29.8	4.12
	29	15.1	2.03	18.1	2.43	21.0	2.86	22.4	3.09	23.8	3.33	26.7	3.83	29.8	4.37
	31	15.1	2.14	18.1	2.57	21.0	3.04	22.4	3.27	23.8	3.54	26.7	4.08	29.8	4.66
	33	15.1	2.27	18.1	2.72	21.0	3.22	22.4	3.47	23.8	3.76	26.7	4.34	29.8	4.97
	35	15.1	2.39	18.1	2.88	21.0	3.40	22.4	3.69	23.8	3.98	26.7	4.59	29.8	5.27
	37	15.1	2.54	18.1	3.04	21.0	3.60	22.4	3.90	23.8	4.21	26.7	4.89	29.8	5.59
	39	15.1	2.71	18.1	3.26	21.0	3.86	22.4	4.20	23.8	4.52	26.7	5.21	29.8	6.04
	41	14.7	2.93	17.6	3.53	20.4	4.22	21.8	4.55	23.2	4.89	26.0	5.71	29.0	6.56
	43	14.4	3.18	17.2	3.84	19.9	4.59	21.3	4.96	22.7	5.33	25.4	6.23	28.3	7.16
46	13.5	3.56	16.1	4.30	18.7	5.15	19.9	5.57	21.2	5.98	23.8	7.01	26.5	8.06	
48	11.9	3.10	14.2	3.75	16.5	4.49	17.6	4.86	18.8	5.22	21.1	6.13	23.4	7.05	

Note

1. TC: Total Capacity(kW), PI : Power Input(kW, Comp. + Outdoor fan motor)
2. Capacity tables show the average value of conditions which may occur.

7. Capacity Tables

◆ A(C)RUN180LLS5

Combination (%)	Outdoor air temp (°C DB)	Indoor air temp. (DB/WB, °C)														Cooling Capacity(18HP)	
		20		23		26		27		28		30		32		TC	PI
		14	16	18	19	20	22	24									
130	10	49.9	5.22	59.5	6.38	63.7	7.40	65.5	7.55	67.4	7.61	70.6	7.67	72.4	7.70	70.6	7.67
	12	49.9	5.35	59.5	6.60	63.7	7.70	65.5	7.75	67.4	7.81	70.6	7.88	72.4	7.95	70.6	7.88
	14	49.9	5.53	59.5	6.84	63.7	7.99	65.5	8.05	67.4	8.11	70.6	8.18	72.4	8.25	70.6	8.18
	16	49.9	5.73	59.5	7.08	63.7	8.35	65.5	8.43	67.4	8.49	70.6	8.57	72.4	8.64	70.6	8.57
	18	49.9	5.97	59.5	7.49	63.7	8.73	65.5	8.92	67.4	8.99	70.6	9.08	72.4	9.14	70.6	9.08
	20	49.9	6.23	59.5	7.98	63.7	9.16	65.5	9.81	67.4	9.89	69.6	9.99	71.4	10.06	69.6	9.99
	21	49.9	6.40	59.5	8.26	63.7	9.36	65.5	10.38	67.4	10.47	69.2	10.57	71.0	10.64	69.2	10.57
	23	49.9	6.86	59.5	8.69	63.7	9.84	65.5	11.46	66.5	11.55	68.2	11.66	70.0	11.75	68.2	11.66
	25	49.9	7.33	59.5	9.19	63.7	10.52	64.8	12.71	65.5	12.81	67.4	12.94	69.2	13.03	67.4	12.94
	27	49.9	7.84	59.5	9.83	62.9	11.21	63.7	13.99	64.8	14.10	66.5	14.24	68.2	14.34	66.5	14.24
	29	49.9	8.36	59.5	10.50	61.9	12.06	62.8	15.38	63.7	15.47	65.5	15.61	67.4	15.67	65.5	15.61
	31	49.9	8.92	59.3	11.06	60.9	12.82	61.9	15.31	62.8	15.40	64.5	15.54	66.3	15.60	64.5	15.54
	33	49.9	9.50	58.2	11.72	60.1	13.75	61.0	15.17	61.9	15.26	63.7	15.40	65.3	15.46	63.7	15.40
	35	49.9	10.13	57.2	12.28	59.0	14.90	60.1	14.97	61.0	15.06	62.7	15.20	64.5	15.26	62.7	15.20
	37	49.9	10.80	56.4	12.88	58.2	14.70	59.0	14.78	60.1	14.86	61.7	15.00	63.5	15.06	61.7	15.00
	39	49.9	11.50	55.4	13.56	57.2	14.50	58.2	14.58	59.0	14.66	60.9	14.80	62.7	14.85	60.9	14.80
	41	48.6	12.20	53.1	14.24	54.9	14.31	55.7	14.38	56.8	14.47	58.5	14.60	60.1	14.65	58.5	14.60
	43	47.4	12.87	50.9	14.04	52.7	14.11	53.5	14.18	54.5	14.27	56.2	14.39	57.7	14.45	56.2	14.39
46	44.5	13.78	46.4	13.75	48.1	13.82	48.9	13.89	49.9	13.97	51.4	14.09	52.9	14.15	51.4	14.09	
48	39.3	13.39	40.3	13.43	41.8	13.46	42.5	13.50	43.4	13.61	44.8	13.70	46.0	13.75	44.8	13.70	
120	10	45.2	4.69	53.7	5.76	58.7	6.84	60.5	7.39	62.3	7.51	65.7	7.54	67.3	7.60	65.7	7.54
	12	45.2	4.82	53.7	5.95	58.7	7.11	60.5	7.55	62.3	7.79	65.7	7.88	67.3	7.94	65.7	7.88
	14	45.2	4.99	53.7	6.15	58.7	7.40	60.5	7.83	62.3	8.07	65.7	8.19	67.3	8.26	65.7	8.19
	16	45.2	5.17	53.7	6.40	58.7	7.69	60.5	8.13	62.3	8.45	65.7	8.55	67.3	8.62	65.7	8.55
	18	45.2	5.37	53.7	6.69	58.7	8.00	60.5	8.55	62.3	8.88	65.7	8.98	67.3	9.05	65.7	8.98
	20	45.2	5.57	53.7	7.10	58.7	8.43	60.5	9.00	62.3	9.35	65.7	9.47	67.3	9.55	65.7	9.47
	21	45.2	5.74	53.7	7.35	58.7	8.66	60.5	9.27	62.3	9.66	65.7	9.78	67.3	9.86	65.7	9.78
	23	45.2	6.14	53.7	7.87	58.7	9.28	60.5	9.85	62.3	10.29	65.7	10.40	67.3	10.48	65.7	10.40
	25	45.2	6.56	53.7	8.43	58.7	9.79	60.5	10.50	62.3	11.04	64.9	11.13	66.4	11.22	64.9	11.13
	27	45.2	7.00	53.7	9.01	58.7	10.42	60.5	11.22	62.3	11.86	63.9	11.94	66.5	12.04	63.9	11.94
	29	45.2	7.47	53.7	9.62	58.7	10.96	60.5	12.00	61.3	12.64	62.9	12.83	64.7	12.94	62.9	12.83
	31	45.2	7.96	53.7	10.27	58.7	11.53	59.7	12.86	60.5	13.56	62.1	13.80	63.7	13.91	62.1	13.80
	33	45.2	8.47	53.7	10.95	57.9	12.20	58.7	13.96	59.5	14.56	61.1	14.73	62.7	14.85	61.1	14.73
	35	45.2	9.01	53.7	11.67	56.9	12.91	57.7	15.38	58.7	15.45	60.3	15.50	61.9	15.62	60.3	15.50
	37	45.2	9.69	53.7	12.31	56.1	13.76	56.9	15.05	57.7	15.13	59.3	15.17	60.9	15.29	59.3	15.17
	39	45.2	10.43	53.5	13.01	55.1	14.60	55.9	14.74	56.7	14.82	58.5	14.86	60.1	14.98	58.5	14.86
	41	44.0	11.17	51.2	13.72	52.9	14.31	53.7	14.43	54.4	14.51	56.0	14.55	57.6	14.66	56.0	14.55
	43	42.9	11.93	49.0	13.52	50.7	13.99	51.5	14.12	52.2	14.19	53.8	14.24	55.3	14.35	53.8	14.24
46	40.2	12.82	44.7	13.20	46.3	13.55	47.0	13.66	47.7	13.73	49.2	13.77	50.6	13.88	49.2	13.77	
48	35.6	12.56	38.8	12.96	40.3	13.28	40.9	13.37	41.5	13.41	42.8	13.46	44.1	13.52	42.8	13.46	
110	10	40.5	4.22	48.2	5.15	53.9	6.11	55.4	6.62	58.9	7.12	60.3	7.32	64.4	7.44	60.3	7.32
	12	40.5	4.35	48.2	5.32	53.9	6.37	55.4	6.80	58.9	7.39	60.3	7.63	64.4	7.80	60.3	7.63
	14	40.5	4.49	48.2	5.56	53.9	6.65	55.4	7.14	58.9	7.76	60.3	7.98	64.4	8.15	60.3	7.98
	16	40.5	4.65	48.2	5.76	53.9	6.93	55.4	7.45	58.9	8.12	60.3	8.34	64.4	8.49	60.3	8.34
	18	40.5	4.82	48.2	6.00	53.9	7.33	55.4	7.85	58.9	8.56	60.3	8.73	64.4	8.90	60.3	8.73
	20	40.5	4.99	48.2	6.30	53.9	7.77	55.4	8.21	58.9	8.98	60.3	9.20	64.4	9.35	60.3	9.20
	21	40.5	5.10	48.2	6.49	53.9	7.97	55.4	8.43	58.9	9.23	60.3	9.46	64.4	9.61	60.3	9.46
	23	40.5	5.44	48.2	6.96	53.9	8.42	55.4	8.90	58.9	9.75	60.3	9.96	64.4	10.12	60.3	9.96
	25	40.5	5.81	48.2	7.42	53.9	8.89	55.4	9.41	58.9	10.30	60.3	10.45	63.6	10.66	60.3	10.45
	27	40.5	6.21	48.2	7.94	53.9	9.40	55.4	9.96	58.9	10.76	60.3	11.00	62.7	11.19	60.3	11.00
	29	40.5	6.63	48.2	8.47	53.9	9.93	55.4	10.54	58.9	11.37	60.3	11.57	61.9	11.74	60.3	11.57
	31	40.5	7.05	48.2	9.03	53.9	10.49	55.4	11.17	58.0	11.95	59.5	12.18	60.9	12.31	59.5	12.18
	33	40.5	7.52	48.2	9.62	53.9	11.09	55.4	11.84	57.2	12.62	58.6	12.83	60.1	12.90	58.6	12.83
	35	40.5	7.98	48.2	10.27	53.9	11.71	55.4	12.54	56.2	13.31	57.6	13.44	59.1	13.50	57.6	13.44
	37	40.5	8.46	48.2	10.90	53.9	12.36	54.7	13.29	55.2	14.04	56.8	14.09	58.2	14.13	56.8	14.09
	39	40.5	9.12	48.2	11.58	52.9	13.04	53.7	14.21	54.5	14.74	55.8	14.76	57.4	14.78	55.8	14.76
	41	39.4	9.78	47.0	12.26	50.6	13.75	51.4	15.38	52.1	15.38	53.6	15.50	55.0	15.62	53.6	15.50
	43	38.5	10.27	45.8	12.78	48.5	14.58	49.3	14.75	50.0	14.72	51.5	14.80	52.8	14.84	51.5	14.80
46	36.0	10.02	43.0	12.34	44.3	13.84	45.1	13.84	45.6	13.96	47.0	14.04	48.3	14.08	47.0	14.04	
48	31.9	9.74	37.3	11.88	38.5	13.17	39.2	13.26	39.7	13.32	40.9	13.36	42.0	13.41	40.9	13.36	

Note

1. TC: Total Capacity(kW), PI: Power Input(kW, Comp. + Outdoor fan motor)
2. Capacity tables show the average value of conditions which may occur.

7. Capacity Tables

Combination (%)	Outdoor air temp (°C DB)	Cooling Capacity(18HP)													
		Indoor air temp. (DB/WB, °C)													
		20		23		26		27		28		30		32	
		14	16	18	19	20	22	24	TC	PI	TC	PI	TC	PI	
100	10	34.0	3.80	40.5	4.62	47.2	5.48	50.4	5.92	53.6	6.36	59.5	7.09	60.8	7.14
	12	34.0	3.92	40.5	4.81	47.2	5.67	50.4	6.08	53.6	6.57	59.5	7.47	60.8	7.54
	14	34.0	4.05	40.5	5.00	47.2	5.91	50.4	6.35	53.6	6.85	59.5	7.88	60.8	7.96
	16	34.0	4.17	40.5	5.17	47.2	6.16	50.4	6.65	53.6	7.22	59.5	8.26	60.8	8.38
	18	34.0	4.29	40.5	5.36	47.2	6.40	50.4	6.97	53.6	7.66	59.5	8.73	60.8	8.80
	20	34.0	4.45	40.5	5.56	47.2	6.77	50.4	7.47	53.6	8.19	59.5	9.15	60.8	9.22
	21	34.0	4.54	40.5	5.69	47.2	7.00	50.4	7.73	53.6	8.50	59.5	9.36	60.8	9.43
	23	34.0	4.81	40.5	6.09	47.2	7.52	50.4	8.29	53.6	9.10	59.5	9.80	60.8	9.88
	25	34.0	5.11	40.5	6.49	47.2	8.03	50.4	8.87	53.6	9.73	59.5	10.22	60.3	10.30
	27	34.0	5.46	40.5	6.93	47.2	8.59	50.4	9.48	53.6	10.35	58.3	10.70	59.5	10.78
	29	34.0	5.81	40.5	7.40	47.2	9.17	50.4	10.13	53.6	10.95	57.2	11.13	58.6	11.22
	31	34.0	6.21	40.5	7.89	47.2	9.78	50.4	10.81	53.6	11.51	56.4	11.56	57.7	11.65
	33	34.0	6.58	40.5	8.40	47.2	10.43	50.4	11.53	53.6	11.94	55.5	11.99	56.8	12.09
	35	34.0	7.00	40.5	8.94	47.2	11.11	50.4	12.30	52.8	12.37	54.5	12.42	55.8	12.52
	37	34.0	7.50	40.5	9.59	47.2	11.77	50.4	12.89	52.0	12.95	53.4	13.00	54.7	13.12
	39	34.0	8.04	40.5	10.30	47.2	12.47	50.4	13.52	51.1	13.58	52.6	13.63	53.8	13.75
	41	33.5	8.58	39.9	11.01	46.4	13.17	48.4	14.15	49.4	14.20	50.6	14.25	52.2	14.38
43	32.3	9.08	38.5	11.67	44.8	13.80	46.4	14.69	46.9	14.74	48.4	14.79	49.6	14.93	
46	30.3	9.77	36.1	12.58	42.0	14.64	42.3	15.38	42.8	15.42	44.2	15.47	45.4	15.61	
48	26.8	8.43	31.9	10.89	36.3	12.52	36.8	13.05	37.2	13.09	38.4	13.12	39.4	13.22	
90	10	30.6	3.47	36.5	4.17	42.5	4.91	45.4	5.29	48.2	5.70	54.2	6.38	60.1	7.09
	12	30.6	3.51	36.5	4.23	42.5	5.00	45.4	5.40	48.2	5.83	54.2	6.50	60.1	7.22
	14	30.6	3.57	36.5	4.32	42.5	5.10	45.4	5.51	48.2	5.93	54.2	6.63	60.1	7.36
	16	30.6	3.64	36.5	4.40	42.5	5.21	45.4	5.61	48.2	6.04	54.2	6.76	60.1	7.49
	18	30.6	3.70	36.5	4.49	42.5	5.29	45.4	5.74	48.2	6.17	54.2	6.90	60.1	7.87
	20	30.6	3.76	36.5	4.57	42.5	5.40	45.4	5.85	48.2	6.40	54.2	7.39	60.1	8.24
	21	30.6	3.81	36.5	4.61	42.5	5.51	45.4	6.04	48.2	6.63	54.2	7.51	60.1	8.43
	23	30.6	3.89	36.5	4.80	42.5	5.89	45.4	6.48	48.2	7.10	54.2	7.96	59.3	8.83
	25	30.6	4.08	36.5	5.12	42.5	6.29	45.4	6.93	48.2	7.59	54.2	8.51	58.4	9.21
	27	30.6	4.36	36.5	5.46	42.5	6.72	45.4	7.40	48.2	8.12	54.2	9.05	57.6	9.64
	29	30.6	4.61	36.5	5.83	42.5	7.19	45.4	7.91	48.2	8.67	54.2	9.59	56.7	10.03
	31	30.6	4.91	36.5	6.21	42.5	7.65	45.4	8.42	48.2	9.25	54.2	10.07	55.9	10.41
	33	30.6	5.23	36.5	6.61	42.5	8.16	45.4	8.97	48.2	9.81	54.2	10.55	55.0	10.80
	35	30.6	5.55	36.5	7.02	42.5	8.67	45.4	9.57	48.2	10.40	53.2	11.16	54.2	11.41
	37	30.6	5.89	36.5	7.46	42.5	9.25	45.4	10.16	48.2	10.98	52.4	11.66	53.3	11.93
	39	30.6	6.24	36.5	7.94	42.5	9.79	45.4	10.81	48.2	11.55	51.5	12.30	52.4	12.45
	41	29.8	6.98	35.6	8.80	41.4	10.74	44.2	11.83	47.0	12.47	49.4	12.96	50.3	13.26
43	29.1	7.53	34.7	9.51	40.4	11.74	43.1	12.74	45.8	13.37	47.3	13.88	48.2	14.05	
46	27.3	8.48	32.5	10.83	37.8	13.37	40.4	14.44	41.7	14.85	43.2	15.23	44.0	15.26	
48	24.1	7.41	28.8	9.47	33.5	11.70	35.7	12.60	36.2	12.80	37.6	13.11	38.3	13.13	
80	10	27.2	2.92	32.4	3.50	37.6	4.11	40.3	4.43	43.0	4.76	48.2	5.43	53.5	5.89
	12	27.2	2.98	32.4	3.54	37.6	4.19	40.3	4.52	43.0	4.84	48.2	5.53	53.5	6.01
	14	27.2	3.02	32.4	3.62	37.6	4.25	40.3	4.60	43.0	4.92	48.2	5.63	53.5	6.13
	16	27.2	3.06	32.4	3.69	37.6	4.33	40.3	4.68	43.0	5.02	48.2	5.75	53.5	6.24
	18	27.2	3.12	32.4	3.75	37.6	4.41	40.3	4.76	43.0	5.12	48.2	5.85	53.5	6.38
	20	27.2	3.18	32.4	3.83	37.6	4.52	40.3	4.86	43.0	5.22	48.2	6.07	53.5	6.76
	21	27.2	3.20	32.4	3.87	37.6	4.56	40.3	4.92	43.0	5.35	48.2	6.27	53.5	6.94
	23	27.2	3.26	32.4	3.93	37.6	4.76	40.3	5.22	43.0	5.71	48.2	6.62	53.5	7.28
	25	27.2	3.38	32.4	4.19	37.6	5.10	40.3	5.59	43.0	6.12	48.2	7.08	53.5	7.78
	27	27.2	3.58	32.4	4.45	37.6	5.45	40.3	5.97	43.0	6.52	48.2	7.52	53.5	8.19
	29	27.2	3.81	32.4	4.76	37.6	5.79	40.3	6.36	43.0	6.97	48.2	8.06	53.5	8.77
	31	27.2	4.05	32.4	5.04	37.6	6.18	40.3	6.78	43.0	7.41	48.2	8.55	53.5	9.20
	33	27.2	4.29	32.4	5.39	37.6	6.58	40.3	7.23	43.0	7.90	48.2	9.01	53.5	9.65
	35	27.2	4.56	32.4	5.71	37.6	7.01	40.3	7.69	43.0	8.42	48.2	9.56	52.9	10.00
	37	27.2	4.82	32.4	6.07	37.6	7.43	40.3	8.18	43.0	8.95	48.2	10.09	52.0	10.46
	39	27.2	5.09	32.4	6.42	37.6	7.95	40.3	8.79	43.0	9.62	48.2	10.66	51.2	11.03
	41	26.5	5.63	31.6	7.11	36.7	8.72	39.3	9.64	41.9	10.57	47.0	11.86	49.0	12.22
43	25.8	6.20	30.8	7.76	35.8	9.52	38.3	10.51	40.9	11.55	45.8	12.69	47.0	13.09	
46	24.2	6.90	28.9	8.74	33.5	10.73	35.9	11.69	38.3	13.03	41.9	13.85	42.9	14.07	
48	21.4	6.03	25.5	7.64	29.6	9.38	31.8	10.21	33.9	11.41	36.4	11.99	37.3	12.12	

Note

1. TC: Total Capacity(kW), PI : Power Input(kW, Comp. + Outdoor fan motor)
2. Capacity tables show the average value of conditions which may occur.

7. Capacity Tables

Combination (%)	Outdoor air temp (°C DB)	Cooling Capacity(18HP)													
		Indoor air temp. (DB/WB, °C)													
		20		23		26		27		28		30		32	
		14	PI	16	PI	18	PI	19	PI	20	PI	22	PI	24	PI
70	10	23.8	2.57	28.4	3.06	32.9	3.54	35.3	3.83	37.6	4.09	42.1	4.66	46.8	5.21
	12	23.8	2.61	28.4	3.10	32.9	3.62	35.3	3.89	37.6	4.17	42.1	4.74	46.8	5.31
	14	23.8	2.65	28.4	3.14	32.9	3.69	35.3	3.95	37.6	4.23	42.1	4.84	46.8	5.40
	16	23.8	2.69	28.4	3.20	32.9	3.75	35.3	4.03	37.6	4.31	42.1	4.92	46.8	5.52
	18	23.8	2.73	28.4	3.26	32.9	3.83	35.3	4.11	37.6	4.39	42.1	5.00	46.8	5.62
	20	23.8	2.77	28.4	3.32	32.9	3.89	35.3	4.19	37.6	4.50	42.1	5.12	46.8	5.83
	21	23.8	2.81	28.4	3.34	32.9	3.93	35.3	4.23	37.6	4.54	42.1	5.20	46.8	5.96
	23	23.8	2.86	28.4	3.42	32.9	4.01	35.3	4.37	37.6	4.76	42.1	5.57	46.8	6.29
	25	23.8	2.90	28.4	3.54	32.9	4.27	35.3	4.68	37.6	5.08	42.1	5.95	46.8	6.59
	27	23.8	3.06	28.4	3.79	32.9	4.56	35.3	4.96	37.6	5.43	42.1	6.36	46.8	7.01
	29	23.8	3.26	28.4	4.01	32.9	4.84	35.3	5.29	37.6	5.77	42.1	6.78	46.8	7.51
	31	23.8	3.46	28.4	4.27	32.9	5.16	35.3	5.65	37.6	6.16	42.1	7.23	46.8	7.97
	33	23.8	3.67	28.4	4.52	32.9	5.49	35.3	5.99	37.6	6.54	42.1	7.70	46.8	8.48
	35	23.8	3.87	28.4	4.82	32.9	5.83	35.3	6.38	37.6	6.97	42.1	8.20	46.8	8.99
	37	23.8	4.11	28.4	5.11	32.9	6.20	35.3	6.78	37.6	7.41	42.1	8.73	46.8	9.49
	39	23.8	4.37	28.4	5.44	32.9	6.63	35.3	7.30	37.6	8.01	42.1	9.34	46.8	10.23
	41	23.2	4.83	27.7	5.96	32.1	7.27	34.4	8.01	36.7	8.70	41.0	10.26	45.6	11.04
	43	22.6	5.25	27.0	6.50	31.3	7.93	33.5	8.73	35.8	9.50	40.0	11.21	44.5	11.93
	46	21.2	5.84	25.3	7.31	29.3	8.93	31.4	9.72	33.5	10.71	37.5	12.64	41.7	13.30
	48	18.7	5.09	22.4	6.38	26.0	7.81	27.8	8.50	29.6	9.37	33.2	11.06	36.9	11.51
60	10	20.3	2.23	24.3	2.61	28.3	3.04	30.2	3.26	32.2	3.46	36.2	3.93	40.1	4.39
	12	20.3	2.27	24.3	2.65	28.3	3.08	30.2	3.30	32.2	3.52	36.2	3.99	40.1	4.48
	14	20.3	2.29	24.3	2.69	28.3	3.14	30.2	3.36	32.2	3.58	36.2	4.07	40.1	4.56
	16	20.3	2.33	24.3	2.75	28.3	3.18	30.2	3.42	32.2	3.67	36.2	4.15	40.1	4.64
	18	20.3	2.37	24.3	2.79	28.3	3.24	30.2	3.48	32.2	3.73	36.2	4.21	40.1	4.74
	20	20.3	2.41	24.3	2.84	28.3	3.30	30.2	3.54	32.2	3.79	36.2	4.29	40.1	4.84
	21	20.3	2.43	24.3	2.86	28.3	3.34	30.2	3.58	32.2	3.83	36.2	4.35	40.1	4.88
	23	20.3	2.47	24.3	2.92	28.3	3.38	30.2	3.65	32.2	3.91	36.2	4.52	40.1	5.18
	25	20.3	2.51	24.3	2.98	28.3	3.52	30.2	3.83	32.2	4.15	36.2	4.82	40.1	5.55
	27	20.3	2.59	24.3	3.14	28.3	3.75	30.2	4.07	32.2	4.41	36.2	5.12	40.1	5.91
	29	20.3	2.75	24.3	3.34	28.3	3.99	30.2	4.33	32.2	4.70	36.2	5.47	40.1	6.32
	31	20.3	2.92	24.3	3.54	28.3	4.23	30.2	4.62	32.2	5.00	36.2	5.83	40.1	6.72
	33	20.3	3.08	24.3	3.75	28.3	4.50	30.2	4.90	32.2	5.33	36.2	6.20	40.1	7.17
	35	20.3	3.26	24.3	3.99	28.3	4.78	30.2	5.20	32.2	5.65	36.2	6.60	40.1	7.61
	37	20.3	3.44	24.3	4.21	28.3	5.06	30.2	5.53	32.2	5.99	36.2	7.01	40.1	8.10
	39	20.3	3.66	24.3	4.48	28.3	5.46	30.2	5.93	32.2	6.45	36.2	7.51	40.1	8.68
	41	19.8	3.97	23.7	4.91	27.5	5.93	29.5	6.48	31.4	7.00	35.3	8.25	39.1	9.43
	43	19.3	4.32	23.1	5.34	26.9	6.47	28.7	7.06	30.6	7.64	34.4	9.00	38.1	10.30
	46	18.1	4.83	21.6	6.00	25.2	7.28	26.9	7.94	28.7	8.59	32.2	10.14	35.7	11.74
	48	16.0	4.21	19.1	5.23	22.3	6.36	23.8	6.93	25.4	7.51	28.5	8.87	31.6	10.27
50	10	17.0	1.92	20.3	2.23	23.6	2.53	25.2	2.71	26.8	2.88	30.1	3.24	33.5	3.60
	12	17.0	1.94	20.3	2.25	23.6	2.57	25.2	2.75	26.8	2.94	30.1	3.30	33.5	3.67
	14	17.0	1.96	20.3	2.29	23.6	2.61	25.2	2.79	26.8	2.98	30.1	3.34	33.5	3.73
	16	17.0	2.00	20.3	2.33	23.6	2.65	25.2	2.86	26.8	3.02	30.1	3.40	33.5	3.79
	18	17.0	2.03	20.3	2.35	23.6	2.69	25.2	2.90	26.8	3.08	30.1	3.46	33.5	3.87
	20	17.0	2.05	20.3	2.39	23.6	2.75	25.2	2.94	26.8	3.14	30.1	3.52	33.5	3.95
	21	17.0	2.07	20.3	2.41	23.6	2.77	25.2	2.98	26.8	3.16	30.1	3.56	33.5	3.99
	23	17.0	2.11	20.3	2.45	23.6	2.82	25.2	3.02	26.8	3.22	30.1	3.63	33.5	4.07
	25	17.0	2.13	20.3	2.49	23.6	2.88	25.2	3.08	26.8	3.32	30.1	3.81	33.5	4.35
	27	17.0	2.17	20.3	2.57	23.6	3.04	25.2	3.28	26.8	3.52	30.1	4.07	33.5	4.64
	29	17.0	2.29	20.3	2.73	23.6	3.22	25.2	3.48	26.8	3.75	30.1	4.31	33.5	4.92
	31	17.0	2.41	20.3	2.90	23.6	3.42	25.2	3.69	26.8	3.99	30.1	4.60	33.5	5.25
	33	17.0	2.55	20.3	3.06	23.6	3.63	25.2	3.91	26.8	4.23	30.1	4.88	33.5	5.59
	35	17.0	2.69	20.3	3.24	23.6	3.83	25.2	4.15	26.8	4.48	30.1	5.16	33.5	5.93
	37	17.0	2.86	20.3	3.42	23.6	4.05	25.2	4.39	26.8	4.74	30.1	5.51	33.5	6.30
	39	17.0	3.05	20.3	3.67	23.6	4.34	25.2	4.73	26.8	5.09	30.1	5.87	33.5	6.80
	41	16.6	3.29	19.8	3.97	23.0	4.75	24.6	5.12	26.1	5.51	29.3	6.43	32.6	7.39
	43	16.2	3.58	19.3	4.32	22.4	5.16	23.9	5.58	25.5	6.00	28.6	7.01	31.8	8.06
	46	15.1	4.01	18.1	4.85	21.0	5.79	22.4	6.26	23.9	6.73	26.8	7.89	29.8	9.07
	48	13.4	3.49	16.0	4.23	18.6	5.05	19.9	5.47	21.1	5.88	23.7	6.90	26.4	7.93

Note

1. TC: Total Capacity(kW), PI : Power Input(kW, Comp. + Outdoor fan motor)
2. Capacity tables show the average value of conditions which may occur.

7. Capacity Tables

◆ A(C)RUN200LLS5

Combination (%)	Outdoor air temp (°C DB)	Indoor air temp. (DB/WB, °C)														Cooling Capacity(20HP)	
		20		23		26		27		28		30		32		TC	PI
		14		16		18		19		20		22		24			
		TC	PI	TC	PI	TC	PI	TC	PI	TC	PI	TC	PI	TC	PI		
130	10	55.5	5.98	66.1	7.31	70.8	8.48	72.8	8.65	74.9	8.72	78.5	8.79	80.5	8.83		
	12	55.5	6.13	66.1	7.57	70.8	8.83	72.8	8.89	74.9	8.96	78.5	9.03	80.5	9.11		
	14	55.5	6.33	66.1	7.85	70.8	9.16	72.8	9.23	74.9	9.30	78.5	9.37	80.5	9.46		
	16	55.5	6.57	66.1	8.12	70.8	9.57	72.8	9.66	74.9	9.74	78.5	9.82	80.5	9.90		
	18	55.5	6.84	66.1	8.59	70.8	10.01	72.8	10.23	74.9	10.31	78.5	10.41	80.5	10.48		
	20	55.5	7.14	66.1	9.15	70.8	10.50	72.8	11.25	74.9	11.34	77.3	11.45	79.4	11.53		
	21	55.5	7.33	66.1	9.47	70.8	10.72	72.8	11.90	74.9	12.00	76.9	12.12	78.9	12.20		
	23	55.5	7.87	66.1	9.96	70.8	11.28	72.8	13.14	73.9	13.24	75.8	13.37	77.8	13.46		
	25	55.5	8.40	66.1	10.54	70.8	12.06	72.0	14.57	72.8	14.68	74.9	14.83	76.9	14.93		
	27	55.5	8.99	66.1	11.26	69.9	12.85	70.8	16.04	72.0	16.17	73.9	16.33	75.8	16.44		
	29	55.5	9.58	66.1	12.04	68.8	13.82	69.8	17.63	70.8	17.73	72.8	17.89	74.9	17.96		
	31	55.5	10.22	65.8	12.68	67.6	14.70	68.8	17.55	69.8	17.66	71.7	17.81	73.7	17.88		
	33	55.5	10.89	64.7	13.44	66.7	15.77	67.8	17.39	68.8	17.50	70.8	17.65	72.6	17.72		
	35	55.5	11.61	63.6	14.07	65.6	17.08	66.7	17.16	67.8	17.27	69.7	17.42	71.7	17.49		
	37	55.5	12.38	62.7	14.77	64.7	16.85	65.6	16.94	66.7	17.04	68.5	17.19	70.6	17.26		
	39	55.5	13.19	61.6	15.55	63.6	16.63	64.7	16.71	65.6	16.81	67.6	16.96	69.7	17.03		
	41	54.0	13.99	59.0	16.32	61.0	16.40	61.9	16.48	63.1	16.58	65.0	16.73	66.8	16.80		
	43	52.7	14.75	56.5	16.09	58.5	16.18	59.4	16.26	60.6	16.35	62.4	16.50	64.1	16.57		
46	49.4	15.79	51.6	15.76	53.5	15.84	54.3	15.92	55.4	16.01	57.2	16.16	58.7	16.22			
48	43.7	15.35	44.8	15.40	46.5	15.43	47.2	15.47	48.2	15.60	49.8	15.70	51.1	15.77			
120	10	50.2	5.38	59.7	6.60	65.2	7.84	67.2	8.47	69.2	8.61	73.0	8.64	74.7	8.71		
	12	50.2	5.53	59.7	6.82	65.2	8.16	67.2	8.65	69.2	8.93	73.0	9.03	74.7	9.11		
	14	50.2	5.72	59.7	7.05	65.2	8.49	67.2	8.98	69.2	9.25	73.0	9.39	74.7	9.46		
	16	50.2	5.92	59.7	7.34	65.2	8.81	67.2	9.32	69.2	9.68	73.0	9.80	74.7	9.88		
	18	50.2	6.15	59.7	7.67	65.2	9.17	67.2	9.81	69.2	10.18	73.0	10.29	74.7	10.38		
	20	50.2	6.39	59.7	8.13	65.2	9.66	67.2	10.32	69.2	10.72	73.0	10.86	74.7	10.94		
	21	50.2	6.58	59.7	8.43	65.2	9.93	67.2	10.62	69.2	11.07	73.0	11.21	74.7	11.30		
	23	50.2	7.04	59.7	9.02	65.2	10.64	67.2	11.29	69.2	11.80	73.0	11.92	74.7	12.02		
	25	50.2	7.52	59.7	9.66	65.2	11.22	67.2	12.03	69.2	12.65	72.1	12.76	73.8	12.86		
	27	50.2	8.03	59.7	10.33	65.2	11.94	67.2	12.86	69.2	13.60	71.0	13.69	72.7	13.80		
	29	50.2	8.56	59.7	11.02	65.2	12.57	67.2	13.76	68.1	14.49	69.9	14.71	71.8	14.83		
	31	50.2	9.12	59.7	11.77	65.2	13.22	66.3	14.74	67.2	15.55	69.0	15.82	70.7	15.95		
	33	50.2	9.71	59.7	12.55	64.3	13.98	65.2	16.00	66.1	16.69	67.9	16.88	69.6	17.02		
	35	50.2	10.33	59.7	13.38	63.2	14.80	64.1	17.63	65.2	17.71	67.0	17.77	68.7	17.91		
	37	50.2	11.11	59.7	14.12	62.3	15.78	63.2	17.25	64.1	17.34	65.9	17.39	67.7	17.53		
	39	50.2	11.96	59.5	14.92	61.2	16.73	62.1	16.90	63.0	16.98	65.0	17.04	66.8	17.17		
	41	48.9	12.81	56.9	15.72	58.8	16.40	59.6	16.55	60.5	16.63	62.2	16.68	64.0	16.81		
	43	47.7	13.67	54.5	15.50	56.4	16.04	57.2	16.19	58.0	16.27	59.7	16.32	61.5	16.45		
46	44.7	14.70	49.7	15.13	51.5	15.53	52.2	15.66	53.0	15.74	54.6	15.78	56.3	15.91			
48	39.5	14.40	43.1	14.86	44.7	15.23	45.4	15.32	46.1	15.37	47.5	15.43	49.0	15.49			
110	10	45.0	4.84	53.6	5.90	59.9	7.01	61.6	7.59	65.5	8.16	67.0	8.39	71.5	8.53		
	12	45.0	4.99	53.6	6.10	59.9	7.30	61.6	7.80	65.5	8.47	67.0	8.74	71.5	8.94		
	14	45.0	5.15	53.6	6.37	59.9	7.63	61.6	8.18	65.5	8.90	67.0	9.15	71.5	9.34		
	16	45.0	5.33	53.6	6.61	59.9	7.94	61.6	8.54	65.5	9.31	67.0	9.56	71.5	9.73		
	18	45.0	5.53	53.6	6.88	59.9	8.40	61.6	9.00	65.5	9.82	67.0	10.01	71.5	10.20		
	20	45.0	5.72	53.6	7.22	59.9	8.91	61.6	9.41	65.5	10.29	67.0	10.55	71.5	10.72		
	21	45.0	5.85	53.6	7.44	59.9	9.14	61.6	9.66	65.5	10.58	67.0	10.85	71.5	11.02		
	23	45.0	6.23	53.6	7.97	59.9	9.65	61.6	10.20	65.5	11.18	67.0	11.42	71.5	11.61		
	25	45.0	6.66	53.6	8.51	59.9	10.19	61.6	10.78	65.5	11.81	67.0	11.98	70.7	12.22		
	27	45.0	7.12	53.6	9.10	59.9	10.77	61.6	11.41	65.5	12.33	67.0	12.62	69.6	12.83		
	29	45.0	7.60	53.6	9.71	59.9	11.38	61.6	12.09	65.5	13.03	67.0	13.26	68.7	13.46		
	31	45.0	8.08	53.6	10.35	59.9	12.03	61.6	12.81	64.4	13.70	66.1	13.96	67.7	14.11		
	33	45.0	8.62	53.6	11.02	59.9	12.71	61.6	13.57	63.5	14.46	65.1	14.70	66.8	14.78		
	35	45.0	9.15	53.6	11.77	59.9	13.42	61.6	14.38	62.5	15.26	64.0	15.40	65.7	15.48		
	37	45.0	9.70	53.6	12.49	59.9	14.17	60.7	15.23	61.4	16.10	63.1	16.15	64.6	16.20		
	39	45.0	10.46	53.6	13.28	58.8	14.95	59.6	16.29	60.5	16.90	62.0	16.92	63.8	16.94		
	41	43.8	11.21	52.2	14.06	56.3	15.77	57.2	17.63	57.9	17.63	59.6	17.77	61.1	17.91		
	43	42.7	11.77	50.9	14.65	53.9	16.72	54.8	16.91	55.5	16.87	57.2	16.97	58.6	17.01		
46	40.0	11.49	47.7	14.14	49.2	15.87	50.1	15.87	50.7	16.00	52.3	16.09	53.6	16.14			
48	35.4	11.16	41.5	13.62	42.7	15.10	43.5	15.20	44.1	15.27	45.5	15.31	46.7	15.37			

Note

1. TC: Total Capacity(kW), PI: Power Input(kW, Comp. + Outdoor fan motor)
2. Capacity tables show the average value of conditions which may occur.

7. Capacity Tables

Combination (%)	Outdoor air temp (°C DB)	Cooling Capacity(20HP)													
		Indoor air temp. (DB/WB, °C)													
		20		23		26		27		28		30		32	
		14	16	18	19	20	22	24							
	TC	PI	TC	PI	TC	PI	TC	PI	TC	PI	TC	PI	TC	PI	
100	10	37.8	4.36	45.0	5.30	52.4	6.28	56.0	6.79	59.6	7.30	66.1	8.12	67.5	8.19
	12	37.8	4.50	45.0	5.51	52.4	6.50	56.0	6.97	59.6	7.53	66.1	8.56	67.5	8.64
	14	37.8	4.64	45.0	5.73	52.4	6.77	56.0	7.28	59.6	7.85	66.1	9.04	67.5	9.12
	16	37.8	4.78	45.0	5.92	52.4	7.06	56.0	7.62	59.6	8.28	66.1	9.47	67.5	9.61
	18	37.8	4.92	45.0	6.14	52.4	7.33	56.0	7.99	59.6	8.78	66.1	10.01	67.5	10.09
	20	37.8	5.10	45.0	6.38	52.4	7.76	56.0	8.56	59.6	9.39	66.1	10.49	67.5	10.57
	21	37.8	5.20	45.0	6.53	52.4	8.03	56.0	8.86	59.6	9.74	66.1	10.73	67.5	10.81
	23	37.8	5.51	45.0	6.98	52.4	8.62	56.0	9.50	59.6	10.43	66.1	11.23	67.5	11.32
	25	37.8	5.86	45.0	7.44	52.4	9.20	56.0	10.17	59.6	11.16	66.1	11.71	67.0	11.81
	27	37.8	6.26	45.0	7.95	52.4	9.85	56.0	10.86	59.6	11.86	64.8	12.26	66.2	12.36
	29	37.8	6.66	45.0	8.48	52.4	10.51	56.0	11.61	59.6	12.55	63.6	12.76	65.2	12.86
	31	37.8	7.12	45.0	9.04	52.4	11.21	56.0	12.39	59.6	13.19	62.6	13.25	64.2	13.36
	33	37.8	7.54	45.0	9.63	52.4	11.96	56.0	13.22	59.6	13.69	61.6	13.75	63.2	13.86
	35	37.8	8.03	45.0	10.25	52.4	12.74	56.0	14.10	58.7	14.18	60.5	14.24	62.0	14.35
	37	37.8	8.60	45.0	10.99	52.4	13.49	56.0	14.77	57.7	14.84	59.4	14.90	60.8	15.04
	39	37.8	9.22	45.0	11.81	52.4	14.30	56.0	15.49	56.8	15.56	58.4	15.62	59.8	15.77
	41	37.2	9.84	44.3	12.62	51.6	15.10	53.7	16.22	54.9	16.28	56.2	16.34	58.0	16.49
	43	35.9	10.41	42.8	13.38	49.8	15.82	51.5	16.84	52.1	16.90	53.7	16.95	55.1	17.11
46	33.7	11.20	40.1	14.43	46.7	16.78	47.0	17.63	47.5	17.68	49.1	17.73	50.4	17.90	
48	29.8	9.67	35.5	12.48	40.3	14.35	40.9	14.95	41.3	15.00	42.7	15.04	43.8	15.16	
90	10	34.0	3.85	40.6	4.63	47.2	5.46	50.4	5.88	53.6	6.33	60.2	7.09	66.8	7.88
	12	34.0	3.90	40.6	4.70	47.2	5.55	50.4	6.00	53.6	6.47	60.2	7.23	66.8	8.02
	14	34.0	3.97	40.6	4.80	47.2	5.67	50.4	6.12	53.6	6.59	60.2	7.37	66.8	8.18
	16	34.0	4.04	40.6	4.89	47.2	5.79	50.4	6.24	53.6	6.71	60.2	7.51	66.8	8.32
	18	34.0	4.11	40.6	4.98	47.2	5.88	50.4	6.38	53.6	6.85	60.2	7.67	66.8	8.74
	20	34.0	4.18	40.6	5.08	47.2	6.00	50.4	6.50	53.6	7.11	60.2	8.21	66.8	9.16
	21	34.0	4.23	40.6	5.13	47.2	6.12	50.4	6.71	53.6	7.37	60.2	8.34	66.8	9.37
	23	34.0	4.32	40.6	5.34	47.2	6.54	50.4	7.20	53.6	7.89	60.2	8.85	65.9	9.81
	25	34.0	4.54	40.6	5.69	47.2	6.99	50.4	7.70	53.6	8.43	60.2	9.46	64.9	10.23
	27	34.0	4.84	40.6	6.07	47.2	7.46	50.4	8.22	53.6	9.02	60.2	10.06	64.0	10.71
	29	34.0	5.13	40.6	6.47	47.2	7.98	50.4	8.79	53.6	9.64	60.2	10.65	63.0	11.14
	31	34.0	5.46	40.6	6.90	47.2	8.50	50.4	9.35	53.6	10.28	60.2	11.18	62.1	11.57
	33	34.0	5.81	40.6	7.35	47.2	9.07	50.4	9.97	53.6	10.90	60.2	11.73	61.1	12.00
	35	34.0	6.17	40.6	7.80	47.2	9.64	50.4	10.63	53.6	11.56	59.2	12.40	60.2	12.68
	37	34.0	6.54	40.6	8.29	47.2	10.28	50.4	11.29	53.6	12.20	58.2	12.96	59.2	13.25
	39	34.0	6.93	40.6	8.82	47.2	10.88	50.4	12.02	53.6	12.83	57.3	13.66	58.3	13.83
	41	33.1	7.75	39.6	9.78	46.0	11.94	49.1	13.14	52.2	13.85	54.9	14.40	55.8	14.73
	43	32.3	8.37	38.6	10.57	44.9	13.04	47.9	14.15	50.9	14.85	52.6	15.42	53.6	15.61
46	30.3	9.42	36.2	12.03	42.0	14.86	44.9	16.05	46.3	16.50	48.0	16.93	48.9	16.95	
48	26.8	8.23	32.0	10.52	37.2	13.00	39.7	14.00	40.2	14.22	41.7	14.57	42.5	14.59	
80	10	30.2	3.27	36.0	3.92	41.8	4.60	44.8	4.97	47.8	5.33	53.6	6.08	59.4	6.60
	12	30.2	3.33	36.0	3.97	41.8	4.69	44.8	5.06	47.8	5.42	53.6	6.19	59.4	6.73
	14	30.2	3.38	36.0	4.06	41.8	4.76	44.8	5.15	47.8	5.51	53.6	6.30	59.4	6.86
	16	30.2	3.42	36.0	4.13	41.8	4.85	44.8	5.24	47.8	5.62	53.6	6.44	59.4	6.99
	18	30.2	3.49	36.0	4.20	41.8	4.94	44.8	5.33	47.8	5.74	53.6	6.55	59.4	7.14
	20	30.2	3.56	36.0	4.29	41.8	5.06	44.8	5.44	47.8	5.85	53.6	6.80	59.4	7.57
	21	30.2	3.58	36.0	4.33	41.8	5.10	44.8	5.51	47.8	5.99	53.6	7.02	59.4	7.77
	23	30.2	3.65	36.0	4.40	41.8	5.33	44.8	5.85	47.8	6.39	53.6	7.41	59.4	8.15
	25	30.2	3.79	36.0	4.69	41.8	5.71	44.8	6.26	47.8	6.85	53.6	7.93	59.4	8.72
	27	30.2	4.01	36.0	4.99	41.8	6.10	44.8	6.69	47.8	7.30	53.6	8.43	59.4	9.17
	29	30.2	4.26	36.0	5.33	41.8	6.49	44.8	7.12	47.8	7.80	53.6	9.03	59.4	9.82
	31	30.2	4.54	36.0	5.65	41.8	6.92	44.8	7.60	47.8	8.30	53.6	9.58	59.4	10.31
	33	30.2	4.81	36.0	6.03	41.8	7.37	44.8	8.10	47.8	8.84	53.6	10.09	59.4	10.81
	35	30.2	5.10	36.0	6.39	41.8	7.85	44.8	8.62	47.8	9.43	53.6	10.70	58.8	11.20
	37	30.2	5.40	36.0	6.80	41.8	8.32	44.8	9.16	47.8	10.02	53.6	11.30	57.8	11.71
	39	30.2	5.70	36.0	7.19	41.8	8.90	44.8	9.85	47.8	10.77	53.6	11.93	56.9	12.35
	41	29.4	6.31	35.1	7.97	40.7	9.77	43.7	10.80	46.6	11.84	52.2	13.28	54.5	13.69
	43	28.7	6.95	34.2	8.69	39.7	10.67	42.6	11.77	45.4	12.93	50.9	14.21	52.2	14.65
46	26.9	7.73	32.1	9.79	37.2	12.02	39.9	13.10	42.6	14.59	46.6	15.51	47.7	15.76	
48	23.8	6.75	28.4	8.56	32.9	10.51	35.3	11.44	37.7	12.78	40.5	13.43	41.4	13.57	

Note

1. TC: Total Capacity(kW), PI : Power Input(kW, Comp. + Outdoor fan motor)
2. Capacity tables show the average value of conditions which may occur.

7. Capacity Tables

Combination (%)	Outdoor air temp (°C DB)	Cooling Capacity(20HP)													
		Indoor air temp. (DB/WB, °C)													
		20		23		26		27		28		30		32	
		14	16	18	19	20	22	24							
	TC	PI	TC	PI	TC	PI	TC	PI	TC	PI	TC	PI	TC	PI	
70	10	26.4	2.90	31.6	3.45	36.6	4.00	39.2	4.32	41.8	4.62	46.8	5.26	52.0	5.88
	12	26.4	2.95	31.6	3.50	36.6	4.09	39.2	4.39	41.8	4.71	46.8	5.35	52.0	5.99
	14	26.4	2.99	31.6	3.54	36.6	4.16	39.2	4.46	41.8	4.78	46.8	5.46	52.0	6.10
	16	26.4	3.04	31.6	3.61	36.6	4.23	39.2	4.55	41.8	4.87	46.8	5.55	52.0	6.23
	18	26.4	3.09	31.6	3.68	36.6	4.32	39.2	4.64	41.8	4.96	46.8	5.65	52.0	6.34
	20	26.4	3.13	31.6	3.75	36.6	4.39	39.2	4.73	41.8	5.07	46.8	5.78	52.0	6.58
	21	26.4	3.18	31.6	3.77	36.6	4.43	39.2	4.78	41.8	5.12	46.8	5.87	52.0	6.72
	23	26.4	3.22	31.6	3.86	36.6	4.53	39.2	4.94	41.8	5.37	46.8	6.29	52.0	7.10
	25	26.4	3.27	31.6	4.00	36.6	4.82	39.2	5.28	41.8	5.74	46.8	6.72	52.0	7.44
	27	26.4	3.45	31.6	4.27	36.6	5.14	39.2	5.60	41.8	6.13	46.8	7.18	52.0	7.91
	29	26.4	3.68	31.6	4.53	36.6	5.46	39.2	5.97	41.8	6.51	46.8	7.66	52.0	8.47
	31	26.4	3.91	31.6	4.82	36.6	5.83	39.2	6.38	41.8	6.95	46.8	8.16	52.0	8.99
	33	26.4	4.14	31.6	5.10	36.6	6.19	39.2	6.77	41.8	7.38	46.8	8.69	52.0	9.57
	35	26.4	4.37	31.6	5.44	36.6	6.58	39.2	7.20	41.8	7.86	46.8	9.26	52.0	10.15
	37	26.4	4.64	31.6	5.76	36.6	6.99	39.2	7.66	41.8	8.37	46.8	9.85	52.0	10.71
	39	26.4	4.93	31.6	6.14	36.6	7.48	39.2	8.24	41.8	9.04	46.8	10.54	52.0	11.55
	41	25.7	5.45	30.8	6.73	35.7	8.20	38.2	9.04	40.7	9.82	45.6	11.58	50.7	12.46
	43	25.1	5.93	30.0	7.34	34.8	8.95	37.3	9.85	39.7	10.73	44.5	12.65	49.4	13.47
46	23.5	6.59	28.1	8.25	32.6	10.08	34.9	10.97	37.2	12.09	41.7	14.27	46.3	15.01	
48	20.8	5.75	24.9	7.20	28.8	8.81	30.9	9.59	32.9	10.58	36.9	12.49	41.0	12.99	
60	10	22.6	2.53	27.0	2.97	31.4	3.46	33.6	3.71	35.8	3.94	40.2	4.47	44.6	5.00
	12	22.6	2.58	27.0	3.02	31.4	3.50	33.6	3.75	35.8	4.01	40.2	4.54	44.6	5.09
	14	22.6	2.60	27.0	3.06	31.4	3.57	33.6	3.82	35.8	4.08	40.2	4.63	44.6	5.18
	16	22.6	2.65	27.0	3.13	31.4	3.62	33.6	3.89	35.8	4.17	40.2	4.72	44.6	5.28
	18	22.6	2.70	27.0	3.18	31.4	3.69	33.6	3.96	35.8	4.24	40.2	4.79	44.6	5.39
	20	22.6	2.74	27.0	3.23	31.4	3.75	33.6	4.03	35.8	4.31	40.2	4.88	44.6	5.51
	21	22.6	2.76	27.0	3.25	31.4	3.80	33.6	4.08	35.8	4.35	40.2	4.95	44.6	5.55
	23	22.6	2.81	27.0	3.32	31.4	3.85	33.6	4.15	35.8	4.45	40.2	5.14	44.6	5.90
	25	22.6	2.86	27.0	3.39	31.4	4.01	33.6	4.35	35.8	4.72	40.2	5.48	44.6	6.31
	27	22.6	2.95	27.0	3.57	31.4	4.26	33.6	4.63	35.8	5.02	40.2	5.83	44.6	6.73
	29	22.6	3.13	27.0	3.80	31.4	4.54	33.6	4.93	35.8	5.34	40.2	6.22	44.6	7.19
	31	22.6	3.32	27.0	4.03	31.4	4.81	33.6	5.25	35.8	5.69	40.2	6.63	44.6	7.65
	33	22.6	3.50	27.0	4.26	31.4	5.11	33.6	5.57	35.8	6.06	40.2	7.05	44.6	8.15
	35	22.6	3.71	27.0	4.54	31.4	5.44	33.6	5.92	35.8	6.43	40.2	7.51	44.6	8.66
	37	22.6	3.92	27.0	4.79	31.4	5.76	33.6	6.29	35.8	6.82	40.2	7.97	44.6	9.21
	39	22.6	4.16	27.0	5.10	31.4	6.22	33.6	6.75	35.8	7.34	40.2	8.55	44.6	9.87
	41	22.0	4.52	26.3	5.58	30.6	6.75	32.7	7.37	34.9	7.97	39.2	9.38	43.5	10.73
	43	21.5	4.91	25.7	6.08	29.8	7.36	31.9	8.03	34.0	8.69	38.2	10.24	42.4	11.72
46	20.1	5.50	24.0	6.82	28.0	8.28	29.9	9.03	31.9	9.77	35.8	11.54	39.7	13.35	
48	17.8	4.79	21.3	5.95	24.7	7.23	26.5	7.89	28.2	8.54	31.7	10.09	35.1	11.68	
50	10	18.9	2.21	22.6	2.55	26.2	2.90	28.0	3.11	29.8	3.30	33.4	3.71	37.2	4.13
	12	18.9	2.23	22.6	2.58	26.2	2.95	28.0	3.16	29.8	3.37	33.4	3.78	37.2	4.20
	14	18.9	2.25	22.6	2.62	26.2	2.99	28.0	3.20	29.8	3.41	33.4	3.83	37.2	4.27
	16	18.9	2.30	22.6	2.67	26.2	3.04	28.0	3.27	29.8	3.46	33.4	3.90	37.2	4.34
	18	18.9	2.32	22.6	2.69	26.2	3.09	28.0	3.32	29.8	3.53	33.4	3.97	37.2	4.43
	20	18.9	2.34	22.6	2.74	26.2	3.16	28.0	3.37	29.8	3.60	33.4	4.04	37.2	4.53
	21	18.9	2.37	22.6	2.76	26.2	3.18	28.0	3.41	29.8	3.62	33.4	4.09	37.2	4.57
	23	18.9	2.41	22.6	2.81	26.2	3.23	28.0	3.46	29.8	3.69	33.4	4.16	37.2	4.67
	25	18.9	2.44	22.6	2.86	26.2	3.30	28.0	3.53	29.8	3.81	33.4	4.36	37.2	4.99
	27	18.9	2.48	22.6	2.95	26.2	3.48	28.0	3.76	29.8	4.04	33.4	4.67	37.2	5.32
	29	18.9	2.62	22.6	3.13	26.2	3.69	28.0	3.99	29.8	4.30	33.4	4.95	37.2	5.64
	31	18.9	2.76	22.6	3.32	26.2	3.92	28.0	4.23	29.8	4.57	33.4	5.27	37.2	6.01
	33	18.9	2.93	22.6	3.51	26.2	4.16	28.0	4.48	29.8	4.85	33.4	5.60	37.2	6.41
	35	18.9	3.09	22.6	3.71	26.2	4.39	28.0	4.76	29.8	5.13	33.4	5.92	37.2	6.80
	37	18.9	3.27	22.6	3.92	26.2	4.64	28.0	5.04	29.8	5.43	33.4	6.31	37.2	7.22
	39	18.9	3.49	22.6	4.21	26.2	4.98	28.0	5.42	29.8	5.83	33.4	6.73	37.2	7.80
	41	18.4	3.78	22.0	4.55	25.5	5.44	27.3	5.87	29.0	6.32	32.5	7.37	36.2	8.47
	43	18.0	4.10	21.5	4.95	24.9	5.92	26.6	6.40	28.3	6.88	31.7	8.04	35.4	9.24
46	16.8	4.60	20.1	5.55	23.3	6.64	24.9	7.18	26.5	7.72	29.7	9.05	33.1	10.40	
48	14.9	4.01	17.8	4.84	20.6	5.79	22.1	6.27	23.5	6.74	26.3	7.91	29.3	9.09	

Note

- TC: Total Capacity(kW), PI : Power Input(kW, Comp. + Outdoor fan motor)
- Capacity tables show the average value of conditions which may occur.

7. Capacity Tables

◆ A(C)RUN220LLS5

Combination (%)	Outdoor air temp (°C DB)	Indoor air temp. (DB/WB, °C)														Cooling Capacity(22HP)	
		20		23		26		27		28		30		32		TC	PI
		14		16		18		19		20		22		24			
		TC	PI	TC	PI	TC	PI	TC	PI	TC	PI	TC	PI	TC	PI		
130	10	61.0	7.13	72.7	8.71	77.9	10.10	80.1	10.31	82.3	10.39	86.3	10.47	88.5	10.52		
	12	61.0	7.30	72.7	9.02	77.9	10.52	80.1	10.59	82.3	10.67	86.3	10.76	88.5	10.85		
	14	61.0	7.55	72.7	9.35	77.9	10.91	80.1	10.99	82.3	11.08	86.3	11.17	88.5	11.27		
	16	61.0	7.82	72.7	9.67	77.9	11.40	80.1	11.51	82.3	11.60	86.3	11.71	88.5	11.80		
	18	61.0	8.15	72.7	10.23	77.9	11.93	80.1	12.18	82.3	12.28	86.3	12.40	88.5	12.49		
	20	61.0	8.51	72.7	10.90	77.9	12.52	80.1	13.40	82.3	13.51	85.1	13.64	87.3	13.74		
	21	61.0	8.73	72.7	11.29	77.9	12.78	80.1	14.18	82.3	14.30	84.6	14.44	86.8	14.54		
	23	61.0	9.37	72.7	11.87	77.9	13.44	80.1	15.65	81.3	15.78	83.3	15.93	85.6	16.04		
	25	61.0	10.01	72.7	12.55	77.9	14.36	79.2	17.36	80.1	17.50	82.3	17.67	84.6	17.79		
	27	61.0	10.71	72.7	13.42	76.9	15.30	77.9	19.11	79.2	19.26	81.3	19.45	83.3	19.59		
	29	61.0	11.41	72.7	14.35	75.6	16.47	76.7	21.00	77.9	21.13	80.1	21.32	82.3	21.49		
	31	61.0	12.18	72.4	15.11	74.4	17.52	75.6	20.91	76.7	21.04	78.9	21.23	81.1	21.31		
	33	61.0	12.97	71.2	16.01	73.4	18.79	74.6	20.72	75.6	20.85	77.9	21.03	79.8	21.11		
	35	61.0	13.84	69.9	16.77	72.2	20.35	73.4	20.45	74.6	20.57	76.6	20.76	78.9	20.84		
	37	61.0	14.75	68.9	17.60	71.2	20.08	72.2	20.18	73.4	20.30	75.4	20.48	77.6	20.56		
	39	61.0	15.71	67.7	18.52	69.9	19.81	71.2	19.91	72.2	20.03	74.4	20.21	76.6	20.29		
	41	59.5	16.67	64.9	19.45	67.1	19.54	68.1	19.64	69.4	19.76	71.5	19.94	73.5	20.01		
	43	58.0	17.58	62.2	19.18	64.4	19.27	65.3	19.37	66.6	19.49	68.7	19.66	70.6	19.74		
46	54.3	18.81	56.7	18.78	58.8	18.87	59.7	18.97	61.0	19.08	62.9	19.25	64.6	19.33			
48	48.1	18.29	49.3	18.34	51.1	18.38	51.9	18.43	53.0	18.59	54.7	18.71	56.3	18.78			
120	10	55.2	6.41	65.6	7.86	71.7	9.34	73.9	10.10	76.1	10.26	80.2	10.30	82.2	10.38		
	12	55.2	6.58	65.6	8.13	71.7	9.72	73.9	10.31	76.1	10.63	80.2	10.76	82.2	10.85		
	14	55.2	6.81	65.6	8.40	71.7	10.11	73.9	10.70	76.1	11.02	80.2	11.19	82.2	11.28		
	16	55.2	7.06	65.6	8.75	71.7	10.50	73.9	11.10	76.1	11.53	80.2	11.68	82.2	11.77		
	18	55.2	7.33	65.6	9.14	71.7	10.92	73.9	11.68	76.1	12.13	80.2	12.26	82.2	12.36		
	20	55.2	7.61	65.6	9.69	71.7	11.51	73.9	12.30	76.1	12.77	80.2	12.94	82.2	13.04		
	21	55.2	7.84	65.6	10.04	71.7	11.83	73.9	12.66	76.1	13.19	80.2	13.36	82.2	13.46		
	23	55.2	8.38	65.6	10.74	71.7	12.68	73.9	13.45	76.1	14.06	80.2	14.20	82.2	14.32		
	25	55.2	8.96	65.6	11.51	71.7	13.37	73.9	14.34	76.1	15.08	79.3	15.20	81.2	15.33		
	27	55.2	9.56	65.6	12.31	71.7	14.23	73.9	15.32	76.1	16.20	78.1	16.31	80.0	16.44		
	29	55.2	10.20	65.6	13.13	71.7	14.97	73.9	16.39	74.9	17.27	76.8	17.53	79.0	17.67		
	31	55.2	10.87	65.6	14.03	71.7	15.75	73.0	17.56	73.9	18.53	75.9	18.85	77.8	19.00		
	33	55.2	11.57	65.6	14.95	70.8	16.66	71.7	19.06	72.7	19.89	74.7	20.12	76.6	20.28		
	35	55.2	12.31	65.6	15.94	69.6	17.63	70.5	21.00	71.7	21.11	73.7	21.17	75.6	21.34		
	37	55.2	13.24	65.6	16.82	68.6	18.80	69.6	20.56	70.5	20.66	72.5	20.72	74.4	20.89		
	39	55.2	14.25	65.4	17.78	67.4	19.94	68.3	20.14	69.3	20.24	71.5	20.30	73.4	20.46		
	41	53.8	15.26	62.6	18.73	64.7	19.54	65.6	19.71	66.5	19.81	68.5	19.87	70.4	20.03		
	43	52.5	16.29	59.9	18.47	62.0	19.11	62.9	19.29	63.8	19.39	65.7	19.45	67.6	19.60		
46	49.2	17.52	54.7	18.03	56.6	18.51	57.5	18.66	58.3	18.75	60.1	18.81	61.9	18.96			
48	43.5	17.16	47.5	17.71	49.2	18.14	50.0	18.25	50.7	18.31	52.3	18.39	53.9	18.46			
110	10	49.5	5.77	59.0	7.03	65.9	8.35	67.7	9.04	72.0	9.73	73.7	10.00	78.7	10.16		
	12	49.5	5.95	59.0	7.27	65.9	8.70	67.7	9.29	72.0	10.09	73.7	10.42	78.7	10.66		
	14	49.5	6.13	59.0	7.59	65.9	9.09	67.7	9.75	72.0	10.60	73.7	10.90	78.7	11.13		
	16	49.5	6.35	59.0	7.87	65.9	9.47	67.7	10.18	72.0	11.09	73.7	11.39	78.7	11.59		
	18	49.5	6.59	59.0	8.20	65.9	10.01	67.7	10.72	72.0	11.70	73.7	11.93	78.7	12.15		
	20	49.5	6.82	59.0	8.61	65.9	10.62	67.7	11.21	72.0	12.26	73.7	12.57	78.7	12.77		
	21	49.5	6.97	59.0	8.86	65.9	10.89	67.7	11.51	72.0	12.61	73.7	12.92	78.7	13.13		
	23	49.5	7.43	59.0	9.50	65.9	11.50	67.7	12.15	72.0	13.32	73.7	13.60	78.7	13.83		
	25	49.5	7.94	59.0	10.14	65.9	12.14	67.7	12.85	72.0	14.07	73.7	14.27	77.7	14.56		
	27	49.5	8.48	59.0	10.84	65.9	12.83	67.7	13.60	72.0	14.69	73.7	15.03	76.6	15.29		
	29	49.5	9.05	59.0	11.57	65.9	13.56	67.7	14.40	72.0	15.53	73.7	15.80	75.6	16.04		
	31	49.5	9.63	59.0	12.34	65.9	14.33	67.7	15.26	70.9	16.32	72.7	16.64	74.4	16.81		
	33	49.5	10.26	59.0	13.13	65.9	15.14	67.7	16.17	69.9	17.23	71.6	17.52	73.5	17.61		
	35	49.5	10.90	59.0	14.03	65.9	15.99	67.7	17.13	68.7	18.19	70.4	18.35	72.3	18.44		
	37	49.5	11.55	59.0	14.89	65.9	16.88	66.8	18.15	67.5	19.18	69.4	19.25	71.1	19.30		
	39	49.5	12.46	59.0	15.82	64.7	17.81	65.6	19.41	66.6	20.13	68.2	20.17	70.1	20.19		
	41	48.2	13.36	57.5	16.75	61.9	18.78	62.9	21.00	63.7	21.00	65.5	21.17	67.2	21.34		
	43	47.0	14.03	56.0	17.45	59.3	19.92	60.3	20.14	61.1	20.10	62.9	20.21	64.5	20.27		
46	44.0	13.69	52.5	16.85	54.1	18.90	55.1	18.90	55.8	19.07	57.5	19.17	59.0	19.22			
48	39.0	13.30	45.6	16.23	47.0	17.99	47.9	18.11	48.5	18.19	50.0	18.25	51.3	18.32			

Note

1. TC: Total Capacity(kW), PI: Power Input(kW, Comp. + Outdoor fan motor)
2. Capacity tables show the average value of conditions which may occur.

7. Capacity Tables

Combination (%)	Outdoor air temp (°C DB)	Cooling Capacity(22HP)													
		Indoor air temp. (DB/WB, °C)													
		20		23		26		27		28		30		32	
		14	16	18	19	20	22	24	TC	PI	TC	PI	TC	PI	
100	10	41.6	5.19	49.5	6.31	57.6	7.49	61.6	8.09	65.6	8.69	72.7	9.68	74.3	9.75
	12	41.6	5.36	49.5	6.57	57.6	7.74	61.6	8.31	65.6	8.97	72.7	10.20	74.3	10.30
	14	41.6	5.53	49.5	6.83	57.6	8.07	61.6	8.67	65.6	9.36	72.7	10.77	74.3	10.87
	16	41.6	5.70	49.5	7.06	57.6	8.41	61.6	9.08	65.6	9.86	72.7	11.29	74.3	11.45
	18	41.6	5.86	49.5	7.32	57.6	8.74	61.6	9.52	65.6	10.46	72.7	11.93	74.3	12.02
	20	41.6	6.07	49.5	7.60	57.6	9.24	61.6	10.20	65.6	11.19	72.7	12.50	74.3	12.60
	21	41.6	6.20	49.5	7.78	57.6	9.56	61.6	10.55	65.6	11.60	72.7	12.78	74.3	12.89
	23	41.6	6.57	49.5	8.32	57.6	10.26	61.6	11.32	65.6	12.43	72.7	13.39	74.3	13.49
	25	41.6	6.98	49.5	8.86	57.6	10.97	61.6	12.11	65.6	13.29	72.7	13.96	73.7	14.07
	27	41.6	7.46	49.5	9.47	57.6	11.73	61.6	12.94	65.6	14.13	71.3	14.61	72.8	14.73
	29	41.6	7.94	49.5	10.11	57.6	12.53	61.6	13.84	65.6	14.96	69.9	15.20	71.7	15.32
	31	41.6	8.48	49.5	10.77	57.6	13.36	61.6	14.76	65.6	15.72	68.9	15.79	70.6	15.92
	33	41.6	8.99	49.5	11.48	57.6	14.25	61.6	15.75	65.6	16.31	67.8	16.38	69.5	16.51
	35	41.6	9.56	49.5	12.21	57.6	15.17	61.6	16.80	64.6	16.90	66.6	16.97	68.3	17.10
	37	41.6	10.24	49.5	13.10	57.6	16.07	61.6	17.60	63.5	17.69	65.3	17.76	66.9	17.92
	39	41.6	10.98	49.5	14.07	57.6	17.03	61.6	18.46	62.4	18.54	64.3	18.61	65.8	18.78
	41	40.9	11.72	48.7	15.04	56.7	17.99	59.1	19.32	60.4	19.40	61.8	19.47	63.8	19.65
	43	39.5	12.40	47.0	15.94	54.8	18.85	56.7	20.06	57.3	20.13	59.1	20.20	60.6	20.39
46	37.0	13.34	44.1	17.19	51.3	20.00	51.7	21.00	52.3	21.06	54.0	21.12	55.4	21.32	
48	32.8	11.52	39.0	14.87	44.3	17.09	45.0	17.82	45.4	17.88	46.9	17.92	48.2	18.06	
90	10	37.4	4.51	44.7	5.42	51.9	6.39	55.4	6.89	59.0	7.42	66.2	8.30	73.5	9.23
	12	37.4	4.57	44.7	5.51	51.9	6.50	55.4	7.03	59.0	7.58	66.2	8.46	73.5	9.39
	14	37.4	4.65	44.7	5.62	51.9	6.64	55.4	7.17	59.0	7.72	66.2	8.63	73.5	9.58
	16	37.4	4.73	44.7	5.73	51.9	6.78	55.4	7.30	59.0	7.86	66.2	8.79	73.5	9.75
	18	37.4	4.81	44.7	5.84	51.9	6.89	55.4	7.47	59.0	8.02	66.2	8.99	73.5	10.24
	20	37.4	4.90	44.7	5.95	51.9	7.03	55.4	7.61	59.0	8.33	66.2	9.62	73.5	10.73
	21	37.4	4.95	44.7	6.00	51.9	7.17	55.4	7.86	59.0	8.63	66.2	9.77	73.5	10.97
	23	37.4	5.06	44.7	6.25	51.9	7.66	55.4	8.44	59.0	9.24	66.2	10.36	72.5	11.49
	25	37.4	5.31	44.7	6.67	51.9	8.19	55.4	9.02	59.0	9.88	66.2	11.08	71.4	11.98
	27	37.4	5.67	44.7	7.11	51.9	8.74	55.4	9.63	59.0	10.57	66.2	11.78	70.4	12.54
	29	37.4	6.00	44.7	7.58	51.9	9.35	55.4	10.29	59.0	11.29	66.2	12.48	69.3	13.05
	31	37.4	6.39	44.7	8.08	51.9	9.96	55.4	10.96	59.0	12.04	66.2	13.10	68.3	13.55
	33	37.4	6.81	44.7	8.61	51.9	10.63	55.4	11.68	59.0	12.77	66.2	13.73	67.2	14.06
	35	37.4	7.22	44.7	9.13	51.9	11.29	55.4	12.45	59.0	13.54	65.1	14.52	66.2	14.86
	37	37.4	7.66	44.7	9.71	51.9	12.04	55.4	13.23	59.0	14.29	64.0	15.18	65.1	15.52
	39	37.4	8.12	44.7	10.33	51.9	12.74	55.4	14.08	59.0	15.03	63.0	16.01	64.1	16.20
	41	36.4	9.08	43.5	11.45	50.6	13.98	54.0	15.39	57.5	16.22	60.4	16.87	61.4	17.25
	43	35.5	9.80	42.4	12.38	49.3	15.27	52.7	16.58	56.0	17.40	57.9	18.06	58.9	18.28
46	33.3	11.03	39.8	14.09	46.2	17.40	49.4	18.80	50.9	19.33	52.8	19.83	53.8	19.86	
48	29.5	9.64	35.2	12.33	40.9	15.23	43.7	16.40	44.2	16.65	45.9	17.07	46.8	17.09	
80	10	33.2	3.76	39.6	4.52	46.0	5.30	49.3	5.72	52.6	6.14	59.0	7.00	65.3	7.60
	12	33.2	3.84	39.6	4.57	46.0	5.40	49.3	5.82	52.6	6.24	59.0	7.13	65.3	7.75
	14	33.2	3.89	39.6	4.67	46.0	5.48	49.3	5.93	52.6	6.34	59.0	7.26	65.3	7.90
	16	33.2	3.94	39.6	4.75	46.0	5.59	49.3	6.03	52.6	6.47	59.0	7.41	65.3	8.05
	18	33.2	4.02	39.6	4.83	46.0	5.69	49.3	6.14	52.6	6.61	59.0	7.54	65.3	8.22
	20	33.2	4.10	39.6	4.93	46.0	5.82	49.3	6.27	52.6	6.74	59.0	7.83	65.3	8.71
	21	33.2	4.12	39.6	4.99	46.0	5.87	49.3	6.34	52.6	6.89	59.0	8.08	65.3	8.94
	23	33.2	4.20	39.6	5.06	46.0	6.14	49.3	6.74	52.6	7.36	59.0	8.53	65.3	9.39
	25	33.2	4.36	39.6	5.40	46.0	6.58	49.3	7.21	52.6	7.88	59.0	9.13	65.3	10.04
	27	33.2	4.62	39.6	5.74	46.0	7.02	49.3	7.70	52.6	8.41	59.0	9.70	65.3	10.56
	29	33.2	4.91	39.6	6.14	46.0	7.47	49.3	8.20	52.6	8.98	59.0	10.39	65.3	11.30
	31	33.2	5.22	39.6	6.50	46.0	7.96	49.3	8.75	52.6	9.56	59.0	11.03	65.3	11.87
	33	33.2	5.53	39.6	6.94	46.0	8.48	49.3	9.32	52.6	10.18	59.0	11.62	65.3	12.44
	35	33.2	5.87	39.6	7.36	46.0	9.03	49.3	9.92	52.6	10.86	59.0	12.32	64.6	12.89
	37	33.2	6.21	39.6	7.83	46.0	9.58	49.3	10.55	52.6	11.54	59.0	13.00	63.6	13.48
	39	33.2	6.57	39.6	8.28	46.0	10.25	49.3	11.34	52.6	12.40	59.0	13.74	62.6	14.22
	41	32.4	7.26	38.6	9.17	44.8	11.25	48.0	12.43	51.2	13.63	57.5	15.29	59.9	15.76
	43	31.6	8.00	37.6	10.01	43.7	12.28	46.8	13.55	50.0	14.89	56.0	16.36	57.5	16.87
46	29.6	8.90	35.3	11.27	40.9	13.83	43.9	15.08	46.8	16.80	51.2	17.86	52.4	18.15	
48	26.2	7.77	31.2	9.86	36.2	12.10	38.8	13.17	41.4	14.71	44.5	15.46	45.6	15.62	

Note

1. TC: Total Capacity(kW), PI : Power Input(kW, Comp. + Outdoor fan motor)
2. Capacity tables show the average value of conditions which may occur.

7. Capacity Tables

Combination (%)	Outdoor air temp (°C DB)	Cooling Capacity(22HP)													
		Indoor air temp. (DB/WB, °C)													
		20		23		26		27		28		30		32	
		14	16	18	19	20	22	24							
	TC	PI	TC	PI	TC	PI	TC	PI	TC	PI	TC	PI	TC	PI	
70	10	29.0	3.28	34.8	3.91	40.3	4.53	43.1	4.89	46.0	5.22	51.5	5.95	57.2	6.65
	12	29.0	3.34	34.8	3.96	40.3	4.63	43.1	4.97	46.0	5.33	51.5	6.05	57.2	6.78
	14	29.0	3.39	34.8	4.01	40.3	4.71	43.1	5.04	46.0	5.40	51.5	6.18	57.2	6.90
	16	29.0	3.44	34.8	4.09	40.3	4.78	43.1	5.15	46.0	5.51	51.5	6.28	57.2	7.05
	18	29.0	3.49	34.8	4.16	40.3	4.89	43.1	5.25	46.0	5.61	51.5	6.39	57.2	7.17
	20	29.0	3.54	34.8	4.24	40.3	4.97	43.1	5.35	46.0	5.74	51.5	6.54	57.2	7.45
	21	29.0	3.59	34.8	4.27	40.3	5.02	43.1	5.40	46.0	5.79	51.5	6.65	57.2	7.61
	23	29.0	3.65	34.8	4.37	40.3	5.12	43.1	5.59	46.0	6.08	51.5	7.11	57.2	8.03
	25	29.0	3.70	34.8	4.53	40.3	5.46	43.1	5.97	46.0	6.49	51.5	7.60	57.2	8.42
	27	29.0	3.91	34.8	4.84	40.3	5.82	43.1	6.34	46.0	6.93	51.5	8.12	57.2	8.95
	29	29.0	4.16	34.8	5.12	40.3	6.18	43.1	6.75	46.0	7.37	51.5	8.66	57.2	9.59
	31	29.0	4.42	34.8	5.46	40.3	6.59	43.1	7.22	46.0	7.86	51.5	9.23	57.2	10.17
	33	29.0	4.68	34.8	5.77	40.3	7.01	43.1	7.65	46.0	8.35	51.5	9.83	57.2	10.83
	35	29.0	4.94	34.8	6.16	40.3	7.45	43.1	8.15	46.0	8.90	51.5	10.47	57.2	11.48
	37	29.0	5.25	34.8	6.52	40.3	7.91	43.1	8.66	46.0	9.47	51.5	11.15	57.2	12.12
	39	29.0	5.57	34.8	6.95	40.3	8.46	43.1	9.32	46.0	10.22	51.5	11.93	57.2	13.07
	41	28.3	6.16	33.9	7.62	39.2	9.28	42.0	10.22	44.8	11.12	50.2	13.10	55.7	14.10
	43	27.6	6.71	33.0	8.30	38.3	10.13	41.0	11.15	43.7	12.14	48.9	14.31	54.4	15.24
46	25.9	7.46	31.0	9.33	35.9	11.40	38.4	12.42	40.9	13.68	45.8	16.14	50.9	16.99	
48	22.9	6.51	27.4	8.15	31.7	9.97	34.0	10.85	36.2	11.97	40.6	14.13	45.1	14.70	
60	10	24.9	2.82	29.7	3.30	34.5	3.84	37.0	4.12	39.4	4.38	44.2	4.97	49.1	5.56
	12	24.9	2.87	29.7	3.36	34.5	3.89	37.0	4.18	39.4	4.46	44.2	5.05	49.1	5.66
	14	24.9	2.89	29.7	3.41	34.5	3.97	37.0	4.25	39.4	4.53	44.2	5.15	49.1	5.76
	16	24.9	2.95	29.7	3.48	34.5	4.02	37.0	4.33	39.4	4.64	44.2	5.25	49.1	5.87
	18	24.9	3.00	29.7	3.53	34.5	4.10	37.0	4.41	39.4	4.71	44.2	5.33	49.1	5.99
	20	24.9	3.05	29.7	3.59	34.5	4.18	37.0	4.48	39.4	4.79	44.2	5.43	49.1	6.12
	21	24.9	3.07	29.7	3.61	34.5	4.23	37.0	4.53	39.4	4.84	44.2	5.51	49.1	6.17
	23	24.9	3.13	29.7	3.69	34.5	4.28	37.0	4.61	39.4	4.94	44.2	5.71	49.1	6.56
	25	24.9	3.18	29.7	3.77	34.5	4.46	37.0	4.84	39.4	5.25	44.2	6.10	49.1	7.02
	27	24.9	3.28	29.7	3.97	34.5	4.74	37.0	5.15	39.4	5.58	44.2	6.48	49.1	7.48
	29	24.9	3.48	29.7	4.23	34.5	5.05	37.0	5.48	39.4	5.94	44.2	6.92	49.1	7.99
	31	24.9	3.69	29.7	4.48	34.5	5.35	37.0	5.84	39.4	6.33	44.2	7.38	49.1	8.50
	33	24.9	3.89	29.7	4.74	34.5	5.69	37.0	6.20	39.4	6.74	44.2	7.84	49.1	9.07
	35	24.9	4.12	29.7	5.05	34.5	6.05	37.0	6.58	39.4	7.15	44.2	8.35	49.1	9.63
	37	24.9	4.35	29.7	5.33	34.5	6.40	37.0	6.99	39.4	7.58	44.2	8.86	49.1	10.25
	39	24.9	4.63	29.7	5.67	34.5	6.91	37.0	7.50	39.4	8.16	44.2	9.50	49.1	10.98
	41	24.2	5.02	28.9	6.21	33.7	7.51	36.0	8.20	38.4	8.86	43.1	10.43	47.8	11.93
	43	23.6	5.46	28.2	6.76	32.8	8.18	35.1	8.93	37.4	9.66	42.0	11.38	46.6	13.03
46	22.1	6.11	26.5	7.59	30.8	9.20	32.9	10.04	35.1	10.87	39.4	12.83	43.7	14.85	
48	19.6	5.33	23.4	6.62	27.2	8.04	29.1	8.77	31.0	9.50	34.8	11.22	38.7	12.99	
50	10	20.8	2.41	24.9	2.79	28.8	3.17	30.8	3.40	32.8	3.60	36.7	4.06	40.9	4.52
	12	20.8	2.44	24.9	2.82	28.8	3.22	30.8	3.45	32.8	3.68	36.7	4.14	40.9	4.59
	14	20.8	2.46	24.9	2.87	28.8	3.27	30.8	3.50	32.8	3.73	36.7	4.19	40.9	4.67
	16	20.8	2.51	24.9	2.92	28.8	3.32	30.8	3.58	32.8	3.78	36.7	4.26	40.9	4.74
	18	20.8	2.54	24.9	2.94	28.8	3.37	30.8	3.63	32.8	3.86	36.7	4.34	40.9	4.85
	20	20.8	2.56	24.9	2.99	28.8	3.45	30.8	3.68	32.8	3.93	36.7	4.41	40.9	4.95
	21	20.8	2.59	24.9	3.02	28.8	3.48	30.8	3.73	32.8	3.96	36.7	4.47	40.9	5.00
	23	20.8	2.64	24.9	3.07	28.8	3.53	30.8	3.78	32.8	4.03	36.7	4.54	40.9	5.10
	25	20.8	2.66	24.9	3.12	28.8	3.60	30.8	3.86	32.8	4.16	36.7	4.77	40.9	5.45
	27	20.8	2.71	24.9	3.22	28.8	3.81	30.8	4.11	32.8	4.41	36.7	5.10	40.9	5.81
	29	20.8	2.87	24.9	3.42	28.8	4.03	30.8	4.36	32.8	4.69	36.7	5.40	40.9	6.16
	31	20.8	3.02	24.9	3.63	28.8	4.29	30.8	4.62	32.8	5.00	36.7	5.76	40.9	6.57
	33	20.8	3.20	24.9	3.83	28.8	4.54	30.8	4.90	32.8	5.30	36.7	6.11	40.9	7.00
	35	20.8	3.37	24.9	4.06	28.8	4.79	30.8	5.20	32.8	5.61	36.7	6.47	40.9	7.43
	37	20.8	3.58	24.9	4.29	28.8	5.07	30.8	5.51	32.8	5.94	36.7	6.90	40.9	7.89
	39	20.8	3.82	24.9	4.60	28.8	5.44	30.8	5.93	32.8	6.37	36.7	7.35	40.9	8.52
	41	20.3	4.13	24.2	4.97	28.1	5.94	30.0	6.42	31.9	6.90	35.8	8.06	39.9	9.25
	43	19.8	4.48	23.6	5.41	27.4	6.47	29.3	6.99	31.2	7.51	34.9	8.79	38.9	10.10
46	18.5	5.02	22.1	6.07	25.7	7.26	27.4	7.85	29.2	8.44	32.7	9.89	36.4	11.37	
48	16.4	4.38	19.6	5.29	22.7	6.33	24.3	6.85	25.8	7.36	28.9	8.64	32.2	9.93	

Note

1. TC: Total Capacity(kW), PI : Power Input(kW, Comp. + Outdoor fan motor)
2. Capacity tables show the average value of conditions which may occur.

7. Capacity Tables

◆ A(C)RUN240LLS5

Combination (%)	Outdoor air temp (°C DB)	Indoor air temp. (DB/WB, °C)														Cooling Capacity(24HP)	
		20		23		26		27		28		30		32		TC	PI
		14		16		18		19		20		22		24			
		TC	PI	TC	PI	TC	PI	TC	PI	TC	PI	TC	PI	TC	PI		
130	10	66.6	7.72	79.3	9.44	85.0	10.95	87.4	11.17	89.8	11.26	94.2	11.35	96.6	11.39		
	12	66.6	7.91	79.3	9.77	85.0	11.40	87.4	11.47	89.8	11.56	94.2	11.65	96.6	11.76		
	14	66.6	8.18	79.3	10.13	85.0	11.82	87.4	11.91	89.8	12.01	94.2	12.10	96.6	12.21		
	16	66.6	8.48	79.3	10.48	85.0	12.35	87.4	12.47	89.8	12.57	94.2	12.68	96.6	12.78		
	18	66.6	8.83	79.3	11.09	85.0	12.92	87.4	13.20	89.8	13.31	94.2	13.44	96.6	13.53		
	20	66.6	9.22	79.3	11.81	85.0	13.56	87.4	14.52	89.8	14.64	92.8	14.78	95.2	14.88		
	21	66.6	9.46	79.3	12.23	85.0	13.84	87.4	15.37	89.8	15.49	92.3	15.64	94.7	15.75		
	23	66.6	10.15	79.3	12.86	85.0	14.56	87.4	16.95	88.7	17.09	90.9	17.26	93.3	17.38		
	25	66.6	10.84	79.3	13.60	85.0	15.56	86.4	18.80	87.4	18.95	89.8	19.14	92.3	19.27		
	27	66.6	11.60	79.3	14.54	83.9	16.58	85.0	20.70	86.4	20.87	88.7	21.07	90.9	21.22		
	29	66.6	12.36	79.3	15.54	82.5	17.84	83.7	22.75	85.0	22.89	87.4	23.09	89.8	23.18		
	31	66.6	13.19	79.0	16.37	81.2	18.98	82.5	22.65	83.7	22.79	86.0	22.99	88.5	23.09		
	33	66.6	14.06	77.6	17.35	80.1	20.35	81.4	22.45	82.5	22.58	85.0	22.78	87.1	22.87		
	35	66.6	14.99	76.3	18.17	78.7	22.04	80.1	22.16	81.4	22.29	83.6	22.49	86.0	22.58		
	37	66.6	15.98	75.2	19.06	77.6	21.75	78.7	21.86	80.1	21.99	82.3	22.19	84.7	22.28		
	39	66.6	17.02	73.9	20.07	76.3	21.46	77.6	21.57	78.7	21.70	81.2	21.89	83.6	21.98		
	41	64.9	18.06	70.8	21.07	73.2	21.17	74.3	21.28	75.7	21.41	78.0	21.60	80.1	21.68		
	43	63.3	19.04	67.9	20.77	70.2	20.88	71.3	20.98	72.7	21.11	74.9	21.30	77.0	21.38		
46	59.3	20.38	61.9	20.34	64.1	20.44	65.1	20.55	66.5	20.67	68.6	20.85	70.5	20.94			
48	52.4	19.81	53.8	19.87	55.8	19.92	56.7	19.97	57.9	20.14	59.7	20.27	61.4	20.35			
120	10	60.2	6.95	71.6	8.52	78.3	10.12	80.6	10.94	83.0	11.11	87.5	11.15	89.7	11.24		
	12	60.2	7.13	71.6	8.80	78.3	10.53	80.6	11.17	83.0	11.52	87.5	11.66	89.7	11.75		
	14	60.2	7.38	71.6	9.10	78.3	10.95	80.6	11.59	83.0	11.94	87.5	12.12	89.7	12.22		
	16	60.2	7.64	71.6	9.47	78.3	11.38	80.6	12.02	83.0	12.50	87.5	12.65	89.7	12.75		
	18	60.2	7.94	71.6	9.90	78.3	11.83	80.6	12.66	83.0	13.14	87.5	13.29	89.7	13.39		
	20	60.2	8.25	71.6	10.50	78.3	12.47	80.6	13.32	83.0	13.83	87.5	14.01	89.7	14.13		
	21	60.2	8.50	71.6	10.88	78.3	12.82	80.6	13.71	83.0	14.29	87.5	14.47	89.7	14.58		
	23	60.2	9.08	71.6	11.64	78.3	13.73	80.6	14.57	83.0	15.23	87.5	15.39	89.7	15.51		
	25	60.2	9.70	71.6	12.47	78.3	14.48	80.6	15.53	83.0	16.33	86.5	16.47	88.6	16.60		
	27	60.2	10.36	71.6	13.33	78.3	15.41	80.6	16.59	83.0	17.55	85.2	17.67	87.3	17.81		
	29	60.2	11.05	71.6	14.23	78.3	16.22	80.6	17.76	81.7	18.71	83.8	18.99	86.2	19.14		
	31	60.2	11.78	71.6	15.20	78.3	17.06	79.6	19.03	80.6	20.07	82.8	20.42	84.9	20.59		
	33	60.2	12.54	71.6	16.20	77.2	18.05	78.3	20.65	79.3	21.55	81.4	21.79	83.6	21.97		
	35	60.2	13.33	71.6	17.27	75.9	19.10	76.9	22.75	78.3	22.86	80.4	22.93	82.5	23.11		
	37	60.2	14.34	71.6	18.22	74.8	20.36	75.9	22.27	76.9	22.38	79.1	22.45	81.2	22.63		
	39	60.2	15.44	71.4	19.26	73.5	21.60	74.5	21.81	75.6	21.92	78.0	21.99	80.1	22.16		
	41	58.7	16.53	68.2	20.29	70.5	21.17	71.5	21.36	72.6	21.46	74.7	21.53	76.8	21.70		
	43	57.2	17.65	65.4	20.00	67.7	20.70	68.6	20.90	69.6	21.00	71.7	21.07	73.8	21.23		
46	53.6	18.98	59.6	19.53	61.8	20.05	62.7	20.21	63.6	20.31	65.6	20.37	67.5	20.54			
48	47.5	18.59	51.8	19.18	53.7	19.66	54.5	19.78	55.3	19.84	57.1	19.92	58.8	20.00			
110	10	54.0	6.25	64.3	7.61	71.9	9.04	73.9	9.79	78.6	10.54	80.4	10.83	85.8	11.01		
	12	54.0	6.44	64.3	7.87	71.9	9.42	73.9	10.07	78.6	10.93	80.4	11.28	85.8	11.55		
	14	54.0	6.64	64.3	8.23	71.9	9.85	73.9	10.56	78.6	11.48	80.4	11.81	85.8	12.06		
	16	54.0	6.88	64.3	8.53	71.9	10.25	73.9	11.03	78.6	12.01	80.4	12.34	85.8	12.56		
	18	54.0	7.13	64.3	8.88	71.9	10.84	73.9	11.61	78.6	12.67	80.4	12.92	85.8	13.16		
	20	54.0	7.39	64.3	9.32	71.9	11.50	73.9	12.14	78.6	13.29	80.4	13.61	85.8	13.83		
	21	54.0	7.55	64.3	9.60	71.9	11.80	73.9	12.47	78.6	13.66	80.4	14.00	85.8	14.22		
	23	54.0	8.05	64.3	10.29	71.9	12.45	73.9	13.17	78.6	14.43	80.4	14.74	85.8	14.98		
	25	54.0	8.60	64.3	10.98	71.9	13.16	73.9	13.92	78.6	15.24	80.4	15.46	84.8	15.78		
	27	54.0	9.19	64.3	11.74	71.9	13.90	73.9	14.73	78.6	15.92	80.4	16.28	83.5	16.56		
	29	54.0	9.81	64.3	12.54	71.9	14.69	73.9	15.60	78.6	16.82	80.4	17.11	82.5	17.37		
	31	54.0	10.43	64.3	13.37	71.9	15.53	73.9	16.53	77.3	17.68	79.4	18.02	81.2	18.21		
	33	54.0	11.12	64.3	14.23	71.9	16.40	73.9	17.52	76.2	18.67	78.1	18.98	80.1	19.08		
	35	54.0	11.81	64.3	15.20	71.9	17.32	73.9	18.56	75.0	19.70	76.8	19.88	78.9	19.98		
	37	54.0	12.52	64.3	16.13	71.9	18.29	72.9	19.66	73.7	20.78	75.7	20.85	77.6	20.91		
	39	54.0	13.50	64.3	17.14	70.5	19.30	71.6	21.03	72.6	21.81	74.4	21.85	76.5	21.87		
	41	52.6	14.47	62.7	18.15	67.5	20.35	68.6	22.75	69.5	22.75	71.5	22.93	73.3	23.11		
	43	51.3	15.20	61.1	18.91	64.7	21.58	65.8	21.82	66.6	21.78	68.6	21.90	70.3	21.96		
46	48.0	14.83	57.3	18.25	59.0	20.48	60.1	20.48	60.9	20.66	62.7	20.77	64.3	20.83			
48	42.5	14.41	49.8	17.58	51.3	19.49	52.2	19.62	52.9	19.71	54.5	19.77	56.0	19.85			

Note

1. TC: Total Capacity(kW), PI: Power Input(kW, Comp. + Outdoor fan motor)
2. Capacity tables show the average value of conditions which may occur.

7. Capacity Tables

Combination (%)	Outdoor air temp (°C DB)	Cooling Capacity(24HP)													
		Indoor air temp. (DB/WB, °C)													
		20		23		26		27		28		30		32	
		14	PI	16	PI	18	PI	19	PI	20	PI	22	PI	24	PI
100	10	45.4	5.63	54.0	6.84	62.9	8.11	67.2	8.77	71.5	9.42	79.3	10.48	81.0	10.57
	12	45.4	5.81	54.0	7.12	62.9	8.39	67.2	9.00	71.5	9.72	79.3	11.05	81.0	11.16
	14	45.4	5.99	54.0	7.40	62.9	8.74	67.2	9.39	71.5	10.14	79.3	11.67	81.0	11.78
	16	45.4	6.17	54.0	7.65	62.9	9.11	67.2	9.84	71.5	10.68	79.3	12.23	81.0	12.40
	18	45.4	6.35	54.0	7.93	62.9	9.47	67.2	10.32	71.5	11.33	79.3	12.92	81.0	13.02
	20	45.4	6.58	54.0	8.23	62.9	10.02	67.2	11.05	71.5	12.12	79.3	13.54	81.0	13.65
	21	45.4	6.72	54.0	8.43	62.9	10.36	67.2	11.43	71.5	12.57	79.3	13.85	81.0	13.96
	23	45.4	7.11	54.0	9.01	62.9	11.12	67.2	12.26	71.5	13.47	79.3	14.50	81.0	14.62
	25	45.4	7.56	54.0	9.60	62.9	11.88	67.2	13.12	71.5	14.40	79.3	15.12	80.4	15.24
	27	45.4	8.08	54.0	10.26	62.9	12.71	67.2	14.02	71.5	15.31	77.8	15.83	79.4	15.96
	29	45.4	8.60	54.0	10.95	62.9	13.57	67.2	14.99	71.5	16.21	76.3	16.47	78.2	16.60
	31	45.4	9.19	54.0	11.67	62.9	14.47	67.2	15.99	71.5	17.03	75.2	17.11	77.0	17.24
	33	45.4	9.74	54.0	12.43	62.9	15.44	67.2	17.06	71.5	17.67	74.0	17.74	75.8	17.89
	35	45.4	10.36	54.0	13.23	62.9	16.44	67.2	18.20	70.4	18.31	72.6	18.38	74.5	18.53
	37	45.4	11.10	54.0	14.19	62.9	17.41	67.2	19.07	69.3	19.16	71.3	19.24	73.0	19.42
	39	45.4	11.90	54.0	15.24	62.9	18.45	67.2	20.00	68.1	20.09	70.1	20.16	71.8	20.35
	41	44.6	12.70	53.1	16.29	61.9	19.49	64.5	20.93	65.9	21.01	67.4	21.09	69.6	21.28
	43	43.1	13.44	51.3	17.27	59.8	20.42	61.8	21.73	62.5	21.81	64.5	21.88	66.2	22.09
46	40.4	14.45	48.1	18.62	56.0	21.66	56.4	22.75	57.1	22.82	58.9	22.88	60.5	23.10	
48	35.7	12.48	42.5	16.11	48.3	18.52	49.1	19.30	49.6	19.37	51.2	19.41	52.6	19.56	
90	10	40.8	4.89	48.7	5.88	56.6	6.93	60.5	7.47	64.3	8.04	72.2	9.00	80.2	10.00
	12	40.8	4.95	48.7	5.97	56.6	7.05	60.5	7.62	64.3	8.22	72.2	9.17	80.2	10.18
	14	40.8	5.04	48.7	6.09	56.6	7.20	60.5	7.77	64.3	8.37	72.2	9.35	80.2	10.39
	16	40.8	5.13	48.7	6.21	56.6	7.35	60.5	7.92	64.3	8.52	72.2	9.53	80.2	10.57
	18	40.8	5.22	48.7	6.33	56.6	7.47	60.5	8.10	64.3	8.70	72.2	9.74	80.2	11.10
	20	40.8	5.31	48.7	6.45	56.6	7.62	60.5	8.25	64.3	9.03	72.2	10.42	80.2	11.63
	21	40.8	5.37	48.7	6.51	56.6	7.77	60.5	8.52	64.3	9.36	72.2	10.59	80.2	11.89
	23	40.8	5.49	48.7	6.78	56.6	8.31	60.5	9.15	64.3	10.02	72.2	11.23	79.1	12.45
	25	40.8	5.76	48.7	7.23	56.6	8.88	60.5	9.78	64.3	10.71	72.2	12.01	77.9	12.99
	27	40.8	6.15	48.7	7.71	56.6	9.48	60.5	10.44	64.3	11.46	72.2	12.77	76.8	13.60
	29	40.8	6.51	48.7	8.22	56.6	10.14	60.5	11.16	64.3	12.24	72.2	13.53	75.6	14.14
	31	40.8	6.93	48.7	8.76	56.6	10.80	60.5	11.88	64.3	13.05	72.2	14.20	74.5	14.69
	33	40.8	7.38	48.7	9.33	56.6	11.52	60.5	12.66	64.3	13.84	72.2	14.89	73.3	15.24
	35	40.8	7.83	48.7	9.90	56.6	12.24	60.5	13.50	64.3	14.67	71.0	15.74	72.2	16.10
	37	40.8	8.31	48.7	10.53	56.6	13.05	60.5	14.34	64.3	15.49	69.9	16.45	71.1	16.82
	39	40.8	8.80	48.7	11.20	56.6	13.81	60.5	15.26	64.3	16.29	68.7	17.35	69.9	17.56
	41	39.8	9.84	47.5	12.41	55.2	15.16	58.9	16.68	62.7	17.58	65.8	18.28	67.0	18.70
	43	38.8	10.62	46.3	13.41	53.8	16.56	57.5	17.97	61.1	18.85	63.1	19.58	64.3	19.81
46	36.3	11.96	43.4	15.28	50.4	18.86	53.9	20.37	55.5	20.95	57.6	21.49	58.7	21.52	
48	32.1	10.45	38.4	13.36	44.6	16.50	47.6	17.77	48.2	18.05	50.1	18.50	51.0	18.52	
80	10	36.2	4.08	43.2	4.90	50.2	5.75	53.8	6.20	57.4	6.65	64.3	7.59	71.3	8.24
	12	36.2	4.16	43.2	4.95	50.2	5.86	53.8	6.31	57.4	6.77	64.3	7.73	71.3	8.40
	14	36.2	4.22	43.2	5.07	50.2	5.95	53.8	6.43	57.4	6.88	64.3	7.87	71.3	8.56
	16	36.2	4.28	43.2	5.15	50.2	6.06	53.8	6.54	57.4	7.02	64.3	8.04	71.3	8.73
	18	36.2	4.36	43.2	5.24	50.2	6.17	53.8	6.65	57.4	7.16	64.3	8.18	71.3	8.92
	20	36.2	4.45	43.2	5.35	50.2	6.31	53.8	6.79	57.4	7.30	64.3	8.49	71.3	9.45
	21	36.2	4.47	43.2	5.41	50.2	6.37	53.8	6.88	57.4	7.47	64.3	8.76	71.3	9.70
	23	36.2	4.56	43.2	5.49	50.2	6.65	53.8	7.30	57.4	7.98	64.3	9.25	71.3	10.18
	25	36.2	4.73	43.2	5.86	50.2	7.13	53.8	7.81	57.4	8.55	64.3	9.90	71.3	10.88
	27	36.2	5.01	43.2	6.23	50.2	7.62	53.8	8.35	57.4	9.12	64.3	10.52	71.3	11.45
	29	36.2	5.32	43.2	6.65	50.2	8.10	53.8	8.89	57.4	9.74	64.3	11.27	71.3	12.26
	31	36.2	5.66	43.2	7.05	50.2	8.64	53.8	9.48	57.4	10.36	64.3	11.96	71.3	12.87
	33	36.2	6.00	43.2	7.53	50.2	9.20	53.8	10.11	57.4	11.04	64.3	12.60	71.3	13.49
	35	36.2	6.37	43.2	7.98	50.2	9.80	53.8	10.76	57.4	11.78	64.3	13.36	70.5	13.98
	37	36.2	6.74	43.2	8.49	50.2	10.39	53.8	11.44	57.4	12.51	64.3	14.10	69.4	14.62
	39	36.2	7.12	43.2	8.97	50.2	11.12	53.8	12.30	57.4	13.45	64.3	14.90	68.2	15.42
	41	35.3	7.88	42.1	9.94	48.9	12.20	52.4	13.48	55.9	14.78	62.7	16.58	65.4	17.09
	43	34.4	8.67	41.1	10.85	47.7	13.32	51.1	14.69	54.5	16.15	61.1	17.74	62.7	18.30
46	32.3	9.65	38.5	12.22	44.7	15.00	47.9	16.35	51.1	18.22	55.9	19.37	57.2	19.68	
48	28.6	8.43	34.0	10.69	39.5	13.12	42.4	14.28	45.2	15.95	48.5	16.76	49.7	16.94	

Note

1. TC: Total Capacity(kW), PI: Power Input(kW, Comp. + Outdoor fan motor)
2. Capacity tables show the average value of conditions which may occur.

7. Capacity Tables

Combination (%)	Outdoor air temp (°C DB)	Cooling Capacity(24HP)													
		Indoor air temp. (DB/WB, °C)													
		20		23		26		27		28		30		32	
		14	16	18	19	20	22	24							
70	10	31.7	3.56	37.9	4.24	43.9	4.91	47.0	5.30	50.2	5.67	56.2	6.45	62.4	7.22
	12	31.7	3.62	37.9	4.29	43.9	5.02	47.0	5.39	50.2	5.78	56.2	6.57	62.4	7.35
	14	31.7	3.68	37.9	4.35	43.9	5.11	47.0	5.47	50.2	5.86	56.2	6.71	62.4	7.49
	16	31.7	3.73	37.9	4.43	43.9	5.19	47.0	5.58	50.2	5.98	56.2	6.82	62.4	7.65
	18	31.7	3.79	37.9	4.52	43.9	5.30	47.0	5.70	50.2	6.09	56.2	6.93	62.4	7.79
	20	31.7	3.84	37.9	4.60	43.9	5.39	47.0	5.81	50.2	6.23	56.2	7.10	62.4	8.08
	21	31.7	3.90	37.9	4.63	43.9	5.44	47.0	5.86	50.2	6.29	56.2	7.21	62.4	8.25
	23	31.7	3.96	37.9	4.74	43.9	5.56	47.0	6.06	50.2	6.59	56.2	7.72	62.4	8.71
	25	31.7	4.01	37.9	4.91	43.9	5.92	47.0	6.48	50.2	7.04	56.2	8.25	62.4	9.14
	27	31.7	4.24	37.9	5.25	43.9	6.31	47.0	6.88	50.2	7.52	56.2	8.81	62.4	9.71
	29	31.7	4.52	37.9	5.56	43.9	6.71	47.0	7.32	50.2	8.00	56.2	9.40	62.4	10.40
	31	31.7	4.80	37.9	5.92	43.9	7.16	47.0	7.83	50.2	8.53	56.2	10.02	62.4	11.04
	33	31.7	5.08	37.9	6.26	43.9	7.60	47.0	8.31	50.2	9.06	56.2	10.66	62.4	11.75
	35	31.7	5.36	37.9	6.68	43.9	8.08	47.0	8.84	50.2	9.65	56.2	11.37	62.4	12.46
	37	31.7	5.70	37.9	7.07	43.9	8.59	47.0	9.40	50.2	10.27	56.2	12.09	62.4	13.15
	39	31.7	6.05	37.9	7.54	43.9	9.18	47.0	10.11	50.2	11.09	56.2	12.94	62.4	14.18
	41	30.9	6.69	36.9	8.26	42.8	10.07	45.8	11.09	48.9	12.06	54.7	14.22	60.8	15.30
	43	30.1	7.28	36.0	9.01	41.7	10.99	44.7	12.10	47.7	13.17	53.4	15.53	59.3	16.54
	46	28.2	8.09	33.8	10.13	39.1	12.38	41.9	13.47	44.7	14.85	50.0	17.52	55.6	18.43
	48	25.0	7.06	29.9	8.85	34.6	10.82	37.1	11.78	39.5	12.99	44.2	15.33	49.2	15.95
60	10	27.1	3.06	32.4	3.59	37.7	4.17	40.3	4.48	43.0	4.76	48.2	5.40	53.5	6.04
	12	27.1	3.11	32.4	3.64	37.7	4.23	40.3	4.53	43.0	4.84	48.2	5.48	53.5	6.15
	14	27.1	3.14	32.4	3.70	37.7	4.31	40.3	4.62	43.0	4.92	48.2	5.59	53.5	6.26
	16	27.1	3.20	32.4	3.78	37.7	4.37	40.3	4.70	43.0	5.03	48.2	5.70	53.5	6.37
	18	27.1	3.25	32.4	3.84	37.7	4.45	40.3	4.78	43.0	5.12	48.2	5.78	53.5	6.51
	20	27.1	3.31	32.4	3.89	37.7	4.53	40.3	4.87	43.0	5.20	48.2	5.90	53.5	6.65
	21	27.1	3.34	32.4	3.92	37.7	4.59	40.3	4.92	43.0	5.26	48.2	5.98	53.5	6.70
	23	27.1	3.39	32.4	4.00	37.7	4.64	40.3	5.01	43.0	5.37	48.2	6.20	53.5	7.12
	25	27.1	3.45	32.4	4.09	37.7	4.84	40.3	5.26	43.0	5.70	48.2	6.62	53.5	7.62
	27	27.1	3.56	32.4	4.31	37.7	5.15	40.3	5.59	43.0	6.06	48.2	7.04	53.5	8.12
	29	27.1	3.78	32.4	4.59	37.7	5.48	40.3	5.95	43.0	6.45	48.2	7.51	53.5	8.68
	31	27.1	4.00	32.4	4.87	37.7	5.81	40.3	6.34	43.0	6.87	48.2	8.01	53.5	9.23
	33	27.1	4.23	32.4	5.15	37.7	6.17	40.3	6.73	43.0	7.31	48.2	8.51	53.5	9.85
	35	27.1	4.48	32.4	5.48	37.7	6.56	40.3	7.15	43.0	7.76	48.2	9.07	53.5	10.46
	37	27.1	4.73	32.4	5.78	37.7	6.95	40.3	7.59	43.0	8.23	48.2	9.62	53.5	11.12
	39	27.1	5.03	32.4	6.16	37.7	7.50	40.3	8.15	43.0	8.86	48.2	10.32	53.5	11.92
	41	26.4	5.45	31.6	6.74	36.7	8.15	39.3	8.90	41.9	9.62	47.0	11.32	52.2	12.95
	43	25.8	5.93	30.8	7.33	35.8	8.88	38.3	9.70	40.8	10.49	45.8	12.36	50.9	14.15
	46	24.2	6.64	28.9	8.24	33.6	9.99	35.9	10.90	38.3	11.80	43.0	13.93	47.7	16.12
	48	21.4	5.78	25.5	7.19	29.7	8.73	31.8	9.52	33.8	10.31	38.0	12.18	42.2	14.10
50	10	22.7	2.62	27.1	3.03	31.4	3.45	33.6	3.69	35.8	3.91	40.1	4.41	44.6	4.91
	12	22.7	2.65	27.1	3.06	31.4	3.50	33.6	3.75	35.8	4.00	40.1	4.49	44.6	4.99
	14	22.7	2.67	27.1	3.11	31.4	3.56	33.6	3.80	35.8	4.05	40.1	4.55	44.6	5.07
	16	22.7	2.73	27.1	3.17	31.4	3.61	33.6	3.89	35.8	4.11	40.1	4.63	44.6	5.15
	18	22.7	2.76	27.1	3.20	31.4	3.67	33.6	3.94	35.8	4.19	40.1	4.71	44.6	5.26
	20	22.7	2.78	27.1	3.25	31.4	3.75	33.6	4.00	35.8	4.27	40.1	4.80	44.6	5.37
	21	22.7	2.81	27.1	3.28	31.4	3.78	33.6	4.05	35.8	4.30	40.1	4.85	44.6	5.43
	23	22.7	2.87	27.1	3.33	31.4	3.83	33.6	4.11	35.8	4.38	40.1	4.93	44.6	5.54
	25	22.7	2.89	27.1	3.39	31.4	3.91	33.6	4.19	35.8	4.52	40.1	5.18	44.6	5.93
	27	22.7	2.95	27.1	3.50	31.4	4.13	33.6	4.46	35.8	4.80	40.1	5.54	44.6	6.31
	29	22.7	3.11	27.1	3.72	31.4	4.38	33.6	4.74	35.8	5.10	40.1	5.87	44.6	6.70
	31	22.7	3.28	27.1	3.94	31.4	4.66	33.6	5.02	35.8	5.43	40.1	6.26	44.6	7.14
	33	22.7	3.47	27.1	4.16	31.4	4.93	33.6	5.32	35.8	5.76	40.1	6.64	44.6	7.61
	35	22.7	3.67	27.1	4.41	31.4	5.21	33.6	5.65	35.8	6.09	40.1	7.03	44.6	8.08
	37	22.7	3.89	27.1	4.66	31.4	5.51	33.6	5.98	35.8	6.45	40.1	7.50	44.6	8.57
	39	22.7	4.15	27.1	4.99	31.4	5.91	33.6	6.44	35.8	6.92	40.1	7.98	44.6	9.26
	41	22.1	4.48	26.4	5.40	30.6	6.46	32.7	6.97	34.8	7.50	39.1	8.75	43.5	10.05
	43	21.6	4.87	25.8	5.88	29.9	7.03	31.9	7.59	34.0	8.16	38.1	9.54	42.4	10.97
	46	20.2	5.46	24.2	6.59	28.0	7.88	29.9	8.53	31.8	9.16	35.7	10.74	39.8	12.35
	48	17.9	4.75	21.4	5.75	24.8	6.88	26.5	7.44	28.2	8.00	31.6	9.38	35.2	10.79

Note

1. TC: Total Capacity(kW), PI : Power Input(kW, Comp. + Outdoor fan motor)
2. Capacity tables show the average value of conditions which may occur.

7. Capacity Tables

◆ A(C)RUN260LLS5

Combination (%)	Outdoor air temp (°C DB)	Indoor air temp. (DB/WB, °C)														Cooling Capacity(26HP)	
		20		23		26		27		28		30		32		TC	PI
		14		16		18		19		20		22		24			
		TC	PI	TC	PI	TC	PI	TC	PI	TC	PI	TC	PI	TC	PI		
130	10	72.1	8.82	85.9	10.78	92.0	12.51	94.7	12.76	97.3	12.87	102.0	12.97	104.6	13.02		
	12	72.1	9.04	85.9	11.17	92.0	13.02	94.7	13.11	97.3	13.21	102.0	13.32	104.6	13.44		
	14	72.1	9.35	85.9	11.57	92.0	13.51	94.7	13.61	97.3	13.72	102.0	13.83	104.6	13.95		
	16	72.1	9.69	85.9	11.98	92.0	14.12	94.7	14.25	97.3	14.36	102.0	14.49	104.6	14.61		
	18	72.1	10.09	85.9	12.67	92.0	14.77	94.7	15.09	97.3	15.21	102.0	15.36	104.6	15.46		
	20	72.1	10.54	85.9	13.50	92.0	15.50	94.7	16.59	97.3	16.73	100.5	16.89	103.2	17.01		
	21	72.1	10.81	85.9	13.97	92.0	15.82	94.7	17.56	97.3	17.70	100.0	17.88	102.6	18.00		
	23	72.1	11.60	85.9	14.70	92.0	16.64	94.7	19.38	96.1	19.53	98.5	19.73	101.1	19.86		
	25	72.1	12.39	85.9	15.54	92.0	17.78	93.5	21.49	94.7	21.66	97.3	21.88	100.0	22.03		
	27	72.1	13.26	85.9	16.62	90.9	18.95	92.0	23.66	93.5	23.85	96.1	24.08	98.5	24.25		
	29	72.1	14.13	85.9	17.76	89.4	20.39	90.7	26.00	92.0	26.16	94.7	26.39	97.3	26.49		
	31	72.1	15.08	85.6	18.71	87.9	21.69	89.4	25.89	90.7	26.05	93.2	26.28	95.8	26.38		
	33	72.1	16.06	84.1	19.83	86.8	23.26	88.2	25.65	89.4	25.81	92.0	26.04	94.4	26.14		
	35	72.1	17.13	82.6	20.76	85.3	25.19	86.8	25.32	88.2	25.47	90.6	25.70	93.2	25.80		
	37	72.1	18.27	81.5	21.79	84.1	24.86	85.3	24.99	86.8	25.14	89.1	25.36	91.8	25.46		
	39	72.1	19.45	80.0	22.93	82.6	24.53	84.1	24.65	85.3	24.80	87.9	25.02	90.6	25.12		
	41	70.3	20.63	76.7	24.08	79.3	24.20	80.5	24.32	82.1	24.46	84.5	24.68	86.8	24.78		
	43	68.5	21.76	73.5	23.74	76.1	23.86	77.2	23.98	78.8	24.13	81.2	24.34	83.4	24.44		
46	64.2	23.29	67.1	23.25	69.5	23.36	70.6	23.48	72.0	23.62	74.3	23.83	76.4	23.93			
48	56.8	22.64	58.2	22.71	60.4	22.76	61.4	22.82	62.7	23.02	64.7	23.17	66.5	23.26			
120	10	65.2	7.94	77.6	9.73	84.8	11.57	87.4	12.50	89.9	12.70	94.8	12.75	97.1	12.85		
	12	65.2	8.15	77.6	10.06	84.8	12.03	87.4	12.76	89.9	13.17	94.8	13.33	97.1	13.43		
	14	65.2	8.43	77.6	10.40	84.8	12.52	87.4	13.25	89.9	13.65	94.8	13.85	97.1	13.96		
	16	65.2	8.74	77.6	10.83	84.8	13.00	87.4	13.74	89.9	14.28	94.8	14.46	97.1	14.57		
	18	65.2	9.08	77.6	11.32	84.8	13.52	87.4	14.47	89.9	15.01	94.8	15.18	97.1	15.31		
	20	65.2	9.42	77.6	12.00	84.8	14.25	87.4	15.22	89.9	15.81	94.8	16.02	97.1	16.14		
	21	65.2	9.71	77.6	12.43	84.8	14.65	87.4	15.67	89.9	16.33	94.8	16.54	97.1	16.67		
	23	65.2	10.38	77.6	13.30	84.8	15.69	87.4	16.65	89.9	17.41	94.8	17.58	97.1	17.72		
	25	65.2	11.09	77.6	14.25	84.8	16.55	87.4	17.75	89.9	18.67	93.7	18.82	96.0	18.97		
	27	65.2	11.84	77.6	15.23	84.8	17.62	87.4	18.97	89.9	20.06	92.3	20.20	94.6	20.36		
	29	65.2	12.63	77.6	16.26	84.8	18.54	87.4	20.30	88.5	21.38	90.8	21.70	93.4	21.88		
	31	65.2	13.46	77.6	17.37	84.8	19.50	86.2	21.74	87.4	22.94	89.7	23.34	91.9	23.53		
	33	65.2	14.33	77.6	18.51	83.6	20.62	84.8	23.60	85.9	24.63	88.2	24.91	90.5	25.11		
	35	65.2	15.23	77.6	19.73	82.2	21.83	83.3	26.00	84.8	26.13	87.1	26.21	89.4	26.42		
	37	65.2	16.39	77.6	20.82	81.0	23.27	82.2	25.45	83.3	25.58	85.6	25.66	88.0	25.86		
	39	65.2	17.64	77.3	22.01	79.6	24.68	80.8	24.93	81.9	25.06	84.5	25.13	86.8	25.33		
	41	63.6	18.90	73.9	23.19	76.4	24.20	77.5	24.41	78.6	24.53	80.9	24.60	83.2	24.80		
	43	62.0	20.17	70.8	22.86	73.3	23.66	74.3	23.88	75.4	24.00	77.7	24.08	79.9	24.27		
46	58.1	21.69	64.6	22.32	66.9	22.91	67.9	23.10	69.0	23.22	71.0	23.29	73.1	23.47			
48	51.4	21.24	56.1	21.92	58.2	22.47	59.1	22.60	60.0	22.67	61.8	22.76	63.7	22.86			
110	10	58.4	7.14	69.7	8.70	77.8	10.34	80.1	11.19	85.1	12.04	87.1	12.38	93.0	12.58		
	12	58.4	7.36	69.7	9.00	77.8	10.77	80.1	11.50	85.1	12.49	87.1	12.90	93.0	13.19		
	14	58.4	7.59	69.7	9.40	77.8	11.25	80.1	12.07	85.1	13.12	87.1	13.50	93.0	13.78		
	16	58.4	7.86	69.7	9.74	77.8	11.72	80.1	12.60	85.1	13.73	87.1	14.10	93.0	14.35		
	18	58.4	8.15	69.7	10.15	77.8	12.39	80.1	13.27	85.1	14.48	87.1	14.77	93.0	15.04		
	20	58.4	8.44	69.7	10.66	77.8	13.14	80.1	13.88	85.1	15.18	87.1	15.56	93.0	15.81		
	21	58.4	8.63	69.7	10.97	77.8	13.48	80.1	14.25	85.1	15.61	87.1	16.00	93.0	16.25		
	23	58.4	9.20	69.7	11.76	77.8	14.23	80.1	15.05	85.1	16.49	87.1	16.84	93.0	17.12		
	25	58.4	9.83	69.7	12.55	77.8	15.04	80.1	15.91	85.1	17.42	87.1	17.67	91.9	18.03		
	27	58.4	10.50	69.7	13.42	77.8	15.89	80.1	16.84	85.1	18.19	87.1	18.61	90.5	18.93		
	29	58.4	11.21	69.7	14.33	77.8	16.79	80.1	17.83	85.1	19.23	87.1	19.56	89.4	19.85		
	31	58.4	11.92	69.7	15.27	77.8	17.74	80.1	18.89	83.7	20.20	86.0	20.60	88.0	20.81		
	33	58.4	12.71	69.7	16.26	77.8	18.75	80.1	20.02	82.6	21.33	84.6	21.69	86.8	21.81		
	35	58.4	13.50	69.7	17.37	77.8	19.80	80.1	21.21	81.2	22.52	83.2	22.72	85.4	22.84		
	37	58.4	14.31	69.7	18.43	77.8	20.90	79.0	22.47	79.8	23.75	82.1	23.83	84.0	23.90		
	39	58.4	15.42	69.7	19.59	76.4	22.05	77.5	24.04	78.7	24.92	80.6	24.97	82.9	24.99		
	41	57.0	16.54	67.9	20.74	73.2	23.26	74.3	26.00	75.3	26.00	77.5	26.21	79.4	26.42		
	43	55.5	17.37	66.2	21.61	70.1	24.66	71.3	24.94	72.2	24.89	74.3	25.03	76.2	25.10		
46	52.1	16.95	62.1	20.86	64.0	23.41	65.1	23.41	65.9	23.61	67.9	23.74	69.7	23.80			
48	46.0	16.46	53.9	20.10	55.6	22.27	56.6	22.42	57.3	22.53	59.1	22.59	60.6	22.68			

Note

1. TC: Total Capacity(kW), PI: Power Input(kW, Comp. + Outdoor fan motor)
2. Capacity tables show the average value of conditions which may occur.

7. Capacity Tables

Combination (%)	Outdoor air temp (°C DB)	Cooling Capacity(26HP)													
		Indoor air temp. (DB/WB, °C)													
		20		23		26		27		28		30		32	
		14	16	18	19	20	22	24							
	TC	PI	TC	PI	TC	PI	TC	PI	TC	PI	TC	PI	TC	PI	
100	10	49.1	6.43	58.5	7.81	68.1	9.27	72.8	10.02	77.5	10.76	85.9	11.98	87.8	12.08
	12	49.1	6.64	58.5	8.13	68.1	9.58	72.8	10.29	77.5	11.11	85.9	12.63	87.8	12.75
	14	49.1	6.84	58.5	8.46	68.1	9.99	72.8	10.73	77.5	11.59	85.9	13.33	87.8	13.46
	16	49.1	7.05	58.5	8.74	68.1	10.41	72.8	11.24	77.5	12.21	85.9	13.98	87.8	14.17
	18	49.1	7.26	58.5	9.06	68.1	10.82	72.8	11.79	77.5	12.95	85.9	14.77	87.8	14.88
	20	49.1	7.52	58.5	9.41	68.1	11.45	72.8	12.63	77.5	13.85	85.9	15.47	87.8	15.60
	21	49.1	7.68	58.5	9.63	68.1	11.84	72.8	13.06	77.5	14.37	85.9	15.83	87.8	15.95
	23	49.1	8.13	58.5	10.30	68.1	12.71	72.8	14.01	77.5	15.39	85.9	16.57	87.8	16.71
	25	49.1	8.64	58.5	10.97	68.1	13.58	72.8	15.00	77.5	16.46	85.9	17.28	87.0	17.42
	27	49.1	9.24	58.5	11.72	68.1	14.52	72.8	16.02	77.5	17.50	84.2	18.09	86.0	18.24
	29	49.1	9.83	58.5	12.51	68.1	15.51	72.8	17.13	77.5	18.52	82.7	18.82	84.7	18.97
	31	49.1	10.50	58.5	13.34	68.1	16.54	72.8	18.27	77.5	19.46	81.4	19.55	83.4	19.71
	33	49.1	11.13	58.5	14.21	68.1	17.64	72.8	19.50	77.5	20.19	80.1	20.28	82.1	20.44
	35	49.1	11.84	58.5	15.12	68.1	18.79	72.8	20.80	76.3	20.92	78.7	21.01	80.7	21.17
	37	49.1	12.68	58.5	16.21	68.1	19.90	72.8	21.79	75.0	21.90	77.2	21.99	79.0	22.19
	39	49.1	13.60	58.5	17.42	68.1	21.09	72.8	22.86	73.8	22.96	76.0	23.04	77.7	23.26
	41	48.4	14.51	57.6	18.62	67.0	22.28	69.9	23.92	71.4	24.02	73.1	24.10	75.4	24.33
	43	46.7	15.36	55.6	19.74	64.7	23.34	67.0	24.84	67.7	24.92	69.8	25.01	71.7	25.24
46	43.8	16.52	52.1	21.28	60.7	24.76	61.2	26.00	61.8	26.08	63.8	26.15	65.5	26.40	
48	38.7	14.26	46.1	18.41	52.4	21.16	53.1	22.06	53.7	22.13	55.5	22.18	57.0	22.36	
90	10	44.2	5.58	52.8	6.70	61.4	7.90	65.5	8.52	69.7	9.17	78.3	10.26	86.8	11.41
	12	44.2	5.64	52.8	6.81	61.4	8.04	65.5	8.69	69.7	9.37	78.3	10.46	86.8	11.61
	14	44.2	5.75	52.8	6.94	61.4	8.21	65.5	8.86	69.7	9.54	78.3	10.67	86.8	11.85
	16	44.2	5.85	52.8	7.08	61.4	8.38	65.5	9.03	69.7	9.72	78.3	10.87	86.8	12.05
	18	44.2	5.95	52.8	7.22	61.4	8.52	65.5	9.24	69.7	9.92	78.3	11.11	86.8	12.66
	20	44.2	6.05	52.8	7.35	61.4	8.69	65.5	9.41	69.7	10.30	78.3	11.89	86.8	13.26
	21	44.2	6.12	52.8	7.42	61.4	8.86	65.5	9.72	69.7	10.67	78.3	12.08	86.8	13.57
	23	44.2	6.26	52.8	7.73	61.4	9.48	65.5	10.43	69.7	11.43	78.3	12.81	85.6	14.21
	25	44.2	6.57	52.8	8.24	61.4	10.13	65.5	11.15	69.7	12.21	78.3	13.70	84.4	14.81
	27	44.2	7.01	52.8	8.79	61.4	10.81	65.5	11.90	69.7	13.07	78.3	14.56	83.2	15.51
	29	44.2	7.42	52.8	9.37	61.4	11.56	65.5	12.73	69.7	13.96	78.3	15.43	81.9	16.13
	31	44.2	7.90	52.8	9.99	61.4	12.32	65.5	13.55	69.7	14.88	78.3	16.20	80.7	16.76
	33	44.2	8.42	52.8	10.64	61.4	13.14	65.5	14.44	69.7	15.78	78.3	16.98	79.5	17.38
	35	44.2	8.93	52.8	11.29	61.4	13.96	65.5	15.39	69.7	16.74	76.9	17.95	78.2	18.37
	37	44.2	9.48	52.8	12.01	61.4	14.88	65.5	16.35	69.7	17.67	75.7	18.77	77.0	19.19
	39	44.2	10.03	52.8	12.77	61.4	15.75	65.5	17.40	69.7	18.58	74.4	19.79	75.7	20.03
	41	43.1	11.23	51.4	14.16	59.8	17.29	63.8	19.03	67.9	20.06	71.3	20.85	72.6	21.33
	43	42.0	12.12	50.2	15.30	58.3	18.88	62.3	20.50	66.2	21.51	68.4	22.33	69.6	22.60
46	39.4	13.64	47.0	17.42	54.6	21.52	58.4	23.24	60.2	23.89	62.4	24.51	63.6	24.55	
48	34.8	11.92	41.6	15.24	48.3	18.82	51.6	20.27	52.2	20.59	54.3	21.10	55.3	21.13	
80	10	39.3	4.65	46.8	5.59	54.3	6.56	58.2	7.08	62.1	7.59	69.7	8.66	77.2	9.40
	12	39.3	4.75	46.8	5.65	54.3	6.69	58.2	7.20	62.1	7.72	69.7	8.82	77.2	9.59
	14	39.3	4.81	46.8	5.78	54.3	6.78	58.2	7.33	62.1	7.85	69.7	8.98	77.2	9.77
	16	39.3	4.88	46.8	5.88	54.3	6.91	58.2	7.46	62.1	8.01	69.7	9.18	77.2	9.96
	18	39.3	4.98	46.8	5.98	54.3	7.04	58.2	7.59	62.1	8.17	69.7	9.34	77.2	10.18
	20	39.3	5.07	46.8	6.11	54.3	7.20	58.2	7.75	62.1	8.34	69.7	9.69	77.2	10.78
	21	39.3	5.10	46.8	6.17	54.3	7.27	58.2	7.85	62.1	8.53	69.7	10.00	77.2	11.07
	23	39.3	5.20	46.8	6.27	54.3	7.59	58.2	8.34	62.1	9.11	69.7	10.56	77.2	11.62
	25	39.3	5.40	46.8	6.69	54.3	8.14	58.2	8.92	62.1	9.76	69.7	11.30	77.2	12.42
	27	39.3	5.72	46.8	7.11	54.3	8.69	58.2	9.53	62.1	10.40	69.7	12.00	77.2	13.07
	29	39.3	6.07	46.8	7.59	54.3	9.24	58.2	10.15	62.1	11.11	69.7	12.86	77.2	13.99
	31	39.3	6.46	46.8	8.04	54.3	9.85	58.2	10.82	62.1	11.83	69.7	13.65	77.2	14.69
	33	39.3	6.85	46.8	8.59	54.3	10.50	58.2	11.53	62.1	12.60	69.7	14.38	77.2	15.40
	35	39.3	7.27	46.8	9.11	54.3	11.18	58.2	12.28	62.1	13.44	69.7	15.25	76.4	15.96
	37	39.3	7.69	46.8	9.69	54.3	11.86	58.2	13.05	62.1	14.28	69.7	16.09	75.2	16.68
	39	39.3	8.13	46.8	10.24	54.3	12.68	58.2	14.03	62.1	15.35	69.7	17.00	73.9	17.60
	41	38.3	8.99	45.6	11.35	52.9	13.92	56.7	15.38	60.5	16.86	67.9	18.92	70.8	19.50
	43	37.3	9.90	44.5	12.38	51.6	15.20	55.3	16.76	59.1	18.43	66.2	20.25	67.9	20.88
46	35.0	11.01	41.7	13.95	48.4	17.12	51.9	18.66	55.3	20.79	60.6	22.10	62.0	22.46	
48	30.9	9.62	36.9	12.20	42.8	14.97	45.9	16.30	49.0	18.20	52.6	19.13	53.9	19.33	

Note

1. TC: Total Capacity(kW), PI : Power Input(kW, Comp. + Outdoor fan motor)
2. Capacity tables show the average value of conditions which may occur.

7. Capacity Tables

		Cooling Capacity(26HP)													
Combination (%)	Outdoor air temp (°C DB)	Indoor air temp. (DB/WB, °C)													
		20		23		26		27		28		30		32	
		14	16	18	19	20	22	24	TC	PI	TC	PI	TC	PI	
70	10	34.3	4.07	41.1	4.84	47.6	5.61	51.0	6.06	54.3	6.47	60.8	7.37	67.6	8.24
	12	34.3	4.13	41.1	4.90	47.6	5.73	51.0	6.15	54.3	6.60	60.8	7.50	67.6	8.40
	14	34.3	4.20	41.1	4.97	47.6	5.83	51.0	6.25	54.3	6.70	60.8	7.66	67.6	8.55
	16	34.3	4.26	41.1	5.06	47.6	5.93	51.0	6.38	54.3	6.82	60.8	7.79	67.6	8.73
	18	34.3	4.33	41.1	5.16	47.6	6.06	51.0	6.50	54.3	6.95	60.8	7.91	67.6	8.89
	20	34.3	4.39	41.1	5.25	47.6	6.15	51.0	6.63	54.3	7.11	60.8	8.11	67.6	9.23
	21	34.3	4.45	41.1	5.29	47.6	6.22	51.0	6.70	54.3	7.18	60.8	8.23	67.6	9.42
	23	34.3	4.52	41.1	5.41	47.6	6.34	51.0	6.92	54.3	7.53	60.8	8.81	67.6	9.95
	25	34.3	4.58	41.1	5.61	47.6	6.76	51.0	7.40	54.3	8.04	60.8	9.42	67.6	10.43
	27	34.3	4.84	41.1	5.99	47.6	7.21	51.0	7.85	54.3	8.59	60.8	10.06	67.6	11.09
	29	34.3	5.16	41.1	6.34	47.6	7.66	51.0	8.36	54.3	9.13	60.8	10.73	67.6	11.88
	31	34.3	5.48	41.1	6.76	47.6	8.17	51.0	8.94	54.3	9.74	60.8	11.44	67.6	12.60
	33	34.3	5.80	41.1	7.14	47.6	8.68	51.0	9.48	54.3	10.35	60.8	12.17	67.6	13.42
	35	34.3	6.12	41.1	7.63	47.6	9.23	51.0	10.09	54.3	11.02	60.8	12.98	67.6	14.23
	37	34.3	6.50	41.1	8.08	47.6	9.80	51.0	10.73	54.3	11.73	60.8	13.81	67.6	15.01
	39	34.3	6.91	41.1	8.61	47.6	10.48	51.0	11.55	54.3	12.67	60.8	14.78	67.6	16.19
	41	33.4	7.64	40.0	9.43	46.4	11.50	49.7	12.67	52.9	13.77	59.3	16.23	65.9	17.46
	43	32.6	8.31	39.0	10.28	45.2	12.55	48.4	13.81	51.6	15.04	57.8	17.73	64.2	18.88
	46	30.6	9.24	36.6	11.56	42.4	14.13	45.4	15.38	48.4	16.95	54.2	20.00	60.2	21.04
	48	27.0	8.06	32.4	10.10	37.5	12.35	40.1	13.44	42.8	14.83	47.9	17.50	53.3	18.21
60	10	29.4	3.49	35.1	4.10	40.8	4.77	43.7	5.11	46.5	5.43	52.3	6.16	58.0	6.89
	12	29.4	3.56	35.1	4.16	40.8	4.83	43.7	5.18	46.5	5.53	52.3	6.26	58.0	7.02
	14	29.4	3.59	35.1	4.23	40.8	4.92	43.7	5.27	46.5	5.62	52.3	6.39	58.0	7.15
	16	29.4	3.65	35.1	4.32	40.8	4.99	43.7	5.37	46.5	5.75	52.3	6.51	58.0	7.27
	18	29.4	3.72	35.1	4.38	40.8	5.08	43.7	5.46	46.5	5.85	52.3	6.61	58.0	7.43
	20	29.4	3.78	35.1	4.45	40.8	5.18	43.7	5.56	46.5	5.94	52.3	6.73	58.0	7.59
	21	29.4	3.81	35.1	4.48	40.8	5.24	43.7	5.62	46.5	6.00	52.3	6.83	58.0	7.66
	23	29.4	3.88	35.1	4.57	40.8	5.31	43.7	5.72	46.5	6.13	52.3	7.08	58.0	8.13
	25	29.4	3.94	35.1	4.67	40.8	5.53	43.7	6.00	46.5	6.51	52.3	7.56	58.0	8.70
	27	29.4	4.07	35.1	4.92	40.8	5.88	43.7	6.39	46.5	6.93	52.3	8.04	58.0	9.28
	29	29.4	4.32	35.1	5.24	40.8	6.26	43.7	6.80	46.5	7.37	52.3	8.58	58.0	9.91
	31	29.4	4.57	35.1	5.56	40.8	6.64	43.7	7.24	46.5	7.85	52.3	9.15	58.0	10.55
	33	29.4	4.83	35.1	5.88	40.8	7.05	43.7	7.69	46.5	8.35	52.3	9.72	58.0	11.25
	35	29.4	5.11	35.1	6.26	40.8	7.50	43.7	8.16	46.5	8.86	52.3	10.36	58.0	11.94
	37	29.4	5.40	35.1	6.60	40.8	7.94	43.7	8.67	46.5	9.40	52.3	10.99	58.0	12.71
	39	29.4	5.74	35.1	7.03	40.8	8.57	43.7	9.30	46.5	10.12	52.3	11.79	58.0	13.62
	41	28.6	6.23	34.2	7.70	39.8	9.31	42.6	10.16	45.3	10.98	50.9	12.93	56.5	14.80
	43	27.9	6.77	33.4	8.38	38.8	10.15	41.5	11.08	44.2	11.98	49.7	14.12	55.1	16.16
	46	26.2	7.58	31.3	9.41	36.4	11.41	38.9	12.45	41.4	13.48	46.5	15.91	51.6	18.41
	48	23.1	6.61	27.7	8.21	32.2	9.97	34.4	10.87	36.7	11.78	41.2	13.91	45.7	16.11
50	10	24.6	2.99	29.4	3.46	34.1	3.94	36.4	4.22	38.7	4.47	43.4	5.04	48.4	5.61
	12	24.6	3.02	29.4	3.50	34.1	4.00	36.4	4.28	38.7	4.57	43.4	5.13	48.4	5.70
	14	24.6	3.06	29.4	3.56	34.1	4.06	36.4	4.35	38.7	4.63	43.4	5.20	48.4	5.80
	16	24.6	3.12	29.4	3.62	34.1	4.13	36.4	4.44	38.7	4.69	43.4	5.29	48.4	5.89
	18	24.6	3.15	29.4	3.65	34.1	4.19	36.4	4.50	38.7	4.79	43.4	5.39	48.4	6.02
	20	24.6	3.18	29.4	3.72	34.1	4.28	36.4	4.57	38.7	4.88	43.4	5.48	48.4	6.14
	21	24.6	3.21	29.4	3.75	34.1	4.32	36.4	4.63	38.7	4.91	43.4	5.54	48.4	6.20
	23	24.6	3.28	29.4	3.81	34.1	4.38	36.4	4.69	38.7	5.01	43.4	5.64	48.4	6.33
	25	24.6	3.31	29.4	3.87	34.1	4.47	36.4	4.79	38.7	5.17	43.4	5.92	48.4	6.77
	27	24.6	3.37	29.4	4.00	34.1	4.72	36.4	5.10	38.7	5.48	43.4	6.33	48.4	7.21
	29	24.6	3.56	29.4	4.25	34.1	5.01	36.4	5.42	38.7	5.83	43.4	6.71	48.4	7.65
	31	24.6	3.75	29.4	4.50	34.1	5.32	36.4	5.73	38.7	6.20	43.4	7.15	48.4	8.16
	33	24.6	3.97	29.4	4.76	34.1	5.64	36.4	6.08	38.7	6.58	43.4	7.59	48.4	8.69
	35	24.6	4.19	29.4	5.04	34.1	5.95	36.4	6.46	38.7	6.96	43.4	8.03	48.4	9.23
	37	24.6	4.44	29.4	5.32	34.1	6.30	36.4	6.83	38.7	7.37	43.4	8.57	48.4	9.80
	39	24.6	4.74	29.4	5.71	34.1	6.75	36.4	7.36	38.7	7.91	43.4	9.13	48.4	10.58
	41	23.9	5.12	28.6	6.18	33.2	7.38	35.5	7.97	37.7	8.57	42.3	10.00	47.1	11.49
	43	23.3	5.57	27.9	6.72	32.4	8.03	34.6	8.68	36.8	9.33	41.3	10.91	46.0	12.53
	46	21.9	6.24	26.2	7.54	30.3	9.01	32.4	9.74	34.5	10.47	38.7	12.27	43.1	14.11
	48	19.4	5.43	23.1	6.57	26.8	7.86	28.7	8.50	30.5	9.14	34.2	10.72	38.1	12.33

Note

1. TC: Total Capacity(kW), PI : Power Input(kW, Comp. + Outdoor fan motor)
2. Capacity tables show the average value of conditions which may occur.

7. Capacity Tables

7.1.2 Two Unit

◆ A(C)RUN280LLS5

Combination (%)	Outdoor air temp (°C DB)	Cooling Capacity(28HP)													
		Indoor air temp. (DB/WB, °C)													
		20		23		26		27		28		30		32	
		14	16	18	19	20	22	24	24	24	24	24	24		
	TC	PI	TC	PI	TC	PI	TC	PI	TC	PI	TC	PI	TC	PI	
130	10	77.7	8.83	92.4	10.78	99.1	12.51	102.0	12.76	104.8	12.87	109.9	12.97	112.7	13.02
	12	77.7	9.04	92.4	11.17	99.1	13.02	102.0	13.11	104.8	13.21	109.9	13.32	112.7	13.44
	14	77.7	9.35	92.4	11.57	99.1	13.51	102.0	13.61	104.8	13.72	109.9	13.83	112.7	13.95
	16	77.7	9.68	92.4	11.97	99.1	14.12	102.0	14.25	104.8	14.37	109.9	14.49	112.7	14.61
	18	77.7	10.09	92.4	12.67	99.1	14.77	102.0	15.08	104.8	15.21	109.9	15.36	112.7	15.47
	20	77.7	10.54	92.4	13.50	99.1	15.50	102.0	16.59	104.8	16.73	108.3	16.89	111.1	17.01
	21	77.7	10.82	92.4	13.97	99.1	15.82	102.0	17.56	104.8	17.70	107.6	17.88	110.5	18.00
	23	77.7	11.61	92.4	14.70	99.1	16.64	102.0	19.38	103.4	19.53	106.1	19.73	108.9	19.86
	25	77.7	12.39	92.4	15.54	99.1	17.78	100.8	21.49	102.0	21.66	104.8	21.88	107.6	22.03
	27	77.7	13.26	92.4	16.62	97.8	18.95	99.1	23.65	100.8	23.84	103.4	24.08	106.1	24.25
	29	77.7	14.13	92.4	17.76	96.3	20.38	97.7	26.01	99.1	26.15	102.0	26.39	104.8	26.50
	31	77.7	15.08	92.2	18.71	94.7	21.69	96.3	25.89	97.7	26.05	100.4	26.28	103.2	26.38
	33	77.7	16.06	90.6	19.82	93.4	23.26	95.0	25.66	96.3	25.81	99.1	26.04	101.6	26.15
	35	77.7	17.13	89.0	20.76	91.9	25.19	93.4	25.32	95.0	25.47	97.5	25.70	100.4	25.80
	37	77.7	18.27	87.7	21.79	90.6	24.86	91.9	24.98	93.4	25.14	95.9	25.36	98.8	25.46
	39	77.7	19.45	86.1	22.93	89.0	24.53	90.6	24.65	91.9	24.80	94.7	25.03	97.5	25.12
	41	75.6	20.64	82.6	24.08	85.4	24.19	86.6	24.31	88.4	24.47	91.0	24.68	93.5	24.78
	43	73.8	21.76	79.1	23.74	81.9	23.86	83.1	23.98	84.9	24.12	87.5	24.35	89.8	24.44
46	69.1	23.30	72.2	23.25	74.9	23.37	76.0	23.48	77.6	23.62	80.0	23.84	82.2	23.93	
48	61.2	22.65	62.7	22.71	65.1	22.76	66.1	22.83	67.5	23.02	69.7	23.16	71.6	23.26	
120	10	70.3	7.94	83.5	9.73	91.3	11.57	94.1	12.50	96.9	12.69	102.2	12.74	104.6	12.85
	12	70.3	8.15	83.5	10.07	91.3	12.03	94.1	12.76	96.9	13.16	102.2	13.32	104.6	13.44
	14	70.3	8.43	83.5	10.40	91.3	12.52	94.1	13.25	96.9	13.65	102.2	13.85	104.6	13.96
	16	70.3	8.74	83.5	10.83	91.3	13.00	94.1	13.74	96.9	14.28	102.2	14.46	104.6	14.57
	18	70.3	9.07	83.5	11.31	91.3	13.53	94.1	14.47	96.9	15.01	102.2	15.19	104.6	15.31
	20	70.3	9.42	83.5	11.99	91.3	14.25	94.1	15.22	96.9	15.80	102.2	16.01	104.6	16.15
	21	70.3	9.70	83.5	12.43	91.3	14.65	94.1	15.68	96.9	16.33	102.2	16.54	104.6	16.67
	23	70.3	10.38	83.5	13.30	91.3	15.70	94.1	16.66	96.9	17.41	102.2	17.58	104.6	17.72
	25	70.3	11.10	83.5	14.25	91.3	16.55	94.1	17.76	96.9	18.67	100.9	18.82	103.4	18.98
	27	70.3	11.84	83.5	15.24	91.3	17.62	94.1	18.97	96.9	20.06	99.4	20.19	101.8	20.36
	29	70.3	12.63	83.5	16.26	91.3	18.54	94.1	20.29	95.3	21.38	97.8	21.71	100.6	21.88
	31	70.3	13.46	83.5	17.37	91.3	19.49	92.9	21.74	94.1	22.93	96.6	23.34	99.0	23.53
	33	70.3	14.33	83.5	18.51	90.1	20.62	91.3	23.60	92.6	24.63	95.0	24.91	97.5	25.10
	35	70.3	15.24	83.5	19.73	88.5	21.83	89.8	26.01	91.3	26.13	93.8	26.20	96.2	26.41
	37	70.3	16.39	83.5	20.82	87.3	23.27	88.5	25.45	89.8	25.59	92.2	25.66	94.7	25.87
	39	70.3	17.64	83.3	22.01	85.7	24.68	87.0	24.93	88.2	25.05	91.0	25.13	93.5	25.33
	41	68.4	18.90	79.6	23.19	82.3	24.19	83.5	24.40	84.7	24.53	87.1	24.61	89.6	24.80
	43	66.8	20.17	76.3	22.86	78.9	23.65	80.1	23.88	81.2	24.00	83.6	24.07	86.1	24.26
46	62.6	21.69	69.5	22.32	72.1	22.91	73.1	23.10	74.2	23.21	76.5	23.28	78.8	23.47	
48	55.3	21.24	60.4	21.92	62.6	22.46	63.6	22.60	64.6	22.67	66.5	22.76	68.6	22.86	
110	10	63.0	7.14	75.1	8.70	83.8	10.33	86.3	11.19	91.7	12.04	93.8	12.38	100.1	12.58
	12	63.0	7.36	75.1	9.00	83.8	10.77	86.3	11.50	91.7	12.50	93.8	12.90	100.1	13.20
	14	63.0	7.59	75.1	9.40	83.8	11.26	86.3	12.08	91.7	13.13	93.8	13.49	100.1	13.78
	16	63.0	7.86	75.1	9.74	83.8	11.71	86.3	12.60	91.7	13.72	93.8	14.10	100.1	14.35
	18	63.0	8.15	75.1	10.15	83.8	12.39	86.3	13.27	91.7	14.48	93.8	14.77	100.1	15.05
	20	63.0	8.44	75.1	10.66	83.8	13.14	86.3	13.88	91.7	15.19	93.8	15.56	100.1	15.80
	21	63.0	8.63	75.1	10.97	83.8	13.48	86.3	14.25	91.7	15.61	93.8	16.00	100.1	16.25
	23	63.0	9.19	75.1	11.76	83.8	14.23	86.3	15.05	91.7	16.49	93.8	16.85	100.1	17.12
	25	63.0	9.83	75.1	12.55	83.8	15.03	86.3	15.91	91.7	17.42	93.8	17.67	98.9	18.04
	27	63.0	10.50	75.1	13.42	83.8	15.89	86.3	16.83	91.7	18.19	93.8	18.61	97.5	18.93
	29	63.0	11.21	75.1	14.33	83.8	16.79	86.3	17.83	91.7	19.23	93.8	19.56	96.2	19.86
	31	63.0	11.92	75.1	15.28	83.8	17.74	86.3	18.89	90.2	20.20	92.6	20.59	94.7	20.82
	33	63.0	12.71	75.1	16.26	83.8	18.75	86.3	20.02	88.9	21.34	91.1	21.69	93.5	21.81
	35	63.0	13.50	75.1	17.37	83.8	19.80	86.3	21.22	87.5	22.51	89.6	22.72	92.0	22.84
	37	63.0	14.30	75.1	18.43	83.8	20.90	85.0	22.48	85.9	23.75	88.4	23.83	90.5	23.90
	39	63.0	15.42	75.1	19.59	82.3	22.06	83.5	24.04	84.7	24.92	86.8	24.96	89.3	24.99
	41	61.3	16.54	73.1	20.74	78.8	23.26	80.0	26.01	81.0	26.01	83.5	26.20	85.5	26.41
	43	59.8	17.37	71.3	21.61	75.5	24.66	76.7	24.94	77.7	24.89	80.0	25.03	82.1	25.10
46	56.0	16.95	66.8	20.86	68.9	23.40	70.0	23.40	71.0	23.61	73.2	23.74	75.1	23.80	
48	49.6	16.46	58.1	20.10	59.8	22.27	60.9	22.42	61.8	22.53	63.7	22.59	65.3	22.68	

Note

1. TC: Total Capacity(kW), PI: Power Input(kW, Comp. + Outdoor fan motor)
2. Capacity tables show the average value of conditions which may occur.

7. Capacity Tables

Combination (%)	Outdoor air temp (°C DB)	Cooling Capacity(28HP)													
		Indoor air temp. (DB/WB, °C)													
		20		23		26		27		28		30		32	
		14	16	18	19	20	22	24							
100	10	52.9	6.43	63.0	7.81	73.3	9.27	78.4	10.02	83.5	10.77	92.5	11.98	94.5	12.08
	12	52.9	6.64	63.0	8.13	73.3	9.58	78.4	10.29	83.5	11.10	92.5	12.62	94.5	12.75
	14	52.9	6.85	63.0	8.46	73.3	9.98	78.4	10.73	83.5	11.59	92.5	13.33	94.5	13.46
	16	52.9	7.05	63.0	8.74	73.3	10.42	78.4	11.24	83.5	12.21	92.5	13.98	94.5	14.17
	18	52.9	7.26	63.0	9.07	73.3	10.82	78.4	11.79	83.5	12.95	92.5	14.77	94.5	14.89
	20	52.9	7.52	63.0	9.40	73.3	11.45	78.4	12.63	83.5	13.86	92.5	15.47	94.5	15.59
	21	52.9	7.67	63.0	9.63	73.3	11.84	78.4	13.06	83.5	14.37	92.5	15.82	94.5	15.96
	23	52.9	8.13	63.0	10.30	73.3	12.71	78.4	14.02	83.5	15.40	92.5	16.57	94.5	16.71
	25	52.9	8.65	63.0	10.97	73.3	13.58	78.4	15.00	83.5	16.46	92.5	17.28	93.8	17.41
	27	52.9	9.23	63.0	11.73	73.3	14.52	78.4	16.03	83.5	17.50	90.7	18.09	92.6	18.23
	29	52.9	9.83	63.0	12.51	73.3	15.51	78.4	17.13	83.5	18.52	89.1	18.82	91.2	18.97
	31	52.9	10.50	63.0	13.34	73.3	16.54	78.4	18.27	83.5	19.46	87.7	19.54	89.8	19.70
	33	52.9	11.13	63.0	14.21	73.3	17.64	78.4	19.49	83.5	20.19	86.3	20.28	88.4	20.44
	35	52.9	11.84	63.0	15.12	73.3	18.79	78.4	20.80	82.2	20.92	84.7	21.01	86.8	21.17
	37	52.9	12.68	63.0	16.22	73.3	19.91	78.4	21.79	80.8	21.90	83.1	21.99	85.1	22.18
	39	52.9	13.60	63.0	17.41	73.3	21.08	78.4	22.86	79.5	22.95	81.8	23.04	83.7	23.26
	41	52.1	14.51	62.0	18.62	72.2	22.27	75.2	23.93	76.8	24.02	78.7	24.10	81.2	24.33
	43	50.3	15.36	59.9	19.74	69.7	23.34	72.1	24.84	73.0	24.92	75.2	25.01	77.2	25.24
46	47.1	16.52	56.1	21.28	65.3	24.75	65.8	26.01	66.5	26.08	68.7	26.15	70.5	26.40	
48	41.7	14.26	49.7	18.41	56.4	21.17	57.2	22.06	57.8	22.13	59.7	22.18	61.4	22.36	
90	10	47.6	5.45	56.9	6.56	66.1	7.73	70.5	8.33	75.1	8.97	84.3	10.03	93.5	11.16
	12	47.6	5.52	56.9	6.65	66.1	7.87	70.5	8.49	75.1	9.16	84.3	10.24	93.5	11.36
	14	47.6	5.62	56.9	6.79	66.1	8.03	70.5	8.67	75.1	9.34	84.3	10.43	93.5	11.59
	16	47.6	5.72	56.9	6.93	66.1	8.19	70.5	8.83	75.1	9.50	84.3	10.63	93.5	11.78
	18	47.6	5.82	56.9	7.06	66.1	8.33	70.5	9.04	75.1	9.71	84.3	10.86	93.5	12.38
	20	47.6	5.92	56.9	7.20	66.1	8.49	70.5	9.20	75.1	10.07	84.3	11.62	93.5	12.97
	21	47.6	5.99	56.9	7.27	66.1	8.67	70.5	9.50	75.1	10.44	84.3	11.82	93.5	13.27
	23	47.6	6.12	56.9	7.57	66.1	9.27	70.5	10.20	75.1	11.18	84.3	12.53	92.2	13.90
	25	47.6	6.42	56.9	8.06	66.1	9.90	70.5	10.91	75.1	11.94	84.3	13.40	90.9	14.49
	27	47.6	6.86	56.9	8.60	66.1	10.57	70.5	11.64	75.1	12.78	84.3	14.24	89.6	15.17
	29	47.6	7.27	56.9	9.16	66.1	11.30	70.5	12.45	75.1	13.65	84.3	15.09	88.2	15.78
	31	47.6	7.73	56.9	9.77	66.1	12.04	70.5	13.25	75.1	14.56	84.3	15.84	86.9	16.39
	33	47.6	8.23	56.9	10.40	66.1	12.84	70.5	14.12	75.1	15.44	84.3	16.61	85.6	17.00
	35	47.6	8.74	56.9	11.04	66.1	13.65	70.5	15.05	75.1	16.37	82.8	17.56	84.2	17.97
	37	47.6	9.27	56.9	11.74	66.1	14.56	70.5	15.99	75.1	17.28	81.5	18.36	82.9	18.77
	39	47.6	9.81	56.9	12.49	66.1	15.41	70.5	17.02	75.1	18.17	80.2	19.35	81.6	19.58
	41	46.4	10.98	55.3	13.85	64.4	16.91	68.8	18.61	73.1	19.62	76.8	20.39	78.2	20.87
	43	45.2	11.85	54.0	14.96	62.8	18.47	67.0	20.04	71.3	21.03	73.7	21.84	75.0	22.11
46	42.4	13.34	50.6	17.05	58.8	21.05	62.8	22.73	64.8	23.37	67.2	23.98	68.5	24.00	
48	37.5	11.66	44.8	14.91	52.0	18.41	55.6	19.83	56.3	20.14	58.4	20.64	59.5	20.66	
80	10	42.3	4.63	50.4	5.58	58.5	6.54	62.7	7.05	66.9	7.57	75.1	8.64	83.1	9.37
	12	42.3	4.74	50.4	5.63	58.5	6.67	62.7	7.19	66.9	7.69	75.1	8.80	83.1	9.55
	14	42.3	4.80	50.4	5.76	58.5	6.76	62.7	7.31	66.9	7.83	75.1	8.96	83.1	9.74
	16	42.3	4.86	50.4	5.86	58.5	6.89	62.7	7.44	66.9	7.99	75.1	9.14	83.1	9.93
	18	42.3	4.96	50.4	5.96	58.5	7.03	62.7	7.57	66.9	8.15	75.1	9.30	83.1	10.14
	20	42.3	5.06	50.4	6.08	58.5	7.19	62.7	7.73	66.9	8.31	75.1	9.66	83.1	10.75
	21	42.3	5.09	50.4	6.15	58.5	7.24	62.7	7.83	66.9	8.50	75.1	9.96	83.1	11.03
	23	42.3	5.19	50.4	6.24	58.5	7.57	62.7	8.31	66.9	9.08	75.1	10.52	83.1	11.58
	25	42.3	5.38	50.4	6.67	58.5	8.12	62.7	8.89	66.9	9.73	75.1	11.26	83.1	12.38
	27	42.3	5.70	50.4	7.08	58.5	8.66	62.7	9.50	66.9	10.37	75.1	11.97	83.1	13.02
	29	42.3	6.06	50.4	7.57	58.5	9.21	62.7	10.12	66.9	11.08	75.1	12.82	83.1	13.95
	31	42.3	6.44	50.4	8.02	58.5	9.82	62.7	10.79	66.9	11.79	75.1	13.61	83.1	14.64
	33	42.3	6.83	50.4	8.57	58.5	10.46	62.7	11.50	66.9	12.56	75.1	14.34	83.1	15.35
	35	42.3	7.24	50.4	9.08	58.5	11.14	62.7	12.24	66.9	13.40	75.1	15.20	82.3	15.90
	37	42.3	7.67	50.4	9.66	58.5	11.82	62.7	13.02	66.9	14.24	75.1	16.04	81.0	16.63
	39	42.3	8.10	50.4	10.21	58.5	12.64	62.7	13.99	66.9	15.29	75.1	16.95	79.6	17.54
	41	41.2	8.96	49.1	11.32	57.0	13.88	61.1	15.33	65.2	16.81	73.1	18.87	76.3	19.44
	43	40.2	9.87	47.9	12.34	55.6	15.15	59.6	16.71	63.6	18.37	71.3	20.19	73.1	20.82
46	37.6	10.98	44.8	13.91	52.1	17.06	55.8	18.60	59.6	20.73	65.2	22.03	66.7	22.39	
48	33.3	9.59	39.7	12.16	46.1	14.93	49.4	16.24	52.7	18.15	56.7	19.07	58.0	19.28	

Note

1. TC: Total Capacity(kW), PI : Power Input(kW, Comp. + Outdoor fan motor)
2. Capacity tables show the average value of conditions which may occur.

7. Capacity Tables

Combination (%)	Outdoor air temp (°C DB)	Cooling Capacity(28HP)													
		Indoor air temp. (DB/WB, °C)													
		20		23		26		27		28		30		32	
		14	16	18	19	20	22	24	TC	PI	TC	PI	TC	PI	
70	10	36.9	4.14	44.3	4.92	51.3	5.70	54.9	6.15	58.5	6.58	65.5	7.49	72.8	8.37
	12	36.9	4.20	44.3	4.98	51.3	5.82	54.9	6.25	58.5	6.71	65.5	7.61	72.8	8.53
	14	36.9	4.27	44.3	5.04	51.3	5.93	54.9	6.35	58.5	6.80	65.5	7.78	72.8	8.68
	16	36.9	4.32	44.3	5.14	51.3	6.02	54.9	6.48	58.5	6.93	65.5	7.91	72.8	8.88
	18	36.9	4.39	44.3	5.24	51.3	6.15	54.9	6.60	58.5	7.07	65.5	8.04	72.8	9.03
	20	36.9	4.46	44.3	5.34	51.3	6.25	54.9	6.74	58.5	7.23	65.5	8.23	72.8	9.37
	21	36.9	4.52	44.3	5.37	51.3	6.31	54.9	6.80	58.5	7.29	65.5	8.37	72.8	9.58
	23	36.9	4.59	44.3	5.50	51.3	6.44	54.9	7.03	58.5	7.65	65.5	8.95	72.8	10.11
	25	36.9	4.65	44.3	5.70	51.3	6.87	54.9	7.52	58.5	8.17	65.5	9.57	72.8	10.60
	27	36.9	4.92	44.3	6.09	51.3	7.32	54.9	7.97	58.5	8.72	65.5	10.22	72.8	11.26
	29	36.9	5.24	44.3	6.44	51.3	7.78	54.9	8.50	58.5	9.28	65.5	10.90	72.8	12.06
	31	36.9	5.57	44.3	6.87	51.3	8.30	54.9	9.08	58.5	9.89	65.5	11.62	72.8	12.80
	33	36.9	5.89	44.3	7.25	51.3	8.82	54.9	9.64	58.5	10.52	65.5	12.37	72.8	13.63
	35	36.9	6.22	44.3	7.75	51.3	9.37	54.9	10.25	58.5	11.19	65.5	13.18	72.8	14.45
	37	36.9	6.60	44.3	8.21	51.3	9.96	54.9	10.90	58.5	11.91	65.5	14.03	72.8	15.26
	39	36.9	7.02	44.3	8.75	51.3	10.65	54.9	11.73	58.5	12.87	65.5	15.01	72.8	16.45
	41	36.0	7.76	43.1	9.58	49.9	11.68	53.5	12.87	57.0	13.99	63.9	16.49	70.9	17.74
	43	35.2	8.44	42.0	10.45	48.7	12.75	52.2	14.03	55.6	15.28	62.3	18.01	69.1	19.18
	46	32.9	9.38	39.4	11.75	45.7	14.36	48.8	15.63	52.1	17.23	58.3	20.32	64.8	21.38
	48	29.1	8.19	34.8	10.26	40.4	12.55	43.2	13.65	46.1	15.06	51.6	17.78	57.4	18.50
60	10	31.7	3.62	37.8	4.24	43.9	4.93	47.1	5.30	50.1	5.63	56.3	6.38	62.5	7.14
	12	31.7	3.69	37.8	4.31	43.9	5.00	47.1	5.36	50.1	5.72	56.3	6.48	62.5	7.27
	14	31.7	3.71	37.8	4.37	43.9	5.10	47.1	5.46	50.1	5.83	56.3	6.61	62.5	7.40
	16	31.7	3.78	37.8	4.48	43.9	5.17	47.1	5.56	50.1	5.96	56.3	6.74	62.5	7.53
	18	31.7	3.85	37.8	4.54	43.9	5.26	47.1	5.66	50.1	6.05	56.3	6.84	62.5	7.70
	20	31.7	3.91	37.8	4.61	43.9	5.36	47.1	5.76	50.1	6.16	56.3	6.98	62.5	7.86
	21	31.7	3.95	37.8	4.64	43.9	5.43	47.1	5.83	50.1	6.22	56.3	7.07	62.5	7.93
	23	31.7	4.02	37.8	4.74	43.9	5.50	47.1	5.92	50.1	6.35	56.3	7.33	62.5	8.42
	25	31.7	4.08	37.8	4.84	43.9	5.72	47.1	6.22	50.1	6.74	56.3	7.83	62.5	9.01
	27	31.7	4.21	37.8	5.10	43.9	6.09	47.1	6.61	50.1	7.17	56.3	8.32	62.5	9.61
	29	31.7	4.48	37.8	5.43	43.9	6.48	47.1	7.04	50.1	7.64	56.3	8.88	62.5	10.26
	31	31.7	4.74	37.8	5.76	43.9	6.87	47.1	7.50	50.1	8.13	56.3	9.47	62.5	10.92
	33	31.7	5.00	37.8	6.09	43.9	7.31	47.1	7.97	50.1	8.65	56.3	10.07	62.5	11.64
	35	31.7	5.30	37.8	6.48	43.9	7.77	47.1	8.46	50.1	9.18	56.3	10.73	62.5	12.37
	37	31.7	5.59	37.8	6.84	43.9	8.22	47.1	8.98	50.1	9.74	56.3	11.38	62.5	13.16
	39	31.7	5.94	37.8	7.28	43.9	8.88	47.1	9.63	50.1	10.48	56.3	12.21	62.5	14.10
	41	30.8	6.45	36.8	7.97	42.9	9.64	45.8	10.53	48.8	11.37	54.8	13.40	60.9	15.32
	43	30.1	7.00	35.9	8.68	41.8	10.51	44.7	11.46	47.6	12.41	53.5	14.62	59.3	16.74
	46	28.2	7.85	33.6	9.74	39.2	11.82	41.9	12.89	44.6	13.96	50.1	16.47	55.6	19.07
	48	24.9	6.84	29.8	8.50	34.6	10.33	37.1	11.26	39.5	12.19	44.3	14.41	49.2	16.69
50	10	26.4	3.16	31.7	3.66	36.7	4.16	39.2	4.45	41.7	4.72	46.7	5.32	52.1	5.91
	12	26.4	3.19	31.7	3.69	36.7	4.22	39.2	4.52	41.7	4.82	46.7	5.42	52.1	6.02
	14	26.4	3.23	31.7	3.75	36.7	4.29	39.2	4.58	41.7	4.88	46.7	5.49	52.1	6.12
	16	26.4	3.29	31.7	3.82	36.7	4.36	39.2	4.69	41.7	4.95	46.7	5.58	52.1	6.21
	18	26.4	3.32	31.7	3.86	36.7	4.42	39.2	4.75	41.7	5.05	46.7	5.69	52.1	6.35
	20	26.4	3.36	31.7	3.92	36.7	4.52	39.2	4.82	41.7	5.15	46.7	5.78	52.1	6.48
	21	26.4	3.39	31.7	3.95	36.7	4.55	39.2	4.88	41.7	5.19	46.7	5.85	52.1	6.54
	23	26.4	3.46	31.7	4.03	36.7	4.62	39.2	4.95	41.7	5.28	46.7	5.95	52.1	6.68
	25	26.4	3.49	31.7	4.09	36.7	4.72	39.2	5.05	41.7	5.45	46.7	6.25	52.1	7.15
	27	26.4	3.55	31.7	4.22	36.7	4.99	39.2	5.38	41.7	5.78	46.7	6.68	52.1	7.61
	29	26.4	3.75	31.7	4.49	36.7	5.28	39.2	5.71	41.7	6.15	46.7	7.08	52.1	8.08
	31	26.4	3.95	31.7	4.75	36.7	5.62	39.2	6.05	41.7	6.54	46.7	7.54	52.1	8.61
	33	26.4	4.19	31.7	5.02	36.7	5.95	39.2	6.41	41.7	6.95	46.7	8.01	52.1	9.18
	35	26.4	4.42	31.7	5.32	36.7	6.28	39.2	6.82	41.7	7.35	46.7	8.48	52.1	9.74
	37	26.4	4.69	31.7	5.62	36.7	6.65	39.2	7.21	41.7	7.78	46.7	9.04	52.1	10.33
	39	26.4	5.00	31.7	6.02	36.7	7.13	39.2	7.76	41.7	8.35	46.7	9.63	52.1	11.16
	41	25.7	5.41	30.8	6.52	35.7	7.79	38.2	8.41	40.6	9.04	45.5	10.55	50.7	12.12
	43	25.2	5.88	30.1	7.09	34.8	8.48	37.3	9.16	39.7	9.85	44.4	11.51	49.5	13.23
	46	23.6	6.58	28.2	7.95	32.7	9.51	34.9	10.29	37.1	11.05	41.6	12.95	46.4	14.89
	48	20.8	5.73	24.9	6.93	28.9	8.29	30.8	8.98	32.9	9.64	36.9	11.32	41.0	13.02

Note

1. TC: Total Capacity(kW), PI : Power Input(kW, Comp. + Outdoor fan motor)
2. Capacity tables show the average value of conditions which may occur.

7. Capacity Tables

◆ A(C)RUN300LLS5

Combination (%)	Outdoor air temp (°C DB)	Indoor air temp. (DB/WB, °C)													
		20		23		26		27		28		30		32	
		14		16		18		19		20		22		24	
		TC	PI	TC	PI	TC	PI	TC	PI	TC	PI	TC	PI	TC	PI
130	10	83.2	9.00	99.1	10.99	106.2	12.75	109.2	13.01	112.3	13.12	117.7	13.22	120.7	13.27
	12	83.2	9.22	99.1	11.38	106.2	13.27	109.2	13.36	112.3	13.46	117.7	13.58	120.7	13.70
	14	83.2	9.53	99.1	11.79	106.2	13.77	109.2	13.87	112.3	13.98	117.7	14.10	120.7	14.22
	16	83.2	9.87	99.1	12.20	106.2	14.39	109.2	14.53	112.3	14.64	117.7	14.77	120.7	14.89
	18	83.2	10.29	99.1	12.91	106.2	15.05	109.2	15.37	112.3	15.50	117.7	15.65	120.7	15.76
	20	83.2	10.74	99.1	13.76	106.2	15.79	109.2	16.91	112.3	17.05	116.0	17.22	119.0	17.34
	21	83.2	11.03	99.1	14.24	106.2	16.13	109.2	17.89	112.3	18.04	115.3	18.22	118.4	18.34
	23	83.2	11.83	99.1	14.98	106.2	16.96	109.2	19.75	110.8	19.91	113.7	20.10	116.7	20.25
	25	83.2	12.63	99.1	15.84	106.2	18.13	108.0	21.91	109.2	22.08	112.3	22.30	115.3	22.46
	27	83.2	13.51	99.1	16.94	104.8	19.32	106.2	24.11	108.0	24.30	110.8	24.54	113.7	24.72
	29	83.2	14.41	99.1	18.10	103.2	20.78	104.7	26.51	106.2	26.66	109.2	26.90	112.3	27.01
	31	83.2	15.37	98.8	19.07	101.5	22.10	103.2	26.39	104.7	26.55	107.5	26.78	110.5	26.89
	33	83.2	16.37	97.0	20.20	100.1	23.70	101.7	26.15	103.2	26.30	106.2	26.54	108.8	26.65
	35	83.2	17.46	95.3	21.16	98.4	25.68	100.1	25.80	101.7	25.96	104.5	26.20	107.5	26.30
	37	83.2	18.62	94.0	22.20	97.0	25.34	98.4	25.47	100.1	25.62	102.8	25.85	105.8	25.95
	39	83.2	19.82	92.3	23.37	95.3	25.00	97.0	25.13	98.4	25.27	101.5	25.51	104.5	25.60
	41	81.0	21.03	88.5	24.54	91.5	24.66	92.8	24.78	94.7	24.94	97.5	25.16	100.2	25.25
	43	79.0	22.18	84.8	24.20	87.8	24.32	89.1	24.44	90.9	24.59	93.7	24.81	96.2	24.91
46	74.1	23.75	77.3	23.70	80.2	23.82	81.5	23.94	83.2	24.08	85.7	24.29	88.1	24.39	
48	65.5	23.08	67.2	23.15	69.7	23.20	70.8	23.27	72.3	23.46	74.7	23.61	76.7	23.70	
120	10	75.3	8.09	89.5	9.92	97.8	11.79	100.8	12.74	103.8	12.94	109.5	12.99	112.1	13.10
	12	75.3	8.31	89.5	10.26	97.8	12.26	100.8	13.01	103.8	13.42	109.5	13.58	112.1	13.69
	14	75.3	8.60	89.5	10.60	97.8	12.76	100.8	13.50	103.8	13.91	109.5	14.12	112.1	14.23
	16	75.3	8.91	89.5	11.03	97.8	13.25	100.8	14.01	103.8	14.56	109.5	14.74	112.1	14.85
	18	75.3	9.25	89.5	11.53	97.8	13.79	100.8	14.74	103.8	15.30	109.5	15.48	112.1	15.60
	20	75.3	9.60	89.5	12.23	97.8	14.53	100.8	15.51	103.8	16.11	109.5	16.32	112.1	16.46
	21	75.3	9.89	89.5	12.67	97.8	14.93	100.8	15.98	103.8	16.65	109.5	16.86	112.1	16.99
	23	75.3	10.58	89.5	13.56	97.8	16.00	100.8	16.98	103.8	17.74	109.5	17.92	112.1	18.06
	25	75.3	11.31	89.5	14.53	97.8	16.87	100.8	18.10	103.8	19.03	108.1	19.18	110.7	19.34
	27	75.3	12.07	89.5	15.53	97.8	17.96	100.8	19.34	103.8	20.44	106.5	20.58	109.1	20.75
	29	75.3	12.87	89.5	16.58	97.8	18.89	100.8	20.68	102.1	21.79	104.8	22.12	107.8	22.30
	31	75.3	13.72	89.5	17.70	97.8	19.87	99.5	22.16	100.8	23.37	103.5	23.79	106.1	23.98
	33	75.3	14.60	89.5	18.87	96.5	21.02	97.8	24.06	99.2	25.10	101.8	25.39	104.5	25.59
	35	75.3	15.53	89.5	20.11	94.8	22.25	96.2	26.51	97.8	26.63	100.5	26.71	103.1	26.92
	37	75.3	16.70	89.5	21.22	93.5	23.72	94.8	25.94	96.2	26.08	98.8	26.15	101.5	26.36
	39	75.3	17.98	89.2	22.43	91.8	25.16	93.2	25.41	94.5	25.54	97.5	25.61	100.2	25.82
	41	73.3	19.26	85.3	23.64	88.2	24.66	89.5	24.87	90.7	25.01	93.3	25.08	96.0	25.27
	43	71.5	20.56	81.7	23.30	84.5	24.11	85.8	24.34	87.0	24.46	89.6	24.54	92.2	24.73
46	67.0	22.10	74.5	22.75	77.2	23.35	78.3	23.54	79.5	23.66	82.0	23.73	84.4	23.92	
48	59.3	21.65	64.7	22.34	67.1	22.89	68.2	23.04	69.2	23.11	71.3	23.20	73.5	23.30	
110	10	67.5	7.28	80.4	8.87	89.8	10.53	92.4	11.41	98.2	12.27	100.5	12.62	107.3	12.82
	12	67.5	7.50	80.4	9.17	89.8	10.98	92.4	11.72	98.2	12.74	100.5	13.15	107.3	13.45
	14	67.5	7.74	80.4	9.58	89.8	11.47	92.4	12.31	98.2	13.38	100.5	13.75	107.3	14.05
	16	67.5	8.01	80.4	9.93	89.8	11.94	92.4	12.84	98.2	13.99	100.5	14.37	107.3	14.63
	18	67.5	8.31	80.4	10.34	89.8	12.63	92.4	13.53	98.2	14.76	100.5	15.05	107.3	15.34
	20	67.5	8.60	80.4	10.86	89.8	13.39	92.4	14.15	98.2	15.48	100.5	15.86	107.3	16.11
	21	67.5	8.79	80.4	11.18	89.8	13.74	92.4	14.53	98.2	15.91	100.5	16.31	107.3	16.56
	23	67.5	9.37	80.4	11.99	89.8	14.51	92.4	15.34	98.2	16.81	100.5	17.17	107.3	17.45
	25	67.5	10.02	80.4	12.79	89.8	15.32	92.4	16.22	98.2	17.75	100.5	18.01	106.0	18.38
	27	67.5	10.70	80.4	13.68	89.8	16.20	92.4	17.16	98.2	18.54	100.5	18.96	104.5	19.29
	29	67.5	11.43	80.4	14.60	89.8	17.11	92.4	18.17	98.2	19.60	100.5	19.94	103.1	20.24
	31	67.5	12.15	80.4	15.57	89.8	18.08	92.4	19.25	96.7	20.59	99.2	20.99	101.5	21.22
	33	67.5	12.96	80.4	16.58	89.8	19.11	92.4	20.41	95.3	21.75	97.6	22.11	100.2	22.23
	35	67.5	13.76	80.4	17.70	89.8	20.18	92.4	21.62	93.7	22.94	96.0	23.16	98.5	23.27
	37	67.5	14.58	80.4	18.79	89.8	21.30	91.1	22.91	92.0	24.20	94.7	24.29	97.0	24.36
	39	67.5	15.72	80.4	19.96	88.2	22.48	89.5	24.50	90.8	25.40	93.0	25.44	95.7	25.47
	41	65.7	16.86	78.3	21.13	84.4	23.70	85.7	26.51	86.8	26.51	89.4	26.71	91.6	26.92
	43	64.1	17.70	76.4	22.03	80.9	25.13	82.2	25.42	83.3	25.37	85.8	25.51	88.0	25.58
46	60.0	17.27	71.6	21.27	73.8	23.85	75.1	23.85	76.0	24.06	78.4	24.20	80.5	24.26	
48	53.2	16.78	62.2	20.48	64.1	22.70	65.3	22.85	66.2	22.96	68.2	23.03	70.0	23.11	

Note

- 1. TC: Total Capacity(kW), PI: Power Input(kW, Comp. + Outdoor fan motor)
- 2. Capacity tables show the average value of conditions which may occur.

7. Capacity Tables

Combination (%)	Outdoor air temp (°C DB)	Cooling Capacity(30HP)													
		Indoor air temp. (DB/WB, °C)													
		20		23		26		27		28		30		32	
		14	16	18	19	20	22	24							
	TC	PI	TC	PI	TC	PI	TC	PI	TC	PI	TC	PI	TC	PI	
100	10	56.7	6.55	67.5	7.96	78.6	9.45	84.0	10.21	89.4	10.97	99.1	12.22	101.3	12.31
	12	56.7	6.76	67.5	8.29	78.6	9.77	84.0	10.48	89.4	11.32	99.1	12.87	101.3	13.00
	14	56.7	6.98	67.5	8.62	78.6	10.18	84.0	10.94	89.4	11.81	99.1	13.58	101.3	13.72
	16	56.7	7.19	67.5	8.91	78.6	10.62	84.0	11.46	89.4	12.44	99.1	14.24	101.3	14.44
	18	56.7	7.40	67.5	9.24	78.6	11.03	84.0	12.01	89.4	13.20	99.1	15.05	101.3	15.17
	20	56.7	7.67	67.5	9.58	78.6	11.67	84.0	12.87	89.4	14.12	99.1	15.77	101.3	15.89
	21	56.7	7.82	67.5	9.81	78.6	12.07	84.0	13.32	89.4	14.65	99.1	16.13	101.3	16.26
	23	56.7	8.29	67.5	10.50	78.6	12.96	84.0	14.29	89.4	15.69	99.1	16.89	101.3	17.03
	25	56.7	8.81	67.5	11.18	78.6	13.84	84.0	15.29	89.4	16.77	99.1	17.61	100.5	17.75
	27	56.7	9.41	67.5	11.95	78.6	14.80	84.0	16.34	89.4	17.84	97.2	18.44	99.2	18.58
	29	56.7	10.02	67.5	12.75	78.6	15.81	84.0	17.46	89.4	18.87	95.4	19.18	97.7	19.34
	31	56.7	10.70	67.5	13.60	78.6	16.86	84.0	18.63	89.4	19.84	94.0	19.92	96.2	20.08
	33	56.7	11.34	67.5	14.48	78.6	17.98	84.0	19.87	89.4	20.58	92.5	20.67	94.7	20.84
	35	56.7	12.07	67.5	15.41	78.6	19.15	84.0	21.20	88.0	21.32	90.8	21.41	93.0	21.58
	37	56.7	12.93	67.5	16.53	78.6	20.29	84.0	22.21	86.6	22.32	89.0	22.41	91.2	22.61
	39	56.7	13.86	67.5	17.75	78.6	21.49	84.0	23.30	85.2	23.40	87.7	23.49	89.7	23.70
	41	55.8	14.79	66.5	18.98	77.3	22.70	80.6	24.39	82.3	24.48	84.3	24.56	87.0	24.79
43	53.9	15.65	64.2	20.12	74.7	23.79	77.3	25.32	78.2	25.40	80.6	25.49	82.7	25.73	
46	50.5	16.84	60.1	21.69	70.0	25.23	70.5	26.51	71.3	26.58	73.6	26.66	75.6	26.91	
48	44.7	14.53	53.2	18.77	60.5	21.58	61.3	22.49	62.0	22.56	64.0	22.61	65.7	22.79	
90	10	51.0	5.84	60.9	7.02	70.8	8.27	75.6	8.91	80.4	9.60	90.3	10.74	100.2	11.94
	12	51.0	5.91	60.9	7.12	70.8	8.42	75.6	9.09	80.4	9.81	90.3	10.95	100.2	12.16
	14	51.0	6.01	60.9	7.27	70.8	8.59	75.6	9.28	80.4	9.99	90.3	11.16	100.2	12.40
	16	51.0	6.13	60.9	7.41	70.8	8.77	75.6	9.45	80.4	10.17	90.3	11.38	100.2	12.61
	18	51.0	6.23	60.9	7.56	70.8	8.91	75.6	9.67	80.4	10.39	90.3	11.62	100.2	13.25
	20	51.0	6.33	60.9	7.70	70.8	9.09	75.6	9.85	80.4	10.78	90.3	12.44	100.2	13.88
	21	51.0	6.41	60.9	7.77	70.8	9.28	75.6	10.17	80.4	11.17	90.3	12.65	100.2	14.20
	23	51.0	6.55	60.9	8.09	70.8	9.92	75.6	10.91	80.4	11.96	90.3	13.41	98.8	14.87
	25	51.0	6.87	60.9	8.62	70.8	10.59	75.6	11.67	80.4	12.78	90.3	14.33	97.4	15.51
	27	51.0	7.34	60.9	9.20	70.8	11.31	75.6	12.46	80.4	13.67	90.3	15.24	96.0	16.23
	29	51.0	7.77	60.9	9.81	70.8	12.10	75.6	13.32	80.4	14.60	90.3	16.15	94.5	16.89
	31	51.0	8.27	60.9	10.46	70.8	12.88	75.6	14.18	80.4	15.58	90.3	16.95	93.1	17.53
	33	51.0	8.81	60.9	11.13	70.8	13.74	75.6	15.11	80.4	16.52	90.3	17.77	91.7	18.19
	35	51.0	9.35	60.9	11.82	70.8	14.60	75.6	16.11	80.4	17.51	88.7	18.79	90.3	19.22
	37	51.0	9.92	60.9	12.56	70.8	15.58	75.6	17.11	80.4	18.49	87.3	19.64	88.8	20.09
	39	51.0	10.50	60.9	13.37	70.8	16.49	75.6	18.21	80.4	19.45	85.9	20.71	87.4	20.96
	41	49.7	11.75	59.3	14.82	69.0	18.09	73.7	19.92	78.3	21.00	82.3	21.82	83.8	22.33
43	48.5	12.68	57.8	16.01	67.3	19.77	71.8	21.45	76.4	22.51	78.9	23.37	80.3	23.66	
46	45.5	14.28	54.2	18.24	63.0	22.52	67.3	24.32	69.5	25.01	72.0	25.65	73.4	25.69	
48	40.2	12.48	48.0	15.95	55.8	19.70	59.5	21.22	60.3	21.55	62.6	22.08	63.8	22.11	
80	10	45.3	4.96	54.0	5.96	62.7	6.99	67.2	7.54	71.7	8.10	80.4	9.24	89.1	10.02
	12	45.3	5.07	54.0	6.02	62.7	7.13	67.2	7.69	71.7	8.23	80.4	9.41	89.1	10.22
	14	45.3	5.14	54.0	6.16	62.7	7.23	67.2	7.82	71.7	8.37	80.4	9.58	89.1	10.42
	16	45.3	5.20	54.0	6.27	62.7	7.37	67.2	7.96	71.7	8.54	80.4	9.78	89.1	10.62
	18	45.3	5.31	54.0	6.38	62.7	7.51	67.2	8.10	71.7	8.71	80.4	9.95	89.1	10.85
	20	45.3	5.41	54.0	6.51	62.7	7.69	67.2	8.27	71.7	8.88	80.4	10.33	89.1	11.50
	21	45.3	5.44	54.0	6.58	62.7	7.75	67.2	8.37	71.7	9.10	80.4	10.66	89.1	11.80
	23	45.3	5.55	54.0	6.68	62.7	8.10	67.2	8.88	71.7	9.71	80.4	11.26	89.1	12.38
	25	45.3	5.75	54.0	7.13	62.7	8.68	67.2	9.51	71.7	10.41	80.4	12.04	89.1	13.24
	27	45.3	6.09	54.0	7.57	62.7	9.27	67.2	10.16	71.7	11.09	80.4	12.80	89.1	13.93
	29	45.3	6.48	54.0	8.10	62.7	9.85	67.2	10.82	71.7	11.85	80.4	13.71	89.1	14.92
	31	45.3	6.89	54.0	8.58	62.7	10.51	67.2	11.54	71.7	12.61	80.4	14.55	89.1	15.65
	33	45.3	7.30	54.0	9.17	62.7	11.19	67.2	12.30	71.7	13.44	80.4	15.33	89.1	16.42
	35	45.3	7.75	54.0	9.71	62.7	11.92	67.2	13.09	71.7	14.33	80.4	16.26	88.2	17.01
	37	45.3	8.20	54.0	10.33	62.7	12.64	67.2	13.92	71.7	15.23	80.4	17.16	86.7	17.79
	39	45.3	8.66	54.0	10.92	62.7	13.52	67.2	14.96	71.7	16.36	80.4	18.13	85.3	18.76
	41	44.2	9.58	52.6	12.10	61.1	14.84	65.5	16.40	69.8	17.98	78.3	20.18	81.7	20.79
43	43.0	10.55	51.3	13.20	59.6	16.20	63.8	17.88	68.2	19.65	76.4	21.59	78.3	22.27	
46	40.3	11.74	48.1	14.87	55.8	18.25	59.8	19.89	63.8	22.17	69.8	23.56	71.5	23.94	
48	35.7	10.26	42.5	13.00	49.4	15.96	53.0	17.37	56.5	19.41	60.7	20.40	62.2	20.62	

Note

1. TC: Total Capacity(kW), PI: Power Input(kW, Comp. + Outdoor fan motor)
2. Capacity tables show the average value of conditions which may occur.

7. Capacity Tables

Combination (%)	Outdoor air temp (°C DB)	Cooling Capacity(30HP)													
		Indoor air temp. (DB/WB, °C)													
		20		23		26		27		28		30		32	
		14	16	18	19	20	22	24							
	TC	PI	TC	PI	TC	PI	TC	PI	TC	PI	TC	PI	TC	PI	
70	10	39.6	4.42	47.4	5.26	54.9	6.09	58.8	6.58	62.7	7.03	70.2	8.01	78.0	8.95
	12	39.6	4.49	47.4	5.33	54.9	6.22	58.8	6.68	62.7	7.17	70.2	8.14	78.0	9.12
	14	39.6	4.56	47.4	5.39	54.9	6.34	58.8	6.79	62.7	7.27	70.2	8.32	78.0	9.28
	16	39.6	4.62	47.4	5.50	54.9	6.44	58.8	6.93	62.7	7.41	70.2	8.46	78.0	9.49
	18	39.6	4.69	47.4	5.60	54.9	6.58	58.8	7.06	62.7	7.55	70.2	8.59	78.0	9.66
	20	39.6	4.76	47.4	5.71	54.9	6.68	58.8	7.20	62.7	7.73	70.2	8.80	78.0	10.02
	21	39.6	4.83	47.4	5.74	54.9	6.75	58.8	7.27	62.7	7.80	70.2	8.94	78.0	10.24
	23	39.6	4.91	47.4	5.88	54.9	6.89	58.8	7.51	62.7	8.18	70.2	9.57	78.0	10.81
	25	39.6	4.98	47.4	6.09	54.9	7.34	58.8	8.04	62.7	8.73	70.2	10.23	78.0	11.33
	27	39.6	5.26	47.4	6.51	54.9	7.83	58.8	8.52	62.7	9.33	70.2	10.93	78.0	12.04
	29	39.6	5.60	47.4	6.89	54.9	8.32	58.8	9.09	62.7	9.92	70.2	11.65	78.0	12.90
	31	39.6	5.95	47.4	7.34	54.9	8.87	58.8	9.71	62.7	10.58	70.2	12.42	78.0	13.69
	33	39.6	6.30	47.4	7.76	54.9	9.43	58.8	10.30	62.7	11.24	70.2	13.23	78.0	14.57
	35	39.6	6.65	47.4	8.28	54.9	10.02	58.8	10.96	62.7	11.97	70.2	14.09	78.0	15.45
	37	39.6	7.06	47.4	8.78	54.9	10.65	58.8	11.65	62.7	12.73	70.2	15.00	78.0	16.31
	39	39.6	7.51	47.4	9.35	54.9	11.39	58.8	12.54	62.7	13.76	70.2	16.05	78.0	17.58
	41	38.6	8.30	46.2	10.24	53.5	12.49	57.3	13.76	61.1	14.95	68.4	17.63	76.0	18.97
	43	37.7	9.02	45.0	11.17	52.2	13.63	55.9	15.00	59.6	16.33	66.7	19.26	74.1	20.50
46	35.3	10.03	42.2	12.56	48.9	15.35	52.3	16.71	55.8	18.41	62.5	21.72	69.5	22.86	
48	31.2	8.75	37.3	10.97	43.3	13.42	46.3	14.60	49.4	16.10	55.3	19.01	61.5	19.78	
60	10	33.9	3.87	40.5	4.53	47.1	5.27	50.4	5.66	53.7	6.01	60.3	6.82	66.9	7.62
	12	33.9	3.94	40.5	4.60	47.1	5.34	50.4	5.73	53.7	6.11	60.3	6.92	66.9	7.77
	14	33.9	3.97	40.5	4.67	47.1	5.45	50.4	5.83	53.7	6.22	60.3	7.06	66.9	7.91
	16	33.9	4.04	40.5	4.78	47.1	5.52	50.4	5.94	53.7	6.37	60.3	7.20	66.9	8.05
	18	33.9	4.11	40.5	4.85	47.1	5.62	50.4	6.04	53.7	6.47	60.3	7.31	66.9	8.23
	20	33.9	4.18	40.5	4.93	47.1	5.73	50.4	6.15	53.7	6.58	60.3	7.45	66.9	8.40
	21	33.9	4.22	40.5	4.96	47.1	5.80	50.4	6.22	53.7	6.65	60.3	7.55	66.9	8.47
	23	33.9	4.29	40.5	5.07	47.1	5.87	50.4	6.33	53.7	6.79	60.3	7.84	66.9	8.99
	25	33.9	4.36	40.5	5.17	47.1	6.11	50.4	6.65	53.7	7.20	60.3	8.37	66.9	9.63
	27	33.9	4.50	40.5	5.45	47.1	6.51	50.4	7.06	53.7	7.66	60.3	8.89	66.9	10.26
	29	33.9	4.78	40.5	5.80	47.1	6.92	50.4	7.52	53.7	8.16	60.3	9.49	66.9	10.97
	31	33.9	5.07	40.5	6.15	47.1	7.34	50.4	8.02	53.7	8.68	60.3	10.12	66.9	11.67
	33	33.9	5.34	40.5	6.51	47.1	7.81	50.4	8.51	53.7	9.25	60.3	10.76	66.9	12.44
	35	33.9	5.66	40.5	6.92	47.1	8.30	50.4	9.03	53.7	9.81	60.3	11.46	66.9	13.21
	37	33.9	5.97	40.5	7.31	47.1	8.78	50.4	9.60	53.7	10.40	60.3	12.16	66.9	14.06
	39	33.9	6.35	40.5	7.78	47.1	9.48	50.4	10.29	53.7	11.20	60.3	13.04	66.9	15.07
	41	33.0	6.89	39.5	8.52	45.9	10.30	49.1	11.25	52.3	12.15	58.8	14.32	65.2	16.37
	43	32.2	7.49	38.5	9.27	44.8	11.23	47.9	12.25	51.0	13.26	57.3	15.62	63.5	17.88
46	30.2	8.39	36.0	10.41	42.0	12.63	44.9	13.78	47.8	14.91	53.7	17.60	59.5	20.38	
48	26.7	7.31	31.9	9.08	37.1	11.04	39.7	12.03	42.3	13.03	47.5	15.40	52.7	17.83	
50	10	28.3	3.37	33.9	3.91	39.3	4.44	42.0	4.75	44.7	5.05	50.1	5.68	55.8	6.31
	12	28.3	3.40	33.9	3.94	39.3	4.51	42.0	4.82	44.7	5.15	50.1	5.79	55.8	6.43
	14	28.3	3.44	33.9	4.01	39.3	4.58	42.0	4.89	44.7	5.22	50.1	5.86	55.8	6.54
	16	28.3	3.51	33.9	4.08	39.3	4.65	42.0	5.01	44.7	5.29	50.1	5.96	55.8	6.64
	18	28.3	3.55	33.9	4.12	39.3	4.72	42.0	5.08	44.7	5.40	50.1	6.07	55.8	6.78
	20	28.3	3.59	33.9	4.19	39.3	4.82	42.0	5.15	44.7	5.50	50.1	6.17	55.8	6.92
	21	28.3	3.63	33.9	4.22	39.3	4.86	42.0	5.22	44.7	5.54	50.1	6.24	55.8	6.99
	23	28.3	3.70	33.9	4.30	39.3	4.94	42.0	5.29	44.7	5.64	50.1	6.36	55.8	7.13
	25	28.3	3.73	33.9	4.37	39.3	5.05	42.0	5.40	44.7	5.82	50.1	6.68	55.8	7.63
	27	28.3	3.80	33.9	4.51	39.3	5.33	42.0	5.75	44.7	6.17	50.1	7.13	55.8	8.13
	29	28.3	4.01	33.9	4.79	39.3	5.64	42.0	6.10	44.7	6.57	50.1	7.56	55.8	8.63
	31	28.3	4.22	33.9	5.08	39.3	6.00	42.0	6.47	44.7	6.99	50.1	8.06	55.8	9.20
	33	28.3	4.47	33.9	5.36	39.3	6.36	42.0	6.85	44.7	7.42	50.1	8.55	55.8	9.80
	35	28.3	4.72	33.9	5.68	39.3	6.71	42.0	7.28	44.7	7.85	50.1	9.05	55.8	10.40
	37	28.3	5.01	33.9	6.00	39.3	7.10	42.0	7.70	44.7	8.31	50.1	9.66	55.8	11.04
	39	28.3	5.34	33.9	6.43	39.3	7.61	42.0	8.29	44.7	8.92	50.1	10.29	55.8	11.92
	41	27.6	5.77	33.0	6.96	38.3	8.32	41.0	8.98	43.5	9.66	48.8	11.27	54.3	12.95
	43	27.0	6.28	32.2	7.57	37.3	9.05	39.9	9.78	42.5	10.52	47.6	12.29	53.0	14.13
46	25.2	7.03	30.2	8.50	35.0	10.15	37.4	10.98	39.8	11.80	44.6	13.83	49.7	15.90	
48	22.3	6.12	26.7	7.41	31.0	8.85	33.1	9.59	35.2	10.30	39.5	12.09	44.0	13.90	

Note

1. TC: Total Capacity(kW), PI : Power Input(kW, Comp. + Outdoor fan motor)
2. Capacity tables show the average value of conditions which may occur.

7. Capacity Tables

◆ A(C)RUN320LLS5

Combination (%)	Outdoor air temp (°C DB)	Indoor air temp. (DB/WB, °C)													
		20		23		26		27		28		30		32	
		14		16		18		19		20		22		24	
		TC	PI	TC	PI	TC	PI	TC	PI	TC	PI	TC	PI	TC	PI
130	10	88.8	9.76	105.7	11.92	113.3	13.83	116.5	14.11	119.8	14.23	125.6	14.34	128.8	14.40
	12	88.8	10.00	105.7	12.35	113.3	14.40	116.5	14.50	119.8	14.61	125.6	14.73	128.8	14.86
	14	88.8	10.33	105.7	12.80	113.3	14.94	116.5	15.05	119.8	15.17	125.6	15.29	128.8	15.43
	16	88.8	10.71	105.7	13.24	113.3	15.61	116.5	15.76	119.8	15.89	125.6	16.02	128.8	16.15
	18	88.8	11.16	105.7	14.01	113.3	16.33	116.5	16.68	119.8	16.82	125.6	16.98	128.8	17.10
	20	88.8	11.65	105.7	14.93	113.3	17.13	116.5	18.35	119.8	18.50	123.7	18.68	127.0	18.81
	21	88.8	11.96	105.7	15.45	113.3	17.49	116.5	19.41	119.8	19.57	123.0	19.77	126.3	19.90
	23	88.8	12.84	105.7	16.25	113.3	18.40	116.5	21.43	118.2	21.60	121.3	21.81	124.5	21.96
	25	88.8	13.70	105.7	17.19	113.3	19.67	115.2	23.77	116.5	23.95	119.8	24.19	123.0	24.36
	27	88.8	14.66	105.7	18.37	111.8	20.96	113.3	26.16	115.2	26.37	118.2	26.63	121.3	26.82
	29	88.8	15.63	105.7	19.64	110.1	22.54	111.7	28.76	113.3	28.92	116.5	29.18	119.8	29.30
	31	88.8	16.67	105.3	20.69	108.2	23.98	110.1	28.63	111.7	28.81	114.7	29.05	117.9	29.17
	33	88.8	17.76	103.5	21.92	106.7	25.72	108.5	28.37	110.1	28.54	113.3	28.79	116.1	28.91
	35	88.8	18.94	101.7	22.95	105.0	27.86	106.7	27.99	108.5	28.17	111.5	28.42	114.7	28.53
	37	88.8	20.20	100.3	24.09	103.5	27.49	105.0	27.63	106.7	27.80	109.6	28.04	112.9	28.15
	39	88.8	21.51	98.5	25.36	101.7	27.13	103.5	27.26	105.0	27.42	108.2	27.67	111.5	27.78
	41	86.4	22.82	94.4	26.62	97.6	26.75	99.0	26.88	101.0	27.05	104.0	27.29	106.9	27.40
	43	84.3	24.06	90.4	26.25	93.6	26.39	95.0	26.52	97.0	26.67	99.9	26.92	102.6	27.03
	46	79.0	25.76	82.5	25.71	85.6	25.84	86.9	25.97	88.7	26.12	91.5	26.36	93.9	26.46
48	69.9	25.04	71.7	25.12	74.4	25.17	75.5	25.24	77.1	25.45	79.7	25.61	81.8	25.72	
120	10	80.3	8.78	95.5	10.76	104.3	12.79	107.5	13.82	110.7	14.04	116.8	14.09	119.5	14.21
	12	80.3	9.02	95.5	11.13	104.3	13.31	107.5	14.11	110.7	14.56	116.8	14.73	119.5	14.86
	14	80.3	9.33	95.5	11.50	104.3	13.85	107.5	14.65	110.7	15.09	116.8	15.32	119.5	15.43
	16	80.3	9.66	95.5	11.97	104.3	14.37	107.5	15.20	110.7	15.79	116.8	15.99	119.5	16.11
	18	80.3	10.03	95.5	12.51	104.3	14.96	107.5	16.00	110.7	16.60	116.8	16.79	119.5	16.93
	20	80.3	10.42	95.5	13.26	104.3	15.76	107.5	16.83	110.7	17.48	116.8	17.71	119.5	17.85
	21	80.3	10.73	95.5	13.75	104.3	16.20	107.5	17.33	110.7	18.06	116.8	18.29	119.5	18.43
	23	80.3	11.48	95.5	14.71	104.3	17.36	107.5	18.42	110.7	19.25	116.8	19.44	119.5	19.60
	25	80.3	12.27	95.5	15.76	104.3	18.30	107.5	19.63	110.7	20.64	115.3	20.81	118.1	20.98
	27	80.3	13.10	95.5	16.85	104.3	19.48	107.5	20.98	110.7	22.18	113.6	22.33	116.3	22.51
	29	80.3	13.96	95.5	17.98	104.3	20.50	107.5	22.44	108.9	23.64	111.8	24.00	114.9	24.19
	31	80.3	14.88	95.5	19.20	104.3	21.56	106.1	24.04	107.5	25.36	110.4	25.81	113.1	26.02
	33	80.3	15.84	95.5	20.47	102.9	22.80	104.3	26.10	105.8	27.23	108.6	27.54	111.4	27.76
	35	80.3	16.85	95.5	21.82	101.1	24.14	102.6	28.76	104.3	28.89	107.2	28.98	109.9	29.21
	37	80.3	18.12	95.5	23.03	99.7	25.74	101.1	28.14	102.6	28.29	105.4	28.37	108.3	28.60
	39	80.3	19.51	95.2	24.34	97.9	27.29	99.4	27.57	100.8	27.70	104.0	27.79	106.9	28.01
	41	78.2	20.90	91.0	25.64	94.1	26.75	95.4	26.99	96.8	27.13	99.5	27.21	102.4	27.42
	43	76.3	22.30	87.2	25.28	90.2	26.16	91.5	26.41	92.8	26.54	95.5	26.62	98.4	26.83
	46	71.5	23.98	79.5	24.68	82.4	25.33	83.5	25.54	84.8	25.67	87.4	25.74	90.1	25.95
48	63.2	23.49	69.0	24.24	71.5	24.84	72.7	24.99	73.8	25.07	76.0	25.17	78.4	25.27	
110	10	72.0	7.90	85.8	9.62	95.8	11.43	98.6	12.38	104.8	13.31	107.2	13.69	114.4	13.91
	12	72.0	8.14	85.8	9.95	95.8	11.91	98.6	12.72	104.8	13.82	107.2	14.26	114.4	14.59
	14	72.0	8.40	85.8	10.39	95.8	12.45	98.6	13.35	104.8	14.52	107.2	14.92	114.4	15.24
	16	72.0	8.69	85.8	10.78	95.8	12.95	98.6	13.93	104.8	15.18	107.2	15.59	114.4	15.87
	18	72.0	9.02	85.8	11.22	95.8	13.70	98.6	14.68	104.8	16.02	107.2	16.33	114.4	16.64
	20	72.0	9.33	85.8	11.78	95.8	14.53	98.6	15.35	104.8	16.79	107.2	17.21	114.4	17.48
	21	72.0	9.54	85.8	12.13	95.8	14.91	98.6	15.76	104.8	17.26	107.2	17.70	114.4	17.97
	23	72.0	10.16	85.8	13.00	95.8	15.74	98.6	16.64	104.8	18.24	107.2	18.63	114.4	18.94
	25	72.0	10.87	85.8	13.88	95.8	16.62	98.6	17.59	104.8	19.26	107.2	19.54	113.1	19.94
	27	72.0	11.61	85.8	14.84	95.8	17.57	98.6	18.61	104.8	20.11	107.2	20.58	111.4	20.93
	29	72.0	12.40	85.8	15.84	95.8	18.56	98.6	19.72	104.8	21.26	107.2	21.63	109.9	21.96
	31	72.0	13.18	85.8	16.89	95.8	19.62	98.6	20.89	103.1	22.34	105.8	22.77	108.3	23.02
	33	72.0	14.06	85.8	17.98	95.8	20.73	98.6	22.14	101.6	23.59	104.1	23.98	106.9	24.11
	35	72.0	14.93	85.8	19.20	95.8	21.89	98.6	23.46	100.0	24.89	102.4	25.12	105.1	25.25
	37	72.0	15.82	85.8	20.38	95.8	23.11	97.1	24.85	98.2	26.26	101.0	26.35	103.4	26.43
	39	72.0	17.06	85.8	21.66	94.1	24.39	95.4	26.58	96.8	27.56	99.2	27.60	102.1	27.63
	41	70.1	18.29	83.5	22.93	90.1	25.72	91.5	28.76	92.6	28.76	95.4	28.98	97.7	29.21
	43	68.3	19.20	81.5	23.90	86.3	27.27	87.7	27.58	88.8	27.52	91.5	27.68	93.8	27.75
	46	64.0	18.74	76.3	23.07	78.7	25.88	80.1	25.88	81.1	26.10	83.7	26.25	85.8	26.32
48	56.7	18.20	66.4	22.22	68.3	24.63	69.6	24.79	70.6	24.91	72.8	24.98	74.7	25.07	

Note

1. TC: Total Capacity(kW), PI: Power Input(kW, Comp. + Outdoor fan motor)
2. Capacity tables show the average value of conditions which may occur.

7. Capacity Tables

Combination (%)	Outdoor air temp (°C DB)	Cooling Capacity(32HP)													
		Indoor air temp. (DB/WB, °C)													
		20		23		26		27		28		30		32	
		14	16	18	19	20	22	24							
	TC	PI	TC	PI	TC	PI	TC	PI	TC	PI	TC	PI	TC	PI	
100	10	60.5	7.11	72.0	8.64	83.8	10.25	89.6	11.08	95.4	11.91	105.7	13.25	108.0	13.36
	12	60.5	7.34	72.0	8.99	83.8	10.60	89.6	11.37	95.4	12.28	105.7	13.96	108.0	14.10
	14	60.5	7.57	72.0	9.35	83.8	11.04	89.6	11.87	95.4	12.81	105.7	14.74	108.0	14.88
	16	60.5	7.80	72.0	9.66	83.8	11.52	89.6	12.43	95.4	13.50	105.7	15.45	108.0	15.67
	18	60.5	8.03	72.0	10.02	83.8	11.96	89.6	13.03	95.4	14.32	105.7	16.33	108.0	16.46
	20	60.5	8.32	72.0	10.40	83.8	12.66	89.6	13.96	95.4	15.32	105.7	17.11	108.0	17.24
	21	60.5	8.48	72.0	10.65	83.8	13.10	89.6	14.45	95.4	15.89	105.7	17.50	108.0	17.64
	23	60.5	8.99	72.0	11.39	83.8	14.06	89.6	15.50	95.4	17.02	105.7	18.32	108.0	18.47
	25	60.5	9.56	72.0	12.13	83.8	15.01	89.6	16.59	95.4	18.20	105.7	19.10	107.2	19.26
	27	60.5	10.21	72.0	12.97	83.8	16.06	89.6	17.72	95.4	19.35	103.7	20.00	105.9	20.16
	29	60.5	10.87	72.0	13.83	83.8	17.15	89.6	18.94	95.4	20.47	101.8	20.81	104.3	20.98
	31	60.5	11.61	72.0	14.75	83.8	18.29	89.6	20.21	95.4	21.52	100.2	21.61	102.7	21.79
	33	60.5	12.30	72.0	15.71	83.8	19.51	89.6	21.56	95.4	22.33	98.6	22.43	101.1	22.61
	35	60.5	13.10	72.0	16.72	83.8	20.78	89.6	23.00	93.9	23.13	96.8	23.23	99.2	23.41
	37	60.5	14.03	72.0	17.93	83.8	22.01	89.6	24.09	92.3	24.21	95.0	24.31	97.3	24.53
	39	60.5	15.04	72.0	19.26	83.8	23.32	89.6	25.27	90.9	25.38	93.5	25.48	95.7	25.72
	41	59.5	16.05	70.9	20.59	82.5	24.63	85.9	26.46	87.8	26.56	89.9	26.65	92.8	26.90
	43	57.5	16.98	68.5	21.83	79.7	25.81	82.4	27.47	83.4	27.56	85.9	27.65	88.2	27.91
46	53.9	18.27	64.1	23.54	74.7	27.37	75.2	28.76	76.0	28.84	78.5	28.92	80.6	29.20	
48	47.7	15.77	56.8	20.36	64.5	23.41	65.4	24.39	66.1	24.47	68.3	24.53	70.1	24.73	
90	10	54.4	6.22	65.0	7.48	75.5	8.82	80.6	9.50	85.8	10.23	96.3	11.45	106.9	12.73
	12	54.4	6.30	65.0	7.59	75.5	8.97	80.6	9.69	85.8	10.45	96.3	11.68	106.9	12.96
	14	54.4	6.41	65.0	7.75	75.5	9.16	80.6	9.89	85.8	10.65	96.3	11.90	106.9	13.22
	16	54.4	6.53	65.0	7.90	75.5	9.35	80.6	10.08	85.8	10.84	96.3	12.13	106.9	13.44
	18	54.4	6.64	65.0	8.05	75.5	9.50	80.6	10.31	85.8	11.07	96.3	12.39	106.9	14.12
	20	54.4	6.75	65.0	8.21	75.5	9.69	80.6	10.50	85.8	11.49	96.3	13.26	106.9	14.80
	21	54.4	6.83	65.0	8.29	75.5	9.89	80.6	10.84	85.8	11.91	96.3	13.48	106.9	15.14
	23	54.4	6.98	65.0	8.63	75.5	10.57	80.6	11.63	85.8	12.75	96.3	14.30	105.4	15.85
	25	54.4	7.33	65.0	9.19	75.5	11.29	80.6	12.44	85.8	13.62	96.3	15.28	103.9	16.53
	27	54.4	7.82	65.0	9.81	75.5	12.05	80.6	13.28	85.8	14.57	96.3	16.25	102.4	17.30
	29	54.4	8.29	65.0	10.45	75.5	12.89	80.6	14.20	85.8	15.57	96.3	17.21	100.8	18.00
	31	54.4	8.82	65.0	11.15	75.5	13.73	80.6	15.11	85.8	16.61	96.3	18.06	99.3	18.69
	33	54.4	9.39	65.0	11.87	75.5	14.65	80.6	16.11	85.8	17.61	96.3	18.95	97.8	19.39
	35	54.4	9.97	65.0	12.60	75.5	15.57	80.6	17.17	85.8	18.67	94.7	20.03	96.3	20.49
	37	54.4	10.57	65.0	13.39	75.5	16.61	80.6	18.24	85.8	19.71	93.1	20.94	94.7	21.41
	39	54.4	11.19	65.0	14.25	75.5	17.58	80.6	19.42	85.8	20.73	91.7	22.07	93.3	22.34
	41	53.0	12.52	63.3	15.80	73.6	19.29	78.6	21.23	83.5	22.38	87.8	23.26	89.3	23.80
	43	51.7	13.52	61.7	17.07	71.8	21.07	76.6	22.86	81.5	23.99	84.2	24.91	85.7	25.22
46	48.5	15.22	57.9	19.44	67.2	24.01	71.8	25.93	74.1	26.66	76.8	27.35	78.3	27.38	
48	42.9	13.30	51.2	17.00	59.5	21.00	63.5	22.62	64.3	22.97	66.7	23.54	68.0	23.57	
80	10	48.3	5.31	57.6	6.38	66.9	7.48	71.7	8.08	76.5	8.67	85.8	9.89	95.0	10.73
	12	48.3	5.42	57.6	6.45	66.9	7.63	71.7	8.23	76.5	8.81	85.8	10.07	95.0	10.94
	14	48.3	5.50	57.6	6.60	66.9	7.74	71.7	8.37	76.5	8.96	85.8	10.25	95.0	11.15
	16	48.3	5.56	57.6	6.71	66.9	7.89	71.7	8.52	76.5	9.14	85.8	10.47	95.0	11.37
	18	48.3	5.68	57.6	6.83	66.9	8.04	71.7	8.67	76.5	9.33	85.8	10.65	95.0	11.61
	20	48.3	5.79	57.6	6.97	66.9	8.23	71.7	8.85	76.5	9.51	85.8	11.06	95.0	12.31
	21	48.3	5.82	57.6	7.04	66.9	8.29	71.7	8.96	76.5	9.74	85.8	11.41	95.0	12.63
	23	48.3	5.94	57.6	7.15	66.9	8.67	71.7	9.51	76.5	10.39	85.8	12.05	95.0	13.25
	25	48.3	6.16	57.6	7.63	66.9	9.29	71.7	10.18	76.5	11.14	85.8	12.89	95.0	14.18
	27	48.3	6.52	57.6	8.11	66.9	9.92	71.7	10.88	76.5	11.87	85.8	13.71	95.0	14.91
	29	48.3	6.93	57.6	8.67	66.9	10.55	71.7	11.58	76.5	12.68	85.8	14.68	95.0	15.97
	31	48.3	7.38	57.6	9.19	66.9	11.25	71.7	12.36	76.5	13.50	85.8	15.58	95.0	16.76
	33	48.3	7.82	57.6	9.81	66.9	11.98	71.7	13.17	76.5	14.38	85.8	16.41	95.0	17.58
	35	48.3	8.29	57.6	10.39	66.9	12.76	71.7	14.02	76.5	15.34	85.8	17.40	94.1	18.21
	37	48.3	8.78	57.6	11.06	66.9	13.53	71.7	14.90	76.5	16.30	85.8	18.37	92.5	19.04
	39	48.3	9.27	57.6	11.69	66.9	14.47	71.7	16.02	76.5	17.51	85.8	19.40	91.0	20.08
	41	47.1	10.26	56.1	12.96	65.1	15.89	69.9	17.56	74.5	19.25	83.5	21.60	87.2	22.26
	43	45.9	11.30	54.7	14.13	63.5	17.35	68.1	19.14	72.7	21.03	81.5	23.11	83.5	23.83
46	43.0	12.57	51.3	15.92	59.5	19.54	63.8	21.30	68.1	23.73	74.5	25.22	76.3	25.63	
48	38.1	10.98	45.4	13.92	52.7	17.09	56.5	18.60	60.3	20.78	64.8	21.84	66.3	22.07	

Note

1. TC: Total Capacity(kW), PI : Power Input(kW, Comp. + Outdoor fan motor)
2. Capacity tables show the average value of conditions which may occur.

7. Capacity Tables

Combination (%)	Outdoor air temp (°C DB)	Cooling Capacity(32HP)													
		Indoor air temp. (DB/WB, °C)													
		20		23		26		27		28		30		32	
		14	16	18	19	20	22	24	TC	PI	TC	PI	TC	PI	
70	10	42.2	4.75	50.6	5.65	58.6	6.55	62.7	7.07	66.9	7.56	74.9	8.61	83.2	9.62
	12	42.2	4.83	50.6	5.73	58.6	6.69	62.7	7.18	66.9	7.71	74.9	8.75	83.2	9.80
	14	42.2	4.90	50.6	5.79	58.6	6.81	62.7	7.30	66.9	7.82	74.9	8.94	83.2	9.98
	16	42.2	4.97	50.6	5.91	58.6	6.92	62.7	7.45	66.9	7.97	74.9	9.09	83.2	10.20
	18	42.2	5.05	50.6	6.02	58.6	7.07	62.7	7.59	66.9	8.12	74.9	9.24	83.2	10.38
	20	42.2	5.12	50.6	6.14	58.6	7.18	62.7	7.74	66.9	8.30	74.9	9.46	83.2	10.77
	21	42.2	5.20	50.6	6.17	58.6	7.25	62.7	7.82	66.9	8.38	74.9	9.61	83.2	11.00
	23	42.2	5.27	50.6	6.32	58.6	7.41	62.7	8.08	66.9	8.79	74.9	10.29	83.2	11.62
	25	42.2	5.35	50.6	6.55	58.6	7.89	62.7	8.64	66.9	9.39	74.9	11.00	83.2	12.18
	27	42.2	5.65	50.6	6.99	58.6	8.41	62.7	9.16	66.9	10.03	74.9	11.75	83.2	12.94
	29	42.2	6.02	50.6	7.41	58.6	8.94	62.7	9.77	66.9	10.66	74.9	12.53	83.2	13.86
	31	42.2	6.40	50.6	7.89	58.6	9.54	62.7	10.44	66.9	11.37	74.9	13.35	83.2	14.71
	33	42.2	6.77	50.6	8.34	58.6	10.13	62.7	11.08	66.9	12.08	74.9	14.22	83.2	15.66
	35	42.2	7.15	50.6	8.90	58.6	10.77	62.7	11.78	66.9	12.86	74.9	15.15	83.2	16.61
	37	42.2	7.59	50.6	9.43	58.6	11.44	62.7	12.53	66.9	13.69	74.9	16.12	83.2	17.53
	39	42.2	8.07	50.6	10.05	58.6	12.24	62.7	13.48	66.9	14.79	74.9	17.25	83.2	18.90
	41	41.1	8.92	49.3	11.01	57.1	13.42	61.1	14.79	65.1	16.07	73.0	18.95	81.1	20.39
	43	40.2	9.70	48.0	12.01	55.7	14.65	59.7	16.12	63.5	17.56	71.2	20.70	79.0	22.04
46	37.6	10.78	45.0	13.50	52.2	16.50	55.8	17.96	59.5	19.79	66.7	23.35	74.1	24.57	
48	33.3	9.41	39.8	11.79	46.1	14.42	49.4	15.69	52.7	17.31	59.0	20.44	65.6	21.26	
60	10	36.2	4.17	43.2	4.89	50.2	5.69	53.8	6.11	57.3	6.49	64.3	7.36	71.4	8.23
	12	36.2	4.25	43.2	4.97	50.2	5.76	53.8	6.18	57.3	6.60	64.3	7.47	71.4	8.38
	14	36.2	4.28	43.2	5.04	50.2	5.88	53.8	6.29	57.3	6.72	64.3	7.62	71.4	8.53
	16	36.2	4.36	43.2	5.16	50.2	5.96	53.8	6.41	57.3	6.87	64.3	7.77	71.4	8.69
	18	36.2	4.44	43.2	5.24	50.2	6.07	53.8	6.52	57.3	6.98	64.3	7.89	71.4	8.88
	20	36.2	4.51	43.2	5.32	50.2	6.18	53.8	6.64	57.3	7.10	64.3	8.04	71.4	9.07
	21	36.2	4.55	43.2	5.35	50.2	6.26	53.8	6.72	57.3	7.17	64.3	8.15	71.4	9.14
	23	36.2	4.63	43.2	5.47	50.2	6.34	53.8	6.83	57.3	7.33	64.3	8.46	71.4	9.71
	25	36.2	4.71	43.2	5.58	50.2	6.60	53.8	7.17	57.3	7.77	64.3	9.03	71.4	10.39
	27	36.2	4.86	43.2	5.88	50.2	7.02	53.8	7.62	57.3	8.27	64.3	9.60	71.4	11.08
	29	36.2	5.16	43.2	6.26	50.2	7.47	53.8	8.12	57.3	8.80	64.3	10.24	71.4	11.84
	31	36.2	5.47	43.2	6.64	50.2	7.92	53.8	8.65	57.3	9.37	64.3	10.92	71.4	12.60
	33	36.2	5.76	43.2	7.02	50.2	8.42	53.8	9.18	57.3	9.98	64.3	11.61	71.4	13.42
	35	36.2	6.11	43.2	7.47	50.2	8.96	53.8	9.75	57.3	10.59	64.3	12.37	71.4	14.26
	37	36.2	6.45	43.2	7.89	50.2	9.48	53.8	10.36	57.3	11.23	64.3	13.12	71.4	15.17
	39	36.2	6.85	43.2	8.40	50.2	10.24	53.8	11.11	57.3	12.09	64.3	14.08	71.4	16.26
	41	35.2	7.44	42.1	9.19	49.0	11.12	52.3	12.14	55.8	13.12	62.7	15.45	69.6	17.67
	43	34.4	8.08	41.1	10.01	47.7	12.12	51.1	13.22	54.4	14.31	61.1	16.86	67.8	19.30
46	32.2	9.06	38.4	11.23	44.8	13.63	47.9	14.87	51.0	16.09	57.3	19.00	63.5	21.99	
48	28.5	7.89	34.1	9.80	39.5	11.91	42.4	12.99	45.1	14.06	50.7	16.62	56.2	19.24	
50	10	30.2	3.66	36.2	4.23	41.9	4.81	44.8	5.15	47.7	5.47	53.4	6.15	59.5	6.84
	12	30.2	3.69	36.2	4.27	41.9	4.89	44.8	5.23	47.7	5.58	53.4	6.27	59.5	6.96
	14	30.2	3.73	36.2	4.34	41.9	4.96	44.8	5.30	47.7	5.65	53.4	6.35	59.5	7.08
	16	30.2	3.81	36.2	4.42	41.9	5.04	44.8	5.42	47.7	5.73	53.4	6.46	59.5	7.19
	18	30.2	3.84	36.2	4.46	41.9	5.12	44.8	5.50	47.7	5.85	53.4	6.58	59.5	7.34
	20	30.2	3.88	36.2	4.54	41.9	5.23	44.8	5.58	47.7	5.96	53.4	6.69	59.5	7.50
	21	30.2	3.93	36.2	4.57	41.9	5.27	44.8	5.65	47.7	6.00	53.4	6.77	59.5	7.57
	23	30.2	4.00	36.2	4.66	41.9	5.35	44.8	5.73	47.7	6.11	53.4	6.89	59.5	7.73
	25	30.2	4.04	36.2	4.74	41.9	5.47	44.8	5.85	47.7	6.31	53.4	7.23	59.5	8.27
	27	30.2	4.11	36.2	4.89	41.9	5.77	44.8	6.23	47.7	6.69	53.4	7.73	59.5	8.81
	29	30.2	4.34	36.2	5.19	41.9	6.11	44.8	6.61	47.7	7.12	53.4	8.20	59.5	9.35
	31	30.2	4.57	36.2	5.50	41.9	6.50	44.8	7.01	47.7	7.57	53.4	8.73	59.5	9.96
	33	30.2	4.85	36.2	5.81	41.9	6.89	44.8	7.42	47.7	8.04	53.4	9.27	59.5	10.62
	35	30.2	5.12	36.2	6.15	41.9	7.27	44.8	7.89	47.7	8.50	53.4	9.81	59.5	11.27
	37	30.2	5.42	36.2	6.50	41.9	7.69	44.8	8.35	47.7	9.00	53.4	10.46	59.5	11.96
	39	30.2	5.78	36.2	6.97	41.9	8.25	44.8	8.98	47.7	9.66	53.4	11.15	59.5	12.92
	41	29.4	6.26	35.2	7.54	40.8	9.01	43.7	9.73	46.4	10.47	52.0	12.21	57.9	14.03
	43	28.8	6.80	34.4	8.20	39.8	9.81	42.6	10.60	45.3	11.40	50.7	13.32	56.6	15.31
46	26.9	7.62	32.2	9.20	37.3	11.00	39.9	11.90	42.4	12.79	47.5	14.99	53.0	17.23	
48	23.8	6.64	28.5	8.02	33.0	9.59	35.3	10.39	37.6	11.16	42.1	13.10	46.9	15.06	

Note

1. TC: Total Capacity(kW), PI: Power Input(kW, Comp. + Outdoor fan motor)
2. Capacity tables show the average value of conditions which may occur.

7. Capacity Tables

◆ A(C)RUN340LLS5

Combination (%)	Outdoor air temp (°C DB)	Indoor air temp. (DB/WB, °C)														Cooling Capacity(34HP)	
		20		23		26		27		28		30		32		TC	PI
		14		16		18		19		20		22		24			
		TC	PI	TC	PI	TC	PI	TC	PI	TC	PI	TC	PI	TC	PI		
130	10	94.3	10.91	112.3	13.32	120.4	15.45	123.8	15.77	127.2	15.90	133.4	16.02	136.8	16.09		
	12	94.3	11.17	112.3	13.80	120.4	16.09	123.8	16.20	127.2	16.32	133.4	16.46	136.8	16.60		
	14	94.3	11.55	112.3	14.30	120.4	16.69	123.8	16.81	127.2	16.95	133.4	17.09	136.8	17.24		
	16	94.3	11.96	112.3	14.79	120.4	17.44	123.8	17.61	127.2	17.75	133.4	17.91	136.8	18.05		
	18	94.3	12.47	112.3	15.65	120.4	18.25	123.8	18.63	127.2	18.79	133.4	18.97	136.8	19.11		
	20	94.3	13.02	112.3	16.68	120.4	19.15	123.8	20.50	127.2	20.67	131.5	20.87	134.9	21.02		
	21	94.3	13.36	112.3	17.27	120.4	19.55	123.8	21.69	127.2	21.87	130.7	22.09	134.2	22.24		
	23	94.3	14.34	112.3	18.16	120.4	20.56	123.8	23.94	125.6	24.14	128.8	24.37	132.3	24.54		
	25	94.3	15.31	112.3	19.20	120.4	21.97	122.4	26.56	123.8	26.77	127.2	27.03	130.7	27.22		
	27	94.3	16.38	112.3	20.53	118.8	23.41	120.4	29.23	122.4	29.46	125.6	29.75	128.8	29.97		
	29	94.3	17.46	112.3	21.95	116.9	25.19	118.6	32.13	120.4	32.32	123.8	32.61	127.2	32.74		
	31	94.3	18.63	111.9	23.12	115.0	26.80	116.9	31.99	118.6	32.19	121.9	32.47	125.3	32.60		
	33	94.3	19.84	110.0	24.49	113.4	28.74	115.3	31.70	116.9	31.89	120.4	32.17	123.3	32.30		
	35	94.3	21.17	108.0	25.65	111.6	31.13	113.4	31.28	115.3	31.47	118.4	31.76	121.9	31.88		
	37	94.3	22.57	106.5	26.92	110.0	30.72	111.6	30.87	113.4	31.06	116.5	31.33	119.9	31.45		
	39	94.3	24.03	104.6	28.33	108.0	30.31	110.0	30.46	111.6	30.64	115.0	30.92	118.4	31.04		
	41	91.9	25.50	100.3	29.75	103.7	29.89	105.2	30.04	107.3	30.23	110.5	30.50	113.6	30.61		
	43	89.6	26.89	96.1	29.34	99.5	29.48	100.9	29.63	103.0	29.81	106.2	30.08	109.1	30.20		
46	83.9	28.78	87.6	28.73	90.9	28.87	92.3	29.02	94.3	29.19	97.2	29.45	99.8	29.57			
48	74.3	27.98	76.2	28.06	79.0	28.12	80.2	28.20	81.9	28.44	84.6	28.62	87.0	28.73			
120	10	85.3	9.81	101.4	12.02	110.8	14.29	114.2	15.45	117.6	15.69	124.0	15.75	127.0	15.88		
	12	85.3	10.07	101.4	12.44	110.8	14.87	114.2	15.77	117.6	16.26	124.0	16.46	127.0	16.60		
	14	85.3	10.42	101.4	12.85	110.8	15.47	114.2	16.37	117.6	16.86	124.0	17.12	127.0	17.25		
	16	85.3	10.80	101.4	13.38	110.8	16.06	114.2	16.98	117.6	17.64	124.0	17.87	127.0	18.00		
	18	85.3	11.21	101.4	13.98	110.8	16.71	114.2	17.87	117.6	18.55	124.0	18.76	127.0	18.91		
	20	85.3	11.64	101.4	14.82	110.8	17.61	114.2	18.81	117.6	19.53	124.0	19.79	127.0	19.95		
	21	85.3	11.99	101.4	15.36	110.8	18.10	114.2	19.37	117.6	20.18	124.0	20.44	127.0	20.59		
	23	85.3	12.82	101.4	16.43	110.8	19.40	114.2	20.58	117.6	21.51	124.0	21.72	127.0	21.90		
	25	85.3	13.71	101.4	17.61	110.8	20.45	114.2	21.94	117.6	23.07	122.5	23.25	125.5	23.45		
	27	85.3	14.63	101.4	18.83	110.8	21.77	114.2	23.44	117.6	24.78	120.7	24.95	123.6	25.15		
	29	85.3	15.60	101.4	20.09	110.8	22.90	114.2	25.07	115.7	26.42	118.7	26.82	122.1	27.03		
	31	85.3	16.63	101.4	21.46	110.8	24.09	112.8	26.86	114.2	28.34	117.3	28.84	120.2	29.07		
	33	85.3	17.70	101.4	22.87	109.4	25.48	110.8	29.16	112.4	30.43	115.4	30.78	118.4	31.02		
	35	85.3	18.83	101.4	24.38	107.5	26.97	109.0	32.13	110.8	32.29	113.9	32.38	116.8	32.64		
	37	85.3	20.25	101.4	25.73	106.0	28.76	107.5	31.45	109.0	31.61	112.0	31.70	115.0	31.96		
	39	85.3	21.80	101.1	27.20	104.1	30.50	105.6	30.81	107.1	30.96	110.5	31.05	113.5	31.30		
	41	83.1	23.35	96.7	28.65	100.0	29.89	101.4	30.15	102.8	30.31	105.8	30.40	108.8	30.64		
	43	81.1	24.92	92.6	28.25	95.8	29.23	97.2	29.51	98.6	29.66	101.5	29.75	104.5	29.98		
46	76.0	26.80	84.5	27.58	87.5	28.31	88.8	28.54	90.1	28.68	92.9	28.77	95.7	29.00			
48	67.2	26.25	73.4	27.09	76.0	27.75	77.3	27.92	78.4	28.01	80.8	28.13	83.3	28.24			
110	10	76.5	8.83	91.2	10.75	101.8	12.77	104.7	13.83	111.3	14.88	113.9	15.30	121.6	15.54		
	12	76.5	9.10	91.2	11.12	101.8	13.31	104.7	14.21	111.3	15.44	113.9	15.94	121.6	16.31		
	14	76.5	9.38	91.2	11.61	101.8	13.91	104.7	14.92	111.3	16.22	113.9	16.67	121.6	17.03		
	16	76.5	9.71	91.2	12.04	101.8	14.48	104.7	15.57	111.3	16.96	113.9	17.42	121.6	17.73		
	18	76.5	10.08	91.2	12.54	101.8	15.31	104.7	16.40	111.3	17.90	113.9	18.25	121.6	18.59		
	20	76.5	10.43	91.2	13.17	101.8	16.24	104.7	17.15	111.3	18.76	113.9	19.23	121.6	19.53		
	21	76.5	10.66	91.2	13.55	101.8	16.66	104.7	17.61	111.3	19.29	113.9	19.77	121.6	20.08		
	23	76.5	11.36	91.2	14.53	101.8	17.59	104.7	18.59	111.3	20.38	113.9	20.81	121.6	21.16		
	25	76.5	12.15	91.2	15.51	101.8	18.57	104.7	19.66	111.3	21.52	113.9	21.83	120.1	22.28		
	27	76.5	12.97	91.2	16.58	101.8	19.63	104.7	20.80	111.3	22.47	113.9	22.99	118.4	23.39		
	29	76.5	13.85	91.2	17.70	101.8	20.74	104.7	22.03	111.3	23.76	113.9	24.17	116.8	24.54		
	31	76.5	14.73	91.2	18.88	101.8	21.92	104.7	23.34	109.6	24.96	112.4	25.45	115.0	25.72		
	33	76.5	15.70	91.2	20.09	101.8	23.16	104.7	24.74	108.0	26.36	110.6	26.80	113.6	26.94		
	35	76.5	16.68	91.2	21.46	101.8	24.46	104.7	26.21	106.2	27.82	108.8	28.07	111.7	28.21		
	37	76.5	17.67	91.2	22.78	101.8	25.82	103.2	27.77	104.3	29.34	107.3	29.45	109.9	29.53		
	39	76.5	19.06	91.2	24.20	100.0	27.25	101.4	29.70	102.9	30.79	105.4	30.85	108.4	30.88		
	41	74.5	20.44	88.8	25.62	95.7	28.73	97.2	32.13	98.4	32.13	101.3	32.38	103.8	32.64		
	43	72.6	21.46	86.6	26.70	91.7	30.47	93.2	30.81	94.4	30.75	97.2	30.92	99.7	31.01		
46	68.0	20.94	81.1	25.78	83.6	28.91	85.1	28.91	86.2	29.17	88.9	29.33	91.2	29.40			
48	60.3	20.34	70.5	24.83	72.6	27.52	74.0	27.70	75.0	27.83	77.3	27.92	79.3	28.02			

Note

- 1. TC: Total Capacity(kW), PI: Power Input(kW, Comp. + Outdoor fan motor)
- 2. Capacity tables show the average value of conditions which may occur.

7. Capacity Tables

Combination (%)	Outdoor air temp (°C DB)	Cooling Capacity(34HP)													
		Indoor air temp. (DB/WB, °C)													
		20		23		26		27		28		30		32	
		14	16	18	19	20	22	24							
	TC	PI	TC	PI	TC	PI	TC	PI	TC	PI	TC	PI	TC	PI	
100	10	64.3	7.94	76.5	9.65	89.0	11.46	95.2	12.38	101.4	13.30	112.3	14.81	114.8	14.92
	12	64.3	8.20	76.5	10.05	89.0	11.84	95.2	12.71	101.4	13.72	112.3	15.60	114.8	15.76
	14	64.3	8.46	76.5	10.45	89.0	12.34	95.2	13.26	101.4	14.32	112.3	16.47	114.8	16.63
	16	64.3	8.72	76.5	10.80	89.0	12.87	95.2	13.89	101.4	15.08	112.3	17.27	114.8	17.51
	18	64.3	8.97	76.5	11.20	89.0	13.37	95.2	14.56	101.4	16.00	112.3	18.25	114.8	18.39
	20	64.3	9.29	76.5	11.62	89.0	14.14	95.2	15.60	101.4	17.12	112.3	19.12	114.8	19.27
	21	64.3	9.48	76.5	11.90	89.0	14.63	95.2	16.14	101.4	17.75	112.3	19.55	114.8	19.72
	23	64.3	10.05	76.5	12.73	89.0	15.70	95.2	17.32	101.4	19.02	112.3	20.48	114.8	20.64
	25	64.3	10.68	76.5	13.55	89.0	16.78	95.2	18.53	101.4	20.33	112.3	21.35	113.9	21.52
	27	64.3	11.41	76.5	14.49	89.0	17.94	95.2	19.80	101.4	21.62	110.2	22.35	112.5	22.53
	29	64.3	12.15	76.5	15.46	89.0	19.17	95.2	21.17	101.4	22.88	108.1	23.25	110.8	23.44
	31	64.3	12.97	76.5	16.48	89.0	20.44	95.2	22.58	101.4	24.05	106.5	24.15	109.1	24.35
	33	64.3	13.75	76.5	17.56	89.0	21.80	95.2	24.09	101.4	24.95	104.8	25.06	107.4	25.26
	35	64.3	14.63	76.5	18.68	89.0	23.21	95.2	25.70	99.8	25.85	102.9	25.96	105.5	26.16
	37	64.3	15.67	76.5	20.04	89.0	24.59	95.2	26.92	98.1	27.06	100.9	27.17	103.4	27.41
	39	64.3	16.80	76.5	21.52	89.0	26.05	95.2	28.24	96.5	28.36	99.4	28.47	101.7	28.73
	41	63.2	17.93	75.3	23.01	87.6	27.52	91.3	29.56	93.3	29.68	95.5	29.78	98.6	30.06
	43	61.1	18.97	72.7	24.39	84.7	28.84	87.6	30.69	88.6	30.79	91.3	30.90	93.7	31.19
46	57.2	20.41	68.1	26.30	79.3	30.59	79.9	32.13	80.8	32.22	83.4	32.31	85.6	32.62	
48	50.7	17.62	60.3	22.75	68.5	26.15	69.5	27.26	70.2	27.35	72.5	27.41	74.5	27.63	
90	10	57.8	6.88	69.1	8.27	80.2	9.75	85.6	10.51	91.2	11.32	102.3	12.66	113.6	14.08
	12	57.8	6.97	69.1	8.40	80.2	9.92	85.6	10.72	91.2	11.56	102.3	12.91	113.6	14.33
	14	57.8	7.09	69.1	8.57	80.2	10.13	85.6	10.94	91.2	11.78	102.3	13.16	113.6	14.62
	16	57.8	7.22	69.1	8.74	80.2	10.34	85.6	11.14	91.2	11.99	102.3	13.41	113.6	14.87
	18	57.8	7.34	69.1	8.91	80.2	10.51	85.6	11.40	91.2	12.24	102.3	13.71	113.6	15.62
	20	57.8	7.47	69.1	9.08	80.2	10.72	85.6	11.61	91.2	12.71	102.3	14.67	113.6	16.37
	21	57.8	7.55	69.1	9.16	80.2	10.94	85.6	11.99	91.2	13.17	102.3	14.91	113.6	16.74
	23	57.8	7.72	69.1	9.54	80.2	11.69	85.6	12.87	91.2	14.10	102.3	15.81	112.0	17.53
	25	57.8	8.10	69.1	10.17	80.2	12.49	85.6	13.76	91.2	15.07	102.3	16.90	110.4	18.28
	27	57.8	8.65	69.1	10.85	80.2	13.33	85.6	14.69	91.2	16.12	102.3	17.97	108.8	19.13
	29	57.8	9.16	69.1	11.56	80.2	14.26	85.6	15.70	91.2	17.22	102.3	19.04	107.1	19.91
	31	57.8	9.75	69.1	12.33	80.2	15.19	85.6	16.72	91.2	18.37	102.3	19.98	105.5	20.67
	33	57.8	10.39	69.1	13.13	80.2	16.21	85.6	17.82	91.2	19.48	102.3	20.95	103.9	21.45
	35	57.8	11.02	69.1	13.93	80.2	17.22	85.6	18.99	91.2	20.65	100.6	22.15	102.3	22.67
	37	57.8	11.69	69.1	14.81	80.2	18.37	85.6	20.18	91.2	21.80	98.9	23.16	100.6	23.68
	39	57.8	12.38	69.1	15.76	80.2	19.44	85.6	21.48	91.2	22.93	97.4	24.42	99.1	24.71
	41	56.3	13.85	67.2	17.47	78.2	21.33	83.5	23.48	88.8	24.75	93.3	25.73	94.9	26.32
	43	54.9	14.95	65.5	18.88	76.2	23.30	81.4	25.29	86.6	26.54	89.5	27.55	91.0	27.89
46	51.5	16.83	61.5	21.50	71.4	26.55	76.3	28.68	78.7	29.49	81.6	30.25	83.2	30.29	
48	45.6	14.71	54.4	18.81	63.2	23.23	67.5	25.02	68.3	25.40	70.9	26.04	72.3	26.07	
80	10	51.3	5.80	61.2	6.98	71.1	8.18	76.2	8.83	81.3	9.48	91.2	10.81	100.9	11.73
	12	51.3	5.93	61.2	7.05	71.1	8.34	76.2	8.99	81.3	9.63	91.2	11.01	100.9	11.96
	14	51.3	6.01	61.2	7.21	71.1	8.46	76.2	9.15	81.3	9.79	91.2	11.21	100.9	12.19
	16	51.3	6.08	61.2	7.33	71.1	8.63	76.2	9.31	81.3	9.99	91.2	11.44	100.9	12.43
	18	51.3	6.21	61.2	7.46	71.1	8.79	76.2	9.48	81.3	10.20	91.2	11.64	100.9	12.69
	20	51.3	6.33	61.2	7.61	71.1	8.99	76.2	9.68	81.3	10.40	91.2	12.09	100.9	13.45
	21	51.3	6.36	61.2	7.70	71.1	9.06	76.2	9.79	81.3	10.64	91.2	12.47	100.9	13.80
	23	51.3	6.49	61.2	7.81	71.1	9.48	76.2	10.40	81.3	11.36	91.2	13.17	100.9	14.49
	25	51.3	6.73	61.2	8.34	71.1	10.16	76.2	11.13	81.3	12.17	91.2	14.09	100.9	15.50
	27	51.3	7.13	61.2	8.86	71.1	10.84	76.2	11.89	81.3	12.98	91.2	14.98	100.9	16.30
	29	51.3	7.58	61.2	9.48	71.1	11.53	76.2	12.66	81.3	13.86	91.2	16.04	100.9	17.45
	31	51.3	8.06	61.2	10.04	71.1	12.29	76.2	13.51	81.3	14.76	91.2	17.03	100.9	18.32
	33	51.3	8.54	61.2	10.72	71.1	13.09	76.2	14.39	81.3	15.72	91.2	17.94	100.9	19.21
	35	51.3	9.06	61.2	11.36	71.1	13.94	76.2	15.32	81.3	16.77	91.2	19.02	99.9	19.90
	37	51.3	9.59	61.2	12.09	71.1	14.79	76.2	16.29	81.3	17.82	91.2	20.07	98.3	20.81
	39	51.3	10.14	61.2	12.78	71.1	15.82	76.2	17.51	81.3	19.14	91.2	21.21	96.7	21.95
	41	50.1	11.21	59.6	14.16	69.2	17.37	74.2	19.19	79.1	21.04	88.8	23.61	92.6	24.33
	43	48.8	12.35	58.1	15.45	67.5	18.96	72.3	20.92	77.3	22.99	86.6	25.26	88.8	26.05
46	45.7	13.74	54.5	17.40	63.2	21.35	67.8	23.28	72.3	25.94	79.1	27.57	81.0	28.02	
48	40.5	12.00	48.2	15.22	56.0	18.68	60.0	20.33	64.0	22.71	68.8	23.87	70.5	24.12	

Note

1. TC: Total Capacity(kW), PI : Power Input(kW, Comp. + Outdoor fan motor)
2. Capacity tables show the average value of conditions which may occur.

7. Capacity Tables

		Cooling Capacity(34HP)													
Combination (%)	Outdoor air temp (°C DB)	Indoor air temp. (DB/WB, °C)													
		20		23		26		27		28		30		32	
		14	16	18	19	20	22	24	TC	PI	TC	PI	TC	PI	
70	10	44.8	5.13	53.8	6.11	62.3	7.08	66.6	7.64	71.1	8.16	79.6	9.30	88.4	10.39
	12	44.8	5.22	53.8	6.19	62.3	7.23	66.6	7.76	71.1	8.33	79.6	9.45	88.4	10.59
	14	44.8	5.30	53.8	6.26	62.3	7.36	66.6	7.88	71.1	8.44	79.6	9.66	88.4	10.78
	16	44.8	5.37	53.8	6.39	62.3	7.47	66.6	8.05	71.1	8.61	79.6	9.82	88.4	11.02
	18	44.8	5.45	53.8	6.50	62.3	7.64	66.6	8.20	71.1	8.77	79.6	9.98	88.4	11.21
	20	44.8	5.53	53.8	6.63	62.3	7.76	66.6	8.36	71.1	8.97	79.6	10.22	88.4	11.64
	21	44.8	5.61	53.8	6.67	62.3	7.84	66.6	8.44	71.1	9.05	79.6	10.39	88.4	11.89
	23	44.8	5.70	53.8	6.83	62.3	8.00	66.6	8.73	71.1	9.50	79.6	11.11	88.4	12.55
	25	44.8	5.78	53.8	7.08	62.3	8.53	66.6	9.33	71.1	10.14	79.6	11.88	88.4	13.16
	27	44.8	6.11	53.8	7.56	62.3	9.09	66.6	9.90	71.1	10.83	79.6	12.69	88.4	13.98
	29	44.8	6.50	53.8	8.00	62.3	9.66	66.6	10.55	71.1	11.52	79.6	13.53	88.4	14.98
	31	44.8	6.91	53.8	8.53	62.3	10.30	66.6	11.28	71.1	12.28	79.6	14.42	88.4	15.89
	33	44.8	7.31	53.8	9.01	62.3	10.95	66.6	11.96	71.1	13.05	79.6	15.36	88.4	16.92
	35	44.8	7.72	53.8	9.62	62.3	11.64	66.6	12.73	71.1	13.90	79.6	16.36	88.4	17.94
	37	44.8	8.20	53.8	10.19	62.3	12.36	66.6	13.53	71.1	14.79	79.6	17.42	88.4	18.94
	39	44.8	8.71	53.8	10.86	62.3	13.22	66.6	14.56	71.1	15.97	79.6	18.64	88.4	20.42
	41	43.7	9.63	52.4	11.90	60.6	14.50	64.9	15.97	69.2	17.37	77.6	20.47	86.1	22.03
	43	42.7	10.48	51.0	12.97	59.2	15.83	63.4	17.42	67.5	18.97	75.6	22.36	84.0	23.81
46	40.0	11.65	47.9	14.58	55.5	17.82	59.3	19.41	63.2	21.38	70.8	25.22	78.7	26.55	
48	35.4	10.17	42.3	12.74	49.0	15.58	52.5	16.95	56.0	18.70	62.7	22.08	69.7	22.97	
60	10	38.5	4.46	45.9	5.22	53.3	6.07	57.2	6.52	60.9	6.93	68.3	7.86	75.9	8.79
	12	38.5	4.54	45.9	5.31	53.3	6.15	57.2	6.61	60.9	7.05	68.3	7.98	75.9	8.95
	14	38.5	4.57	45.9	5.39	53.3	6.28	57.2	6.72	60.9	7.17	68.3	8.14	75.9	9.11
	16	38.5	4.66	45.9	5.51	53.3	6.36	57.2	6.85	60.9	7.34	68.3	8.30	75.9	9.28
	18	38.5	4.74	45.9	5.59	53.3	6.48	57.2	6.97	60.9	7.45	68.3	8.43	75.9	9.48
	20	38.5	4.82	45.9	5.68	53.3	6.61	57.2	7.09	60.9	7.58	68.3	8.59	75.9	9.68
	21	38.5	4.86	45.9	5.71	53.3	6.69	57.2	7.17	60.9	7.66	68.3	8.71	75.9	9.76
	23	38.5	4.95	45.9	5.84	53.3	6.77	57.2	7.29	60.9	7.82	68.3	9.03	75.9	10.37
	25	38.5	5.03	45.9	5.96	53.3	7.05	57.2	7.66	60.9	8.30	68.3	9.65	75.9	11.10
	27	38.5	5.19	45.9	6.28	53.3	7.50	57.2	8.14	60.9	8.83	68.3	10.25	75.9	11.83
	29	38.5	5.51	45.9	6.69	53.3	7.98	57.2	8.67	60.9	9.40	68.3	10.94	75.9	12.64
	31	38.5	5.84	45.9	7.09	53.3	8.46	57.2	9.24	60.9	10.01	68.3	11.67	75.9	13.45
	33	38.5	6.15	45.9	7.50	53.3	9.00	57.2	9.81	60.9	10.66	68.3	12.40	75.9	14.34
	35	38.5	6.52	45.9	7.98	53.3	9.57	57.2	10.41	60.9	11.31	68.3	13.21	75.9	15.23
	37	38.5	6.88	45.9	8.43	53.3	10.12	57.2	11.06	60.9	11.99	68.3	14.01	75.9	16.21
	39	38.5	7.32	45.9	8.97	53.3	10.93	57.2	11.86	60.9	12.91	68.3	15.03	75.9	17.37
	41	37.4	7.94	44.7	9.82	52.1	11.88	55.6	12.97	59.3	14.01	66.6	16.50	73.9	18.87
	43	36.5	8.63	43.6	10.69	50.7	12.94	54.3	14.12	57.8	15.28	64.9	18.00	72.0	20.61
46	34.2	9.67	40.9	12.00	47.6	14.55	50.9	15.88	54.2	17.19	60.9	20.29	67.5	23.49	
48	30.3	8.43	36.2	10.47	42.0	12.72	45.0	13.87	47.9	15.02	53.8	17.75	59.8	20.55	
50	10	32.1	3.86	38.5	4.47	44.5	5.08	47.6	5.44	50.7	5.77	56.7	6.50	63.2	7.23
	12	32.1	3.90	38.5	4.51	44.5	5.16	47.6	5.52	50.7	5.89	56.7	6.63	63.2	7.35
	14	32.1	3.94	38.5	4.59	44.5	5.24	47.6	5.60	50.7	5.97	56.7	6.71	63.2	7.48
	16	32.1	4.02	38.5	4.67	44.5	5.32	47.6	5.73	50.7	6.05	56.7	6.82	63.2	7.59
	18	32.1	4.06	38.5	4.71	44.5	5.40	47.6	5.81	50.7	6.18	56.7	6.95	63.2	7.76
	20	32.1	4.10	38.5	4.79	44.5	5.52	47.6	5.89	50.7	6.29	56.7	7.06	63.2	7.92
	21	32.1	4.15	38.5	4.83	44.5	5.57	47.6	5.97	50.7	6.34	56.7	7.15	63.2	8.00
	23	32.1	4.23	38.5	4.92	44.5	5.65	47.6	6.05	50.7	6.45	56.7	7.27	63.2	8.16
	25	32.1	4.26	38.5	5.00	44.5	5.77	47.6	6.18	50.7	6.66	56.7	7.64	63.2	8.73
	27	32.1	4.34	38.5	5.16	44.5	6.10	47.6	6.58	50.7	7.06	56.7	8.16	63.2	9.30
	29	32.1	4.59	38.5	5.48	44.5	6.45	47.6	6.98	50.7	7.51	56.7	8.65	63.2	9.87
	31	32.1	4.83	38.5	5.81	44.5	6.87	47.6	7.40	50.7	8.00	56.7	9.22	63.2	10.52
	33	32.1	5.12	38.5	6.13	44.5	7.27	47.6	7.84	50.7	8.49	56.7	9.78	63.2	11.21
	35	32.1	5.40	38.5	6.50	44.5	7.67	47.6	8.33	50.7	8.98	56.7	10.36	63.2	11.90
	37	32.1	5.73	38.5	6.87	44.5	8.12	47.6	8.82	50.7	9.51	56.7	11.05	63.2	12.63
	39	32.1	6.11	38.5	7.36	44.5	8.71	47.6	9.49	50.7	10.20	56.7	11.77	63.2	13.64
	41	31.3	6.61	37.4	7.96	43.4	9.51	46.4	10.28	49.3	11.05	55.3	12.90	61.6	14.81
	43	30.6	7.18	36.5	8.66	42.3	10.36	45.3	11.19	48.2	12.03	53.9	14.07	60.1	16.17
46	28.6	8.04	34.2	9.72	39.7	11.62	42.4	12.57	45.1	13.51	50.5	15.83	56.3	18.20	
48	25.3	7.01	30.3	8.47	35.1	10.13	37.5	10.97	39.9	11.78	44.7	13.83	49.8	15.90	

Note
1. TC: Total Capacity(kW), PI: Power Input(kW, Comp. + Outdoor fan motor)
2. Capacity tables show the average value of conditions which may occur.

7. Capacity Tables

◆ A(C)RUN360LLS5

Combination (%)	Outdoor air temp (°C DB)	Indoor air temp. (DB/WB, °C)														Cooling Capacity(36HP)	
		20		23		26		27		28		30		32		TC	PI
		14		16		18		19		20		22		24			
		TC	PI	TC	PI	TC	PI	TC	PI	TC	PI	TC	PI	TC	PI		
130	10	99.9	11.50	118.9	14.05	127.5	16.30	131.1	16.63	134.7	16.77	141.3	16.90	144.9	16.96		
	12	99.9	11.78	118.9	14.55	127.5	16.97	131.1	17.08	134.7	17.21	141.3	17.35	144.9	17.51		
	14	99.9	12.18	118.9	15.08	127.5	17.60	131.1	17.73	134.7	17.88	141.3	18.02	144.9	18.18		
	16	99.9	12.62	118.9	15.60	127.5	18.39	131.1	18.57	134.7	18.72	141.3	18.88	144.9	19.03		
	18	99.9	13.15	118.9	16.51	127.5	19.24	131.1	19.65	134.7	19.82	141.3	20.01	144.9	20.15		
	20	99.9	13.73	118.9	17.59	127.5	20.19	131.1	21.62	134.7	21.80	139.2	22.01	142.8	22.16		
	21	99.9	14.09	118.9	18.21	127.5	20.61	131.1	22.88	134.7	23.06	138.4	23.29	142.1	23.45		
	23	99.9	15.12	118.9	19.15	127.5	21.68	131.1	25.24	133.0	25.45	136.4	25.70	140.0	25.88		
	25	99.9	16.14	118.9	20.25	127.5	23.17	129.6	28.00	131.1	28.22	134.7	28.50	138.4	28.70		
	27	99.9	17.27	118.9	21.65	125.8	24.69	127.5	30.82	129.6	31.07	133.0	31.37	136.4	31.60		
	29	99.9	18.41	118.9	23.14	123.8	26.56	125.6	33.88	127.5	34.08	131.1	34.38	134.7	34.52		
	31	99.9	19.64	118.5	24.38	121.8	28.26	123.8	33.73	125.6	33.94	129.0	34.23	132.7	34.38		
	33	99.9	20.93	116.4	25.83	120.1	30.30	122.1	33.43	123.8	33.62	127.5	33.92	130.6	34.06		
	35	99.9	22.32	114.4	27.05	118.1	32.82	120.1	32.99	122.1	33.19	125.4	33.49	129.0	33.62		
	37	99.9	23.80	112.8	28.38	116.4	32.39	118.1	32.55	120.1	32.75	123.4	33.04	127.0	33.17		
	39	99.9	25.34	110.8	29.88	114.4	31.96	116.4	32.12	118.1	32.31	121.8	32.60	125.4	32.73		
	41	97.3	26.89	106.2	31.37	109.8	31.52	111.4	31.68	113.6	31.88	117.0	32.16	120.2	32.28		
	43	94.9	28.35	101.8	30.93	105.3	31.09	106.9	31.24	109.1	31.43	112.4	31.72	115.5	31.84		
	46	88.9	30.35	92.8	30.29	96.2	30.44	97.7	30.60	99.8	30.78	102.9	31.05	105.7	31.18		
	48	78.6	29.50	80.7	29.59	83.7	29.66	85.0	29.74	86.8	29.99	89.6	30.18	92.1	30.30		
120	10	90.3	10.35	107.4	12.68	117.4	15.07	120.9	16.29	124.5	16.54	131.3	16.60	134.5	16.74		
	12	90.3	10.62	107.4	13.11	117.4	15.68	120.9	16.63	124.5	17.15	131.3	17.36	134.5	17.50		
	14	90.3	10.99	107.4	13.55	117.4	16.31	120.9	17.26	124.5	17.78	131.3	18.05	134.5	18.19		
	16	90.3	11.38	107.4	14.10	117.4	16.94	120.9	17.90	124.5	18.61	131.3	18.84	134.5	18.98		
	18	90.3	11.82	107.4	14.74	117.4	17.62	120.9	18.85	124.5	19.56	131.3	19.79	134.5	19.94		
	20	90.3	12.28	107.4	15.63	117.4	18.57	120.9	19.83	124.5	20.59	131.3	20.86	134.5	21.04		
	21	90.3	12.65	107.4	16.20	117.4	19.09	120.9	20.42	124.5	21.28	131.3	21.55	134.5	21.71		
	23	90.3	13.52	107.4	17.33	117.4	20.45	120.9	21.70	124.5	22.68	131.3	22.91	134.5	23.09		
	25	90.3	14.45	107.4	18.57	117.4	21.56	120.9	23.13	124.5	24.32	129.7	24.52	132.9	24.72		
	27	90.3	15.43	107.4	19.85	117.4	22.95	120.9	24.71	124.5	26.13	127.8	26.31	130.9	26.52		
	29	90.3	16.45	107.4	21.19	117.4	24.15	120.9	26.44	122.5	27.86	125.7	28.28	129.3	28.50		
	31	90.3	17.54	107.4	22.63	117.4	25.40	119.4	28.33	120.9	29.88	124.2	30.41	127.3	30.66		
	33	90.3	18.67	107.4	24.12	115.8	26.87	117.4	30.75	119.0	32.09	122.1	32.45	125.4	32.71		
	35	90.3	19.85	107.4	25.71	113.8	28.44	115.4	33.88	117.4	34.04	120.6	34.14	123.7	34.41		
	37	90.3	21.35	107.4	27.13	112.2	30.32	113.8	33.16	115.4	33.33	118.6	33.43	121.8	33.70		
	39	90.3	22.99	107.1	28.68	110.2	32.16	111.8	32.48	113.4	32.64	117.0	32.74	120.2	33.00		
	41	88.0	24.62	102.3	30.21	105.8	31.52	107.3	31.80	108.9	31.96	112.0	32.06	115.2	32.31		
	43	85.8	26.28	98.1	29.78	101.5	30.82	102.9	31.12	104.4	31.27	107.5	31.37	110.7	31.61		
	46	80.4	28.26	89.4	29.08	92.7	29.85	94.0	30.09	95.4	30.24	98.4	30.33	101.3	30.58		
	48	71.2	27.68	77.7	28.56	80.5	29.27	81.8	29.45	83.0	29.54	85.6	29.66	88.2	29.78		
110	10	81.0	9.31	96.5	11.33	107.8	13.46	110.9	14.58	117.9	15.69	120.6	16.13	128.7	16.39		
	12	81.0	9.59	96.5	11.72	107.8	14.03	110.9	14.99	117.9	16.28	120.6	16.80	128.7	17.20		
	14	81.0	9.89	96.5	12.25	107.8	14.67	110.9	15.73	117.9	17.10	120.6	17.58	128.7	17.96		
	16	81.0	10.24	96.5	12.70	107.8	15.26	110.9	16.42	117.9	17.88	120.6	18.37	128.7	18.70		
	18	81.0	10.62	96.5	13.22	107.8	16.14	110.9	17.29	117.9	18.87	120.6	19.24	128.7	19.60		
	20	81.0	11.00	96.5	13.88	107.8	17.12	110.9	18.08	117.9	19.79	120.6	20.27	128.7	20.59		
	21	81.0	11.24	96.5	14.29	107.8	17.57	110.9	18.57	117.9	20.34	120.6	20.85	128.7	21.17		
	23	81.0	11.98	96.5	15.32	107.8	18.54	110.9	19.61	117.9	21.49	120.6	21.95	128.7	22.31		
	25	81.0	12.81	96.5	16.35	107.8	19.59	110.9	20.73	117.9	22.69	120.6	23.02	127.2	23.50		
	27	81.0	13.68	96.5	17.48	107.8	20.70	110.9	21.93	117.9	23.70	120.6	24.24	125.3	24.66		
	29	81.0	14.61	96.5	18.67	107.8	21.87	110.9	23.23	117.9	25.05	120.6	25.48	123.7	25.87		
	31	81.0	15.53	96.5	19.91	107.8	23.12	110.9	24.61	116.0	26.32	119.1	26.83	121.8	27.12		
	33	81.0	16.56	96.5	21.19	107.8	24.42	110.9	26.09	114.3	27.80	117.1	28.26	120.2	28.41		
	35	81.0	17.59	96.5	22.63	107.8	25.79	110.9	27.64	112.5	29.33	115.2	29.60	118.3	29.75		
	37	81.0	18.64	96.5	24.02	107.8	27.23	109.3	29.28	110.5	30.94	113.6	31.05	116.4	31.14		
	39	81.0	20.10	96.5	25.52	105.8	28.74	107.4	31.32	108.9	32.47	111.6	32.53	114.8	32.56		
	41	78.9	21.55	94.0	27.02	101.3	30.30	102.9	33.88	104.2	33.88	107.3	34.14	109.9	34.41		
	43	76.9	22.63	91.7	28.16	97.1	32.13	98.7	32.49	99.9	32.43	102.9	32.61	105.5	32.70		
	46	72.0	22.08	85.9	27.18	88.5	30.49	90.1	30.49	91.3	30.76	94.1	30.93	96.5	31.01		
	48	63.8	21.45	74.7	26.18	76.9	29.02	78.3	29.21	79.4	29.35	81.8	29.44	84.0	29.55		

Note

1. TC: Total Capacity(kW), PI: Power Input(kW, Comp. + Outdoor fan motor)
2. Capacity tables show the average value of conditions which may occur.

7. Capacity Tables

		Cooling Capacity(36HP)													
Combination (%)	Outdoor air temp (°C DB)	Indoor air temp. (DB/WB, °C)													
		20		23		26		27		28		30		32	
		14	16	18	19	20	22	24	TC	PI	TC	PI	TC	PI	
100	10	68.1	8.38	81.0	10.18	94.3	12.08	100.8	13.06	107.3	14.03	118.9	15.61	121.5	15.74
	12	68.1	8.65	81.0	10.60	94.3	12.49	100.8	13.40	107.3	14.47	118.9	16.45	121.5	16.62
	14	68.1	8.92	81.0	11.02	94.3	13.01	100.8	13.98	107.3	15.10	118.9	17.37	121.5	17.54
	16	68.1	9.19	81.0	11.39	94.3	13.57	100.8	14.65	107.3	15.90	118.9	18.21	121.5	18.46
	18	68.1	9.46	81.0	11.81	94.3	14.10	100.8	15.36	107.3	16.87	118.9	19.24	121.5	19.39
	20	68.1	9.80	81.0	12.25	94.3	14.92	100.8	16.45	107.3	18.05	118.9	20.16	121.5	20.32
	21	68.1	10.00	81.0	12.55	94.3	15.43	100.8	17.02	107.3	18.72	118.9	20.62	121.5	20.79
	23	68.1	10.59	81.0	13.42	94.3	16.56	100.8	18.26	107.3	20.06	118.9	21.59	121.5	21.77
	25	68.1	11.26	81.0	14.29	94.3	17.69	100.8	19.54	107.3	21.44	118.9	22.51	120.6	22.69
	27	68.1	12.03	81.0	15.28	94.3	18.92	100.8	20.88	107.3	22.80	116.7	23.57	119.1	23.76
	29	68.1	12.81	81.0	16.30	94.3	20.21	100.8	22.32	107.3	24.13	114.5	24.52	117.3	24.72
	31	68.1	13.68	81.0	17.38	94.3	21.55	100.8	23.81	107.3	25.36	112.8	25.47	115.5	25.67
	33	68.1	14.50	81.0	18.51	94.3	22.99	100.8	25.40	107.3	26.31	111.0	26.42	113.7	26.64
	35	68.1	15.43	81.0	19.70	94.3	24.48	100.8	27.10	105.6	27.26	108.9	27.37	111.7	27.59
	37	68.1	16.53	81.0	21.13	94.3	25.93	100.8	28.39	103.9	28.53	106.9	28.65	109.5	28.91
	39	68.1	17.72	81.0	22.69	94.3	27.47	100.8	29.78	102.2	29.91	105.2	30.02	107.7	30.30
	41	66.9	18.91	79.7	24.26	92.8	29.02	96.7	31.17	98.8	31.29	101.1	31.40	104.4	31.69
	43	64.7	20.01	77.0	25.72	89.7	30.41	92.7	32.36	93.8	32.47	96.7	32.58	99.3	32.89
46	60.6	21.52	72.1	27.73	84.0	32.25	84.6	33.88	85.6	33.98	88.3	34.07	90.7	34.40	
48	53.6	18.58	63.8	23.99	72.5	27.58	73.6	28.74	74.4	28.84	76.8	28.90	78.9	29.13	
90	10	61.2	7.26	73.1	8.73	84.9	10.29	90.7	11.09	96.5	11.94	108.3	13.36	120.3	14.85
	12	61.2	7.35	73.1	8.86	84.9	10.47	90.7	11.31	96.5	12.20	108.3	13.62	120.3	15.12
	14	61.2	7.48	73.1	9.04	84.9	10.69	90.7	11.54	96.5	12.43	108.3	13.88	120.3	15.43
	16	61.2	7.62	73.1	9.22	84.9	10.91	90.7	11.76	96.5	12.65	108.3	14.15	120.3	15.69
	18	61.2	7.75	73.1	9.40	84.9	11.09	90.7	12.03	96.5	12.92	108.3	14.46	120.3	16.48
	20	61.2	7.88	73.1	9.58	84.9	11.31	90.7	12.25	96.5	13.41	108.3	15.47	120.3	17.27
	21	61.2	7.97	73.1	9.67	84.9	11.54	90.7	12.65	96.5	13.90	108.3	15.73	120.3	17.66
	23	61.2	8.15	73.1	10.07	84.9	12.34	90.7	13.58	96.5	14.88	108.3	16.68	118.6	18.49
	25	61.2	8.55	73.1	10.73	84.9	13.18	90.7	14.52	96.5	15.90	108.3	17.83	116.9	19.29
	27	61.2	9.13	73.1	11.45	84.9	14.07	90.7	15.50	96.5	17.01	108.3	18.96	115.2	20.19
	29	61.2	9.67	73.1	12.20	84.9	15.05	90.7	16.57	96.5	18.17	108.3	20.09	113.4	21.00
	31	61.2	10.29	73.1	13.01	84.9	16.03	90.7	17.64	96.5	19.38	108.3	21.08	111.7	21.81
	33	61.2	10.96	73.1	13.85	84.9	17.10	90.7	18.80	96.5	20.55	108.3	22.11	110.0	22.63
	35	61.2	11.63	73.1	14.70	84.9	18.17	90.7	20.04	96.5	21.78	106.5	23.37	108.3	23.91
	37	61.2	12.34	73.1	15.63	84.9	19.38	90.7	21.29	96.5	23.00	104.8	24.43	106.6	24.98
	39	61.2	13.06	73.1	16.63	84.9	20.51	90.7	22.66	96.5	24.19	103.1	25.76	104.9	26.07
	41	59.7	14.61	71.2	18.43	82.8	22.51	88.4	24.77	94.0	26.11	98.7	27.14	100.5	27.77
	43	58.2	15.77	69.4	19.91	80.7	24.59	86.2	26.68	91.7	27.99	94.7	29.07	96.4	29.42
46	54.5	17.76	65.1	22.69	75.6	28.01	80.8	30.25	83.3	31.11	86.4	31.91	88.1	31.95	
48	48.2	15.52	57.6	19.84	66.9	24.50	71.4	26.39	72.3	26.80	75.1	27.47	76.5	27.50	
80	10	54.3	6.12	64.8	7.36	75.3	8.63	80.7	9.31	86.1	9.99	96.5	11.40	106.9	12.37
	12	54.3	6.25	64.8	7.43	75.3	8.80	80.7	9.48	86.1	10.16	96.5	11.61	106.9	12.61
	14	54.3	6.34	64.8	7.61	75.3	8.93	80.7	9.65	86.1	10.33	96.5	11.82	106.9	12.85
	16	54.3	6.42	64.8	7.73	75.3	9.10	80.7	9.82	86.1	10.54	96.5	12.07	106.9	13.11
	18	54.3	6.55	64.8	7.87	75.3	9.27	80.7	9.99	86.1	10.75	96.5	12.28	106.9	13.39
	20	54.3	6.68	64.8	8.03	75.3	9.48	80.7	10.20	86.1	10.96	96.5	12.75	106.9	14.19
	21	54.3	6.71	64.8	8.12	75.3	9.56	80.7	10.33	86.1	11.22	96.5	13.15	106.9	14.56
	23	54.3	6.85	64.8	8.24	75.3	9.99	80.7	10.96	86.1	11.98	96.5	13.89	106.9	15.28
	25	54.3	7.10	64.8	8.80	75.3	10.71	80.7	11.73	86.1	12.84	96.5	14.86	106.9	16.34
	27	54.3	7.52	64.8	9.35	75.3	11.44	80.7	12.54	86.1	13.69	96.5	15.80	106.9	17.19
	29	54.3	7.99	64.8	9.99	75.3	12.16	80.7	13.35	86.1	14.62	96.5	16.92	106.9	18.41
	31	54.3	8.50	64.8	10.59	75.3	12.97	80.7	14.24	86.1	15.56	96.5	17.96	106.9	19.32
	33	54.3	9.01	64.8	11.31	75.3	13.81	80.7	15.18	86.1	16.58	96.5	18.92	106.9	20.26
	35	54.3	9.56	64.8	11.98	75.3	14.71	80.7	16.16	86.1	17.69	96.5	20.06	105.8	20.99
	37	54.3	10.12	64.8	12.75	75.3	15.60	80.7	17.18	86.1	18.79	96.5	21.17	104.1	21.95
	39	54.3	10.69	64.8	13.47	75.3	16.69	80.7	18.47	86.1	20.19	96.5	22.37	102.3	23.15
	41	53.0	11.83	63.1	14.93	73.3	18.32	78.6	20.24	83.8	22.19	94.0	24.90	98.1	25.66
	43	51.6	13.02	61.6	16.29	71.5	20.00	76.6	22.06	81.8	24.25	91.7	26.64	94.0	27.48
46	48.4	14.49	57.7	18.35	67.0	22.52	71.8	24.55	76.6	27.36	83.8	29.08	85.8	29.55	
48	42.9	12.66	51.0	16.05	59.3	19.70	63.6	21.44	67.8	23.95	72.8	25.17	74.6	25.44	

Note

1. TC: Total Capacity(kW), PI : Power Input(kW, Comp. + Outdoor fan motor)
2. Capacity tables show the average value of conditions which may occur.

7. Capacity Tables

Combination (%)	Outdoor air temp (°C DB)	Cooling Capacity(36HP)													
		Indoor air temp. (DB/WB, °C)													
		20		23		26		27		28		30		32	
		14	16	18	19	20	22	24							
	TC	PI	TC	PI	TC	PI	TC	PI	TC	PI	TC	PI	TC	PI	
70	10	47.5	5.41	56.9	6.44	65.9	7.46	70.5	8.05	75.3	8.61	84.3	9.80	93.6	10.96
	12	47.5	5.50	56.9	6.52	65.9	7.62	70.5	8.18	75.3	8.78	84.3	9.97	93.6	11.16
	14	47.5	5.59	56.9	6.60	65.9	7.76	70.5	8.31	75.3	8.90	84.3	10.19	93.6	11.37
	16	47.5	5.66	56.9	6.73	65.9	7.88	70.5	8.48	75.3	9.08	84.3	10.36	93.6	11.62
	18	47.5	5.75	56.9	6.86	65.9	8.05	70.5	8.65	75.3	9.25	84.3	10.52	93.6	11.83
	20	47.5	5.83	56.9	6.99	65.9	8.18	70.5	8.82	75.3	9.46	84.3	10.78	93.6	12.27
	21	47.5	5.92	56.9	7.03	65.9	8.26	70.5	8.90	75.3	9.55	84.3	10.95	93.6	12.53
	23	47.5	6.01	56.9	7.20	65.9	8.44	70.5	9.20	75.3	10.01	84.3	11.72	93.6	13.23
	25	47.5	6.09	56.9	7.46	65.9	8.99	70.5	9.84	75.3	10.69	84.3	12.53	93.6	13.88
	27	47.5	6.44	56.9	7.97	65.9	9.58	70.5	10.44	75.3	11.42	84.3	13.38	93.6	14.74
	29	47.5	6.86	56.9	8.44	65.9	10.19	70.5	11.12	75.3	12.15	84.3	14.27	93.6	15.79
	31	47.5	7.29	56.9	8.99	65.9	10.87	70.5	11.89	75.3	12.95	84.3	15.21	93.6	16.76
	33	47.5	7.71	56.9	9.50	65.9	11.54	70.5	12.62	75.3	13.76	84.3	16.19	93.6	17.84
	35	47.5	8.14	56.9	10.14	65.9	12.27	70.5	13.42	75.3	14.65	84.3	17.26	93.6	18.92
	37	47.5	8.65	56.9	10.74	65.9	13.04	70.5	14.27	75.3	15.59	84.3	18.36	93.6	19.97
	39	47.5	9.19	56.9	11.45	65.9	13.94	70.5	15.35	75.3	16.84	84.3	19.65	93.6	21.53
	41	46.3	10.16	55.4	12.54	64.2	15.29	68.7	16.84	73.3	18.31	82.1	21.59	91.2	23.23
	43	45.2	11.05	54.0	13.68	62.6	16.69	67.1	18.37	71.5	20.00	80.1	23.58	88.9	25.11
	46	42.3	12.28	50.7	15.38	58.7	18.80	62.8	20.46	67.0	22.55	75.0	26.60	83.4	27.99
48	37.5	10.72	44.8	13.44	51.9	16.43	55.6	17.88	59.3	19.72	66.3	23.28	73.8	24.22	
60	10	40.7	4.70	48.6	5.51	56.5	6.40	60.5	6.88	64.5	7.31	72.3	8.29	80.3	9.27
	12	40.7	4.78	48.6	5.59	56.5	6.49	60.5	6.96	64.5	7.43	72.3	8.41	80.3	9.44
	14	40.7	4.82	48.6	5.68	56.5	6.62	60.5	7.09	64.5	7.56	72.3	8.58	80.3	9.61
	16	40.7	4.91	48.6	5.81	56.5	6.71	60.5	7.22	64.5	7.73	72.3	8.75	80.3	9.78
	18	40.7	4.99	48.6	5.90	56.5	6.83	60.5	7.34	64.5	7.86	72.3	8.88	80.3	10.00
	20	40.7	5.08	48.6	5.98	56.5	6.96	60.5	7.48	64.5	7.99	72.3	9.06	80.3	10.21
	21	40.7	5.13	48.6	6.02	56.5	7.05	60.5	7.56	64.5	8.08	72.3	9.18	80.3	10.29
	23	40.7	5.21	48.6	6.15	56.5	7.13	60.5	7.69	64.5	8.25	72.3	9.52	80.3	10.93
	25	40.7	5.30	48.6	6.28	56.5	7.43	60.5	8.08	64.5	8.75	72.3	10.17	80.3	11.70
	27	40.7	5.47	48.6	6.62	56.5	7.91	60.5	8.58	64.5	9.31	72.3	10.81	80.3	12.47
	29	40.7	5.81	48.6	7.05	56.5	8.41	60.5	9.14	64.5	9.91	72.3	11.53	80.3	13.33
	31	40.7	6.15	48.6	7.48	56.5	8.92	60.5	9.74	64.5	10.55	72.3	12.30	80.3	14.18
	33	40.7	6.49	48.6	7.91	56.5	9.48	60.5	10.34	64.5	11.23	72.3	13.07	80.3	15.12
	35	40.7	6.88	48.6	8.41	56.5	10.08	60.5	10.98	64.5	11.92	72.3	13.93	80.3	16.06
	37	40.7	7.26	48.6	8.88	56.5	10.67	60.5	11.66	64.5	12.64	72.3	14.77	80.3	17.08
	39	40.7	7.72	48.6	9.46	56.5	11.52	60.5	12.51	64.5	13.61	72.3	15.85	80.3	18.31
	41	39.6	8.37	47.4	10.35	55.1	12.52	58.9	13.67	62.8	14.77	70.5	17.39	78.3	19.89
	43	38.7	9.10	46.2	11.26	53.7	13.64	57.5	14.89	61.2	16.11	68.7	18.98	76.3	21.73
	46	36.3	10.20	43.3	12.65	50.4	15.34	53.9	16.74	57.4	18.12	64.5	21.39	71.5	24.76
48	32.1	8.88	38.3	11.04	44.5	13.41	47.7	14.62	50.7	15.83	57.0	18.71	63.3	21.66	
50	10	34.0	4.07	40.7	4.71	47.1	5.36	50.4	5.73	53.7	6.08	60.1	6.85	66.9	7.62
	12	34.0	4.11	40.7	4.75	47.1	5.44	50.4	5.82	53.7	6.21	60.1	6.98	66.9	7.75
	14	34.0	4.15	40.7	4.83	47.1	5.53	50.4	5.90	53.7	6.29	60.1	7.07	66.9	7.88
	16	34.0	4.24	40.7	4.92	47.1	5.61	50.4	6.04	53.7	6.38	60.1	7.19	66.9	8.00
	18	34.0	4.28	40.7	4.97	47.1	5.70	50.4	6.12	53.7	6.51	60.1	7.32	66.9	8.17
	20	34.0	4.32	40.7	5.05	47.1	5.82	50.4	6.21	53.7	6.63	60.1	7.45	66.9	8.34
	21	34.0	4.37	40.7	5.09	47.1	5.87	50.4	6.29	53.7	6.68	60.1	7.53	66.9	8.43
	23	34.0	4.46	40.7	5.18	47.1	5.95	50.4	6.38	53.7	6.80	60.1	7.66	66.9	8.60
	25	34.0	4.49	40.7	5.27	47.1	6.08	50.4	6.51	53.7	7.02	60.1	8.05	66.9	9.21
	27	34.0	4.58	40.7	5.44	47.1	6.42	50.4	6.93	53.7	7.45	60.1	8.60	66.9	9.80
	29	34.0	4.83	40.7	5.78	47.1	6.80	50.4	7.36	53.7	7.92	60.1	9.12	66.9	10.41
	31	34.0	5.09	40.7	6.12	47.1	7.24	50.4	7.80	53.7	8.43	60.1	9.72	66.9	11.09
	33	34.0	5.39	40.7	6.46	47.1	7.66	50.4	8.26	53.7	8.95	60.1	10.31	66.9	11.82
	35	34.0	5.70	40.7	6.85	47.1	8.09	50.4	8.78	53.7	9.46	60.1	10.92	66.9	12.55
	37	34.0	6.04	40.7	7.24	47.1	8.56	50.4	9.29	53.7	10.02	60.1	11.65	66.9	13.31
	39	34.0	6.44	40.7	7.75	47.1	9.18	50.4	10.00	53.7	10.75	60.1	12.40	66.9	14.38
	41	33.1	6.96	39.6	8.39	45.9	10.03	49.1	10.83	52.2	11.65	58.6	13.59	65.2	15.61
	43	32.4	7.57	38.7	9.13	44.8	10.92	47.9	11.79	51.0	12.68	57.1	14.82	63.6	17.04
	46	30.3	8.48	36.3	10.24	42.0	12.24	44.9	13.25	47.7	14.23	53.5	16.68	59.7	19.18
48	26.8	7.38	32.1	8.93	37.2	10.68	39.7	11.56	42.3	12.42	47.4	14.57	52.8	16.76	

Note

1. TC: Total Capacity(kW), PI : Power Input(kW, Comp. + Outdoor fan motor)
2. Capacity tables show the average value of conditions which may occur.

7. Capacity Tables

◆ A(C)RUN380LLS5

Combination (%)	Outdoor air temp (°C DB)	Indoor air temp. (DB/WB, °C)														Cooling Capacity(38HP)	
		20		23		26		27		28		30		32		TC	PI
		14		16		18		19		20		22		24			
		TC	PI	TC	PI	TC	PI	TC	PI	TC	PI	TC	PI	TC	PI		
130	10	105.4	12.60	125.5	15.39	134.5	17.86	138.4	18.22	142.2	18.38	149.1	18.52	152.9	18.59		
	12	105.4	12.91	125.5	15.95	134.5	18.59	138.4	18.72	142.2	18.86	149.1	19.02	152.9	19.19		
	14	105.4	13.35	125.5	16.52	134.5	19.29	138.4	19.43	142.2	19.59	149.1	19.75	152.9	19.92		
	16	105.4	13.83	125.5	17.10	134.5	20.16	138.4	20.35	142.2	20.51	149.1	20.69	152.9	20.86		
	18	105.4	14.41	125.5	18.09	134.5	21.09	138.4	21.54	142.2	21.72	149.1	21.93	152.9	22.08		
	20	105.4	15.05	125.5	19.28	134.5	22.13	138.4	23.69	142.2	23.89	146.9	24.12	150.8	24.29		
	21	105.4	15.44	125.5	19.95	134.5	22.59	138.4	25.07	142.2	25.27	146.1	25.53	150.0	25.70		
	23	105.4	16.57	125.5	20.99	134.5	23.76	138.4	27.67	140.4	27.89	144.0	28.17	147.8	28.36		
	25	105.4	17.69	125.5	22.19	134.5	25.39	136.7	30.69	138.4	30.93	142.2	31.24	146.1	31.46		
	27	105.4	18.93	125.5	23.73	132.8	27.06	134.5	33.78	136.7	34.05	140.4	34.38	144.0	34.63		
	29	105.4	20.18	125.5	25.36	130.7	29.11	132.6	37.13	134.5	37.35	138.4	37.68	142.2	37.83		
	31	105.4	21.53	125.1	26.72	128.5	30.97	130.7	36.97	132.6	37.20	136.2	37.52	140.0	37.67		
	33	105.4	22.93	122.9	28.31	126.8	33.21	128.9	36.63	130.7	36.85	134.5	37.18	137.9	37.33		
	35	105.4	24.46	120.7	29.64	124.7	35.97	126.8	36.15	128.9	36.37	132.4	36.70	136.2	36.84		
	37	105.4	26.09	119.1	31.11	122.9	35.50	124.7	35.68	126.8	35.90	130.2	36.21	134.1	36.35		
	39	105.4	27.77	116.9	32.74	120.7	35.03	122.9	35.20	124.7	35.41	128.5	35.73	132.4	35.87		
	41	102.7	29.46	112.1	34.38	115.9	34.55	117.6	34.72	120.0	34.93	123.5	35.24	126.9	35.38		
	43	100.1	31.07	107.4	33.90	111.2	34.07	112.8	34.24	115.2	34.45	118.7	34.76	121.9	34.90		
46	93.8	33.26	98.0	33.20	101.6	33.36	103.2	33.53	105.3	33.73	108.6	34.03	111.6	34.17			
48	83.0	32.33	85.1	32.43	88.3	32.50	89.7	32.59	91.6	32.87	94.6	33.08	97.2	33.21			
120	10	95.3	11.34	113.4	13.89	123.9	16.52	127.7	17.85	131.4	18.13	138.6	18.20	141.9	18.35		
	12	95.3	11.64	113.4	14.37	123.9	17.18	127.7	18.22	131.4	18.80	138.6	19.03	141.9	19.18		
	14	95.3	12.04	113.4	14.85	123.9	17.88	127.7	18.92	131.4	19.49	138.6	19.78	141.9	19.93		
	16	95.3	12.48	113.4	15.46	123.9	18.56	127.7	19.62	131.4	20.39	138.6	20.65	141.9	20.80		
	18	95.3	12.96	113.4	16.16	123.9	19.31	127.7	20.66	131.4	21.43	138.6	21.68	141.9	21.86		
	20	95.3	13.45	113.4	17.13	123.9	20.35	127.7	21.73	131.4	22.57	138.6	22.87	141.9	23.05		
	21	95.3	13.86	113.4	17.75	123.9	20.92	127.7	22.38	131.4	23.32	138.6	23.62	141.9	23.80		
	23	95.3	14.82	113.4	18.99	123.9	22.41	127.7	23.78	131.4	24.86	138.6	25.10	141.9	25.30		
	25	95.3	15.84	113.4	20.35	123.9	23.63	127.7	25.35	131.4	26.66	136.9	26.87	140.3	27.09		
	27	95.3	16.91	113.4	21.75	123.9	25.16	127.7	27.09	131.4	28.64	134.9	28.84	138.2	29.07		
	29	95.3	18.03	113.4	23.22	123.9	26.47	127.7	28.98	129.3	30.53	132.7	30.99	136.5	31.24		
	31	95.3	19.22	113.4	24.80	123.9	27.84	126.0	31.04	127.7	32.75	131.1	33.33	134.3	33.60		
	33	95.3	20.46	113.4	26.43	122.2	29.44	123.9	33.70	125.6	35.17	128.9	35.57	132.3	35.85		
	35	95.3	21.75	113.4	28.17	120.1	31.17	121.8	37.13	123.9	37.31	127.3	37.42	130.6	37.72		
	37	95.3	23.40	113.4	29.73	118.4	33.23	120.1	36.34	121.8	36.53	125.1	36.64	128.6	36.93		
	39	95.3	25.19	113.0	31.43	116.3	35.24	118.1	35.60	119.7	35.78	123.5	35.88	126.9	36.17		
	41	92.9	26.99	108.0	33.11	111.7	34.55	113.3	34.85	114.9	35.03	118.2	35.13	121.6	35.41		
	43	90.6	28.80	103.5	32.64	107.1	33.78	108.6	34.10	110.2	34.27	113.5	34.38	116.8	34.65		
46	84.9	30.97	94.4	31.87	97.8	32.71	99.2	32.98	100.8	33.15	103.8	33.25	106.9	33.51			
48	75.1	30.33	82.0	31.30	85.0	32.08	86.4	32.27	87.7	32.37	90.3	32.50	93.1	32.64			
110	10	85.4	10.20	101.9	12.42	113.7	14.76	117.1	15.98	124.4	17.19	127.3	17.68	135.9	17.96		
	12	85.4	10.51	101.9	12.85	113.7	15.38	117.1	16.42	124.4	17.84	127.3	18.42	135.9	18.84		
	14	85.4	10.84	101.9	13.42	113.7	16.07	117.1	17.24	124.4	18.74	127.3	19.27	135.9	19.68		
	16	85.4	11.22	101.9	13.91	113.7	16.73	117.1	17.99	124.4	19.60	127.3	20.13	135.9	20.49		
	18	85.4	11.64	101.9	14.49	113.7	17.69	117.1	18.95	124.4	20.68	127.3	21.09	135.9	21.48		
	20	85.4	12.05	101.9	15.22	113.7	18.76	117.1	19.82	124.4	21.68	127.3	22.22	135.9	22.57		
	21	85.4	12.32	101.9	15.66	113.7	19.25	117.1	20.35	124.4	22.29	127.3	22.85	135.9	23.20		
	23	85.4	13.13	101.9	16.79	113.7	20.32	117.1	21.49	124.4	23.55	127.3	24.05	135.9	24.45		
	25	85.4	14.04	101.9	17.92	113.7	21.47	117.1	22.72	124.4	24.87	127.3	25.23	134.3	25.75		
	27	85.4	14.99	101.9	19.16	113.7	22.69	117.1	24.04	124.4	25.97	127.3	26.57	132.3	27.03		
	29	85.4	16.01	101.9	20.46	113.7	23.97	117.1	25.46	124.4	27.46	127.3	27.93	130.6	28.35		
	31	85.4	17.02	101.9	21.81	113.7	25.33	117.1	26.97	122.4	28.84	125.7	29.41	128.6	29.72		
	33	85.4	18.15	101.9	23.22	113.7	26.77	117.1	28.59	120.7	30.46	123.6	30.97	126.9	31.14		
	35	85.4	19.28	101.9	24.80	113.7	28.27	117.1	30.29	118.7	32.15	121.6	32.44	124.8	32.61		
	37	85.4	20.43	101.9	26.32	113.7	29.84	115.4	32.09	116.6	33.91	120.0	34.03	122.8	34.13		
	39	85.4	22.02	101.9	27.97	111.7	31.49	113.3	34.33	115.0	35.58	117.8	35.65	121.2	35.68		
	41	83.3	23.62	99.2	29.61	107.0	33.21	108.6	37.13	110.0	37.13	113.3	37.42	116.0	37.72		
	43	81.1	24.80	96.8	30.86	102.5	35.21	104.2	35.61	105.5	35.54	108.6	35.74	111.4	35.84		
46	76.1	24.20	90.7	29.79	93.5	33.42	95.1	33.42	96.3	33.71	99.3	33.90	101.9	33.98			
48	67.3	23.50	78.8	28.70	81.2	31.80	82.7	32.01	83.8	32.17	86.4	32.26	88.6	32.38			

Note
 1. TC: Total Capacity(kW), PI : Power Input(kW, Comp. + Outdoor fan motor)
 2. Capacity tables show the average value of conditions which may occur.

7. Capacity Tables

Combination (%)	Outdoor air temp (°C DB)	Cooling Capacity(38HP)													
		Indoor air temp. (DB/WB, °C)													
		20		23		26		27		28		30		32	
		14	16	18	19	20	22	24							
	TC	PI	TC	PI	TC	PI	TC	PI	TC	PI	TC	PI	TC	PI	
100	10	71.8	9.18	85.5	11.15	99.5	13.24	106.4	14.31	113.3	15.37	125.5	17.11	128.3	17.25
	12	71.8	9.48	85.5	11.61	99.5	13.68	106.4	14.69	113.3	15.86	125.5	18.03	128.3	18.21
	14	71.8	9.77	85.5	12.08	99.5	14.26	106.4	15.32	113.3	16.55	125.5	19.03	128.3	19.22
	16	71.8	10.07	85.5	12.48	99.5	14.87	106.4	16.05	113.3	17.43	125.5	19.96	128.3	20.23
	18	71.8	10.37	85.5	12.94	99.5	15.45	106.4	16.83	113.3	18.49	125.5	21.09	128.3	21.25
	20	71.8	10.74	85.5	13.43	99.5	16.35	106.4	18.03	113.3	19.78	125.5	22.09	128.3	22.27
	21	71.8	10.96	85.5	13.75	99.5	16.91	106.4	18.65	113.3	20.52	125.5	22.60	128.3	22.78
	23	71.8	11.61	85.5	14.71	99.5	18.15	106.4	20.01	113.3	21.98	125.5	23.66	128.3	23.86
	25	71.8	12.34	85.5	15.66	99.5	19.39	106.4	21.42	113.3	23.50	125.5	24.67	127.2	24.87
	27	71.8	13.19	85.5	16.74	99.5	20.73	106.4	22.88	113.3	24.99	123.1	25.83	125.7	26.04
	29	71.8	14.04	85.5	17.86	99.5	22.15	106.4	24.46	113.3	26.44	120.9	26.87	123.8	27.09
	31	71.8	14.99	85.5	19.05	99.5	23.62	106.4	26.09	113.3	27.79	119.0	27.91	121.9	28.14
	33	71.8	15.89	85.5	20.29	99.5	25.19	106.4	27.84	113.3	28.83	117.1	28.96	120.0	29.19
	35	71.8	16.91	85.5	21.59	99.5	26.83	106.4	29.70	111.5	29.87	115.0	30.00	117.9	30.23
	37	71.8	18.11	85.5	23.15	99.5	28.42	106.4	31.11	109.6	31.27	112.8	31.40	115.5	31.68
	39	71.8	19.42	85.5	24.87	99.5	30.11	106.4	32.64	107.9	32.78	111.1	32.90	113.6	33.21
	41	70.7	20.72	84.2	26.59	97.9	31.81	102.1	34.16	104.3	34.30	106.8	34.41	110.2	34.74
	43	68.3	21.93	81.3	28.19	94.6	33.33	97.9	35.47	99.0	35.58	102.0	35.71	104.8	36.04
46	64.0	23.59	76.1	30.39	88.7	35.35	89.4	37.13	90.3	37.24	93.2	37.34	95.7	37.70	
48	56.6	20.36	67.4	26.29	76.6	30.22	77.6	31.50	78.5	31.60	81.1	31.67	83.3	31.93	
90	10	64.6	7.95	77.2	9.55	89.7	11.26	95.7	12.14	101.9	13.07	114.4	14.62	126.9	16.26
	12	64.6	8.04	77.2	9.70	89.7	11.46	95.7	12.38	101.9	13.35	114.4	14.91	126.9	16.55
	14	64.6	8.19	77.2	9.89	89.7	11.70	95.7	12.63	101.9	13.60	114.4	15.20	126.9	16.89
	16	64.6	8.34	77.2	10.09	89.7	11.94	95.7	12.87	101.9	13.85	114.4	15.49	126.9	17.17
	18	64.6	8.48	77.2	10.29	89.7	12.14	95.7	13.17	101.9	14.14	114.4	15.83	126.9	18.04
	20	64.6	8.62	77.2	10.48	89.7	12.38	95.7	13.41	101.9	14.68	114.4	16.94	126.9	18.90
	21	64.6	8.72	77.2	10.58	89.7	12.63	95.7	13.85	101.9	15.21	114.4	17.22	126.9	19.34
	23	64.6	8.92	77.2	11.02	89.7	13.51	95.7	14.86	101.9	16.29	114.4	18.26	125.1	20.25
	25	64.6	9.36	77.2	11.74	89.7	14.43	95.7	15.89	101.9	17.40	114.4	19.52	123.4	21.11
	27	64.6	9.99	77.2	12.53	89.7	15.40	95.7	16.96	101.9	18.62	114.4	20.75	121.6	22.10
	29	64.6	10.58	77.2	13.35	89.7	16.47	95.7	18.14	101.9	19.89	114.4	21.99	119.7	22.99
	31	64.6	11.26	77.2	14.24	89.7	17.55	95.7	19.31	101.9	21.21	114.4	23.08	117.9	23.88
	33	64.6	12.00	77.2	15.16	89.7	18.72	95.7	20.58	101.9	22.49	114.4	24.20	116.2	24.77
	35	64.6	12.73	77.2	16.09	89.7	19.89	95.7	21.93	101.9	23.85	112.4	25.58	114.3	26.18
	37	64.6	13.51	77.2	17.11	89.7	21.21	95.7	23.30	101.9	25.18	110.6	26.75	112.5	27.35
	39	64.6	14.29	77.2	18.20	89.7	22.45	95.7	24.80	101.9	26.48	108.8	28.20	110.7	28.54
	41	63.0	16.00	75.1	20.18	87.4	24.64	93.3	27.12	99.2	28.59	104.2	29.71	106.1	30.40
	43	61.4	17.27	73.3	21.80	85.2	26.91	91.0	29.21	96.8	30.65	100.0	31.82	101.7	32.21
46	57.6	19.44	68.7	24.83	79.8	30.67	85.3	33.12	88.0	34.05	91.2	34.93	93.0	34.98	
48	50.9	16.99	60.8	21.72	70.6	26.82	75.4	28.89	76.3	29.34	79.3	30.07	80.8	30.11	
80	10	57.4	6.69	68.4	8.05	79.4	9.44	85.1	10.19	90.8	10.93	101.9	12.47	112.8	13.53
	12	57.4	6.84	68.4	8.13	79.4	9.63	85.1	10.37	90.8	11.11	101.9	12.70	112.8	13.80
	14	57.4	6.93	68.4	8.32	79.4	9.76	85.1	10.55	90.8	11.30	101.9	12.93	112.8	14.06
	16	57.4	7.02	68.4	8.46	79.4	9.95	85.1	10.74	90.8	11.53	101.9	13.21	112.8	14.34
	18	57.4	7.17	68.4	8.61	79.4	10.14	85.1	10.93	90.8	11.76	101.9	13.44	112.8	14.65
	20	57.4	7.30	68.4	8.79	79.4	10.37	85.1	11.16	90.8	12.00	101.9	13.95	112.8	15.52
	21	57.4	7.34	68.4	8.88	79.4	10.46	85.1	11.30	90.8	12.28	101.9	14.39	112.8	15.93
	23	57.4	7.49	68.4	9.02	79.4	10.93	85.1	12.00	90.8	13.11	101.9	15.20	112.8	16.72
	25	57.4	7.77	68.4	9.63	79.4	11.72	85.1	12.84	90.8	14.05	101.9	16.26	112.8	17.88
	27	57.4	8.23	68.4	10.23	79.4	12.51	85.1	13.72	90.8	14.97	101.9	17.28	112.8	18.81
	29	57.4	8.74	68.4	10.93	79.4	13.30	85.1	14.61	90.8	15.99	101.9	18.51	112.8	20.14
	31	57.4	9.30	68.4	11.58	79.4	14.18	85.1	15.58	90.8	17.03	101.9	19.65	112.8	21.14
	33	57.4	9.86	68.4	12.37	79.4	15.11	85.1	16.60	90.8	18.14	101.9	20.70	112.8	22.17
	35	57.4	10.46	68.4	13.11	79.4	16.09	85.1	17.68	90.8	19.35	101.9	21.95	111.7	22.97
	37	57.4	11.07	68.4	13.95	79.4	17.07	85.1	18.79	90.8	20.56	101.9	23.16	109.9	24.01
	39	57.4	11.70	68.4	14.74	79.4	18.25	85.1	20.20	90.8	22.09	101.9	24.47	108.0	25.33
	41	56.0	12.94	66.6	16.34	77.3	20.04	82.9	22.14	88.4	24.27	99.2	27.24	103.5	28.07
	43	54.5	14.25	65.0	17.82	75.4	21.88	80.8	24.13	86.4	26.53	96.8	29.15	99.2	30.06
46	51.1	15.85	60.9	20.08	70.7	24.64	75.8	26.86	80.8	29.93	88.5	31.81	90.6	32.33	
48	45.2	13.85	53.9	17.56	62.6	21.55	67.1	23.46	71.6	26.20	76.9	27.54	78.8	27.83	

Note

1. TC: Total Capacity(kW), PI : Power Input(kW, Comp. + Outdoor fan motor)
2. Capacity tables show the average value of conditions which may occur.

7. Capacity Tables

		Cooling Capacity(38HP)													
Combination (%)	Outdoor air temp (°C DB)	Indoor air temp. (DB/WB, °C)													
		20		23		26		27		28		30		32	
		14	16	18	19	20	22	24	TC	PI	TC	PI	TC	PI	
70	10	50.1	5.92	60.1	7.04	69.6	8.16	74.5	8.81	79.4	9.41	88.9	10.72	98.8	11.98
	12	50.1	6.01	60.1	7.13	69.6	8.33	74.5	8.94	79.4	9.60	88.9	10.90	98.8	12.21
	14	50.1	6.11	60.1	7.22	69.6	8.48	74.5	9.09	79.4	9.74	88.9	11.14	98.8	12.43
	16	50.1	6.19	60.1	7.36	69.6	8.62	74.5	9.28	79.4	9.92	88.9	11.33	98.8	12.70
	18	50.1	6.29	60.1	7.50	69.6	8.81	74.5	9.45	79.4	10.11	88.9	11.50	98.8	12.93
	20	50.1	6.38	60.1	7.64	69.6	8.94	74.5	9.64	79.4	10.34	88.9	11.79	98.8	13.42
	21	50.1	6.47	60.1	7.69	69.6	9.04	74.5	9.74	79.4	10.44	88.9	11.97	98.8	13.70
	23	50.1	6.57	60.1	7.87	69.6	9.22	74.5	10.06	79.4	10.95	88.9	12.81	98.8	14.47
	25	50.1	6.66	60.1	8.16	69.6	9.83	74.5	10.76	79.4	11.69	88.9	13.70	98.8	15.17
	27	50.1	7.04	60.1	8.71	69.6	10.48	74.5	11.41	79.4	12.49	88.9	14.63	98.8	16.12
	29	50.1	7.50	60.1	9.22	69.6	11.14	74.5	12.16	79.4	13.28	88.9	15.60	98.8	17.27
	31	50.1	7.97	60.1	9.83	69.6	11.88	74.5	13.00	79.4	14.16	88.9	16.63	98.8	18.32
	33	50.1	8.43	60.1	10.38	69.6	12.62	74.5	13.79	79.4	15.05	88.9	17.70	98.8	19.51
	35	50.1	8.90	60.1	11.09	69.6	13.42	74.5	14.67	79.4	16.02	88.9	18.87	98.8	20.69
	37	50.1	9.45	60.1	11.75	69.6	14.25	74.5	15.60	79.4	17.05	88.9	20.08	98.8	21.83
	39	50.1	10.05	60.1	12.52	69.6	15.24	74.5	16.79	79.4	18.42	88.9	21.49	98.8	23.54
	41	48.8	11.11	58.5	13.71	67.8	16.72	72.6	18.42	77.3	20.02	86.7	23.60	96.3	25.39
	43	47.7	12.08	57.0	14.95	66.1	18.25	70.8	20.08	75.4	21.87	84.5	25.78	93.8	27.45
46	44.7	13.43	53.5	16.81	62.0	20.55	66.3	22.37	70.7	24.65	79.2	29.08	88.0	30.60	
48	39.5	11.72	47.3	14.69	54.8	17.96	58.6	19.54	62.6	21.56	70.0	25.45	77.9	26.48	
60	10	43.0	5.13	51.3	6.02	59.6	7.00	63.9	7.51	68.0	7.98	76.4	9.05	84.8	10.12
	12	43.0	5.23	51.3	6.11	59.6	7.09	63.9	7.61	68.0	8.12	76.4	9.19	84.8	10.31
	14	43.0	5.27	51.3	6.21	59.6	7.23	63.9	7.74	68.0	8.26	76.4	9.38	84.8	10.50
	16	43.0	5.36	51.3	6.35	59.6	7.33	63.9	7.89	68.0	8.45	76.4	9.56	84.8	10.68
	18	43.0	5.46	51.3	6.44	59.6	7.46	63.9	8.02	68.0	8.59	76.4	9.71	84.8	10.92
	20	43.0	5.55	51.3	6.54	59.6	7.61	63.9	8.17	68.0	8.73	76.4	9.89	84.8	11.15
	21	43.0	5.60	51.3	6.58	59.6	7.70	63.9	8.26	68.0	8.82	76.4	10.03	84.8	11.25
	23	43.0	5.70	51.3	6.72	59.6	7.80	63.9	8.40	68.0	9.01	76.4	10.40	84.8	11.94
	25	43.0	5.79	51.3	6.86	59.6	8.12	63.9	8.82	68.0	9.56	76.4	11.11	84.8	12.78
	27	43.0	5.98	51.3	7.23	59.6	8.64	63.9	9.38	68.0	10.18	76.4	11.81	84.8	13.63
	29	43.0	6.35	51.3	7.70	59.6	9.19	63.9	9.99	68.0	10.83	76.4	12.60	84.8	14.56
	31	43.0	6.72	51.3	8.17	59.6	9.75	63.9	10.64	68.0	11.53	76.4	13.44	84.8	15.50
	33	43.0	7.09	51.3	8.64	59.6	10.36	63.9	11.30	68.0	12.27	76.4	14.28	84.8	16.52
	35	43.0	7.51	51.3	9.19	59.6	11.02	63.9	11.99	68.0	13.02	76.4	15.22	84.8	17.54
	37	43.0	7.93	51.3	9.70	59.6	11.66	63.9	12.74	68.0	13.81	76.4	16.14	84.8	18.67
	39	43.0	8.43	51.3	10.33	59.6	12.59	63.9	13.66	68.0	14.87	76.4	17.32	84.8	20.01
	41	41.8	9.15	50.0	11.31	58.2	13.68	62.2	14.93	66.2	16.13	74.4	19.00	82.6	21.74
	43	40.8	9.94	48.8	12.31	56.7	14.91	60.7	16.27	64.6	17.60	72.6	20.74	80.5	23.74
46	38.3	11.14	45.7	13.82	53.2	16.76	56.9	18.29	60.5	19.80	68.0	23.37	75.4	27.05	
48	33.8	9.71	40.5	12.06	47.0	14.65	50.3	15.97	53.6	17.30	60.2	20.44	66.8	23.67	
50	10	35.9	4.44	43.0	5.14	49.8	5.85	53.2	6.26	56.6	6.64	63.4	7.48	70.7	8.32
	12	35.9	4.48	43.0	5.19	49.8	5.94	53.2	6.35	56.6	6.78	63.4	7.62	70.7	8.46
	14	35.9	4.54	43.0	5.28	49.8	6.03	53.2	6.45	56.6	6.87	63.4	7.72	70.7	8.61
	16	35.9	4.63	43.0	5.37	49.8	6.13	53.2	6.59	56.6	6.96	63.4	7.85	70.7	8.74
	18	35.9	4.67	43.0	5.42	49.8	6.22	53.2	6.68	56.6	7.11	63.4	8.00	70.7	8.93
	20	35.9	4.72	43.0	5.52	49.8	6.35	53.2	6.78	56.6	7.24	63.4	8.13	70.7	9.11
	21	35.9	4.77	43.0	5.56	49.8	6.41	53.2	6.87	56.6	7.29	63.4	8.22	70.7	9.20
	23	35.9	4.87	43.0	5.66	49.8	6.50	53.2	6.96	56.6	7.43	63.4	8.37	70.7	9.39
	25	35.9	4.91	43.0	5.75	49.8	6.64	53.2	7.11	56.6	7.67	63.4	8.79	70.7	10.05
	27	35.9	5.00	43.0	5.94	49.8	7.01	53.2	7.57	56.6	8.13	63.4	9.39	70.7	10.70
	29	35.9	5.28	43.0	6.31	49.8	7.43	53.2	8.04	56.6	8.65	63.4	9.96	70.7	11.36
	31	35.9	5.56	43.0	6.68	49.8	7.90	53.2	8.51	56.6	9.20	63.4	10.61	70.7	12.11
	33	35.9	5.89	43.0	7.06	49.8	8.37	53.2	9.02	56.6	9.77	63.4	11.26	70.7	12.90
	35	35.9	6.22	43.0	7.48	49.8	8.83	53.2	9.59	56.6	10.33	63.4	11.92	70.7	13.70
	37	35.9	6.59	43.0	7.90	49.8	9.35	53.2	10.14	56.6	10.94	63.4	12.72	70.7	14.54
	39	35.9	7.03	43.0	8.47	49.8	10.02	53.2	10.92	56.6	11.74	63.4	13.55	70.7	15.70
	41	34.9	7.60	41.8	9.17	48.5	10.95	51.9	11.83	55.1	12.72	61.8	14.84	68.8	17.05
	43	34.1	8.27	40.8	9.97	47.3	11.92	50.6	12.88	53.8	13.85	60.3	16.19	67.2	18.60
46	32.0	9.26	38.3	11.19	44.3	13.37	47.4	14.46	50.4	15.54	56.5	18.21	63.0	20.94	
48	28.3	8.06	33.8	9.75	39.2	11.66	41.9	12.62	44.6	13.56	50.0	15.91	55.7	18.30	

Note

1. TC: Total Capacity(kW), PI : Power Input(kW, Comp. + Outdoor fan motor)
2. Capacity tables show the average value of conditions which may occur.

7. Capacity Tables

◆ A(C)RUN400LLS5

Combination (%)	Outdoor air temp (°C DB)	Indoor air temp. (DB/WB, °C)														Cooling Capacity(40HP)	
		20		23		26		27		28		30		32		TC	PI
		14		16		18		19		20		22		24			
		TC	PI	TC	PI	TC	PI	TC	PI	TC	PI	TC	PI	TC	PI		
130	10	110.9	13.32	132.1	16.28	141.6	18.89	145.7	19.26	149.7	19.43	156.9	19.58	160.9	19.65		
	12	110.9	13.65	132.1	16.86	141.6	19.66	145.7	19.79	149.7	19.94	156.9	20.11	160.9	20.29		
	14	110.9	14.11	132.1	17.47	141.6	20.40	145.7	20.55	149.7	20.71	156.9	20.88	160.9	21.06		
	16	110.9	14.63	132.1	18.08	141.6	21.32	145.7	21.51	149.7	21.68	156.9	21.88	160.9	22.05		
	18	110.9	15.23	132.1	19.13	141.6	22.30	145.7	22.78	149.7	22.96	156.9	23.19	160.9	23.34		
	20	110.9	15.91	132.1	20.38	141.6	23.40	145.7	25.05	149.7	25.25	154.6	25.50	158.7	25.68		
	21	110.9	16.32	132.1	21.09	141.6	23.88	145.7	26.51	149.7	26.72	153.8	26.99	157.8	27.17		
	23	110.9	17.51	132.1	22.19	141.6	25.12	145.7	29.25	147.8	29.48	151.5	29.78	155.5	29.98		
	25	110.9	18.71	132.1	23.46	141.6	26.84	143.9	32.44	145.7	32.70	149.7	33.03	153.8	33.26		
	27	110.9	20.02	132.1	25.09	139.8	28.61	141.6	35.72	143.9	36.00	147.8	36.35	151.5	36.61		
	29	110.9	21.33	132.1	26.81	137.5	30.78	139.5	39.25	141.6	39.49	145.7	39.84	149.7	39.99		
	31	110.9	22.76	131.7	28.25	135.2	32.74	137.5	39.08	139.5	39.32	143.4	39.67	147.4	39.83		
	33	110.9	24.25	129.4	29.93	133.5	35.11	135.7	38.72	137.5	38.96	141.6	39.31	145.2	39.46		
	35	110.9	25.86	127.1	31.34	131.2	38.03	133.5	38.22	135.7	38.45	139.4	38.80	143.4	38.95		
	37	110.9	27.58	125.4	32.89	129.4	37.53	131.2	37.72	133.5	37.95	137.1	38.28	141.2	38.44		
	39	110.9	29.36	123.1	34.62	127.1	37.03	129.4	37.21	131.2	37.44	135.2	37.77	139.4	37.92		
	41	108.1	31.15	118.0	36.35	122.0	36.53	123.8	36.71	126.3	36.93	130.0	37.26	133.5	37.41		
	43	105.4	32.85	113.1	35.84	117.1	36.02	118.8	36.20	121.2	36.43	124.9	36.75	128.3	36.89		
46	98.8	35.16	103.2	35.10	106.9	35.27	108.6	35.45	110.8	35.66	114.3	35.98	117.5	36.12			
48	87.4	34.18	89.6	34.28	92.9	34.36	94.4	34.45	96.5	34.75	99.5	34.98	102.3	35.11			
120	10	100.3	11.99	119.4	14.69	130.5	17.46	134.4	18.87	138.3	19.17	145.9	19.25	149.4	19.40		
	12	100.3	12.30	119.4	15.19	130.5	18.16	134.4	19.26	138.3	19.88	145.9	20.12	149.4	20.28		
	14	100.3	12.73	119.4	15.70	130.5	18.90	134.4	20.00	138.3	20.61	145.9	20.91	149.4	21.08		
	16	100.3	13.19	119.4	16.35	130.5	19.63	134.4	20.74	138.3	21.56	145.9	21.83	149.4	22.00		
	18	100.3	13.71	119.4	17.09	130.5	20.41	134.4	21.84	138.3	22.66	145.9	22.92	149.4	23.11		
	20	100.3	14.22	119.4	18.11	130.5	21.51	134.4	22.98	138.3	23.87	145.9	24.18	149.4	24.37		
	21	100.3	14.66	119.4	18.77	130.5	22.11	134.4	23.66	138.3	24.65	145.9	24.97	149.4	25.16		
	23	100.3	15.67	119.4	20.08	130.5	23.69	134.4	25.14	138.3	26.28	145.9	26.54	149.4	26.75		
	25	100.3	16.74	119.4	21.51	130.5	24.99	134.4	26.80	138.3	28.18	144.2	28.41	147.7	28.64		
	27	100.3	17.87	119.4	22.99	130.5	26.60	134.4	28.64	138.3	30.28	142.0	30.49	145.5	30.73		
	29	100.3	19.07	119.4	24.55	130.5	27.99	134.4	30.64	136.2	32.28	139.7	32.76	143.7	33.03		
	31	100.3	20.32	119.4	26.22	130.5	29.44	132.6	32.82	134.4	34.63	138.0	35.24	141.4	35.52		
	33	100.3	21.63	119.4	27.94	128.6	31.13	130.5	35.63	132.2	37.18	135.7	37.60	139.2	37.90		
	35	100.3	22.99	119.4	29.79	126.5	32.95	128.2	39.25	130.5	39.45	134.0	39.57	137.5	39.88		
	37	100.3	24.74	119.4	31.43	124.6	35.13	126.5	38.42	128.2	38.62	131.7	38.74	135.4	39.04		
	39	100.3	26.63	118.9	33.23	122.5	37.26	124.3	37.63	126.0	37.83	130.0	37.94	133.5	38.24		
	41	97.8	28.53	113.7	35.01	117.6	36.53	119.2	36.85	120.9	37.03	124.5	37.14	128.0	37.44		
	43	95.4	30.45	108.9	34.51	112.8	35.71	114.3	36.05	116.0	36.23	119.5	36.35	122.9	36.64		
46	89.4	32.74	99.4	33.69	102.9	34.59	104.5	34.87	106.1	35.05	109.2	35.16	112.5	35.43			
48	79.1	32.07	86.3	33.09	89.5	33.92	90.9	34.12	92.3	34.22	95.1	34.36	98.0	34.51			
110	10	89.9	10.78	107.2	13.14	119.7	15.61	123.2	16.89	130.9	18.18	134.0	18.69	143.1	18.99		
	12	89.9	11.11	107.2	13.58	119.7	16.26	123.2	17.36	130.9	18.86	134.0	19.47	143.1	19.91		
	14	89.9	11.46	107.2	14.19	119.7	16.99	123.2	18.22	130.9	19.81	134.0	20.38	143.1	20.80		
	16	89.9	11.87	107.2	14.71	119.7	17.69	123.2	19.02	130.9	20.73	134.0	21.29	143.1	21.66		
	18	89.9	12.31	107.2	15.32	119.7	18.71	123.2	20.03	130.9	21.86	134.0	22.30	143.1	22.71		
	20	89.9	12.74	107.2	16.09	119.7	19.84	123.2	20.95	130.9	22.92	134.0	23.49	143.1	23.87		
	21	89.9	13.03	107.2	16.56	119.7	20.35	123.2	21.51	130.9	23.56	134.0	24.15	143.1	24.53		
	23	89.9	13.89	107.2	17.75	119.7	21.48	123.2	22.72	130.9	24.89	134.0	25.42	143.1	25.84		
	25	89.9	14.84	107.2	18.95	119.7	22.70	123.2	24.02	130.9	26.30	134.0	26.67	141.4	27.22		
	27	89.9	15.85	107.2	20.26	119.7	23.99	123.2	25.42	130.9	27.46	134.0	28.09	139.2	28.57		
	29	89.9	16.92	107.2	21.63	119.7	25.35	123.2	26.92	130.9	29.03	134.0	29.53	137.5	29.97		
	31	89.9	17.99	107.2	23.05	119.7	26.78	123.2	28.52	128.8	30.50	132.3	31.10	135.4	31.42		
	33	89.9	19.19	107.2	24.55	119.7	28.30	123.2	30.22	127.1	32.20	130.1	32.74	133.5	32.92		
	35	89.9	20.38	107.2	26.22	119.7	29.89	123.2	32.02	124.9	33.99	128.0	34.30	131.4	34.48		
	37	89.9	21.60	107.2	27.82	119.7	31.55	121.5	33.92	122.8	35.85	126.3	35.97	129.2	36.08		
	39	89.9	23.28	107.2	29.57	117.6	33.29	119.3	36.29	121.1	37.62	124.0	37.69	127.5	37.73		
	41	87.7	24.97	104.5	31.31	112.6	35.11	114.3	39.25	115.8	39.25	119.2	39.57	122.1	39.88		
	43	85.4	26.22	101.9	32.62	107.8	37.23	109.7	37.65	111.1	37.57	114.3	37.78	117.2	37.89		
46	80.1	25.59	95.5	31.49	98.4	35.34	100.1	35.34	101.4	35.64	104.5	35.84	107.2	35.93			
48	70.8	24.85	82.9	30.34	85.5	33.62	87.1	33.84	88.2	34.01	90.9	34.10	93.3	34.24			

Note
 1. TC: Total Capacity(kW), PI : Power Input(kW, Comp. + Outdoor fan motor)
 2. Capacity tables show the average value of conditions which may occur.

7. Capacity Tables

Combination (%)	Outdoor air temp (°C DB)	Cooling Capacity(40HP)													
		Indoor air temp. (DB/WB, °C)													
		20		23		26		27		28		30		32	
		14	16	18	19	20	22	24	TC	PI	TC	PI	TC	PI	
100	10	75.6	9.71	90.0	11.79	104.8	13.99	112.0	15.12	119.2	16.25	132.2	18.09	135.1	18.23
	12	75.6	10.02	90.0	12.28	104.8	14.46	112.0	15.53	119.2	16.77	132.2	19.06	135.1	19.25
	14	75.6	10.33	90.0	12.77	104.8	15.08	112.0	16.20	119.2	17.49	132.2	20.12	135.1	20.32
	16	75.6	10.64	90.0	13.19	104.8	15.72	112.0	16.97	119.2	18.43	132.2	21.10	135.1	21.39
	18	75.6	10.96	90.0	13.68	104.8	16.33	112.0	17.80	119.2	19.55	132.2	22.29	135.1	22.47
	20	75.6	11.35	90.0	14.20	104.8	17.28	112.0	19.07	119.2	20.91	132.2	23.36	135.1	23.55
	21	75.6	11.59	90.0	14.54	104.8	17.87	112.0	19.72	119.2	21.69	132.2	23.90	135.1	24.08
	23	75.6	12.27	90.0	15.55	104.8	19.19	112.0	21.15	119.2	23.23	132.2	25.02	135.1	25.22
	25	75.6	13.04	90.0	16.56	104.8	20.50	112.0	22.64	119.2	24.85	132.2	26.09	133.9	26.30
	27	75.6	13.95	90.0	17.69	104.8	21.92	112.0	24.19	119.2	26.42	129.6	27.31	132.3	27.53
	29	75.6	14.84	90.0	18.89	104.8	23.41	112.0	25.86	119.2	27.96	127.2	28.41	130.3	28.64
	31	75.6	15.85	90.0	20.14	104.8	24.97	112.0	27.58	119.2	29.38	125.2	29.51	128.3	29.75
	33	75.6	16.80	90.0	21.45	104.8	26.63	112.0	29.44	119.2	30.48	123.2	30.61	126.3	30.86
	35	75.6	17.87	90.0	22.82	104.8	28.36	112.0	31.40	117.4	31.58	121.1	31.72	124.1	31.96
	37	75.6	19.14	90.0	24.47	104.8	30.04	112.0	32.89	115.4	33.06	118.8	33.19	121.6	33.50
	39	75.6	20.53	90.0	26.30	104.8	31.84	112.0	34.51	113.5	34.66	116.9	34.78	119.6	35.11
	41	74.4	21.90	88.6	28.11	103.1	33.63	107.5	36.11	109.8	36.26	112.4	36.38	116.0	36.73
43	71.8	23.19	85.5	29.80	99.6	35.23	103.1	37.50	104.2	37.62	107.4	37.75	110.3	38.10	
46	67.4	24.94	80.2	32.12	93.4	37.38	94.1	39.25	95.1	39.37	98.2	39.48	100.8	39.85	
48	59.5	21.53	70.9	27.79	80.6	31.95	81.7	33.30	82.6	33.41	85.4	33.48	87.7	33.75	
90	10	68.0	8.33	81.2	10.01	94.4	11.80	100.8	12.72	107.2	13.69	120.4	15.32	133.6	17.04
	12	68.0	8.43	81.2	10.17	94.4	12.01	100.8	12.98	107.2	14.00	120.4	15.62	133.6	17.34
	14	68.0	8.59	81.2	10.37	94.4	12.26	100.8	13.23	107.2	14.25	120.4	15.93	133.6	17.70
	16	68.0	8.74	81.2	10.57	94.4	12.52	100.8	13.49	107.2	14.51	120.4	16.23	133.6	18.00
	18	68.0	8.89	81.2	10.78	94.4	12.72	100.8	13.80	107.2	14.82	120.4	16.59	133.6	18.91
	20	68.0	9.04	81.2	10.98	94.4	12.98	100.8	14.05	107.2	15.38	120.4	17.76	133.6	19.81
	21	68.0	9.14	81.2	11.08	94.4	13.23	100.8	14.51	107.2	15.94	120.4	18.04	133.6	20.26
	23	68.0	9.35	81.2	11.55	94.4	14.16	100.8	15.58	107.2	17.07	120.4	19.13	131.7	21.22
	25	68.0	9.81	81.2	12.31	94.4	15.13	100.8	16.65	107.2	18.24	120.4	20.46	129.9	22.12
	27	68.0	10.47	81.2	13.13	94.4	16.14	100.8	17.77	107.2	19.52	120.4	21.75	128.0	23.16
	29	68.0	11.08	81.2	14.00	94.4	17.27	100.8	19.01	107.2	20.85	120.4	23.04	126.0	24.09
	31	68.0	11.80	81.2	14.92	94.4	18.40	100.8	20.24	107.2	22.22	120.4	24.19	124.2	25.03
	33	68.0	12.57	81.2	15.89	94.4	19.62	100.8	21.56	107.2	23.57	120.4	25.36	122.3	25.96
	35	68.0	13.34	81.2	16.86	94.4	20.85	100.8	22.99	107.2	25.00	118.3	26.81	120.3	27.43
	37	68.0	14.16	81.2	17.94	94.4	22.22	100.8	24.42	107.2	26.39	116.4	28.03	118.5	28.66
	39	68.0	14.98	81.2	19.07	94.4	23.52	100.8	25.99	107.2	27.75	114.5	29.56	116.5	29.91
	41	66.3	16.77	79.1	21.15	92.0	25.82	98.2	28.42	104.5	29.96	109.7	31.14	111.7	31.86
43	64.6	18.10	77.2	22.85	89.7	28.20	95.8	30.61	101.9	32.12	105.2	33.35	107.1	33.75	
46	60.6	20.37	72.3	26.02	84.0	32.14	89.8	34.71	92.6	35.68	96.0	36.61	97.8	36.66	
48	53.6	17.80	64.0	22.76	74.3	28.11	79.4	30.27	80.3	30.75	83.5	31.51	85.1	31.56	
80	10	60.4	6.96	72.0	8.37	83.6	9.82	89.6	10.60	95.6	11.37	107.2	12.97	118.8	14.08
	12	60.4	7.11	72.0	8.46	83.6	10.02	89.6	10.78	95.6	11.56	107.2	13.21	118.8	14.36
	14	60.4	7.20	72.0	8.66	83.6	10.15	89.6	10.98	95.6	11.75	107.2	13.45	118.8	14.63
	16	60.4	7.31	72.0	8.80	83.6	10.35	89.6	11.17	95.6	11.99	107.2	13.74	118.8	14.91
	18	60.4	7.45	72.0	8.95	83.6	10.54	89.6	11.37	95.6	12.24	107.2	13.98	118.8	15.24
	20	60.4	7.59	72.0	9.15	83.6	10.78	89.6	11.61	95.6	12.49	107.2	14.51	118.8	16.14
	21	60.4	7.64	72.0	9.24	83.6	10.89	89.6	11.75	95.6	12.77	107.2	14.97	118.8	16.57
	23	60.4	7.79	72.0	9.39	83.6	11.37	89.6	12.49	95.6	13.64	107.2	15.81	118.8	17.40
	25	60.4	8.08	72.0	10.02	83.6	12.19	89.6	13.35	95.6	14.61	107.2	16.92	118.8	18.60
	27	60.4	8.56	72.0	10.64	83.6	13.01	89.6	14.27	95.6	15.57	107.2	17.97	118.8	19.57
	29	60.4	9.09	72.0	11.37	83.6	13.84	89.6	15.20	95.6	16.64	107.2	19.26	118.8	20.95
	31	60.4	9.67	72.0	12.04	83.6	14.75	89.6	16.20	95.6	17.71	107.2	20.44	118.8	21.99
	33	60.4	10.26	72.0	12.86	83.6	15.72	89.6	17.27	95.6	18.87	107.2	21.53	118.8	23.06
	35	60.4	10.89	72.0	13.64	83.6	16.74	89.6	18.39	95.6	20.12	107.2	22.83	117.5	23.89
	37	60.4	11.51	72.0	14.51	83.6	17.76	89.6	19.54	95.6	21.38	107.2	24.09	115.7	24.98
	39	60.4	12.17	72.0	15.33	83.6	18.99	89.6	21.01	95.6	22.98	107.2	25.46	113.7	26.35
	41	58.9	13.46	70.2	16.99	81.4	20.84	87.3	23.03	93.1	25.25	104.5	28.33	108.9	29.20
43	57.4	14.82	68.4	18.54	79.4	22.76	85.1	25.10	90.9	27.59	101.9	30.32	104.5	31.26	
46	53.8	16.49	64.1	20.89	74.5	25.63	79.8	27.94	85.1	31.13	93.2	33.09	95.4	33.63	
48	47.6	14.40	56.8	18.27	65.9	22.42	70.6	24.40	75.4	27.25	80.9	28.64	82.9	28.94	

Note
1. TC: Total Capacity(kW), PI : Power Input(kW, Comp. + Outdoor fan motor)
2. Capacity tables show the average value of conditions which may occur.

7. Capacity Tables

Combination (%)	Outdoor air temp (°C DB)	Cooling Capacity(40HP)													
		Indoor air temp. (DB/WB, °C)													
		20		23		26		27		28		30		32	
		14	16	18	19	20	22	24							
	TC	PI	TC	PI	TC	PI	TC	PI	TC	PI	TC	PI	TC	PI	
70	10	52.8	6.11	63.2	7.26	73.2	8.42	78.4	9.09	83.6	9.71	93.6	11.06	104.0	12.37
	12	52.8	6.20	63.2	7.36	73.2	8.60	78.4	9.23	83.6	9.91	93.6	11.26	104.0	12.61
	14	52.8	6.30	63.2	7.46	73.2	8.75	78.4	9.38	83.6	10.06	93.6	11.50	104.0	12.84
	16	52.8	6.40	63.2	7.60	73.2	8.90	78.4	9.58	83.6	10.24	93.6	11.69	104.0	13.11
	18	52.8	6.50	63.2	7.75	73.2	9.09	78.4	9.76	83.6	10.43	93.6	11.88	104.0	13.34
	20	52.8	6.59	63.2	7.88	73.2	9.23	78.4	9.95	83.6	10.67	93.6	12.17	104.0	13.85
	21	52.8	6.68	63.2	7.94	73.2	9.34	78.4	10.06	83.6	10.78	93.6	12.36	104.0	14.14
	23	52.8	6.78	63.2	8.12	73.2	9.52	78.4	10.39	83.6	11.30	93.6	13.23	104.0	14.94
	25	52.8	6.88	63.2	8.42	73.2	10.15	78.4	11.11	83.6	12.07	93.6	14.14	104.0	15.66
	27	52.8	7.26	63.2	8.99	73.2	10.82	78.4	11.78	83.6	12.89	93.6	15.10	104.0	16.65
	29	52.8	7.75	63.2	9.52	73.2	11.50	78.4	12.55	83.6	13.71	93.6	16.11	104.0	17.83
	31	52.8	8.23	63.2	10.15	73.2	12.26	78.4	13.42	83.6	14.62	93.6	17.17	104.0	18.92
	33	52.8	8.71	63.2	10.72	73.2	13.03	78.4	14.23	83.6	15.54	93.6	18.27	104.0	20.14
	35	52.8	9.19	63.2	11.45	73.2	13.85	78.4	15.15	83.6	16.54	93.6	19.48	104.0	21.36
	37	52.8	9.76	63.2	12.13	73.2	14.71	78.4	16.11	83.6	17.61	93.6	20.73	104.0	22.53
	39	52.8	10.37	63.2	12.93	73.2	15.73	78.4	17.34	83.6	19.02	93.6	22.19	104.0	24.30
	41	51.4	11.47	61.6	14.16	71.4	17.26	76.4	19.02	81.4	20.67	91.2	24.36	101.4	26.21
	43	50.2	12.48	60.0	15.43	69.5	18.84	74.5	20.73	79.4	22.58	88.9	26.62	98.8	28.34
46	47.1	13.87	56.3	17.35	65.2	21.21	69.8	23.09	74.5	25.45	83.4	30.02	92.6	31.59	
48	41.6	12.10	49.8	15.16	57.7	18.54	61.7	20.18	65.9	22.26	73.7	26.27	82.0	27.34	
60	10	45.2	5.26	54.0	6.17	62.8	7.18	67.2	7.69	71.6	8.17	80.4	9.27	89.2	10.37
	12	45.2	5.36	54.0	6.26	62.8	7.27	67.2	7.80	71.6	8.32	80.4	9.42	89.2	10.57
	14	45.2	5.40	54.0	6.36	62.8	7.41	67.2	7.93	71.6	8.46	80.4	9.62	89.2	10.76
	16	45.2	5.50	54.0	6.50	62.8	7.51	67.2	8.08	71.6	8.65	80.4	9.80	89.2	10.94
	18	45.2	5.60	54.0	6.59	62.8	7.65	67.2	8.22	71.6	8.80	80.4	9.95	89.2	11.18
	20	45.2	5.69	54.0	6.70	62.8	7.80	67.2	8.37	71.6	8.94	80.4	10.13	89.2	11.43
	21	45.2	5.74	54.0	6.74	62.8	7.89	67.2	8.46	71.6	9.03	80.4	10.28	89.2	11.53
	23	45.2	5.84	54.0	6.88	62.8	7.99	67.2	8.61	71.6	9.23	80.4	10.66	89.2	12.24
	25	45.2	5.93	54.0	7.03	62.8	8.32	67.2	9.03	71.6	9.80	80.4	11.38	89.2	13.10
	27	45.2	6.12	54.0	7.41	62.8	8.85	67.2	9.62	71.6	10.43	80.4	12.10	89.2	13.97
	29	45.2	6.50	54.0	7.89	62.8	9.42	67.2	10.23	71.6	11.09	80.4	12.91	89.2	14.92
	31	45.2	6.88	54.0	8.37	62.8	9.99	67.2	10.90	71.6	11.81	80.4	13.77	89.2	15.88
	33	45.2	7.27	54.0	8.85	62.8	10.61	67.2	11.57	71.6	12.57	80.4	14.63	89.2	16.93
	35	45.2	7.69	54.0	9.42	62.8	11.29	67.2	12.28	71.6	13.34	80.4	15.59	89.2	17.97
	37	45.2	8.13	54.0	9.94	62.8	11.95	67.2	13.05	71.6	14.15	80.4	16.54	89.2	19.13
	39	45.2	8.64	54.0	10.58	62.8	12.90	67.2	14.00	71.6	15.23	80.4	17.74	89.2	20.50
	41	44.0	9.38	52.6	11.59	61.2	14.01	65.5	15.29	69.7	16.53	78.3	19.46	86.9	22.27
	43	42.9	10.19	51.4	12.61	59.7	15.28	63.9	16.67	68.0	18.03	76.4	21.25	84.8	24.32
46	40.3	11.41	48.1	14.16	56.0	17.18	59.8	18.74	63.7	20.29	71.6	23.95	79.4	27.71	
48	35.6	9.95	42.6	12.36	49.5	15.01	52.9	16.36	56.4	17.73	63.4	20.94	70.3	24.25	
50	10	37.8	4.51	45.2	5.22	52.4	5.94	56.0	6.37	59.6	6.75	66.8	7.61	74.4	8.46
	12	37.8	4.56	45.2	5.28	52.4	6.04	56.0	6.46	59.6	6.90	66.8	7.74	74.4	8.60
	14	37.8	4.62	45.2	5.37	52.4	6.13	56.0	6.56	59.6	6.99	66.8	7.85	74.4	8.75
	16	37.8	4.71	45.2	5.46	52.4	6.23	56.0	6.70	59.6	7.08	66.8	7.98	74.4	8.89
	18	37.8	4.75	45.2	5.51	52.4	6.32	56.0	6.79	59.6	7.23	66.8	8.13	74.4	9.08
	20	37.8	4.80	45.2	5.61	52.4	6.46	56.0	6.90	59.6	7.37	66.8	8.27	74.4	9.27
	21	37.8	4.85	45.2	5.66	52.4	6.52	56.0	6.99	59.6	7.41	66.8	8.36	74.4	9.36
	23	37.8	4.95	45.2	5.75	52.4	6.61	56.0	7.08	59.6	7.56	66.8	8.51	74.4	9.55
	25	37.8	4.99	45.2	5.84	52.4	6.75	56.0	7.23	59.6	7.80	66.8	8.93	74.4	10.22
	27	37.8	5.09	45.2	6.04	52.4	7.13	56.0	7.70	59.6	8.27	66.8	9.55	74.4	10.88
	29	37.8	5.37	45.2	6.41	52.4	7.56	56.0	8.18	59.6	8.80	66.8	10.13	74.4	11.55
	31	37.8	5.66	45.2	6.79	52.4	8.03	56.0	8.65	59.6	9.36	66.8	10.79	74.4	12.31
	33	37.8	5.99	45.2	7.18	52.4	8.51	56.0	9.17	59.6	9.93	66.8	11.45	74.4	13.12
	35	37.8	6.32	45.2	7.61	52.4	8.98	56.0	9.75	59.6	10.50	66.8	12.12	74.4	13.93
	37	37.8	6.70	45.2	8.03	52.4	9.51	56.0	10.31	59.6	11.12	66.8	12.93	74.4	14.79
	39	37.8	7.15	45.2	8.61	52.4	10.19	56.0	11.11	59.6	11.94	66.8	13.78	74.4	15.97
	41	36.8	7.73	44.0	9.32	51.1	11.14	54.6	12.03	58.0	12.93	65.1	15.09	72.5	17.34
	43	35.9	8.40	42.9	10.14	49.8	12.12	53.2	13.10	56.6	14.08	63.5	16.46	70.7	18.91
46	33.7	9.41	40.3	11.38	46.6	13.60	49.9	14.70	53.1	15.80	59.5	18.52	66.3	21.29	
48	29.8	8.20	35.6	9.92	41.2	11.86	44.1	12.83	46.9	13.79	52.6	16.18	58.6	18.61	

Note
1. TC: Total Capacity(kW), PI : Power Input(kW, Comp. + Outdoor fan motor)
2. Capacity tables show the average value of conditions which may occur.

7. Capacity Tables

◆ A(C)RUN420LLS5

Combination (%)	Outdoor air temp (°C DB)	Indoor air temp. (DB/WB, °C)														Cooling Capacity(42HP)	
		20		23		26		27		28		30		32		TC	PI
		14		16		18		19		20		22		24			
		TC	PI	TC	PI	TC	PI	TC	PI	TC	PI	TC	PI	TC	PI		
130	10	116.5	13.87	138.7	16.95	148.6	19.67	153.0	20.06	157.2	20.23	164.8	20.39	169.0	20.47		
	12	116.5	14.21	138.7	17.56	148.6	20.47	153.0	20.61	157.2	20.77	164.8	20.94	169.0	21.13		
	14	116.5	14.70	138.7	18.19	148.6	21.24	153.0	21.40	157.2	21.57	164.8	21.74	169.0	21.93		
	16	116.5	15.23	138.7	18.83	148.6	22.20	153.0	22.40	157.2	22.58	164.8	22.78	169.0	22.97		
	18	116.5	15.86	138.7	19.92	148.6	23.22	153.0	23.72	157.2	23.91	164.8	24.15	169.0	24.31		
	20	116.5	16.57	138.7	21.22	148.6	24.37	153.0	26.08	157.2	26.30	162.4	26.55	166.7	26.74		
	21	116.5	17.00	138.7	21.96	148.6	24.87	153.0	27.61	157.2	27.83	161.5	28.11	165.7	28.30		
	23	116.5	18.24	138.7	23.11	148.6	26.16	153.0	30.47	155.2	30.70	159.1	31.02	163.3	31.22		
	25	116.5	19.48	138.7	24.43	148.6	27.95	151.1	33.78	153.0	34.05	157.2	34.40	161.5	34.63		
	27	116.5	20.85	138.7	26.13	146.8	29.79	148.6	37.19	151.1	37.49	155.2	37.86	159.1	38.12		
	29	116.5	22.21	138.7	27.92	144.4	32.05	146.5	40.88	148.6	41.12	153.0	41.49	157.2	41.65		
	31	116.5	23.71	138.3	29.41	142.0	34.10	144.4	40.70	146.5	40.95	150.6	41.32	154.8	41.47		
	33	116.5	25.25	135.9	31.17	140.2	36.57	142.5	40.33	144.4	40.58	148.6	40.94	152.5	41.10		
	35	116.5	26.93	133.5	32.64	137.8	39.60	140.2	39.81	142.5	40.04	146.3	40.40	150.6	40.56		
	37	116.5	28.72	131.6	34.26	135.9	39.08	137.8	39.28	140.2	39.52	143.9	39.87	148.3	40.03		
	39	116.5	30.58	129.2	36.05	133.5	38.56	135.9	38.75	137.8	38.99	142.0	39.34	146.3	39.49		
	41	113.5	32.44	123.9	37.86	128.1	38.04	130.0	38.23	132.6	38.46	136.5	38.80	140.2	38.96		
	43	110.7	34.21	118.7	37.32	122.9	37.51	124.7	37.70	127.3	37.93	131.2	38.27	134.7	38.42		
46	103.7	36.62	108.4	36.55	112.3	36.73	114.0	36.91	116.3	37.13	120.0	37.47	123.4	37.62			
48	91.8	35.60	94.0	35.70	97.6	35.78	99.2	35.88	101.3	36.19	104.5	36.42	107.4	36.57			
120	10	105.4	12.48	125.3	15.30	137.0	18.19	141.2	19.65	145.3	19.96	153.2	20.04	156.9	20.20		
	12	105.4	12.81	125.3	15.82	137.0	18.91	141.2	20.06	145.3	20.70	153.2	20.95	156.9	21.12		
	14	105.4	13.25	125.3	16.35	137.0	19.68	141.2	20.83	145.3	21.46	153.2	21.77	156.9	21.95		
	16	105.4	13.74	125.3	17.03	137.0	20.44	141.2	21.60	145.3	22.45	153.2	22.73	156.9	22.91		
	18	105.4	14.27	125.3	17.79	137.0	21.26	141.2	22.75	145.3	23.60	153.2	23.87	156.9	24.07		
	20	105.4	14.81	125.3	18.86	137.0	22.40	141.2	23.93	145.3	24.85	153.2	25.18	156.9	25.38		
	21	105.4	15.26	125.3	19.54	137.0	23.03	141.2	24.64	145.3	25.67	153.2	26.00	156.9	26.21		
	23	105.4	16.32	125.3	20.91	137.0	24.67	141.2	26.18	145.3	27.37	153.2	27.64	156.9	27.86		
	25	105.4	17.44	125.3	22.40	137.0	26.02	141.2	27.91	145.3	29.35	151.4	29.59	155.1	29.83		
	27	105.4	18.61	125.3	23.95	137.0	27.70	141.2	29.82	145.3	31.54	149.1	31.75	152.8	32.01		
	29	105.4	19.86	125.3	25.56	137.0	29.15	141.2	31.91	143.0	33.61	146.7	34.12	150.9	34.40		
	31	105.4	21.16	125.3	27.31	137.0	30.65	139.3	34.18	141.2	36.06	144.9	36.69	148.5	36.99		
	33	105.4	22.53	125.3	29.10	135.1	32.42	137.0	37.10	138.8	38.72	142.5	39.16	146.2	39.47		
	35	105.4	23.95	125.3	31.02	132.8	34.32	134.6	40.88	137.0	41.08	140.7	41.20	144.4	41.53		
	37	105.4	25.77	125.3	32.73	130.9	36.58	132.8	40.01	134.6	40.22	138.3	40.34	142.1	40.66		
	39	105.4	27.73	124.9	34.60	128.6	38.80	130.5	39.19	132.3	39.39	136.5	39.51	140.2	39.82		
	41	102.7	29.71	119.4	36.46	123.4	38.04	125.2	38.37	127.0	38.56	130.7	38.68	134.4	38.99		
	43	100.2	31.71	114.4	35.94	118.4	37.19	120.1	37.54	121.8	37.73	125.5	37.85	129.1	38.15		
46	93.9	34.10	104.3	35.09	108.1	36.02	109.7	36.32	111.4	36.50	114.7	36.61	118.1	36.90			
48	83.0	33.39	90.6	34.46	94.0	35.32	95.4	35.53	96.9	35.64	99.8	35.78	102.9	35.94			
110	10	94.4	11.22	112.6	13.68	125.7	16.25	129.4	17.59	137.5	18.93	140.7	19.46	150.2	19.78		
	12	94.4	11.57	112.6	14.15	125.7	16.93	129.4	18.08	137.5	19.64	140.7	20.28	150.2	20.74		
	14	94.4	11.93	112.6	14.78	125.7	17.69	129.4	18.98	137.5	20.63	140.7	21.22	150.2	21.66		
	16	94.4	12.36	112.6	15.31	125.7	18.42	129.4	19.81	137.5	21.58	140.7	22.17	150.2	22.56		
	18	94.4	12.81	112.6	15.96	125.7	19.48	129.4	20.86	137.5	22.76	140.7	23.22	150.2	23.65		
	20	94.4	13.27	112.6	16.76	125.7	20.66	129.4	21.82	137.5	23.87	140.7	24.46	150.2	24.85		
	21	94.4	13.57	112.6	17.25	125.7	21.19	129.4	22.40	137.5	24.54	140.7	25.15	150.2	25.55		
	23	94.4	14.46	112.6	18.49	125.7	22.37	129.4	23.66	137.5	25.92	140.7	26.48	150.2	26.91		
	25	94.4	15.45	112.6	19.73	125.7	23.64	129.4	25.01	137.5	27.39	140.7	27.78	148.4	28.35		
	27	94.4	16.51	112.6	21.10	125.7	24.98	129.4	26.47	137.5	28.60	140.7	29.26	146.2	29.76		
	29	94.4	17.62	112.6	22.53	125.7	26.40	129.4	28.03	137.5	30.23	140.7	30.75	144.4	31.21		
	31	94.4	18.74	112.6	24.01	125.7	27.89	129.4	29.70	135.2	31.76	138.9	32.38	142.1	32.72		
	33	94.4	19.98	112.6	25.56	125.7	29.48	129.4	31.47	133.4	33.54	136.7	34.10	140.2	34.29		
	35	94.4	21.22	112.6	27.31	125.7	31.13	129.4	33.35	131.2	35.40	134.4	35.72	138.0	35.91		
	37	94.4	22.49	112.6	28.97	125.7	32.86	127.6	35.33	128.9	37.34	132.6	37.46	135.7	37.57		
	39	94.4	24.24	112.6	30.80	123.4	34.67	125.2	37.79	127.1	39.18	130.2	39.25	133.9	39.29		
	41	92.0	26.00	109.7	32.61	118.2	36.57	120.0	40.88	121.6	40.88	125.2	41.20	128.3	41.53		
	43	89.7	27.31	106.9	33.97	113.2	38.77	115.1	39.21	116.6	39.13	120.0	39.35	123.1	39.46		
46	84.1	26.65	100.3	32.79	103.4	36.80	105.1	36.80	106.5	37.12	109.7	37.32	112.6	37.42			
48	74.3	25.88	87.1	31.60	89.8	35.01	91.4	35.25	92.6	35.42	95.5	35.51	97.9	35.66			

Note

1. TC: Total Capacity(kW), PI: Power Input(kW, Comp. + Outdoor fan motor)
2. Capacity tables show the average value of conditions which may occur.

7. Capacity Tables

Combination (%)	Outdoor air temp (°C DB)	Cooling Capacity(42HP)													
		Indoor air temp. (DB/WB, °C)													
		20		23		26		27		28		30		32	
		14	16	18	19	20	22	24							
	TC	PI	TC	PI	TC	PI	TC	PI	TC	PI	TC	PI	TC	PI	
100	10	79.3	10.11	94.5	12.28	110.0	14.57	117.6	15.75	125.2	16.92	138.8	18.83	141.8	18.99
	12	79.3	10.44	94.5	12.78	110.0	15.06	117.6	16.18	125.2	17.46	138.8	19.85	141.8	20.04
	14	79.3	10.76	94.5	13.30	110.0	15.70	117.6	16.87	125.2	18.22	138.8	20.96	141.8	21.16
	16	79.3	11.08	94.5	13.74	110.0	16.37	117.6	17.67	125.2	19.20	138.8	21.98	141.8	22.28
	18	79.3	11.41	94.5	14.25	110.0	17.01	117.6	18.54	125.2	20.36	138.8	23.22	141.8	23.40
	20	79.3	11.82	94.5	14.79	110.0	18.00	117.6	19.86	125.2	21.78	138.8	24.32	141.8	24.52
	21	79.3	12.07	94.5	15.14	110.0	18.61	117.6	20.53	125.2	22.59	138.8	24.88	141.8	25.08
	23	79.3	12.78	94.5	16.19	110.0	19.98	117.6	22.03	125.2	24.20	138.8	26.05	141.8	26.27
	25	79.3	13.59	94.5	17.25	110.0	21.35	117.6	23.58	125.2	25.88	138.8	27.17	140.6	27.38
	27	79.3	14.52	94.5	18.43	110.0	22.83	117.6	25.19	125.2	27.51	136.0	28.44	138.9	28.67
	29	79.3	15.45	94.5	19.67	110.0	24.38	117.6	26.93	125.2	29.12	133.6	29.59	136.8	29.82
	31	79.3	16.51	94.5	20.97	110.0	26.00	117.6	28.72	125.2	30.59	131.5	30.73	134.7	30.98
	33	79.3	17.50	94.5	22.34	110.0	27.73	117.6	30.65	125.2	31.74	129.4	31.88	132.6	32.13
	35	79.3	18.61	94.5	23.77	110.0	29.54	117.6	32.70	123.3	32.89	127.1	33.03	130.3	33.28
	37	79.3	19.93	94.5	25.49	110.0	31.29	117.6	34.26	121.2	34.43	124.7	34.57	127.6	34.88
	39	79.3	21.38	94.5	27.38	110.0	33.15	117.6	35.94	119.2	36.09	122.7	36.22	125.5	36.57
	41	78.2	22.81	93.0	29.27	108.3	35.02	112.9	37.61	115.3	37.76	118.1	37.89	121.8	38.25
	43	75.4	24.15	89.8	31.03	104.5	36.69	108.2	39.05	109.4	39.18	112.8	39.32	115.8	39.68
46	70.7	25.97	84.2	33.45	98.0	38.92	98.8	40.88	99.8	41.00	103.1	41.11	105.8	41.50	
48	62.5	22.42	74.5	28.94	84.6	33.27	85.8	34.68	86.7	34.79	89.6	34.87	92.1	35.15	
90	10	71.4	8.66	85.3	10.41	99.2	12.27	105.8	13.23	112.6	14.24	126.5	15.93	140.2	17.72
	12	71.4	8.76	85.3	10.57	99.2	12.49	105.8	13.49	112.6	14.55	126.5	16.25	140.2	18.03
	14	71.4	8.93	85.3	10.78	99.2	12.75	105.8	13.76	112.6	14.82	126.5	16.57	140.2	18.40
	16	71.4	9.08	85.3	11.00	99.2	13.01	105.8	14.02	112.6	15.09	126.5	16.88	140.2	18.71
	18	71.4	9.24	85.3	11.21	99.2	13.23	105.8	14.35	112.6	15.41	126.5	17.25	140.2	19.66
	20	71.4	9.40	85.3	11.42	99.2	13.49	105.8	14.61	112.6	15.99	126.5	18.46	140.2	20.59
	21	71.4	9.51	85.3	11.53	99.2	13.76	105.8	15.09	112.6	16.57	126.5	18.76	140.2	21.07
	23	71.4	9.72	85.3	12.01	99.2	14.72	105.8	16.20	112.6	17.75	126.5	19.89	138.3	22.07
	25	71.4	10.20	85.3	12.80	99.2	15.73	105.8	17.32	112.6	18.96	126.5	21.28	136.3	23.00
	27	71.4	10.89	85.3	13.65	99.2	16.79	105.8	18.48	112.6	20.30	126.5	22.61	134.4	24.09
	29	71.4	11.53	85.3	14.55	99.2	17.95	105.8	19.77	112.6	21.68	126.5	23.96	132.3	25.05
	31	71.4	12.27	85.3	15.51	99.2	19.13	105.8	21.04	112.6	23.11	126.5	25.16	130.4	26.03
	33	71.4	13.07	85.3	16.52	99.2	20.40	105.8	22.42	112.6	24.51	126.5	26.37	128.4	26.99
	35	71.4	13.87	85.3	17.53	99.2	21.68	105.8	23.90	112.6	26.00	124.2	27.88	126.3	28.53
	37	71.4	14.72	85.3	18.65	99.2	23.11	105.8	25.39	112.6	27.44	122.3	29.15	124.4	29.80
	39	71.4	15.58	85.3	19.83	99.2	24.46	105.8	27.02	112.6	28.85	120.2	30.73	122.3	31.10
	41	69.6	17.44	83.0	21.99	96.6	26.85	103.1	29.55	109.7	31.15	115.2	32.38	117.3	33.13
	43	67.8	18.82	81.1	23.76	94.2	29.32	100.6	31.83	106.9	33.40	110.5	34.68	112.5	35.10
46	63.6	21.18	75.9	27.06	88.2	33.42	94.3	36.09	97.2	37.10	100.8	38.07	102.7	38.12	
48	56.2	18.51	67.2	23.67	78.0	29.23	83.4	31.48	84.4	31.98	87.7	32.77	89.3	32.81	
80	10	63.5	7.24	75.6	8.71	87.7	10.22	94.0	11.02	100.3	11.82	112.6	13.49	124.7	14.64
	12	63.5	7.40	75.6	8.80	87.7	10.42	94.0	11.22	100.3	12.02	112.6	13.74	124.7	14.93
	14	63.5	7.49	75.6	9.00	87.7	10.56	94.0	11.42	100.3	12.23	112.6	13.99	124.7	15.22
	16	63.5	7.60	75.6	9.16	87.7	10.76	94.0	11.62	100.3	12.48	112.6	14.29	124.7	15.51
	18	63.5	7.75	75.6	9.31	87.7	10.97	94.0	11.82	100.3	12.73	112.6	14.54	124.7	15.85
	20	63.5	7.90	75.6	9.51	87.7	11.22	94.0	12.07	100.3	12.99	112.6	15.09	124.7	16.79
	21	63.5	7.95	75.6	9.61	87.7	11.32	94.0	12.23	100.3	13.28	112.6	15.57	124.7	17.24
	23	63.5	8.10	75.6	9.76	87.7	11.82	94.0	12.99	100.3	14.19	112.6	16.44	124.7	18.10
	25	63.5	8.41	75.6	10.42	87.7	12.68	94.0	13.89	100.3	15.20	112.6	17.60	124.7	19.34
	27	63.5	8.91	75.6	11.07	87.7	13.53	94.0	14.84	100.3	16.20	112.6	18.69	124.7	20.35
	29	63.5	9.46	75.6	11.82	87.7	14.39	94.0	15.81	100.3	17.31	112.6	20.03	124.7	21.79
	31	63.5	10.06	75.6	12.52	87.7	15.34	94.0	16.85	100.3	18.42	112.6	21.26	124.7	22.88
	33	63.5	10.67	75.6	13.38	87.7	16.35	94.0	17.96	100.3	19.62	112.6	22.40	124.7	23.98
	35	63.5	11.32	75.6	14.19	87.7	17.41	94.0	19.12	100.3	20.93	112.6	23.75	123.4	24.85
	37	63.5	11.98	75.6	15.09	87.7	18.47	94.0	20.33	100.3	22.24	112.6	25.06	121.5	25.98
	39	63.5	12.66	75.6	15.95	87.7	19.75	94.0	21.85	100.3	23.90	112.6	26.48	119.4	27.41
	41	61.8	14.00	73.7	17.68	85.5	21.68	91.6	23.95	97.8	26.26	109.7	29.47	114.4	30.37
	43	60.3	15.42	71.9	19.28	83.4	23.67	89.4	26.10	95.4	28.70	106.9	31.54	109.7	32.52
46	56.5	17.15	67.3	21.73	78.2	26.66	83.8	29.06	89.4	32.38	97.9	34.42	100.1	34.98	
48	49.9	14.98	59.6	19.00	69.1	23.32	74.1	25.38	79.1	28.35	85.0	29.79	87.0	30.11	

Note

1. TC: Total Capacity(kW), PI : Power Input(kW, Comp. + Outdoor fan motor)
2. Capacity tables show the average value of conditions which may occur.

7. Capacity Tables

Combination (%)	Outdoor air temp (°C DB)	Cooling Capacity(42HP)													
		Indoor air temp. (DB/WB, °C)													
		20		23		26		27		28		30		32	
		14	16	18	19	20	22	24							
	TC	PI	TC	PI	TC	PI	TC	PI	TC	PI	TC	PI	TC	PI	
70	10	55.4	6.36	66.4	7.56	76.9	8.76	82.4	9.46	87.7	10.11	98.2	11.51	109.2	12.87
	12	55.4	6.45	66.4	7.65	76.9	8.95	82.4	9.61	87.7	10.31	98.2	11.71	109.2	13.12
	14	55.4	6.56	66.4	7.76	76.9	9.11	82.4	9.76	87.7	10.46	98.2	11.96	109.2	13.35
	16	55.4	6.65	66.4	7.90	76.9	9.26	82.4	9.96	87.7	10.65	98.2	12.16	109.2	13.64
	18	55.4	6.76	66.4	8.06	76.9	9.46	82.4	10.15	87.7	10.86	98.2	12.36	109.2	13.88
	20	55.4	6.86	66.4	8.20	76.9	9.61	82.4	10.36	87.7	11.11	98.2	12.66	109.2	14.41
	21	55.4	6.95	66.4	8.26	76.9	9.71	82.4	10.46	87.7	11.21	98.2	12.86	109.2	14.72
	23	55.4	7.06	66.4	8.45	76.9	9.90	82.4	10.81	87.7	11.76	98.2	13.76	109.2	15.54
	25	55.4	7.15	66.4	8.76	76.9	10.56	82.4	11.56	87.7	12.56	98.2	14.71	109.2	16.29
	27	55.4	7.56	66.4	9.36	76.9	11.26	82.4	12.26	87.7	13.41	98.2	15.71	109.2	17.32
	29	55.4	8.06	66.4	9.90	76.9	11.96	82.4	13.06	87.7	14.26	98.2	16.76	109.2	18.55
	31	55.4	8.56	66.4	10.56	76.9	12.76	82.4	13.96	87.7	15.21	98.2	17.87	109.2	19.68
	33	55.4	9.06	66.4	11.15	76.9	13.56	82.4	14.81	87.7	16.17	98.2	19.01	109.2	20.96
	35	55.4	9.56	66.4	11.92	76.9	14.41	82.4	15.76	87.7	17.21	98.2	20.27	109.2	22.22
	37	55.4	10.15	66.4	12.62	76.9	15.31	82.4	16.76	87.7	18.32	98.2	21.57	109.2	23.45
	39	55.4	10.79	66.4	13.45	76.9	16.37	82.4	18.04	87.7	19.79	98.2	23.08	109.2	25.29
	41	54.0	11.93	64.6	14.73	74.9	17.96	80.3	19.79	85.5	21.51	95.8	25.35	106.4	27.27
	43	52.7	12.98	63.0	16.06	73.0	19.60	78.2	21.57	83.4	23.49	93.4	27.69	103.7	29.49
46	49.4	14.43	59.1	18.06	68.5	22.07	73.3	24.02	78.2	26.48	87.5	31.24	97.2	32.86	
48	43.6	12.59	52.3	15.77	60.6	19.29	64.8	20.99	69.1	23.16	77.4	27.33	86.1	28.44	
60	10	47.5	5.47	56.7	6.42	65.9	7.47	70.6	8.01	75.1	8.51	84.5	9.65	93.7	10.80
	12	47.5	5.58	56.7	6.52	65.9	7.57	70.6	8.11	75.1	8.66	84.5	9.81	93.7	11.00
	14	47.5	5.62	56.7	6.62	65.9	7.71	70.6	8.26	75.1	8.81	84.5	10.01	93.7	11.20
	16	47.5	5.72	56.7	6.77	65.9	7.82	70.6	8.41	75.1	9.01	84.5	10.20	93.7	11.39
	18	47.5	5.83	56.7	6.86	65.9	7.96	70.6	8.56	75.1	9.16	84.5	10.35	93.7	11.64
	20	47.5	5.92	56.7	6.97	65.9	8.11	70.6	8.71	75.1	9.31	84.5	10.55	93.7	11.89
	21	47.5	5.97	56.7	7.02	65.9	8.21	70.6	8.81	75.1	9.40	84.5	10.70	93.7	12.00
	23	47.5	6.08	56.7	7.16	65.9	8.32	70.6	8.96	75.1	9.60	84.5	11.09	93.7	12.74
	25	47.5	6.17	56.7	7.32	65.9	8.66	70.6	9.40	75.1	10.20	84.5	11.84	93.7	13.63
	27	47.5	6.37	56.7	7.71	65.9	9.21	70.6	10.01	75.1	10.85	84.5	12.59	93.7	14.54
	29	47.5	6.77	56.7	8.21	65.9	9.81	70.6	10.65	75.1	11.55	84.5	13.44	93.7	15.52
	31	47.5	7.16	56.7	8.71	65.9	10.40	70.6	11.34	75.1	12.30	84.5	14.33	93.7	16.52
	33	47.5	7.57	56.7	9.21	65.9	11.05	70.6	12.05	75.1	13.08	84.5	15.23	93.7	17.62
	35	47.5	8.01	56.7	9.81	65.9	11.75	70.6	12.79	75.1	13.88	84.5	16.23	93.7	18.71
	37	47.5	8.46	56.7	10.34	65.9	12.44	70.6	13.58	75.1	14.73	84.5	17.22	93.7	19.91
	39	47.5	8.99	56.7	11.01	65.9	13.43	70.6	14.57	75.1	15.85	84.5	18.47	93.7	21.33
	41	46.2	9.76	55.2	12.06	64.3	14.58	68.8	15.92	73.2	17.20	82.2	20.26	91.3	23.18
	43	45.1	10.60	53.9	13.13	62.7	15.90	67.0	17.35	71.4	18.77	80.3	22.12	89.0	25.32
46	42.3	11.87	50.5	14.74	58.8	17.88	62.8	19.50	66.9	21.12	75.1	24.92	83.4	28.84	
48	37.3	10.35	44.7	12.86	52.0	15.62	55.6	17.03	59.3	18.45	66.5	21.79	73.8	25.24	
50	10	39.7	4.70	47.5	5.44	55.1	6.19	58.8	6.63	62.5	7.02	70.1	7.92	78.2	8.81
	12	39.7	4.75	47.5	5.50	55.1	6.28	58.8	6.73	62.5	7.18	70.1	8.06	78.2	8.96
	14	39.7	4.81	47.5	5.59	55.1	6.38	58.8	6.83	62.5	7.27	70.1	8.17	78.2	9.11
	16	39.7	4.90	47.5	5.69	55.1	6.49	58.8	6.98	62.5	7.37	70.1	8.31	78.2	9.25
	18	39.7	4.95	47.5	5.74	55.1	6.58	58.8	7.07	62.5	7.52	70.1	8.47	78.2	9.46
	20	39.7	5.00	47.5	5.84	55.1	6.73	58.8	7.18	62.5	7.67	70.1	8.61	78.2	9.65
	21	39.7	5.04	47.5	5.89	55.1	6.78	58.8	7.27	62.5	7.72	70.1	8.71	78.2	9.74
	23	39.7	5.15	47.5	5.99	55.1	6.88	58.8	7.37	62.5	7.87	70.1	8.86	78.2	9.95
	25	39.7	5.20	47.5	6.08	55.1	7.02	58.8	7.52	62.5	8.12	70.1	9.30	78.2	10.64
	27	39.7	5.29	47.5	6.28	55.1	7.42	58.8	8.01	62.5	8.61	70.1	9.95	78.2	11.33
	29	39.7	5.59	47.5	6.68	55.1	7.87	58.8	8.51	62.5	9.16	70.1	10.54	78.2	12.02
	31	39.7	5.89	47.5	7.07	55.1	8.36	58.8	9.00	62.5	9.74	70.1	11.23	78.2	12.82
	33	39.7	6.24	47.5	7.48	55.1	8.86	58.8	9.55	62.5	10.34	70.1	11.93	78.2	13.66
	35	39.7	6.58	47.5	7.92	55.1	9.35	58.8	10.15	62.5	10.94	70.1	12.62	78.2	14.50
	37	39.7	6.98	47.5	8.36	55.1	9.90	58.8	10.73	62.5	11.58	70.1	13.46	78.2	15.39
	39	39.7	7.45	47.5	8.97	55.1	10.61	58.8	11.56	62.5	12.43	70.1	14.34	78.2	16.62
	41	38.6	8.05	46.2	9.71	53.6	11.60	57.3	12.52	60.9	13.46	68.3	15.71	76.1	18.05
	43	37.7	8.75	45.1	10.56	52.3	12.62	55.9	13.64	59.5	14.66	66.7	17.14	74.3	19.69
46	35.4	9.80	42.3	11.84	49.0	14.16	52.3	15.31	55.7	16.45	62.5	19.28	69.6	22.17	
48	31.3	8.53	37.3	10.32	43.3	12.35	46.3	13.36	49.3	14.36	55.3	16.85	61.5	19.38	

Note

1. TC: Total Capacity(kW), PI : Power Input(kW, Comp. + Outdoor fan motor)
2. Capacity tables show the average value of conditions which may occur.

7. Capacity Tables

◆ A(C)RUN440LLS5

Combination (%)	Outdoor air temp (°C DB)	Indoor air temp. (DB/WB, °C)														Cooling Capacity(44HP)	
		20		23		26		27		28		30		32		TC	PI
		14		16		18		19		20		22		24			
		TC	PI	TC	PI	TC	PI	TC	PI	TC	PI	TC	PI	TC	PI		
130	10	122.0	14.04	145.4	17.16	155.7	19.91	160.2	20.31	164.7	20.48	172.6	20.64	177.0	20.72		
	12	122.0	14.39	145.4	17.77	155.7	20.72	160.2	20.86	164.7	21.02	172.6	21.20	177.0	21.39		
	14	122.0	14.88	145.4	18.41	155.7	21.50	160.2	21.66	164.7	21.83	172.6	22.01	177.0	22.20		
	16	122.0	15.42	145.4	19.06	155.7	22.47	160.2	22.68	164.7	22.85	172.6	23.06	177.0	23.25		
	18	122.0	16.06	145.4	20.16	155.7	23.50	160.2	24.01	164.7	24.20	172.6	24.44	177.0	24.60		
	20	122.0	16.77	145.4	21.48	155.7	24.66	160.2	26.40	164.7	26.62	170.1	26.88	174.6	27.07		
	21	122.0	17.21	145.4	22.23	155.7	25.18	160.2	27.94	164.7	28.17	169.2	28.45	173.6	28.64		
	23	122.0	18.46	145.4	23.39	155.7	26.48	160.2	30.84	162.6	31.08	166.7	31.39	171.1	31.61		
	25	122.0	19.72	145.4	24.73	155.7	28.30	158.3	34.20	160.2	34.47	164.7	34.82	169.2	35.06		
	27	122.0	21.10	145.4	26.45	153.8	30.16	155.7	37.65	158.3	37.95	162.6	38.32	166.7	38.59		
	29	122.0	22.49	145.4	28.26	151.3	32.45	153.5	41.38	155.7	41.63	160.2	42.00	164.7	42.16		
	31	122.0	24.00	144.9	29.77	148.8	34.51	151.3	41.20	153.5	41.45	157.7	41.82	162.1	41.98		
	33	122.0	25.56	142.3	31.55	146.9	37.01	149.2	40.82	151.3	41.07	155.7	41.44	159.7	41.60		
	35	122.0	27.26	139.8	33.04	144.3	40.09	146.9	40.29	149.2	40.53	153.3	40.90	157.7	41.06		
	37	122.0	29.07	137.9	34.67	142.3	39.56	144.3	39.77	146.9	40.00	150.8	40.36	155.3	40.52		
	39	122.0	30.95	135.4	36.49	139.8	39.03	142.3	39.23	144.3	39.46	148.8	39.82	153.3	39.97		
	41	118.9	32.83	129.8	38.32	134.2	38.51	136.2	38.70	138.9	38.93	143.0	39.28	146.9	39.43		
	43	115.9	34.63	124.4	37.78	128.8	37.97	130.7	38.16	133.3	38.40	137.4	38.73	141.1	38.89		
46	108.7	37.07	113.5	37.00	117.6	37.18	119.5	37.37	121.9	37.59	125.7	37.92	129.3	38.08			
48	96.1	36.03	98.5	36.14	102.2	36.22	103.9	36.32	106.1	36.63	109.5	36.87	112.5	37.01			
120	10	110.4	12.63	131.3	15.49	143.5	18.41	147.9	19.89	152.2	20.21	160.5	20.29	164.4	20.45		
	12	110.4	12.97	131.3	16.01	143.5	19.14	147.9	20.31	152.2	20.96	160.5	21.21	164.4	21.37		
	14	110.4	13.42	131.3	16.55	143.5	19.92	147.9	21.08	152.2	21.72	160.5	22.04	164.4	22.22		
	16	110.4	13.91	131.3	17.23	143.5	20.69	147.9	21.87	152.2	22.73	160.5	23.01	164.4	23.19		
	18	110.4	14.45	131.3	18.01	143.5	21.52	147.9	23.02	152.2	23.89	160.5	24.16	164.4	24.36		
	20	110.4	14.99	131.3	19.10	143.5	22.68	147.9	24.22	152.2	25.16	160.5	25.49	164.4	25.69		
	21	110.4	15.45	131.3	19.78	143.5	23.31	147.9	24.94	152.2	25.99	160.5	26.32	164.4	26.53		
	23	110.4	16.52	131.3	21.17	143.5	24.97	147.9	26.50	152.2	27.70	160.5	27.98	164.4	28.20		
	25	110.4	17.65	131.3	22.68	143.5	26.34	147.9	28.25	152.2	29.71	158.6	29.95	162.4	30.19		
	27	110.4	18.84	131.3	24.24	143.5	28.04	147.9	30.19	152.2	31.92	156.2	32.14	160.1	32.40		
	29	110.4	20.10	131.3	25.88	143.5	29.50	147.9	32.30	149.8	34.02	153.7	34.53	158.1	34.82		
	31	110.4	21.42	131.3	27.64	143.5	31.03	145.9	34.60	147.9	36.50	151.8	37.14	155.6	37.44		
	33	110.4	22.80	131.3	29.46	141.5	32.82	143.5	37.56	145.4	39.19	149.3	39.64	153.2	39.96		
	35	110.4	24.24	131.3	31.40	139.1	34.74	141.0	41.38	143.5	41.58	147.4	41.71	151.3	42.04		
	37	110.4	26.08	131.3	33.13	137.1	37.03	139.1	40.50	141.0	40.71	144.9	40.83	148.9	41.15		
	39	110.4	28.07	130.8	35.02	134.7	39.28	136.7	39.67	138.6	39.88	143.0	39.99	146.9	40.31		
	41	107.6	30.07	125.1	36.91	129.3	38.51	131.2	38.84	133.0	39.04	136.9	39.15	140.8	39.46		
	43	104.9	32.10	119.8	36.38	124.0	37.65	125.8	38.00	127.6	38.19	131.5	38.32	135.2	38.62		
46	98.3	34.51	109.3	35.52	113.2	36.46	114.9	36.76	116.7	36.95	120.2	37.06	123.7	37.35			
48	87.0	33.80	94.9	34.88	98.5	35.75	100.0	35.97	101.5	36.08	104.6	36.22	107.8	36.38			
110	10	98.9	11.36	117.9	13.85	131.7	16.45	135.5	17.81	144.0	19.16	147.4	19.70	157.4	20.02		
	12	98.9	11.71	117.9	14.32	131.7	17.14	135.5	18.30	144.0	19.88	147.4	20.53	157.4	20.99		
	14	98.9	12.08	117.9	14.96	131.7	17.90	135.5	19.21	144.0	20.88	147.4	21.48	157.4	21.93		
	16	98.9	12.51	117.9	15.50	131.7	18.65	135.5	20.05	144.0	21.85	147.4	22.44	157.4	22.84		
	18	98.9	12.97	117.9	16.15	131.7	19.72	135.5	21.12	144.0	23.04	147.4	23.50	157.4	23.94		
	20	98.9	13.43	117.9	16.96	131.7	20.91	135.5	22.09	144.0	24.16	147.4	24.76	157.4	25.16		
	21	98.9	13.73	117.9	17.46	131.7	21.45	135.5	22.68	144.0	24.84	147.4	25.46	157.4	25.86		
	23	98.9	14.64	117.9	18.72	131.7	22.65	135.5	23.95	144.0	26.24	147.4	26.80	157.4	27.24		
	25	98.9	15.64	117.9	19.97	131.7	23.93	135.5	25.32	144.0	27.72	147.4	28.12	155.5	28.69		
	27	98.9	16.71	117.9	21.36	131.7	25.29	135.5	26.80	144.0	28.95	147.4	29.61	153.2	30.12		
	29	98.9	17.84	117.9	22.80	131.7	26.72	135.5	28.37	144.0	30.60	147.4	31.13	151.3	31.59		
	31	98.9	18.97	117.9	24.30	131.7	28.23	135.5	30.06	141.7	32.15	145.5	32.78	148.9	33.12		
	33	98.9	20.23	117.9	25.88	131.7	29.84	135.5	31.86	139.8	33.95	143.2	34.52	146.9	34.71		
	35	98.9	21.48	117.9	27.64	131.7	31.51	135.5	33.75	137.4	35.83	140.8	36.16	144.5	36.34		
	37	98.9	22.77	117.9	29.33	131.7	33.26	133.7	35.76	135.0	37.79	138.9	37.92	142.2	38.03		
	39	98.9	24.54	117.9	31.17	129.3	35.09	131.2	38.25	133.2	39.66	136.4	39.73	140.3	39.77		
	41	96.4	26.32	114.9	33.00	123.8	37.01	125.7	41.38	127.4	41.38	131.1	41.71	134.4	42.04		
	43	94.0	27.64	112.0	34.39	118.6	39.24	120.6	39.69	122.2	39.61	125.8	39.83	129.0	39.94		
46	88.1	26.97	105.1	33.20	108.3	37.25	110.2	37.25	111.5	37.57	114.9	37.78	118.0	37.88			
48	77.9	26.20	91.2	31.98	94.1	35.44	95.8	35.68	97.0	35.85	100.0	35.95	102.6	36.09			

Note

1. TC: Total Capacity(kW), PI : Power Input(kW, Comp. + Outdoor fan motor)
2. Capacity tables show the average value of conditions which may occur.

7. Capacity Tables

Combination (%)	Outdoor air temp (°C DB)	Cooling Capacity(44HP)													
		Indoor air temp. (DB/WB, °C)													
		20		23		26		27		28		30		32	
		14	16	18	19	20	22	24							
	TC	PI	TC	PI	TC	PI	TC	PI	TC	PI	TC	PI	TC	PI	
100	10	83.1	10.23	99.0	12.43	115.3	14.75	123.2	15.94	131.1	17.12	145.4	19.07	148.6	19.22
	12	83.1	10.56	99.0	12.94	115.3	15.25	123.2	16.37	131.1	17.68	145.4	20.10	148.6	20.29
	14	83.1	10.89	99.0	13.46	115.3	15.90	123.2	17.08	131.1	18.44	145.4	21.21	148.6	21.42
	16	83.1	11.22	99.0	13.91	115.3	16.57	123.2	17.89	131.1	19.43	145.4	22.24	148.6	22.55
	18	83.1	11.55	99.0	14.42	115.3	17.22	123.2	18.76	131.1	20.61	145.4	23.50	148.6	23.68
	20	83.1	11.97	99.0	14.97	115.3	18.22	123.2	20.10	131.1	22.04	145.4	24.62	148.6	24.82
	21	83.1	12.22	99.0	15.32	115.3	18.84	123.2	20.79	131.1	22.87	145.4	25.19	148.6	25.38
	23	83.1	12.94	99.0	16.39	115.3	20.23	123.2	22.30	131.1	24.49	145.4	26.37	148.6	26.59
	25	83.1	13.75	99.0	17.46	115.3	21.61	123.2	23.87	131.1	26.19	145.4	27.50	147.3	27.72
	27	83.1	14.70	99.0	18.65	115.3	23.11	123.2	25.50	131.1	27.85	142.5	28.79	145.5	29.02
	29	83.1	15.64	99.0	19.91	115.3	24.68	123.2	27.26	131.1	29.47	139.9	29.95	143.3	30.19
	31	83.1	16.71	99.0	21.23	115.3	26.32	123.2	29.08	131.1	30.97	137.8	31.11	141.1	31.36
	33	83.1	17.71	99.0	22.61	115.3	28.07	123.2	31.03	131.1	32.13	135.6	32.27	138.9	32.53
	35	83.1	18.84	99.0	24.06	115.3	29.90	123.2	33.10	129.1	33.29	133.2	33.43	136.5	33.69
	37	83.1	20.18	99.0	25.80	115.3	31.67	123.2	34.68	127.0	34.85	130.6	34.99	133.7	35.31
	39	83.1	21.64	99.0	27.72	115.3	33.56	123.2	36.38	124.9	36.54	128.6	36.67	131.5	37.01
	41	81.9	23.09	97.5	29.63	113.4	35.45	118.3	38.07	120.8	38.22	123.7	38.35	127.6	38.71
	43	79.0	24.44	94.1	31.41	109.5	37.14	113.4	39.53	114.6	39.66	118.2	39.80	121.3	40.17
	46	74.1	26.29	88.2	33.86	102.7	39.40	103.5	41.38	104.6	41.50	108.0	41.62	110.9	42.01
48	65.5	22.69	78.0	29.30	88.7	33.68	89.9	35.11	90.9	35.22	93.9	35.30	96.4	35.58	
90	10	74.8	9.05	89.3	10.87	103.9	12.81	110.9	13.81	117.9	14.87	132.5	16.64	146.9	18.50
	12	74.8	9.15	89.3	11.04	103.9	13.04	110.9	14.09	117.9	15.20	132.5	16.96	146.9	18.83
	14	74.8	9.32	89.3	11.26	103.9	13.31	110.9	14.37	117.9	15.47	132.5	17.30	146.9	19.21
	16	74.8	9.49	89.3	11.48	103.9	13.59	110.9	14.64	117.9	15.76	132.5	17.63	146.9	19.54
	18	74.8	9.65	89.3	11.71	103.9	13.81	110.9	14.98	117.9	16.09	132.5	18.01	146.9	20.53
	20	74.8	9.81	89.3	11.92	103.9	14.09	110.9	15.26	117.9	16.70	132.5	19.28	146.9	21.50
	21	74.8	9.93	89.3	12.03	103.9	14.37	110.9	15.76	117.9	17.30	132.5	19.59	146.9	22.00
	23	74.8	10.15	89.3	12.53	103.9	15.37	110.9	16.91	117.9	18.53	132.5	20.77	144.9	23.04
	25	74.8	10.65	89.3	13.36	103.9	16.42	110.9	18.08	117.9	19.80	132.5	22.21	142.8	24.02
	27	74.8	11.37	89.3	14.25	103.9	17.53	110.9	19.30	117.9	21.19	132.5	23.61	140.8	25.15
	29	74.8	12.03	89.3	15.20	103.9	18.75	110.9	20.64	117.9	22.63	132.5	25.02	138.6	26.16
	31	74.8	12.81	89.3	16.20	103.9	19.97	110.9	21.97	117.9	24.13	132.5	26.27	136.6	27.17
	33	74.8	13.65	89.3	17.25	103.9	21.30	110.9	23.41	117.9	25.59	132.5	27.53	134.5	28.18
	35	74.8	14.48	89.3	18.31	103.9	22.63	110.9	24.96	117.9	27.14	130.1	29.11	132.4	29.78
	37	74.8	15.37	89.3	19.47	103.9	24.13	110.9	26.51	117.9	28.65	128.1	30.43	130.3	31.12
	39	74.8	16.27	89.3	20.71	103.9	25.54	110.9	28.21	117.9	30.13	125.9	32.09	128.1	32.48
	41	72.9	18.21	87.0	22.96	101.2	28.03	108.0	30.86	114.9	32.53	120.7	33.81	122.9	34.59
	43	71.1	19.65	84.9	24.81	98.7	30.62	105.4	33.24	112.0	34.88	115.7	36.21	117.8	36.65
	46	66.7	22.12	79.5	28.25	92.4	34.89	98.8	37.68	101.9	38.74	105.6	39.74	107.6	39.81
48	58.9	19.33	70.4	24.71	81.8	30.52	87.3	32.87	88.4	33.39	91.9	34.21	93.6	34.26	
80	10	66.5	7.57	79.2	9.09	91.9	10.67	98.5	11.51	105.1	12.35	117.9	14.09	130.7	15.29
	12	66.5	7.73	79.2	9.19	91.9	10.88	98.5	11.72	105.1	12.56	117.9	14.35	130.7	15.60
	14	66.5	7.83	79.2	9.40	91.9	11.03	98.5	11.93	105.1	12.77	117.9	14.61	130.7	15.90
	16	66.5	7.94	79.2	9.57	91.9	11.24	98.5	12.14	105.1	13.03	117.9	14.93	130.7	16.20
	18	66.5	8.10	79.2	9.73	91.9	11.45	98.5	12.35	105.1	13.29	117.9	15.19	130.7	16.56
	20	66.5	8.25	79.2	9.94	91.9	11.72	98.5	12.61	105.1	13.56	117.9	15.76	130.7	17.54
	21	66.5	8.30	79.2	10.04	91.9	11.83	98.5	12.77	105.1	13.88	117.9	16.27	130.7	18.01
	23	66.5	8.46	79.2	10.20	91.9	12.35	98.5	13.56	105.1	14.82	117.9	17.18	130.7	18.90
	25	66.5	8.78	79.2	10.88	91.9	13.24	98.5	14.51	105.1	15.88	117.9	18.38	130.7	20.20
	27	66.5	9.30	79.2	11.56	91.9	14.14	98.5	15.50	105.1	16.92	117.9	19.52	130.7	21.26
	29	66.5	9.88	79.2	12.35	91.9	15.03	98.5	16.51	105.1	18.08	117.9	20.92	130.7	22.76
	31	66.5	10.51	79.2	13.08	91.9	16.03	98.5	17.60	105.1	19.24	117.9	22.20	130.7	23.89
	33	66.5	11.14	79.2	13.98	91.9	17.08	98.5	18.76	105.1	20.50	117.9	23.39	130.7	25.05
	35	66.5	11.83	79.2	14.82	91.9	18.19	98.5	19.97	105.1	21.86	117.9	24.81	129.3	25.96
	37	66.5	12.51	79.2	15.76	91.9	19.29	98.5	21.23	105.1	23.23	117.9	26.18	127.2	27.14
	39	66.5	13.22	79.2	16.66	91.9	20.63	98.5	22.82	105.1	24.97	117.9	27.66	125.1	28.63
	41	64.8	14.62	77.2	18.46	89.6	22.64	96.0	25.02	102.4	27.43	114.9	30.78	119.8	31.72
	43	63.1	16.10	75.3	20.14	87.4	24.72	93.6	27.27	100.0	29.98	112.0	32.94	114.9	33.97
	46	59.2	17.91	70.6	22.69	81.9	27.85	87.8	30.35	93.6	33.82	102.5	35.95	104.9	36.53
48	52.3	15.65	62.4	19.84	72.4	24.35	77.7	26.51	82.9	29.61	89.0	31.12	91.2	31.45	

Note

1. TC: Total Capacity(kW), PI : Power Input(kW, Comp. + Outdoor fan motor)
2. Capacity tables show the average value of conditions which may occur.

7. Capacity Tables

		Cooling Capacity(44HP)													
Combination (%)	Outdoor air temp (°C DB)	Indoor air temp. (DB/WB, °C)													
		20		23		26		27		28		30		32	
		14	16	18	19	20	22	24	TC	PI	TC	PI	TC	PI	
70	10	58.1	6.64	69.5	7.90	80.5	9.15	86.3	9.89	91.9	10.56	102.9	12.03	114.4	13.45
	12	58.1	6.74	69.5	8.00	80.5	9.35	86.3	10.04	91.9	10.77	102.9	12.24	114.4	13.71
	14	58.1	6.85	69.5	8.11	80.5	9.52	86.3	10.20	91.9	10.93	102.9	12.50	114.4	13.95
	16	58.1	6.95	69.5	8.26	80.5	9.68	86.3	10.41	91.9	11.13	102.9	12.71	114.4	14.25
	18	58.1	7.06	69.5	8.42	80.5	9.89	86.3	10.61	91.9	11.34	102.9	12.91	114.4	14.51
	20	58.1	7.16	69.5	8.57	80.5	10.04	86.3	10.82	91.9	11.61	102.9	13.23	114.4	15.06
	21	58.1	7.26	69.5	8.63	80.5	10.15	86.3	10.93	91.9	11.72	102.9	13.43	114.4	15.38
	23	58.1	7.38	69.5	8.83	80.5	10.35	86.3	11.29	91.9	12.29	102.9	14.38	114.4	16.24
	25	58.1	7.48	69.5	9.15	80.5	11.03	86.3	12.08	91.9	13.12	102.9	15.37	114.4	17.02
	27	58.1	7.90	69.5	9.78	80.5	11.77	86.3	12.81	91.9	14.02	102.9	16.42	114.4	18.10
	29	58.1	8.42	69.5	10.35	80.5	12.50	86.3	13.65	91.9	14.90	102.9	17.51	114.4	19.39
	31	58.1	8.94	69.5	11.03	80.5	13.33	86.3	14.59	91.9	15.90	102.9	18.67	114.4	20.57
	33	58.1	9.47	69.5	11.66	80.5	14.17	86.3	15.47	91.9	16.89	102.9	19.87	114.4	21.90
	35	58.1	9.99	69.5	12.45	80.5	15.06	86.3	16.47	91.9	17.99	102.9	21.18	114.4	23.22
	37	58.1	10.61	69.5	13.19	80.5	16.00	86.3	17.51	91.9	19.14	102.9	22.54	114.4	24.50
	39	58.1	11.28	69.5	14.05	80.5	17.11	86.3	18.85	91.9	20.68	102.9	24.12	114.4	26.42
	41	56.6	12.47	67.7	15.39	78.5	18.77	84.1	20.68	89.6	22.47	100.3	26.49	111.5	28.50
	43	55.2	13.56	66.0	16.78	76.5	20.48	81.9	22.54	87.4	24.54	97.8	28.94	108.7	30.81
46	51.8	15.08	61.9	18.87	71.7	23.06	76.8	25.10	81.9	27.66	91.7	32.64	101.9	34.34	
48	45.7	13.15	54.8	16.48	63.5	20.16	67.9	21.94	72.4	24.20	81.1	28.56	90.2	29.72	
60	10	49.7	5.72	59.4	6.71	69.1	7.81	73.9	8.37	78.7	8.89	88.5	10.09	98.1	11.28
	12	49.7	5.83	59.4	6.81	69.1	7.91	73.9	8.48	78.7	9.05	88.5	10.25	98.1	11.50
	14	49.7	5.88	59.4	6.92	69.1	8.06	73.9	8.63	78.7	9.20	88.5	10.46	98.1	11.71
	16	49.7	5.98	59.4	7.07	69.1	8.17	73.9	8.79	78.7	9.42	88.5	10.66	98.1	11.91
	18	49.7	6.09	59.4	7.17	69.1	8.32	73.9	8.94	78.7	9.58	88.5	10.82	98.1	12.17
	20	49.7	6.19	59.4	7.29	69.1	8.48	73.9	9.10	78.7	9.73	88.5	11.02	98.1	12.43
	21	49.7	6.24	59.4	7.34	69.1	8.58	73.9	9.20	78.7	9.83	88.5	11.18	98.1	12.54
	23	49.7	6.35	59.4	7.49	69.1	8.69	73.9	9.37	78.7	10.04	88.5	11.60	98.1	13.31
	25	49.7	6.45	59.4	7.65	69.1	9.05	73.9	9.83	78.7	10.66	88.5	12.38	98.1	14.25
	27	49.7	6.66	59.4	8.06	69.1	9.63	73.9	10.46	78.7	11.34	88.5	13.16	98.1	15.19
	29	49.7	7.07	59.4	8.58	69.1	10.25	73.9	11.13	78.7	12.07	88.5	14.05	98.1	16.23
	31	49.7	7.49	59.4	9.10	69.1	10.87	73.9	11.86	78.7	12.85	88.5	14.98	98.1	17.27
	33	49.7	7.91	59.4	9.63	69.1	11.55	73.9	12.59	78.7	13.68	88.5	15.92	98.1	18.42
	35	49.7	8.37	59.4	10.25	69.1	12.28	73.9	13.36	78.7	14.51	88.5	16.96	98.1	19.55
	37	49.7	8.84	59.4	10.81	69.1	13.00	73.9	14.20	78.7	15.39	88.5	18.00	98.1	20.81
	39	49.7	9.40	59.4	11.51	69.1	14.03	73.9	15.23	78.7	16.57	88.5	19.30	98.1	22.30
	41	48.4	10.20	57.9	12.61	67.3	15.24	72.1	16.64	76.7	17.98	86.2	21.18	95.6	24.23
	43	47.2	11.09	56.5	13.72	65.7	16.62	70.2	18.14	74.8	19.62	84.1	23.12	93.2	26.46
46	44.3	12.41	52.9	15.41	61.6	18.69	65.8	20.39	70.1	22.07	78.7	26.05	87.3	30.15	
48	39.1	10.82	46.8	13.44	54.5	16.33	58.2	17.80	62.1	19.29	69.7	22.78	77.3	26.38	
50	10	41.6	4.91	49.7	5.69	57.7	6.47	61.6	6.93	65.5	7.35	73.5	8.28	81.9	9.21
	12	41.6	4.96	49.7	5.75	57.7	6.57	61.6	7.03	65.5	7.51	73.5	8.43	81.9	9.37
	14	41.6	5.02	49.7	5.85	57.7	6.67	61.6	7.14	65.5	7.61	73.5	8.54	81.9	9.53
	16	41.6	5.12	49.7	5.95	57.7	6.78	61.6	7.30	65.5	7.71	73.5	8.69	81.9	9.68
	18	41.6	5.18	49.7	6.00	57.7	6.88	61.6	7.40	65.5	7.87	73.5	8.85	81.9	9.89
	20	41.6	5.23	49.7	6.11	57.7	7.03	61.6	7.51	65.5	8.02	73.5	9.00	81.9	10.09
	21	41.6	5.28	49.7	6.16	57.7	7.09	61.6	7.61	65.5	8.07	73.5	9.10	81.9	10.19
	23	41.6	5.39	49.7	6.26	57.7	7.20	61.6	7.71	65.5	8.23	73.5	9.27	81.9	10.40
	25	41.6	5.44	49.7	6.36	57.7	7.35	61.6	7.87	65.5	8.49	73.5	9.73	81.9	11.12
	27	41.6	5.54	49.7	6.57	57.7	7.76	61.6	8.38	65.5	9.00	73.5	10.40	81.9	11.85
	29	41.6	5.85	49.7	6.98	57.7	8.23	61.6	8.90	65.5	9.58	73.5	11.02	81.9	12.57
	31	41.6	6.16	49.7	7.40	57.7	8.74	61.6	9.42	65.5	10.19	73.5	11.75	81.9	13.41
	33	41.6	6.52	49.7	7.82	57.7	9.27	61.6	9.99	65.5	10.81	73.5	12.47	81.9	14.28
	35	41.6	6.88	49.7	8.28	57.7	9.78	61.6	10.61	65.5	11.44	73.5	13.19	81.9	15.16
	37	41.6	7.30	49.7	8.74	57.7	10.35	61.6	11.22	65.5	12.11	73.5	14.08	81.9	16.10
	39	41.6	7.79	49.7	9.38	57.7	11.09	61.6	12.09	65.5	13.00	73.5	15.00	81.9	17.38
	41	40.5	8.41	48.4	10.15	56.2	12.13	60.1	13.09	63.8	14.08	71.6	16.43	79.7	18.88
	43	39.5	9.15	47.2	11.04	54.8	13.19	58.5	14.26	62.3	15.33	69.9	17.92	77.8	20.59
46	37.0	10.25	44.3	12.39	51.3	14.80	54.8	16.00	58.4	17.20	65.5	20.16	72.9	23.18	
48	32.8	8.92	39.1	10.80	45.4	12.91	48.6	13.97	51.6	15.02	57.9	17.62	64.5	20.26	

Note

1. TC: Total Capacity(kW), PI : Power Input(kW, Comp. + Outdoor fan motor)
2. Capacity tables show the average value of conditions which may occur.

7. Capacity Tables

◆ A(C)RUN460LLS5

Combination (%)	Outdoor air temp (°C DB)	Indoor air temp. (DB/WB, °C)														Cooling Capacity(46HP)	
		20		23		26		27		28		30		32		TC	PI
		14		16		18		19		20		22		24			
		TC	PI	TC	PI	TC	PI	TC	PI	TC	PI	TC	PI	TC	PI		
130	10	127.6	14.80	152.0	18.09	162.8	20.99	167.5	21.41	172.2	21.59	180.5	21.76	185.1	21.85		
	12	127.6	15.17	152.0	18.74	162.8	21.85	167.5	22.00	172.2	22.17	180.5	22.35	185.1	22.55		
	14	127.6	15.68	152.0	19.42	162.8	22.67	167.5	22.84	172.2	23.02	180.5	23.20	185.1	23.41		
	16	127.6	16.26	152.0	20.10	162.8	23.69	167.5	23.91	172.2	24.10	180.5	24.31	185.1	24.51		
	18	127.6	16.93	152.0	21.26	162.8	24.78	167.5	25.32	172.2	25.52	180.5	25.77	185.1	25.94		
	20	127.6	17.68	152.0	22.65	162.8	26.00	167.5	27.84	172.2	28.07	177.8	28.34	182.6	28.54		
	21	127.6	18.14	152.0	23.44	162.8	26.54	167.5	29.46	172.2	29.70	176.9	30.00	181.5	30.20		
	23	127.6	19.47	152.0	24.66	162.8	27.92	167.5	32.52	170.0	32.77	174.3	33.10	178.9	33.32		
	25	127.6	20.79	152.0	26.08	162.8	29.84	165.5	36.06	167.5	36.34	172.2	36.71	176.9	36.96		
	27	127.6	22.25	152.0	27.88	160.8	31.80	162.8	39.70	165.5	40.02	170.0	40.41	174.3	40.69		
	29	127.6	23.71	152.0	29.80	158.2	34.21	160.5	43.63	162.8	43.89	167.5	44.28	172.2	44.45		
	31	127.6	25.30	151.4	31.39	155.5	36.39	158.2	43.44	160.5	43.71	164.9	44.09	169.5	44.26		
	33	127.6	26.95	148.8	33.27	153.5	39.03	156.0	43.04	158.2	43.31	162.8	43.69	167.0	43.86		
	35	127.6	28.74	146.2	34.83	150.9	42.27	153.5	42.48	156.0	42.74	160.3	43.12	164.9	43.29		
	37	127.6	30.65	144.2	36.56	148.8	41.71	150.9	41.93	153.5	42.18	157.6	42.55	162.4	42.72		
	39	127.6	32.64	141.6	38.48	146.2	41.16	148.8	41.36	150.9	41.61	155.5	41.98	160.3	42.15		
	41	124.3	34.62	135.7	40.40	140.3	40.60	142.4	40.80	145.2	41.04	149.5	41.41	153.6	41.58		
	43	121.2	36.51	130.0	39.83	134.6	40.04	136.6	40.24	139.4	40.48	143.6	40.84	147.5	41.01		
	46	113.6	39.08	118.7	39.01	123.0	39.20	124.9	39.40	127.4	39.63	131.5	39.99	135.1	40.15		
48	100.5	37.99	103.0	38.11	106.9	38.19	108.6	38.29	110.9	38.62	114.5	38.87	117.6	39.03			
120	10	115.4	13.32	137.3	16.33	150.0	19.41	154.6	20.97	159.1	21.31	167.8	21.39	171.8	21.56		
	12	115.4	13.68	137.3	16.88	150.0	20.19	154.6	21.41	159.1	22.10	167.8	22.36	171.8	22.54		
	14	115.4	14.15	137.3	17.45	150.0	21.01	154.6	22.23	159.1	22.90	167.8	23.24	171.8	23.42		
	16	115.4	14.66	137.3	18.17	150.0	21.81	154.6	23.06	159.1	23.96	167.8	24.26	171.8	24.45		
	18	115.4	15.23	137.3	18.99	150.0	22.69	154.6	24.28	159.1	25.19	167.8	25.47	171.8	25.69		
	20	115.4	15.81	137.3	20.13	150.0	23.91	154.6	25.54	159.1	26.53	167.8	26.88	171.8	27.08		
	21	115.4	16.29	137.3	20.86	150.0	24.58	154.6	26.29	159.1	27.40	167.8	27.75	171.8	27.97		
	23	115.4	17.42	137.3	22.32	150.0	26.33	154.6	27.94	159.1	29.21	167.8	29.50	171.8	29.74		
	25	115.4	18.61	137.3	23.91	150.0	27.77	154.6	29.78	159.1	31.32	165.8	31.58	169.8	31.83		
	27	115.4	19.87	137.3	25.56	150.0	29.56	154.6	31.83	159.1	33.66	163.3	33.89	167.3	34.16		
	29	115.4	21.19	137.3	27.28	150.0	31.11	154.6	34.06	156.6	35.87	160.7	36.41	165.2	36.71		
	31	115.4	22.58	137.3	29.14	150.0	32.72	152.5	36.48	154.6	38.49	158.7	39.16	162.6	39.48		
	33	115.4	24.04	137.3	31.06	147.9	34.60	150.0	39.60	152.0	41.32	156.1	41.79	160.1	42.13		
	35	115.4	25.56	137.3	33.11	145.4	36.63	147.4	43.63	150.0	43.84	154.1	43.98	158.1	44.33		
	37	115.4	27.50	137.3	34.94	143.3	39.05	145.4	42.70	147.4	42.92	151.5	43.05	155.7	43.39		
	39	115.4	29.60	136.8	36.93	140.8	41.41	142.9	41.83	144.9	42.04	149.5	42.17	153.6	42.50		
	41	112.5	31.71	130.8	38.91	135.2	40.60	137.1	40.96	139.1	41.16	143.1	41.28	147.2	41.61		
	43	109.7	33.84	125.3	38.36	129.7	39.70	131.5	40.07	133.4	40.27	137.4	40.40	141.4	40.72		
	46	102.8	36.39	114.3	37.45	118.4	38.44	120.1	38.76	122.0	38.96	125.6	39.07	129.4	39.38		
48	90.9	35.64	99.2	36.78	102.9	37.70	104.5	37.92	106.1	38.04	109.3	38.19	112.7	38.35			
110	10	103.4	11.98	123.3	14.60	137.7	17.35	141.7	18.78	150.6	20.20	154.1	20.77	164.5	21.11		
	12	103.4	12.35	123.3	15.10	137.7	18.07	141.7	19.30	150.6	20.96	154.1	21.64	164.5	22.13		
	14	103.4	12.74	123.3	15.77	137.7	18.88	141.7	20.25	150.6	22.02	154.1	22.65	164.5	23.12		
	16	103.4	13.19	123.3	16.35	137.7	19.66	141.7	21.14	150.6	23.04	154.1	23.66	164.5	24.08		
	18	103.4	13.68	123.3	17.03	137.7	20.79	141.7	22.27	150.6	24.30	154.1	24.78	164.5	25.24		
	20	103.4	14.16	123.3	17.88	137.7	22.05	141.7	23.29	150.6	25.47	154.1	26.11	164.5	26.53		
	21	103.4	14.48	123.3	18.41	137.7	22.62	141.7	23.91	150.6	26.19	154.1	26.85	164.5	27.27		
	23	103.4	15.43	123.3	19.73	137.7	23.88	141.7	25.25	150.6	27.67	154.1	28.26	164.5	28.73		
	25	103.4	16.49	123.3	21.06	137.7	25.23	141.7	26.69	150.6	29.23	154.1	29.65	162.6	30.25		
	27	103.4	17.62	123.3	22.52	137.7	26.66	141.7	28.25	150.6	30.52	154.1	31.23	160.1	31.76		
	29	103.4	18.81	123.3	24.04	137.7	28.17	141.7	29.92	150.6	32.26	154.1	32.82	158.1	33.31		
	31	103.4	20.00	123.3	25.62	137.7	29.77	141.7	31.70	148.1	33.90	152.1	34.56	155.7	34.92		
	33	103.4	21.33	123.3	27.28	137.7	31.46	141.7	33.59	146.1	35.79	149.7	36.39	153.6	36.59		
	35	103.4	22.65	123.3	29.14	137.7	33.22	141.7	35.59	143.7	37.78	147.2	38.12	151.1	38.32		
	37	103.4	24.01	123.3	30.92	137.7	35.07	139.7	37.70	141.2	39.85	145.2	39.98	148.6	40.10		
	39	103.4	25.88	123.3	32.87	135.2	37.00	137.1	40.33	139.2	41.82	142.6	41.89	146.7	41.93		
	41	100.8	27.75	120.1	34.80	129.5	39.03	131.5	43.63	133.2	43.63	137.1	43.98	140.5	44.33		
	43	98.2	29.14	117.1	36.26	124.0	41.38	126.1	41.85	127.7	41.76	131.5	42.00	134.8	42.11		
	46	92.1	28.44	109.8	35.00	113.2	39.28	115.2	39.28	116.6	39.61	120.2	39.83	123.3	39.94		
48	81.4	27.62	95.4	33.72	98.3	37.37	100.1	37.62	101.4	37.80	104.6	37.90	107.3	38.05			

Note

1. TC: Total Capacity(kW), PI: Power Input(kW, Comp. + Outdoor fan motor)
2. Capacity tables show the average value of conditions which may occur.

7. Capacity Tables

Combination (%)	Outdoor air temp (°C DB)	Cooling Capacity(46HP)													
		Indoor air temp. (DB/WB, °C)													
		20		23		26		27		28		30		32	
		14	PI	TC	PI	TC	PI	TC	PI	TC	PI	TC	PI	TC	PI
100	10	86.9	10.79	103.5	13.11	120.5	15.55	128.8	16.81	137.1	18.06	152.0	20.10	155.3	20.27
	12	86.9	11.14	103.5	13.64	120.5	16.08	128.8	17.26	137.1	18.64	152.0	21.19	155.3	21.39
	14	86.9	11.48	103.5	14.19	120.5	16.76	128.8	18.01	137.1	19.44	152.0	22.37	155.3	22.58
	16	86.9	11.83	103.5	14.66	120.5	17.47	128.8	18.86	137.1	20.49	152.0	23.45	155.3	23.78
	18	86.9	12.18	103.5	15.20	120.5	18.15	128.8	19.78	137.1	21.73	152.0	24.78	155.3	24.97
	20	86.9	12.62	103.5	15.79	120.5	19.21	128.8	21.19	137.1	23.24	152.0	25.96	155.3	26.17
	21	86.9	12.88	103.5	16.16	120.5	19.87	128.8	21.92	137.1	24.11	152.0	26.56	155.3	26.76
	23	86.9	13.64	103.5	17.28	120.5	21.33	128.8	23.51	137.1	25.82	152.0	27.80	155.3	28.03
	25	86.9	14.50	103.5	18.41	120.5	22.78	128.8	25.17	137.1	27.62	152.0	28.99	154.0	29.23
	27	86.9	15.50	103.5	19.67	120.5	24.37	128.8	26.88	137.1	29.36	149.0	30.35	152.2	30.60
	29	86.9	16.49	103.5	20.99	120.5	26.02	128.8	28.74	137.1	31.07	146.3	31.58	149.9	31.83
	31	86.9	17.62	103.5	22.38	120.5	27.75	128.8	30.66	137.1	32.65	144.0	32.80	147.6	33.07
	33	86.9	18.67	103.5	23.84	120.5	29.60	128.8	32.72	137.1	33.88	141.7	34.03	145.3	34.30
	35	86.9	19.87	103.5	25.37	120.5	31.53	128.8	34.90	135.0	35.10	139.2	35.25	142.7	35.52
	37	86.9	21.28	103.5	27.20	120.5	33.39	128.8	36.56	132.7	36.74	136.6	36.89	139.8	37.23
	39	86.9	22.82	103.5	29.23	120.5	35.39	128.8	38.35	130.6	38.52	134.4	38.66	137.5	39.03
	41	85.6	24.35	101.9	31.24	118.6	37.38	123.6	40.14	126.3	40.30	129.3	40.44	133.4	40.82
	43	82.6	25.77	98.4	33.12	114.5	39.16	118.5	41.68	119.8	41.82	123.5	41.96	126.8	42.35
46	77.5	27.72	92.2	35.71	107.4	41.54	108.2	43.63	109.3	43.76	112.9	43.88	115.9	44.30	
48	68.5	23.93	81.6	30.89	92.7	35.51	94.0	37.01	95.0	37.13	98.2	37.22	100.8	37.52	
90	10	78.2	9.43	93.4	11.33	108.6	13.36	115.9	14.40	123.3	15.50	138.5	17.35	153.6	19.29
	12	78.2	9.54	93.4	11.51	108.6	13.59	115.9	14.69	123.3	15.84	138.5	17.69	153.6	19.63
	14	78.2	9.72	93.4	11.74	108.6	13.88	115.9	14.98	123.3	16.13	138.5	18.04	153.6	20.03
	16	78.2	9.89	93.4	11.97	108.6	14.17	115.9	15.27	123.3	16.43	138.5	18.38	153.6	20.37
	18	78.2	10.06	93.4	12.20	108.6	14.40	115.9	15.62	123.3	16.77	138.5	18.78	153.6	21.40
	20	78.2	10.23	93.4	12.43	108.6	14.69	115.9	15.91	123.3	17.41	138.5	20.10	153.6	22.42
	21	78.2	10.35	93.4	12.55	108.6	14.98	115.9	16.43	123.3	18.04	138.5	20.42	153.6	22.94
	23	78.2	10.58	93.4	13.07	108.6	16.02	115.9	17.63	123.3	19.32	138.5	21.66	151.5	24.02
	25	78.2	11.11	93.4	13.93	108.6	17.12	115.9	18.85	123.3	20.64	138.5	23.16	149.3	25.04
	27	78.2	11.85	93.4	14.86	108.6	18.27	115.9	20.12	123.3	22.09	138.5	24.62	147.2	26.22
	29	78.2	12.55	93.4	15.84	108.6	19.54	115.9	21.52	123.3	23.60	138.5	26.08	144.9	27.27
	31	78.2	13.36	93.4	16.89	108.6	20.82	115.9	22.90	123.3	25.16	138.5	27.38	142.8	28.33
	33	78.2	14.23	93.4	17.99	108.6	22.21	115.9	24.41	123.3	26.68	138.5	28.71	140.6	29.38
	35	78.2	15.10	93.4	19.09	108.6	23.60	115.9	26.02	123.3	28.30	136.1	30.35	138.4	31.05
	37	78.2	16.02	93.4	20.30	108.6	25.16	115.9	27.64	123.3	29.87	133.9	31.73	136.2	32.44
	39	78.2	16.96	93.4	21.59	108.6	26.63	115.9	29.42	123.3	31.41	131.7	33.45	134.0	33.86
	41	76.2	18.98	91.0	23.94	105.8	29.23	112.9	32.17	120.1	33.91	126.2	35.25	128.4	36.06
	43	74.3	20.49	88.8	25.87	103.2	31.92	110.2	34.65	117.1	36.36	121.0	37.75	123.2	38.21
46	69.7	23.06	83.2	29.45	96.6	36.38	103.3	39.29	106.5	40.39	110.4	41.44	112.5	41.50	
48	61.6	20.15	73.6	25.76	85.5	31.82	91.3	34.27	92.4	34.81	96.0	35.67	97.8	35.72	
80	10	69.5	7.92	82.8	9.51	96.1	11.16	103.0	12.05	109.9	12.92	123.3	14.74	136.6	16.00
	12	69.5	8.08	82.8	9.62	96.1	11.38	103.0	12.26	109.9	13.14	123.3	15.01	136.6	16.32
	14	69.5	8.19	82.8	9.84	96.1	11.54	103.0	12.48	109.9	13.36	123.3	15.28	136.6	16.63
	16	69.5	8.30	82.8	10.01	96.1	11.76	103.0	12.70	109.9	13.63	123.3	15.62	136.6	16.95
	18	69.5	8.47	82.8	10.18	96.1	11.98	103.0	12.92	109.9	13.91	123.3	15.89	136.6	17.32
	20	69.5	8.63	82.8	10.40	96.1	12.26	103.0	13.19	109.9	14.19	123.3	16.49	136.6	18.35
	21	69.5	8.68	82.8	10.50	96.1	12.37	103.0	13.36	109.9	14.52	123.3	17.02	136.6	18.84
	23	69.5	8.85	82.8	10.67	96.1	12.92	103.0	14.19	109.9	15.50	123.3	17.97	136.6	19.77
	25	69.5	9.19	82.8	11.38	96.1	13.85	103.0	15.18	109.9	16.61	123.3	19.23	136.6	21.14
	27	69.5	9.73	82.8	12.10	96.1	14.79	103.0	16.22	109.9	17.70	123.3	20.43	136.6	22.24
	29	69.5	10.33	82.8	12.92	96.1	15.73	103.0	17.27	109.9	18.91	123.3	21.89	136.6	23.81
	31	69.5	11.00	82.8	13.69	96.1	16.77	103.0	18.42	109.9	20.13	123.3	23.23	136.6	25.00
	33	69.5	11.66	82.8	14.62	96.1	17.87	103.0	19.63	109.9	21.44	123.3	24.47	136.6	26.21
	35	69.5	12.37	82.8	15.50	96.1	19.03	103.0	20.90	109.9	22.87	123.3	25.95	135.2	27.16
	37	69.5	13.09	82.8	16.49	96.1	20.18	103.0	22.21	109.9	24.30	123.3	27.39	133.0	28.39
	39	69.5	13.83	82.8	17.43	96.1	21.58	103.0	23.88	109.9	26.12	123.3	28.93	130.8	29.95
	41	67.7	15.30	80.7	19.32	93.6	23.69	100.4	26.18	107.1	28.70	120.1	32.20	125.3	33.19
	43	66.0	16.85	78.7	21.07	91.3	25.87	97.9	28.53	104.5	31.36	117.1	34.46	120.1	35.53
46	61.9	18.74	73.8	23.74	85.6	29.14	91.8	31.76	97.9	35.38	107.2	37.61	109.7	38.22	
48	54.7	16.37	65.3	20.76	75.7	25.48	81.2	27.74	86.7	30.98	93.1	32.56	95.3	32.90	

Note
 1. TC: Total Capacity(kW), PI: Power Input(kW, Comp. + Outdoor fan motor)
 2. Capacity tables show the average value of conditions which may occur.

7. Capacity Tables

Combination (%)	Outdoor air temp (°C DB)	Cooling Capacity(46HP)													
		Indoor air temp. (DB/WB, °C)													
		20		23		26		27		28		30		32	
		14	16	18	19	20	22	24	TC	PI	TC	PI	TC	PI	
70	10	60.7	6.97	72.7	8.29	84.2	9.61	90.2	10.38	96.1	11.09	107.6	12.63	119.6	14.12
	12	60.7	7.08	72.7	8.40	84.2	9.82	90.2	10.54	96.1	11.31	107.6	12.85	119.6	14.39
	14	60.7	7.19	72.7	8.51	84.2	9.99	90.2	10.71	96.1	11.48	107.6	13.12	119.6	14.65
	16	60.7	7.30	72.7	8.67	84.2	10.16	90.2	10.93	96.1	11.69	107.6	13.34	119.6	14.96
	18	60.7	7.42	72.7	8.84	84.2	10.38	90.2	11.14	96.1	11.91	107.6	13.56	119.6	15.23
	20	60.7	7.52	72.7	9.00	84.2	10.54	90.2	11.36	96.1	12.18	107.6	13.89	119.6	15.81
	21	60.7	7.63	72.7	9.06	84.2	10.65	90.2	11.48	96.1	12.30	107.6	14.10	119.6	16.14
	23	60.7	7.74	72.7	9.27	84.2	10.87	90.2	11.86	96.1	12.90	107.6	15.10	119.6	17.05
	25	60.7	7.85	72.7	9.61	84.2	11.58	90.2	12.68	96.1	13.78	107.6	16.14	119.6	17.87
	27	60.7	8.29	72.7	10.26	84.2	12.35	90.2	13.45	96.1	14.72	107.6	17.24	119.6	19.00
	29	60.7	8.84	72.7	10.87	84.2	13.12	90.2	14.33	96.1	15.64	107.6	18.39	119.6	20.35
	31	60.7	9.39	72.7	11.58	84.2	14.00	90.2	15.32	96.1	16.69	107.6	19.60	119.6	21.59
	33	60.7	9.94	72.7	12.24	84.2	14.87	90.2	16.25	96.1	17.73	107.6	20.86	119.6	22.99
	35	60.7	10.49	72.7	13.07	84.2	15.81	90.2	17.29	96.1	18.88	107.6	22.24	119.6	24.38
	37	60.7	11.14	72.7	13.84	84.2	16.79	90.2	18.39	96.1	20.10	107.6	23.66	119.6	25.72
	39	60.7	11.84	72.7	14.75	84.2	17.96	90.2	19.79	96.1	21.71	107.6	25.32	119.6	27.74
	41	59.1	13.09	70.8	16.16	82.1	19.70	87.9	21.71	93.6	23.59	104.9	27.81	116.6	29.92
	43	57.7	14.24	69.0	17.62	80.0	21.50	85.7	23.66	91.3	25.77	102.3	30.38	113.6	32.35
46	54.1	15.83	64.7	19.81	75.0	24.21	80.3	26.35	85.6	29.04	95.9	34.27	106.5	36.05	
48	47.8	13.81	57.3	17.30	66.3	21.16	71.0	23.03	75.7	25.41	84.8	29.99	94.3	31.20	
60	10	52.0	6.02	62.1	7.07	72.2	8.23	77.3	8.82	82.3	9.37	92.5	10.63	102.6	11.89
	12	52.0	6.14	62.1	7.18	72.2	8.33	77.3	8.93	82.3	9.54	92.5	10.80	102.6	12.11
	14	52.0	6.19	62.1	7.29	72.2	8.49	77.3	9.09	82.3	9.70	92.5	11.02	102.6	12.33
	16	52.0	6.30	62.1	7.45	72.2	8.61	77.3	9.26	82.3	9.92	92.5	11.23	102.6	12.55
	18	52.0	6.42	62.1	7.56	72.2	8.77	77.3	9.42	82.3	10.09	92.5	11.40	102.6	12.82
	20	52.0	6.52	62.1	7.68	72.2	8.93	77.3	9.59	82.3	10.25	92.5	11.61	102.6	13.10
	21	52.0	6.57	62.1	7.73	72.2	9.04	77.3	9.70	82.3	10.35	92.5	11.78	102.6	13.21
	23	52.0	6.69	62.1	7.89	72.2	9.16	77.3	9.87	82.3	10.58	92.5	12.22	102.6	14.03
	25	52.0	6.80	62.1	8.06	72.2	9.54	77.3	10.35	82.3	11.23	92.5	13.04	102.6	15.01
	27	52.0	7.02	62.1	8.49	72.2	10.14	77.3	11.02	82.3	11.95	92.5	13.87	102.6	16.01
	29	52.0	7.45	62.1	9.04	72.2	10.80	77.3	11.73	82.3	12.71	92.5	14.80	102.6	17.10
	31	52.0	7.89	62.1	9.59	72.2	11.45	77.3	12.49	82.3	13.54	92.5	15.78	102.6	18.20
	33	52.0	8.33	62.1	10.14	72.2	12.16	77.3	13.26	82.3	14.41	92.5	16.77	102.6	19.40
	35	52.0	8.82	62.1	10.80	72.2	12.94	77.3	14.08	82.3	15.29	92.5	17.87	102.6	20.60
	37	52.0	9.32	62.1	11.39	72.2	13.70	77.3	14.96	82.3	16.22	92.5	18.96	102.6	21.92
	39	52.0	9.90	62.1	12.13	72.2	14.79	77.3	16.05	82.3	17.46	92.5	20.34	102.6	23.49
	41	50.6	10.75	60.5	13.28	70.4	16.06	75.3	17.53	80.2	18.95	90.1	22.31	100.0	25.53
	43	49.4	11.68	59.1	14.46	68.6	17.51	73.4	19.11	78.2	20.67	87.9	24.36	97.5	27.88
46	46.3	13.08	55.3	16.23	64.4	19.69	68.8	21.48	73.3	23.25	82.3	27.45	91.3	31.76	
48	40.9	11.40	49.0	14.16	56.9	17.20	60.9	18.76	64.9	20.32	72.9	24.00	80.8	27.79	
50	10	43.5	5.20	52.0	6.01	60.3	6.84	64.4	7.33	68.5	7.77	76.8	8.75	85.6	9.74
	12	43.5	5.25	52.0	6.08	60.3	6.95	64.4	7.44	68.5	7.94	76.8	8.91	85.6	9.90
	14	43.5	5.31	52.0	6.18	60.3	7.05	64.4	7.55	68.5	8.04	76.8	9.03	85.6	10.07
	16	43.5	5.42	52.0	6.29	60.3	7.17	64.4	7.71	68.5	8.15	76.8	9.19	85.6	10.23
	18	43.5	5.47	52.0	6.34	60.3	7.28	64.4	7.82	68.5	8.32	76.8	9.36	85.6	10.45
	20	43.5	5.52	52.0	6.46	60.3	7.44	64.4	7.94	68.5	8.48	76.8	9.52	85.6	10.67
	21	43.5	5.58	52.0	6.51	60.3	7.50	64.4	8.04	68.5	8.53	76.8	9.63	85.6	10.77
	23	43.5	5.69	52.0	6.62	60.3	7.61	64.4	8.15	68.5	8.70	76.8	9.80	85.6	11.00
	25	43.5	5.75	52.0	6.73	60.3	7.77	64.4	8.32	68.5	8.98	76.8	10.28	85.6	11.76
	27	43.5	5.85	52.0	6.95	60.3	8.20	64.4	8.86	68.5	9.52	76.8	11.00	85.6	12.53
	29	43.5	6.18	52.0	7.38	60.3	8.70	64.4	9.41	68.5	10.13	76.8	11.66	85.6	13.29
	31	43.5	6.51	52.0	7.82	60.3	9.24	64.4	9.96	68.5	10.77	76.8	12.42	85.6	14.17
	33	43.5	6.90	52.0	8.27	60.3	9.80	64.4	10.56	68.5	11.43	76.8	13.19	85.6	15.10
	35	43.5	7.28	52.0	8.75	60.3	10.34	64.4	11.22	68.5	12.09	76.8	13.95	85.6	16.03
	37	43.5	7.71	52.0	9.24	60.3	10.94	64.4	11.87	68.5	12.80	76.8	14.88	85.6	17.02
	39	43.5	8.23	52.0	9.92	60.3	11.73	64.4	12.78	68.5	13.74	76.8	15.86	85.6	18.38
	41	42.3	8.90	50.6	10.73	58.7	12.82	62.8	13.84	66.7	14.89	74.8	17.37	83.3	19.96
	43	41.3	9.67	49.4	11.67	57.3	13.95	61.2	15.08	65.1	16.21	73.0	18.95	81.4	21.77
46	38.7	10.84	46.3	13.09	53.6	15.65	57.3	16.92	61.0	18.19	68.4	21.32	76.2	24.51	
48	34.3	9.44	40.9	11.41	47.4	13.65	50.8	14.77	54.0	15.88	60.5	18.63	67.4	21.42	

Note

- 1. TC: Total Capacity(kW), PI : Power Input(kW, Comp. + Outdoor fan motor)
- 2. Capacity tables show the average value of conditions which may occur.

7. Capacity Tables

◆ A(C)RUN480LLS5

Combination (%)	Outdoor air temp (°C DB)	Indoor air temp. (DB/WB, °C)														Cooling Capacity(48HP)	
		20		23		26		27		28		30		32		TC	PI
		14		16		18		19		20		22		24			
		TC	PI	TC	PI	TC	PI	TC	PI	TC	PI	TC	PI	TC	PI		
130	10	133.1	15.95	158.6	19.49	169.9	22.61	174.8	23.07	179.6	23.26	188.3	23.44	193.1	23.54		
	12	133.1	16.34	158.6	20.19	169.9	23.54	174.8	23.70	179.6	23.88	188.3	24.08	193.1	24.29		
	14	133.1	16.90	158.6	20.92	169.9	24.42	174.8	24.60	179.6	24.80	188.3	25.00	193.1	25.22		
	16	133.1	17.51	158.6	21.65	169.9	25.52	174.8	25.76	179.6	25.96	188.3	26.20	193.1	26.41		
	18	133.1	18.24	158.6	22.90	169.9	26.70	174.8	27.27	179.6	27.49	188.3	27.76	193.1	27.95		
	20	133.1	19.05	158.6	24.40	169.9	28.02	174.8	29.99	179.6	30.24	185.6	30.53	190.5	30.75		
	21	133.1	19.54	158.6	25.26	169.9	28.60	174.8	31.74	179.6	32.00	184.6	32.32	189.4	32.54		
	23	133.1	20.97	158.6	26.57	169.9	30.08	174.8	35.03	177.4	35.31	181.8	35.66	186.7	35.90		
	25	133.1	22.40	158.6	28.09	169.9	32.14	172.7	38.85	174.8	39.16	179.6	39.55	184.6	39.82		
	27	133.1	23.97	158.6	30.04	167.8	34.25	169.9	42.77	172.7	43.11	177.4	43.53	181.8	43.84		
	29	133.1	25.54	158.6	32.11	165.0	36.86	167.4	47.00	169.9	47.29	174.8	47.71	179.6	47.89		
	31	133.1	27.26	158.0	33.82	162.3	39.21	165.0	46.80	167.4	47.09	172.1	47.51	176.9	47.69		
	33	133.1	29.03	155.3	35.84	160.2	42.05	162.8	46.37	165.0	46.66	169.9	47.07	174.2	47.25		
	35	133.1	30.97	152.5	37.53	157.5	45.54	160.2	45.77	162.8	46.04	167.2	46.46	172.1	46.64		
	37	133.1	33.02	150.4	39.39	155.3	44.94	157.5	45.17	160.2	45.44	164.5	45.84	169.4	46.02		
	39	133.1	35.16	147.7	41.45	152.5	44.34	155.3	44.56	157.5	44.83	162.3	45.23	167.2	45.41		
	41	129.8	37.30	141.6	43.53	146.4	43.74	148.6	43.96	151.5	44.22	156.0	44.62	160.3	44.79		
	43	126.5	39.34	135.7	42.92	140.5	43.13	142.5	43.35	145.4	43.62	149.9	44.00	154.0	44.18		
46	118.5	42.10	123.8	42.03	128.3	42.23	130.3	42.45	133.0	42.70	137.2	43.08	141.0	43.26			
48	104.9	40.93	107.5	41.05	111.5	41.14	113.3	41.25	115.7	41.61	119.4	41.88	122.8	42.04			
120	10	120.4	14.35	143.2	17.59	156.5	20.91	161.3	22.60	166.0	22.96	175.0	23.05	179.3	23.23		
	12	120.4	14.73	143.2	18.19	156.5	21.75	161.3	23.07	166.0	23.80	175.0	24.09	179.3	24.28		
	14	120.4	15.24	143.2	18.80	156.5	22.63	161.3	23.95	166.0	24.67	175.0	25.04	179.3	25.24		
	16	120.4	15.80	143.2	19.58	156.5	23.50	161.3	24.84	166.0	25.81	175.0	26.14	179.3	26.34		
	18	120.4	16.41	143.2	20.46	156.5	24.44	161.3	26.15	166.0	27.14	175.0	27.44	179.3	27.67		
	20	120.4	17.03	143.2	21.69	156.5	25.76	161.3	27.52	166.0	28.58	175.0	28.96	179.3	29.18		
	21	120.4	17.55	143.2	22.47	156.5	26.48	161.3	28.33	166.0	29.52	175.0	29.90	179.3	30.13		
	23	120.4	18.76	143.2	24.04	156.5	28.37	161.3	30.10	166.0	31.47	175.0	31.78	179.3	32.04		
	25	120.4	20.05	143.2	25.76	156.5	29.92	161.3	32.09	166.0	33.75	173.0	34.02	177.2	34.30		
	27	120.4	21.40	143.2	27.54	156.5	31.85	161.3	34.29	166.0	36.26	170.4	36.51	174.6	36.80		
	29	120.4	22.83	143.2	29.39	156.5	33.51	161.3	36.69	163.4	38.65	167.6	39.23	172.4	39.55		
	31	120.4	24.33	143.2	31.40	156.5	35.25	159.2	39.30	161.3	41.47	165.6	42.19	169.7	42.53		
	33	120.4	25.90	143.2	33.46	154.4	37.28	156.5	42.66	158.6	44.52	162.9	45.03	167.1	45.39		
	35	120.4	27.54	143.2	35.67	151.8	39.46	153.8	47.00	156.5	47.24	160.8	47.38	165.0	47.76		
	37	120.4	29.63	143.2	37.64	149.6	42.07	151.8	46.01	153.8	46.24	158.1	46.38	162.4	46.75		
	39	120.4	31.89	142.7	39.79	147.0	44.62	149.1	45.07	151.2	45.30	156.0	45.43	160.2	45.79		
	41	117.4	34.16	136.5	41.92	141.1	43.74	143.1	44.12	145.1	44.34	149.4	44.47	153.6	44.83		
	43	114.5	36.46	130.7	41.33	135.3	42.77	137.2	43.17	139.2	43.39	143.4	43.53	147.5	43.87		
46	107.3	39.21	119.3	40.35	123.5	41.42	125.4	41.76	127.3	41.97	131.1	42.10	135.0	42.43			
48	94.9	38.40	103.6	39.63	107.4	40.61	109.1	40.85	110.7	40.98	114.1	41.15	117.6	41.32			
110	10	107.9	12.91	128.7	15.73	143.7	18.69	147.8	20.23	157.1	21.77	160.8	22.38	171.7	22.74		
	12	107.9	13.31	128.7	16.27	143.7	19.47	147.8	20.79	157.1	22.58	160.8	23.32	171.7	23.85		
	14	107.9	13.72	128.7	16.99	143.7	20.34	147.8	21.82	157.1	23.72	160.8	24.40	171.7	24.91		
	16	107.9	14.21	128.7	17.61	143.7	21.19	147.8	22.78	157.1	24.82	160.8	25.49	171.7	25.94		
	18	107.9	14.74	128.7	18.35	143.7	22.40	147.8	23.99	157.1	26.18	160.8	26.70	171.7	27.19		
	20	107.9	15.26	128.7	19.27	143.7	23.76	147.8	25.09	157.1	27.44	160.8	28.13	171.7	28.58		
	21	107.9	15.60	128.7	19.83	143.7	24.37	147.8	25.76	157.1	28.22	160.8	28.92	171.7	29.38		
	23	107.9	16.63	128.7	21.26	143.7	25.73	147.8	27.20	157.1	29.81	160.8	30.44	171.7	30.95		
	25	107.9	17.77	128.7	22.69	143.7	27.18	147.8	28.76	157.1	31.49	160.8	31.94	169.6	32.59		
	27	107.9	18.98	128.7	24.26	143.7	28.72	147.8	30.44	157.1	32.88	160.8	33.64	167.1	34.22		
	29	107.9	20.26	128.7	25.90	143.7	30.35	147.8	32.23	157.1	34.76	160.8	35.36	165.0	35.89		
	31	107.9	21.55	128.7	27.61	143.7	32.07	147.8	34.15	154.6	36.52	158.7	37.24	162.4	37.62		
	33	107.9	22.97	128.7	29.39	143.7	33.89	147.8	36.19	152.5	38.56	156.2	39.21	160.3	39.42		
	35	107.9	24.40	128.7	31.40	143.7	35.79	147.8	38.34	149.9	40.71	153.6	41.07	157.7	41.28		
	37	107.9	25.86	128.7	33.32	143.7	37.78	145.8	40.62	147.3	42.93	151.5	43.08	155.1	43.20		
	39	107.9	27.88	128.7	35.41	141.1	39.86	143.1	43.45	145.3	45.05	148.8	45.14	153.0	45.18		
	41	105.2	29.90	125.4	37.49	135.1	42.04	137.2	47.00	139.0	47.00	143.0	47.38	146.6	47.76		
	43	102.5	31.40	122.2	39.06	129.4	44.58	131.6	45.08	133.3	44.99	137.2	45.24	140.7	45.37		
46	96.1	30.64	114.6	37.71	118.1	42.31	120.2	42.31	121.7	42.68	125.4	42.91	128.7	43.02			
48	85.0	29.76	99.5	36.33	102.6	40.26	104.5	40.53	105.8	40.72	109.1	40.84	111.9	41.00			

Note

1. TC: Total Capacity(kW), PI : Power Input(kW, Comp. + Outdoor fan motor)
2. Capacity tables show the average value of conditions which may occur.

7. Capacity Tables

Combination (%)	Outdoor air temp (°C DB)	Cooling Capacity(48HP)													
		Indoor air temp. (DB/WB, °C)													
		20		23		26		27		28		30		32	
		14	16	18	19	20	22	24							
	TC	PI	TC	PI	TC	PI	TC	PI	TC	PI	TC	PI	TC	PI	
100	10	90.7	11.62	108.0	14.12	125.7	16.76	134.4	18.11	143.1	19.45	158.6	21.66	162.1	21.83
	12	90.7	12.00	108.0	14.70	125.7	17.32	134.4	18.60	143.1	20.08	158.6	22.83	162.1	23.05
	14	90.7	12.37	108.0	15.29	125.7	18.06	134.4	19.40	143.1	20.95	158.6	24.10	162.1	24.33
	16	90.7	12.75	108.0	15.80	125.7	18.82	134.4	20.32	143.1	22.07	158.6	25.27	162.1	25.62
	18	90.7	13.12	108.0	16.38	125.7	19.56	134.4	21.31	143.1	23.41	158.6	26.70	162.1	26.90
	20	90.7	13.59	108.0	17.01	125.7	20.69	134.4	22.83	143.1	25.04	158.6	27.97	162.1	28.20
	21	90.7	13.88	108.0	17.41	125.7	21.40	134.4	23.61	143.1	25.97	158.6	28.61	162.1	28.84
	23	90.7	14.70	108.0	18.62	125.7	22.97	134.4	25.33	143.1	27.82	158.6	29.96	162.1	30.20
	25	90.7	15.62	108.0	19.83	125.7	24.55	134.4	27.11	143.1	29.75	158.6	31.24	160.7	31.49
	27	90.7	16.70	108.0	21.19	125.7	26.25	134.4	28.96	143.1	31.63	155.5	32.70	158.8	32.97
	29	90.7	17.77	108.0	22.62	125.7	28.04	134.4	30.97	143.1	33.48	152.6	34.02	156.4	34.29
	31	90.7	18.98	108.0	24.11	125.7	29.90	134.4	33.03	143.1	35.18	150.3	35.34	154.0	35.63
	33	90.7	20.12	108.0	25.69	125.7	31.89	134.4	35.25	143.1	36.50	147.9	36.66	151.6	36.95
	35	90.7	21.40	108.0	27.33	125.7	33.96	134.4	37.60	140.9	37.82	145.3	37.98	149.0	38.27
	37	90.7	22.92	108.0	29.31	125.7	35.97	134.4	39.39	138.5	39.59	142.5	39.75	145.9	40.11
	39	90.7	24.58	108.0	31.49	125.7	38.12	134.4	41.32	136.2	41.50	140.3	41.65	143.5	42.04
	41	89.3	26.23	106.3	33.66	123.7	40.27	129.0	43.24	131.8	43.42	134.9	43.57	139.2	43.98
	43	86.2	27.76	102.6	35.68	119.5	42.19	123.7	44.90	125.0	45.05	128.9	45.21	132.3	45.63
46	80.8	29.86	96.2	38.47	112.0	44.76	112.9	47.00	114.1	47.14	117.8	47.27	120.9	47.72	
48	71.5	25.78	85.1	33.28	96.7	38.25	98.1	39.88	99.1	40.01	102.4	40.10	105.2	40.42	
90	10	81.6	10.09	97.5	12.12	113.3	14.29	120.9	15.41	128.7	16.59	144.5	18.56	160.3	20.64
	12	81.6	10.21	97.5	12.32	113.3	14.54	120.9	15.72	128.7	16.95	144.5	18.92	160.3	21.00
	14	81.6	10.40	97.5	12.56	113.3	14.85	120.9	16.03	128.7	17.26	144.5	19.30	160.3	21.43
	16	81.6	10.58	97.5	12.81	113.3	15.16	120.9	16.33	128.7	17.58	144.5	19.66	160.3	21.80
	18	81.6	10.76	97.5	13.06	113.3	15.41	120.9	16.71	128.7	17.94	144.5	20.10	160.3	22.90
	20	81.6	10.95	97.5	13.30	113.3	15.72	120.9	17.02	128.7	18.63	144.5	21.51	160.3	23.99
	21	81.6	11.07	97.5	13.42	113.3	16.03	120.9	17.58	128.7	19.30	144.5	21.85	160.3	24.54
	23	81.6	11.32	97.5	13.98	113.3	17.14	120.9	18.87	128.7	20.67	144.5	23.17	158.1	25.70
	25	81.6	11.88	97.5	14.91	113.3	18.32	120.9	20.17	128.7	22.09	144.5	24.78	155.8	26.79
	27	81.6	12.68	97.5	15.90	113.3	19.55	120.9	21.53	128.7	23.64	144.5	26.34	153.6	28.05
	29	81.6	13.42	97.5	16.95	113.3	20.91	120.9	23.02	128.7	25.25	144.5	27.91	151.2	29.18
	31	81.6	14.29	97.5	18.07	113.3	22.28	120.9	24.51	128.7	26.92	144.5	29.30	149.0	30.31
	33	81.6	15.23	97.5	19.25	113.3	23.77	120.9	26.12	128.7	28.55	144.5	30.71	146.7	31.44
	35	81.6	16.15	97.5	20.42	113.3	25.25	120.9	27.84	128.7	30.28	142.0	32.47	144.4	33.23
	37	81.6	17.14	97.5	21.72	113.3	26.92	120.9	29.58	128.7	31.96	139.7	33.95	142.1	34.71
	39	81.6	18.15	97.5	23.10	113.3	28.49	120.9	31.48	128.7	33.61	137.4	35.80	139.8	36.23
	41	79.5	20.31	94.9	25.61	110.4	31.27	117.8	34.42	125.4	36.28	131.7	37.72	134.0	38.58
	43	77.5	21.92	92.6	27.68	107.6	34.15	115.0	37.08	122.2	38.91	126.3	40.39	128.5	40.88
46	72.7	24.67	86.8	31.51	100.8	38.92	107.8	42.04	111.1	43.22	115.2	44.34	117.4	44.41	
48	64.3	21.56	76.8	27.57	89.2	34.05	95.3	36.67	96.4	37.24	100.2	38.17	102.1	38.22	
80	10	72.5	8.41	86.4	10.11	100.3	11.86	107.5	12.80	114.7	13.73	128.7	15.66	142.5	17.00
	12	72.5	8.59	86.4	10.22	100.3	12.09	107.5	13.02	114.7	13.96	128.7	15.95	142.5	17.34
	14	72.5	8.70	86.4	10.45	100.3	12.26	107.5	13.26	114.7	14.19	128.7	16.24	142.5	17.67
	16	72.5	8.82	86.4	10.63	100.3	12.50	107.5	13.49	114.7	14.48	128.7	16.59	142.5	18.01
	18	72.5	9.00	86.4	10.81	100.3	12.73	107.5	13.73	114.7	14.78	128.7	16.88	142.5	18.40
	20	72.5	9.17	86.4	11.04	100.3	13.02	107.5	14.02	114.7	15.08	128.7	17.52	142.5	19.49
	21	72.5	9.22	86.4	11.16	100.3	13.14	107.5	14.19	114.7	15.42	128.7	18.08	142.5	20.01
	23	72.5	9.40	86.4	11.33	100.3	13.73	107.5	15.08	114.7	16.47	128.7	19.09	142.5	21.01
	25	72.5	9.76	86.4	12.09	100.3	14.72	107.5	16.13	114.7	17.64	128.7	20.43	142.5	22.46
	27	72.5	10.34	86.4	12.85	100.3	15.71	107.5	17.23	114.7	18.81	128.7	21.70	142.5	23.63
	29	72.5	10.98	86.4	13.73	100.3	16.71	107.5	18.35	114.7	20.09	128.7	23.25	142.5	25.29
	31	72.5	11.68	86.4	14.54	100.3	17.81	107.5	19.57	114.7	21.39	128.7	24.68	142.5	26.56
	33	72.5	12.38	86.4	15.53	100.3	18.98	107.5	20.85	114.7	22.78	128.7	26.00	142.5	27.84
	35	72.5	13.14	86.4	16.47	100.3	20.21	107.5	22.20	114.7	24.30	128.7	27.57	141.0	28.85
	37	72.5	13.90	86.4	17.52	100.3	21.44	107.5	23.60	114.7	25.82	128.7	29.09	138.8	30.16
	39	72.5	14.70	86.4	18.52	100.3	22.93	107.5	25.37	114.7	27.75	128.7	30.74	136.5	31.82
	41	70.7	16.25	84.2	20.52	97.7	25.17	104.7	27.81	111.7	30.49	125.4	34.21	130.7	35.26
	43	68.9	17.90	82.1	22.39	95.3	27.48	102.1	30.31	109.1	33.32	122.2	36.61	125.4	37.75
46	64.6	19.91	77.0	25.22	89.3	30.95	95.8	33.74	102.1	37.59	111.8	39.96	114.4	40.61	
48	57.1	17.39	68.1	22.06	79.0	27.07	84.7	29.47	90.4	32.91	97.1	34.59	99.5	34.95	

Note

1. TC: Total Capacity(kW), PI : Power Input(kW, Comp. + Outdoor fan motor)
2. Capacity tables show the average value of conditions which may occur.

7. Capacity Tables

Combination (%)	Outdoor air temp (°C DB)	Cooling Capacity(48HP)													
		Indoor air temp. (DB/WB, °C)													
		20		23		26		27		28		30		32	
		14	16	18	19	20	22	24							
	TC	PI	TC	PI	TC	PI	TC	PI	TC	PI	TC	PI	TC	PI	
70	10	63.3	7.35	75.9	8.75	87.9	10.14	94.1	10.95	100.3	11.69	112.3	13.32	124.8	14.89
	12	63.3	7.47	75.9	8.86	87.9	10.36	94.1	11.12	100.3	11.93	112.3	13.55	124.8	15.18
	14	63.3	7.59	75.9	8.98	87.9	10.54	94.1	11.29	100.3	12.10	112.3	13.84	124.8	15.45
	16	63.3	7.70	75.9	9.15	87.9	10.71	94.1	11.53	100.3	12.33	112.3	14.07	124.8	15.78
	18	63.3	7.82	75.9	9.32	87.9	10.95	94.1	11.75	100.3	12.56	112.3	14.30	124.8	16.06
	20	63.3	7.93	75.9	9.49	87.9	11.12	94.1	11.98	100.3	12.85	112.3	14.65	124.8	16.68
	21	63.3	8.04	75.9	9.56	87.9	11.24	94.1	12.10	100.3	12.97	112.3	14.88	124.8	17.03
	23	63.3	8.17	75.9	9.78	87.9	11.46	94.1	12.51	100.3	13.61	112.3	15.92	124.8	17.98
	25	63.3	8.28	75.9	10.14	87.9	12.22	94.1	13.37	100.3	14.53	112.3	17.02	124.8	18.85
	27	63.3	8.75	75.9	10.83	87.9	13.03	94.1	14.19	100.3	15.52	112.3	18.18	124.8	20.04
	29	63.3	9.32	75.9	11.46	87.9	13.84	94.1	15.11	100.3	16.50	112.3	19.39	124.8	21.47
	31	63.3	9.90	75.9	12.22	87.9	14.76	94.1	16.16	100.3	17.60	112.3	20.67	124.8	22.77
	33	63.3	10.48	75.9	12.91	87.9	15.69	94.1	17.13	100.3	18.70	112.3	22.00	124.8	24.25
	35	63.3	11.06	75.9	13.79	87.9	16.68	94.1	18.24	100.3	19.92	112.3	23.45	124.8	25.71
	37	63.3	11.75	75.9	14.60	87.9	17.71	94.1	19.39	100.3	21.20	112.3	24.96	124.8	27.13
	39	63.3	12.48	75.9	15.56	87.9	18.94	94.1	20.87	100.3	22.89	112.3	26.71	124.8	29.26
	41	61.7	13.80	73.9	17.05	85.6	20.78	91.7	22.89	97.7	24.89	109.5	29.33	121.6	31.56
	43	60.2	15.02	72.0	18.58	83.5	22.68	89.4	24.96	95.3	27.18	106.7	32.04	118.6	34.12
46	56.5	16.70	67.6	20.89	78.3	25.53	83.8	27.80	89.3	30.63	100.0	36.14	111.1	38.03	
48	49.9	14.57	59.8	18.25	69.2	22.32	74.1	24.29	79.0	26.80	88.5	31.63	98.4	32.91	
60	10	54.3	6.31	64.8	7.40	75.3	8.61	80.7	9.23	85.9	9.81	96.5	11.13	107.1	12.45
	12	54.3	6.43	64.8	7.52	75.3	8.72	80.7	9.36	85.9	9.99	96.5	11.31	107.1	12.68
	14	54.3	6.48	64.8	7.64	75.3	8.89	80.7	9.52	85.9	10.15	96.5	11.54	107.1	12.91
	16	54.3	6.60	64.8	7.80	75.3	9.01	80.7	9.70	85.9	10.39	96.5	11.76	107.1	13.14
	18	54.3	6.72	64.8	7.91	75.3	9.18	80.7	9.87	85.9	10.56	96.5	11.94	107.1	13.42
	20	54.3	6.83	64.8	8.04	75.3	9.36	80.7	10.04	85.9	10.73	96.5	12.16	107.1	13.71
	21	54.3	6.88	64.8	8.09	75.3	9.47	80.7	10.15	85.9	10.84	96.5	12.34	107.1	13.83
	23	54.3	7.01	64.8	8.26	75.3	9.59	80.7	10.33	85.9	11.07	96.5	12.79	107.1	14.69
	25	54.3	7.12	64.8	8.44	75.3	9.99	80.7	10.84	85.9	11.76	96.5	13.66	107.1	15.72
	27	54.3	7.35	64.8	8.89	75.3	10.62	80.7	11.54	85.9	12.51	96.5	14.52	107.1	16.76
	29	54.3	7.80	64.8	9.47	75.3	11.31	80.7	12.28	85.9	13.31	96.5	15.50	107.1	17.90
	31	54.3	8.26	64.8	10.04	75.3	11.99	80.7	13.08	85.9	14.18	96.5	16.53	107.1	19.05
	33	54.3	8.72	64.8	10.62	75.3	12.74	80.7	13.89	85.9	15.09	96.5	17.56	107.1	20.32
	35	54.3	9.23	64.8	11.31	75.3	13.55	80.7	14.74	85.9	16.01	96.5	18.71	107.1	21.57
	37	54.3	9.75	64.8	11.93	75.3	14.34	80.7	15.66	85.9	16.98	96.5	19.85	107.1	22.96
	39	54.3	10.37	64.8	12.70	75.3	15.48	80.7	16.80	85.9	18.28	96.5	21.29	107.1	24.60
	41	52.8	11.25	63.1	13.91	73.5	16.82	78.6	18.36	83.7	19.84	94.0	23.36	104.3	26.73
	43	51.5	12.23	61.6	15.14	71.6	18.33	76.6	20.01	81.6	21.64	91.7	25.50	101.7	29.19
46	48.3	13.69	57.8	17.00	67.2	20.61	71.8	22.49	76.5	24.35	85.9	28.74	95.3	33.26	
48	42.7	11.94	51.1	14.83	59.4	18.01	63.5	19.64	67.7	21.28	76.0	25.13	84.4	29.10	
50	10	45.4	5.40	54.3	6.25	62.9	7.11	67.2	7.62	71.5	8.07	80.1	9.10	89.3	10.13
	12	45.4	5.46	54.3	6.32	62.9	7.22	67.2	7.73	71.5	8.25	80.1	9.27	89.3	10.29
	14	45.4	5.52	54.3	6.43	62.9	7.33	67.2	7.85	71.5	8.36	80.1	9.39	89.3	10.47
	16	45.4	5.63	54.3	6.54	62.9	7.45	67.2	8.02	71.5	8.47	80.1	9.55	89.3	10.63
	18	45.4	5.69	54.3	6.59	62.9	7.56	67.2	8.13	71.5	8.65	80.1	9.73	89.3	10.87
	20	45.4	5.74	54.3	6.71	62.9	7.73	67.2	8.25	71.5	8.81	80.1	9.89	89.3	11.09
	21	45.4	5.80	54.3	6.77	62.9	7.80	67.2	8.36	71.5	8.87	80.1	10.01	89.3	11.20
	23	45.4	5.92	54.3	6.88	62.9	7.91	67.2	8.47	71.5	9.04	80.1	10.18	89.3	11.43
	25	45.4	5.97	54.3	6.99	62.9	8.07	67.2	8.65	71.5	9.33	80.1	10.69	89.3	12.22
	27	45.4	6.08	54.3	7.22	62.9	8.53	67.2	9.21	71.5	9.89	80.1	11.43	89.3	13.02
	29	45.4	6.43	54.3	7.67	62.9	9.04	67.2	9.78	71.5	10.52	80.1	12.11	89.3	13.81
	31	45.4	6.77	54.3	8.13	62.9	9.61	67.2	10.35	71.5	11.20	80.1	12.91	89.3	14.73
	33	45.4	7.17	54.3	8.59	62.9	10.18	67.2	10.98	71.5	11.88	80.1	13.70	89.3	15.69
	35	45.4	7.56	54.3	9.10	62.9	10.74	67.2	11.66	71.5	12.57	80.1	14.50	89.3	16.66
	37	45.4	8.02	54.3	9.61	62.9	11.37	67.2	12.34	71.5	13.31	80.1	15.47	89.3	17.69
	39	45.4	8.56	54.3	10.31	62.9	12.19	67.2	13.29	71.5	14.28	80.1	16.48	89.3	19.10
	41	44.2	9.25	52.8	11.15	61.3	13.32	65.5	14.39	69.6	15.47	78.1	18.06	87.0	20.74
	43	43.1	10.05	51.5	12.13	59.8	14.50	63.9	15.67	68.0	16.84	76.2	19.70	84.9	22.63
46	40.4	11.26	48.3	13.61	56.0	16.27	59.8	17.59	63.7	18.91	71.4	22.16	79.5	25.48	
48	35.8	9.81	42.7	11.86	49.5	14.19	53.0	15.35	56.3	16.50	63.1	19.36	70.3	22.26	

Note

1. TC: Total Capacity(kW), PI : Power Input(kW, Comp. + Outdoor fan motor)
2. Capacity tables show the average value of conditions which may occur.

7. Capacity Tables

◆ A(C)RUN500LLS5

Combination (%)	Outdoor air temp (°C DB)	Indoor air temp. (DB/WB, °C)													
		20		23		26		27		28		30		32	
		14		16		18		19		20		22		24	
		TC	PI	TC	PI	TC	PI	TC	PI	TC	PI	TC	PI	TC	PI
130	10	138.7	16.54	165.2	20.22	177.0	23.46	182.1	23.93	187.1	24.13	196.2	24.32	201.2	24.41
	12	138.7	16.95	165.2	20.94	177.0	24.42	182.1	24.58	187.1	24.77	196.2	24.97	201.2	25.20
	14	138.7	17.53	165.2	21.70	177.0	25.33	182.1	25.52	187.1	25.73	196.2	25.93	201.2	26.16
	16	138.7	18.17	165.2	22.46	177.0	26.47	182.1	26.72	187.1	26.93	196.2	27.17	201.2	27.39
	18	138.7	18.92	165.2	23.76	177.0	27.69	182.1	28.29	187.1	28.52	196.2	28.80	201.2	28.99
	20	138.7	19.76	165.2	25.31	177.0	29.06	182.1	31.11	187.1	31.37	193.3	31.67	198.4	31.89
	21	138.7	20.27	165.2	26.20	177.0	29.66	182.1	32.93	187.1	33.19	192.3	33.52	197.3	33.75
	23	138.7	21.75	165.2	27.56	177.0	31.20	182.1	36.33	184.8	36.62	189.4	36.99	194.4	37.24
	25	138.7	23.23	165.2	29.14	177.0	33.34	179.9	40.29	182.1	40.61	187.1	41.02	192.3	41.30
	27	138.7	24.86	165.2	31.16	174.8	35.53	177.0	44.36	179.9	44.72	184.8	45.15	189.4	45.47
	29	138.7	26.49	165.2	33.30	171.9	38.23	174.4	48.75	177.0	49.05	182.1	49.48	187.1	49.67
	31	138.7	28.27	164.6	35.08	169.1	40.67	171.9	48.54	174.4	48.84	179.2	49.27	184.3	49.47
	33	138.7	30.12	161.7	37.18	166.9	43.61	169.6	48.10	171.9	48.39	177.0	48.82	181.5	49.01
	35	138.7	32.12	158.9	38.93	164.0	47.23	166.9	47.48	169.6	47.76	174.2	48.19	179.2	48.38
	37	138.7	34.25	156.7	40.85	161.7	46.61	164.0	46.85	166.9	47.13	171.4	47.55	176.5	47.74
	39	138.7	36.47	153.9	43.00	158.9	45.99	161.7	46.22	164.0	46.50	169.1	46.91	174.2	47.10
	41	135.2	38.69	147.5	45.15	152.5	45.37	154.8	45.60	157.8	45.87	162.5	46.28	166.9	46.46
	43	131.8	40.80	141.4	44.51	146.3	44.74	148.5	44.96	151.5	45.24	156.1	45.64	160.4	45.82
46	123.5	43.67	129.0	43.59	133.6	43.80	135.7	44.03	138.5	44.29	142.9	44.68	146.9	44.87	
48	109.2	42.45	112.0	42.58	116.2	42.68	118.1	42.79	120.6	43.16	124.4	43.44	127.9	43.61	
120	10	125.4	14.89	149.2	18.25	163.1	21.69	168.0	23.44	172.9	23.81	182.3	23.90	186.8	24.09
	12	125.4	15.28	149.2	18.86	163.1	22.56	168.0	23.93	172.9	24.69	182.3	24.99	186.8	25.18
	14	125.4	15.81	149.2	19.50	163.1	23.47	168.0	24.84	172.9	25.59	182.3	25.97	186.8	26.18
	16	125.4	16.38	149.2	20.30	163.1	24.38	168.0	25.76	172.9	26.78	182.3	27.11	186.8	27.32
	18	125.4	17.02	149.2	21.22	163.1	25.35	168.0	27.13	172.9	28.15	182.3	28.47	186.8	28.70
	20	125.4	17.67	149.2	22.50	163.1	26.72	168.0	28.54	172.9	29.64	182.3	30.03	186.8	30.27
	21	125.4	18.21	149.2	23.31	163.1	27.47	168.0	29.38	172.9	30.62	182.3	31.01	186.8	31.25
	23	125.4	19.46	149.2	24.94	163.1	29.42	168.0	31.22	172.9	32.64	182.3	32.97	186.8	33.23
	25	125.4	20.79	149.2	26.72	163.1	31.03	168.0	33.28	172.9	35.00	180.2	35.29	184.6	35.57
	27	125.4	22.20	149.2	28.56	163.1	33.03	168.0	35.56	172.9	37.61	177.5	37.87	181.9	38.17
	29	125.4	23.68	149.2	30.49	163.1	34.76	168.0	38.06	170.2	40.09	174.6	40.69	179.6	41.02
	31	125.4	25.24	149.2	32.57	163.1	36.56	165.8	40.77	168.0	43.01	172.5	43.76	176.8	44.12
	33	125.4	26.87	149.2	34.71	160.8	38.67	163.1	44.25	165.2	46.18	169.6	46.70	174.1	47.08
	35	125.4	28.56	149.2	37.00	158.1	40.93	160.2	48.75	163.1	48.99	167.5	49.14	171.9	49.53
	37	125.4	30.73	149.2	39.04	155.8	43.63	158.1	47.72	160.2	47.96	164.7	48.11	169.2	48.49
	39	125.4	33.08	148.7	41.27	153.1	46.28	155.3	46.74	157.5	46.98	162.5	47.12	166.9	47.49
	41	122.3	35.43	142.1	43.48	146.9	45.37	149.0	45.77	151.2	45.99	155.6	46.13	160.0	46.50
	43	119.2	37.82	136.2	42.86	141.0	44.36	142.9	44.78	145.0	45.00	149.4	45.15	153.7	45.50
46	111.7	40.67	124.2	41.85	128.7	42.96	130.6	43.31	132.6	43.53	136.6	43.66	140.6	44.01	
48	98.9	39.83	107.9	41.10	111.9	42.13	113.6	42.38	115.3	42.51	118.9	42.68	122.5	42.86	
110	10	112.4	13.39	134.0	16.31	149.7	19.38	154.0	20.98	163.7	22.58	167.5	23.21	178.8	23.59
	12	112.4	13.80	134.0	16.87	149.7	20.19	154.0	21.57	163.7	23.42	167.5	24.18	178.8	24.74
	14	112.4	14.23	134.0	17.63	149.7	21.10	154.0	22.63	163.7	24.60	167.5	25.31	178.8	25.84
	16	112.4	14.74	134.0	18.27	149.7	21.97	154.0	23.63	163.7	25.74	167.5	26.44	178.8	26.91
	18	112.4	15.28	134.0	19.03	149.7	23.23	154.0	24.88	163.7	27.15	167.5	27.69	178.8	28.20
	20	112.4	15.83	134.0	19.98	149.7	24.64	154.0	26.02	163.7	28.47	167.5	29.17	178.8	29.64
	21	112.4	16.18	134.0	20.57	149.7	25.28	154.0	26.72	163.7	29.27	167.5	30.00	178.8	30.47
	23	112.4	17.25	134.0	22.05	149.7	26.68	154.0	28.22	163.7	30.92	167.5	31.58	178.8	32.10
	25	112.4	18.43	134.0	23.53	149.7	28.20	154.0	29.83	163.7	32.66	167.5	33.13	176.7	33.81
	27	112.4	19.69	134.0	25.16	149.7	29.79	154.0	31.57	163.7	34.11	167.5	34.89	174.0	35.49
	29	112.4	21.02	134.0	26.87	149.7	31.48	154.0	33.43	163.7	36.05	167.5	36.67	171.9	37.22
	31	112.4	22.35	134.0	28.64	149.7	33.27	154.0	35.42	161.0	37.88	165.4	38.62	169.2	39.02
	33	112.4	23.83	134.0	30.49	149.7	35.15	154.0	37.54	158.8	40.00	162.7	40.67	166.9	40.89
	35	112.4	25.31	134.0	32.57	149.7	37.12	154.0	39.77	156.2	42.22	160.0	42.60	164.3	42.82
	37	112.4	26.83	134.0	34.56	149.7	39.19	151.9	42.13	153.5	44.53	157.8	44.68	161.6	44.81
	39	112.4	28.92	134.0	36.73	146.9	41.35	149.1	45.07	151.3	46.73	155.0	46.82	159.4	46.86
	41	109.6	31.01	130.6	38.89	140.7	43.61	142.9	48.75	144.8	48.75	149.0	49.14	152.7	49.53
	43	106.8	32.57	127.3	40.52	134.8	46.24	137.1	46.76	138.8	46.67	142.9	46.93	146.5	47.06
46	100.1	31.78	119.4	39.11	123.0	43.89	125.2	43.89	126.8	44.27	130.6	44.51	134.0	44.63	
48	88.5	30.87	103.7	37.68	106.9	41.76	108.8	42.04	110.2	42.24	113.6	42.36	116.6	42.53	

Note

1. TC: Total Capacity(kW), PI : Power Input(kW, Comp. + Outdoor fan motor)
2. Capacity tables show the average value of conditions which may occur.

7. Capacity Tables

Combination (%)	Outdoor air temp (°C DB)	Cooling Capacity(50HP)													
		Indoor air temp. (DB/WB, °C)													
		20		23		26		27		28		30		32	
		14	16	18	19	20	22	24	TC	PI	TC	PI	TC	PI	
100	10	94.5	12.06	112.5	14.65	131.0	17.38	140.0	18.79	149.0	20.18	165.2	22.46	168.8	22.65
	12	94.5	12.45	112.5	15.25	131.0	17.97	140.0	19.29	149.0	20.83	165.2	23.68	168.8	23.91
	14	94.5	12.83	112.5	15.86	131.0	18.73	140.0	20.12	149.0	21.73	165.2	25.00	168.8	25.24
	16	94.5	13.22	112.5	16.39	131.0	19.52	140.0	21.08	149.0	22.89	165.2	26.21	168.8	26.57
	18	94.5	13.61	112.5	16.99	131.0	20.29	140.0	22.11	149.0	24.28	165.2	27.69	168.8	27.90
	20	94.5	14.10	112.5	17.64	131.0	21.47	140.0	23.68	149.0	25.97	165.2	29.01	168.8	29.25
	21	94.5	14.40	112.5	18.06	131.0	22.20	140.0	24.49	149.0	26.94	165.2	29.68	168.8	29.91
	23	94.5	15.24	112.5	19.31	131.0	23.83	140.0	26.27	149.0	28.86	165.2	31.07	168.8	31.33
	25	94.5	16.20	112.5	20.57	131.0	25.46	140.0	28.12	149.0	30.86	165.2	32.40	167.4	32.66
	27	94.5	17.32	112.5	21.98	131.0	27.23	140.0	30.04	149.0	32.81	162.0	33.92	165.4	34.20
	29	94.5	18.43	112.5	23.46	131.0	29.08	140.0	32.12	149.0	34.73	159.0	35.29	162.9	35.57
	31	94.5	19.69	112.5	25.01	131.0	31.01	140.0	34.26	149.0	36.49	156.6	36.66	160.4	36.95
	33	94.5	20.87	112.5	26.64	131.0	33.08	140.0	36.56	149.0	37.86	154.1	38.02	157.9	38.33
	35	94.5	22.20	112.5	28.35	131.0	35.23	140.0	39.00	146.7	39.23	151.3	39.39	155.2	39.70
	37	94.5	23.78	112.5	30.40	131.0	37.31	140.0	40.86	144.3	41.06	148.5	41.23	152.0	41.61
	39	94.5	25.50	112.5	32.66	131.0	39.54	140.0	42.86	141.9	43.05	146.1	43.20	149.5	43.61
	41	93.0	27.21	110.7	34.91	128.9	41.77	134.4	44.85	137.3	45.03	140.5	45.19	145.0	45.61
	43	89.8	28.80	106.9	37.01	124.5	43.76	128.8	46.57	130.2	46.73	134.3	46.89	137.9	47.33
46	84.2	30.97	100.2	39.90	116.7	46.42	117.6	48.75	118.9	48.90	122.7	49.03	126.0	49.50	
48	74.4	26.74	88.6	34.52	100.7	39.68	102.2	41.36	103.3	41.50	106.7	41.59	109.6	41.92	
90	10	85.0	10.47	101.5	12.58	118.0	14.83	126.0	15.99	134.0	17.21	150.5	19.26	167.0	21.41
	12	85.0	10.59	101.5	12.78	118.0	15.09	126.0	16.31	134.0	17.59	150.5	19.63	167.0	21.79
	14	85.0	10.79	101.5	13.03	118.0	15.41	126.0	16.63	134.0	17.91	150.5	20.02	167.0	22.24
	16	85.0	10.98	101.5	13.29	118.0	15.73	126.0	16.95	134.0	18.24	150.5	20.40	167.0	22.62
	18	85.0	11.17	101.5	13.55	118.0	15.99	126.0	17.34	134.0	18.62	150.5	20.85	167.0	23.76
	20	85.0	11.36	101.5	13.80	118.0	16.31	126.0	17.66	134.0	19.33	150.5	22.31	167.0	24.89
	21	85.0	11.49	101.5	13.93	118.0	16.63	126.0	18.24	134.0	20.03	150.5	22.67	167.0	25.46
	23	85.0	11.75	101.5	14.51	118.0	17.79	126.0	19.58	134.0	21.45	150.5	24.04	164.7	26.66
	25	85.0	12.33	101.5	15.47	118.0	19.01	126.0	20.93	134.0	22.92	150.5	25.71	162.3	27.80
	27	85.0	13.16	101.5	16.50	118.0	20.29	126.0	22.34	134.0	24.53	150.5	27.33	160.0	29.11
	29	85.0	13.93	101.5	17.59	118.0	21.70	126.0	23.89	134.0	26.20	150.5	28.96	157.5	30.27
	31	85.0	14.83	101.5	18.75	118.0	23.12	126.0	25.43	134.0	27.93	150.5	30.40	155.2	31.45
	33	85.0	15.80	101.5	19.97	118.0	24.66	126.0	27.10	134.0	29.62	150.5	31.87	152.8	32.62
	35	85.0	16.76	101.5	21.19	118.0	26.20	126.0	28.89	134.0	31.41	147.9	33.69	150.4	34.47
	37	85.0	17.79	101.5	22.54	118.0	27.93	126.0	30.69	134.0	33.16	145.6	35.22	148.1	36.01
	39	85.0	18.83	101.5	23.97	118.0	29.56	126.0	32.66	134.0	34.87	143.1	37.14	145.6	37.59
	41	82.9	21.07	98.9	26.57	115.0	32.45	122.7	35.71	130.6	37.64	137.1	39.13	139.6	40.03
	43	80.8	22.74	96.5	28.71	112.1	35.44	119.8	38.47	127.3	40.36	131.5	41.91	133.9	42.41
46	75.7	25.60	90.4	32.70	105.0	40.38	112.3	43.61	115.7	44.84	120.0	46.00	122.3	46.07	
48	66.9	22.37	80.0	28.60	92.9	35.32	99.2	38.04	100.4	38.64	104.4	39.60	106.3	39.65	
80	10	75.5	8.73	90.0	10.49	104.5	12.31	112.0	13.28	119.5	14.24	134.0	16.25	148.5	17.64
	12	75.5	8.91	90.0	10.60	104.5	12.55	112.0	13.51	119.5	14.49	134.0	16.55	148.5	17.99
	14	75.5	9.03	90.0	10.85	104.5	12.73	112.0	13.76	119.5	14.73	134.0	16.85	148.5	18.33
	16	75.5	9.16	90.0	11.03	104.5	12.97	112.0	14.00	119.5	15.03	134.0	17.22	148.5	18.69
	18	75.5	9.34	90.0	11.22	104.5	13.21	112.0	14.24	119.5	15.33	134.0	17.52	148.5	19.10
	20	75.5	9.52	90.0	11.46	104.5	13.51	112.0	14.54	119.5	15.64	134.0	18.18	148.5	20.23
	21	75.5	9.57	90.0	11.58	104.5	13.64	112.0	14.73	119.5	16.00	134.0	18.76	148.5	20.77
	23	75.5	9.76	90.0	11.76	104.5	14.24	112.0	15.64	119.5	17.09	134.0	19.81	148.5	21.80
	25	75.5	10.13	90.0	12.55	104.5	15.27	112.0	16.73	119.5	18.31	134.0	21.20	148.5	23.30
	27	75.5	10.73	90.0	13.34	104.5	16.31	112.0	17.88	119.5	19.52	134.0	22.52	148.5	24.52
	29	75.5	11.39	90.0	14.24	104.5	17.34	112.0	19.04	119.5	20.85	134.0	24.13	148.5	26.25
	31	75.5	12.12	90.0	15.09	104.5	18.49	112.0	20.30	119.5	22.19	134.0	25.61	148.5	27.56
	33	75.5	12.85	90.0	16.12	104.5	19.70	112.0	21.64	119.5	23.64	134.0	26.98	148.5	28.89
	35	75.5	13.64	90.0	17.09	104.5	20.98	112.0	23.04	119.5	25.22	134.0	28.61	146.9	29.94
	37	75.5	14.43	90.0	18.18	104.5	22.25	112.0	24.49	119.5	26.79	134.0	30.19	144.6	31.30
	39	75.5	15.25	90.0	19.21	104.5	23.80	112.0	26.33	119.5	28.80	134.0	31.90	142.1	33.02
	41	73.6	16.87	87.7	21.29	101.8	26.12	109.1	28.86	116.4	31.64	130.6	35.50	136.2	36.59
	43	71.7	18.57	85.6	23.23	99.3	28.52	106.4	31.45	113.6	34.58	127.3	37.99	130.6	39.18
46	67.3	20.66	80.2	26.17	93.1	32.12	99.8	35.01	106.4	39.01	116.5	41.47	119.2	42.14	
48	59.5	18.05	70.9	22.89	82.3	28.09	88.3	30.58	94.2	34.15	101.1	35.89	103.6	36.27	

Note

1. TC: Total Capacity(kW), PI : Power Input(kW, Comp. + Outdoor fan motor)
2. Capacity tables show the average value of conditions which may occur.

7. Capacity Tables

Combination (%)	Outdoor air temp (°C DB)	Cooling Capacity(50HP)													
		Indoor air temp. (DB/WB, °C)													
		20		23		26		27		28		30		32	
		14	16	18	19	20	22	24							
	TC	PI	TC	PI	TC	PI	TC	PI	TC	PI	TC	PI	TC	PI	
70	10	66.0	7.63	79.0	9.08	91.5	10.52	98.0	11.36	104.5	12.14	117.0	13.82	130.0	15.46
	12	66.0	7.75	79.0	9.19	91.5	10.75	98.0	11.54	104.5	12.38	117.0	14.07	130.0	15.75
	14	66.0	7.88	79.0	9.32	91.5	10.94	98.0	11.72	104.5	12.56	117.0	14.37	130.0	16.04
	16	66.0	7.99	79.0	9.49	91.5	11.12	98.0	11.96	104.5	12.80	117.0	14.61	130.0	16.38
	18	66.0	8.12	79.0	9.68	91.5	11.36	98.0	12.20	104.5	13.04	117.0	14.84	130.0	16.68
	20	66.0	8.23	79.0	9.85	91.5	11.54	98.0	12.44	104.5	13.34	117.0	15.21	130.0	17.31
	21	66.0	8.35	79.0	9.92	91.5	11.66	98.0	12.56	104.5	13.47	117.0	15.44	130.0	17.67
	23	66.0	8.48	79.0	10.15	91.5	11.90	98.0	12.98	104.5	14.12	117.0	16.53	130.0	18.66
	25	66.0	8.59	79.0	10.52	91.5	12.68	98.0	13.88	104.5	15.08	117.0	17.67	130.0	19.57
	27	66.0	9.08	79.0	11.24	91.5	13.52	98.0	14.73	104.5	16.11	117.0	18.87	130.0	20.80
	29	66.0	9.68	79.0	11.90	91.5	14.37	98.0	15.68	104.5	17.13	117.0	20.13	130.0	22.28
	31	66.0	10.28	79.0	12.68	91.5	15.33	98.0	16.77	104.5	18.27	117.0	21.46	130.0	23.64
	33	66.0	10.88	79.0	13.40	91.5	16.28	98.0	17.79	104.5	19.41	117.0	22.83	130.0	25.17
	35	66.0	11.48	79.0	14.31	91.5	17.31	98.0	18.93	104.5	20.67	117.0	24.35	130.0	26.69
	37	66.0	12.20	79.0	15.15	91.5	18.39	98.0	20.13	104.5	22.00	117.0	25.90	130.0	28.16
	39	66.0	12.96	79.0	16.15	91.5	19.66	98.0	21.66	104.5	23.76	117.0	27.72	130.0	30.37
	41	64.3	14.33	76.9	17.69	89.2	21.57	95.5	23.76	101.8	25.83	114.0	30.45	126.7	32.76
	43	62.7	15.59	75.0	19.29	86.9	23.54	93.1	25.91	99.3	28.21	111.2	33.26	123.5	35.42
46	58.8	17.33	70.4	21.69	81.5	26.51	87.3	28.85	93.1	31.80	104.2	37.52	115.8	39.47	
48	52.0	15.12	62.3	18.95	72.1	23.17	77.2	25.22	82.3	27.82	92.1	32.83	102.5	34.16	
60	10	56.5	6.55	67.5	7.69	78.5	8.94	84.0	9.59	89.5	10.19	100.5	11.56	111.5	12.93
	12	56.5	6.67	67.5	7.80	78.5	9.06	84.0	9.71	89.5	10.37	100.5	11.74	111.5	13.17
	14	56.5	6.73	67.5	7.93	78.5	9.23	84.0	9.89	89.5	10.54	100.5	11.98	111.5	13.41
	16	56.5	6.85	67.5	8.10	78.5	9.36	84.0	10.07	89.5	10.78	100.5	12.21	111.5	13.64
	18	56.5	6.97	67.5	8.22	78.5	9.53	84.0	10.24	89.5	10.97	100.5	12.39	111.5	13.94
	20	56.5	7.09	67.5	8.34	78.5	9.71	84.0	10.43	89.5	11.14	100.5	12.63	111.5	14.24
	21	56.5	7.15	67.5	8.40	78.5	9.83	84.0	10.54	89.5	11.26	100.5	12.81	111.5	14.36
	23	56.5	7.27	67.5	8.57	78.5	9.95	84.0	10.73	89.5	11.50	100.5	13.28	111.5	15.25
	25	56.5	7.39	67.5	8.76	78.5	10.37	84.0	11.26	89.5	12.21	100.5	14.18	111.5	16.32
	27	56.5	7.63	67.5	9.23	78.5	11.03	84.0	11.98	89.5	12.99	100.5	15.08	111.5	17.40
	29	56.5	8.10	67.5	9.83	78.5	11.74	84.0	12.75	89.5	13.82	100.5	16.09	111.5	18.59
	31	56.5	8.57	67.5	10.43	78.5	12.45	84.0	13.58	89.5	14.72	100.5	17.16	111.5	19.78
	33	56.5	9.06	67.5	11.03	78.5	13.22	84.0	14.42	89.5	15.66	100.5	18.23	111.5	21.10
	35	56.5	9.59	67.5	11.74	78.5	14.06	84.0	15.31	89.5	16.62	100.5	19.43	111.5	22.40
	37	56.5	10.13	67.5	12.38	78.5	14.89	84.0	16.26	89.5	17.63	100.5	20.61	111.5	23.83
	39	56.5	10.77	67.5	13.19	78.5	16.07	84.0	17.45	89.5	18.98	100.5	22.11	111.5	25.54
	41	55.0	11.68	65.8	14.44	76.5	17.46	81.9	19.06	87.2	20.60	97.9	24.25	108.7	27.75
	43	53.7	12.70	64.2	15.71	74.6	19.03	79.8	20.78	85.0	22.47	95.5	26.48	106.0	30.31
46	50.4	14.22	60.2	17.65	70.0	21.40	74.8	23.35	79.7	25.28	89.5	29.84	99.3	34.53	
48	44.5	12.39	53.2	15.40	61.9	18.70	66.2	20.39	70.5	22.09	79.2	26.09	87.9	30.21	
50	10	47.3	5.61	56.5	6.49	65.5	7.39	70.0	7.91	74.5	8.38	83.5	9.45	93.0	10.52
	12	47.3	5.67	56.5	6.56	65.5	7.50	70.0	8.03	74.5	8.57	83.5	9.62	93.0	10.69
	14	47.3	5.73	56.5	6.67	65.5	7.62	70.0	8.15	74.5	8.68	83.5	9.75	93.0	10.87
	16	47.3	5.85	56.5	6.79	65.5	7.74	70.0	8.33	74.5	8.80	83.5	9.92	93.0	11.04
	18	47.3	5.91	56.5	6.85	65.5	7.86	70.0	8.44	74.5	8.98	83.5	10.10	93.0	11.28
	20	47.3	5.96	56.5	6.97	65.5	8.03	70.0	8.57	74.5	9.15	83.5	10.28	93.0	11.51
	21	47.3	6.02	56.5	7.03	65.5	8.10	70.0	8.68	74.5	9.21	83.5	10.39	93.0	11.63
	23	47.3	6.15	56.5	7.14	65.5	8.21	70.0	8.80	74.5	9.39	83.5	10.57	93.0	11.87
	25	47.3	6.20	56.5	7.26	65.5	8.38	70.0	8.98	74.5	9.69	83.5	11.10	93.0	12.70
	27	47.3	6.32	56.5	7.50	65.5	8.85	70.0	9.56	74.5	10.28	83.5	11.87	93.0	13.52
	29	47.3	6.67	56.5	7.97	65.5	9.39	70.0	10.16	74.5	10.93	83.5	12.58	93.0	14.35
	31	47.3	7.03	56.5	8.44	65.5	9.98	70.0	10.75	74.5	11.63	83.5	13.41	93.0	15.30
	33	47.3	7.44	56.5	8.92	65.5	10.57	70.0	11.40	74.5	12.34	83.5	14.23	93.0	16.30
	35	47.3	7.86	56.5	9.45	65.5	11.16	70.0	12.11	74.5	13.05	83.5	15.06	93.0	17.31
	37	47.3	8.33	56.5	9.98	65.5	11.81	70.0	12.81	74.5	13.82	83.5	16.07	93.0	18.37
	39	47.3	8.89	56.5	10.70	65.5	12.66	70.0	13.80	74.5	14.83	83.5	17.11	93.0	19.84
	41	46.0	9.60	55.0	11.58	63.8	13.84	68.2	14.94	72.5	16.07	81.4	18.75	90.6	21.54
	43	44.9	10.44	53.7	12.60	62.3	15.06	66.5	16.27	70.8	17.49	79.4	20.45	88.4	23.50
46	42.1	11.70	50.4	14.13	58.3	16.89	62.3	18.27	66.3	19.63	74.4	23.01	82.9	26.46	
48	37.3	10.18	44.5	12.32	51.6	14.74	55.2	15.94	58.7	17.14	65.8	20.10	73.3	23.12	

Note

1. TC: Total Capacity(kW), PI : Power Input(kW, Comp. + Outdoor fan motor)
2. Capacity tables show the average value of conditions which may occur.

7. Capacity Tables

◆ A(C)RUN520LLS5

Combination (%)	Outdoor air temp (°C DB)	Indoor air temp. (DB/WB, °C)														Cooling Capacity(52HP)	
		20		23		26		27		28		30		32		TC	PI
		14		16		18		19		20		22		24			
		TC	PI	TC	PI	TC	PI	TC	PI	TC	PI	TC	PI	TC	PI		
130	10	144.2	17.64	171.8	21.56	184.0	25.02	189.4	25.52	194.6	25.74	204.0	25.94	209.2	26.04		
	12	144.2	18.08	171.8	22.34	184.0	26.04	189.4	26.22	194.6	26.42	204.0	26.64	209.2	26.88		
	14	144.2	18.70	171.8	23.14	184.0	27.02	189.4	27.22	194.6	27.44	204.0	27.66	209.2	27.90		
	16	144.2	19.38	171.8	23.96	184.0	28.24	189.4	28.50	194.6	28.72	204.0	28.98	209.2	29.22		
	18	144.2	20.18	171.8	25.34	184.0	29.54	189.4	30.18	194.6	30.42	204.0	30.72	209.2	30.92		
	20	144.2	21.08	171.8	27.00	184.0	31.00	189.4	33.18	194.6	33.46	201.0	33.78	206.4	34.02		
	21	144.2	21.62	171.8	27.94	184.0	31.64	189.4	35.12	194.6	35.40	200.0	35.76	205.2	36.00		
	23	144.2	23.20	171.8	29.40	184.0	33.28	189.4	38.76	192.2	39.06	197.0	39.46	202.2	39.72		
	25	144.2	24.78	171.8	31.08	184.0	35.56	187.0	42.98	189.4	43.32	194.6	43.76	200.0	44.06		
	27	144.2	26.52	171.8	33.24	181.8	37.90	184.0	47.32	187.0	47.70	192.2	48.16	197.0	48.50		
	29	144.2	28.26	171.8	35.52	178.8	40.78	181.4	52.00	184.0	52.32	189.4	52.78	194.6	52.98		
	31	144.2	30.16	171.2	37.42	175.8	43.38	178.8	51.78	181.4	52.10	186.4	52.56	191.6	52.76		
	33	144.2	32.12	168.2	39.66	173.6	46.52	176.4	51.30	178.8	51.62	184.0	52.08	188.8	52.28		
	35	144.2	34.26	165.2	41.52	170.6	50.38	173.6	50.64	176.4	50.94	181.2	51.40	186.4	51.60		
	37	144.2	36.54	163.0	43.58	168.2	49.72	170.6	49.98	173.6	50.28	178.2	50.72	183.6	50.92		
	39	144.2	38.90	160.0	45.86	165.2	49.06	168.2	49.30	170.6	49.60	175.8	50.04	181.2	50.24		
	41	140.6	41.26	153.4	48.16	158.6	48.40	161.0	48.64	164.2	48.92	169.0	49.36	173.6	49.56		
	43	137.0	43.52	147.0	47.48	152.2	47.72	154.4	47.96	157.6	48.26	162.4	48.68	166.8	48.88		
46	128.4	46.58	134.2	46.50	139.0	46.72	141.2	46.96	144.0	47.24	148.6	47.66	152.8	47.86			
48	113.6	45.28	116.4	45.42	120.8	45.52	122.8	45.64	125.4	46.04	129.4	46.34	133.0	46.52			
120	10	130.4	15.88	155.2	19.46	169.6	23.14	174.8	25.00	179.8	25.40	189.6	25.50	194.2	25.70		
	12	130.4	16.30	155.2	20.12	169.6	24.06	174.8	25.52	179.8	26.34	189.6	26.66	194.2	26.86		
	14	130.4	16.86	155.2	20.80	169.6	25.04	174.8	26.50	179.8	27.30	189.6	27.70	194.2	27.92		
	16	130.4	17.48	155.2	21.66	169.6	26.00	174.8	27.48	179.8	28.56	189.6	28.92	194.2	29.14		
	18	130.4	18.16	155.2	22.64	169.6	27.04	174.8	28.94	179.8	30.02	189.6	30.36	194.2	30.62		
	20	130.4	18.84	155.2	24.00	169.6	28.50	174.8	30.44	179.8	31.62	189.6	32.04	194.2	32.28		
	21	130.4	19.42	155.2	24.86	169.6	29.30	174.8	31.34	179.8	32.66	189.6	33.08	194.2	33.34		
	23	130.4	20.76	155.2	26.60	169.6	31.38	174.8	33.30	179.8	34.82	189.6	35.16	194.2	35.44		
	25	130.4	22.18	155.2	28.50	169.6	33.10	174.8	35.50	179.8	37.34	187.4	37.64	192.0	37.94		
	27	130.4	23.68	155.2	30.46	169.6	35.24	174.8	37.94	179.8	40.12	184.6	40.40	189.2	40.72		
	29	130.4	25.26	155.2	32.52	169.6	37.08	174.8	40.60	177.0	42.76	181.6	43.40	186.8	43.76		
	31	130.4	26.92	155.2	34.74	169.6	39.00	172.4	43.48	174.8	45.88	179.4	46.68	183.8	47.06		
	33	130.4	28.66	155.2	37.02	167.2	41.24	169.6	47.20	171.8	49.26	176.4	49.82	181.0	50.22		
	35	130.4	30.46	155.2	39.46	164.4	43.66	166.6	52.00	169.6	52.26	174.2	52.42	178.8	52.84		
	37	130.4	32.78	155.2	41.64	162.0	46.54	164.4	50.90	166.6	51.16	171.2	51.32	176.0	51.72		
	39	130.4	35.28	154.6	44.02	159.2	49.36	161.6	49.86	163.8	50.12	169.0	50.26	173.6	50.66		
	41	127.2	37.80	147.8	46.38	152.8	48.40	155.0	48.82	157.2	49.06	161.8	49.20	166.4	49.60		
	43	124.0	40.34	141.6	45.72	146.6	47.32	148.6	47.76	150.8	48.00	155.4	48.16	159.8	48.54		
46	116.2	43.38	129.2	44.64	133.8	45.82	135.8	46.20	138.0	46.44	142.0	46.58	146.2	46.94			
48	102.8	42.48	112.2	43.84	116.4	44.94	118.2	45.20	120.0	45.34	123.6	45.52	127.4	45.72			
110	10	116.8	14.28	139.4	17.40	155.6	20.68	160.2	22.38	170.2	24.08	174.2	24.76	186.0	25.16		
	12	116.8	14.72	139.4	18.00	155.6	21.54	160.2	23.00	170.2	24.98	174.2	25.80	186.0	26.38		
	14	116.8	15.18	139.4	18.80	155.6	22.50	160.2	24.14	170.2	26.24	174.2	27.00	186.0	27.56		
	16	116.8	15.72	139.4	19.48	155.6	23.44	160.2	25.20	170.2	27.46	174.2	28.20	186.0	28.70		
	18	116.8	16.30	139.4	20.30	155.6	24.78	160.2	26.54	170.2	28.96	174.2	29.54	186.0	30.08		
	20	116.8	16.88	139.4	21.32	155.6	26.28	160.2	27.76	170.2	30.36	174.2	31.12	186.0	31.62		
	21	116.8	17.26	139.4	21.94	155.6	26.96	160.2	28.50	170.2	31.22	174.2	32.00	186.0	32.50		
	23	116.8	18.40	139.4	23.52	155.6	28.46	160.2	30.10	170.2	32.98	174.2	33.68	186.0	34.24		
	25	116.8	19.66	139.4	25.10	155.6	30.08	160.2	31.82	170.2	34.84	174.2	35.34	183.8	36.06		
	27	116.8	21.00	139.4	26.84	155.6	31.78	160.2	33.68	170.2	36.38	174.2	37.22	181.0	37.86		
	29	116.8	22.42	139.4	28.66	155.6	33.58	160.2	35.66	170.2	38.46	174.2	39.12	178.8	39.70		
	31	116.8	23.84	139.4	30.54	155.6	35.48	160.2	37.78	167.4	40.40	172.0	41.20	176.0	41.62		
	33	116.8	25.42	139.4	32.52	155.6	37.50	160.2	40.04	165.2	42.66	169.2	43.38	173.6	43.62		
	35	116.8	27.00	139.4	34.74	155.6	39.60	160.2	42.42	162.4	45.04	166.4	45.44	170.8	45.68		
	37	116.8	28.62	139.4	36.86	155.6	41.80	158.0	44.94	159.6	47.50	164.2	47.66	168.0	47.80		
	39	116.8	30.84	139.4	39.18	152.8	44.10	155.0	48.08	157.4	49.84	161.2	49.94	165.8	49.98		
	41	114.0	33.08	135.8	41.48	146.4	46.52	148.6	52.00	150.6	52.00	155.0	52.42	158.8	52.84		
	43	111.0	34.74	132.4	43.22	140.2	49.32	142.6	49.88	144.4	49.78	148.6	50.06	152.4	50.20		
46	104.2	33.90	124.2	41.72	128.0	46.82	130.2	46.82	131.8	47.22	135.8	47.48	139.4	47.60			
48	92.0	32.92	107.8	40.20	111.2	44.54	113.2	44.84	114.6	45.06	118.2	45.18	121.2	45.36			

Note

1. TC: Total Capacity(kW), PI : Power Input(kW, Comp. + Outdoor fan motor)
2. Capacity tables show the average value of conditions which may occur.

7. Capacity Tables

Combination (%)	Outdoor air temp (°C DB)	Cooling Capacity(52HP)													
		Indoor air temp. (DB/WB, °C)													
		20		23		26		27		28		30		32	
		14	PI	16	PI	18	PI	19	PI	20	PI	22	PI	24	PI
100	10	98.2	12.86	117.0	15.62	136.2	18.54	145.6	20.04	155.0	21.52	171.8	23.96	175.6	24.16
	12	98.2	13.28	117.0	16.26	136.2	19.16	145.6	20.58	155.0	22.22	171.8	25.26	175.6	25.50
	14	98.2	13.68	117.0	16.92	136.2	19.98	145.6	21.46	155.0	23.18	171.8	26.66	175.6	26.92
	16	98.2	14.10	117.0	17.48	136.2	20.82	145.6	22.48	155.0	24.42	171.8	27.96	175.6	28.34
	18	98.2	14.52	117.0	18.12	136.2	21.64	145.6	23.58	155.0	25.90	171.8	29.54	175.6	29.76
	20	98.2	15.04	117.0	18.82	136.2	22.90	145.6	25.26	155.0	27.70	171.8	30.94	175.6	31.20
	21	98.2	15.36	117.0	19.26	136.2	23.68	145.6	26.12	155.0	28.74	171.8	31.66	175.6	31.90
	23	98.2	16.26	117.0	20.60	136.2	25.42	145.6	28.02	155.0	30.78	171.8	33.14	175.6	33.42
	25	98.2	17.28	117.0	21.94	136.2	27.16	145.6	30.00	155.0	32.92	171.8	34.56	174.0	34.84
	27	98.2	18.48	117.0	23.44	136.2	29.04	145.6	32.04	155.0	35.00	168.4	36.18	172.0	36.48
	29	98.2	19.66	117.0	25.02	136.2	31.02	145.6	34.26	155.0	37.04	165.4	37.64	169.4	37.94
	31	98.2	21.00	117.0	26.68	136.2	33.08	145.6	36.54	155.0	38.92	162.8	39.10	166.8	39.42
	33	98.2	22.26	117.0	28.42	136.2	35.28	145.6	39.00	155.0	40.38	160.2	40.56	164.2	40.88
	35	98.2	23.68	117.0	30.24	136.2	37.58	145.6	41.60	152.6	41.84	157.4	42.02	161.4	42.34
	37	98.2	25.36	117.0	32.42	136.2	39.80	145.6	43.58	150.0	43.80	154.4	43.98	158.0	44.38
	39	98.2	27.20	117.0	34.84	136.2	42.18	145.6	45.72	147.6	45.92	152.0	46.08	155.4	46.52
	41	96.8	29.02	115.2	37.24	134.0	44.56	139.8	47.84	142.8	48.04	146.2	48.20	150.8	48.66
	43	93.4	30.72	111.2	39.48	129.4	46.68	134.0	49.68	135.4	49.84	139.6	50.02	143.4	50.48
46	87.6	33.04	104.2	42.56	121.4	49.52	122.4	52.00	123.6	52.16	127.6	52.30	131.0	52.80	
48	77.4	28.52	92.2	36.82	104.8	42.32	106.2	44.12	107.4	44.26	111.0	44.36	114.0	44.72	
90	10	88.4	11.16	105.6	13.40	122.8	15.80	131.0	17.04	139.4	18.34	156.6	20.52	173.6	22.82
	12	88.4	11.28	105.6	13.62	122.8	16.08	131.0	17.38	139.4	18.74	156.6	20.92	173.6	23.22
	14	88.4	11.50	105.6	13.88	122.8	16.42	131.0	17.72	139.4	19.08	156.6	21.34	173.6	23.70
	16	88.4	11.70	105.6	14.16	122.8	16.76	131.0	18.06	139.4	19.44	156.6	21.74	173.6	24.10
	18	88.4	11.90	105.6	14.44	122.8	17.04	131.0	18.48	139.4	19.84	156.6	22.22	173.6	25.32
	20	88.4	12.10	105.6	14.70	122.8	17.38	131.0	18.82	139.4	20.60	156.6	23.78	173.6	26.52
	21	88.4	12.24	105.6	14.84	122.8	17.72	131.0	19.44	139.4	21.34	156.6	24.16	173.6	27.14
	23	88.4	12.52	105.6	15.46	122.8	18.96	131.0	20.86	139.4	22.86	156.6	25.62	171.2	28.42
	25	88.4	13.14	105.6	16.48	122.8	20.26	131.0	22.30	139.4	24.42	156.6	27.40	168.8	29.62
	27	88.4	14.02	105.6	17.58	122.8	21.62	131.0	23.80	139.4	26.14	156.6	29.12	166.4	31.02
	29	88.4	14.84	105.6	18.74	122.8	23.12	131.0	25.46	139.4	27.92	156.6	30.86	163.8	32.26
	31	88.4	15.80	105.6	19.98	122.8	24.64	131.0	27.10	139.4	29.76	156.6	32.40	161.4	33.52
	33	88.4	16.84	105.6	21.28	122.8	26.28	131.0	28.88	139.4	31.56	156.6	33.96	159.0	34.76
	35	88.4	17.86	105.6	22.58	122.8	27.92	131.0	30.78	139.4	33.48	153.8	35.90	156.4	36.74
	37	88.4	18.96	105.6	24.02	122.8	29.76	131.0	32.70	139.4	35.34	151.4	37.54	154.0	38.38
	39	88.4	20.06	105.6	25.54	122.8	31.50	131.0	34.80	139.4	37.16	148.8	39.58	151.4	40.06
	41	86.2	22.46	102.8	28.32	119.6	34.58	127.6	38.06	135.8	40.12	142.6	41.70	145.2	42.66
	43	84.0	24.24	100.4	30.60	116.6	37.76	124.6	41.00	132.4	43.02	136.8	44.66	139.2	45.20
46	78.8	27.28	94.0	34.84	109.2	43.04	116.8	46.48	120.4	47.78	124.8	49.02	127.2	49.10	
48	69.6	23.84	83.2	30.48	96.6	37.64	103.2	40.54	104.4	41.18	108.6	42.20	110.6	42.26	
80	10	78.6	9.30	93.6	11.18	108.6	13.12	116.4	14.16	124.2	15.18	139.4	17.32	154.4	18.80
	12	78.6	9.50	93.6	11.30	108.6	13.38	116.4	14.40	124.2	15.44	139.4	17.64	154.4	19.18
	14	78.6	9.62	93.6	11.56	108.6	13.56	116.4	14.66	124.2	15.70	139.4	17.96	154.4	19.54
	16	78.6	9.76	93.6	11.76	108.6	13.82	116.4	14.92	124.2	16.02	139.4	18.36	154.4	19.92
	18	78.6	9.96	93.6	11.96	108.6	14.08	116.4	15.18	124.2	16.34	139.4	18.68	154.4	20.36
	20	78.6	10.14	93.6	12.22	108.6	14.40	116.4	15.50	124.2	16.68	139.4	19.38	154.4	21.56
	21	78.6	10.20	93.6	12.34	108.6	14.54	116.4	15.70	124.2	17.06	139.4	20.00	154.4	22.14
	23	78.6	10.40	93.6	12.54	108.6	15.18	116.4	16.68	124.2	18.22	139.4	21.12	154.4	23.24
	25	78.6	10.80	93.6	13.38	108.6	16.28	116.4	17.84	124.2	19.52	139.4	22.60	154.4	24.84
	27	78.6	11.44	93.6	14.22	108.6	17.38	116.4	19.06	124.2	20.80	139.4	24.00	154.4	26.14
	29	78.6	12.14	93.6	15.18	108.6	18.48	116.4	20.30	124.2	22.22	139.4	25.72	154.4	27.98
	31	78.6	12.92	93.6	16.08	108.6	19.70	116.4	21.64	124.2	23.66	139.4	27.30	154.4	29.38
	33	78.6	13.70	93.6	17.18	108.6	21.00	116.4	23.06	124.2	25.20	139.4	28.76	154.4	30.80
	35	78.6	14.54	93.6	18.22	108.6	22.36	116.4	24.56	124.2	26.88	139.4	30.50	152.8	31.92
	37	78.6	15.38	93.6	19.38	108.6	23.72	116.4	26.10	124.2	28.56	139.4	32.18	150.4	33.36
	39	78.6	16.26	93.6	20.48	108.6	25.36	116.4	28.06	124.2	30.70	139.4	34.00	147.8	35.20
	41	76.6	17.98	91.2	22.70	105.8	27.84	113.4	30.76	121.0	33.72	135.8	37.84	141.6	39.00
	43	74.6	19.80	89.0	24.76	103.2	30.40	110.6	33.52	118.2	36.86	132.4	40.50	135.8	41.76
46	70.0	22.02	83.4	27.90	96.8	34.24	103.8	37.32	110.6	41.58	121.2	44.20	124.0	44.92	
48	61.8	19.24	73.8	24.40	85.6	29.94	91.8	32.60	98.0	36.40	105.2	38.26	107.8	38.66	

Note

1. TC: Total Capacity(kW), PI : Power Input(kW, Comp. + Outdoor fan motor)
2. Capacity tables show the average value of conditions which may occur.

7. Capacity Tables

Combination (%)	Outdoor air temp (°C DB)	Cooling Capacity(52HP)													
		Indoor air temp. (DB/WB, °C)													
		20		23		26		27		28		30		32	
		14	16	18	19	20	22	24							
	TC	PI	TC	PI	TC	PI	TC	PI	TC	PI	TC	PI	TC	PI	
70	10	68.6	8.14	82.2	9.68	95.2	11.22	102.0	12.12	108.6	12.94	121.6	14.74	135.2	16.48
	12	68.6	8.26	82.2	9.80	95.2	11.46	102.0	12.30	108.6	13.20	121.6	15.00	135.2	16.80
	14	68.6	8.40	82.2	9.94	95.2	11.66	102.0	12.50	108.6	13.40	121.6	15.32	135.2	17.10
	16	68.6	8.52	82.2	10.12	95.2	11.86	102.0	12.76	108.6	13.64	121.6	15.58	135.2	17.46
	18	68.6	8.66	82.2	10.32	95.2	12.12	102.0	13.00	108.6	13.90	121.6	15.82	135.2	17.78
	20	68.6	8.78	82.2	10.50	95.2	12.30	102.0	13.26	108.6	14.22	121.6	16.22	135.2	18.46
	21	68.6	8.90	82.2	10.58	95.2	12.44	102.0	13.40	108.6	14.36	121.6	16.46	135.2	18.84
	23	68.6	9.04	82.2	10.82	95.2	12.68	102.0	13.84	108.6	15.06	121.6	17.62	135.2	19.90
	25	68.6	9.16	82.2	11.22	95.2	13.52	102.0	14.80	108.6	16.08	121.6	18.84	135.2	20.86
	27	68.6	9.68	82.2	11.98	95.2	14.42	102.0	15.70	108.6	17.18	121.6	20.12	135.2	22.18
	29	68.6	10.32	82.2	12.68	95.2	15.32	102.0	16.72	108.6	18.26	121.6	21.46	135.2	23.76
	31	68.6	10.96	82.2	13.52	95.2	16.34	102.0	17.88	108.6	19.48	121.6	22.88	135.2	25.20
	33	68.6	11.60	82.2	14.28	95.2	17.36	102.0	18.96	108.6	20.70	121.6	24.34	135.2	26.84
	35	68.6	12.24	82.2	15.26	95.2	18.46	102.0	20.18	108.6	22.04	121.6	25.96	135.2	28.46
	37	68.6	13.00	82.2	16.16	95.2	19.60	102.0	21.46	108.6	23.46	121.6	27.62	135.2	30.02
	39	68.6	13.82	82.2	17.22	95.2	20.96	102.0	23.10	108.6	25.34	121.6	29.56	135.2	32.38
	41	66.8	15.28	80.0	18.86	92.8	23.00	99.4	25.34	105.8	27.54	118.6	32.46	131.8	34.92
	43	65.2	16.62	78.0	20.56	90.4	25.10	96.8	27.62	103.2	30.08	115.6	35.46	128.4	37.76
46	61.2	18.48	73.2	23.12	84.8	28.26	90.8	30.76	96.8	33.90	108.4	40.00	120.4	42.08	
48	54.0	16.12	64.8	20.20	75.0	24.70	80.2	26.88	85.6	29.66	95.8	35.00	106.6	36.42	
60	10	58.8	6.98	70.2	8.20	81.6	9.54	87.4	10.22	93.0	10.86	104.6	12.32	116.0	13.78
	12	58.8	7.12	70.2	8.32	81.6	9.66	87.4	10.36	93.0	11.06	104.6	12.52	116.0	14.04
	14	58.8	7.18	70.2	8.46	81.6	9.84	87.4	10.54	93.0	11.24	104.6	12.78	116.0	14.30
	16	58.8	7.30	70.2	8.64	81.6	9.98	87.4	10.74	93.0	11.50	104.6	13.02	116.0	14.54
	18	58.8	7.44	70.2	8.76	81.6	10.16	87.4	10.92	93.0	11.70	104.6	13.22	116.0	14.86
	20	58.8	7.56	70.2	8.90	81.6	10.36	87.4	11.12	93.0	11.88	104.6	13.46	116.0	15.18
	21	58.8	7.62	70.2	8.96	81.6	10.48	87.4	11.24	93.0	12.00	104.6	13.66	116.0	15.32
	23	58.8	7.76	70.2	9.14	81.6	10.62	87.4	11.44	93.0	12.26	104.6	14.16	116.0	16.26
	25	58.8	7.88	70.2	9.34	81.6	11.06	87.4	12.00	93.0	13.02	104.6	15.12	116.0	17.40
	27	58.8	8.14	70.2	9.84	81.6	11.76	87.4	12.78	93.0	13.86	104.6	16.08	116.0	18.56
	29	58.8	8.64	70.2	10.48	81.6	12.52	87.4	13.60	93.0	14.74	104.6	17.16	116.0	19.82
	31	58.8	9.14	70.2	11.12	81.6	13.28	87.4	14.48	93.0	15.70	104.6	18.30	116.0	21.10
	33	58.8	9.66	70.2	11.76	81.6	14.10	87.4	15.38	93.0	16.70	104.6	19.44	116.0	22.50
	35	58.8	10.22	70.2	12.52	81.6	15.00	87.4	16.32	93.0	17.72	104.6	20.72	116.0	23.88
	37	58.8	10.80	70.2	13.20	81.6	15.88	87.4	17.34	93.0	18.80	104.6	21.98	116.0	25.42
	39	58.8	11.48	70.2	14.06	81.6	17.14	87.4	18.60	93.0	20.24	104.6	23.58	116.0	27.24
	41	57.2	12.46	68.4	15.40	79.6	18.62	85.2	20.32	90.6	21.96	101.8	25.86	113.0	29.60
	43	55.8	13.54	66.8	16.76	77.6	20.30	83.0	22.16	88.4	23.96	99.4	28.24	110.2	32.32
46	52.4	15.16	62.6	18.82	72.8	22.82	77.8	24.90	82.8	26.96	93.0	31.82	103.2	36.82	
48	46.2	13.22	55.4	16.42	64.4	19.94	68.8	21.74	73.4	23.56	82.4	27.82	91.4	32.22	
50	10	49.2	5.98	58.8	6.92	68.2	7.88	72.8	8.44	77.4	8.94	86.8	10.08	96.8	11.22
	12	49.2	6.04	58.8	7.00	68.2	8.00	72.8	8.56	77.4	9.14	86.8	10.26	96.8	11.40
	14	49.2	6.12	58.8	7.12	68.2	8.12	72.8	8.70	77.4	9.26	86.8	10.40	96.8	11.60
	16	49.2	6.24	58.8	7.24	68.2	8.26	72.8	8.88	77.4	9.38	86.8	10.58	96.8	11.78
	18	49.2	6.30	58.8	7.30	68.2	8.38	72.8	9.00	77.4	9.58	86.8	10.78	96.8	12.04
	20	49.2	6.36	58.8	7.44	68.2	8.56	72.8	9.14	77.4	9.76	86.8	10.96	96.8	12.28
	21	49.2	6.42	58.8	7.50	68.2	8.64	72.8	9.26	77.4	9.82	86.8	11.08	96.8	12.40
	23	49.2	6.56	58.8	7.62	68.2	8.76	72.8	9.38	77.4	10.02	86.8	11.28	96.8	12.66
	25	49.2	6.62	58.8	7.74	68.2	8.94	72.8	9.58	77.4	10.34	86.8	11.84	96.8	13.54
	27	49.2	6.74	58.8	8.00	68.2	9.44	72.8	10.20	77.4	10.96	86.8	12.66	96.8	14.42
	29	49.2	7.12	58.8	8.50	68.2	10.02	72.8	10.84	77.4	11.66	86.8	13.42	96.8	15.30
	31	49.2	7.50	58.8	9.00	68.2	10.64	72.8	11.46	77.4	12.40	86.8	14.30	96.8	16.32
	33	49.2	7.94	58.8	9.52	68.2	11.28	72.8	12.16	77.4	13.16	86.8	15.18	96.8	17.38
	35	49.2	8.38	58.8	10.08	68.2	11.90	72.8	12.92	77.4	13.92	86.8	16.06	96.8	18.46
	37	49.2	8.88	58.8	10.64	68.2	12.60	72.8	13.66	77.4	14.74	86.8	17.14	96.8	19.60
	39	49.2	9.48	58.8	11.42	68.2	13.50	72.8	14.72	77.4	15.82	86.8	18.26	96.8	21.16
	41	47.8	10.24	57.2	12.36	66.4	14.76	71.0	15.94	75.4	17.14	84.6	20.00	94.2	22.98
	43	46.6	11.14	55.8	13.44	64.8	16.06	69.2	17.36	73.6	18.66	82.6	21.82	92.0	25.06
46	43.8	12.48	52.4	15.08	60.6	18.02	64.8	19.48	69.0	20.94	77.4	24.54	86.2	28.22	
48	38.8	10.86	46.2	13.14	53.6	15.72	57.4	17.00	61.0	18.28	68.4	21.44	76.2	24.66	

Note

1. TC: Total Capacity(kW), PI : Power Input(kW, Comp. + Outdoor fan motor)
2. Capacity tables show the average value of conditions which may occur.

7. Capacity Tables

7.1.3 Three Unit

◆ A(C)RUN540LLS5

Combination (%)	Outdoor air temp (°C DB)	Cooling Capacity(54HP)													
		Indoor air temp. (DB/WB, °C)													
		20		23		26		27		28		30		32	
		14	16	18	19	20	22	24							
	TC	PI	TC	PI	TC	PI	TC	PI	TC	PI	TC	PI	TC	PI	
130	10	149.8	17.65	178.3	21.56	191.1	25.02	196.7	25.52	202.1	25.74	211.9	25.94	217.3	26.04
	12	149.8	18.08	178.3	22.34	191.1	26.04	196.7	26.22	202.1	26.42	211.9	26.64	217.3	26.88
	14	149.8	18.70	178.3	23.14	191.1	27.02	196.7	27.22	202.1	27.44	211.9	27.66	217.3	27.90
	16	149.8	19.37	178.3	23.95	191.1	28.24	196.7	28.50	202.1	28.73	211.9	28.98	217.3	29.22
	18	149.8	20.18	178.3	25.34	191.1	29.54	196.7	30.17	202.1	30.42	211.9	30.72	217.3	30.93
	20	149.8	21.08	178.3	27.00	191.1	31.00	196.7	33.18	202.1	33.46	208.8	33.78	214.3	34.02
	21	149.8	21.63	178.3	27.94	191.1	31.64	196.7	35.12	202.1	35.40	207.6	35.76	213.1	36.00
	23	149.8	23.21	178.3	29.40	191.1	33.28	196.7	38.76	199.5	39.06	204.6	39.46	210.0	39.72
	25	149.8	24.78	178.3	31.08	191.1	35.56	194.3	42.98	196.7	43.32	202.1	43.76	207.6	44.06
	27	149.8	26.52	178.3	33.24	188.7	37.90	191.1	47.31	194.3	47.69	199.5	48.16	204.6	48.50
	29	149.8	28.26	178.3	35.52	185.7	40.77	188.4	52.01	191.1	52.31	196.7	52.78	202.1	52.99
	31	149.8	30.16	177.8	37.42	182.6	43.38	185.7	51.78	188.4	52.10	193.6	52.56	199.0	52.76
	33	149.8	32.12	174.7	39.65	180.2	46.52	183.2	51.31	185.7	51.62	191.1	52.08	196.0	52.29
	35	149.8	34.26	171.6	41.52	177.2	50.38	180.2	50.64	183.2	50.94	188.1	51.40	193.6	51.60
	37	149.8	36.54	169.2	43.58	174.7	49.72	177.2	49.97	180.2	50.28	185.0	50.72	190.6	50.92
	39	149.8	38.90	166.1	45.86	171.6	49.06	174.7	49.30	177.2	49.60	182.6	50.05	188.1	50.24
	41	145.9	41.27	159.3	48.16	164.7	48.39	167.1	48.63	170.5	48.93	175.5	49.36	180.3	49.56
	43	142.3	43.52	152.6	47.48	158.0	47.72	160.3	47.96	163.7	48.25	168.7	48.69	173.2	48.88
46	133.3	46.59	139.3	46.50	144.4	46.73	146.6	46.96	149.6	47.24	154.3	47.67	158.6	47.86	
48	118.0	45.29	120.9	45.42	125.5	45.52	127.5	45.65	130.2	46.04	134.4	46.33	138.1	46.52	
120	10	135.5	15.88	161.1	19.46	176.1	23.14	181.5	25.00	186.8	25.39	197.0	25.49	201.7	25.70
	12	135.5	16.30	161.1	20.13	176.1	24.06	181.5	25.52	186.8	26.33	197.0	26.65	201.7	26.87
	14	135.5	16.86	161.1	20.80	176.1	25.04	181.5	26.50	186.8	27.30	197.0	27.70	201.7	27.92
	16	135.5	17.48	161.1	21.66	176.1	26.00	181.5	27.48	186.8	28.56	197.0	28.92	201.7	29.14
	18	135.5	18.15	161.1	22.63	176.1	27.05	181.5	28.94	186.8	30.02	197.0	30.37	201.7	30.62
	20	135.5	18.84	161.1	23.99	176.1	28.50	181.5	30.44	186.8	31.61	197.0	32.03	201.7	32.29
	21	135.5	19.41	161.1	24.86	176.1	29.30	181.5	31.35	186.8	32.66	197.0	33.08	201.7	33.34
	23	135.5	20.76	161.1	26.60	176.1	31.39	181.5	33.31	186.8	34.82	197.0	35.16	201.7	35.44
	25	135.5	22.19	161.1	28.50	176.1	33.10	181.5	35.51	186.8	37.34	194.6	37.64	199.4	37.95
	27	135.5	23.68	161.1	30.47	176.1	35.24	181.5	37.94	186.8	40.12	191.7	40.39	196.4	40.72
	29	135.5	25.26	161.1	32.52	176.1	37.08	181.5	40.59	183.8	42.76	188.6	43.41	194.0	43.76
	31	135.5	26.92	161.1	34.74	176.1	38.99	179.1	43.48	181.5	45.87	186.3	46.68	190.9	47.06
	33	135.5	28.66	161.1	37.02	173.7	41.24	176.1	47.20	178.5	49.26	183.2	49.82	188.0	50.21
	35	135.5	30.47	161.1	39.46	170.7	43.66	173.1	52.01	176.1	52.26	180.9	52.41	185.6	52.83
	37	135.5	32.78	161.1	41.64	168.3	46.54	170.7	50.90	173.1	51.17	177.8	51.32	182.7	51.73
	39	135.5	35.28	160.6	44.02	165.3	49.36	167.8	49.86	170.1	50.11	175.5	50.26	180.3	50.66
	41	132.0	37.80	153.5	46.38	158.7	48.39	161.0	48.81	163.3	49.06	168.0	49.21	172.8	49.60
	43	128.8	40.34	147.1	45.72	152.2	47.31	154.4	47.76	156.6	48.00	161.3	48.15	166.0	48.53
46	120.7	43.38	134.1	44.64	139.0	45.82	141.0	46.20	143.2	46.43	147.5	46.57	151.9	46.94	
48	106.7	42.48	116.5	43.84	120.8	44.93	122.7	45.20	124.6	45.34	128.3	45.52	132.3	45.72	
110	10	121.4	14.28	144.8	17.40	161.6	20.67	166.4	22.38	176.8	24.08	180.9	24.76	193.1	25.16
	12	121.4	14.72	144.8	18.00	161.6	21.54	166.4	23.00	176.8	24.99	180.9	25.80	193.1	26.39
	14	121.4	15.18	144.8	18.80	161.6	22.51	166.4	24.15	176.8	26.25	180.9	26.99	193.1	27.56
	16	121.4	15.72	144.8	19.48	161.6	23.43	166.4	25.20	176.8	27.45	180.9	28.20	193.1	28.70
	18	121.4	16.30	144.8	20.30	161.6	24.78	166.4	26.54	176.8	28.96	180.9	29.54	193.1	30.09
	20	121.4	16.88	144.8	21.32	161.6	26.28	166.4	27.76	176.8	30.37	180.9	31.12	193.1	31.61
	21	121.4	17.26	144.8	21.94	161.6	26.96	166.4	28.50	176.8	31.22	180.9	32.00	193.1	32.50
	23	121.4	18.39	144.8	23.52	161.6	28.46	166.4	30.10	176.8	32.98	180.9	33.69	193.1	34.24
	25	121.4	19.66	144.8	25.10	161.6	30.07	166.4	31.82	176.8	34.84	180.9	35.34	190.8	36.07
	27	121.4	21.00	144.8	26.84	161.6	31.78	166.4	33.67	176.8	36.38	180.9	37.22	188.0	37.86
	29	121.4	22.42	144.8	28.66	161.6	33.58	166.4	35.66	176.8	38.46	180.9	39.12	185.6	39.71
	31	121.4	23.84	144.8	30.55	161.6	35.48	166.4	37.78	173.9	40.40	178.6	41.19	182.7	41.63
	33	121.4	25.42	144.8	32.52	161.6	37.50	166.4	40.04	171.5	42.67	175.7	43.38	180.3	43.62
	35	121.4	27.00	144.8	34.74	161.6	39.60	166.4	42.43	168.7	45.03	172.8	45.44	177.4	45.68
	37	121.4	28.61	144.8	36.86	161.6	41.80	164.0	44.95	165.7	47.50	170.5	47.66	174.5	47.80
	39	121.4	30.84	144.8	39.18	158.7	44.11	161.0	48.08	163.4	49.84	167.4	49.93	172.2	49.98
	41	118.3	33.08	141.0	41.48	152.0	46.52	154.3	52.01	156.3	52.01	161.0	52.41	164.9	52.83
	43	115.3	34.74	137.5	43.22	145.6	49.32	148.0	49.88	149.9	49.78	154.3	50.06	158.3	50.20
46	108.1	33.90	128.9	41.72	132.9	46.81	135.1	46.81	136.9	47.22	141.1	47.48	144.8	47.60	
48	95.6	32.92	112.0	40.20	115.4	44.54	117.5	44.84	119.1	45.06	122.8	45.18	125.9	45.36	

Note

1. TC: Total Capacity(kW), PI : Power Input(kW, Comp. + Outdoor fan motor)
2. Capacity tables show the average value of conditions which may occur.

7. Capacity Tables

		Cooling Capacity(54HP)													
Combination (%)	Outdoor air temp (°C DB)	Indoor air temp. (DB/WB, °C)													
		20		23		26		27		28		30		32	
		14	16	18	19	20	22	24	TC	PI	TC	PI	TC	PI	
100	10	102.0	12.86	121.5	15.62	141.4	18.54	151.2	20.04	161.0	21.53	178.4	23.96	182.3	24.16
	12	102.0	13.28	121.5	16.26	141.4	19.16	151.2	20.58	161.0	22.21	178.4	25.25	182.3	25.50
	14	102.0	13.69	121.5	16.92	141.4	19.97	151.2	21.46	161.0	23.18	178.4	26.66	182.3	26.92
	16	102.0	14.10	121.5	17.48	141.4	20.83	151.2	22.48	161.0	24.42	178.4	27.96	182.3	28.34
	18	102.0	14.52	121.5	18.13	141.4	21.64	151.2	23.58	161.0	25.90	178.4	29.54	182.3	29.77
	20	102.0	15.04	121.5	18.81	141.4	22.90	151.2	25.26	161.0	27.71	178.4	30.94	182.3	31.19
	21	102.0	15.35	121.5	19.26	141.4	23.68	151.2	26.12	161.0	28.74	178.4	31.65	182.3	31.91
	23	102.0	16.26	121.5	20.60	141.4	25.42	151.2	28.03	161.0	30.79	178.4	33.14	182.3	33.42
	25	102.0	17.29	121.5	21.94	141.4	27.16	151.2	30.00	161.0	32.92	178.4	34.56	180.8	34.83
	27	102.0	18.47	121.5	23.45	141.4	29.04	151.2	32.05	161.0	35.00	174.9	36.18	178.6	36.47
	29	102.0	19.66	121.5	25.02	141.4	31.02	151.2	34.26	161.0	37.04	171.8	37.64	175.9	37.94
	31	102.0	21.00	121.5	26.68	141.4	33.08	151.2	36.54	161.0	38.92	169.1	39.09	173.2	39.41
	33	102.0	22.26	121.5	28.42	141.4	35.28	151.2	38.99	161.0	40.38	166.4	40.56	170.5	40.88
	35	102.0	23.68	121.5	30.24	141.4	37.58	151.2	41.60	158.5	41.84	163.4	42.02	167.5	42.34
	37	102.0	25.36	121.5	32.43	141.4	39.81	151.2	43.58	155.8	43.80	160.3	43.98	164.1	44.37
	39	102.0	27.20	121.5	34.83	141.4	42.17	151.2	45.72	153.3	45.91	157.8	46.08	161.4	46.52
	41	100.5	29.02	119.6	37.24	139.2	44.55	145.1	47.85	148.2	48.04	151.8	48.20	156.6	48.66
	43	97.0	30.72	115.5	39.48	134.4	46.68	139.1	49.68	140.7	49.84	145.0	50.02	148.9	50.48
46	90.9	33.04	108.2	42.56	126.0	49.51	127.0	52.01	128.3	52.16	132.5	52.30	136.0	52.80	
48	80.4	28.52	95.8	36.82	108.8	42.33	110.3	44.12	111.5	44.26	115.2	44.36	118.4	44.72	
90	10	91.8	11.03	109.7	13.26	127.5	15.63	136.0	16.85	144.8	18.14	162.6	20.29	180.3	22.57
	12	91.8	11.16	109.7	13.46	127.5	15.91	136.0	17.18	144.8	18.53	162.6	20.70	180.3	22.97
	14	91.8	11.37	109.7	13.73	127.5	16.24	136.0	17.53	144.8	18.88	162.6	21.10	180.3	23.44
	16	91.8	11.57	109.7	14.01	127.5	16.57	136.0	17.86	144.8	19.22	162.6	21.50	180.3	23.83
	18	91.8	11.77	109.7	14.28	127.5	16.85	136.0	18.28	144.8	19.63	162.6	21.97	180.3	25.04
	20	91.8	11.97	109.7	14.55	127.5	17.18	136.0	18.61	144.8	20.37	162.6	23.51	180.3	26.23
	21	91.8	12.11	109.7	14.69	127.5	17.53	136.0	19.22	144.8	21.11	162.6	23.90	180.3	26.84
	23	91.8	12.38	109.7	15.30	127.5	18.75	136.0	20.63	144.8	22.61	162.6	25.34	177.8	28.11
	25	91.8	12.99	109.7	16.30	127.5	20.03	136.0	22.06	144.8	24.15	162.6	27.10	175.3	29.30
	27	91.8	13.87	109.7	17.39	127.5	21.38	136.0	23.54	144.8	25.85	162.6	28.80	172.8	30.68
	29	91.8	14.69	109.7	18.53	127.5	22.86	136.0	25.18	144.8	27.61	162.6	30.52	170.1	31.91
	31	91.8	15.63	109.7	19.76	127.5	24.36	136.0	26.80	144.8	29.44	162.6	32.04	167.6	33.15
	33	91.8	16.65	109.7	21.04	127.5	25.98	136.0	28.56	144.8	31.22	162.6	33.59	165.1	34.38
	35	91.8	17.67	109.7	22.33	127.5	27.61	136.0	30.44	144.8	33.11	159.7	35.51	162.4	36.34
	37	91.8	18.75	109.7	23.75	127.5	29.44	136.0	32.34	144.8	34.95	157.2	37.13	159.9	37.96
	39	91.8	19.84	109.7	25.26	127.5	31.16	136.0	34.42	144.8	36.75	154.6	39.14	157.3	39.61
	41	89.5	22.21	106.7	28.01	124.2	34.20	132.6	37.64	141.0	39.68	148.1	41.24	150.8	42.20
	43	87.2	23.97	104.2	30.26	121.1	37.35	129.3	40.54	137.5	42.54	142.1	44.17	144.6	44.71
46	81.8	26.98	97.6	34.47	113.4	42.57	121.2	45.97	125.0	47.26	129.6	48.49	132.1	48.55	
48	72.3	23.58	86.4	30.15	100.3	37.23	107.2	40.10	108.5	40.73	112.7	41.74	114.8	41.79	
80	10	81.6	9.28	97.2	11.17	112.8	13.10	120.9	14.13	129.0	15.16	144.8	17.30	160.3	18.77
	12	81.6	9.49	97.2	11.28	112.8	13.36	120.9	14.39	129.0	15.41	144.8	17.62	160.3	19.14
	14	81.6	9.61	97.2	11.54	112.8	13.54	120.9	14.64	129.0	15.68	144.8	17.94	160.3	19.51
	16	81.6	9.74	97.2	11.74	112.8	13.80	120.9	14.90	129.0	16.00	144.8	18.32	160.3	19.89
	18	81.6	9.94	97.2	11.94	112.8	14.07	120.9	15.16	129.0	16.32	144.8	18.64	160.3	20.32
	20	81.6	10.13	97.2	12.19	112.8	14.39	120.9	15.48	129.0	16.65	144.8	19.35	160.3	21.53
	21	81.6	10.19	97.2	12.32	112.8	14.51	120.9	15.68	129.0	17.03	144.8	19.96	160.3	22.10
	23	81.6	10.39	97.2	12.51	112.8	15.16	120.9	16.65	129.0	18.19	144.8	21.08	160.3	23.20
	25	81.6	10.78	97.2	13.36	112.8	16.26	120.9	17.81	129.0	19.49	144.8	22.56	160.3	24.80
	27	81.6	11.42	97.2	14.19	112.8	17.35	120.9	19.03	129.0	20.77	144.8	23.97	160.3	26.09
	29	81.6	12.13	97.2	15.16	112.8	18.45	120.9	20.27	129.0	22.19	144.8	25.68	160.3	27.94
	31	81.6	12.90	97.2	16.06	112.8	19.67	120.9	21.61	129.0	23.62	144.8	27.26	160.3	29.33
	33	81.6	13.68	97.2	17.16	112.8	20.96	120.9	23.03	129.0	25.16	144.8	28.72	160.3	30.75
	35	81.6	14.51	97.2	18.19	112.8	22.32	120.9	24.52	129.0	26.84	144.8	30.45	158.7	31.86
	37	81.6	15.36	97.2	19.35	112.8	23.68	120.9	26.07	129.0	28.52	144.8	32.13	156.2	33.31
	39	81.6	16.23	97.2	20.45	112.8	25.32	120.9	28.02	129.0	30.64	144.8	33.95	153.5	35.14
	41	79.5	17.95	94.7	22.67	109.9	27.80	117.8	30.71	125.7	33.67	141.0	37.79	147.1	38.94
	43	77.5	19.77	92.4	24.72	107.2	30.35	114.9	33.47	122.7	36.80	137.5	40.44	141.0	41.70
46	72.6	21.99	86.5	27.86	100.5	34.18	107.7	37.26	114.9	41.52	125.8	44.13	128.7	44.85	
48	64.2	19.21	76.6	24.36	88.9	29.90	95.3	32.54	101.7	36.35	109.3	38.20	111.9	38.61	

Note

1. TC: Total Capacity(kW), PI : Power Input(kW, Comp. + Outdoor fan motor)
2. Capacity tables show the average value of conditions which may occur.

7. Capacity Tables

Combination (%)	Outdoor air temp (°C DB)	Cooling Capacity(54HP)													
		Indoor air temp. (DB/WB, °C)													
		20		23		26		27		28		30		32	
		14	16	18	19	20	22	24							
	TC	PI	TC	PI	TC	PI	TC	PI	TC	PI	TC	PI	TC	PI	
70	10	71.2	8.21	85.4	9.76	98.9	11.31	105.9	12.21	112.8	13.05	126.3	14.86	140.4	16.61
	12	71.2	8.33	85.4	9.88	98.9	11.55	105.9	12.40	112.8	13.31	126.3	15.11	140.4	16.93
	14	71.2	8.47	85.4	10.01	98.9	11.76	105.9	12.60	112.8	13.50	126.3	15.44	140.4	17.23
	16	71.2	8.58	85.4	10.20	98.9	11.95	105.9	12.86	112.8	13.75	126.3	15.70	140.4	17.61
	18	71.2	8.72	85.4	10.40	98.9	12.21	105.9	13.10	112.8	14.02	126.3	15.95	140.4	17.92
	20	71.2	8.85	85.4	10.59	98.9	12.40	105.9	13.37	112.8	14.34	126.3	16.34	140.4	18.60
	21	71.2	8.97	85.4	10.66	98.9	12.53	105.9	13.50	112.8	14.47	126.3	16.60	140.4	19.00
	23	71.2	9.11	85.4	10.91	98.9	12.78	105.9	13.95	112.8	15.18	126.3	17.76	140.4	20.06
	25	71.2	9.23	85.4	11.31	98.9	13.63	105.9	14.92	112.8	16.21	126.3	18.99	140.4	21.03
	27	71.2	9.76	85.4	12.08	98.9	14.53	105.9	15.82	112.8	17.31	126.3	20.28	140.4	22.35
	29	71.2	10.40	85.4	12.78	98.9	15.44	105.9	16.86	112.8	18.41	126.3	21.63	140.4	23.94
	31	71.2	11.05	85.4	13.63	98.9	16.47	105.9	18.02	112.8	19.63	126.3	23.06	140.4	25.40
	33	71.2	11.69	85.4	14.39	98.9	17.50	105.9	19.12	112.8	20.87	126.3	24.54	140.4	27.05
	35	71.2	12.34	85.4	15.38	98.9	18.60	105.9	20.34	112.8	22.21	126.3	26.16	140.4	28.68
	37	71.2	13.10	85.4	16.29	98.9	19.76	105.9	21.63	112.8	23.64	126.3	27.84	140.4	30.27
	39	71.2	13.93	85.4	17.36	98.9	21.13	105.9	23.28	112.8	25.54	126.3	29.79	140.4	32.64
	41	69.4	15.40	83.1	19.01	96.3	23.18	103.2	25.54	109.9	27.76	123.2	32.72	136.8	35.20
	43	67.8	16.75	81.0	20.73	93.9	25.30	100.6	27.84	107.2	30.32	120.1	35.74	133.3	38.06
46	63.5	18.62	76.0	23.31	88.1	28.49	94.2	31.01	100.5	34.18	112.5	40.32	125.0	42.42	
48	56.1	16.25	67.2	20.36	77.9	24.90	83.3	27.09	88.9	29.89	99.5	35.28	110.7	36.71	
60	10	61.1	7.11	72.9	8.34	84.7	9.70	90.8	10.41	96.6	11.06	108.6	12.54	120.5	14.03
	12	61.1	7.25	72.9	8.47	84.7	9.83	90.8	10.54	96.6	11.25	108.6	12.74	120.5	14.29
	14	61.1	7.30	72.9	8.60	84.7	10.02	90.8	10.73	96.6	11.45	108.6	13.00	120.5	14.55
	16	61.1	7.43	72.9	8.80	84.7	10.16	90.8	10.93	96.6	11.71	108.6	13.25	120.5	14.80
	18	61.1	7.57	72.9	8.92	84.7	10.34	90.8	11.12	96.6	11.90	108.6	13.45	120.5	15.13
	20	61.1	7.69	72.9	9.06	84.7	10.54	90.8	11.32	96.6	12.10	108.6	13.71	120.5	15.45
	21	61.1	7.76	72.9	9.12	84.7	10.67	90.8	11.45	96.6	12.22	108.6	13.90	120.5	15.59
	23	61.1	7.90	72.9	9.31	84.7	10.81	90.8	11.64	96.6	12.48	108.6	14.41	120.5	16.55
	25	61.1	8.02	72.9	9.51	84.7	11.25	90.8	12.22	96.6	13.25	108.6	15.39	120.5	17.71
	27	61.1	8.28	72.9	10.02	84.7	11.97	90.8	13.00	96.6	14.10	108.6	16.36	120.5	18.89
	29	61.1	8.80	72.9	10.67	84.7	12.74	90.8	13.84	96.6	15.01	108.6	17.46	120.5	20.17
	31	61.1	9.31	72.9	11.32	84.7	13.51	90.8	14.74	96.6	15.98	108.6	18.62	120.5	21.47
	33	61.1	9.83	72.9	11.97	84.7	14.36	90.8	15.66	96.6	17.00	108.6	19.79	120.5	22.89
	35	61.1	10.41	72.9	12.74	84.7	15.27	90.8	16.62	96.6	18.04	108.6	21.09	120.5	24.31
	37	61.1	10.99	72.9	13.44	84.7	16.16	90.8	17.65	96.6	19.14	108.6	22.37	120.5	25.87
	39	61.1	11.68	72.9	14.31	84.7	17.45	90.8	18.93	96.6	20.60	108.6	24.00	120.5	27.72
	41	59.4	12.68	71.0	15.67	82.7	18.95	88.4	20.69	94.1	22.35	105.7	26.33	117.4	30.12
	43	58.0	13.77	69.3	17.06	80.6	20.66	86.2	22.54	91.8	24.39	103.2	28.74	114.4	32.90
46	54.4	15.43	64.9	19.15	75.6	23.23	80.8	25.34	86.0	27.44	96.6	32.38	107.2	37.48	
48	48.0	13.45	57.5	16.71	66.8	20.30	71.5	22.13	76.2	23.97	85.5	28.32	94.9	32.80	
50	10	51.0	6.15	61.1	7.12	70.8	8.10	75.6	8.67	80.4	9.19	90.1	10.36	100.5	11.52
	12	51.0	6.21	61.1	7.19	70.8	8.22	75.6	8.80	80.4	9.39	90.1	10.55	100.5	11.72
	14	51.0	6.29	61.1	7.31	70.8	8.35	75.6	8.93	80.4	9.51	90.1	10.69	100.5	11.92
	16	51.0	6.41	61.1	7.44	70.8	8.49	75.6	9.13	80.4	9.64	90.1	10.87	100.5	12.10
	18	51.0	6.47	61.1	7.51	70.8	8.61	75.6	9.25	80.4	9.84	90.1	11.08	100.5	12.37
	20	51.0	6.54	61.1	7.64	70.8	8.80	75.6	9.39	80.4	10.03	90.1	11.26	100.5	12.62
	21	51.0	6.60	61.1	7.70	70.8	8.87	75.6	9.51	80.4	10.10	90.1	11.39	100.5	12.74
	23	51.0	6.74	61.1	7.84	70.8	9.00	75.6	9.64	80.4	10.29	90.1	11.59	100.5	13.01
	25	51.0	6.80	61.1	7.96	70.8	9.19	75.6	9.84	80.4	10.62	90.1	12.17	100.5	13.92
	27	51.0	6.92	61.1	8.22	70.8	9.71	75.6	10.48	80.4	11.26	90.1	13.01	100.5	14.82
	29	51.0	7.31	61.1	8.74	70.8	10.29	75.6	11.13	80.4	11.98	90.1	13.79	100.5	15.73
	31	51.0	7.70	61.1	9.25	70.8	10.94	75.6	11.78	80.4	12.74	90.1	14.69	100.5	16.77
	33	51.0	8.16	61.1	9.78	70.8	11.59	75.6	12.49	80.4	13.53	90.1	15.60	100.5	17.87
	35	51.0	8.61	61.1	10.36	70.8	12.23	75.6	13.28	80.4	14.31	90.1	16.51	100.5	18.97
	37	51.0	9.13	61.1	10.94	70.8	12.95	75.6	14.04	80.4	15.15	90.1	17.61	100.5	20.13
	39	51.0	9.74	61.1	11.73	70.8	13.88	75.6	15.12	80.4	16.26	90.1	18.76	100.5	21.74
	41	49.6	10.53	59.4	12.70	68.9	15.17	73.7	16.38	78.3	17.61	87.8	20.55	97.8	23.61
	43	48.5	11.45	58.0	13.81	67.2	16.51	71.9	17.84	76.5	19.18	85.7	22.42	95.5	25.76
46	45.5	12.82	54.4	15.49	63.0	18.52	67.3	20.03	71.6	21.52	80.3	25.22	89.5	29.00	
48	40.2	11.16	48.0	13.50	55.7	16.15	59.5	17.48	63.4	18.78	71.1	22.04	79.1	25.35	

Note

1. TC: Total Capacity(kW), PI : Power Input(kW, Comp. + Outdoor fan motor)
2. Capacity tables show the average value of conditions which may occur.

7. Capacity Tables

◆ A(C)RUN560LLS5

Combination (%)	Outdoor air temp (°C DB)	Indoor air temp. (DB/WB, °C)														Cooling Capacity(56HP)	
		20		23		26		27		28		30		32		TC	PI
		14		16		18		19		20		22		24			
		TC	PI	TC	PI	TC	PI	TC	PI	TC	PI	TC	PI	TC	PI		
130	10	155.3	17.82	185.0	21.77	198.2	25.26	203.9	25.77	209.6	25.99	219.7	26.19	225.3	26.29		
	12	155.3	18.26	185.0	22.55	198.2	26.29	203.9	26.47	209.6	26.67	219.7	26.90	225.3	27.14		
	14	155.3	18.88	185.0	23.36	198.2	27.28	203.9	27.48	209.6	27.70	219.7	27.93	225.3	28.17		
	16	155.3	19.56	185.0	24.18	198.2	28.51	203.9	28.78	209.6	29.00	219.7	29.26	225.3	29.50		
	18	155.3	20.38	185.0	25.58	198.2	29.82	203.9	30.46	209.6	30.71	219.7	31.01	225.3	31.22		
	20	155.3	21.28	185.0	27.26	198.2	31.29	203.9	33.50	209.6	33.78	216.5	34.11	222.2	34.35		
	21	155.3	21.84	185.0	28.21	198.2	31.95	203.9	35.45	209.6	35.74	215.3	36.10	221.0	36.34		
	23	155.3	23.43	185.0	29.68	198.2	33.60	203.9	39.13	206.9	39.44	212.2	39.83	217.8	40.11		
	25	155.3	25.02	185.0	31.38	198.2	35.91	201.5	43.40	203.9	43.74	209.6	44.18	215.3	44.49		
	27	155.3	26.77	185.0	33.56	195.7	38.27	198.2	47.77	201.5	48.15	206.9	48.62	212.2	48.97		
	29	155.3	28.54	185.0	35.86	192.6	41.17	195.4	52.51	198.2	52.82	203.9	53.29	209.6	53.50		
	31	155.3	30.45	184.4	37.78	189.4	43.79	192.6	52.28	195.4	52.60	200.7	53.06	206.3	53.27		
	33	155.3	32.43	181.1	40.03	186.9	46.96	189.9	51.80	192.6	52.11	198.2	52.58	203.2	52.79		
	35	155.3	34.59	177.9	41.92	183.7	50.87	186.9	51.12	189.9	51.43	195.1	51.90	200.7	52.10		
	37	155.3	36.89	175.5	43.99	181.1	50.20	183.7	50.46	186.9	50.76	191.9	51.21	197.6	51.41		
	39	155.3	39.27	172.3	46.30	177.9	49.53	181.1	49.78	183.7	50.07	189.4	50.53	195.1	50.72		
	41	151.3	41.66	165.2	48.62	170.8	48.86	173.3	49.10	176.8	49.40	182.0	49.84	187.0	50.03		
	43	147.5	43.94	158.3	47.94	163.9	48.18	166.3	48.42	169.7	48.72	174.9	49.15	179.6	49.35		
46	138.3	47.04	144.4	46.95	149.7	47.18	152.1	47.42	155.2	47.70	160.0	48.12	164.5	48.32			
48	122.3	45.72	125.4	45.86	130.1	45.96	132.2	46.09	135.0	46.48	139.4	46.78	143.2	46.96			
120	10	140.5	16.03	167.1	19.65	182.6	23.36	188.2	25.24	193.7	25.64	204.3	25.74	209.2	25.95		
	12	140.5	16.46	167.1	20.32	182.6	24.29	188.2	25.77	193.7	26.59	204.3	26.91	209.2	27.12		
	14	140.5	17.03	167.1	21.00	182.6	25.28	188.2	26.75	193.7	27.56	204.3	27.97	209.2	28.19		
	16	140.5	17.65	167.1	21.86	182.6	26.25	188.2	27.75	193.7	28.84	204.3	29.20	209.2	29.42		
	18	140.5	18.33	167.1	22.85	182.6	27.31	188.2	29.21	193.7	30.31	204.3	30.66	209.2	30.91		
	20	140.5	19.02	167.1	24.23	182.6	28.78	188.2	30.73	193.7	31.92	204.3	32.34	209.2	32.60		
	21	140.5	19.60	167.1	25.10	182.6	29.58	188.2	31.65	193.7	32.98	204.3	33.40	209.2	33.66		
	23	140.5	20.96	167.1	26.86	182.6	31.69	188.2	33.63	193.7	35.15	204.3	35.50	209.2	35.78		
	25	140.5	22.40	167.1	28.78	182.6	33.42	188.2	35.85	193.7	37.70	201.8	38.00	206.7	38.31		
	27	140.5	23.91	167.1	30.76	182.6	35.58	188.2	38.31	193.7	40.50	198.8	40.78	203.7	41.11		
	29	140.5	25.50	167.1	32.84	182.6	37.43	188.2	40.98	190.6	43.17	195.6	43.82	201.2	44.18		
	31	140.5	27.18	167.1	35.07	182.6	39.37	185.7	43.90	188.2	46.31	193.2	47.13	198.0	47.51		
	33	140.5	28.93	167.1	37.38	180.1	41.64	182.6	47.66	185.1	49.73	190.0	50.30	195.0	50.70		
	35	140.5	30.76	167.1	39.84	177.0	44.08	179.5	52.51	182.6	52.76	187.6	52.92	192.5	53.34		
	37	140.5	33.09	167.1	42.04	174.5	46.99	177.0	51.39	179.5	51.66	184.4	51.81	189.5	52.22		
	39	140.5	35.62	166.5	44.44	171.4	49.84	174.0	50.34	176.4	50.60	182.0	50.74	187.0	51.15		
	41	136.9	38.16	159.2	46.83	164.6	48.86	167.0	49.28	169.3	49.54	174.2	49.68	179.2	50.07		
	43	133.5	40.73	152.5	46.16	157.8	47.77	160.1	48.22	162.4	48.46	167.3	48.62	172.1	49.00		
46	125.1	43.79	139.1	45.07	144.1	46.26	146.2	46.64	148.5	46.88	153.0	47.02	157.5	47.39			
48	110.7	42.89	120.8	44.26	125.3	45.36	127.3	45.64	129.2	45.78	133.1	45.96	137.2	46.16			
110	10	125.9	14.42	150.1	17.57	167.6	20.87	172.5	22.60	183.3	24.31	187.6	25.00	200.3	25.40		
	12	125.9	14.86	150.1	18.17	167.6	21.75	172.5	23.22	183.3	25.23	187.6	26.05	200.3	26.64		
	14	125.9	15.33	150.1	18.98	167.6	22.72	172.5	24.38	183.3	26.50	187.6	27.25	200.3	27.83		
	16	125.9	15.87	150.1	19.67	167.6	23.66	172.5	25.44	183.3	27.72	187.6	28.47	200.3	28.98		
	18	125.9	16.46	150.1	20.49	167.6	25.02	172.5	26.80	183.3	29.24	187.6	29.82	200.3	30.38		
	20	125.9	17.04	150.1	21.52	167.6	26.53	172.5	28.03	183.3	30.66	187.6	31.42	200.3	31.92		
	21	125.9	17.42	150.1	22.15	167.6	27.22	172.5	28.78	183.3	31.52	187.6	32.31	200.3	32.81		
	23	125.9	18.57	150.1	23.75	167.6	28.74	172.5	30.39	183.3	33.30	187.6	34.01	200.3	34.57		
	25	125.9	19.85	150.1	25.34	167.6	30.36	172.5	32.13	183.3	35.17	187.6	35.68	197.9	36.41		
	27	125.9	21.20	150.1	27.10	167.6	32.09	172.5	34.00	183.3	36.73	187.6	37.57	195.0	38.22		
	29	125.9	22.64	150.1	28.93	167.6	33.90	172.5	36.00	183.3	38.83	187.6	39.50	192.5	40.09		
	31	125.9	24.07	150.1	30.84	167.6	35.82	172.5	38.14	180.4	40.79	185.2	41.59	189.5	42.03		
	33	125.9	25.67	150.1	32.84	167.6	37.86	172.5	40.43	177.9	43.08	182.2	43.80	187.0	44.04		
	35	125.9	27.26	150.1	35.07	167.6	39.98	172.5	42.83	174.9	45.46	179.2	45.88	183.9	46.11		
	37	125.9	28.89	150.1	37.22	167.6	42.20	170.1	45.38	171.8	47.95	176.8	48.12	181.0	48.26		
	39	125.9	31.14	150.1	39.55	164.6	44.53	167.0	48.54	169.5	50.32	173.6	50.41	178.6	50.46		
	41	122.7	33.40	146.2	41.87	157.6	46.96	160.0	52.51	162.1	52.51	166.9	52.92	171.0	53.34		
	43	119.6	35.07	142.6	43.64	151.0	49.79	153.5	50.36	155.5	50.26	160.1	50.54	164.2	50.68		
46	112.1	34.22	133.7	42.13	137.8	47.26	140.2	47.26	141.9	47.67	146.3	47.94	150.2	48.06			
48	99.2	33.24	116.1	40.58	119.7	44.97	121.9	45.27	123.5	45.49	127.3	45.62	130.6	45.79			

Note

1. TC: Total Capacity(kW), PI : Power Input(kW, Comp. + Outdoor fan motor)
2. Capacity tables show the average value of conditions which may occur.

7. Capacity Tables

Combination (%)	Outdoor air temp (°C DB)	Cooling Capacity(56HP)													
		Indoor air temp. (DB/WB, °C)													
		20		23		26		27		28		30		32	
		14	16	18	19	20	22	24	TC	PI	TC	PI	TC	PI	
100	10	105.8	12.98	126.0	15.77	146.7	18.72	156.8	20.23	166.9	21.73	185.0	24.20	189.1	24.39
	12	105.8	13.40	126.0	16.42	146.7	19.35	156.8	20.77	166.9	22.43	185.0	25.50	189.1	25.75
	14	105.8	13.82	126.0	17.08	146.7	20.17	156.8	21.67	166.9	23.40	185.0	26.91	189.1	27.18
	16	105.8	14.24	126.0	17.65	146.7	21.03	156.8	22.70	166.9	24.65	185.0	28.22	189.1	28.61
	18	105.8	14.66	126.0	18.30	146.7	21.85	156.8	23.80	166.9	26.15	185.0	29.82	189.1	30.05
	20	105.8	15.19	126.0	18.99	146.7	23.12	156.8	25.50	166.9	27.97	185.0	31.24	189.1	31.49
	21	105.8	15.50	126.0	19.44	146.7	23.91	156.8	26.38	166.9	29.02	185.0	31.96	189.1	32.21
	23	105.8	16.42	126.0	20.80	146.7	25.67	156.8	28.30	166.9	31.08	185.0	33.46	189.1	33.74
	25	105.8	17.45	126.0	22.15	146.7	27.42	156.8	30.29	166.9	33.23	185.0	34.89	187.5	35.17
	27	105.8	18.65	126.0	23.67	146.7	29.32	156.8	32.36	166.9	35.34	181.4	36.53	185.2	36.82
	29	105.8	19.85	126.0	25.26	146.7	31.32	156.8	34.59	166.9	37.39	178.1	38.00	182.4	38.31
	31	105.8	21.20	126.0	26.94	146.7	33.40	156.8	36.90	166.9	39.30	175.4	39.47	179.6	39.79
	33	105.8	22.47	126.0	28.69	146.7	35.62	156.8	39.37	166.9	40.77	172.6	40.95	176.8	41.28
	35	105.8	23.91	126.0	30.53	146.7	37.94	156.8	42.00	164.3	42.24	169.5	42.42	173.7	42.75
	37	105.8	25.61	126.0	32.74	146.7	40.19	156.8	44.00	161.6	44.22	166.2	44.40	170.2	44.80
	39	105.8	27.46	126.0	35.17	146.7	42.58	156.8	46.16	159.0	46.36	163.7	46.53	167.4	46.96
	41	104.2	29.30	124.1	37.60	144.3	44.98	150.5	48.31	153.7	48.50	157.4	48.66	162.4	49.12
	43	100.6	31.01	119.8	39.86	139.4	47.13	144.3	50.16	145.9	50.32	150.4	50.50	154.4	50.97
46	94.3	33.36	112.2	42.97	130.7	49.99	131.7	52.51	133.1	52.66	137.4	52.81	141.1	53.31	
48	83.4	28.79	99.3	37.18	112.9	42.74	114.4	44.55	115.7	44.69	119.5	44.79	122.7	45.15	
90	10	95.2	11.42	113.7	13.72	132.2	16.17	141.1	17.43	150.1	18.77	168.6	21.00	187.0	23.35
	12	95.2	11.55	113.7	13.93	132.2	16.46	141.1	17.78	150.1	19.18	168.6	21.41	187.0	23.77
	14	95.2	11.76	113.7	14.21	132.2	16.80	141.1	18.14	150.1	19.53	168.6	21.83	187.0	24.25
	16	95.2	11.98	113.7	14.49	132.2	17.15	141.1	18.48	150.1	19.89	168.6	22.25	187.0	24.66
	18	95.2	12.18	113.7	14.78	132.2	17.43	141.1	18.91	150.1	20.31	168.6	22.73	187.0	25.91
	20	95.2	12.38	113.7	15.05	132.2	17.78	141.1	19.26	150.1	21.08	168.6	24.33	187.0	27.14
	21	95.2	12.53	113.7	15.19	132.2	18.14	141.1	19.89	150.1	21.84	168.6	24.73	187.0	27.77
	23	95.2	12.81	113.7	15.82	132.2	19.40	141.1	21.34	150.1	23.39	168.6	26.22	184.4	29.08
	25	95.2	13.44	113.7	16.86	132.2	20.72	141.1	22.82	150.1	24.99	168.6	28.03	181.8	30.32
	27	95.2	14.35	113.7	17.99	132.2	22.12	141.1	24.36	150.1	26.74	168.6	29.80	179.2	31.74
	29	95.2	15.19	113.7	19.18	132.2	23.66	141.1	26.05	150.1	28.56	168.6	31.58	176.4	33.02
	31	95.2	16.17	113.7	20.45	132.2	25.20	141.1	27.73	150.1	30.46	168.6	33.15	173.8	34.29
	33	95.2	17.23	113.7	21.77	132.2	26.88	141.1	29.55	150.1	32.30	168.6	34.75	171.2	35.57
	35	95.2	18.28	113.7	23.11	132.2	28.56	141.1	31.50	150.1	34.25	165.6	36.74	168.5	37.59
	37	95.2	19.40	113.7	24.57	132.2	30.46	141.1	33.46	150.1	36.16	163.0	38.41	165.8	39.28
	39	95.2	20.53	113.7	26.14	132.2	32.24	141.1	35.61	150.1	38.03	160.3	40.50	163.1	40.99
	41	92.8	22.98	110.7	28.98	128.8	35.38	137.5	38.95	146.2	41.06	153.6	42.67	156.4	43.66
	43	90.5	24.80	108.0	31.31	125.6	38.65	134.1	41.95	142.6	44.02	147.3	45.70	149.9	46.26
46	84.9	27.92	101.2	35.66	117.6	44.04	125.7	47.56	129.7	48.90	134.4	50.16	137.0	50.24	
48	75.0	24.40	89.6	31.19	104.1	38.52	111.1	41.49	112.5	42.14	116.9	43.18	119.1	43.24	
80	10	84.6	9.61	100.8	11.55	117.0	13.55	125.4	14.62	133.8	15.69	150.1	17.90	166.3	19.42
	12	84.6	9.82	100.8	11.67	117.0	13.82	125.4	14.89	133.8	15.95	150.1	18.23	166.3	19.81
	14	84.6	9.95	100.8	11.94	117.0	14.01	125.4	15.15	133.8	16.22	150.1	18.56	166.3	20.19
	16	84.6	10.08	100.8	12.15	117.0	14.28	125.4	15.42	133.8	16.55	150.1	18.96	166.3	20.58
	18	84.6	10.29	100.8	12.36	117.0	14.55	125.4	15.69	133.8	16.88	150.1	19.29	166.3	21.03
	20	84.6	10.48	100.8	12.62	117.0	14.89	125.4	16.02	133.8	17.22	150.1	20.02	166.3	22.28
	21	84.6	10.54	100.8	12.75	117.0	15.02	125.4	16.22	133.8	17.63	150.1	20.66	166.3	22.87
	23	84.6	10.75	100.8	12.95	117.0	15.69	125.4	17.22	133.8	18.82	150.1	21.82	166.3	24.00
	25	84.6	11.15	100.8	13.82	117.0	16.82	125.4	18.43	133.8	20.17	150.1	23.34	166.3	25.66
	27	84.6	11.81	100.8	14.68	117.0	17.96	125.4	19.69	133.8	21.49	150.1	24.80	166.3	27.00
	29	84.6	12.55	100.8	15.69	117.0	19.09	125.4	20.97	133.8	22.96	150.1	26.57	166.3	28.91
	31	84.6	13.35	100.8	16.62	117.0	20.36	125.4	22.36	133.8	24.44	150.1	28.20	166.3	30.34
	33	84.6	14.15	100.8	17.76	117.0	21.69	125.4	23.83	133.8	26.04	150.1	29.71	166.3	31.82
	35	84.6	15.02	100.8	18.82	117.0	23.10	125.4	25.37	133.8	27.77	150.1	31.51	164.6	32.97
	37	84.6	15.89	100.8	20.02	117.0	24.50	125.4	26.97	133.8	29.51	150.1	33.25	161.9	34.47
	39	84.6	16.79	100.8	21.16	117.0	26.20	125.4	28.99	133.8	31.71	150.1	35.13	159.2	36.36
	41	82.5	18.57	98.2	23.45	114.0	28.76	122.2	31.78	130.3	34.84	146.2	39.10	152.5	40.29
	43	80.3	20.45	95.8	25.58	111.2	31.40	119.1	34.64	127.3	38.08	142.6	41.84	146.2	43.15
46	75.3	22.75	89.8	28.82	104.2	35.37	111.7	38.55	119.1	42.96	130.4	45.66	133.5	46.40	
48	66.6	19.88	79.4	25.20	92.2	30.93	98.9	33.67	105.5	37.61	113.3	39.53	116.1	39.95	

Note

1. TC: Total Capacity(kW), PI : Power Input(kW, Comp. + Outdoor fan motor)
2. Capacity tables show the average value of conditions which may occur.

7. Capacity Tables

Combination (%)	Outdoor air temp (°C DB)	Cooling Capacity(56HP)													
		Indoor air temp. (DB/WB, °C)													
		20		23		26		27		28		30		32	
		14	16	18	19	20	22	24							
	TC	PI	TC	PI	TC	PI	TC	PI	TC	PI	TC	PI	TC	PI	
70	10	73.9	8.49	88.5	10.10	102.5	11.70	109.8	12.64	117.0	13.50	131.0	15.38	145.6	17.19
	12	73.9	8.62	88.5	10.23	102.5	11.95	109.8	12.83	117.0	13.77	131.0	15.64	145.6	17.52
	14	73.9	8.76	88.5	10.36	102.5	12.17	109.8	13.04	117.0	13.97	131.0	15.98	145.6	17.83
	16	73.9	8.88	88.5	10.56	102.5	12.37	109.8	13.31	117.0	14.23	131.0	16.25	145.6	18.22
	18	73.9	9.02	88.5	10.76	102.5	12.64	109.8	13.56	117.0	14.50	131.0	16.50	145.6	18.55
	20	73.9	9.15	88.5	10.96	102.5	12.83	109.8	13.83	117.0	14.84	131.0	16.91	145.6	19.25
	21	73.9	9.28	88.5	11.03	102.5	12.97	109.8	13.97	117.0	14.98	131.0	17.17	145.6	19.66
	23	73.9	9.43	88.5	11.29	102.5	13.23	109.8	14.43	117.0	15.71	131.0	18.38	145.6	20.76
	25	73.9	9.56	88.5	11.70	102.5	14.10	109.8	15.44	117.0	16.77	131.0	19.65	145.6	21.76
	27	73.9	10.10	88.5	12.50	102.5	15.04	109.8	16.37	117.0	17.92	131.0	20.99	145.6	23.13
	29	73.9	10.76	88.5	13.23	102.5	15.98	109.8	17.45	117.0	19.05	131.0	22.38	145.6	24.78
	31	73.9	11.43	88.5	14.10	102.5	17.04	109.8	18.65	117.0	20.32	131.0	23.86	145.6	26.29
	33	73.9	12.10	88.5	14.90	102.5	18.11	109.8	19.78	117.0	21.59	131.0	25.40	145.6	27.99
	35	73.9	12.77	88.5	15.91	102.5	19.25	109.8	21.05	117.0	22.99	131.0	27.07	145.6	29.68
	37	73.9	13.56	88.5	16.86	102.5	20.45	109.8	22.38	117.0	24.46	131.0	28.81	145.6	31.32
	39	73.9	14.42	88.5	17.96	102.5	21.87	109.8	24.09	117.0	26.43	131.0	30.83	145.6	33.77
	41	72.0	15.94	86.2	19.67	99.9	23.99	107.0	26.43	114.0	28.72	127.7	33.86	141.9	36.43
	43	70.3	17.33	84.0	21.45	97.4	26.18	104.3	28.81	111.2	31.37	124.5	36.99	138.3	39.38
46	65.9	19.27	78.8	24.12	91.3	29.48	97.7	32.09	104.2	35.36	116.7	41.72	129.7	43.90	
48	58.2	16.81	69.7	21.07	80.8	25.77	86.4	28.04	92.2	30.93	103.2	36.51	114.8	37.99	
60	10	63.3	7.36	75.6	8.63	87.9	10.04	94.1	10.77	100.2	11.44	112.6	12.98	124.9	14.51
	12	63.3	7.50	75.6	8.76	87.9	10.17	94.1	10.91	100.2	11.64	112.6	13.18	124.9	14.79
	14	63.3	7.56	75.6	8.90	87.9	10.37	94.1	11.10	100.2	11.84	112.6	13.45	124.9	15.06
	16	63.3	7.69	75.6	9.10	87.9	10.51	94.1	11.31	100.2	12.12	112.6	13.71	124.9	15.32
	18	63.3	7.83	75.6	9.23	87.9	10.70	94.1	11.50	100.2	12.32	112.6	13.92	124.9	15.66
	20	63.3	7.96	75.6	9.38	87.9	10.91	94.1	11.71	100.2	12.52	112.6	14.18	124.9	15.99
	21	63.3	8.03	75.6	9.44	87.9	11.04	94.1	11.84	100.2	12.65	112.6	14.38	124.9	16.13
	23	63.3	8.17	75.6	9.64	87.9	11.18	94.1	12.05	100.2	12.92	112.6	14.92	124.9	17.12
	25	63.3	8.30	75.6	9.84	87.9	11.64	94.1	12.65	100.2	13.71	112.6	15.93	124.9	18.33
	27	63.3	8.57	75.6	10.37	87.9	12.39	94.1	13.45	100.2	14.59	112.6	16.93	124.9	19.54
	29	63.3	9.10	75.6	11.04	87.9	13.18	94.1	14.32	100.2	15.53	112.6	18.07	124.9	20.88
	31	63.3	9.64	75.6	11.71	87.9	13.98	94.1	15.26	100.2	16.53	112.6	19.27	124.9	22.22
	33	63.3	10.17	75.6	12.39	87.9	14.86	94.1	16.20	100.2	17.60	112.6	20.48	124.9	23.69
	35	63.3	10.77	75.6	13.18	87.9	15.80	94.1	17.19	100.2	18.67	112.6	21.82	124.9	25.15
	37	63.3	11.37	75.6	13.91	87.9	16.72	94.1	18.27	100.2	19.80	112.6	23.15	124.9	26.77
	39	63.3	12.09	75.6	14.81	87.9	18.05	94.1	19.59	100.2	21.32	112.6	24.83	124.9	28.69
	41	61.6	13.12	73.7	16.22	85.7	19.61	91.7	21.41	97.6	23.13	109.7	27.25	121.7	31.17
	43	60.1	14.26	71.9	17.65	83.6	21.38	89.4	23.33	95.2	25.24	107.0	29.74	118.6	34.04
46	56.4	15.97	67.3	19.82	78.4	24.04	83.8	26.23	89.2	28.39	100.2	33.51	111.1	38.79	
48	49.8	13.92	59.6	17.29	69.3	21.01	74.1	22.90	79.0	24.81	88.7	29.31	98.4	33.94	
50	10	52.9	6.36	63.3	7.37	73.4	8.38	78.4	8.97	83.4	9.52	93.5	10.72	104.2	11.92
	12	52.9	6.42	63.3	7.44	73.4	8.51	78.4	9.10	83.4	9.72	93.5	10.92	104.2	12.13
	14	52.9	6.50	63.3	7.57	73.4	8.64	78.4	9.24	83.4	9.85	93.5	11.06	104.2	12.34
	16	52.9	6.63	63.3	7.70	73.4	8.78	78.4	9.45	83.4	9.98	93.5	11.25	104.2	12.53
	18	52.9	6.70	63.3	7.77	73.4	8.91	78.4	9.58	83.4	10.19	93.5	11.46	104.2	12.80
	20	52.9	6.77	63.3	7.91	73.4	9.10	78.4	9.72	83.4	10.38	93.5	11.65	104.2	13.06
	21	52.9	6.84	63.3	7.97	73.4	9.18	78.4	9.85	83.4	10.45	93.5	11.78	104.2	13.19
	23	52.9	6.98	63.3	8.11	73.4	9.32	78.4	9.98	83.4	10.65	93.5	12.00	104.2	13.46
	25	52.9	7.04	63.3	8.24	73.4	9.52	78.4	10.19	83.4	10.99	93.5	12.60	104.2	14.40
	27	52.9	7.17	63.3	8.51	73.4	10.05	78.4	10.85	83.4	11.65	93.5	13.46	104.2	15.34
	29	52.9	7.57	63.3	9.04	73.4	10.65	78.4	11.52	83.4	12.40	93.5	14.27	104.2	16.28
	31	52.9	7.97	63.3	9.58	73.4	11.32	78.4	12.20	83.4	13.19	93.5	15.21	104.2	17.36
	33	52.9	8.44	63.3	10.12	73.4	12.00	78.4	12.93	83.4	14.00	93.5	16.14	104.2	18.49
	35	52.9	8.91	63.3	10.72	73.4	12.66	78.4	13.74	83.4	14.81	93.5	17.08	104.2	19.63
	37	52.9	9.45	63.3	11.32	73.4	13.40	78.4	14.53	83.4	15.68	93.5	18.23	104.2	20.84
	39	52.9	10.08	63.3	12.14	73.4	14.36	78.4	15.65	83.4	16.83	93.5	19.42	104.2	22.50
	41	51.5	10.89	61.6	13.14	71.5	15.70	76.5	16.95	81.2	18.23	91.1	21.27	101.4	24.44
	43	50.3	11.85	60.1	14.29	69.7	17.08	74.5	18.46	79.3	19.85	88.9	23.20	99.0	26.66
46	47.1	13.27	56.4	16.04	65.3	19.16	69.8	20.72	74.3	22.27	83.3	26.10	92.8	30.01	
48	41.7	11.55	49.8	13.98	57.8	16.71	61.8	18.09	65.7	19.44	73.7	22.81	82.1	26.23	

Note

1. TC: Total Capacity(kW), PI : Power Input(kW, Comp. + Outdoor fan motor)
2. Capacity tables show the average value of conditions which may occur.

7. Capacity Tables

◆ A(C)RUN580LLS5

Combination (%)	Outdoor air temp (°C DB)	Indoor air temp. (DB/WB, °C)														Cooling Capacity(58HP)	
		20		23		26		27		28		30		32		TC	PI
		14		16		18		19		20		22		24			
		TC	PI	TC	PI	TC	PI	TC	PI	TC	PI	TC	PI	TC	PI		
130	10	160.9	18.58	191.6	22.70	205.3	26.34	211.2	26.87	217.1	27.10	227.6	27.31	233.4	27.42		
	12	160.9	19.04	191.6	23.52	205.3	27.42	211.2	27.61	217.1	27.82	227.6	28.05	233.4	28.30		
	14	160.9	19.68	191.6	24.37	205.3	28.45	211.2	28.66	217.1	28.89	227.6	29.12	233.4	29.38		
	16	160.9	20.40	191.6	25.22	205.3	29.73	211.2	30.01	217.1	30.25	227.6	30.51	233.4	30.76		
	18	160.9	21.25	191.6	26.68	205.3	31.10	211.2	31.77	217.1	32.03	227.6	32.34	233.4	32.56		
	20	160.9	22.19	191.6	28.43	205.3	32.63	211.2	34.94	217.1	35.23	224.2	35.57	230.2	35.82		
	21	160.9	22.77	191.6	29.42	205.3	33.31	211.2	36.97	217.1	37.27	223.0	37.65	228.9	37.90		
	23	160.9	24.44	191.6	30.95	205.3	35.04	211.2	40.81	214.3	41.13	219.8	41.54	225.6	41.82		
	25	160.9	26.09	191.6	32.73	205.3	37.45	208.7	45.26	211.2	45.61	217.1	46.07	223.0	46.39		
	27	160.9	27.92	191.6	34.99	202.7	39.91	205.3	49.82	208.7	50.22	214.3	50.71	219.8	51.07		
	29	160.9	29.76	191.6	37.40	199.5	42.93	202.4	54.76	205.3	55.08	211.2	55.57	217.1	55.79		
	31	160.9	31.75	190.9	39.40	196.1	45.67	199.5	54.52	202.4	54.86	207.9	55.33	213.7	55.55		
	33	160.9	33.82	187.6	41.75	193.5	48.98	196.7	54.02	199.5	54.35	205.3	54.83	210.5	55.05		
	35	160.9	36.07	184.3	43.71	190.5	53.05	193.5	53.31	196.7	53.64	202.1	54.12	207.9	54.33		
	37	160.9	38.47	181.8	45.88	187.6	52.35	190.3	52.62	193.5	52.94	198.7	53.40	204.7	53.61		
	39	160.9	40.96	178.5	48.29	184.3	51.66	187.6	51.91	190.3	52.22	196.1	52.69	202.1	52.90		
	41	156.7	43.45	171.1	50.70	176.9	50.95	179.5	51.20	183.1	51.51	188.5	51.97	193.7	52.18		
	43	152.8	45.82	163.9	49.99	169.7	50.25	172.2	50.50	175.8	50.80	181.1	51.26	186.0	51.47		
46	143.2	49.05	149.6	48.96	155.1	49.20	157.5	49.45	160.7	49.74	165.8	50.19	170.3	50.39			
48	126.7	47.68	129.9	47.83	134.8	47.93	136.9	48.06	139.8	48.47	144.4	48.78	148.3	48.98			
120	10	145.5	16.72	173.1	20.49	189.1	24.36	194.9	26.32	200.6	26.74	211.6	26.84	216.6	27.06		
	12	145.5	17.17	173.1	21.19	189.1	25.34	194.9	26.87	200.6	27.73	211.6	28.06	216.6	28.29		
	14	145.5	17.76	173.1	21.90	189.1	26.37	194.9	27.90	200.6	28.74	211.6	29.17	216.6	29.39		
	16	145.5	18.40	173.1	22.80	189.1	27.37	194.9	28.94	200.6	30.07	211.6	30.45	216.6	30.68		
	18	145.5	19.11	173.1	23.83	189.1	28.48	194.9	30.47	200.6	31.61	211.6	31.97	216.6	32.24		
	20	145.5	19.84	173.1	25.26	189.1	30.01	194.9	32.05	200.6	33.29	211.6	33.73	216.6	33.99		
	21	145.5	20.44	173.1	26.18	189.1	30.85	194.9	33.00	200.6	34.39	211.6	34.83	216.6	35.10		
	23	145.5	21.86	173.1	28.01	189.1	33.05	194.9	35.07	200.6	36.66	211.6	37.02	216.6	37.32		
	25	145.5	23.36	173.1	30.01	189.1	34.85	194.9	37.38	200.6	39.31	209.0	39.63	214.1	39.95		
	27	145.5	24.94	173.1	32.08	189.1	37.10	194.9	39.95	200.6	42.24	205.9	42.53	210.9	42.87		
	29	145.5	26.59	173.1	34.24	189.1	39.04	194.9	42.74	197.4	45.02	202.6	45.70	208.3	46.07		
	31	145.5	28.34	173.1	36.57	189.1	41.06	192.3	45.78	194.9	48.30	200.1	49.15	205.0	49.55		
	33	145.5	30.17	173.1	38.98	186.5	43.42	189.1	49.70	191.7	51.86	196.8	52.45	201.9	52.87		
	35	145.5	32.08	173.1	41.55	183.3	45.97	185.9	54.76	189.1	55.02	194.3	55.19	199.3	55.63		
	37	145.5	34.51	173.1	43.85	180.7	49.01	183.3	53.59	185.9	53.87	191.0	54.03	196.3	54.46		
	39	145.5	37.15	172.5	46.35	177.5	51.97	180.2	52.50	182.7	52.76	188.5	52.92	193.7	53.34		
	41	141.8	39.80	164.9	48.83	170.5	50.95	172.9	51.40	175.4	51.66	180.4	51.81	185.6	52.22		
	43	138.3	42.47	158.0	48.14	163.5	49.82	165.8	50.29	168.2	50.54	173.2	50.70	178.3	51.10		
46	129.6	45.67	144.1	47.00	149.3	48.24	151.4	48.64	153.8	48.89	158.4	49.03	163.2	49.42			
48	114.6	44.73	125.1	46.16	129.7	47.31	131.8	47.59	133.8	47.74	137.8	47.93	142.1	48.13			
110	10	130.4	15.04	155.5	18.32	173.6	21.77	178.7	23.57	189.9	25.35	194.3	26.07	207.4	26.49		
	12	130.4	15.50	155.5	18.95	173.6	22.68	178.7	24.22	189.9	26.31	194.3	27.16	207.4	27.78		
	14	130.4	15.99	155.5	19.79	173.6	23.70	178.7	25.42	189.9	27.64	194.3	28.42	207.4	29.02		
	16	130.4	16.55	155.5	20.52	173.6	24.67	178.7	26.53	189.9	28.91	194.3	29.69	207.4	30.22		
	18	130.4	17.17	155.5	21.37	173.6	26.09	178.7	27.95	189.9	30.50	194.3	31.10	207.4	31.68		
	20	130.4	17.77	155.5	22.44	173.6	27.67	178.7	29.23	189.9	31.97	194.3	32.77	207.4	33.29		
	21	130.4	18.17	155.5	23.10	173.6	28.39	178.7	30.01	189.9	32.87	194.3	33.70	207.4	34.22		
	23	130.4	19.36	155.5	24.76	173.6	29.97	178.7	31.69	189.9	34.73	194.3	35.47	207.4	36.06		
	25	130.4	20.70	155.5	26.43	173.6	31.66	178.7	33.50	189.9	36.68	194.3	37.21	205.0	37.97		
	27	130.4	22.11	155.5	28.26	173.6	33.46	178.7	35.45	189.9	38.30	194.3	39.19	201.9	39.86		
	29	130.4	23.61	155.5	30.17	173.6	35.35	178.7	37.55	189.9	40.49	194.3	41.19	199.3	41.81		
	31	130.4	25.10	155.5	32.16	173.6	37.36	178.7	39.78	186.8	42.54	191.8	43.37	196.3	43.83		
	33	130.4	26.77	155.5	34.24	173.6	39.48	178.7	42.16	184.2	44.92	188.7	45.67	193.7	45.92		
	35	130.4	28.43	155.5	36.57	173.6	41.69	178.7	44.67	181.2	47.41	185.6	47.84	190.5	48.09		
	37	130.4	30.13	155.5	38.81	173.6	44.01	176.1	47.32	178.0	50.01	183.1	50.18	187.4	50.33		
	39	130.4	32.48	155.5	41.25	170.5	46.44	172.9	50.62	175.5	52.48	179.8	52.57	185.0	52.62		
	41	127.1	34.83	151.4	43.67	163.3	48.98	165.8	54.76	167.9	54.76	172.9	55.19	177.1	55.63		
	43	123.8	36.57	147.7	45.51	156.4	51.93	159.0	52.52	161.0	52.41	165.8	52.71	170.0	52.85		
46	116.1	35.69	138.4	43.93	142.7	49.29	145.2	49.29	147.0	49.71	151.6	49.99	155.5	50.12			
48	102.7	34.66	120.3	42.32	123.9	46.90	126.2	47.21	127.9	47.44	131.9	47.57	135.3	47.75			

Note

1. TC: Total Capacity(kW), PI : Power Input(kW, Comp. + Outdoor fan motor)
2. Capacity tables show the average value of conditions which may occur.

7. Capacity Tables

Combination (%)	Outdoor air temp (°C DB)	Cooling Capacity(58HP)													
		Indoor air temp. (DB/WB, °C)													
		20		23		26		27		28		30		32	
		14	16	18	19	20	22	24							
	TC	PI	TC	PI	TC	PI	TC	PI	TC	PI	TC	PI	TC	PI	
100	10	109.6	13.54	130.5	16.45	151.9	19.52	162.4	21.10	172.9	22.67	191.6	25.23	195.8	25.44
	12	109.6	13.98	130.5	17.12	151.9	20.18	162.4	21.66	172.9	23.39	191.6	26.59	195.8	26.85
	14	109.6	14.41	130.5	17.81	151.9	21.03	162.4	22.60	172.9	24.40	191.6	28.07	195.8	28.34
	16	109.6	14.85	130.5	18.40	151.9	21.93	162.4	23.67	172.9	25.71	191.6	29.43	195.8	29.84
	18	109.6	15.29	130.5	19.08	151.9	22.78	162.4	24.82	172.9	27.27	191.6	31.10	195.8	31.34
	20	109.6	15.84	130.5	19.81	151.9	24.11	162.4	26.59	172.9	29.17	191.6	32.58	195.8	32.84
	21	109.6	16.16	130.5	20.28	151.9	24.94	162.4	27.51	172.9	30.26	191.6	33.33	195.8	33.59
	23	109.6	17.12	130.5	21.69	151.9	26.77	162.4	29.51	172.9	32.41	191.6	34.89	195.8	35.18
	25	109.6	18.20	130.5	23.10	151.9	28.59	162.4	31.59	172.9	34.66	191.6	36.38	194.2	36.68
	27	109.6	19.45	130.5	24.69	151.9	30.58	162.4	33.74	172.9	36.85	187.9	38.09	191.9	38.40
	29	109.6	20.70	130.5	26.34	151.9	32.66	162.4	36.07	172.9	38.99	184.5	39.63	189.0	39.95
	31	109.6	22.11	130.5	28.09	151.9	34.83	162.4	38.48	172.9	40.98	181.6	41.16	186.1	41.50
	33	109.6	23.43	130.5	29.92	151.9	37.15	162.4	41.06	172.9	42.52	178.7	42.71	183.2	43.05
	35	109.6	24.94	130.5	31.84	151.9	39.57	162.4	43.80	170.2	44.05	175.5	44.24	179.9	44.58
	37	109.6	26.71	130.5	34.14	151.9	41.91	162.4	45.88	167.3	46.11	172.2	46.30	176.3	46.72
	39	109.6	28.64	130.5	36.68	151.9	44.41	162.4	48.13	164.7	48.34	169.5	48.52	173.4	48.98
	41	107.9	30.56	128.5	39.21	149.5	46.91	155.8	50.38	159.2	50.58	163.0	50.75	168.2	51.23
	43	104.2	32.34	124.1	41.57	144.4	49.15	149.4	52.31	151.1	52.48	155.7	52.66	159.9	53.15
46	97.7	34.79	116.2	44.82	135.4	52.13	136.4	54.76	137.8	54.92	142.3	55.07	146.1	55.60	
48	86.4	30.03	102.9	38.77	116.9	44.57	118.5	46.45	119.8	46.60	123.8	46.71	127.1	47.09	
90	10	98.6	11.80	117.8	14.18	136.9	16.72	146.1	18.02	155.5	19.40	174.6	21.71	193.7	24.14
	12	98.6	11.94	117.8	14.40	136.9	17.01	146.1	18.38	155.5	19.82	174.6	22.14	193.7	24.57
	14	98.6	12.16	117.8	14.69	136.9	17.37	146.1	18.75	155.5	20.19	174.6	22.57	193.7	25.07
	16	98.6	12.38	117.8	14.98	136.9	17.73	146.1	19.11	155.5	20.56	174.6	23.00	193.7	25.49
	18	98.6	12.59	117.8	15.27	136.9	18.02	146.1	19.55	155.5	20.99	174.6	23.50	193.7	26.78
	20	98.6	12.80	117.8	15.56	136.9	18.38	146.1	19.91	155.5	21.79	174.6	25.15	193.7	28.06
	21	98.6	12.95	117.8	15.71	136.9	18.75	146.1	20.56	155.5	22.58	174.6	25.56	193.7	28.71
	23	98.6	13.24	117.8	16.36	136.9	20.05	146.1	22.06	155.5	24.18	174.6	27.11	191.0	30.06
	25	98.6	13.90	117.8	17.43	136.9	21.42	146.1	23.59	155.5	25.83	174.6	28.98	188.3	31.34
	27	98.6	14.83	117.8	18.60	136.9	22.86	146.1	25.18	155.5	27.64	174.6	30.81	185.6	32.81
	29	98.6	15.71	117.8	19.82	136.9	24.45	146.1	26.93	155.5	29.53	174.6	32.64	182.7	34.13
	31	98.6	16.72	117.8	21.14	136.9	26.05	146.1	28.66	155.5	31.49	174.6	34.26	180.0	35.45
	33	98.6	17.81	117.8	22.51	136.9	27.79	146.1	30.55	155.5	33.39	174.6	35.93	177.3	36.77
	35	98.6	18.90	117.8	23.89	136.9	29.53	146.1	32.56	155.5	35.41	171.6	37.98	174.5	38.86
	37	98.6	20.05	117.8	25.40	136.9	31.49	146.1	34.59	155.5	37.38	168.8	39.71	171.7	40.60
	39	98.6	21.22	117.8	27.02	136.9	33.33	146.1	36.82	155.5	39.31	166.1	41.86	169.0	42.37
	41	96.1	23.75	114.7	29.96	133.4	36.58	142.4	40.26	151.4	42.44	159.1	44.11	161.9	45.13
	43	93.7	25.64	111.9	32.37	130.1	39.95	138.9	43.36	147.7	45.50	152.6	47.24	155.3	47.82
46	87.9	28.86	104.9	36.86	121.8	45.53	130.2	49.17	134.3	50.55	139.2	51.86	141.9	51.93	
48	77.7	25.22	92.8	32.24	107.8	39.82	115.1	42.89	116.5	43.56	121.0	44.64	123.3	44.70	
80	10	87.6	9.96	104.4	11.97	121.2	14.04	129.9	15.16	138.6	16.26	155.5	18.55	172.2	20.13
	12	87.6	10.17	104.4	12.10	121.2	14.32	129.9	15.43	138.6	16.53	155.5	18.89	172.2	20.53
	14	87.6	10.31	104.4	12.38	121.2	14.52	129.9	15.70	138.6	16.81	155.5	19.23	172.2	20.92
	16	87.6	10.44	104.4	12.59	121.2	14.80	129.9	15.98	138.6	17.15	155.5	19.65	172.2	21.33
	18	87.6	10.66	104.4	12.81	121.2	15.08	129.9	16.26	138.6	17.50	155.5	19.99	172.2	21.79
	20	87.6	10.86	104.4	13.08	121.2	15.43	129.9	16.60	138.6	17.85	155.5	20.75	172.2	23.09
	21	87.6	10.92	104.4	13.21	121.2	15.56	129.9	16.81	138.6	18.27	155.5	21.41	172.2	23.70
	23	87.6	11.14	104.4	13.42	121.2	16.26	129.9	17.85	138.6	19.50	155.5	22.61	172.2	24.87
	25	87.6	11.56	104.4	14.32	121.2	17.43	129.9	19.10	138.6	20.90	155.5	24.19	172.2	26.60
	27	87.6	12.24	104.4	15.22	121.2	18.61	129.9	20.41	138.6	22.27	155.5	25.71	172.2	27.98
	29	87.6	13.00	104.4	16.26	121.2	19.79	129.9	21.73	138.6	23.79	155.5	27.54	172.2	29.96
	31	87.6	13.84	104.4	17.23	121.2	21.10	129.9	23.18	138.6	25.33	155.5	29.23	172.2	31.45
	33	87.6	14.67	104.4	18.40	121.2	22.48	129.9	24.70	138.6	26.98	155.5	30.79	172.2	32.98
	35	87.6	15.56	104.4	19.50	121.2	23.94	129.9	26.30	138.6	28.78	155.5	32.65	170.5	34.17
	37	87.6	16.47	104.4	20.75	121.2	25.39	129.9	27.95	138.6	30.58	155.5	34.46	167.7	35.72
	39	87.6	17.40	104.4	21.93	121.2	27.15	129.9	30.05	138.6	32.86	155.5	36.40	164.9	37.68
	41	85.4	19.25	101.7	24.31	118.0	29.81	126.6	32.94	135.0	36.11	151.4	40.52	158.0	41.76
	43	83.2	21.20	99.2	26.51	115.1	32.55	123.4	35.90	131.8	39.46	147.7	43.36	151.4	44.71
46	78.0	23.58	93.0	29.87	107.9	36.66	115.7	39.96	123.4	44.52	135.1	47.32	138.3	48.09	
48	69.0	20.60	82.3	26.12	95.5	32.06	102.4	34.90	109.3	38.98	117.4	40.97	120.2	41.40	

Note

1. TC: Total Capacity(kW), PI : Power Input(kW, Comp. + Outdoor fan motor)
2. Capacity tables show the average value of conditions which may occur.

7. Capacity Tables

Combination (%)	Outdoor air temp (°C DB)	Cooling Capacity(58HP)													
		Indoor air temp. (DB/WB, °C)													
		20		23		26		27		28		30		32	
		14	16	18	19	20	22	24							
	TC	PI	TC	PI	TC	PI	TC	PI	TC	PI	TC	PI	TC	PI	
70	10	76.5	8.82	91.7	10.49	106.2	12.16	113.7	13.13	121.2	14.03	135.7	15.98	150.8	17.86
	12	76.5	8.96	91.7	10.63	106.2	12.42	113.7	13.33	121.2	14.31	135.7	16.25	150.8	18.20
	14	76.5	9.10	91.7	10.76	106.2	12.64	113.7	13.55	121.2	14.52	135.7	16.60	150.8	18.53
	16	76.5	9.23	91.7	10.97	106.2	12.85	113.7	13.83	121.2	14.79	135.7	16.88	150.8	18.93
	18	76.5	9.38	91.7	11.18	106.2	13.13	113.7	14.09	121.2	15.07	135.7	17.15	150.8	19.27
	20	76.5	9.51	91.7	11.39	106.2	13.33	113.7	14.37	121.2	15.41	135.7	17.57	150.8	20.00
	21	76.5	9.65	91.7	11.46	106.2	13.47	113.7	14.52	121.2	15.56	135.7	17.84	150.8	20.42
	23	76.5	9.79	91.7	11.73	106.2	13.75	113.7	15.00	121.2	16.32	135.7	19.10	150.8	21.57
	25	76.5	9.93	91.7	12.16	106.2	14.65	113.7	16.04	121.2	17.43	135.7	20.42	150.8	22.61
	27	76.5	10.49	91.7	12.98	106.2	15.62	113.7	17.01	121.2	18.62	135.7	21.81	150.8	24.03
	29	76.5	11.18	91.7	13.75	106.2	16.60	113.7	18.13	121.2	19.79	135.7	23.26	150.8	25.74
	31	76.5	11.88	91.7	14.65	106.2	17.71	113.7	19.38	121.2	21.11	135.7	24.79	150.8	27.31
	33	76.5	12.57	91.7	15.48	106.2	18.81	113.7	20.56	121.2	22.43	135.7	26.39	150.8	29.08
	35	76.5	13.27	91.7	16.53	106.2	20.00	113.7	21.87	121.2	23.88	135.7	28.13	150.8	30.84
	37	76.5	14.09	91.7	17.51	106.2	21.24	113.7	23.26	121.2	25.42	135.7	29.93	150.8	32.54
	39	76.5	14.98	91.7	18.66	106.2	22.72	113.7	25.03	121.2	27.46	135.7	32.03	150.8	35.09
	41	74.5	16.56	89.3	20.44	103.5	24.92	110.8	27.46	118.0	29.84	132.3	35.18	147.0	37.85
	43	72.8	18.01	87.0	22.29	100.9	27.20	108.1	29.93	115.1	32.60	129.0	38.43	143.2	40.92
46	68.2	20.02	81.6	25.06	94.6	30.63	101.2	33.34	107.9	36.74	120.9	43.35	134.3	45.61	
48	60.3	17.47	72.2	21.89	83.6	26.77	89.5	29.13	95.5	32.14	106.9	37.94	118.9	39.47	
60	10	65.6	7.66	78.3	8.99	91.0	10.46	97.5	11.22	103.8	11.92	116.6	13.52	129.4	15.12
	12	65.6	7.81	78.3	9.13	91.0	10.59	97.5	11.36	103.8	12.13	116.6	13.73	129.4	15.40
	14	65.6	7.87	78.3	9.27	91.0	10.80	97.5	11.56	103.8	12.34	116.6	14.01	129.4	15.68
	16	65.6	8.01	78.3	9.48	91.0	10.95	97.5	11.78	103.8	12.62	116.6	14.28	129.4	15.96
	18	65.6	8.16	78.3	9.62	91.0	11.15	97.5	11.98	103.8	12.83	116.6	14.50	129.4	16.31
	20	65.6	8.29	78.3	9.77	91.0	11.36	97.5	12.20	103.8	13.04	116.6	14.77	129.4	16.66
	21	65.6	8.36	78.3	9.83	91.0	11.50	97.5	12.34	103.8	13.17	116.6	14.98	129.4	16.80
	23	65.6	8.51	78.3	10.04	91.0	11.65	97.5	12.55	103.8	13.46	116.6	15.54	129.4	17.84
	25	65.6	8.65	78.3	10.25	91.0	12.13	97.5	13.17	103.8	14.28	116.6	16.59	129.4	19.09
	27	65.6	8.93	78.3	10.80	91.0	12.90	97.5	14.01	103.8	15.20	116.6	17.64	129.4	20.36
	29	65.6	9.48	78.3	11.50	91.0	13.73	97.5	14.92	103.8	16.17	116.6	18.82	129.4	21.75
	31	65.6	10.04	78.3	12.20	91.0	14.56	97.5	15.89	103.8	17.22	116.6	20.07	129.4	23.15
	33	65.6	10.59	78.3	12.90	91.0	15.47	97.5	16.87	103.8	18.33	116.6	21.33	129.4	24.67
	35	65.6	11.22	78.3	13.73	91.0	16.46	97.5	17.91	103.8	19.45	116.6	22.73	129.4	26.20
	37	65.6	11.85	78.3	14.49	91.0	17.42	97.5	19.03	103.8	20.63	116.6	24.11	129.4	27.88
	39	65.6	12.59	78.3	15.43	91.0	18.81	97.5	20.41	103.8	22.21	116.6	25.87	129.4	29.88
	41	63.8	13.67	76.3	16.89	88.8	20.43	94.9	22.30	101.1	24.10	113.6	28.38	126.1	32.47
	43	62.3	14.85	74.5	18.39	86.5	22.27	92.6	24.30	98.6	26.29	110.8	30.98	122.9	35.46
46	58.4	16.64	69.7	20.64	81.2	25.04	86.8	27.32	92.4	29.57	103.8	34.91	115.1	40.40	
48	51.6	14.50	61.8	18.01	71.7	21.88	76.8	23.86	81.8	25.84	91.9	30.53	101.9	35.35	
50	10	54.8	6.65	65.6	7.69	76.0	8.75	81.2	9.37	86.4	9.94	96.8	11.19	107.9	12.45
	12	54.8	6.71	65.6	7.77	76.0	8.89	81.2	9.51	86.4	10.15	96.8	11.40	107.9	12.66
	14	54.8	6.79	65.6	7.90	76.0	9.02	81.2	9.65	86.4	10.28	96.8	11.55	107.9	12.88
	16	54.8	6.93	65.6	8.04	76.0	9.17	81.2	9.86	86.4	10.42	96.8	11.75	107.9	13.08
	18	54.8	6.99	65.6	8.11	76.0	9.31	81.2	10.00	86.4	10.64	96.8	11.97	107.9	13.36
	20	54.8	7.06	65.6	8.26	76.0	9.51	81.2	10.15	86.4	10.84	96.8	12.17	107.9	13.64
	21	54.8	7.14	65.6	8.32	76.0	9.59	81.2	10.28	86.4	10.91	96.8	12.31	107.9	13.77
	23	54.8	7.28	65.6	8.47	76.0	9.73	81.2	10.42	86.4	11.12	96.8	12.53	107.9	14.06
	25	54.8	7.35	65.6	8.61	76.0	9.94	81.2	10.64	86.4	11.48	96.8	13.15	107.9	15.04
	27	54.8	7.48	65.6	8.89	76.0	10.49	81.2	11.33	86.4	12.17	96.8	14.06	107.9	16.02
	29	54.8	7.90	65.6	9.44	76.0	11.12	81.2	12.03	86.4	12.95	96.8	14.91	107.9	17.00
	31	54.8	8.32	65.6	10.00	76.0	11.82	81.2	12.74	86.4	13.77	96.8	15.88	107.9	18.12
	33	54.8	8.82	65.6	10.57	76.0	12.53	81.2	13.50	86.4	14.62	96.8	16.86	107.9	19.31
	35	54.8	9.31	65.6	11.19	76.0	13.22	81.2	14.35	86.4	15.46	96.8	17.84	107.9	20.50
	37	54.8	9.86	65.6	11.82	76.0	13.99	81.2	15.18	86.4	16.37	96.8	19.03	107.9	21.76
	39	54.8	10.52	65.6	12.68	76.0	15.00	81.2	16.34	86.4	17.57	96.8	20.28	107.9	23.50
	41	53.3	11.38	63.8	13.72	74.0	16.39	79.2	17.70	84.1	19.04	94.3	22.21	105.0	25.52
	43	52.1	12.37	62.3	14.92	72.2	17.84	77.2	19.28	82.1	20.73	92.0	24.23	102.6	27.84
46	48.8	13.86	58.4	16.74	67.6	20.01	72.3	21.64	76.9	23.26	86.2	27.26	96.1	31.34	
48	43.2	12.07	51.6	14.59	59.8	17.45	64.0	18.89	68.1	20.30	76.3	23.82	85.0	27.39	

Note

1. TC: Total Capacity(kW), PI : Power Input(kW, Comp. + Outdoor fan motor)
2. Capacity tables show the average value of conditions which may occur.

7. Capacity Tables

◆ A(C)RUN600LLS5

Combination (%)	Outdoor air temp (°C DB)	Indoor air temp. (DB/WB, °C)														Cooling Capacity(60HP)	
		20		23		26		27		28		30		32		TC	PI
		14		16		18		19		20		22		24			
		TC	PI	TC	PI	TC	PI	TC	PI	TC	PI	TC	PI	TC	PI		
130	10	166.4	19.73	198.2	24.10	212.4	27.96	218.5	28.53	224.5	28.77	235.4	28.99	241.4	29.11		
	12	166.4	20.21	198.2	24.97	212.4	29.11	218.5	29.31	224.5	29.53	235.4	29.78	241.4	30.04		
	14	166.4	20.90	198.2	25.87	212.4	30.20	218.5	30.42	224.5	30.67	235.4	30.92	241.4	31.19		
	16	166.4	21.65	198.2	26.77	212.4	31.56	218.5	31.86	224.5	32.11	235.4	32.40	241.4	32.66		
	18	166.4	22.56	198.2	28.32	212.4	33.02	218.5	33.72	224.5	34.00	235.4	34.33	241.4	34.57		
	20	166.4	23.56	198.2	30.18	212.4	34.65	218.5	37.09	224.5	37.40	232.0	37.76	238.1	38.03		
	21	166.4	24.17	198.2	31.24	212.4	35.37	218.5	39.25	224.5	39.57	230.7	39.97	236.8	40.24		
	23	166.4	25.94	198.2	32.86	212.4	37.20	218.5	43.32	221.7	43.67	227.3	44.10	233.4	44.40		
	25	166.4	27.70	198.2	34.74	212.4	39.75	215.9	48.05	218.5	48.43	224.5	48.91	230.7	49.25		
	27	166.4	29.64	198.2	37.15	209.7	42.36	212.4	52.89	215.9	53.31	221.7	53.83	227.3	54.22		
	29	166.4	31.59	198.2	39.71	206.3	45.58	209.3	58.13	212.4	58.48	218.5	59.00	224.5	59.23		
	31	166.4	33.71	197.5	41.83	202.9	48.49	206.3	57.88	209.3	58.24	215.1	58.75	221.1	58.98		
	33	166.4	35.90	194.1	44.32	200.2	52.00	203.5	57.35	206.3	57.70	212.4	58.21	217.7	58.44		
	35	166.4	38.30	190.6	46.41	196.9	56.32	200.2	56.60	203.5	56.94	209.0	57.46	215.1	57.68		
	37	166.4	40.84	188.0	48.71	194.1	55.58	196.9	55.86	200.2	56.20	205.6	56.69	211.7	56.91		
	39	166.4	43.48	184.6	51.26	190.6	54.84	194.1	55.11	196.9	55.44	202.9	55.94	209.0	56.16		
	41	162.2	46.13	177.0	53.83	183.0	54.09	185.7	54.36	189.4	54.69	195.0	55.18	200.4	55.39		
	43	158.1	48.65	169.6	53.08	175.6	53.34	178.1	53.61	181.8	53.94	187.4	54.42	192.5	54.64		
46	148.1	52.07	154.7	51.98	160.4	52.23	162.9	52.50	166.3	52.81	171.5	53.28	176.2	53.50			
48	131.1	50.62	134.4	50.77	139.4	50.88	141.6	51.02	144.6	51.46	149.3	51.79	153.5	51.99			
120	10	150.5	17.75	179.0	21.75	195.6	25.86	201.6	27.95	207.5	28.39	218.8	28.50	224.1	28.73		
	12	150.5	18.22	179.0	22.50	195.6	26.90	201.6	28.53	207.5	29.43	218.8	29.79	224.1	30.03		
	14	150.5	18.85	179.0	23.25	195.6	27.99	201.6	29.62	207.5	30.51	218.8	30.97	224.1	31.21		
	16	150.5	19.54	179.0	24.21	195.6	29.06	201.6	30.72	207.5	31.92	218.8	32.33	224.1	32.57		
	18	150.5	20.29	179.0	25.30	195.6	30.23	201.6	32.34	207.5	33.56	218.8	33.94	224.1	34.22		
	20	150.5	21.06	179.0	26.82	195.6	31.86	201.6	34.03	207.5	35.34	218.8	35.81	224.1	36.09		
	21	150.5	21.70	179.0	27.79	195.6	32.75	201.6	35.04	207.5	36.51	218.8	36.98	224.1	37.26		
	23	150.5	23.20	179.0	29.73	195.6	35.09	201.6	37.23	207.5	38.92	218.8	39.30	224.1	39.62		
	25	150.5	24.80	179.0	31.86	195.6	37.00	201.6	39.69	207.5	41.74	216.2	42.07	221.5	42.42		
	27	150.5	26.47	179.0	34.06	195.6	39.39	201.6	42.41	207.5	44.84	213.0	45.15	218.2	45.51		
	29	150.5	28.23	179.0	36.35	195.6	41.44	201.6	45.37	204.2	47.80	209.5	48.52	215.5	48.91		
	31	150.5	30.09	179.0	38.83	195.6	43.59	199.0	48.60	201.6	51.28	207.0	52.18	212.1	52.60		
	33	150.5	32.03	179.0	41.38	193.0	46.10	195.6	52.76	198.3	55.06	203.6	55.69	208.9	56.13		
	35	150.5	34.06	179.0	44.11	189.7	48.80	192.3	58.13	195.6	58.42	201.0	58.59	206.2	59.06		
	37	150.5	36.64	179.0	46.55	187.0	52.03	189.7	56.90	192.3	57.19	197.6	57.36	203.0	57.82		
	39	150.5	39.44	178.4	49.21	183.7	55.18	186.4	55.74	189.0	56.02	195.0	56.18	200.3	56.63		
	41	146.7	42.25	170.6	51.84	176.4	54.09	178.9	54.56	181.4	54.84	186.7	55.00	192.0	55.44		
	43	143.1	45.09	163.4	51.11	169.1	52.89	171.5	53.39	174.0	53.66	179.2	53.83	184.4	54.25		
46	134.1	48.49	149.1	49.90	154.4	51.22	156.7	51.64	159.1	51.90	163.9	52.06	168.8	52.47			
48	118.6	47.49	129.5	49.01	134.2	50.22	136.4	50.52	138.4	50.68	142.6	50.89	147.0	51.10			
110	10	134.9	15.97	160.9	19.45	179.6	23.11	184.8	25.02	196.4	26.92	201.0	27.68	214.6	28.12		
	12	134.9	16.46	160.9	20.12	179.6	24.08	184.8	25.71	196.4	27.93	201.0	28.84	214.6	29.50		
	14	134.9	16.97	160.9	21.01	179.6	25.16	184.8	26.99	196.4	29.34	201.0	30.17	214.6	30.81		
	16	134.9	17.57	160.9	21.78	179.6	26.20	184.8	28.17	196.4	30.69	201.0	31.52	214.6	32.08		
	18	134.9	18.23	160.9	22.69	179.6	27.70	184.8	29.67	196.4	32.38	201.0	33.02	214.6	33.63		
	20	134.9	18.87	160.9	23.83	179.6	29.38	184.8	31.03	196.4	33.94	201.0	34.79	214.6	35.34		
	21	134.9	19.29	160.9	24.52	179.6	30.14	184.8	31.86	196.4	34.90	201.0	35.77	214.6	36.33		
	23	134.9	20.56	160.9	26.29	179.6	31.82	184.8	33.64	196.4	36.87	201.0	37.65	214.6	38.28		
	25	134.9	21.98	160.9	28.06	179.6	33.61	184.8	35.57	196.4	38.94	201.0	39.50	212.0	40.31		
	27	134.9	23.47	160.9	30.00	179.6	35.52	184.8	37.64	196.4	40.66	201.0	41.60	208.9	42.32		
	29	134.9	25.06	160.9	32.03	179.6	37.53	184.8	39.86	196.4	42.99	201.0	43.73	206.2	44.39		
	31	134.9	26.65	160.9	34.15	179.6	39.66	184.8	42.23	193.3	45.16	198.4	46.05	203.0	46.53		
	33	134.9	28.41	160.9	36.35	179.6	41.91	184.8	44.76	190.6	47.69	195.2	48.49	200.4	48.75		
	35	134.9	30.18	160.9	38.83	179.6	44.26	184.8	47.42	187.4	50.34	192.0	50.79	197.1	51.05		
	37	134.9	31.98	160.9	41.21	179.6	46.72	182.2	50.24	184.1	53.09	189.4	53.28	193.9	53.43		
	39	134.9	34.48	160.9	43.79	176.4	49.30	178.9	53.74	181.6	55.71	186.0	55.82	191.3	55.87		
	41	131.5	36.98	156.7	46.36	168.9	51.99	171.5	58.13	173.7	58.13	178.8	58.59	183.2	59.06		
	43	128.1	38.83	152.8	48.31	161.8	55.13	164.5	55.75	166.6	55.64	171.5	55.95	175.9	56.11		
46	120.1	37.89	143.2	46.64	147.6	52.32	150.2	52.32	152.1	52.78	156.8	53.07	160.9	53.20			
48	106.3	36.80	124.4	44.93	128.2	49.79	130.6	50.12	132.3	50.36	136.4	50.51	139.9	50.70			

Note

1. TC: Total Capacity(kW), PI : Power Input(kW, Comp. + Outdoor fan motor)
2. Capacity tables show the average value of conditions which may occur.

7. Capacity Tables

Combination (%)	Outdoor air temp (°C DB)	Cooling Capacity(60HP)													
		Indoor air temp. (DB/WB, °C)													
		20		23		26		27		28		30		32	
		14	16	18	19	20	22	24							
	TC	PI	TC	PI	TC	PI	TC	PI	TC	PI	TC	PI	TC	PI	
100	10	113.4	14.37	135.0	17.46	157.1	20.73	168.0	22.40	178.9	24.06	198.2	26.79	202.6	27.00
	12	113.4	14.84	135.0	18.18	157.1	21.42	168.0	23.00	178.9	24.83	198.2	28.23	202.6	28.51
	14	113.4	15.30	135.0	18.91	157.1	22.33	168.0	23.99	178.9	25.91	198.2	29.80	202.6	30.09
	16	113.4	15.77	135.0	19.54	157.1	23.28	168.0	25.13	178.9	27.29	198.2	31.25	202.6	31.68
	18	113.4	16.23	135.0	20.26	157.1	24.19	168.0	26.35	178.9	28.95	198.2	33.02	202.6	33.27
	20	113.4	16.81	135.0	21.03	157.1	25.59	168.0	28.23	178.9	30.97	198.2	34.59	202.6	34.87
	21	113.4	17.16	135.0	21.53	157.1	26.47	168.0	29.20	178.9	32.12	198.2	35.38	202.6	35.67
	23	113.4	18.18	135.0	23.03	157.1	28.41	168.0	31.33	178.9	34.41	198.2	37.05	202.6	37.35
	25	113.4	19.32	135.0	24.52	157.1	30.36	168.0	33.53	178.9	36.79	198.2	38.63	200.9	38.94
	27	113.4	20.65	135.0	26.21	157.1	32.46	168.0	35.82	178.9	39.12	194.4	40.44	198.5	40.77
	29	113.4	21.98	135.0	27.97	157.1	34.68	168.0	38.30	178.9	41.40	190.8	42.07	195.5	42.41
	31	113.4	23.47	135.0	29.82	157.1	36.98	168.0	40.85	178.9	43.51	187.9	43.70	192.5	44.06
	33	113.4	24.88	135.0	31.77	157.1	39.44	168.0	43.59	178.9	45.14	184.9	45.34	189.5	45.70
	35	113.4	26.47	135.0	33.80	157.1	42.00	168.0	46.50	176.1	46.77	181.6	46.97	186.2	47.33
	37	113.4	28.35	135.0	36.25	157.1	44.49	168.0	48.71	173.1	48.96	178.1	49.16	182.4	49.60
	39	113.4	30.40	135.0	38.94	157.1	47.14	168.0	51.10	170.3	51.32	175.4	51.51	179.4	51.99
	41	111.6	32.44	132.9	41.63	154.6	49.80	161.2	53.48	164.7	53.70	168.6	53.88	174.0	54.39
	43	107.8	34.33	128.3	44.13	149.4	52.18	154.6	55.53	156.3	55.71	161.1	55.91	165.4	56.43
46	101.0	36.93	120.2	47.58	140.0	55.35	141.1	58.13	142.6	58.30	147.2	58.46	151.1	59.02	
48	89.4	31.88	106.4	41.16	120.9	47.31	122.6	49.32	123.9	49.48	128.0	49.59	131.5	49.99	
90	10	102.0	12.46	121.9	14.97	141.6	17.65	151.1	19.03	160.9	20.49	180.6	22.92	200.4	25.49
	12	102.0	12.61	121.9	15.21	141.6	17.96	151.1	19.41	160.9	20.93	180.6	23.37	200.4	25.94
	14	102.0	12.84	121.9	15.51	141.6	18.34	151.1	19.80	160.9	21.32	180.6	23.83	200.4	26.47
	16	102.0	13.07	121.9	15.82	141.6	18.72	151.1	20.17	160.9	21.71	180.6	24.28	200.4	26.92
	18	102.0	13.29	121.9	16.13	141.6	19.03	151.1	20.64	160.9	22.16	180.6	24.82	200.4	28.28
	20	102.0	13.52	121.9	16.43	141.6	19.41	151.1	21.02	160.9	23.01	180.6	26.56	200.4	29.63
	21	102.0	13.67	121.9	16.58	141.6	19.80	151.1	21.71	160.9	23.84	180.6	26.99	200.4	30.31
	23	102.0	13.98	121.9	17.27	141.6	21.17	151.1	23.30	160.9	25.53	180.6	28.62	197.6	31.74
	25	102.0	14.67	121.9	18.41	141.6	22.62	151.1	24.91	160.9	27.28	180.6	30.60	194.8	33.09
	27	102.0	15.66	121.9	19.64	141.6	24.14	151.1	26.59	160.9	29.19	180.6	32.53	192.0	34.64
	29	102.0	16.58	121.9	20.93	141.6	25.82	151.1	28.43	160.9	31.18	180.6	34.47	189.0	36.04
	31	102.0	17.65	121.9	22.32	141.6	27.51	151.1	30.27	160.9	33.25	180.6	36.18	186.2	37.43
	33	102.0	18.81	121.9	23.77	141.6	29.35	151.1	32.26	160.9	35.26	180.6	37.93	183.4	38.83
	35	102.0	19.95	121.9	25.22	141.6	31.18	151.1	34.38	160.9	37.39	177.5	40.10	180.5	41.04
	37	102.0	21.17	121.9	26.82	141.6	33.25	151.1	36.53	160.9	39.47	174.6	41.93	177.6	42.87
	39	102.0	22.41	121.9	28.53	141.6	35.19	151.1	38.88	160.9	41.51	171.8	44.21	174.8	44.74
	41	99.4	25.08	118.6	31.63	138.0	38.62	147.3	42.51	156.7	44.81	164.6	46.58	167.5	47.65
	43	96.9	27.07	115.7	34.18	134.5	42.18	143.7	45.79	152.8	48.05	157.9	49.88	160.6	50.49
46	90.9	30.47	108.5	38.92	126.0	48.07	134.7	51.92	138.9	53.38	144.0	54.76	146.8	54.84	
48	80.4	26.63	96.0	34.05	111.5	42.05	119.1	45.29	120.5	45.99	125.2	47.14	127.6	47.20	
80	10	90.6	10.45	108.0	12.57	125.4	14.74	134.4	15.91	143.4	17.07	160.9	19.47	178.1	21.13
	12	90.6	10.68	108.0	12.70	125.4	15.03	134.4	16.19	143.4	17.35	160.9	19.83	178.1	21.55
	14	90.6	10.82	108.0	12.99	125.4	15.24	134.4	16.48	143.4	17.64	160.9	20.19	178.1	21.96
	16	90.6	10.96	108.0	13.21	125.4	15.54	134.4	16.77	143.4	18.00	160.9	20.62	178.1	22.39
	18	90.6	11.19	108.0	13.44	125.4	15.83	134.4	17.07	143.4	18.37	160.9	20.98	178.1	22.87
	20	90.6	11.40	108.0	13.72	125.4	16.19	134.4	17.43	143.4	18.74	160.9	21.78	178.1	24.23
	21	90.6	11.46	108.0	13.87	125.4	16.33	134.4	17.64	143.4	19.17	160.9	22.47	178.1	24.87
	23	90.6	11.69	108.0	14.08	125.4	17.07	134.4	18.74	143.4	20.47	160.9	23.73	178.1	26.11
	25	90.6	12.13	108.0	15.03	125.4	18.30	134.4	20.05	143.4	21.93	160.9	25.39	178.1	27.92
	27	90.6	12.85	108.0	15.97	125.4	19.53	134.4	21.42	143.4	23.38	160.9	26.98	178.1	29.37
	29	90.6	13.65	108.0	17.07	125.4	20.77	134.4	22.81	143.4	24.97	160.9	28.90	178.1	31.44
	31	90.6	14.52	108.0	18.08	125.4	22.14	134.4	24.33	143.4	26.59	160.9	30.68	178.1	33.01
	33	90.6	15.39	108.0	19.31	125.4	23.59	134.4	25.92	143.4	28.32	160.9	32.32	178.1	34.61
	35	90.6	16.33	108.0	20.47	125.4	25.12	134.4	27.60	143.4	30.21	160.9	34.27	176.3	35.86
	37	90.6	17.28	108.0	21.78	125.4	26.65	134.4	29.34	143.4	32.10	160.9	36.16	173.5	37.49
	39	90.6	18.27	108.0	23.02	125.4	28.50	134.4	31.54	143.4	34.49	160.9	38.21	170.6	39.55
	41	88.4	20.20	105.2	25.51	122.1	31.29	130.9	34.57	139.6	37.90	156.7	42.53	163.4	43.83
	43	86.1	22.25	102.6	27.83	119.1	34.16	127.6	37.68	136.4	41.42	152.8	45.51	156.7	46.93
46	80.7	24.75	96.2	31.35	111.6	38.47	119.7	41.94	127.6	46.73	139.7	49.67	143.0	50.48	
48	71.4	21.62	85.1	27.42	98.8	33.65	105.9	36.63	113.0	40.91	121.4	43.00	124.4	43.45	

Note

1. TC: Total Capacity(kW), PI : Power Input(kW, Comp. + Outdoor fan motor)
2. Capacity tables show the average value of conditions which may occur.

7. Capacity Tables

Combination (%)	Outdoor air temp (°C DB)	Cooling Capacity(60HP)													
		Indoor air temp. (DB/WB, °C)													
		20		23		26		27		28		30		32	
		14	16	18	19	20	22	24	TC	PI	TC	PI	TC	PI	
70	10	79.1	9.20	94.9	10.95	109.9	12.69	117.6	13.70	125.4	14.63	140.4	16.67	156.0	18.63
	12	79.1	9.35	94.9	11.09	109.9	12.96	117.6	13.91	125.4	14.93	140.4	16.95	156.0	18.99
	14	79.1	9.50	94.9	11.23	109.9	13.19	117.6	14.13	125.4	15.14	140.4	17.32	156.0	19.33
	16	79.1	9.63	94.9	11.45	109.9	13.40	117.6	14.43	125.4	15.43	140.4	17.61	156.0	19.75
	18	79.1	9.78	94.9	11.66	109.9	13.70	117.6	14.70	125.4	15.72	140.4	17.89	156.0	20.10
	20	79.1	9.92	94.9	11.88	109.9	13.91	117.6	14.99	125.4	16.08	140.4	18.33	156.0	20.87
	21	79.1	10.06	94.9	11.96	109.9	14.06	117.6	15.14	125.4	16.23	140.4	18.62	156.0	21.31
	23	79.1	10.22	94.9	12.24	109.9	14.34	117.6	15.65	125.4	17.03	140.4	19.92	156.0	22.50
	25	79.1	10.36	94.9	12.69	109.9	15.29	117.6	16.73	125.4	18.18	140.4	21.30	156.0	23.59
	27	79.1	10.95	94.9	13.55	109.9	16.30	117.6	17.75	125.4	19.42	140.4	22.75	156.0	25.07
	29	79.1	11.66	94.9	14.34	109.9	17.32	117.6	18.91	125.4	20.65	140.4	24.26	156.0	26.86
	31	79.1	12.39	94.9	15.29	109.9	18.47	117.6	20.22	125.4	22.02	140.4	25.86	156.0	28.49
	33	79.1	13.11	94.9	16.15	109.9	19.63	117.6	21.44	125.4	23.40	140.4	27.53	156.0	30.34
	35	79.1	13.84	94.9	17.25	109.9	20.87	117.6	22.82	125.4	24.92	140.4	29.34	156.0	32.17
	37	79.1	14.70	94.9	18.27	109.9	22.16	117.6	24.26	125.4	26.52	140.4	31.23	156.0	33.95
	39	79.1	15.62	94.9	19.47	109.9	23.70	117.6	26.11	125.4	28.64	140.4	33.42	156.0	36.61
	41	77.1	17.27	92.4	21.33	107.0	26.00	114.6	28.64	122.1	31.14	136.9	36.70	152.0	39.49
	43	75.3	18.79	90.0	23.25	104.4	28.38	111.8	31.23	119.1	34.01	133.4	40.09	148.2	42.69
46	70.6	20.89	84.5	26.14	97.9	31.95	104.7	34.79	111.6	38.33	125.0	45.22	138.9	47.59	
48	62.4	18.23	74.7	22.84	86.5	27.93	92.6	30.39	98.8	33.53	110.6	39.58	123.0	41.18	
60	10	67.9	8.10	81.0	9.32	94.1	10.84	100.9	11.63	107.4	12.36	120.6	14.02	133.9	15.68
	12	67.9	8.16	81.0	9.47	94.1	11.20	100.9	11.99	107.4	12.79	120.6	14.53	133.9	16.26
	14	67.9	8.31	81.0	9.83	94.1	11.35	100.9	12.22	107.4	13.09	120.6	14.81	133.9	16.55
	16	67.9	8.46	81.0	9.97	94.1	11.56	100.9	12.43	107.4	13.30	120.6	15.04	133.9	16.91
	20	67.9	8.60	81.0	10.13	94.1	11.79	100.9	12.65	107.4	13.52	120.6	15.32	133.9	17.27
	21	67.9	8.67	81.0	10.19	94.1	11.93	100.9	12.79	107.4	13.66	120.6	15.54	133.9	17.42
	23	67.9	8.83	81.0	10.41	94.1	12.08	100.9	13.01	107.4	13.95	120.6	16.11	133.9	18.50
	25	67.9	8.97	81.0	10.63	94.1	12.58	100.9	13.66	107.4	14.81	120.6	17.21	133.9	19.80
	27	67.9	9.26	81.0	11.20	94.1	13.38	100.9	14.53	107.4	15.76	120.6	18.29	133.9	21.11
	29	67.9	9.83	81.0	11.93	94.1	14.24	100.9	15.47	107.4	16.77	120.6	19.52	133.9	22.55
	31	67.9	10.41	81.0	12.65	94.1	15.10	100.9	16.48	107.4	17.86	120.6	20.82	133.9	24.00
	33	67.9	10.98	81.0	13.38	94.1	16.05	100.9	17.50	107.4	19.01	120.6	22.12	133.9	25.59
	35	67.9	11.63	81.0	14.24	94.1	17.07	100.9	18.57	107.4	20.17	120.6	23.57	133.9	27.17
	37	67.9	12.28	81.0	15.03	94.1	18.06	100.9	19.73	107.4	21.39	120.6	25.00	133.9	28.92
	39	67.9	13.06	81.0	16.00	94.1	19.50	100.9	21.16	107.4	23.03	120.6	26.82	133.9	30.99
	41	66.0	14.17	78.9	17.52	91.9	21.19	98.2	23.13	104.6	24.99	117.5	29.43	130.4	33.67
	43	64.4	15.40	77.0	19.07	89.5	23.09	95.8	25.20	102.0	27.26	114.6	32.12	127.1	36.77
	46	60.4	17.25	72.2	21.41	84.0	25.96	89.8	28.33	95.6	30.67	107.4	36.20	119.1	41.90
48	53.4	15.04	63.9	18.68	74.2	22.69	79.4	24.74	84.6	26.80	95.0	31.66	105.5	36.66	
50	10	56.7	6.85	67.9	7.93	78.6	9.02	84.0	9.66	89.4	10.24	100.1	11.54	111.6	12.84
	12	56.7	6.92	67.9	8.01	78.6	9.16	84.0	9.80	89.4	10.46	100.1	11.76	111.6	13.05
	14	56.7	7.00	67.9	8.15	78.6	9.30	84.0	9.95	89.4	10.60	100.1	11.91	111.6	13.28
	16	56.7	7.14	67.9	8.29	78.6	9.45	84.0	10.17	89.4	10.74	100.1	12.11	111.6	13.48
	18	56.7	7.21	67.9	8.36	78.6	9.59	84.0	10.31	89.4	10.97	100.1	12.34	111.6	13.78
	20	56.7	7.28	67.9	8.51	78.6	9.80	84.0	10.46	89.4	11.17	100.1	12.54	111.6	14.06
	21	56.7	7.36	67.9	8.58	78.6	9.89	84.0	10.60	89.4	11.25	100.1	12.69	111.6	14.20
	23	56.7	7.51	67.9	8.73	78.6	10.03	84.0	10.74	89.4	11.46	100.1	12.91	111.6	14.49
	25	56.7	7.57	67.9	8.87	78.6	10.24	84.0	10.97	89.4	11.83	100.1	13.56	111.6	15.50
	27	56.7	7.71	67.9	9.16	78.6	10.82	84.0	11.68	89.4	12.54	100.1	14.49	111.6	16.51
	29	56.7	8.15	67.9	9.73	78.6	11.46	84.0	12.40	89.4	13.34	100.1	15.36	111.6	17.52
	31	56.7	8.58	67.9	10.31	78.6	12.19	84.0	13.13	89.4	14.20	100.1	16.37	111.6	18.68
	33	56.7	9.09	67.9	10.89	78.6	12.91	84.0	13.92	89.4	15.07	100.1	17.37	111.6	19.90
	35	56.7	9.59	67.9	11.54	78.6	13.62	84.0	14.79	89.4	15.94	100.1	18.39	111.6	21.13
	37	56.7	10.17	67.9	12.19	78.6	14.42	84.0	15.65	89.4	16.88	100.1	19.62	111.6	22.43
	39	56.7	10.85	67.9	13.07	78.6	15.46	84.0	16.85	89.4	18.11	100.1	20.90	111.6	24.22
	41	55.2	11.73	66.0	14.14	76.6	16.89	81.9	18.25	87.0	19.62	97.6	22.90	108.7	26.30
	43	53.9	12.75	64.4	15.38	74.7	18.39	79.9	19.87	85.0	21.36	95.2	24.98	106.1	28.70
46	50.5	14.28	60.4	17.26	70.0	20.63	74.8	22.31	79.6	23.98	89.2	28.10	99.4	32.31	
48	44.7	12.44	53.4	15.04	61.9	17.99	66.2	19.47	70.4	20.92	78.9	24.55	87.9	28.23	

Note

1. TC: Total Capacity(kW), PI : Power Input(kW, Comp. + Outdoor fan motor)
2. Capacity tables show the average value of conditions which may occur.

7. Capacity Tables

◆ A(C)RUN620LLS5

Combination (%)	Outdoor air temp (°C DB)	Indoor air temp. (DB/WB, °C)														Cooling Capacity(62HP)	
		20		23		26		27		28		30		32		TC	PI
		14		16		18		19		20		22		24			
		TC	PI	TC	PI	TC	PI	TC	PI	TC	PI	TC	PI	TC	PI		
130	10	172.0	20.32	204.8	24.83	219.5	28.81	225.8	29.39	232.0	29.64	243.3	29.87	249.5	29.98		
	12	172.0	20.82	204.8	25.72	219.5	29.99	225.8	30.19	232.0	30.42	243.3	30.67	249.5	30.95		
	14	172.0	21.53	204.8	26.65	219.5	31.11	225.8	31.34	232.0	31.60	243.3	31.85	249.5	32.13		
	16	172.0	22.31	204.8	27.58	219.5	32.51	225.8	32.82	232.0	33.08	243.3	33.37	249.5	33.64		
	18	172.0	23.24	204.8	29.18	219.5	34.01	225.8	34.74	232.0	35.03	243.3	35.37	249.5	35.61		
	20	172.0	24.27	204.8	31.09	219.5	35.69	225.8	38.21	232.0	38.53	239.7	38.90	246.0	39.17		
	21	172.0	24.90	204.8	32.18	219.5	36.43	225.8	40.44	232.0	40.76	238.4	41.17	244.7	41.45		
	23	172.0	26.72	204.8	33.85	219.5	38.32	225.8	44.62	229.1	44.98	234.9	45.43	241.1	45.74		
	25	172.0	28.53	204.8	35.79	219.5	40.95	223.1	49.49	225.8	49.88	232.0	50.38	238.4	50.73		
	27	172.0	30.53	204.8	38.27	216.7	43.64	219.5	54.48	223.1	54.92	229.1	55.45	234.9	55.85		
	29	172.0	32.54	204.8	40.90	213.2	46.95	216.3	59.88	219.5	60.24	225.8	60.77	232.0	61.01		
	31	172.0	34.72	204.1	43.09	209.7	49.95	213.2	59.62	216.3	59.99	222.2	60.51	228.5	60.76		
	33	172.0	36.99	200.5	45.66	206.9	53.56	210.3	59.08	213.2	59.43	219.5	59.96	225.0	60.20		
	35	172.0	39.45	197.0	47.81	203.4	58.01	206.9	58.31	210.3	58.66	216.0	59.19	222.2	59.42		
	37	172.0	42.07	194.3	50.17	200.5	57.25	203.4	57.54	206.9	57.89	212.5	58.40	218.8	58.63		
	39	172.0	44.79	190.8	52.81	197.0	56.49	200.5	56.77	203.4	57.11	209.7	57.62	216.0	57.85		
	41	167.6	47.52	182.9	55.45	189.1	55.72	191.9	56.00	195.7	56.34	201.5	56.84	207.0	57.06		
	43	163.4	50.11	175.3	54.67	181.4	54.95	184.1	55.22	187.9	55.56	193.6	56.06	198.9	56.28		
	46	153.1	53.64	159.9	53.54	165.7	53.80	168.3	54.08	171.8	54.40	177.2	54.88	182.1	55.11		
	48	135.4	52.14	138.9	52.30	144.1	52.42	146.4	52.56	149.5	53.01	154.3	53.35	158.6	53.56		
120	10	155.5	18.29	185.0	22.41	202.2	26.64	208.3	28.79	214.4	29.24	226.1	29.35	231.6	29.59		
	12	155.5	18.77	185.0	23.17	202.2	27.71	208.3	29.39	214.4	30.32	226.1	30.69	231.6	30.93		
	14	155.5	19.42	185.0	23.95	202.2	28.83	208.3	30.51	214.4	31.43	226.1	31.90	231.6	32.15		
	16	155.5	20.12	185.0	24.93	202.2	29.94	208.3	31.64	214.4	32.89	226.1	33.30	231.6	33.55		
	18	155.5	20.90	185.0	26.06	202.2	31.14	208.3	33.32	214.4	34.57	226.1	34.97	231.6	35.25		
	20	155.5	21.70	185.0	27.63	202.2	32.82	208.3	35.05	214.4	36.40	226.1	36.88	231.6	37.18		
	21	155.5	22.36	185.0	28.63	202.2	33.74	208.3	36.09	214.4	37.61	226.1	38.09	231.6	38.38		
	23	155.5	23.90	185.0	30.63	202.2	36.14	208.3	38.35	214.4	40.09	226.1	40.49	231.6	40.81		
	25	155.5	25.54	185.0	32.82	202.2	38.11	208.3	40.88	214.4	42.99	223.4	43.34	228.9	43.69		
	27	155.5	27.27	185.0	35.08	202.2	40.57	208.3	43.68	214.4	46.19	220.1	46.51	225.5	46.88		
	29	155.5	29.08	185.0	37.45	202.2	42.69	208.3	46.74	211.0	49.24	216.5	49.98	222.7	50.38		
	31	155.5	31.00	185.0	40.00	202.2	44.90	205.6	50.07	208.3	52.82	213.9	53.75	219.2	54.19		
	33	155.5	33.00	185.0	42.63	199.4	47.49	202.2	54.35	204.9	56.72	210.3	57.36	215.9	57.82		
	35	155.5	35.08	185.0	45.44	196.0	50.27	198.7	59.88	202.2	60.17	207.7	60.35	213.1	60.83		
	37	155.5	37.74	185.0	47.95	193.2	53.59	196.0	58.61	198.7	58.91	204.2	59.09	209.8	59.56		
	39	155.5	40.63	184.4	50.69	189.8	56.84	192.6	57.41	195.3	57.70	201.5	57.87	207.0	58.33		
	41	151.6	43.52	176.2	53.40	182.2	55.72	184.8	56.21	187.5	56.49	192.9	56.66	198.4	57.11		
	43	147.8	46.45	168.9	52.64	174.8	54.48	177.2	55.00	179.8	55.27	185.2	55.45	190.6	55.88		
	46	138.5	49.95	154.0	51.40	159.6	52.76	161.9	53.19	164.4	53.46	169.4	53.62	174.4	54.05		
	48	122.6	48.92	133.8	50.48	138.7	51.74	140.9	52.05	143.0	52.21	147.4	52.42	151.9	52.64		
110	10	139.4	16.45	166.2	20.03	185.6	23.80	191.0	25.77	203.0	27.73	207.7	28.51	221.7	28.97		
	12	139.4	16.95	166.2	20.72	185.6	24.80	191.0	26.49	203.0	28.77	207.7	29.70	221.7	30.39		
	14	139.4	17.48	166.2	21.65	185.6	25.92	191.0	27.80	203.0	30.22	207.7	31.08	221.7	31.74		
	16	139.4	18.10	166.2	22.44	185.6	26.98	191.0	29.02	203.0	31.61	207.7	32.47	221.7	33.05		
	18	139.4	18.77	166.2	23.37	185.6	28.53	191.0	30.56	203.0	33.35	207.7	34.01	221.7	34.64		
	20	139.4	19.44	166.2	24.54	185.6	30.26	191.0	31.96	203.0	34.97	207.7	35.83	221.7	36.40		
	21	139.4	19.87	166.2	25.26	185.6	31.05	191.0	32.82	203.0	35.95	207.7	36.85	221.7	37.42		
	23	139.4	21.18	166.2	27.08	185.6	32.77	191.0	34.66	203.0	37.98	207.7	38.79	221.7	39.43		
	25	139.4	22.64	166.2	28.90	185.6	34.63	191.0	36.64	203.0	40.11	207.7	40.69	219.1	41.53		
	27	139.4	24.18	166.2	30.90	185.6	36.59	191.0	38.77	203.0	41.89	207.7	42.85	215.8	43.59		
	29	139.4	25.82	166.2	33.00	185.6	38.66	191.0	41.06	203.0	44.28	207.7	45.04	213.1	45.72		
	31	139.4	27.45	166.2	35.18	185.6	40.86	191.0	43.50	199.7	46.52	205.1	47.43	209.8	47.93		
	33	139.4	29.27	166.2	37.45	185.6	43.17	191.0	46.11	196.9	49.13	201.7	49.95	207.0	50.22		
	35	139.4	31.09	166.2	40.00	185.6	45.59	191.0	48.85	193.7	51.85	198.4	52.32	203.7	52.59		
	37	139.4	32.95	166.2	42.45	185.6	48.13	188.3	51.75	190.3	54.69	195.7	54.88	200.4	55.04		
	39	139.4	35.52	166.2	45.11	182.2	50.79	184.9	55.36	187.6	57.39	192.2	57.50	197.7	57.55		
	41	135.9	38.09	161.9	47.76	174.5	53.56	177.2	59.88	179.5	59.88	184.8	60.35	189.3	60.83		
	43	132.4	40.00	157.9	49.77	167.2	56.79	170.0	57.43	172.1	57.32	177.2	57.64	181.7	57.80		
	46	124.1	39.03	148.0	48.04	152.5	53.90	155.2	53.90	157.2	54.37	162.0	54.67	166.2	54.81		
	48	109.8	37.91	128.6	46.28	132.5	51.29	134.9	51.63	136.7	51.88	140.9	52.03	144.6	52.23		

Note

1. TC: Total Capacity(kW), PI : Power Input(kW, Comp. + Outdoor fan motor)
2. Capacity tables show the average value of conditions which may occur.

7. Capacity Tables

Combination (%)	Outdoor air temp (°C DB)	Cooling Capacity(62HP)													
		Indoor air temp. (DB/WB, °C)													
		20		23		26		27		28		30		32	
		14	16	18	19	20	22	24							
	TC	PI	TC	PI	TC	PI	TC	PI	TC	PI	TC	PI	TC	PI	
100	10	117.2	14.81	139.5	17.99	162.4	21.35	173.6	23.08	184.8	24.79	204.8	27.59	209.3	27.82
	12	117.2	15.29	139.5	18.73	162.4	22.07	173.6	23.69	184.8	25.58	204.8	29.08	209.3	29.37
	14	117.2	15.76	139.5	19.48	162.4	23.00	173.6	24.71	184.8	26.69	204.8	30.70	209.3	31.00
	16	117.2	16.24	139.5	20.13	162.4	23.98	173.6	25.89	184.8	28.11	204.8	32.19	209.3	32.63
	18	117.2	16.72	139.5	20.87	162.4	24.92	173.6	27.15	184.8	29.82	204.8	34.01	209.3	34.27
	20	117.2	17.32	139.5	21.66	162.4	26.37	173.6	29.08	184.8	31.90	204.8	35.63	209.3	35.92
	21	117.2	17.68	139.5	22.18	162.4	27.27	173.6	30.08	184.8	33.09	204.8	36.45	209.3	36.74
	23	117.2	18.72	139.5	23.72	162.4	29.27	173.6	32.27	184.8	35.45	204.8	38.16	209.3	38.48
	25	117.2	19.90	139.5	25.26	162.4	31.27	173.6	34.54	184.8	37.90	204.8	39.79	207.6	40.11
	27	117.2	21.27	139.5	27.00	162.4	33.44	173.6	36.90	184.8	40.30	200.9	41.66	205.1	42.00
	29	117.2	22.64	139.5	28.81	162.4	35.72	173.6	39.45	184.8	42.65	197.2	43.34	202.0	43.69
	31	117.2	24.18	139.5	30.72	162.4	38.09	173.6	42.08	184.8	44.82	194.2	45.02	198.9	45.38
	33	117.2	25.63	139.5	32.72	162.4	40.63	173.6	44.90	184.8	46.50	191.1	46.70	195.8	47.08
	35	117.2	27.27	139.5	34.82	162.4	43.27	173.6	47.90	181.9	48.18	187.6	48.38	192.4	48.76
	37	117.2	29.21	139.5	37.34	162.4	45.83	173.6	50.18	178.9	50.43	184.1	50.64	188.5	51.10
	39	117.2	31.32	139.5	40.11	162.4	48.56	173.6	52.64	176.0	52.87	181.2	53.06	185.4	53.56
	41	115.3	33.42	137.3	42.88	159.8	51.30	166.6	55.09	170.2	55.31	174.2	55.50	179.8	56.02
	43	111.4	35.37	132.6	45.46	154.4	53.75	159.7	57.20	161.5	57.39	166.5	57.59	171.0	58.13
46	104.4	38.04	124.2	49.01	144.7	57.01	145.8	59.88	147.4	60.06	152.1	60.22	156.2	60.80	
48	92.3	32.84	109.9	42.40	124.9	48.74	126.7	50.80	128.1	50.97	132.3	51.08	135.9	51.49	
90	10	105.4	12.84	125.9	15.43	146.3	18.19	156.2	19.61	166.2	21.11	186.6	23.62	207.1	26.26
	12	105.4	12.99	125.9	15.67	146.3	18.51	156.2	20.00	166.2	21.57	186.6	24.08	207.1	26.73
	14	105.4	13.23	125.9	15.98	146.3	18.90	156.2	20.40	166.2	21.97	186.6	24.55	207.1	27.28
	16	105.4	13.47	125.9	16.30	146.3	19.29	156.2	20.79	166.2	22.37	186.6	25.02	207.1	27.74
	18	105.4	13.70	125.9	16.62	146.3	19.61	156.2	21.27	166.2	22.84	186.6	25.57	207.1	29.14
	20	105.4	13.93	125.9	16.93	146.3	20.00	156.2	21.66	166.2	23.71	186.6	27.36	207.1	30.53
	21	105.4	14.09	125.9	17.09	146.3	20.40	156.2	22.37	166.2	24.57	186.6	27.81	207.1	31.23
	23	105.4	14.41	125.9	17.80	146.3	21.82	156.2	24.01	166.2	26.31	186.6	29.49	204.2	32.70
	25	105.4	15.12	125.9	18.97	146.3	23.31	156.2	25.67	166.2	28.11	186.6	31.53	201.3	34.10
	27	105.4	16.14	125.9	20.24	146.3	24.88	156.2	27.40	166.2	30.08	186.6	33.52	198.4	35.70
	29	105.4	17.09	125.9	21.57	146.3	26.61	156.2	29.30	166.2	32.13	186.6	35.52	195.3	37.13
	31	105.4	18.19	125.9	23.00	146.3	28.35	156.2	31.19	166.2	34.26	186.6	37.28	192.4	38.57
	33	105.4	19.38	125.9	24.49	146.3	30.24	156.2	33.24	166.2	36.33	186.6	39.09	189.5	40.01
	35	105.4	20.56	125.9	25.99	146.3	32.13	156.2	35.43	166.2	38.52	183.4	41.32	186.5	42.28
	37	105.4	21.82	125.9	27.64	146.3	34.26	156.2	37.64	166.2	40.67	180.5	43.20	183.6	44.17
	39	105.4	23.09	125.9	29.40	146.3	36.26	156.2	40.06	166.2	42.77	177.5	45.55	180.6	46.10
	41	102.8	25.84	122.6	32.59	142.6	39.80	152.2	43.80	161.9	46.17	170.0	47.99	173.1	49.10
	43	100.2	27.89	119.6	35.21	139.0	43.47	148.5	47.18	157.9	49.50	163.1	51.40	166.0	52.02
46	93.9	31.40	112.1	40.11	130.2	49.53	139.2	53.49	143.5	55.00	148.8	56.42	151.7	56.50	
48	83.0	27.44	99.2	35.08	115.2	43.32	123.0	46.66	124.5	47.39	129.4	48.57	131.8	48.63	
80	10	93.6	10.77	111.6	12.95	129.6	15.19	138.9	16.39	148.2	17.58	166.2	20.06	184.1	21.77
	12	93.6	11.00	111.6	13.08	129.6	15.49	138.9	16.68	148.2	17.88	166.2	20.43	184.1	22.20
	14	93.6	11.15	111.6	13.39	129.6	15.71	138.9	16.98	148.2	18.18	166.2	20.80	184.1	22.62
	16	93.6	11.30	111.6	13.61	129.6	16.01	138.9	17.28	148.2	18.55	166.2	21.25	184.1	23.07
	18	93.6	11.53	111.6	13.85	129.6	16.31	138.9	17.58	148.2	18.92	166.2	21.62	184.1	23.57
	20	93.6	11.75	111.6	14.14	129.6	16.68	138.9	17.95	148.2	19.30	166.2	22.44	184.1	24.97
	21	93.6	11.81	111.6	14.29	129.6	16.83	138.9	18.18	148.2	19.75	166.2	23.15	184.1	25.63
	23	93.6	12.05	111.6	14.51	129.6	17.58	138.9	19.30	148.2	21.09	166.2	24.45	184.1	26.90
	25	93.6	12.50	111.6	15.49	129.6	18.85	138.9	20.65	148.2	22.60	166.2	26.16	184.1	28.76
	27	93.6	13.24	111.6	16.46	129.6	20.13	138.9	22.07	148.2	24.09	166.2	27.80	184.1	30.26
	29	93.6	14.06	111.6	17.58	129.6	21.40	138.9	23.50	148.2	25.73	166.2	29.78	184.1	32.40
	31	93.6	14.96	111.6	18.63	129.6	22.82	138.9	25.06	148.2	27.39	166.2	31.61	184.1	34.01
	33	93.6	15.86	111.6	19.90	129.6	24.31	138.9	26.71	148.2	29.18	166.2	33.30	184.1	35.66
	35	93.6	16.83	111.6	21.09	129.6	25.89	138.9	28.44	148.2	31.13	166.2	35.31	182.2	36.95
	37	93.6	17.81	111.6	22.44	129.6	27.46	138.9	30.23	148.2	33.07	166.2	37.26	179.3	38.63
	39	93.6	18.82	111.6	23.71	129.6	29.37	138.9	32.50	148.2	35.54	166.2	39.37	176.2	40.75
	41	91.3	20.82	108.7	26.28	126.2	32.24	135.3	35.62	144.3	39.05	161.9	43.82	168.9	45.16
	43	88.9	22.92	106.1	28.67	123.1	35.20	131.9	38.82	140.9	42.68	157.9	46.89	161.9	48.36
46	83.4	25.50	99.4	32.30	115.4	39.64	123.7	43.21	131.9	48.15	144.4	51.18	147.8	52.01	
48	73.8	22.28	87.9	28.25	102.1	34.67	109.5	37.74	116.8	42.15	125.4	44.30	128.5	44.77	

Note

1. TC: Total Capacity(kW), PI : Power Input(kW, Comp. + Outdoor fan motor)
2. Capacity tables show the average value of conditions which may occur.

7. Capacity Tables

Combination (%)	Outdoor air temp (°C DB)	Cooling Capacity(62HP)													
		Indoor air temp. (DB/WB, °C)													
		20		23		26		27		28		30		32	
		14	16	18	19	20	22	24	TC	PI	TC	PI	TC	PI	
70	10	81.8	9.48	98.0	11.28	113.5	13.07	121.5	14.11	129.6	15.08	145.1	17.17	161.2	19.20
	12	81.8	9.63	98.0	11.42	113.5	13.35	121.5	14.33	129.6	15.38	145.1	17.47	161.2	19.56
	14	81.8	9.79	98.0	11.57	113.5	13.59	121.5	14.56	129.6	15.60	145.1	17.85	161.2	19.92
	16	81.8	9.92	98.0	11.79	113.5	13.81	121.5	14.86	129.6	15.90	145.1	18.15	161.2	20.35
	18	81.8	10.08	98.0	12.02	113.5	14.11	121.5	15.15	129.6	16.20	145.1	18.43	161.2	20.72
	20	81.8	10.22	98.0	12.24	113.5	14.33	121.5	15.45	129.6	16.57	145.1	18.89	161.2	21.50
	21	81.8	10.37	98.0	12.32	113.5	14.48	121.5	15.60	129.6	16.73	145.1	19.18	161.2	21.95
	23	81.8	10.53	98.0	12.61	113.5	14.78	121.5	16.12	129.6	17.54	145.1	20.53	161.2	23.18
	25	81.8	10.67	98.0	13.07	113.5	15.75	121.5	17.24	129.6	18.73	145.1	21.95	161.2	24.31
	27	81.8	11.28	98.0	13.96	113.5	16.79	121.5	18.29	129.6	20.01	145.1	23.44	161.2	25.83
	29	81.8	12.02	98.0	14.78	113.5	17.85	121.5	19.48	129.6	21.28	145.1	25.00	161.2	27.67
	31	81.8	12.77	98.0	15.75	113.5	19.04	121.5	20.83	129.6	22.69	145.1	26.65	161.2	29.36
	33	81.8	13.51	98.0	16.64	113.5	20.22	121.5	22.10	129.6	24.11	145.1	28.36	161.2	31.26
	35	81.8	14.26	98.0	17.77	113.5	21.50	121.5	23.51	129.6	25.67	145.1	30.24	161.2	33.15
	37	81.8	15.15	98.0	18.82	113.5	22.84	121.5	25.00	129.6	27.32	145.1	32.17	161.2	34.98
	39	81.8	16.10	98.0	20.06	113.5	24.42	121.5	26.90	129.6	29.51	145.1	34.43	161.2	37.72
	41	79.7	17.80	95.4	21.97	110.6	26.79	118.4	29.51	126.2	32.08	141.4	37.82	157.1	40.69
	43	77.8	19.36	93.0	23.96	107.8	29.24	115.5	32.18	123.1	35.04	137.9	41.31	153.1	43.99
46	72.9	21.52	87.3	26.94	101.1	32.93	108.2	35.84	115.4	39.50	129.2	46.60	143.6	49.03	
48	64.5	18.78	77.2	23.54	89.4	28.78	95.7	31.32	102.1	34.55	114.2	40.78	127.1	42.43	
60	10	70.1	8.19	83.7	9.61	97.3	11.17	104.2	11.99	111.0	12.74	124.6	14.45	138.3	16.16
	12	70.1	8.34	83.7	9.75	97.3	11.32	104.2	12.14	111.0	12.96	124.6	14.67	138.3	16.46
	14	70.1	8.41	83.7	9.91	97.3	11.54	104.2	12.36	111.0	13.18	124.6	14.97	138.3	16.76
	16	70.1	8.56	83.7	10.13	97.3	11.70	104.2	12.59	111.0	13.48	124.6	15.26	138.3	17.05
	18	70.1	8.71	83.7	10.28	97.3	11.91	104.2	12.80	111.0	13.71	124.6	15.49	138.3	17.43
	20	70.1	8.86	83.7	10.43	97.3	12.14	104.2	13.04	111.0	13.93	124.6	15.79	138.3	17.80
	21	70.1	8.94	83.7	10.50	97.3	12.29	104.2	13.18	111.0	14.08	124.6	16.01	138.3	17.95
	23	70.1	9.09	83.7	10.72	97.3	12.44	104.2	13.41	111.0	14.38	124.6	16.60	138.3	19.06
	25	70.1	9.24	83.7	10.95	97.3	12.96	104.2	14.08	111.0	15.26	124.6	17.73	138.3	20.40
	27	70.1	9.54	83.7	11.54	97.3	13.79	104.2	14.97	111.0	16.24	124.6	18.85	138.3	21.75
	29	70.1	10.13	83.7	12.29	97.3	14.67	104.2	15.94	111.0	17.28	124.6	20.11	138.3	23.24
	31	70.1	10.72	83.7	13.04	97.3	15.56	104.2	16.98	111.0	18.40	124.6	21.45	138.3	24.73
	33	70.1	11.32	83.7	13.79	97.3	16.53	104.2	18.03	111.0	19.58	124.6	22.79	138.3	26.37
	35	70.1	11.99	83.7	14.67	97.3	17.58	104.2	19.14	111.0	20.78	124.6	24.29	138.3	28.00
	37	70.1	12.66	83.7	15.48	97.3	18.61	104.2	20.33	111.0	22.04	124.6	25.76	138.3	29.79
	39	70.1	13.46	83.7	16.49	97.3	20.09	104.2	21.81	111.0	23.73	124.6	27.64	138.3	31.93
	41	68.2	14.60	81.6	18.05	94.9	21.83	101.5	23.83	108.1	25.75	121.4	30.32	134.8	34.69
	43	66.6	15.87	79.6	19.64	92.5	23.79	99.0	25.97	105.4	28.09	118.4	33.10	131.4	37.89
46	62.5	17.78	74.6	22.06	86.8	26.75	92.8	29.19	98.8	31.60	111.0	37.30	123.1	43.17	
48	55.2	15.49	66.0	19.25	76.7	23.38	82.1	25.49	87.4	27.61	98.2	32.62	109.0	37.77	
50	10	58.6	7.06	70.1	8.17	81.2	9.30	86.8	9.95	92.4	10.55	103.5	11.89	115.3	13.23
	12	58.6	7.13	70.1	8.25	81.2	9.44	86.8	10.10	92.4	10.78	103.5	12.11	115.3	13.45
	14	58.6	7.21	70.1	8.39	81.2	9.59	86.8	10.25	92.4	10.92	103.5	12.27	115.3	13.68
	16	58.6	7.36	70.1	8.54	81.2	9.74	86.8	10.48	92.4	11.07	103.5	12.48	115.3	13.89
	18	58.6	7.43	70.1	8.62	81.2	9.89	86.8	10.62	92.4	11.30	103.5	12.71	115.3	14.19
	20	58.6	7.50	70.1	8.77	81.2	10.10	86.8	10.78	92.4	11.51	103.5	12.93	115.3	14.48
	21	58.6	7.58	70.1	8.84	81.2	10.19	86.8	10.92	92.4	11.59	103.5	13.07	115.3	14.63
	23	58.6	7.74	70.1	8.99	81.2	10.33	86.8	11.07	92.4	11.81	103.5	13.30	115.3	14.93
	25	58.6	7.80	70.1	9.14	81.2	10.55	86.8	11.30	92.4	12.19	103.5	13.97	115.3	15.98
	27	58.6	7.95	70.1	9.44	81.2	11.14	86.8	12.03	92.4	12.93	103.5	14.93	115.3	17.01
	29	58.6	8.39	70.1	10.03	81.2	11.81	86.8	12.78	92.4	13.75	103.5	15.83	115.3	18.06
	31	58.6	8.84	70.1	10.62	81.2	12.56	86.8	13.53	92.4	14.63	103.5	16.87	115.3	19.25
	33	58.6	9.36	70.1	11.22	81.2	13.30	86.8	14.34	92.4	15.53	103.5	17.90	115.3	20.51
	35	58.6	9.89	70.1	11.89	81.2	14.04	86.8	15.24	92.4	16.42	103.5	18.95	115.3	21.78
	37	58.6	10.48	70.1	12.56	81.2	14.86	86.8	16.12	92.4	17.39	103.5	20.22	115.3	23.11
	39	58.6	11.18	70.1	13.46	81.2	15.93	86.8	17.36	92.4	18.66	103.5	21.53	115.3	24.96
	41	57.0	12.08	68.2	14.57	79.1	17.41	84.6	18.80	89.9	20.22	100.9	23.59	112.3	27.10
	43	55.7	13.14	66.6	15.85	77.2	18.95	82.5	20.47	87.8	22.01	98.4	25.73	109.6	29.57
46	52.2	14.72	62.5	17.78	72.3	21.25	77.3	22.99	82.2	24.70	92.2	28.95	102.8	33.29	
48	46.2	12.81	55.2	15.50	64.0	18.54	68.4	20.06	72.8	21.56	81.6	25.29	90.9	29.09	

Note

1. TC: Total Capacity(kW), PI : Power Input(kW, Comp. + Outdoor fan motor)
2. Capacity tables show the average value of conditions which may occur.

7. Capacity Tables

◆ A(C)RUN640LLS5

Combination (%)	Outdoor air temp (°C DB)	Indoor air temp. (DB/WB, °C)														Cooling Capacity(64HP)	
		20		23		26		27		28		30		32		TC	PI
		14		16		18		19		20		22		24			
		TC	PI	TC	PI	TC	PI	TC	PI	TC	PI	TC	PI	TC	PI		
130	10	177.5	21.42	211.4	26.17	226.5	30.37	233.1	30.98	239.5	31.25	251.1	31.49	257.5	31.61		
	12	177.5	21.95	211.4	27.12	226.5	31.61	233.1	31.83	239.5	32.07	251.1	32.34	257.5	32.63		
	14	177.5	22.70	211.4	28.09	226.5	32.80	233.1	33.04	239.5	33.31	251.1	33.58	257.5	33.87		
	16	177.5	23.52	211.4	29.08	226.5	34.28	233.1	34.60	239.5	34.87	251.1	35.18	257.5	35.47		
	18	177.5	24.50	211.4	30.76	226.5	35.86	233.1	36.63	239.5	36.93	251.1	37.29	257.5	37.54		
	20	177.5	25.59	211.4	32.78	226.5	37.63	233.1	40.28	239.5	40.62	247.4	41.01	254.0	41.30		
	21	177.5	26.25	211.4	33.92	226.5	38.41	233.1	42.63	239.5	42.97	246.1	43.41	252.6	43.70		
	23	177.5	28.17	211.4	35.69	226.5	40.40	233.1	47.05	236.5	47.42	242.5	47.90	248.9	48.22		
	25	177.5	30.08	211.4	37.73	226.5	43.17	230.2	52.18	233.1	52.59	239.5	53.12	246.1	53.49		
	27	177.5	32.19	211.4	40.35	223.7	46.01	226.5	57.44	230.2	57.90	236.5	58.46	242.5	58.88		
	29	177.5	34.31	211.4	43.12	220.1	49.50	223.3	63.13	226.5	63.51	233.1	64.07	239.5	64.32		
	31	177.5	36.61	210.7	45.43	216.4	52.66	220.1	62.86	223.3	63.25	229.4	63.80	235.8	64.05		
	33	177.5	38.99	207.0	48.14	213.6	56.47	217.1	62.28	220.1	62.66	226.5	63.22	232.3	63.47		
	35	177.5	41.59	203.3	50.40	210.0	61.16	213.6	61.47	217.1	61.84	223.0	62.40	229.4	62.64		
	37	177.5	44.36	200.6	52.90	207.0	60.36	210.0	60.67	213.6	61.04	219.3	61.57	225.9	61.81		
	39	177.5	47.22	196.9	55.67	203.3	59.56	207.0	59.85	210.0	60.21	216.4	60.75	223.0	60.99		
	41	173.0	50.09	188.8	58.46	195.2	58.75	198.1	59.04	202.1	59.39	208.0	59.92	213.7	60.16		
	43	168.6	52.83	180.9	57.64	187.3	57.93	190.0	58.22	194.0	58.58	199.9	59.10	205.3	59.34		
	46	158.0	56.55	165.1	56.45	171.1	56.72	173.8	57.01	177.3	57.35	182.9	57.86	188.0	58.10		
	48	139.8	54.97	143.3	55.14	148.7	55.26	151.1	55.41	154.3	55.89	159.3	56.25	163.7	56.47		
120	10	160.5	19.28	191.0	23.62	208.7	28.09	215.1	30.35	221.3	30.83	233.4	30.95	239.0	31.20		
	12	160.5	19.79	191.0	24.43	208.7	29.21	215.1	30.98	221.3	31.97	233.4	32.36	239.0	32.61		
	14	160.5	20.47	191.0	25.25	208.7	30.40	215.1	32.17	221.3	33.14	233.4	33.63	239.0	33.89		
	16	160.5	21.22	191.0	26.29	208.7	31.56	215.1	33.36	221.3	34.67	233.4	35.11	239.0	35.37		
	18	160.5	22.04	191.0	27.48	208.7	32.83	215.1	35.13	221.3	36.44	233.4	36.86	239.0	37.17		
	20	160.5	22.87	191.0	29.13	208.7	34.60	215.1	36.95	221.3	38.38	233.4	38.89	239.0	39.19		
	21	160.5	23.57	191.0	30.18	208.7	35.57	215.1	38.05	221.3	39.65	233.4	40.16	239.0	40.47		
	23	160.5	25.20	191.0	32.29	208.7	38.10	215.1	40.43	221.3	42.27	233.4	42.68	239.0	43.02		
	25	160.5	26.93	191.0	34.60	208.7	40.18	215.1	43.10	221.3	45.33	230.6	45.69	236.3	46.06		
	27	160.5	28.75	191.0	36.98	208.7	42.78	215.1	46.06	221.3	48.70	227.2	49.04	232.8	49.43		
	29	160.5	30.66	191.0	39.48	208.7	45.01	215.1	49.28	217.8	51.91	223.5	52.69	229.9	53.12		
	31	160.5	32.68	191.0	42.17	208.7	47.34	212.2	52.78	215.1	55.69	220.8	56.67	226.2	57.13		
	33	160.5	34.79	191.0	44.94	205.8	50.06	208.7	57.30	211.5	59.80	217.1	60.48	222.8	60.96		
	35	160.5	36.98	191.0	47.90	202.3	53.00	205.1	63.13	208.7	63.44	214.4	63.63	220.0	64.14		
	37	160.5	39.79	191.0	50.55	199.4	56.50	202.3	61.79	205.1	62.11	210.7	62.30	216.6	62.79		
	39	160.5	42.83	190.3	53.44	195.9	59.92	198.9	60.53	201.6	60.84	208.0	61.01	213.7	61.50		
	41	156.5	45.89	181.9	56.30	188.1	58.75	190.8	59.26	193.5	59.56	199.1	59.73	204.8	60.21		
	43	152.6	48.97	174.3	55.50	180.4	57.44	182.9	57.98	185.6	58.27	191.2	58.46	196.7	58.92		
	46	143.0	52.66	159.0	54.19	164.7	55.62	167.1	56.08	169.8	56.37	174.8	56.54	180.0	56.98		
	48	126.5	51.57	138.1	53.22	143.2	54.55	145.5	54.87	147.7	55.04	152.1	55.26	156.8	55.50		
110	10	143.8	17.34	171.6	21.12	191.5	25.10	197.2	27.17	209.5	29.23	214.4	30.06	228.9	30.54		
	12	143.8	17.87	171.6	21.85	191.5	26.15	197.2	27.92	209.5	30.33	214.4	31.32	228.9	32.03		
	14	143.8	18.43	171.6	22.82	191.5	27.32	197.2	29.31	209.5	31.86	214.4	32.77	228.9	33.46		
	16	143.8	19.08	171.6	23.65	191.5	28.45	197.2	30.59	209.5	33.33	214.4	34.23	228.9	34.84		
	18	143.8	19.79	171.6	24.64	191.5	30.08	197.2	32.22	209.5	35.16	214.4	35.86	228.9	36.52		
	20	143.8	20.49	171.6	25.88	191.5	31.90	197.2	33.70	209.5	36.86	214.4	37.78	228.9	38.38		
	21	143.8	20.95	171.6	26.63	191.5	32.73	197.2	34.60	209.5	37.90	214.4	38.85	228.9	39.45		
	23	143.8	22.33	171.6	28.55	191.5	34.55	197.2	36.54	209.5	40.04	214.4	40.89	228.9	41.57		
	25	143.8	23.87	171.6	30.47	191.5	36.51	197.2	38.63	209.5	42.29	214.4	42.90	226.2	43.78		
	27	143.8	25.49	171.6	32.58	191.5	38.58	197.2	40.88	209.5	44.16	214.4	45.18	222.8	45.96		
	29	143.8	27.22	171.6	34.79	191.5	40.76	197.2	43.29	209.5	46.69	214.4	47.49	220.0	48.20		
	31	143.8	28.94	171.6	37.08	191.5	43.07	197.2	45.86	206.1	49.04	211.7	50.01	216.6	50.53		
	33	143.8	30.86	171.6	39.48	191.5	45.52	197.2	48.61	203.3	51.79	208.2	52.66	213.7	52.95		
	35	143.8	32.78	171.6	42.17	191.5	48.07	197.2	51.50	199.9	54.67	204.8	55.16	210.2	55.45		
	37	143.8	34.74	171.6	44.75	191.5	50.74	194.4	54.56	196.4	57.66	202.1	57.86	206.8	58.03		
	39	143.8	37.44	171.6	47.56	188.1	53.54	190.8	58.37	193.7	60.50	198.4	60.62	204.1	60.67		
	41	140.3	40.16	167.1	50.35	180.2	56.47	182.9	63.13	185.3	63.13	190.8	63.63	195.4	64.14		
	43	136.6	42.17	163.0	52.47	172.6	59.87	175.5	60.55	177.7	60.43	182.9	60.77	187.6	60.94		
	46	128.2	41.15	152.8	50.65	157.5	56.83	160.2	56.83	162.2	57.32	167.2	57.64	171.6	57.78		
	48	113.3	39.96	132.7	48.80	136.8	54.07	139.3	54.43	141.1	54.70	145.5	54.85	149.2	55.06		

Note

1. TC: Total Capacity(kW), PI : Power Input(kW, Comp. + Outdoor fan motor)
2. Capacity tables show the average value of conditions which may occur.

7. Capacity Tables

Combination (%)	Outdoor air temp (°C DB)	Cooling Capacity(64HP)													
		Indoor air temp. (DB/WB, °C)													
		20		23		26		27		28		30		32	
		14	16	18	19	20	22	24	TC	PI	TC	PI	TC	PI	
100	10	120.9	15.61	144.0	18.96	167.6	22.51	179.2	24.33	190.8	26.13	211.4	29.09	216.1	29.33
	12	120.9	16.12	144.0	19.74	167.6	23.26	179.2	24.98	190.8	26.97	211.4	30.66	216.1	30.96
	14	120.9	16.61	144.0	20.54	167.6	24.25	179.2	26.05	190.8	28.14	211.4	32.36	216.1	32.68
	16	120.9	17.12	144.0	21.22	167.6	25.28	179.2	27.29	190.8	29.64	211.4	33.94	216.1	34.40
	18	120.9	17.63	144.0	22.00	167.6	26.27	179.2	28.62	190.8	31.44	211.4	35.86	216.1	36.13
	20	120.9	18.26	144.0	22.84	167.6	27.80	179.2	30.66	190.8	33.63	211.4	37.56	216.1	37.87
	21	120.9	18.64	144.0	23.38	167.6	28.75	179.2	31.71	190.8	34.89	211.4	38.43	216.1	38.73
	23	120.9	19.74	144.0	25.01	167.6	30.86	179.2	34.02	190.8	37.37	211.4	40.23	216.1	40.57
	25	120.9	20.98	144.0	26.63	167.6	32.97	179.2	36.42	190.8	39.96	211.4	41.95	214.2	42.29
	27	120.9	22.43	144.0	28.46	167.6	35.25	179.2	38.90	190.8	42.49	207.3	43.92	211.7	44.28
	29	120.9	23.87	144.0	30.37	167.6	37.66	179.2	41.59	190.8	44.96	203.6	45.69	208.5	46.06
	31	120.9	25.49	144.0	32.39	167.6	40.16	179.2	44.36	190.8	47.25	200.4	47.46	205.3	47.85
	33	120.9	27.02	144.0	34.50	167.6	42.83	179.2	47.34	190.8	49.02	197.2	49.24	202.1	49.63
	35	120.9	28.75	144.0	36.71	167.6	45.62	179.2	50.50	187.8	50.79	193.7	51.01	198.6	51.40
	37	120.9	30.79	144.0	39.36	167.6	48.32	179.2	52.90	184.6	53.17	190.0	53.39	194.5	53.87
	39	120.9	33.02	144.0	42.29	167.6	51.20	179.2	55.50	181.7	55.74	187.1	55.94	191.3	56.47
	41	119.1	35.23	141.8	45.21	164.9	54.09	172.0	58.08	175.7	58.32	179.9	58.51	185.6	59.07
	43	115.0	37.29	136.9	47.93	159.3	56.67	164.9	60.31	166.7	60.50	171.8	60.72	176.5	61.28
46	107.8	40.11	128.2	51.67	149.4	60.11	150.6	63.13	152.1	63.32	157.0	63.49	161.2	64.10	
48	95.3	34.62	113.5	44.70	129.0	51.38	130.7	53.56	132.2	53.73	136.6	53.85	140.3	54.29	
90	10	108.8	13.53	130.0	16.25	151.1	19.16	161.2	20.66	171.6	22.24	192.7	24.88	213.7	27.67
	12	108.8	13.68	130.0	16.51	151.1	19.50	161.2	21.07	171.6	22.72	192.7	25.37	213.7	28.16
	14	108.8	13.94	130.0	16.83	151.1	19.91	161.2	21.49	171.6	23.14	192.7	25.87	213.7	28.74
	16	108.8	14.19	130.0	17.17	151.1	20.32	161.2	21.90	171.6	23.57	192.7	26.36	213.7	29.22
	18	108.8	14.43	130.0	17.51	151.1	20.66	161.2	22.41	171.6	24.06	192.7	26.94	213.7	30.70
	20	108.8	14.67	130.0	17.83	151.1	21.07	161.2	22.82	171.6	24.98	192.7	28.83	213.7	32.16
	21	108.8	14.84	130.0	18.00	151.1	21.49	161.2	23.57	171.6	25.88	192.7	29.30	213.7	32.91
	23	108.8	15.18	130.0	18.75	151.1	22.99	161.2	25.29	171.6	27.72	192.7	31.07	210.7	34.46
	25	108.8	15.93	130.0	19.98	151.1	24.56	161.2	27.04	171.6	29.61	192.7	33.22	207.8	35.92
	27	108.8	17.00	130.0	21.32	151.1	26.21	161.2	28.86	171.6	31.69	192.7	35.31	204.8	37.61
	29	108.8	18.00	130.0	22.72	151.1	28.03	161.2	30.87	171.6	33.85	192.7	37.42	201.6	39.12
	31	108.8	19.16	130.0	24.23	151.1	29.87	161.2	32.86	171.6	36.09	192.7	39.28	198.6	40.64
	33	108.8	20.42	130.0	25.80	151.1	31.86	161.2	35.02	171.6	38.27	192.7	41.18	195.7	42.15
	35	108.8	21.66	130.0	27.38	151.1	33.85	161.2	37.32	171.6	40.59	189.3	43.53	192.5	44.55
	37	108.8	22.99	130.0	29.12	151.1	36.09	161.2	39.65	171.6	42.85	186.3	45.52	189.5	46.54
	39	108.8	24.32	130.0	30.97	151.1	38.20	161.2	42.20	171.6	45.06	183.2	47.99	186.4	48.57
	41	106.1	27.23	126.5	34.34	147.2	41.93	157.1	46.15	167.1	48.65	175.5	50.56	178.7	51.73
	43	103.4	29.39	123.5	37.10	143.5	45.79	153.3	49.71	163.0	52.16	168.4	54.15	171.3	54.81
46	97.0	33.08	115.7	42.25	134.4	52.19	143.7	56.36	148.2	57.94	153.6	59.44	156.6	59.53	
48	85.7	28.91	102.4	36.96	118.9	45.64	127.0	49.16	128.5	49.93	133.6	51.17	136.1	51.24	
80	10	96.7	11.34	115.2	13.64	133.7	16.00	143.3	17.27	152.9	18.52	171.6	21.13	190.0	22.93
	12	96.7	11.59	115.2	13.78	133.7	16.32	143.3	17.57	152.9	18.83	171.6	21.52	190.0	23.39
	14	96.7	11.74	115.2	14.10	133.7	16.54	143.3	17.88	152.9	19.15	171.6	21.91	190.0	23.83
	16	96.7	11.90	115.2	14.34	133.7	16.86	143.3	18.20	152.9	19.54	171.6	22.39	190.0	24.30
	18	96.7	12.15	115.2	14.59	133.7	17.18	143.3	18.52	152.9	19.93	171.6	22.78	190.0	24.83
	20	96.7	12.37	115.2	14.90	133.7	17.57	143.3	18.91	152.9	20.34	171.6	23.64	190.0	26.30
	21	96.7	12.44	115.2	15.05	133.7	17.73	143.3	19.15	152.9	20.81	171.6	24.39	190.0	27.00
	23	96.7	12.69	115.2	15.29	133.7	18.52	143.3	20.34	152.9	22.22	171.6	25.76	190.0	28.34
	25	96.7	13.17	115.2	16.32	133.7	19.86	143.3	21.76	152.9	23.81	171.6	27.56	190.0	30.30
	27	96.7	13.95	115.2	17.34	133.7	21.20	143.3	23.25	152.9	25.37	171.6	29.28	190.0	31.88
	29	96.7	14.81	115.2	18.52	133.7	22.54	143.3	24.76	152.9	27.10	171.6	31.37	190.0	34.13
	31	96.7	15.76	115.2	19.62	133.7	24.03	143.3	26.40	152.9	28.86	171.6	33.30	190.0	35.83
	33	96.7	16.71	115.2	20.96	133.7	25.61	143.3	28.13	152.9	30.74	171.6	35.08	190.0	37.57
	35	96.7	17.73	115.2	22.22	133.7	27.27	143.3	29.96	152.9	32.79	171.6	37.20	188.1	38.93
	37	96.7	18.76	115.2	23.64	133.7	28.93	143.3	31.84	152.9	34.84	171.6	39.25	185.1	40.69
	39	96.7	19.83	115.2	24.98	133.7	30.93	143.3	34.23	152.9	37.44	171.6	41.47	181.9	42.93
	41	94.3	21.93	112.2	27.69	130.2	33.96	139.6	37.52	148.9	41.13	167.1	46.16	174.3	47.57
	43	91.8	24.15	109.5	30.20	127.0	37.08	136.1	40.89	145.5	44.96	163.0	49.40	167.1	50.94
46	86.1	26.86	102.6	34.03	119.1	41.76	127.7	45.52	136.1	50.72	149.1	53.91	152.6	54.79	
48	76.1	23.47	90.8	29.76	105.4	36.52	113.0	39.76	120.6	44.40	129.5	46.67	132.7	47.16	

Note

1. TC: Total Capacity(kW), PI : Power Input(kW, Comp. + Outdoor fan motor)
2. Capacity tables show the average value of conditions which may occur.

7. Capacity Tables

Combination (%)	Outdoor air temp (°C DB)	Cooling Capacity(64HP)													
		Indoor air temp. (DB/WB, °C)													
		20		23		26		27		28		30		32	
		14	16	18	19	20	22	24							
	TC	PI	TC	PI	TC	PI	TC	PI	TC	PI	TC	PI	TC	PI	
70	10	84.4	9.99	101.2	11.88	117.2	13.77	125.5	14.87	133.7	15.88	149.7	18.09	166.4	20.22
	12	84.4	10.14	101.2	12.03	117.2	14.06	125.5	15.09	133.7	16.20	149.7	18.40	166.4	20.61
	14	84.4	10.31	101.2	12.19	117.2	14.31	125.5	15.34	133.7	16.44	149.7	18.80	166.4	20.98
	16	84.4	10.45	101.2	12.42	117.2	14.55	125.5	15.66	133.7	16.74	149.7	19.12	166.4	21.43
	18	84.4	10.62	101.2	12.66	117.2	14.87	125.5	15.95	133.7	17.06	149.7	19.41	166.4	21.82
	20	84.4	10.77	101.2	12.89	117.2	15.09	125.5	16.27	133.7	17.45	149.7	19.90	166.4	22.65
	21	84.4	10.92	101.2	12.98	117.2	15.26	125.5	16.44	133.7	17.62	149.7	20.20	166.4	23.12
	23	84.4	11.09	101.2	13.28	117.2	15.56	125.5	16.98	133.7	18.48	149.7	21.62	166.4	24.42
	25	84.4	11.24	101.2	13.77	117.2	16.59	125.5	18.16	133.7	19.73	149.7	23.12	166.4	25.60
	27	84.4	11.88	101.2	14.70	117.2	17.69	125.5	19.26	133.7	21.08	149.7	24.69	166.4	27.21
	29	84.4	12.66	101.2	15.56	117.2	18.80	125.5	20.52	133.7	22.41	149.7	26.33	166.4	29.15
	31	84.4	13.45	101.2	16.59	117.2	20.05	125.5	21.94	133.7	23.90	149.7	28.07	166.4	30.92
	33	84.4	14.23	101.2	17.52	117.2	21.30	125.5	23.27	133.7	25.40	149.7	29.87	166.4	32.93
	35	84.4	15.02	101.2	18.72	117.2	22.65	125.5	24.76	133.7	27.04	149.7	31.85	166.4	34.92
	37	84.4	15.95	101.2	19.83	117.2	24.05	125.5	26.33	133.7	28.78	149.7	33.89	166.4	36.84
	39	84.4	16.96	101.2	21.13	117.2	25.72	125.5	28.34	133.7	31.09	149.7	36.27	166.4	39.73
	41	82.2	18.75	98.5	23.14	114.2	28.22	122.3	31.09	130.2	33.79	146.0	39.83	162.2	42.85
	43	80.3	20.39	96.0	25.23	111.3	30.80	119.2	33.89	127.0	36.91	142.3	43.51	158.0	46.33
46	75.3	22.67	90.1	28.37	104.4	34.68	111.7	37.75	119.1	41.60	133.4	49.08	148.2	51.64	
48	66.5	19.78	79.7	24.79	92.3	30.31	98.7	32.98	105.4	36.39	117.9	42.95	131.2	44.69	
60	10	72.4	8.62	86.4	10.12	100.4	11.77	107.6	12.62	114.5	13.41	128.7	15.21	142.8	17.01
	12	72.4	8.79	86.4	10.27	100.4	11.92	107.6	12.79	114.5	13.65	128.7	15.45	142.8	17.33
	14	72.4	8.86	86.4	10.44	100.4	12.15	107.6	13.01	114.5	13.88	128.7	15.77	142.8	17.65
	16	72.4	9.01	86.4	10.67	100.4	12.32	107.6	13.26	114.5	14.20	128.7	16.07	142.8	17.95
	18	72.4	9.18	86.4	10.82	100.4	12.54	107.6	13.48	114.5	14.44	128.7	16.32	142.8	18.35
	20	72.4	9.33	86.4	10.99	100.4	12.79	107.6	13.73	114.5	14.67	128.7	16.62	142.8	18.74
	21	72.4	9.41	86.4	11.06	100.4	12.94	107.6	13.88	114.5	14.82	128.7	16.86	142.8	18.91
	23	72.4	9.58	86.4	11.29	100.4	13.11	107.6	14.12	114.5	15.14	128.7	17.48	142.8	20.07
	25	72.4	9.73	86.4	11.53	100.4	13.65	107.6	14.82	114.5	16.07	128.7	18.67	142.8	21.48
	27	72.4	10.05	86.4	12.15	100.4	14.52	107.6	15.77	114.5	17.11	128.7	19.85	142.8	22.91
	29	72.4	10.67	86.4	12.94	100.4	15.45	107.6	16.79	114.5	18.20	128.7	21.18	142.8	24.47
	31	72.4	11.29	86.4	13.73	100.4	16.39	107.6	17.88	114.5	19.38	128.7	22.59	142.8	26.05
	33	72.4	11.92	86.4	14.52	100.4	17.41	107.6	18.99	114.5	20.62	128.7	24.00	142.8	27.77
	35	72.4	12.62	86.4	15.45	100.4	18.52	107.6	20.15	114.5	21.88	128.7	25.58	142.8	29.48
	37	72.4	13.33	86.4	16.30	100.4	19.60	107.6	21.41	114.5	23.21	128.7	27.13	142.8	31.38
	39	72.4	14.17	86.4	17.36	100.4	21.16	107.6	22.96	114.5	24.99	128.7	29.11	142.8	33.63
	41	70.4	15.38	84.2	19.01	98.0	22.99	104.8	25.09	111.5	27.11	125.3	31.93	139.1	36.54
	43	68.7	16.71	82.2	20.69	95.5	25.06	102.2	27.35	108.8	29.58	122.3	34.86	135.6	39.90
46	64.5	18.72	77.0	23.23	89.6	28.17	95.8	30.74	101.9	33.28	114.5	39.28	127.0	45.46	
48	56.9	16.32	68.2	20.27	79.2	24.62	84.7	26.84	90.3	29.08	101.4	34.35	112.5	39.78	
50	10	60.5	7.43	72.4	8.60	83.9	9.79	89.6	10.48	95.3	11.11	106.8	12.52	119.1	13.93
	12	60.5	7.50	72.4	8.69	83.9	9.94	89.6	10.63	95.3	11.35	106.8	12.75	119.1	14.16
	14	60.5	7.60	72.4	8.84	83.9	10.09	89.6	10.80	95.3	11.50	106.8	12.92	119.1	14.41
	16	60.5	7.75	72.4	8.99	83.9	10.26	89.6	11.03	95.3	11.65	106.8	13.14	119.1	14.63
	18	60.5	7.82	72.4	9.07	83.9	10.41	89.6	11.18	95.3	11.90	106.8	13.39	119.1	14.95
	20	60.5	7.90	72.4	9.24	83.9	10.63	89.6	11.35	95.3	12.12	106.8	13.61	119.1	15.25
	21	60.5	7.98	72.4	9.31	83.9	10.73	89.6	11.50	95.3	12.20	106.8	13.76	119.1	15.40
	23	60.5	8.15	72.4	9.47	83.9	10.88	89.6	11.65	95.3	12.44	106.8	14.01	119.1	15.72
	25	60.5	8.22	72.4	9.62	83.9	11.11	89.6	11.90	95.3	12.84	106.8	14.71	119.1	16.82
	27	60.5	8.37	72.4	9.94	83.9	11.73	89.6	12.67	95.3	13.61	106.8	15.72	119.1	17.91
	29	60.5	8.84	72.4	10.56	83.9	12.44	89.6	13.46	95.3	14.48	106.8	16.67	119.1	19.01
	31	60.5	9.31	72.4	11.18	83.9	13.22	89.6	14.24	95.3	15.40	106.8	17.76	119.1	20.27
	33	60.5	9.86	72.4	11.82	83.9	14.01	89.6	15.10	95.3	16.35	106.8	18.85	119.1	21.59
	35	60.5	10.41	72.4	12.52	83.9	14.78	89.6	16.05	95.3	17.29	106.8	19.95	119.1	22.93
	37	60.5	11.03	72.4	13.22	83.9	15.65	89.6	16.97	95.3	18.31	106.8	21.29	119.1	24.34
	39	60.5	11.77	72.4	14.18	83.9	16.77	89.6	18.28	95.3	19.65	106.8	22.68	119.1	26.28
	41	58.8	12.72	70.4	15.35	81.7	18.33	87.4	19.80	92.8	21.29	104.1	24.84	115.9	28.54
	43	57.4	13.84	68.7	16.69	79.7	19.95	85.2	21.56	90.6	23.18	101.6	27.10	113.2	31.13
46	53.9	15.50	64.5	18.73	74.6	22.38	79.8	24.20	84.9	26.01	95.2	30.48	106.1	35.05	
48	47.7	13.49	56.9	16.32	66.0	19.52	70.6	21.12	75.1	22.70	84.2	26.63	93.8	30.63	

Note

1. TC: Total Capacity(kW), PI : Power Input(kW, Comp. + Outdoor fan motor)
2. Capacity tables show the average value of conditions which may occur.

7. Capacity Tables

◆ A(C)RUN660LLS5

Combination (%)	Outdoor air temp (°C DB)	Indoor air temp. (DB/WB, °C)														Cooling Capacity(66HP)	
		20		23		26		27		28		30		32		TC	PI
		14		16		18		19		20		22		24			
		TC	PI	TC	PI	TC	PI	TC	PI	TC	PI	TC	PI	TC	PI		
130	10	183.0	22.14	218.0	27.06	233.6	31.40	240.4	32.02	247.0	32.30	258.9	32.55	265.5	32.67		
	12	183.0	22.69	218.0	28.03	233.6	32.68	240.4	32.90	247.0	33.15	258.9	33.43	265.5	33.73		
	14	183.0	23.46	218.0	29.04	233.6	33.91	240.4	34.16	247.0	34.43	258.9	34.71	265.5	35.01		
	16	183.0	24.32	218.0	30.06	233.6	35.44	240.4	35.76	247.0	36.04	258.9	36.37	265.5	36.66		
	18	183.0	25.32	218.0	31.80	233.6	37.07	240.4	37.87	247.0	38.17	258.9	38.55	265.5	38.80		
	20	183.0	26.45	218.0	33.88	233.6	38.90	240.4	41.64	247.0	41.98	255.1	42.39	261.9	42.69		
	21	183.0	27.13	218.0	35.06	233.6	39.70	240.4	44.07	247.0	44.42	253.8	44.87	260.4	45.17		
	23	183.0	29.11	218.0	36.89	233.6	41.76	240.4	48.63	243.9	49.01	250.0	49.51	256.6	49.84		
	25	183.0	31.10	218.0	39.00	233.6	44.62	237.4	53.93	240.4	54.36	247.0	54.91	253.8	55.29		
	27	183.0	33.28	218.0	41.71	230.7	47.56	233.6	59.38	237.4	59.85	243.9	60.43	250.0	60.86		
	29	183.0	35.46	218.0	44.57	226.9	51.17	230.2	65.25	233.6	65.65	240.4	66.23	247.0	66.48		
	31	183.0	37.84	217.3	46.96	223.1	54.43	226.9	64.97	230.2	65.37	236.6	65.95	243.2	66.21		
	33	183.0	40.31	213.5	49.76	220.3	58.37	223.9	64.37	226.9	64.77	233.6	65.35	239.6	65.60		
	35	183.0	42.99	209.7	52.10	216.5	63.22	220.3	63.54	223.9	63.92	230.0	64.50	236.6	64.75		
	37	183.0	45.85	206.9	54.68	213.5	62.39	216.5	62.71	220.3	63.09	226.2	63.64	233.0	63.90		
	39	183.0	48.81	203.1	57.55	209.7	61.56	213.5	61.86	216.5	62.24	223.1	62.79	230.0	63.04		
	41	178.4	51.78	194.7	60.43	201.3	60.73	204.3	61.03	208.4	61.39	214.5	61.94	220.3	62.19		
	43	173.9	54.61	186.6	59.58	193.2	59.88	196.0	60.18	200.0	60.56	206.1	61.09	211.7	61.33		
46	163.0	58.45	170.3	58.35	176.4	58.63	179.2	58.93	182.8	59.28	188.6	59.81	193.9	60.05			
48	144.2	56.82	147.8	56.99	153.3	57.12	155.8	57.27	159.2	57.77	164.2	58.15	168.8	58.37			
120	10	165.5	19.93	197.0	24.42	215.3	29.03	221.8	31.37	228.2	31.87	240.7	32.00	246.5	32.25		
	12	165.5	20.45	197.0	25.25	215.3	30.19	221.8	32.02	228.2	33.05	240.7	33.45	246.5	33.71		
	14	165.5	21.16	197.0	26.10	215.3	31.42	221.8	33.25	228.2	34.26	240.7	34.76	246.5	35.04		
	16	165.5	21.93	197.0	27.18	215.3	32.63	221.8	34.48	228.2	35.84	240.7	36.29	246.5	36.57		
	18	165.5	22.79	197.0	28.41	215.3	33.93	221.8	36.31	228.2	37.67	240.7	38.10	246.5	38.42		
	20	165.5	23.64	197.0	30.11	215.3	35.76	221.8	38.20	228.2	39.68	240.7	40.20	246.5	40.51		
	21	165.5	24.37	197.0	31.20	215.3	36.76	221.8	39.33	228.2	40.98	240.7	41.51	246.5	41.83		
	23	165.5	26.05	197.0	33.38	215.3	39.38	221.8	41.79	228.2	43.69	240.7	44.12	246.5	44.47		
	25	165.5	27.83	197.0	35.76	215.3	41.54	221.8	44.55	228.2	46.85	237.9	47.23	243.7	47.61		
	27	165.5	29.71	197.0	38.22	215.3	44.22	221.8	47.61	228.2	50.34	234.3	50.69	240.1	51.09		
	29	165.5	31.70	197.0	40.81	215.3	46.53	221.8	50.94	224.7	53.66	230.5	54.46	237.1	54.91		
	31	165.5	33.78	197.0	43.59	215.3	48.94	218.8	54.56	221.8	57.57	227.7	58.58	233.3	59.05		
	33	165.5	35.96	197.0	46.45	212.2	51.75	215.3	59.23	218.1	61.81	223.9	62.51	229.7	63.01		
	35	165.5	38.22	197.0	49.52	208.7	54.78	211.5	65.25	215.3	65.58	221.1	65.78	226.9	66.30		
	37	165.5	41.13	197.0	52.25	205.6	58.40	208.7	63.87	211.5	64.20	217.3	64.40	223.4	64.90		
	39	165.5	44.27	196.2	55.24	202.1	61.94	205.1	62.56	207.9	62.89	214.5	63.07	220.3	63.57		
	41	161.4	47.43	187.6	58.20	194.0	60.73	196.7	61.26	199.5	61.56	205.4	61.74	211.2	62.24		
	43	157.4	50.62	179.7	57.37	186.1	59.37	188.6	59.93	191.4	60.23	197.2	60.43	202.8	60.91		
46	147.5	54.43	164.0	56.01	169.8	57.50	172.4	57.97	175.1	58.27	180.2	58.45	185.6	58.90			
48	130.5	53.31	142.4	55.01	147.7	56.39	150.0	56.72	152.3	56.89	156.9	57.12	161.7	57.37			
110	10	148.3	17.92	176.9	21.84	197.5	25.95	203.3	28.08	216.0	30.22	221.1	31.07	236.1	31.57		
	12	148.3	18.47	176.9	22.58	197.5	27.03	203.3	28.86	216.0	31.35	221.1	32.37	236.1	33.10		
	14	148.3	19.05	176.9	23.59	197.5	28.24	203.3	30.29	216.0	32.93	221.1	33.88	236.1	34.58		
	16	148.3	19.73	176.9	24.45	197.5	29.41	203.3	31.62	216.0	34.46	221.1	35.39	236.1	36.01		
	18	148.3	20.46	176.9	25.47	197.5	31.10	203.3	33.30	216.0	36.34	221.1	37.07	236.1	37.75		
	20	148.3	21.18	176.9	26.75	197.5	32.98	203.3	34.83	216.0	38.10	221.1	39.05	236.1	39.68		
	21	148.3	21.66	176.9	27.53	197.5	33.83	203.3	35.76	216.0	39.17	221.1	40.15	236.1	40.78		
	23	148.3	23.09	176.9	29.51	197.5	35.71	203.3	37.77	216.0	41.38	221.1	42.26	236.1	42.96		
	25	148.3	24.67	176.9	31.50	197.5	37.74	203.3	39.93	216.0	43.72	221.1	44.34	233.3	45.25		
	27	148.3	26.35	176.9	33.68	197.5	39.88	203.3	42.26	216.0	45.65	221.1	46.70	229.7	47.50		
	29	148.3	28.13	176.9	35.96	197.5	42.14	203.3	44.75	216.0	48.26	221.1	49.09	226.9	49.82		
	31	148.3	29.91	176.9	38.32	197.5	44.52	203.3	47.41	212.5	50.70	218.3	51.70	223.4	52.23		
	33	148.3	31.90	176.9	40.81	197.5	47.05	203.3	50.24	209.7	53.53	214.7	54.43	220.3	54.73		
	35	148.3	33.88	176.9	43.59	197.5	49.69	203.3	53.23	206.1	56.51	211.2	57.02	216.8	57.32		
	37	148.3	35.91	176.9	46.25	197.5	52.45	200.5	56.39	202.6	59.60	208.4	59.80	213.2	59.98		
	39	148.3	38.70	176.9	49.16	194.0	55.34	196.8	60.33	199.8	62.54	204.6	62.66	210.4	62.72		
	41	144.7	41.51	172.4	52.05	185.8	58.37	188.6	65.25	191.1	65.25	196.7	65.78	201.5	66.30		
	43	140.9	43.59	168.1	54.23	177.9	61.89	181.0	62.59	183.3	62.46	188.6	62.81	193.4	62.99		
46	132.2	42.54	157.6	52.35	162.4	58.75	165.2	58.75	167.3	59.25	172.4	59.58	176.9	59.73			
48	116.8	41.31	136.8	50.44	141.1	55.89	143.7	56.26	145.5	56.54	150.0	56.69	153.9	56.92			

Note

1. TC: Total Capacity(kW), PI : Power Input(kW, Comp. + Outdoor fan motor)
2. Capacity tables show the average value of conditions which may occur.

7. Capacity Tables

Combination (%)	Outdoor air temp (°C DB)	Cooling Capacity(66HP)													
		Indoor air temp. (DB/WB, °C)													
		20		23		26		27		28		30		32	
		14	16	18	19	20	22	24	TC	PI	TC	PI	TC	PI	
100	10	124.7	16.14	148.5	19.60	172.9	23.26	184.8	25.14	196.7	27.01	218.1	30.07	222.9	30.31
	12	124.7	16.66	148.5	20.41	172.9	24.04	184.8	25.82	196.7	27.88	218.1	31.69	222.9	32.00
	14	124.7	17.17	148.5	21.23	172.9	25.07	184.8	26.93	196.7	29.08	218.1	33.45	222.9	33.78
	16	124.7	17.69	148.5	21.93	172.9	26.13	184.8	28.21	196.7	30.64	218.1	35.08	222.9	35.56
	18	124.7	18.22	148.5	22.74	172.9	27.15	184.8	29.59	196.7	32.50	218.1	37.06	222.9	37.35
	20	124.7	18.87	148.5	23.61	172.9	28.73	184.8	31.70	196.7	34.76	218.1	38.83	222.9	39.15
	21	124.7	19.27	148.5	24.17	172.9	29.71	184.8	32.78	196.7	36.06	218.1	39.73	222.9	40.03
	23	124.7	20.40	148.5	25.85	172.9	31.90	184.8	35.16	196.7	38.62	218.1	41.59	222.9	41.93
	25	124.7	21.68	148.5	27.53	172.9	34.08	184.8	37.64	196.7	41.31	218.1	43.37	220.9	43.72
	27	124.7	23.19	148.5	29.41	172.9	36.44	184.8	40.21	196.7	43.92	213.8	45.40	218.3	45.77
	29	124.7	24.67	148.5	31.40	172.9	38.92	184.8	42.99	196.7	46.48	209.9	47.23	215.0	47.61
	31	124.7	26.35	148.5	33.48	172.9	41.51	184.8	45.85	196.7	48.84	206.6	49.06	211.7	49.46
	33	124.7	27.93	148.5	35.66	172.9	44.27	184.8	48.94	196.7	50.67	203.3	50.89	208.4	51.30
	35	124.7	29.71	148.5	37.94	172.9	47.15	184.8	52.20	193.7	52.50	199.8	52.73	204.8	53.13
	37	124.7	31.82	148.5	40.68	172.9	49.94	184.8	54.68	190.4	54.96	196.0	55.18	200.6	55.69
	39	124.7	34.13	148.5	43.72	172.9	52.93	184.8	57.37	187.3	57.62	192.9	57.82	197.3	58.37
	41	122.8	36.41	146.2	46.73	170.1	55.91	177.4	60.03	181.2	60.28	185.5	60.48	191.4	61.06
	43	118.5	38.55	141.1	49.54	164.3	58.57	170.1	62.34	171.9	62.54	177.2	62.76	182.0	63.34
46	111.2	41.46	132.3	53.40	154.1	62.14	155.3	65.25	156.9	65.45	162.0	65.63	166.3	66.25	
48	98.2	35.79	117.0	46.20	133.0	53.11	134.8	55.36	136.3	55.54	140.9	55.66	144.7	56.11	
90	10	112.2	13.91	134.0	16.71	155.8	19.70	166.3	21.24	176.9	22.86	198.7	25.58	220.4	28.45
	12	112.2	14.07	134.0	16.98	155.8	20.05	166.3	21.67	176.9	23.37	198.7	26.08	220.4	28.95
	14	112.2	14.34	134.0	17.31	155.8	20.47	166.3	22.09	176.9	23.79	198.7	26.60	220.4	29.55
	16	112.2	14.59	134.0	17.65	155.8	20.90	166.3	22.52	176.9	24.23	198.7	27.10	220.4	30.05
	18	112.2	14.84	134.0	18.00	155.8	21.24	166.3	23.04	176.9	24.74	198.7	27.70	220.4	31.57
	20	112.2	15.09	134.0	18.33	155.8	21.67	166.3	23.46	176.9	25.68	198.7	29.65	220.4	33.07
	21	112.2	15.26	134.0	18.50	155.8	22.09	166.3	24.23	176.9	26.61	198.7	30.12	220.4	33.83
	23	112.2	15.61	134.0	19.28	155.8	23.64	166.3	26.01	176.9	28.50	198.7	31.94	217.3	35.43
	25	112.2	16.38	134.0	20.55	155.8	25.26	166.3	27.80	176.9	30.45	198.7	34.16	214.3	36.93
	27	112.2	17.48	134.0	21.92	155.8	26.95	166.3	29.67	176.9	32.59	198.7	36.31	211.2	38.67
	29	112.2	18.50	134.0	23.37	155.8	28.83	166.3	31.74	176.9	34.81	198.7	38.47	207.9	40.22
	31	112.2	19.70	134.0	24.91	155.8	30.72	166.3	33.79	176.9	37.10	198.7	40.39	204.9	41.79
	33	112.2	20.99	134.0	26.53	155.8	32.76	166.3	36.00	176.9	39.35	198.7	42.34	201.8	43.34
	35	112.2	22.27	134.0	28.15	155.8	34.81	166.3	38.38	176.9	41.74	195.2	44.76	198.5	45.80
	37	112.2	23.64	134.0	29.95	155.8	37.10	166.3	40.77	176.9	44.06	192.1	46.80	195.5	47.85
	39	112.2	25.01	134.0	31.84	155.8	39.27	166.3	43.39	176.9	46.33	188.9	49.35	192.2	49.94
	41	109.4	28.00	130.5	35.31	151.8	43.11	162.0	47.45	172.4	50.02	181.0	51.99	184.3	53.19
	43	106.6	30.22	127.4	38.15	148.0	47.08	158.1	51.11	168.1	53.63	173.6	55.68	176.7	56.35
46	100.0	34.01	119.3	43.44	138.6	53.66	148.2	57.95	152.8	59.57	158.4	61.12	161.4	61.21	
48	88.4	29.72	105.6	38.00	122.6	46.93	131.0	50.54	132.5	51.34	137.8	52.61	140.4	52.69	
80	10	99.7	11.61	118.8	13.96	137.9	16.38	147.8	17.68	157.7	18.96	176.9	21.63	196.0	23.48
	12	99.7	11.86	118.8	14.11	137.9	16.71	147.8	17.98	157.7	19.28	176.9	22.03	196.0	23.95
	14	99.7	12.01	118.8	14.44	137.9	16.93	147.8	18.31	157.7	19.60	176.9	22.43	196.0	24.40
	16	99.7	12.19	118.8	14.68	137.9	17.26	147.8	18.63	157.7	20.00	176.9	22.92	196.0	24.87
	18	99.7	12.43	118.8	14.93	137.9	17.58	147.8	18.96	157.7	20.41	176.9	23.32	196.0	25.42
	20	99.7	12.66	118.8	15.26	137.9	17.98	147.8	19.36	157.7	20.83	176.9	24.20	196.0	26.92
	21	99.7	12.74	118.8	15.41	137.9	18.16	147.8	19.60	157.7	21.30	176.9	24.97	196.0	27.64
	23	99.7	12.99	118.8	15.66	137.9	18.96	147.8	20.83	157.7	22.75	176.9	26.37	196.0	29.02
	25	99.7	13.48	118.8	16.71	137.9	20.33	147.8	22.27	157.7	24.37	176.9	28.22	196.0	31.02
	27	99.7	14.28	118.8	17.75	137.9	21.70	147.8	23.80	157.7	25.97	176.9	29.97	196.0	32.64
	29	99.7	15.16	118.8	18.96	137.9	23.08	147.8	25.35	157.7	27.75	176.9	32.12	196.0	34.94
	31	99.7	16.13	118.8	20.08	137.9	24.60	147.8	27.02	157.7	29.54	176.9	34.09	196.0	36.68
	33	99.7	17.11	118.8	21.45	137.9	26.22	147.8	28.80	157.7	31.47	176.9	35.91	196.0	38.46
	35	99.7	18.16	118.8	22.75	137.9	27.92	147.8	30.67	157.7	33.56	176.9	38.08	193.9	39.85
	37	99.7	19.20	118.8	24.20	137.9	29.62	147.8	32.59	157.7	35.66	176.9	40.18	190.9	41.66
	39	99.7	20.30	118.8	25.57	137.9	31.67	147.8	35.04	157.7	38.33	176.9	42.46	187.6	43.95
	41	97.2	22.45	115.8	28.34	134.3	34.76	144.0	38.41	153.6	42.11	172.4	47.25	179.7	48.70
	43	94.7	24.72	112.9	30.92	131.0	37.96	140.4	41.86	150.0	46.02	168.1	50.57	172.4	52.14
46	88.8	27.50	105.8	34.84	122.9	42.75	131.7	46.60	140.4	51.92	153.8	55.19	157.4	56.09	
48	78.5	24.02	93.7	30.47	108.7	37.39	116.5	40.70	124.4	45.45	133.5	47.77	136.8	48.27	

Note

1. TC: Total Capacity(kW), PI : Power Input(kW, Comp. + Outdoor fan motor)
2. Capacity tables show the average value of conditions which may occur.

7. Capacity Tables

Combination (%)	Outdoor air temp (°C DB)	Cooling Capacity(66HP)													
		Indoor air temp. (DB/WB, °C)													
		20		23		26		27		28		30		32	
		14	16	18	19	20	22	24	TC	PI	TC	PI	TC	PI	
70	10	87.1	10.18	104.3	12.10	120.8	14.03	129.4	15.15	137.9	16.18	154.4	18.43	171.6	20.61
	12	87.1	10.33	104.3	12.26	120.8	14.33	129.4	15.38	137.9	16.51	154.4	18.76	171.6	21.01
	14	87.1	10.50	104.3	12.43	120.8	14.58	129.4	15.63	137.9	16.76	154.4	19.16	171.6	21.39
	16	87.1	10.66	104.3	12.66	120.8	14.83	129.4	15.96	137.9	17.06	154.4	19.48	171.6	21.84
	18	87.1	10.83	104.3	12.91	120.8	15.15	129.4	16.26	137.9	17.38	154.4	19.79	171.6	22.23
	20	87.1	10.98	104.3	13.13	120.8	15.38	129.4	16.58	137.9	17.78	154.4	20.28	171.6	23.08
	21	87.1	11.13	104.3	13.23	120.8	15.56	129.4	16.76	137.9	17.96	154.4	20.59	171.6	23.56
	23	87.1	11.30	104.3	13.53	120.8	15.86	129.4	17.31	137.9	18.83	154.4	22.04	171.6	24.89
	25	87.1	11.46	104.3	14.03	120.8	16.91	129.4	18.51	137.9	20.11	154.4	23.56	171.6	26.09
	27	87.1	12.10	104.3	14.98	120.8	18.03	129.4	19.63	137.9	21.48	154.4	25.16	171.6	27.74
	29	87.1	12.91	104.3	15.86	120.8	19.16	129.4	20.91	137.9	22.84	154.4	26.84	171.6	29.71
	31	87.1	13.71	104.3	16.91	120.8	20.43	129.4	22.36	137.9	24.36	154.4	28.61	171.6	31.52
	33	87.1	14.51	104.3	17.86	120.8	21.71	129.4	23.71	137.9	25.89	154.4	30.44	171.6	33.56
	35	87.1	15.31	104.3	19.08	120.8	23.08	129.4	25.24	137.9	27.56	154.4	32.46	171.6	35.59
	37	87.1	16.26	104.3	20.21	120.8	24.51	129.4	26.84	137.9	29.34	154.4	34.54	171.6	37.54
	39	87.1	17.28	104.3	21.54	120.8	26.21	129.4	28.89	137.9	31.69	154.4	36.97	171.6	40.49
	41	84.8	19.11	101.6	23.59	117.8	28.76	126.1	31.69	134.3	34.44	150.5	40.59	167.3	43.67
	43	82.8	20.79	99.0	25.71	114.7	31.39	122.9	34.54	131.0	37.62	146.7	44.35	163.0	47.22
46	77.7	23.11	92.9	28.91	107.6	35.34	115.2	38.47	122.9	42.40	137.6	50.02	152.8	52.63	
48	68.6	20.16	82.2	25.26	95.2	30.89	101.8	33.62	108.7	37.09	121.6	43.77	135.3	45.55	
60	10	74.6	8.75	89.1	10.27	103.6	11.95	110.9	12.80	118.1	13.60	132.7	15.43	147.2	17.26
	12	74.6	8.92	89.1	10.42	103.6	12.10	110.9	12.98	118.1	13.85	132.7	15.68	147.2	17.59
	14	74.6	8.99	89.1	10.59	103.6	12.33	110.9	13.20	118.1	14.08	132.7	16.01	147.2	17.91
	16	74.6	9.15	89.1	10.82	103.6	12.50	110.9	13.45	118.1	14.40	132.7	16.31	147.2	18.21
	18	74.6	9.32	89.1	10.97	103.6	12.73	110.9	13.68	118.1	14.65	132.7	16.56	147.2	18.61
	20	74.6	9.47	89.1	11.15	103.6	12.98	110.9	13.93	118.1	14.88	132.7	16.86	147.2	19.02
	21	74.6	9.55	89.1	11.22	103.6	13.13	110.9	14.08	118.1	15.03	132.7	17.11	147.2	19.19
	23	74.6	9.72	89.1	11.45	103.6	13.30	110.9	14.33	118.1	15.36	132.7	17.74	147.2	20.37
	25	74.6	9.87	89.1	11.70	103.6	13.85	110.9	15.03	118.1	16.31	132.7	18.94	147.2	21.80
	27	74.6	10.19	89.1	12.33	103.6	14.73	110.9	16.01	118.1	17.36	132.7	20.14	147.2	23.25
	29	74.6	10.82	89.1	13.13	103.6	15.68	110.9	17.03	118.1	18.46	132.7	21.49	147.2	24.83
	31	74.6	11.45	89.1	13.93	103.6	16.63	110.9	18.14	118.1	19.66	132.7	22.92	147.2	26.43
	33	74.6	12.10	89.1	14.73	103.6	17.66	110.9	19.26	118.1	20.92	132.7	24.35	147.2	28.18
	35	74.6	12.80	89.1	15.68	103.6	18.79	110.9	20.44	118.1	22.20	132.7	25.95	147.2	29.91
	37	74.6	13.53	89.1	16.54	103.6	19.89	110.9	21.72	118.1	23.55	132.7	27.53	147.2	31.84
	39	74.6	14.38	89.1	17.61	103.6	21.47	110.9	23.30	118.1	25.35	132.7	29.53	147.2	34.12
	41	72.6	15.61	86.8	19.29	101.0	23.32	108.1	25.45	115.0	27.51	129.2	32.39	143.4	37.07
	43	70.8	16.96	84.8	20.99	98.5	25.43	105.4	27.75	112.2	30.01	126.1	35.37	139.9	40.48
46	66.5	18.99	79.4	23.57	92.4	28.59	98.7	31.19	105.1	33.77	118.1	39.86	131.0	46.12	
48	58.7	16.56	70.3	20.57	81.7	24.98	87.3	27.23	93.1	29.51	104.6	34.85	116.0	40.36	
50	10	62.4	7.50	74.6	8.68	86.5	9.88	92.4	10.59	98.3	11.22	110.2	12.65	122.8	14.07
	12	62.4	7.58	74.6	8.78	86.5	10.04	92.4	10.74	98.3	11.47	110.2	12.87	122.8	14.30
	14	62.4	7.68	74.6	8.93	86.5	10.19	92.4	10.91	98.3	11.62	110.2	13.05	122.8	14.55
	16	62.4	7.83	74.6	9.08	86.5	10.36	92.4	11.14	98.3	11.77	110.2	13.27	122.8	14.78
	18	62.4	7.90	74.6	9.16	86.5	10.51	92.4	11.29	98.3	12.02	110.2	13.52	122.8	15.10
	20	62.4	7.98	74.6	9.33	86.5	10.74	92.4	11.47	98.3	12.25	110.2	13.75	122.8	15.41
	21	62.4	8.06	74.6	9.41	86.5	10.84	92.4	11.62	98.3	12.32	110.2	13.90	122.8	15.56
	23	62.4	8.23	74.6	9.56	86.5	10.99	92.4	11.77	98.3	12.57	110.2	14.15	122.8	15.88
	25	62.4	8.30	74.6	9.71	86.5	11.22	92.4	12.02	98.3	12.97	110.2	14.85	122.8	16.99
	27	62.4	8.46	74.6	10.04	86.5	11.85	92.4	12.80	98.3	13.75	110.2	15.88	122.8	18.09
	29	62.4	8.93	74.6	10.66	86.5	12.57	92.4	13.60	98.3	14.63	110.2	16.84	122.8	19.20
	31	62.4	9.41	74.6	11.29	86.5	13.35	92.4	14.38	98.3	15.56	110.2	17.94	122.8	20.47
	33	62.4	9.96	74.6	11.94	86.5	14.15	92.4	15.25	98.3	16.51	110.2	19.04	122.8	21.81
	35	62.4	10.51	74.6	12.65	86.5	14.93	92.4	16.21	98.3	17.46	110.2	20.15	122.8	23.16
	37	62.4	11.14	74.6	13.35	86.5	15.81	92.4	17.14	98.3	18.49	110.2	21.50	122.8	24.59
	39	62.4	11.89	74.6	14.32	86.5	16.94	92.4	18.47	98.3	19.85	110.2	22.91	122.8	26.55
	41	60.7	12.85	72.6	15.50	84.3	18.52	90.1	20.00	95.7	21.50	107.4	25.09	119.6	28.83
	43	59.2	13.97	70.8	16.86	82.2	20.15	87.8	21.78	93.4	23.41	104.8	27.37	116.7	31.44
46	55.6	15.65	66.5	18.92	76.9	22.61	82.3	24.44	87.6	26.27	98.2	30.79	109.4	35.40	
48	49.2	13.63	58.7	16.49	68.0	19.72	72.8	21.33	77.4	22.93	86.8	26.90	96.7	30.94	

Note

1. TC: Total Capacity(kW), PI : Power Input(kW, Comp. + Outdoor fan motor)
2. Capacity tables show the average value of conditions which may occur.

7. Capacity Tables

◆ A(C)RUN680LLS5

Combination (%)	Outdoor air temp (°C DB)	Indoor air temp. (DB/WB, °C)														Cooling Capacity(68HP)	
		20		23		26		27		28		30		32		TC	PI
		14		16		18		19		20		22		24			
		TC	PI	TC	PI	TC	PI	TC	PI	TC	PI	TC	PI	TC	PI		
130	10	188.6	22.69	224.6	27.73	240.6	32.18	247.7	32.82	254.5	33.10	266.8	33.36	273.6	33.49		
	12	188.6	23.25	224.6	28.73	240.6	33.49	247.7	33.72	254.5	33.98	266.8	34.26	273.6	34.57		
	14	188.6	24.05	224.6	29.76	240.6	34.75	247.7	35.01	254.5	35.29	266.8	35.57	273.6	35.88		
	16	188.6	24.92	224.6	30.81	240.6	36.32	247.7	36.65	254.5	36.94	266.8	37.27	273.6	37.58		
	18	188.6	25.95	224.6	32.59	240.6	37.99	247.7	38.81	254.5	39.12	266.8	39.51	273.6	39.77		
	20	188.6	27.11	224.6	34.72	240.6	39.87	247.7	42.67	254.5	43.03	262.9	43.44	269.9	43.75		
	21	188.6	27.81	224.6	35.93	240.6	40.69	247.7	45.17	254.5	45.53	261.5	45.99	268.3	46.30		
	23	188.6	29.84	224.6	37.81	240.6	42.80	247.7	49.85	251.3	50.23	257.6	50.75	264.4	51.08		
	25	188.6	31.87	224.6	39.97	240.6	45.73	244.6	55.27	247.7	55.71	254.5	56.28	261.5	56.66		
	27	188.6	34.11	224.6	42.75	237.7	48.74	240.6	60.85	244.6	61.34	251.3	61.94	257.6	62.37		
	29	188.6	36.34	224.6	45.68	233.8	52.44	237.2	66.88	240.6	67.28	247.7	67.88	254.5	68.14		
	31	188.6	38.79	223.9	48.12	229.9	55.79	233.8	66.59	237.2	67.00	243.8	67.60	250.6	67.85		
	33	188.6	41.31	220.0	51.00	227.0	59.83	230.7	65.98	233.8	66.39	240.6	66.98	246.9	67.24		
	35	188.6	44.06	216.1	53.40	223.1	64.79	227.0	65.13	230.7	65.51	236.9	66.10	243.8	66.36		
	37	188.6	46.99	213.1	56.05	220.0	63.94	223.1	64.27	227.0	64.66	233.0	65.23	240.1	65.49		
	39	188.6	50.03	209.2	58.98	216.1	63.09	220.0	63.40	223.1	63.79	229.9	64.36	236.9	64.61		
	41	183.8	53.07	200.6	61.94	207.4	62.24	210.5	62.55	214.7	62.92	221.0	63.48	227.0	63.74		
	43	179.2	55.97	192.2	61.06	199.0	61.37	201.9	61.68	206.1	62.06	212.4	62.61	218.1	62.86		
46	167.9	59.91	175.5	59.80	181.8	60.09	184.6	60.39	188.3	60.75	194.3	61.30	199.8	61.55			
48	148.6	58.24	152.2	58.41	158.0	58.54	160.6	58.70	164.0	59.21	169.2	59.59	173.9	59.83			
120	10	170.6	20.42	202.9	25.03	221.8	29.76	228.6	32.15	235.2	32.66	248.0	32.79	254.0	33.05		
	12	170.6	20.96	202.9	25.88	221.8	30.94	228.6	32.82	235.2	33.87	248.0	34.28	254.0	34.55		
	14	170.6	21.68	202.9	26.75	221.8	32.20	228.6	34.08	235.2	35.11	248.0	35.62	254.0	35.91		
	16	170.6	22.48	202.9	27.86	221.8	33.44	228.6	35.34	235.2	36.73	248.0	37.19	254.0	37.48		
	18	170.6	23.35	202.9	29.11	221.8	34.78	228.6	37.22	235.2	38.61	248.0	39.05	254.0	39.38		
	20	170.6	24.23	202.9	30.86	221.8	36.65	228.6	39.15	235.2	40.66	248.0	41.20	254.0	41.52		
	21	170.6	24.97	202.9	31.97	221.8	37.68	228.6	40.31	235.2	42.00	248.0	42.54	254.0	42.88		
	23	170.6	26.70	202.9	34.21	221.8	40.36	228.6	42.83	235.2	44.78	248.0	45.22	254.0	45.58		
	25	170.6	28.53	202.9	36.65	221.8	42.57	228.6	45.66	235.2	48.02	245.1	48.41	251.1	48.80		
	27	170.6	30.45	202.9	39.18	221.8	45.32	228.6	48.79	235.2	51.60	241.4	51.95	247.4	52.37		
	29	170.6	32.49	202.9	41.82	221.8	47.69	228.6	52.21	231.5	54.99	237.5	55.82	244.3	56.28		
	31	170.6	34.62	202.9	44.68	221.8	50.15	225.5	55.92	228.6	59.00	234.6	60.03	240.4	60.52		
	33	170.6	36.86	202.9	47.61	218.7	53.04	221.8	60.70	224.7	63.35	230.7	64.07	236.7	64.58		
	35	170.6	39.18	202.9	50.75	215.0	56.15	217.9	66.88	221.8	67.21	227.8	67.41	233.8	67.95		
	37	170.6	42.16	202.9	53.55	211.9	59.85	215.0	65.46	217.9	65.80	223.9	66.00	230.1	66.52		
	39	170.6	45.37	202.2	56.61	208.2	63.48	211.3	64.12	214.2	64.45	221.0	64.64	227.0	65.15		
	41	166.3	48.61	193.3	59.65	199.8	62.24	202.7	62.78	205.6	63.09	211.6	63.28	217.6	63.79		
	43	162.2	51.88	185.2	58.80	191.7	60.85	194.4	61.42	197.2	61.73	203.2	61.93	209.0	62.42		
46	152.0	55.79	168.9	57.41	175.0	58.93	177.6	59.42	180.4	59.72	185.7	59.90	191.2	60.37			
48	134.4	54.63	146.7	56.38	152.2	57.79	154.5	58.13	156.9	58.31	161.6	58.54	166.6	58.80			
110	10	152.8	18.36	182.3	22.38	203.5	26.59	209.5	28.78	222.6	30.97	227.8	31.84	243.2	32.36		
	12	152.8	18.93	182.3	23.15	203.5	27.70	209.5	29.58	222.6	32.13	227.8	33.18	243.2	33.93		
	14	152.8	19.52	182.3	24.18	203.5	28.94	209.5	31.05	222.6	33.75	227.8	34.72	243.2	35.44		
	16	152.8	20.22	182.3	25.05	203.5	30.14	209.5	32.41	222.6	35.31	227.8	36.27	243.2	36.91		
	18	152.8	20.96	182.3	26.11	203.5	31.87	209.5	34.13	222.6	37.24	227.8	37.99	243.2	38.69		
	20	152.8	21.71	182.3	27.42	203.5	33.80	209.5	35.70	222.6	39.05	227.8	40.02	243.2	40.66		
	21	152.8	22.20	182.3	28.22	203.5	34.67	209.5	36.65	222.6	40.15	227.8	41.15	243.2	41.80		
	23	152.8	23.66	182.3	30.25	203.5	36.60	209.5	38.71	222.6	42.41	227.8	43.32	243.2	44.03		
	25	152.8	25.28	182.3	32.28	203.5	38.68	209.5	40.92	222.6	44.81	227.8	45.45	240.3	46.38		
	27	152.8	27.01	182.3	34.52	203.5	40.87	209.5	43.31	222.6	46.79	227.8	47.87	236.7	48.69		
	29	152.8	28.83	182.3	36.86	203.5	43.19	209.5	45.86	222.6	49.46	227.8	50.31	233.8	51.06		
	31	152.8	30.66	182.3	39.28	203.5	45.63	209.5	48.59	218.9	51.96	224.9	52.98	230.1	53.53		
	33	152.8	32.69	182.3	41.82	203.5	48.23	209.5	51.49	216.0	54.87	221.3	55.79	227.0	56.10		
	35	152.8	34.72	182.3	44.68	203.5	50.93	209.5	54.56	212.4	57.92	217.6	58.44	223.4	58.75		
	37	152.8	36.80	182.3	47.40	203.5	53.76	206.6	57.80	208.7	61.09	214.7	61.29	219.7	61.47		
	39	152.8	39.66	182.3	50.39	199.8	56.72	202.7	61.83	205.8	64.10	210.8	64.22	216.8	64.28		
	41	149.0	42.54	177.6	53.35	191.4	59.83	194.3	66.88	196.9	66.88	202.7	67.41	207.7	67.95		
	43	145.2	44.68	173.1	55.58	183.3	63.43	186.4	64.15	188.8	64.02	194.3	64.38	199.3	64.56		
46	136.2	43.60	162.4	53.65	167.4	60.21	170.2	60.21	172.4	60.73	177.6	61.06	182.3	61.22			
48	120.3	42.34	141.0	51.70	145.4	57.28	148.0	57.67	149.9	57.95	154.6	58.10	158.5	58.34			

Note

1. TC: Total Capacity(kW), PI : Power Input(kW, Comp. + Outdoor fan motor)
2. Capacity tables show the average value of conditions which may occur.

7. Capacity Tables

Combination (%)	Outdoor air temp (°C DB)	Cooling Capacity(68HP)													
		Indoor air temp. (DB/WB, °C)													
		20		23		26		27		28		30		32	
		14	16	18	19	20	22	24	TC	PI	TC	PI	TC	PI	
100	10	128.4	16.54	153.0	20.09	178.1	23.84	190.4	25.77	202.7	27.68	224.7	30.81	229.6	31.07
	12	128.4	17.08	153.0	20.91	178.1	24.64	190.4	26.47	202.7	28.57	224.7	32.48	229.6	32.79
	14	128.4	17.60	153.0	21.76	178.1	25.69	190.4	27.60	202.7	29.81	224.7	34.29	229.6	34.62
	16	128.4	18.13	153.0	22.48	178.1	26.78	190.4	28.91	202.7	31.41	224.7	35.96	229.6	36.45
	18	128.4	18.67	153.0	23.31	178.1	27.83	190.4	30.33	202.7	33.31	224.7	37.99	229.6	38.28
	20	128.4	19.34	153.0	24.20	178.1	29.45	190.4	32.49	202.7	35.63	224.7	39.79	229.6	40.12
	21	128.4	19.75	153.0	24.77	178.1	30.45	190.4	33.59	202.7	36.96	224.7	40.71	229.6	41.03
	23	128.4	20.91	153.0	26.49	178.1	32.69	190.4	36.04	202.7	39.59	224.7	42.62	229.6	42.98
	25	128.4	22.23	153.0	28.22	178.1	34.93	190.4	38.58	202.7	42.34	224.7	44.45	227.6	44.80
	27	128.4	23.76	153.0	30.15	178.1	37.35	190.4	41.21	202.7	45.01	220.2	46.53	224.9	46.91
	29	128.4	25.28	153.0	32.18	178.1	39.89	190.4	44.06	202.7	47.64	216.3	48.41	221.5	48.79
	31	128.4	27.01	153.0	34.31	178.1	42.54	190.4	46.99	202.7	50.05	212.9	50.28	218.1	50.69
	33	128.4	28.63	153.0	36.55	178.1	45.37	190.4	50.15	202.7	51.93	209.5	52.16	214.7	52.57
	35	128.4	30.45	153.0	38.89	178.1	48.33	190.4	53.50	199.6	53.81	205.8	54.04	211.0	54.45
	37	128.4	32.61	153.0	41.70	178.1	51.19	190.4	56.05	196.2	56.33	201.9	56.56	206.6	57.07
	39	128.4	34.98	153.0	44.80	178.1	54.24	190.4	58.80	193.0	59.05	198.7	59.26	203.2	59.83
	41	126.6	37.32	150.6	47.89	175.3	57.30	182.8	61.53	186.7	61.78	191.2	61.99	197.2	62.58
	43	122.1	39.51	145.4	50.77	169.2	60.03	175.2	63.89	177.1	64.10	182.6	64.33	187.5	64.92
46	114.5	42.49	136.3	54.73	158.7	63.68	160.0	66.88	161.6	67.08	166.9	67.26	171.3	67.90	
48	101.2	36.68	120.6	47.35	137.0	54.43	138.9	56.74	140.4	56.92	145.1	57.05	149.1	57.51	
90	10	115.6	14.24	138.1	17.11	160.6	20.17	171.3	21.75	182.3	23.41	204.8	26.19	227.0	29.13
	12	115.6	14.40	138.1	17.38	160.6	20.53	171.3	22.18	182.3	23.92	204.8	26.71	227.0	29.64
	14	115.6	14.68	138.1	17.72	160.6	20.96	171.3	22.62	182.3	24.36	204.8	27.24	227.0	30.25
	16	115.6	14.93	138.1	18.08	160.6	21.39	171.3	23.05	182.3	24.81	204.8	27.75	227.0	30.76
	18	115.6	15.19	138.1	18.43	160.6	21.75	171.3	23.59	182.3	25.33	204.8	28.36	227.0	32.32
	20	115.6	15.45	138.1	18.77	160.6	22.18	171.3	24.02	182.3	26.29	204.8	30.35	227.0	33.85
	21	115.6	15.63	138.1	18.95	160.6	22.62	171.3	24.81	182.3	27.24	204.8	30.84	227.0	34.64
	23	115.6	15.98	138.1	19.74	160.6	24.20	171.3	26.63	182.3	29.18	204.8	32.70	223.9	36.28
	25	115.6	16.77	138.1	21.04	160.6	25.86	171.3	28.47	182.3	31.17	204.8	34.98	220.7	37.81
	27	115.6	17.90	138.1	22.44	160.6	27.60	171.3	30.38	182.3	33.37	204.8	37.17	217.6	39.60
	29	115.6	18.95	138.1	23.92	160.6	29.51	171.3	32.50	182.3	35.64	204.8	39.39	214.2	41.18
	31	115.6	20.17	138.1	25.50	160.6	31.45	171.3	34.59	182.3	37.99	204.8	41.36	211.1	42.79
	33	115.6	21.49	138.1	27.16	160.6	33.54	171.3	36.86	182.3	40.29	204.8	43.35	207.9	44.37
	35	115.6	22.80	138.1	28.82	160.6	35.64	171.3	39.29	182.3	42.74	201.1	45.83	204.5	46.90
	37	115.6	24.20	138.1	30.66	160.6	37.99	171.3	41.74	182.3	45.11	198.0	47.92	201.4	48.99
	39	115.6	25.61	138.1	32.60	160.6	40.21	171.3	44.42	182.3	47.43	194.6	50.52	198.0	51.13
	41	112.7	28.67	134.4	36.15	156.4	44.14	166.9	48.58	177.6	51.21	186.5	53.23	189.9	54.46
	43	109.8	30.94	131.3	39.06	152.5	48.20	162.9	52.33	173.1	54.91	178.9	57.01	182.1	57.70
46	103.0	34.82	122.9	44.48	142.8	54.94	152.7	59.33	157.4	60.99	163.2	62.58	166.3	62.67	
48	91.0	30.43	108.8	38.91	126.3	48.05	135.0	51.75	136.6	52.57	142.0	53.87	144.6	53.94	
80	10	102.8	11.89	122.4	14.30	142.0	16.78	152.2	18.10	162.4	19.41	182.3	22.15	201.9	24.04
	12	102.8	12.15	122.4	14.45	142.0	17.11	152.2	18.42	162.4	19.74	182.3	22.56	201.9	24.52
	14	102.8	12.30	122.4	14.78	142.0	17.34	152.2	18.75	162.4	20.08	182.3	22.97	201.9	24.99
	16	102.8	12.48	122.4	15.04	142.0	17.67	152.2	19.08	162.4	20.49	182.3	23.47	201.9	25.47
	18	102.8	12.73	122.4	15.29	142.0	18.01	152.2	19.41	162.4	20.90	182.3	23.88	201.9	26.03
	20	102.8	12.97	122.4	15.62	142.0	18.42	152.2	19.82	162.4	21.33	182.3	24.78	201.9	27.57
	21	102.8	13.05	122.4	15.78	142.0	18.59	152.2	20.08	162.4	21.81	182.3	25.57	201.9	28.31
	23	102.8	13.30	122.4	16.03	142.0	19.41	152.2	21.33	162.4	23.30	182.3	27.00	201.9	29.72
	25	102.8	13.81	122.4	17.11	142.0	20.82	152.2	22.81	162.4	24.96	182.3	28.90	201.9	31.76
	27	102.8	14.63	122.4	18.18	142.0	22.22	152.2	24.37	162.4	26.60	182.3	30.69	201.9	33.42
	29	102.8	15.53	122.4	19.41	142.0	23.63	152.2	25.96	162.4	28.42	182.3	32.89	201.9	35.78
	31	102.8	16.52	122.4	20.56	142.0	25.19	152.2	27.67	162.4	30.25	182.3	34.91	201.9	37.57
	33	102.8	17.52	122.4	21.97	142.0	26.85	152.2	29.49	162.4	32.22	182.3	36.78	201.9	39.38
	35	102.8	18.59	122.4	23.30	142.0	28.59	152.2	31.40	162.4	34.37	182.3	39.00	199.8	40.81
	37	102.8	19.67	122.4	24.78	142.0	30.33	152.2	33.38	162.4	36.52	182.3	41.15	196.7	42.66
	39	102.8	20.79	122.4	26.19	142.0	32.43	152.2	35.88	162.4	39.25	182.3	43.48	193.3	45.01
	41	100.1	22.99	119.3	29.03	138.4	35.60	148.3	39.33	158.3	43.12	177.6	48.39	185.2	49.87
	43	97.6	25.32	116.4	31.66	135.0	38.87	144.7	42.86	154.5	47.13	173.1	51.79	177.6	53.40
46	91.5	28.16	109.0	35.68	126.6	43.78	135.7	47.72	144.7	53.17	158.5	56.52	162.1	57.44	
48	80.8	24.60	96.5	31.20	111.9	38.29	120.0	41.68	128.1	46.55	137.6	48.92	140.9	49.44	

Note

1. TC: Total Capacity(kW), PI : Power Input(kW, Comp. + Outdoor fan motor)
2. Capacity tables show the average value of conditions which may occur.

7. Capacity Tables

Combination (%)	Outdoor air temp (°C DB)	Cooling Capacity(68HP)													
		Indoor air temp. (DB/WB, °C)													
		20		23		26		27		28		30		32	
		14	16	18	19	20	22	24							
	TC	PI	TC	PI	TC	PI	TC	PI	TC	PI	TC	PI	TC	PI	
70	10	89.7	10.43	107.5	12.40	124.5	14.37	133.4	15.52	142.0	16.58	159.0	18.88	176.8	21.11
	12	89.7	10.58	107.5	12.55	124.5	14.68	133.4	15.76	142.0	16.91	159.0	19.21	176.8	21.52
	14	89.7	10.76	107.5	12.73	124.5	14.94	133.4	16.01	142.0	17.16	159.0	19.62	176.8	21.90
	16	89.7	10.91	107.5	12.96	124.5	15.19	133.4	16.34	142.0	17.47	159.0	19.95	176.8	22.37
	18	89.7	11.09	107.5	13.22	124.5	15.52	133.4	16.65	142.0	17.81	159.0	20.27	176.8	22.77
	20	89.7	11.25	107.5	13.45	124.5	15.76	133.4	16.99	142.0	18.22	159.0	20.77	176.8	23.64
	21	89.7	11.40	107.5	13.55	124.5	15.93	133.4	17.16	142.0	18.39	159.0	21.09	176.8	24.14
	23	89.7	11.58	107.5	13.86	124.5	16.24	133.4	17.73	142.0	19.29	159.0	22.57	176.8	25.49
	25	89.7	11.73	107.5	14.37	124.5	17.32	133.4	18.96	142.0	20.60	159.0	24.13	176.8	26.72
	27	89.7	12.40	107.5	15.35	124.5	18.47	133.4	20.11	142.0	22.00	159.0	25.77	176.8	28.41
	29	89.7	13.22	107.5	16.24	124.5	19.62	133.4	21.42	142.0	23.39	159.0	27.49	176.8	30.43
	31	89.7	14.04	107.5	17.32	124.5	20.93	133.4	22.90	142.0	24.95	159.0	29.31	176.8	32.28
	33	89.7	14.86	107.5	18.29	124.5	22.24	133.4	24.29	142.0	26.52	159.0	31.18	176.8	34.38
	35	89.7	15.68	107.5	19.55	124.5	23.64	133.4	25.85	142.0	28.23	159.0	33.25	176.8	36.45
	37	89.7	16.65	107.5	20.70	124.5	25.11	133.4	27.49	142.0	30.05	159.0	35.38	176.8	38.46
	39	89.7	17.70	107.5	22.06	124.5	26.85	133.4	29.59	142.0	32.46	159.0	37.86	176.8	41.48
	41	87.4	19.57	104.6	24.16	121.3	29.46	130.0	32.46	138.4	35.28	155.1	41.58	172.3	44.73
	43	85.3	21.29	102.0	26.34	118.2	32.15	126.6	35.38	135.0	38.53	151.2	45.42	167.9	48.37
46	80.0	23.67	95.7	29.62	110.9	36.20	118.7	39.40	126.6	43.43	141.7	51.24	157.4	53.90	
48	70.6	20.65	84.7	25.87	98.1	31.64	104.9	34.43	111.9	37.99	125.3	44.83	139.4	46.65	
60	10	76.9	8.96	91.8	10.52	106.7	12.24	114.3	13.12	121.6	13.94	136.8	15.81	151.7	17.69
	12	76.9	9.14	91.8	10.68	106.7	12.40	114.3	13.29	121.6	14.19	136.8	16.07	151.7	18.02
	14	76.9	9.21	91.8	10.85	106.7	12.63	114.3	13.53	121.6	14.43	136.8	16.40	151.7	18.35
	16	76.9	9.37	91.8	11.09	106.7	12.81	114.3	13.78	121.6	14.76	136.8	16.71	151.7	18.66
	18	76.9	9.55	91.8	11.24	106.7	13.04	114.3	14.02	121.6	15.01	136.8	16.96	151.7	19.07
	20	76.9	9.70	91.8	11.42	106.7	13.29	114.3	14.27	121.6	15.25	136.8	17.28	151.7	19.48
	21	76.9	9.78	91.8	11.50	106.7	13.45	114.3	14.43	121.6	15.40	136.8	17.53	151.7	19.66
	23	76.9	9.96	91.8	11.73	106.7	13.63	114.3	14.68	121.6	15.73	136.8	18.17	151.7	20.87
	25	76.9	10.11	91.8	11.99	106.7	14.19	114.3	15.40	121.6	16.71	136.8	19.40	151.7	22.33
	27	76.9	10.44	91.8	12.63	106.7	15.09	114.3	16.40	121.6	17.78	136.8	20.63	151.7	23.82
	29	76.9	11.09	91.8	13.45	106.7	16.07	114.3	17.45	121.6	18.92	136.8	22.02	151.7	25.43
	31	76.9	11.73	91.8	14.27	106.7	17.04	114.3	18.58	121.6	20.15	136.8	23.48	151.7	27.07
	33	76.9	12.40	91.8	15.09	106.7	18.10	114.3	19.74	121.6	21.43	136.8	24.95	151.7	28.87
	35	76.9	13.12	91.8	16.07	106.7	19.25	114.3	20.95	121.6	22.74	136.8	26.59	151.7	30.65
	37	76.9	13.86	91.8	16.94	106.7	20.38	114.3	22.25	121.6	24.13	136.8	28.21	151.7	32.62
	39	76.9	14.73	91.8	18.04	106.7	22.00	114.3	23.87	121.6	25.97	136.8	30.26	151.7	34.95
	41	74.8	15.99	89.4	19.76	104.1	23.89	111.4	26.08	118.5	28.18	133.1	33.19	147.8	37.98
	43	73.0	17.37	87.3	21.51	101.5	26.05	108.5	28.43	115.6	30.75	130.0	36.24	144.1	41.48
46	68.5	19.45	81.8	24.15	95.2	29.29	101.7	31.95	108.3	34.60	121.6	40.83	135.0	47.25	
48	60.4	16.96	72.4	21.07	84.2	25.59	90.0	27.90	96.0	30.23	107.7	35.70	119.5	41.35	
50	10	64.3	7.69	76.9	8.90	89.2	10.13	95.2	10.85	101.2	11.49	113.5	12.96	126.6	14.42
	12	64.3	7.77	76.9	9.00	89.2	10.28	95.2	11.01	101.2	11.75	113.5	13.19	126.6	14.66
	14	64.3	7.87	76.9	9.15	89.2	10.44	95.2	11.18	101.2	11.90	113.5	13.37	126.6	14.91
	16	64.3	8.02	76.9	9.31	89.2	10.62	95.2	11.42	101.2	12.06	113.5	13.60	126.6	15.14
	18	64.3	8.10	76.9	9.39	89.2	10.77	95.2	11.57	101.2	12.31	113.5	13.86	126.6	15.48
	20	64.3	8.18	76.9	9.56	89.2	11.01	95.2	11.75	101.2	12.55	113.5	14.09	126.6	15.79
	21	64.3	8.25	76.9	9.64	89.2	11.10	95.2	11.90	101.2	12.63	113.5	14.25	126.6	15.94
	23	64.3	8.43	76.9	9.80	89.2	11.26	95.2	12.06	101.2	12.88	113.5	14.50	126.6	16.28
	25	64.3	8.51	76.9	9.95	89.2	11.49	95.2	12.31	101.2	13.29	113.5	15.22	126.6	17.41
	27	64.3	8.66	76.9	10.28	89.2	12.14	95.2	13.11	101.2	14.09	113.5	16.28	126.6	18.54
	29	64.3	9.15	76.9	10.93	89.2	12.88	95.2	13.93	101.2	14.99	113.5	17.25	126.6	19.67
	31	64.3	9.64	76.9	11.57	89.2	13.68	95.2	14.73	101.2	15.94	113.5	18.38	126.6	20.98
	33	64.3	10.21	76.9	12.24	89.2	14.50	95.2	15.63	101.2	16.92	113.5	19.52	126.6	22.35
	35	64.3	10.77	76.9	12.96	89.2	15.30	95.2	16.61	101.2	17.90	113.5	20.65	126.6	23.73
	37	64.3	11.42	76.9	13.68	89.2	16.20	95.2	17.56	101.2	18.95	113.5	22.03	126.6	25.19
	39	64.3	12.19	76.9	14.68	89.2	17.36	95.2	18.92	101.2	20.34	113.5	23.47	126.6	27.20
	41	62.5	13.17	74.8	15.89	86.8	18.98	92.8	20.49	98.6	22.03	110.6	25.71	123.2	29.54
	43	61.0	14.32	73.0	17.28	84.7	20.65	90.5	22.32	96.3	23.99	108.0	28.05	120.3	32.22
46	57.3	16.04	68.5	19.38	79.3	23.17	84.7	25.05	90.2	26.92	101.2	31.55	112.7	36.28	
48	50.7	13.96	60.4	16.89	70.1	20.21	75.0	21.86	79.8	23.50	89.5	27.57	99.6	31.71	

Note

1. TC: Total Capacity(kW), PI : Power Input(kW, Comp. + Outdoor fan motor)
2. Capacity tables show the average value of conditions which may occur.

7. Capacity Tables

◆ A(C)RUN700LLS5

Combination (%)	Outdoor air temp (°C DB)	Cooling Capacity(70HP)													
		Indoor air temp. (DB/WB, °C)													
		20 14		23 16		26 18		27 19		28 20		30 22		32 24	
	TC	PI	TC	PI	TC	PI	TC	PI	TC	PI	TC	PI	TC	PI	
130	10	194.1	22.86	231.3	27.94	247.7	32.42	254.9	33.07	262.0	33.35	274.6	33.61	281.6	33.74
	12	194.1	23.43	231.3	28.94	247.7	33.74	254.9	33.97	262.0	34.23	274.6	34.52	281.6	34.83
	14	194.1	24.23	231.3	29.98	247.7	35.01	254.9	35.27	262.0	35.55	274.6	35.84	281.6	36.15
	16	194.1	25.11	231.3	31.04	247.7	36.59	254.9	36.93	262.0	37.21	274.6	37.55	281.6	37.86
	18	194.1	26.15	231.3	32.83	247.7	38.27	254.9	39.10	262.0	39.41	274.6	39.80	281.6	40.06
	20	194.1	27.31	231.3	34.98	247.7	40.16	254.9	42.99	262.0	43.35	270.6	43.77	277.8	44.08
	21	194.1	28.02	231.3	36.20	247.7	41.00	254.9	45.50	262.0	45.87	269.2	46.33	276.2	46.64
	23	194.1	30.06	231.3	38.09	247.7	43.12	254.9	50.22	258.7	50.61	265.2	51.12	272.2	51.47
	25	194.1	32.11	231.3	40.27	247.7	46.08	251.8	55.69	254.9	56.13	262.0	56.70	269.2	57.09
	27	194.1	34.36	231.3	43.07	244.7	49.11	247.7	61.31	251.8	61.80	258.7	62.40	265.2	62.84
	29	194.1	36.62	231.3	46.02	240.7	52.84	244.2	67.38	247.7	67.79	254.9	68.39	262.0	68.65
	31	194.1	39.08	230.5	48.48	236.7	56.20	240.7	73.09	244.2	73.50	250.9	74.11	257.9	74.46
	33	194.1	41.62	226.4	51.38	233.7	60.27	237.4	78.88	240.7	79.39	247.8	79.90	254.9	79.99
	35	194.1	44.39	222.4	53.80	229.6	65.28	233.7	85.11	237.4	85.62	243.9	86.13	250.9	86.64
	37	194.1	47.34	219.4	56.46	226.4	70.42	229.6	91.98	233.7	92.49	239.9	92.99	247.8	93.49
	39	194.1	50.40	215.4	59.42	222.4	76.56	226.4	99.68	229.6	100.19	236.7	100.69	244.7	101.19
	41	189.2	53.46	206.5	62.40	213.5	82.11	216.7	107.41	221.0	107.91	233.8	108.41	241.6	108.91
	43	184.4	56.39	197.9	61.52	204.9	81.83	207.9	115.24	212.1	115.74	230.7	116.24	238.5	116.74
	46	172.9	60.36	180.6	60.25	187.1	80.54	190.1	123.17	193.9	123.67	227.6	124.17	235.4	124.67
	48	152.9	58.67	156.7	58.85	162.6	78.98	165.3	131.20	168.8	131.70	224.5	132.20	232.3	132.70
	120	10	175.6	20.57	208.9	25.22	228.3	29.98	235.3	32.39	242.1	32.91	255.3	33.04	261.5
12		175.6	21.12	208.9	26.07	228.3	31.17	235.3	33.07	242.1	34.13	255.3	34.54	261.5	34.80
14		175.6	21.85	208.9	26.95	228.3	32.44	235.3	34.33	242.1	35.37	255.3	35.89	261.5	36.18
16		175.6	22.65	208.9	28.06	228.3	33.69	235.3	35.61	242.1	37.01	255.3	37.47	261.5	37.76
18		175.6	23.53	208.9	29.33	228.3	35.04	235.3	37.49	242.1	38.90	255.3	39.34	261.5	39.67
20		175.6	24.41	208.9	31.10	228.3	36.93	235.3	39.44	242.1	40.97	255.3	41.51	261.5	41.83
21		175.6	25.16	208.9	32.21	228.3	37.96	235.3	40.61	242.1	42.32	255.3	42.86	261.5	43.20
23		175.6	26.90	208.9	34.47	228.3	40.66	235.3	43.15	242.1	45.11	255.3	45.56	261.5	45.92
25		175.6	28.74	208.9	36.93	228.3	42.89	235.3	46.00	242.1	48.38	252.3	48.77	258.4	49.16
27		175.6	30.68	208.9	39.47	228.3	45.66	235.3	49.16	242.1	51.98	248.5	52.34	254.7	52.76
29		175.6	32.73	208.9	42.14	228.3	48.04	235.3	52.60	238.3	55.40	244.5	56.23	251.5	56.70
31		175.6	34.88	208.9	45.01	228.3	50.53	232.1	56.34	235.3	59.44	241.5	60.48	247.5	60.97
33		175.6	37.13	208.9	47.97	225.1	53.44	228.3	61.16	231.3	63.82	237.5	64.55	243.7	65.07
35		175.6	39.47	208.9	51.13	221.3	56.57	224.3	67.38	228.3	67.71	234.5	67.92	240.7	68.46
37		175.6	42.47	208.9	53.95	218.1	60.30	221.3	65.95	224.3	66.29	230.5	66.49	236.9	67.01
39		175.6	45.71	208.1	57.03	214.3	63.96	217.5	64.60	220.5	64.94	227.5	65.12	233.7	65.64
41		171.2	48.97	199.0	60.10	205.7	62.71	208.7	63.25	211.6	63.57	217.8	63.75	224.0	64.26
43		166.9	52.27	190.6	59.24	197.3	61.31	200.1	61.88	203.0	62.19	209.2	62.40	215.1	62.89
46		156.4	56.20	173.9	57.84	180.1	59.37	182.8	59.86	185.7	60.17	191.2	60.35	196.8	60.82
48		138.4	55.04	151.0	56.80	156.7	58.22	159.1	58.57	161.5	58.75	166.4	58.98	171.5	59.24
110		10	157.3	18.50	187.6	22.55	209.5	26.79	215.6	29.00	229.1	31.20	234.5	32.08	250.4
	12	157.3	19.07	187.6	23.32	209.5	27.91	215.6	29.80	229.1	32.37	234.5	33.43	250.4	34.18
	14	157.3	19.67	187.6	24.36	209.5	29.15	215.6	31.28	229.1	34.00	234.5	34.98	250.4	35.71
	16	157.3	20.37	187.6	25.24	209.5	30.37	215.6	32.65	229.1	35.58	234.5	36.54	250.4	37.19
	18	157.3	21.12	187.6	26.30	209.5	32.11	215.6	34.39	229.1	37.52	234.5	38.27	250.4	38.98
	20	157.3	21.87	187.6	27.62	209.5	34.05	215.6	35.97	229.1	39.34	234.5	40.32	250.4	40.97
	21	157.3	22.36	187.6	28.43	209.5	34.93	215.6	36.93	229.1	40.45	234.5	41.46	250.4	42.11
	23	157.3	23.84	187.6	30.48	209.5	36.88	215.6	39.00	229.1	42.73	234.5	43.64	250.4	44.36
	25	157.3	25.47	187.6	32.52	209.5	38.97	215.6	41.23	229.1	45.14	234.5	45.79	247.4	46.72
	27	157.3	27.21	187.6	34.78	209.5	41.18	215.6	43.64	229.1	47.14	234.5	48.22	243.7	49.05
	29	157.3	29.05	187.6	37.13	209.5	43.51	215.6	46.20	229.1	49.83	234.5	50.69	240.7	51.44
	31	157.3	30.89	187.6	39.57	209.5	45.97	215.6	48.95	225.4	52.35	231.5	53.38	236.9	53.93
	33	157.3	32.94	187.6	42.14	209.5	48.59	215.6	51.88	222.4	55.28	227.8	56.21	233.7	56.52
	35	157.3	34.98	187.6	45.01	209.5	51.31	215.6	54.96	218.6	58.35	224.0	58.88	229.9	59.18
	37	157.3	37.08	187.6	47.76	209.5	54.16	212.7	58.23	214.8	61.54	221.0	61.75	226.2	61.93
	39	157.3	39.96	187.6	50.76	205.7	57.14	208.7	62.29	211.9	64.58	217.0	64.70	223.2	64.76
	41	153.4	42.86	182.8	53.74	197.0	60.27	200.0	67.38	202.7	67.38	208.6	67.92	213.8	68.46
	43	149.5	45.01	178.2	56.00	188.7	63.90	191.9	64.63	194.4	64.50	200.1	64.86	205.2	65.04
	46	140.2	43.92	167.2	54.06	172.3	60.66	175.3	60.66	177.4	61.18	182.8	61.52	187.7	61.68
	48	123.9	42.66	145.1	52.08	149.7	57.71	152.4	58.10	154.3	58.38	159.1	58.54	163.2	58.77

Note

1. TC: Total Capacity(kW), PI: Power Input(kW, Comp. + Outdoor fan motor)
2. Capacity tables show the average value of conditions which may occur.

7. Capacity Tables

Combination (%)	Outdoor air temp (°C DB)	Cooling Capacity(70HP)													
		Indoor air temp. (DB/WB, °C)													
		20		23		26		27		28		30		32	
		14	16	18	19	20	22	24							
	TC	PI	TC	PI	TC	PI	TC	PI	TC	PI	TC	PI	TC	PI	
100	10	132.2	16.66	157.5	20.24	183.4	24.02	196.0	25.96	208.6	27.88	231.3	31.05	236.4	31.30
	12	132.2	17.20	157.5	21.07	183.4	24.83	196.0	26.66	208.6	28.79	231.3	32.73	236.4	33.04
	14	132.2	17.73	157.5	21.92	183.4	25.89	196.0	27.81	208.6	30.03	231.3	34.54	236.4	34.88
	16	132.2	18.27	157.5	22.65	183.4	26.98	196.0	29.13	208.6	31.64	231.3	36.22	236.4	36.72
	18	132.2	18.81	157.5	23.48	183.4	28.04	196.0	30.55	208.6	33.56	231.3	38.27	236.4	38.56
	20	132.2	19.49	157.5	24.38	183.4	29.67	196.0	32.73	208.6	35.89	231.3	40.09	236.4	40.42
	21	132.2	19.90	157.5	24.95	183.4	30.68	196.0	33.85	208.6	37.24	231.3	41.02	236.4	41.33
	23	132.2	21.07	157.5	26.69	183.4	32.94	196.0	36.31	208.6	39.88	231.3	42.94	236.4	43.30
	25	132.2	22.39	157.5	28.43	183.4	35.19	196.0	38.87	208.6	42.65	231.3	44.78	234.3	45.14
	27	132.2	23.94	157.5	30.37	183.4	37.63	196.0	41.52	208.6	45.35	226.7	46.88	231.5	47.26
	29	132.2	25.47	157.5	32.42	183.4	40.19	196.0	44.39	208.6	47.99	222.6	48.77	228.0	49.16
	31	132.2	27.21	157.5	34.57	183.4	42.86	196.0	47.35	208.6	50.43	219.2	50.66	224.5	51.07
	33	132.2	28.84	157.5	36.82	183.4	45.71	196.0	50.53	208.6	52.32	215.7	52.55	221.0	52.97
	35	132.2	30.68	157.5	39.18	183.4	48.69	196.0	53.90	205.4	54.21	211.9	54.44	217.2	54.86
	37	132.2	32.86	157.5	42.01	183.4	51.57	196.0	56.47	202.0	56.75	207.8	56.98	212.7	57.50
	39	132.2	35.24	157.5	45.14	183.4	54.65	196.0	59.24	198.7	59.50	204.6	59.71	209.2	60.27
	41	130.3	37.60	155.1	48.25	180.4	57.73	188.2	61.99	192.2	62.24	196.8	62.45	203.0	63.04
	43	125.7	39.80	149.7	51.15	174.2	60.48	180.4	64.37	182.3	64.58	188.0	64.81	193.0	65.41
46	117.9	42.81	140.3	55.14	163.4	64.16	164.7	67.38	166.4	67.58	171.8	67.77	176.4	68.41	
48	104.2	36.95	124.1	47.71	141.1	54.84	143.0	57.17	144.6	57.35	149.4	57.48	153.4	57.94	
90	10	119.0	14.63	142.1	17.57	165.3	20.71	176.4	22.33	187.6	24.04	210.8	26.90	233.7	29.91
	12	119.0	14.79	142.1	17.85	165.3	21.08	176.4	22.78	187.6	24.57	210.8	27.42	233.7	30.44
	14	119.0	15.07	142.1	18.20	165.3	21.52	176.4	23.23	187.6	25.01	210.8	27.97	233.7	31.06
	16	119.0	15.34	142.1	18.56	165.3	21.97	176.4	23.67	187.6	25.48	210.8	28.50	233.7	31.59
	18	119.0	15.60	142.1	18.93	165.3	22.33	176.4	24.22	187.6	26.01	210.8	29.12	233.7	33.19
	20	119.0	15.86	142.1	19.27	165.3	22.78	176.4	24.67	187.6	27.00	210.8	31.17	233.7	34.76
	21	119.0	16.05	142.1	19.45	165.3	23.23	176.4	25.48	187.6	27.97	210.8	31.67	233.7	35.57
	23	119.0	16.41	142.1	20.26	165.3	24.85	176.4	27.34	187.6	29.96	210.8	33.58	230.5	37.25
	25	119.0	17.22	142.1	21.60	165.3	26.55	176.4	29.23	187.6	32.01	210.8	35.91	227.2	38.83
	27	119.0	18.38	142.1	23.04	165.3	28.34	176.4	31.20	187.6	34.26	210.8	38.17	224.0	40.66
	29	119.0	19.45	142.1	24.57	165.3	30.31	176.4	33.37	187.6	36.59	210.8	40.45	220.5	42.29
	31	119.0	20.71	142.1	26.19	165.3	32.29	176.4	35.52	187.6	39.01	210.8	42.47	217.3	43.93
	33	119.0	22.07	142.1	27.89	165.3	34.44	176.4	37.85	187.6	41.37	210.8	44.51	214.0	45.56
	35	119.0	23.41	142.1	29.60	165.3	36.59	176.4	40.35	187.6	43.88	207.0	47.06	210.6	48.15
	37	119.0	24.85	142.1	31.48	165.3	39.01	176.4	42.86	187.6	46.32	203.8	49.20	207.3	50.31
	39	119.0	26.30	142.1	33.48	165.3	41.29	176.4	45.61	187.6	48.71	200.3	51.88	203.8	52.51
	41	116.0	29.44	138.4	37.12	161.0	45.32	171.8	49.89	182.8	52.59	192.0	54.66	195.5	55.92
	43	113.1	31.77	135.1	40.11	157.0	49.50	167.7	53.74	178.2	56.39	184.1	58.54	187.4	59.25
46	106.1	35.76	126.5	45.67	147.0	56.41	157.2	60.92	162.1	62.63	168.0	64.25	171.2	64.36	
48	93.7	31.25	112.0	39.95	130.1	49.34	138.9	53.14	140.6	53.98	146.2	55.31	148.9	55.39	
80	10	105.8	12.22	126.0	14.68	146.2	17.23	156.7	18.59	167.2	19.94	187.6	22.75	207.9	24.69
	12	105.8	12.48	126.0	14.84	146.2	17.57	156.7	18.92	167.2	20.28	187.6	23.17	207.9	25.19
	14	105.8	12.64	126.0	15.18	146.2	17.81	156.7	19.26	167.2	20.62	187.6	23.59	207.9	25.67
	16	105.8	12.82	126.0	15.45	146.2	18.15	156.7	19.60	167.2	21.04	187.6	24.11	207.9	26.16
	18	105.8	13.08	126.0	15.71	146.2	18.49	156.7	19.94	167.2	21.46	187.6	24.53	207.9	26.74
	20	105.8	13.32	126.0	16.05	146.2	18.92	156.7	20.36	167.2	21.90	187.6	25.45	207.9	28.32
	21	105.8	13.40	126.0	16.21	146.2	19.10	156.7	20.62	167.2	22.41	187.6	26.27	207.9	29.08
	23	105.8	13.66	126.0	16.47	146.2	19.94	156.7	21.90	167.2	23.93	187.6	27.74	207.9	30.52
	25	105.8	14.18	126.0	17.57	146.2	21.38	156.7	23.43	167.2	25.64	187.6	29.68	207.9	32.62
	27	105.8	15.02	126.0	18.67	146.2	22.83	156.7	25.03	167.2	27.32	187.6	31.52	207.9	34.33
	29	105.8	15.95	126.0	19.94	146.2	24.27	156.7	26.66	167.2	29.19	187.6	33.78	207.9	36.75
	31	105.8	16.97	126.0	21.12	146.2	25.88	156.7	28.42	167.2	31.07	187.6	35.85	207.9	38.58
	33	105.8	17.99	126.0	22.57	146.2	27.58	156.7	30.29	167.2	33.10	187.6	37.77	207.9	40.45
	35	105.8	19.10	126.0	23.93	146.2	29.37	156.7	32.25	167.2	35.30	187.6	40.06	205.7	41.92
	37	105.8	20.20	126.0	25.45	146.2	31.15	156.7	34.28	167.2	37.51	187.6	42.27	202.4	43.82
	39	105.8	21.35	126.0	26.90	146.2	33.31	156.7	36.85	167.2	40.32	187.6	44.66	199.0	46.23
	41	103.1	23.61	122.8	29.81	142.5	36.56	152.7	40.40	162.9	44.29	182.8	49.70	190.6	51.22
	43	100.4	26.00	119.8	32.52	139.0	39.92	148.9	44.03	159.1	48.41	178.2	53.19	182.8	54.85
46	94.2	28.92	112.3	36.64	130.3	44.97	139.7	49.01	148.9	54.61	163.1	58.05	166.9	58.99	
48	83.2	25.27	99.3	32.04	115.2	39.32	123.6	42.81	131.9	47.81	141.6	50.25	145.1	50.78	

Note

1. TC: Total Capacity(kW), PI : Power Input(kW, Comp. + Outdoor fan motor)
2. Capacity tables show the average value of conditions which may occur.

7. Capacity Tables

Combination (%)	Outdoor air temp (°C DB)	Cooling Capacity(70HP)													
		Indoor air temp. (DB/WB, °C)													
		20		23		26		27		28		30		32	
		14	16	18	19	20	22	24	TC	PI	TC	PI	TC	PI	
70	10	92.4	10.71	110.6	12.74	128.1	14.76	137.3	15.95	146.2	17.03	163.7	19.40	182.0	21.69
	12	92.4	10.87	110.6	12.90	128.1	15.08	137.3	16.19	146.2	17.37	163.7	19.74	182.0	22.11
	14	92.4	11.05	110.6	13.08	128.1	15.35	137.3	16.45	146.2	17.63	163.7	20.16	182.0	22.50
	16	92.4	11.21	110.6	13.32	128.1	15.61	137.3	16.79	146.2	17.95	163.7	20.50	182.0	22.98
	18	92.4	11.39	110.6	13.58	128.1	15.95	137.3	17.11	146.2	18.29	163.7	20.82	182.0	23.40
	20	92.4	11.55	110.6	13.82	128.1	16.19	137.3	17.45	146.2	18.72	163.7	21.34	182.0	24.29
	21	92.4	11.71	110.6	13.92	128.1	16.37	137.3	17.63	146.2	18.90	163.7	21.66	182.0	24.80
	23	92.4	11.90	110.6	14.24	128.1	16.69	137.3	18.21	146.2	19.82	163.7	23.19	182.0	26.19
	25	92.4	12.06	110.6	14.76	128.1	17.79	137.3	19.48	146.2	21.16	163.7	24.79	182.0	27.45
	27	92.4	12.74	110.6	15.77	128.1	18.98	137.3	20.66	146.2	22.61	163.7	26.48	182.0	29.19
	29	92.4	13.58	110.6	16.69	128.1	20.16	137.3	22.01	146.2	24.03	163.7	28.24	182.0	31.27
	31	92.4	14.42	110.6	17.79	128.1	21.50	137.3	23.53	146.2	25.64	163.7	30.11	182.0	33.17
	33	92.4	15.27	110.6	18.80	128.1	22.85	137.3	24.95	146.2	27.24	163.7	32.04	182.0	35.32
	35	92.4	16.11	110.6	20.08	128.1	24.29	137.3	26.56	146.2	29.01	163.7	34.16	182.0	37.45
	37	92.4	17.11	110.6	21.27	128.1	25.80	137.3	28.24	146.2	30.87	163.7	36.35	182.0	39.51
	39	92.4	18.19	110.6	22.66	128.1	27.59	137.3	30.40	146.2	33.35	163.7	38.90	182.0	42.61
	41	90.0	20.11	107.7	24.82	124.9	30.27	133.8	33.35	142.5	36.24	159.6	42.72	177.4	45.96
	43	87.8	21.87	105.0	27.06	121.7	33.03	130.3	36.35	139.0	39.58	155.6	46.67	172.9	49.69
46	82.4	24.32	98.5	30.43	114.1	37.19	122.2	40.48	130.3	44.61	145.9	52.64	162.1	55.38	
48	72.7	21.21	87.2	26.58	101.0	32.51	108.0	35.38	115.2	39.03	129.0	46.06	143.5	47.93	
60	10	79.1	9.21	94.5	10.81	109.9	12.58	117.6	13.48	125.2	14.32	140.8	16.25	156.1	18.17
	12	79.1	9.39	94.5	10.97	109.9	12.74	117.6	13.66	125.2	14.58	140.8	16.51	156.1	18.52
	14	79.1	9.47	94.5	11.15	109.9	12.98	117.6	13.90	125.2	14.82	140.8	16.85	156.1	18.86
	16	79.1	9.63	94.5	11.39	109.9	13.16	117.6	14.16	125.2	15.17	140.8	17.17	156.1	19.18
	18	79.1	9.81	94.5	11.55	109.9	13.40	117.6	14.40	125.2	15.43	140.8	17.43	156.1	19.60
	20	79.1	9.97	94.5	11.74	109.9	13.66	117.6	14.66	125.2	15.67	140.8	17.75	156.1	20.02
	21	79.1	10.05	94.5	11.82	109.9	13.82	117.6	14.82	125.2	15.83	140.8	18.01	156.1	20.20
	23	79.1	10.23	94.5	12.06	109.9	14.00	117.6	15.09	125.2	16.17	140.8	18.68	156.1	21.44
	25	79.1	10.39	94.5	12.32	109.9	14.58	117.6	15.83	125.2	17.17	140.8	19.94	156.1	22.95
	27	79.1	10.73	94.5	12.98	109.9	15.51	117.6	16.85	125.2	18.27	140.8	21.20	156.1	24.47
	29	79.1	11.39	94.5	13.82	109.9	16.51	117.6	17.93	125.2	19.44	140.8	22.63	156.1	26.14
	31	79.1	12.06	94.5	14.66	109.9	17.51	117.6	19.10	125.2	20.70	140.8	24.13	156.1	27.82
	33	79.1	12.74	94.5	15.51	109.9	18.60	117.6	20.28	125.2	22.03	140.8	25.64	156.1	29.67
	35	79.1	13.48	94.5	16.51	109.9	19.78	117.6	21.52	125.2	23.37	140.8	27.32	156.1	31.49
	37	79.1	14.24	94.5	17.41	109.9	20.94	117.6	22.87	125.2	24.79	140.8	28.99	156.1	33.52
	39	79.1	15.14	94.5	18.54	109.9	22.60	117.6	24.53	125.2	26.69	140.8	31.09	156.1	35.92
	41	77.0	16.43	92.1	20.31	107.1	24.55	114.7	26.80	122.0	28.96	137.1	34.11	152.1	39.03
	43	75.1	17.86	89.9	22.10	104.5	26.77	111.7	29.22	119.0	31.60	133.8	37.24	148.3	42.62
46	70.5	19.99	84.2	24.82	98.0	30.10	104.7	32.84	111.5	35.55	125.2	41.96	138.9	48.56	
48	62.2	17.43	74.5	21.65	86.7	26.30	92.6	28.67	98.8	31.07	110.9	36.69	123.0	42.49	
50	10	66.2	7.90	79.1	9.15	91.8	10.41	98.0	11.15	104.2	11.82	116.9	13.32	130.3	14.82
	12	66.2	7.98	79.1	9.25	91.8	10.57	98.0	11.31	104.2	12.08	116.9	13.56	130.3	15.07
	14	66.2	8.08	79.1	9.41	91.8	10.73	98.0	11.49	104.2	12.24	116.9	13.74	130.3	15.33
	16	66.2	8.24	79.1	9.57	91.8	10.91	98.0	11.74	104.2	12.40	116.9	13.98	130.3	15.57
	18	66.2	8.33	79.1	9.65	91.8	11.07	98.0	11.90	104.2	12.66	116.9	14.24	130.3	15.91
	20	66.2	8.41	79.1	9.83	91.8	11.31	98.0	12.08	104.2	12.90	116.9	14.48	130.3	16.23
	21	66.2	8.49	79.1	9.91	91.8	11.41	98.0	12.24	104.2	12.98	116.9	14.64	130.3	16.39
	23	66.2	8.67	79.1	10.07	91.8	11.58	98.0	12.40	104.2	13.24	116.9	14.91	130.3	16.73
	25	66.2	8.75	79.1	10.23	91.8	11.82	98.0	12.66	104.2	13.66	116.9	15.65	130.3	17.89
	27	66.2	8.91	79.1	10.57	91.8	12.48	98.0	13.48	104.2	14.48	116.9	16.73	130.3	19.06
	29	66.2	9.41	79.1	11.23	91.8	13.24	98.0	14.32	104.2	15.41	116.9	17.73	130.3	20.22
	31	66.2	9.91	79.1	11.90	91.8	14.06	98.0	15.15	104.2	16.39	116.9	18.90	130.3	21.57
	33	66.2	10.49	79.1	12.58	91.8	14.91	98.0	16.07	104.2	17.39	116.9	20.06	130.3	22.97
	35	66.2	11.07	79.1	13.32	91.8	15.73	98.0	17.07	104.2	18.40	116.9	21.22	130.3	24.39
	37	66.2	11.74	79.1	14.06	91.8	16.65	98.0	18.05	104.2	19.48	116.9	22.65	130.3	25.90
	39	66.2	12.53	79.1	15.09	91.8	17.84	98.0	19.45	104.2	20.91	116.9	24.13	130.3	27.96
	41	64.4	13.53	77.0	16.33	89.4	19.51	95.6	21.06	101.5	22.65	113.9	26.43	126.8	30.37
	43	62.8	14.72	75.1	17.76	87.2	21.22	93.1	22.94	99.1	24.66	111.2	28.83	123.8	33.12
46	58.9	16.49	70.5	19.93	81.6	23.81	87.2	25.74	92.9	27.67	104.2	32.43	116.0	37.29	
48	52.2	14.35	62.2	17.37	72.2	20.77	77.3	22.47	82.1	24.16	92.1	28.34	102.6	32.59	

Note

1. TC: Total Capacity(kW), PI : Power Input(kW, Comp. + Outdoor fan motor)
2. Capacity tables show the average value of conditions which may occur.

7. Capacity Tables

◆ A(C)RUN720LLS5

Combination (%)	Outdoor air temp (°C DB)	Indoor air temp. (DB/WB, °C)														Cooling Capacity(72HP)	
		20		23		26		27		28		30		32		TC	PI
		14		16		18		19		20		22		24			
		TC	PI	TC	PI	TC	PI	TC	PI	TC	PI	TC	PI	TC	PI		
130	10	199.7	23.62	237.9	28.87	254.8	33.50	262.2	34.17	269.5	34.46	282.5	34.73	289.7	34.87		
	12	199.7	24.21	237.9	29.91	254.8	34.87	262.2	35.11	269.5	35.38	282.5	35.67	289.7	35.99		
	14	199.7	25.03	237.9	30.99	254.8	36.18	262.2	36.45	269.5	36.74	282.5	37.03	289.7	37.36		
	16	199.7	25.95	237.9	32.08	254.8	37.81	262.2	38.16	269.5	38.46	282.5	38.80	289.7	39.12		
	18	199.7	27.02	237.9	33.93	254.8	39.55	262.2	40.41	269.5	40.73	282.5	41.13	289.7	41.40		
	20	199.7	28.22	237.9	36.15	254.8	41.50	262.2	44.43	269.5	44.80	278.3	45.23	285.8	45.55		
	21	199.7	28.95	237.9	37.41	254.8	42.36	262.2	47.02	269.5	47.40	276.9	47.88	284.1	48.20		
	23	199.7	31.07	237.9	39.36	254.8	44.56	262.2	51.90	266.1	52.30	272.8	52.83	280.0	53.18		
	25	199.7	33.18	237.9	41.62	254.8	47.62	259.0	57.55	262.2	58.00	269.5	58.59	276.9	58.99		
	27	199.7	35.51	237.9	44.50	251.7	50.75	254.8	63.36	259.0	63.87	266.1	64.49	272.8	64.94		
	29	199.7	37.84	237.9	47.56	247.6	54.60	251.2	69.63	254.8	70.05	262.2	70.67	269.5	70.94		
	31	199.7	40.38	237.0	50.10	243.4	58.08	247.6	69.33	251.2	69.76	258.1	70.37	265.3	70.64		
	33	199.7	43.01	232.9	53.10	240.3	62.29	244.2	68.69	247.6	69.12	254.8	69.73	261.4	70.00		
	35	199.7	45.87	228.8	55.59	236.2	67.46	240.3	67.80	244.2	68.21	250.9	68.82	258.1	69.09		
	37	199.7	48.92	225.7	58.35	232.9	66.57	236.2	66.92	240.3	67.32	246.7	67.91	254.2	68.18		
	39	199.7	52.09	221.6	61.41	228.8	65.69	232.9	66.01	236.2	66.41	243.4	67.00	250.9	67.27		
	41	194.6	55.25	212.4	64.48	219.6	64.80	222.9	65.12	227.3	65.50	234.0	66.09	240.4	66.36		
	43	189.7	58.27	203.5	63.57	210.7	63.90	213.8	64.22	218.2	64.61	224.8	65.18	230.9	65.45		
	46	177.8	62.37	185.8	62.26	192.5	62.56	195.5	62.88	199.4	63.25	205.8	63.82	211.5	64.08		
	48	157.3	60.63	161.2	60.82	167.3	60.95	170.0	61.11	173.6	61.64	179.2	62.04	184.1	62.29		
120	10	180.6	21.26	214.9	26.06	234.8	30.98	242.0	33.47	249.0	34.01	262.6	34.14	268.9	34.41		
	12	180.6	21.83	214.9	26.94	234.8	32.22	242.0	34.17	249.0	35.27	262.6	35.69	268.9	35.97		
	14	180.6	22.58	214.9	27.85	234.8	33.53	242.0	35.48	249.0	36.55	262.6	37.09	268.9	37.38		
	16	180.6	23.40	214.9	29.00	234.8	34.81	242.0	36.80	249.0	38.24	262.6	38.72	268.9	39.02		
	18	180.6	24.31	214.9	30.31	234.8	36.21	242.0	38.75	249.0	40.20	262.6	40.65	268.9	41.00		
	20	180.6	25.23	214.9	32.13	234.8	38.16	242.0	40.76	249.0	42.34	262.6	42.90	268.9	43.22		
	21	180.6	26.00	214.9	33.29	234.8	39.23	242.0	41.96	249.0	43.73	262.6	44.29	268.9	44.64		
	23	180.6	27.80	214.9	35.62	234.8	42.02	242.0	44.59	249.0	46.62	262.6	47.08	268.9	47.46		
	25	180.6	29.70	214.9	38.16	234.8	44.32	242.0	47.53	249.0	49.99	259.5	50.40	265.8	50.80		
	27	180.6	31.71	214.9	40.79	234.8	47.18	242.0	50.80	249.0	53.72	255.6	54.09	261.9	54.52		
	29	180.6	33.82	214.9	43.54	234.8	49.65	242.0	54.36	245.1	57.25	251.5	58.11	258.6	58.59		
	31	180.6	36.04	214.9	46.51	234.8	52.22	238.7	58.22	242.0	61.43	248.4	62.50	254.5	63.01		
	33	180.6	38.37	214.9	49.57	231.5	55.22	234.8	63.20	237.9	65.95	244.3	66.70	250.6	67.24		
	35	180.6	40.79	214.9	52.84	227.6	58.46	230.7	69.63	234.8	69.97	241.2	70.19	247.5	70.75		
	37	180.6	43.89	214.9	55.76	224.3	62.32	227.6	68.15	230.7	68.50	237.1	68.71	243.7	69.25		
	39	180.6	47.24	214.1	58.94	220.4	66.09	223.7	66.76	226.8	67.10	234.0	67.30	240.4	67.83		
	41	176.1	50.61	204.7	62.10	211.6	64.80	214.6	65.37	217.7	65.69	224.0	65.88	230.4	66.41		
	43	171.7	54.01	196.1	61.22	203.0	63.36	205.8	63.95	208.8	64.27	215.1	64.48	221.3	64.99		
	46	160.9	58.08	178.9	59.77	185.3	61.35	188.0	61.86	191.0	62.18	196.6	62.36	202.5	62.85		
	48	142.3	56.88	155.3	58.70	161.1	60.17	163.6	60.52	166.1	60.71	171.1	60.95	176.4	61.21		
110	10	161.8	19.12	193.0	23.30	215.5	27.69	221.8	29.97	235.7	32.24	241.2	33.15	257.5	33.69		
	12	161.8	19.71	193.0	24.10	215.5	28.84	221.8	30.80	235.7	33.45	241.2	34.54	257.5	35.32		
	14	161.8	20.33	193.0	25.17	215.5	30.13	221.8	32.32	235.7	35.14	241.2	36.15	257.5	36.90		
	16	161.8	21.05	193.0	26.09	215.5	31.38	221.8	33.74	235.7	36.77	241.2	37.76	257.5	38.43		
	18	161.8	21.83	193.0	27.18	215.5	33.18	221.8	35.54	235.7	38.78	241.2	39.55	257.5	40.28		
	20	161.8	22.60	193.0	28.54	215.5	35.19	221.8	37.17	235.7	40.65	241.2	41.67	257.5	42.34		
	21	161.8	23.11	193.0	29.38	215.5	36.10	221.8	38.16	235.7	41.80	241.2	42.85	257.5	43.52		
	23	161.8	24.63	193.0	31.49	215.5	38.11	221.8	40.30	235.7	44.16	241.2	45.10	257.5	45.85		
	25	161.8	26.32	193.0	33.61	215.5	40.27	221.8	42.60	235.7	46.65	241.2	47.32	254.5	48.28		
	27	161.8	28.12	193.0	35.94	215.5	42.55	221.8	45.09	235.7	48.71	241.2	49.84	250.6	50.69		
	29	161.8	30.02	193.0	38.37	215.5	44.96	221.8	47.75	235.7	51.49	241.2	52.38	247.5	53.16		
	31	161.8	31.92	193.0	40.89	215.5	47.51	221.8	50.59	231.8	54.10	238.1	55.16	243.7	55.73		
	33	161.8	34.04	193.0	43.54	215.5	50.21	221.8	53.61	228.7	57.12	234.3	58.08	240.4	58.40		
	35	161.8	36.15	193.0	46.51	215.5	53.02	221.8	56.80	224.9	60.30	230.4	60.84	236.5	61.16		
	37	161.8	38.32	193.0	49.35	215.5	55.97	218.7	60.17	221.0	63.60	227.3	63.81	232.6	64.00		
	39	161.8	41.30	193.0	52.46	211.6	59.05	214.6	64.37	217.9	66.74	223.2	66.86	229.6	66.92		
	41	157.8	44.29	188.0	55.54	202.7	62.29	205.8	69.63	208.5	69.63	214.6	70.19	219.9	70.75		
	43	153.7	46.51	183.3	57.87	194.1	66.04	197.4	66.79	199.9	66.65	205.8	67.03	211.0	67.21		
	46	144.2	45.39	171.9	55.86	177.2	62.69	180.3	62.69	182.5	63.22	188.1	63.57	193.0	63.74		
	48	127.4	44.08	149.3	53.82	153.9	59.64	156.7	60.04	158.7	60.33	163.7	60.49	167.9	60.73		

Note

1. TC: Total Capacity(kW), PI : Power Input(kW, Comp. + Outdoor fan motor)
2. Capacity tables show the average value of conditions which may occur.

7. Capacity Tables

Combination (%)	Outdoor air temp (°C DB)	Cooling Capacity(72HP)													
		Indoor air temp. (DB/WB, °C)													
		20		23		26		27		28		30		32	
		14	16	18	19	20	22	24	TC	PI	TC	PI	TC	PI	
100	10	136.0	17.22	162.0	20.92	188.6	24.82	201.6	26.83	214.6	28.82	237.9	32.08	243.1	32.35
	12	136.0	17.78	162.0	21.77	188.6	25.66	201.6	27.55	214.6	29.75	237.9	33.82	243.1	34.14
	14	136.0	18.32	162.0	22.65	188.6	26.75	201.6	28.74	214.6	31.03	237.9	35.70	243.1	36.04
	16	136.0	18.88	162.0	23.40	188.6	27.88	201.6	30.10	214.6	32.70	237.9	37.43	243.1	37.95
	18	136.0	19.44	162.0	24.26	188.6	28.97	201.6	31.57	214.6	34.68	237.9	39.55	243.1	39.85
	20	136.0	20.14	162.0	25.20	188.6	30.66	201.6	33.82	214.6	37.09	237.9	41.43	243.1	41.77
	21	136.0	20.56	162.0	25.79	188.6	31.71	201.6	34.98	214.6	38.48	237.9	42.39	243.1	42.71
	23	136.0	21.77	162.0	27.58	188.6	34.04	201.6	37.52	214.6	41.21	237.9	44.37	243.1	44.74
	25	136.0	23.14	162.0	29.38	188.6	36.36	201.6	40.17	214.6	44.08	237.9	46.27	241.0	46.65
	27	136.0	24.74	162.0	31.39	188.6	38.89	201.6	42.90	214.6	46.86	233.2	48.44	238.2	48.84
	29	136.0	26.32	162.0	33.50	188.6	41.53	201.6	45.87	214.6	49.59	229.0	50.40	234.6	50.80
	31	136.0	28.12	162.0	35.72	188.6	44.29	201.6	48.93	214.6	52.11	225.4	52.35	231.0	52.78
	33	136.0	29.80	162.0	38.05	188.6	47.24	201.6	52.22	214.6	54.07	221.8	54.31	227.4	54.74
	35	136.0	31.71	162.0	40.49	188.6	50.32	201.6	55.70	211.3	56.02	217.9	56.26	223.4	56.69
	37	136.0	33.96	162.0	43.41	188.6	53.29	201.6	58.35	207.7	58.64	213.8	58.88	218.8	59.42
	39	136.0	36.42	162.0	46.65	188.6	56.48	201.6	61.21	204.4	61.48	210.4	61.70	215.2	62.29
	41	134.0	38.86	159.5	49.86	185.6	59.66	193.5	64.06	197.7	64.32	202.4	64.54	208.8	65.15
	43	129.3	41.13	154.0	52.86	179.2	62.50	185.5	66.52	187.5	66.74	193.3	66.97	198.5	67.59
46	121.3	44.24	144.3	56.99	168.1	66.30	169.4	69.63	171.1	69.84	176.7	70.03	181.4	70.70	
48	107.2	38.19	127.7	49.30	145.1	56.67	147.1	59.07	148.7	59.26	153.7	59.40	157.8	59.88	
90	10	122.4	15.01	146.2	18.03	170.0	21.26	181.4	22.92	193.0	24.67	216.8	27.61	240.4	30.70
	12	122.4	15.18	146.2	18.32	170.0	21.63	181.4	23.38	193.0	25.21	216.8	28.15	240.4	31.24
	14	122.4	15.47	146.2	18.68	170.0	22.09	181.4	23.84	193.0	25.67	216.8	28.71	240.4	31.88
	16	122.4	15.74	146.2	19.05	170.0	22.55	181.4	24.30	193.0	26.15	216.8	29.25	240.4	32.42
	18	122.4	16.01	146.2	19.42	170.0	22.92	181.4	24.86	193.0	26.69	216.8	29.89	240.4	34.06
	20	122.4	16.28	146.2	19.78	170.0	23.38	181.4	25.32	193.0	27.71	216.8	31.99	240.4	35.68
	21	122.4	16.47	146.2	19.97	170.0	23.84	181.4	26.15	193.0	28.71	216.8	32.50	240.4	36.51
	23	122.4	16.84	146.2	20.80	170.0	25.50	181.4	28.06	193.0	30.75	216.8	34.47	237.1	38.23
	25	122.4	17.68	146.2	22.17	170.0	27.25	181.4	30.00	193.0	32.85	216.8	36.86	233.7	39.85
	27	122.4	18.86	146.2	23.65	170.0	29.08	181.4	32.02	193.0	35.16	216.8	39.18	230.4	41.73
	29	122.4	19.97	146.2	25.21	170.0	31.10	181.4	34.25	193.0	37.56	216.8	41.51	226.8	43.40
	31	122.4	21.26	146.2	26.88	170.0	33.14	181.4	36.45	193.0	40.04	216.8	43.58	223.5	45.09
	33	122.4	22.65	146.2	28.63	170.0	35.35	181.4	38.85	193.0	42.46	216.8	45.69	220.1	46.76
	35	122.4	24.03	146.2	30.38	170.0	37.56	181.4	41.41	193.0	45.04	213.0	48.30	216.6	49.42
	37	122.4	25.50	146.2	32.31	170.0	40.04	181.4	43.99	193.0	47.54	209.6	50.50	213.2	51.63
	39	122.4	26.99	146.2	34.36	170.0	42.38	181.4	46.82	193.0	49.99	206.1	53.24	209.7	53.89
	41	119.3	30.21	142.4	38.10	165.6	46.52	176.7	51.20	188.0	53.97	197.5	56.10	201.0	57.39
	43	116.3	32.61	139.0	41.17	161.5	50.80	172.5	55.15	183.3	57.87	189.4	60.08	192.8	60.81
46	109.1	36.70	130.2	46.87	151.2	57.90	161.7	62.53	166.7	64.28	172.8	65.95	176.1	66.05	
48	96.4	32.07	115.2	41.00	133.8	50.64	142.9	54.54	144.6	55.40	150.3	56.77	153.1	56.85	
80	10	108.8	12.57	129.6	15.10	150.4	17.72	161.2	19.13	172.0	20.51	193.0	23.40	213.8	25.40
	12	108.8	12.83	129.6	15.27	150.4	18.07	161.2	19.46	172.0	20.86	193.0	23.83	213.8	25.91
	14	108.8	13.00	129.6	15.62	150.4	18.32	161.2	19.81	172.0	21.21	193.0	24.26	213.8	26.40
	16	108.8	13.18	129.6	15.89	150.4	18.67	161.2	20.16	172.0	21.64	193.0	24.80	213.8	26.91
	18	108.8	13.45	129.6	16.16	150.4	19.02	161.2	20.51	172.0	22.08	193.0	25.23	213.8	27.50
	20	108.8	13.70	129.6	16.51	150.4	19.46	161.2	20.94	172.0	22.53	193.0	26.18	213.8	29.13
	21	108.8	13.78	129.6	16.67	150.4	19.64	161.2	21.21	172.0	23.05	193.0	27.02	213.8	29.91
	23	108.8	14.05	129.6	16.94	150.4	20.51	161.2	22.53	172.0	24.61	193.0	28.53	213.8	31.39
	25	108.8	14.59	129.6	18.07	150.4	21.99	161.2	24.10	172.0	26.37	193.0	30.53	213.8	33.56
	27	108.8	15.45	129.6	19.21	150.4	23.48	161.2	25.75	172.0	28.10	193.0	32.43	213.8	35.31
	29	108.8	16.40	129.6	20.51	150.4	24.97	161.2	27.42	172.0	30.02	193.0	34.75	213.8	37.80
	31	108.8	17.46	129.6	21.73	150.4	26.62	161.2	29.24	172.0	31.96	193.0	36.88	213.8	39.69
	33	108.8	18.51	129.6	23.21	150.4	28.37	161.2	31.16	172.0	34.04	193.0	38.85	213.8	41.61
	35	108.8	19.64	129.6	24.61	150.4	30.21	161.2	33.18	172.0	36.31	193.0	41.20	211.6	43.12
	37	108.8	20.78	129.6	26.18	150.4	32.04	161.2	35.26	172.0	38.58	193.0	43.48	208.2	45.07
	39	108.8	21.96	129.6	27.67	150.4	34.26	161.2	37.91	172.0	41.47	193.0	45.93	204.7	47.55
	41	106.0	24.29	126.3	30.67	146.5	37.61	157.1	41.56	167.6	45.56	188.0	51.12	196.1	52.69
	43	103.3	26.75	123.2	33.45	142.9	41.07	153.2	45.29	163.6	49.79	183.3	54.71	188.0	56.41
46	96.9	29.75	115.5	37.69	134.0	46.26	143.7	50.42	153.2	56.17	167.8	59.71	171.7	60.68	
48	85.6	25.99	102.2	32.96	118.5	40.45	127.1	44.04	135.7	49.18	145.7	51.69	149.2	52.23	

Note

1. TC: Total Capacity(kW), PI : Power Input(kW, Comp. + Outdoor fan motor)
2. Capacity tables show the average value of conditions which may occur.

7. Capacity Tables

Combination (%)	Outdoor air temp (°C DB)	Cooling Capacity(72HP)													
		Indoor air temp. (DB/WB, °C)													
		20		23		26		27		28		30		32	
		14	16	18	19	20	22	24							
	TC	PI	TC	PI	TC	PI	TC	PI	TC	PI	TC	PI	TC	PI	
70	10	95.0	11.04	113.8	13.13	131.8	15.22	141.2	16.44	150.4	17.56	168.4	20.00	187.2	22.36
	12	95.0	11.21	113.8	13.30	131.8	15.55	141.2	16.69	150.4	17.91	168.4	20.35	187.2	22.79
	14	95.0	11.39	113.8	13.48	131.8	15.82	141.2	16.96	150.4	18.18	168.4	20.78	187.2	23.20
	16	95.0	11.56	113.8	13.73	131.8	16.09	141.2	17.31	150.4	18.51	168.4	21.13	187.2	23.69
	18	95.0	11.75	113.8	14.00	131.8	16.44	141.2	17.64	150.4	18.86	168.4	21.47	187.2	24.12
	20	95.0	11.91	113.8	14.25	131.8	16.69	141.2	17.99	150.4	19.29	168.4	22.00	187.2	25.04
	21	95.0	12.08	113.8	14.35	131.8	16.87	141.2	18.18	150.4	19.48	168.4	22.33	187.2	25.56
	23	95.0	12.26	113.8	14.68	131.8	17.21	141.2	18.78	150.4	20.43	168.4	23.91	187.2	27.00
	25	95.0	12.43	113.8	15.22	131.8	18.34	141.2	20.08	150.4	21.82	168.4	25.56	187.2	28.30
	27	95.0	13.13	113.8	16.25	131.8	19.56	141.2	21.30	150.4	23.31	168.4	27.30	187.2	30.09
	29	95.0	14.00	113.8	17.21	131.8	20.78	141.2	22.69	150.4	24.77	168.4	29.12	187.2	32.23
	31	95.0	14.87	113.8	18.34	131.8	22.17	141.2	24.26	150.4	26.43	168.4	31.04	187.2	34.19
	33	95.0	15.74	113.8	19.38	131.8	23.55	141.2	25.73	150.4	28.08	168.4	33.03	187.2	36.41
	35	95.0	16.61	113.8	20.70	131.8	25.04	141.2	27.38	150.4	29.90	168.4	35.22	187.2	38.61
	37	95.0	17.64	113.8	21.92	131.8	26.59	141.2	29.12	150.4	31.83	168.4	37.47	187.2	40.73
	39	95.0	18.75	113.8	23.36	131.8	28.44	141.2	31.34	150.4	34.38	168.4	40.10	187.2	43.93
	41	92.5	20.73	110.8	25.59	128.5	31.20	137.6	34.38	146.5	37.36	164.2	44.04	182.5	47.38
	43	90.3	22.55	108.0	27.90	125.2	34.05	134.1	37.47	142.9	40.81	160.1	48.11	177.8	51.23
46	84.7	25.07	101.3	31.37	117.4	38.34	125.7	41.73	134.0	45.99	150.1	54.27	166.7	57.09	
48	74.8	21.87	89.7	27.40	103.8	33.51	111.1	36.47	118.5	40.24	132.7	47.49	147.6	49.41	
60	10	81.4	9.51	97.2	11.17	113.0	13.00	121.0	13.93	128.8	14.80	144.8	16.79	160.6	18.78
	12	81.4	9.70	97.2	11.34	113.0	13.16	121.0	14.11	128.8	15.07	144.8	17.06	160.6	19.13
	14	81.4	9.78	97.2	11.52	113.0	13.41	121.0	14.36	128.8	15.32	144.8	17.41	160.6	19.48
	16	81.4	9.95	97.2	11.77	113.0	13.60	121.0	14.63	128.8	15.67	144.8	17.74	160.6	19.82
	18	81.4	10.14	97.2	11.94	113.0	13.85	121.0	14.88	128.8	15.94	144.8	18.01	160.6	20.25
	20	81.4	10.30	97.2	12.13	113.0	14.11	121.0	15.15	128.8	16.19	144.8	18.34	160.6	20.69
	21	81.4	10.38	97.2	12.21	113.0	14.28	121.0	15.32	128.8	16.35	144.8	18.61	160.6	20.87
	23	81.4	10.57	97.2	12.46	113.0	14.47	121.0	15.59	128.8	16.71	144.8	19.30	160.6	22.16
	25	81.4	10.74	97.2	12.73	113.0	15.07	121.0	16.35	128.8	17.74	144.8	20.60	160.6	23.71
	27	81.4	11.09	97.2	13.41	113.0	16.02	121.0	17.41	128.8	18.88	144.8	21.91	160.6	25.29
	29	81.4	11.77	97.2	14.28	113.0	17.06	121.0	18.53	128.8	20.08	144.8	23.38	160.6	27.01
	31	81.4	12.46	97.2	15.15	113.0	18.09	121.0	19.73	128.8	21.39	144.8	24.93	160.6	28.75
	33	81.4	13.16	97.2	16.02	113.0	19.21	121.0	20.95	128.8	22.76	144.8	26.49	160.6	30.65
	35	81.4	13.93	97.2	17.06	113.0	20.44	121.0	22.24	128.8	24.15	144.8	28.23	160.6	32.54
	37	81.4	14.72	97.2	17.99	113.0	21.64	121.0	23.63	128.8	25.62	144.8	29.95	160.6	34.63
	39	81.4	15.64	97.2	19.16	113.0	23.36	121.0	25.35	128.8	27.58	144.8	32.13	160.6	37.11
	41	79.2	16.98	94.7	20.98	110.2	25.37	117.9	27.69	125.5	29.93	141.0	35.24	156.5	40.33
	43	77.3	18.45	92.5	22.84	107.4	27.66	114.9	30.19	122.4	32.65	137.6	38.48	152.6	44.04
46	72.5	20.66	86.6	25.64	100.8	31.10	107.7	33.93	114.7	36.73	128.8	43.36	142.9	50.17	
48	64.0	18.01	76.7	22.37	89.1	27.17	95.3	29.63	101.6	32.10	114.1	37.91	126.5	43.90	
50	10	68.1	8.19	81.4	9.47	94.4	10.78	100.8	11.55	107.2	12.24	120.2	13.79	134.0	15.35
	12	68.1	8.27	81.4	9.58	94.4	10.95	100.8	11.72	107.2	12.51	120.2	14.04	134.0	15.60
	14	68.1	8.37	81.4	9.74	94.4	11.11	100.8	11.90	107.2	12.67	120.2	14.23	134.0	15.87
	16	68.1	8.54	81.4	9.91	94.4	11.30	100.8	12.15	107.2	12.84	120.2	14.48	134.0	16.12
	18	68.1	8.62	81.4	9.99	94.4	11.47	100.8	12.32	107.2	13.11	120.2	14.75	134.0	16.47
	20	68.1	8.70	81.4	10.18	94.4	11.72	100.8	12.51	107.2	13.36	120.2	15.00	134.0	16.81
	21	68.1	8.79	81.4	10.26	94.4	11.82	100.8	12.67	107.2	13.44	120.2	15.17	134.0	16.97
	23	68.1	8.97	81.4	10.43	94.4	11.99	100.8	12.84	107.2	13.71	120.2	15.44	134.0	17.33
	25	68.1	9.06	81.4	10.60	94.4	12.24	100.8	13.11	107.2	14.15	120.2	16.20	134.0	18.53
	27	68.1	9.22	81.4	10.95	94.4	12.92	100.8	13.96	107.2	15.00	120.2	17.33	134.0	19.74
	29	68.1	9.74	81.4	11.63	94.4	13.71	100.8	14.83	107.2	15.96	120.2	18.37	134.0	20.94
	31	68.1	10.26	81.4	12.32	94.4	14.56	100.8	15.69	107.2	16.97	120.2	19.57	134.0	22.33
	33	68.1	10.87	81.4	13.03	94.4	15.44	100.8	16.64	107.2	18.01	120.2	20.78	134.0	23.79
	35	68.1	11.47	81.4	13.79	94.4	16.29	100.8	17.68	107.2	19.05	120.2	21.98	134.0	25.26
	37	68.1	12.15	81.4	14.56	94.4	17.24	100.8	18.70	107.2	20.17	120.2	23.45	134.0	26.82
	39	68.1	12.97	81.4	15.63	94.4	18.48	100.8	20.14	107.2	21.65	120.2	24.99	134.0	28.96
	41	66.2	14.02	79.2	16.91	91.9	20.20	98.3	21.81	104.4	23.46	117.1	27.37	130.4	31.45
	43	64.6	15.24	77.3	18.39	89.7	21.98	95.8	23.76	101.9	25.54	114.3	29.86	127.4	34.30
46	60.6	17.08	72.5	20.63	83.9	24.66	89.7	26.66	95.5	28.66	107.1	33.59	119.3	38.62	
48	53.7	14.87	64.0	17.98	74.2	21.51	79.5	23.27	84.5	25.02	94.7	29.35	105.5	33.75	

Note

1. TC: Total Capacity(kW), PI : Power Input(kW, Comp. + Outdoor fan motor)
2. Capacity tables show the average value of conditions which may occur.

7. Capacity Tables

◆ A(C)RUN740LLS5

Combination (%)	Outdoor air temp (°C DB)	Indoor air temp. (DB/WB, °C)														Cooling Capacity(74HP)	
		20		23		26		27		28		30		32		TC	PI
		14		16		18		19		20		22		24			
		TC	PI	TC	PI	TC	PI	TC	PI	TC	PI	TC	PI	TC	PI		
130	10	205.2	24.77	244.5	30.27	261.9	35.12	269.5	35.83	276.9	36.13	290.3	36.41	297.7	36.56		
	12	205.2	25.38	244.5	31.36	261.9	36.56	269.5	36.81	276.9	37.09	290.3	37.40	297.7	37.73		
	14	205.2	26.25	244.5	32.49	261.9	37.93	269.5	38.21	276.9	38.52	290.3	38.83	297.7	39.17		
	16	205.2	27.20	244.5	33.63	261.9	39.64	269.5	40.01	276.9	40.32	290.3	40.69	297.7	41.02		
	18	205.2	28.33	244.5	35.57	261.9	41.47	269.5	42.36	276.9	42.70	290.3	43.12	297.7	43.41		
	20	205.2	29.59	244.5	37.90	261.9	43.52	269.5	46.58	276.9	46.97	286.1	47.42	293.7	47.76		
	21	205.2	30.35	244.5	39.23	261.9	44.42	269.5	49.30	276.9	49.70	284.6	50.20	292.0	50.54		
	23	205.2	32.57	244.5	41.27	261.9	46.72	269.5	54.41	273.5	54.84	280.3	55.39	287.8	55.76		
	25	205.2	34.79	244.5	43.63	261.9	49.92	266.2	60.34	269.5	60.82	276.9	61.43	284.6	61.85		
	27	205.2	37.23	244.5	46.66	258.7	53.20	261.9	66.43	266.2	66.96	273.5	67.61	280.3	68.09		
	29	205.2	39.67	244.5	49.87	254.4	57.25	258.1	73.00	261.9	73.45	269.5	74.10	276.9	74.38		
	31	205.2	42.34	243.6	52.53	250.2	60.90	254.4	72.69	258.1	73.14	265.3	73.79	272.7	74.07		
	33	205.2	45.09	239.4	55.67	247.0	65.31	251.0	72.02	254.4	72.47	261.9	73.11	268.6	73.39		
	35	205.2	48.10	235.1	58.29	242.8	70.73	247.0	71.09	251.0	71.51	257.8	72.16	265.3	72.44		
	37	205.2	51.29	231.9	61.18	239.4	69.80	242.8	70.16	247.0	70.58	253.6	71.20	261.2	71.48		
	39	205.2	54.61	227.7	64.38	235.1	68.87	239.4	69.21	242.8	69.63	250.2	70.25	257.8	70.53		
	41	200.1	57.93	218.3	67.61	225.7	67.94	229.1	68.28	233.6	68.68	240.5	69.30	247.1	69.57		
	43	195.0	61.10	209.2	66.66	216.6	66.99	219.7	67.33	224.2	67.75	231.1	68.34	237.4	68.62		
46	182.7	65.39	190.9	65.28	197.8	65.59	200.9	65.93	205.0	66.32	211.5	66.91	217.4	67.19			
48	161.7	63.57	165.7	63.76	171.9	63.90	174.7	64.07	178.4	64.63	184.1	65.05	189.3	65.30			
120	10	185.6	22.29	220.8	27.32	241.3	32.48	248.7	35.10	255.9	35.66	269.8	35.80	276.4	36.08		
	12	185.6	22.88	220.8	28.25	241.3	33.78	248.7	35.83	255.9	36.97	269.8	37.42	276.4	37.71		
	14	185.6	23.67	220.8	29.20	241.3	35.15	248.7	37.20	255.9	38.32	269.8	38.89	276.4	39.20		
	16	185.6	24.54	220.8	30.41	241.3	36.50	248.7	38.58	255.9	40.09	269.8	40.60	276.4	40.91		
	18	185.6	25.49	220.8	31.78	241.3	37.96	248.7	40.62	255.9	42.15	269.8	42.62	276.4	42.98		
	20	185.6	26.45	220.8	33.69	241.3	40.01	248.7	42.74	255.9	44.39	269.8	44.98	276.4	45.32		
	21	185.6	27.26	220.8	34.90	241.3	41.13	248.7	44.00	255.9	45.85	269.8	46.44	276.4	46.80		
	23	185.6	29.14	220.8	37.34	241.3	44.06	248.7	46.75	255.9	48.88	269.8	49.36	276.4	49.76		
	25	185.6	31.14	220.8	40.01	241.3	46.47	248.7	49.84	255.9	52.42	266.7	52.84	273.2	53.27		
	27	185.6	33.24	220.8	42.77	241.3	49.47	248.7	53.26	255.9	56.32	262.7	56.71	269.2	57.16		
	29	185.6	35.46	220.8	45.65	241.3	52.05	248.7	56.99	251.9	60.03	258.4	60.93	265.8	61.43		
	31	185.6	37.79	220.8	48.77	241.3	54.75	245.4	61.04	248.7	64.41	255.3	65.53	261.6	66.06		
	33	185.6	40.23	220.8	51.97	238.0	57.90	241.3	66.26	244.5	69.15	251.1	69.94	257.6	70.50		
	35	185.6	42.77	220.8	55.40	234.0	61.29	237.1	73.00	241.3	73.37	247.9	73.59	254.4	74.18		
	37	185.6	46.02	220.8	58.46	230.6	65.34	234.0	71.46	237.1	71.82	243.7	72.04	250.4	72.61		
	39	185.6	49.53	220.0	61.80	226.6	69.30	229.9	70.00	233.1	70.36	240.5	70.56	247.0	71.12		
	41	181.0	53.06	210.4	65.11	217.5	67.94	220.6	68.53	223.7	68.87	230.3	69.07	236.8	69.63		
	43	176.5	56.63	201.5	64.19	208.6	66.43	211.5	67.05	214.6	67.39	221.1	67.61	227.4	68.14		
46	165.4	60.90	183.9	62.67	190.4	64.33	193.3	64.86	196.3	65.19	202.1	65.39	208.1	65.90			
48	146.3	59.64	159.7	61.55	165.6	63.08	168.2	63.45	170.7	63.65	175.9	63.91	181.3	64.18			
110	10	166.3	20.05	198.4	24.43	221.5	29.03	227.9	31.42	242.2	33.81	247.9	34.76	264.7	35.32		
	12	166.3	20.67	198.4	25.27	221.5	30.24	227.9	32.29	242.2	35.07	247.9	36.22	264.7	37.04		
	14	166.3	21.31	198.4	26.39	221.5	31.59	227.9	33.89	242.2	36.84	247.9	37.90	264.7	38.69		
	16	166.3	22.07	198.4	27.35	221.5	32.91	227.9	35.38	242.2	38.55	247.9	39.59	264.7	40.29		
	18	166.3	22.89	198.4	28.50	221.5	34.79	227.9	37.26	242.2	40.66	247.9	41.47	264.7	42.23		
	20	166.3	23.70	198.4	29.93	221.5	36.90	227.9	38.97	242.2	42.62	247.9	43.69	264.7	44.39		
	21	166.3	24.23	198.4	30.80	221.5	37.85	227.9	40.01	242.2	43.83	247.9	44.92	264.7	45.63		
	23	166.3	25.83	198.4	33.02	221.5	39.96	227.9	42.25	242.2	46.30	247.9	47.28	264.7	48.07		
	25	166.3	27.60	198.4	35.24	221.5	42.22	227.9	44.67	242.2	48.91	247.9	49.61	261.5	50.62		
	27	166.3	29.48	198.4	37.68	221.5	44.61	227.9	47.28	242.2	51.07	247.9	52.25	257.6	53.15		
	29	166.3	31.47	198.4	40.23	221.5	47.14	227.9	50.06	242.2	53.99	247.9	54.92	254.4	55.74		
	31	166.3	33.47	198.4	42.88	221.5	49.81	227.9	53.04	238.3	56.72	244.7	57.84	250.4	58.43		
	33	166.3	35.68	198.4	45.65	221.5	52.64	227.9	56.21	235.1	59.89	240.8	60.90	247.1	61.23		
	35	166.3	37.90	198.4	48.77	221.5	55.59	227.9	59.55	231.1	63.23	236.8	63.79	243.1	64.12		
	37	166.3	40.17	198.4	51.75	221.5	58.68	224.8	63.09	227.1	66.68	233.6	66.91	239.1	67.10		
	39	166.3	43.30	198.4	55.00	217.5	61.91	220.6	67.49	224.0	69.97	229.4	70.11	235.9	70.17		
	41	162.2	46.44	193.3	58.23	208.3	65.30	211.5	73.00	214.3	73.00	220.5	73.59	226.0	74.18		
	43	158.0	48.77	188.4	60.67	199.5	69.24	202.9	70.02	205.5	69.88	211.5	70.27	216.9	70.47		
46	148.2	47.59	176.7	58.57	182.1	65.72	185.3	65.72	187.6	66.29	193.3	66.65	198.4	66.82			
48	131.0	46.22	153.4	56.43	158.2	62.53	161.1	62.95	163.1	63.25	168.2	63.43	172.5	63.68			

Note

1. TC: Total Capacity(kW), PI : Power Input(kW, Comp. + Outdoor fan motor)
2. Capacity tables show the average value of conditions which may occur.

7. Capacity Tables

Combination (%)	Outdoor air temp (°C DB)	Cooling Capacity(74HP)													
		Indoor air temp. (DB/WB, °C)													
		20		23		26		27		28		30		32	
		14	16	18	19	20	22	24							
	TC	PI	TC	PI	TC	PI	TC	PI	TC	PI	TC	PI	TC	PI	
100	10	139.8	18.05	166.5	21.93	193.8	26.03	207.2	28.13	220.6	30.21	244.5	33.64	249.9	33.91
	12	139.8	18.64	166.5	22.83	193.8	26.90	207.2	28.89	220.6	31.19	244.5	35.46	249.9	35.80
	14	139.8	19.21	166.5	23.75	193.8	28.05	207.2	30.13	220.6	32.54	244.5	37.43	249.9	37.79
	16	139.8	19.80	166.5	24.54	193.8	29.23	207.2	31.56	220.6	34.28	244.5	39.25	249.9	39.79
	18	139.8	20.38	166.5	25.44	193.8	30.38	207.2	33.10	220.6	36.36	244.5	41.47	249.9	41.78
	20	139.8	21.11	166.5	26.42	193.8	32.14	207.2	35.46	220.6	38.89	244.5	43.44	249.9	43.80
	21	139.8	21.56	166.5	27.04	193.8	33.24	207.2	36.67	220.6	40.34	244.5	44.44	249.9	44.79
	23	139.8	22.83	166.5	28.92	193.8	35.68	207.2	39.34	220.6	43.21	244.5	46.53	249.9	46.91
	25	139.8	24.26	166.5	30.80	193.8	38.13	207.2	42.11	220.6	46.21	244.5	48.52	247.7	48.91
	27	139.8	25.94	166.5	32.91	193.8	40.77	207.2	44.98	220.6	49.13	239.7	50.79	244.8	51.21
	29	139.8	27.60	166.5	35.13	193.8	43.55	207.2	48.10	220.6	52.00	235.3	52.84	241.1	53.26
	31	139.8	29.48	166.5	37.45	193.8	46.44	207.2	51.30	220.6	54.64	231.7	54.89	237.4	55.34
	33	139.8	31.25	166.5	39.90	193.8	49.53	207.2	54.75	220.6	56.69	228.0	56.94	233.7	57.39
	35	139.8	33.24	166.5	42.45	193.8	52.75	207.2	58.40	217.2	58.74	224.0	58.99	229.7	59.44
	37	139.8	35.60	166.5	45.52	193.8	55.87	207.2	61.18	213.5	61.49	219.7	61.74	224.9	62.30
	39	139.8	38.18	166.5	48.91	193.8	59.21	207.2	64.18	210.0	64.46	216.3	64.69	221.2	65.30
	41	137.7	40.74	163.9	52.28	190.7	62.55	198.9	67.16	203.2	67.44	208.0	67.67	214.6	68.31
	43	132.9	43.12	158.2	55.42	184.2	65.53	190.7	69.74	192.7	69.97	198.7	70.22	204.0	70.87
46	124.6	46.38	148.3	59.75	172.7	69.52	174.1	73.00	175.9	73.22	181.6	73.42	186.4	74.12	
48	110.2	40.04	131.2	51.69	149.1	59.41	151.2	61.94	152.8	62.14	157.9	62.28	162.2	62.78	
90	10	125.8	15.67	150.3	18.82	174.7	22.19	186.4	23.93	198.4	25.76	222.8	28.82	247.1	32.05
	12	125.8	15.85	150.3	19.13	174.7	22.58	186.4	24.41	198.4	26.32	222.8	29.38	247.1	32.61
	14	125.8	16.15	150.3	19.50	174.7	23.06	186.4	24.89	198.4	26.80	222.8	29.97	247.1	33.28
	16	125.8	16.43	150.3	19.89	174.7	23.54	186.4	25.36	198.4	27.30	222.8	30.53	247.1	33.85
	18	125.8	16.71	150.3	20.28	174.7	23.93	186.4	25.95	198.4	27.86	222.8	31.21	247.1	35.56
	20	125.8	17.00	150.3	20.65	174.7	24.41	186.4	26.43	198.4	28.93	222.8	33.40	247.1	37.25
	21	125.8	17.19	150.3	20.84	174.7	24.89	186.4	27.30	198.4	29.97	222.8	33.93	247.1	38.11
	23	125.8	17.58	150.3	21.71	174.7	26.62	186.4	29.30	198.4	32.10	222.8	35.98	243.7	39.91
	25	125.8	18.45	150.3	23.15	174.7	28.45	186.4	31.32	198.4	34.30	222.8	38.48	240.2	41.60
	27	125.8	19.69	150.3	24.69	174.7	30.36	186.4	33.43	198.4	36.71	222.8	40.90	236.8	43.56
	29	125.8	20.84	150.3	26.32	174.7	32.47	186.4	35.75	198.4	39.21	222.8	43.34	233.1	45.31
	31	125.8	22.19	150.3	28.06	174.7	34.60	186.4	38.06	198.4	41.80	222.8	45.50	229.7	47.07
	33	125.8	23.65	150.3	29.89	174.7	36.91	186.4	40.56	198.4	44.33	222.8	47.69	226.2	48.82
	35	125.8	25.08	150.3	31.71	174.7	39.21	186.4	43.23	198.4	47.02	218.9	50.42	222.6	51.60
	37	125.8	26.62	150.3	33.73	174.7	41.80	186.4	45.93	198.4	49.63	215.4	52.72	219.1	53.90
	39	125.8	28.18	150.3	35.87	174.7	44.24	186.4	48.88	198.4	52.19	211.8	55.59	215.5	56.26
	41	122.6	31.54	146.3	39.77	170.2	48.56	181.6	53.45	193.3	56.34	203.0	58.57	206.6	59.91
	43	119.5	34.04	142.8	42.98	165.9	53.03	177.3	57.58	188.4	60.42	194.7	62.72	198.1	63.48
46	112.1	38.31	133.8	48.93	155.4	60.44	166.2	65.28	171.3	67.11	177.6	68.85	181.0	68.96	
48	99.1	33.48	118.4	42.81	137.5	52.87	146.9	56.94	148.6	57.83	154.5	59.27	157.4	59.35	
80	10	111.8	13.06	133.2	15.70	154.6	18.42	165.7	19.88	176.8	21.32	198.4	24.32	219.7	26.40
	12	111.8	13.34	133.2	15.87	154.6	18.78	165.7	20.22	176.8	21.68	198.4	24.77	219.7	26.93
	14	111.8	13.51	133.2	16.23	154.6	19.04	165.7	20.59	176.8	22.04	198.4	25.22	219.7	27.44
	16	111.8	13.70	133.2	16.51	154.6	19.41	165.7	20.95	176.8	22.49	198.4	25.77	219.7	27.97
	18	111.8	13.98	133.2	16.79	154.6	19.77	165.7	21.32	176.8	22.95	198.4	26.22	219.7	28.58
	20	111.8	14.24	133.2	17.15	154.6	20.22	165.7	21.77	176.8	23.42	198.4	27.21	219.7	30.27
	21	111.8	14.32	133.2	17.33	154.6	20.41	165.7	22.04	176.8	23.95	198.4	28.08	219.7	31.08
	23	111.8	14.60	133.2	17.60	154.6	21.32	165.7	23.42	176.8	25.58	198.4	29.65	219.7	32.63
	25	111.8	15.16	133.2	18.78	154.6	22.86	165.7	25.05	176.8	27.40	198.4	31.73	219.7	34.88
	27	111.8	16.06	133.2	19.96	154.6	24.40	165.7	26.76	176.8	29.21	198.4	33.70	219.7	36.70
	29	111.8	17.05	133.2	21.32	154.6	25.95	165.7	28.50	176.8	31.20	198.4	36.11	219.7	39.28
	31	111.8	18.14	133.2	22.58	154.6	27.66	165.7	30.39	176.8	33.22	198.4	38.33	219.7	41.25
	33	111.8	19.23	133.2	24.12	154.6	29.48	165.7	32.38	176.8	35.38	198.4	40.38	219.7	43.24
	35	111.8	20.41	133.2	25.58	154.6	31.39	165.7	34.48	176.8	37.74	198.4	42.82	217.4	44.81
	37	111.8	21.59	133.2	27.21	154.6	33.30	165.7	36.65	176.8	40.10	198.4	45.18	214.0	46.84
	39	111.8	22.83	133.2	28.76	154.6	35.61	165.7	39.40	176.8	43.10	198.4	47.74	210.4	49.42
	41	109.0	25.24	129.8	31.87	150.6	39.09	161.4	43.19	172.2	47.35	193.3	53.13	201.5	54.76
	43	106.2	27.80	126.6	34.77	146.9	42.68	157.4	47.07	168.2	51.75	188.4	56.86	193.3	58.63
46	99.6	30.92	118.7	39.17	137.7	48.07	147.7	52.40	157.4	58.38	172.4	62.06	176.4	63.07	
48	88.0	27.01	105.0	34.26	121.8	42.04	130.6	45.77	139.4	51.11	149.7	53.72	153.4	54.28	

Note

1. TC: Total Capacity(kW), PI : Power Input(kW, Comp. + Outdoor fan motor)
2. Capacity tables show the average value of conditions which may occur.

7. Capacity Tables

Combination (%)	Outdoor air temp (°C DB)	Cooling Capacity(74HP)													
		Indoor air temp. (DB/WB, °C)													
		20		23		26		27		28		30		32	
		14	16	18	19	20	22	24							
	TC	PI	TC	PI	TC	PI	TC	PI	TC	PI	TC	PI	TC	PI	
70	10	97.6	11.42	117.0	13.59	135.5	15.75	145.1	17.01	154.6	18.16	173.1	20.69	192.4	23.13
	12	97.6	11.60	117.0	13.76	135.5	16.09	145.1	17.27	154.6	18.53	173.1	21.05	192.4	23.58
	14	97.6	11.79	117.0	13.95	135.5	16.37	145.1	17.54	154.6	18.80	173.1	21.50	192.4	24.00
	16	97.6	11.96	117.0	14.21	135.5	16.64	145.1	17.91	154.6	19.15	173.1	21.86	192.4	24.51
	18	97.6	12.15	117.0	14.48	135.5	17.01	145.1	18.25	154.6	19.51	173.1	22.21	192.4	24.95
	20	97.6	12.32	117.0	14.74	135.5	17.27	145.1	18.61	154.6	19.96	173.1	22.76	192.4	25.91
	21	97.6	12.49	117.0	14.85	135.5	17.46	145.1	18.80	154.6	20.15	173.1	23.11	192.4	26.45
	23	97.6	12.69	117.0	15.19	135.5	17.80	145.1	19.43	154.6	21.14	173.1	24.73	192.4	27.93
	25	97.6	12.86	117.0	15.75	135.5	18.98	145.1	20.77	154.6	22.57	173.1	26.44	192.4	29.28
	27	97.6	13.59	117.0	16.82	135.5	20.24	145.1	22.04	154.6	24.11	173.1	28.24	192.4	31.13
	29	97.6	14.48	117.0	17.80	135.5	21.50	145.1	23.47	154.6	25.63	173.1	30.12	192.4	33.35
	31	97.6	15.38	117.0	18.98	135.5	22.93	145.1	25.10	154.6	27.34	173.1	32.11	192.4	35.37
	33	97.6	16.28	117.0	20.05	135.5	24.37	145.1	26.61	154.6	29.05	173.1	34.17	192.4	37.67
	35	97.6	17.18	117.0	21.42	135.5	25.91	145.1	28.33	154.6	30.94	173.1	36.43	192.4	39.94
	37	97.6	18.25	117.0	22.68	135.5	27.51	145.1	30.12	154.6	32.93	173.1	38.77	192.4	42.14
	39	97.6	19.39	117.0	24.17	135.5	29.42	145.1	32.42	154.6	35.56	173.1	41.49	192.4	45.45
	41	95.1	21.44	113.9	26.48	132.0	32.28	141.4	35.56	150.6	38.66	168.8	45.56	187.5	49.02
	43	92.8	23.33	111.0	28.86	128.7	35.23	137.8	38.77	146.9	42.22	164.5	49.77	182.8	53.00
46	87.1	25.94	104.2	32.45	120.7	39.66	129.2	43.18	137.7	47.58	154.2	56.14	171.3	59.07	
48	76.9	22.63	92.2	28.35	106.7	34.67	114.2	37.73	121.8	41.63	136.4	49.13	151.7	51.12	
60	10	83.7	9.80	99.9	11.50	116.1	13.38	124.4	14.34	132.4	15.24	148.8	17.29	165.1	19.34
	12	83.7	9.99	99.9	11.68	116.1	13.55	124.4	14.54	132.4	15.52	148.8	17.57	165.1	19.70
	14	83.7	10.07	99.9	11.87	116.1	13.81	124.4	14.79	132.4	15.77	148.8	17.93	165.1	20.06
	16	83.7	10.25	99.9	12.12	116.1	14.00	124.4	15.07	132.4	16.14	148.8	18.27	165.1	20.41
	18	83.7	10.44	99.9	12.29	116.1	14.26	124.4	15.33	132.4	16.41	148.8	18.55	165.1	20.85
	20	83.7	10.61	99.9	12.49	116.1	14.54	124.4	15.60	132.4	16.67	148.8	18.89	165.1	21.30
	21	83.7	10.69	99.9	12.57	116.1	14.71	124.4	15.77	132.4	16.84	148.8	19.17	165.1	21.49
	23	83.7	10.89	99.9	12.83	116.1	14.90	124.4	16.05	132.4	17.20	148.8	19.87	165.1	22.82
	25	83.7	11.06	99.9	13.11	116.1	15.52	124.4	16.84	132.4	18.27	148.8	21.22	165.1	24.42
	27	83.7	11.42	99.9	13.81	116.1	16.50	124.4	17.93	132.4	19.44	148.8	22.56	165.1	26.04
	29	83.7	12.12	99.9	14.71	116.1	17.57	124.4	19.08	132.4	20.68	148.8	24.08	165.1	27.81
	31	83.7	12.83	99.9	15.60	116.1	18.63	124.4	20.32	132.4	22.03	148.8	25.68	165.1	29.60
	33	83.7	13.55	99.9	16.50	116.1	19.79	124.4	21.58	132.4	23.44	148.8	27.28	165.1	31.57
	35	83.7	14.34	99.9	17.57	116.1	21.05	124.4	22.90	132.4	24.87	148.8	29.07	165.1	33.51
	37	83.7	15.15	99.9	18.53	116.1	22.28	124.4	24.33	132.4	26.38	148.8	30.84	165.1	35.67
	39	83.7	16.11	99.9	19.73	116.1	24.05	124.4	26.10	132.4	28.40	148.8	33.08	165.1	38.22
	41	81.4	17.48	97.3	21.61	113.3	26.13	121.2	28.52	129.0	30.82	144.9	36.29	160.8	41.53
	43	79.4	19.00	95.0	23.52	110.4	28.48	118.1	31.09	125.8	33.62	141.4	39.62	156.8	45.35
46	74.5	21.27	89.1	26.41	103.6	32.02	110.7	34.94	117.9	37.83	132.4	44.65	146.9	51.67	
48	65.8	18.55	78.8	23.04	91.6	27.98	97.9	30.51	104.4	33.06	117.2	39.04	130.1	45.21	
50	10	70.0	8.39	83.7	9.71	97.0	11.05	103.6	11.84	110.2	12.54	123.5	14.14	137.7	15.74
	12	70.0	8.48	83.7	9.82	97.0	11.22	103.6	12.01	110.2	12.82	123.5	14.40	137.7	15.99
	14	70.0	8.58	83.7	9.99	97.0	11.39	103.6	12.20	110.2	12.99	123.5	14.59	137.7	16.27
	16	70.0	8.75	83.7	10.16	97.0	11.58	103.6	12.46	110.2	13.16	123.5	14.84	137.7	16.52
	18	70.0	8.84	83.7	10.24	97.0	11.75	103.6	12.63	110.2	13.44	123.5	15.12	137.7	16.89
	20	70.0	8.92	83.7	10.43	97.0	12.01	103.6	12.82	110.2	13.69	123.5	15.37	137.7	17.23
	21	70.0	9.01	83.7	10.52	97.0	12.12	103.6	12.99	110.2	13.78	123.5	15.55	137.7	17.40
	23	70.0	9.20	83.7	10.69	97.0	12.29	103.6	13.16	110.2	14.05	123.5	15.82	137.7	17.76
	25	70.0	9.28	83.7	10.86	97.0	12.54	103.6	13.44	110.2	14.50	123.5	16.61	137.7	18.99
	27	70.0	9.45	83.7	11.22	97.0	13.25	103.6	14.31	110.2	15.37	123.5	17.76	137.7	20.23
	29	70.0	9.99	83.7	11.92	97.0	14.05	103.6	15.20	110.2	16.35	123.5	18.82	137.7	21.46
	31	70.0	10.52	83.7	12.63	97.0	14.93	103.6	16.08	110.2	17.40	123.5	20.06	137.7	22.89
	33	70.0	11.14	83.7	13.35	97.0	15.82	103.6	17.06	110.2	18.46	123.5	21.29	137.7	24.38
	35	70.0	11.75	83.7	14.14	97.0	16.69	103.6	18.12	110.2	19.53	123.5	22.53	137.7	25.89
	37	70.0	12.46	83.7	14.93	97.0	17.67	103.6	19.17	110.2	20.68	123.5	24.04	137.7	27.49
	39	70.0	13.30	83.7	16.02	97.0	18.94	103.6	20.65	110.2	22.19	123.5	25.61	137.7	29.68
	41	68.1	14.37	81.4	17.33	94.5	20.70	101.0	22.36	107.3	24.04	120.4	28.06	134.1	32.23
	43	66.4	15.62	79.4	18.85	92.2	22.53	98.5	24.35	104.8	26.17	117.5	30.61	130.9	35.16
46	62.3	17.50	74.5	21.15	86.3	25.28	92.2	27.33	98.2	29.38	110.1	34.43	122.6	39.59	
48	55.2	15.24	65.8	18.43	76.3	22.05	81.7	23.85	86.8	25.64	97.3	30.08	108.4	34.59	

Note

1. TC: Total Capacity(kW), PI : Power Input(kW, Comp. + Outdoor fan motor)
2. Capacity tables show the average value of conditions which may occur.

7. Capacity Tables

◆ A(C)RUN760LLS5

Combination (%)	Outdoor air temp (°C DB)	Indoor air temp. (DB/WB, °C)														Cooling Capacity(76HP)	
		20		23		26		27		28		30		32		TC	PI
		14		16		18		19		20		22		24			
		TC	PI	TC	PI	TC	PI	TC	PI	TC	PI	TC	PI	TC	PI		
130	10	210.8	25.36	251.1	31.00	269.0	35.97	276.8	36.69	284.4	37.00	298.2	37.29	305.8	37.43		
	12	210.8	25.99	251.1	32.11	269.0	37.44	276.8	37.69	284.4	37.98	298.2	38.29	305.8	38.64		
	14	210.8	26.88	251.1	33.27	269.0	38.84	276.8	39.13	284.4	39.45	298.2	39.76	305.8	40.11		
	16	210.8	27.86	251.1	34.44	269.0	40.59	276.8	40.97	284.4	41.29	298.2	41.66	305.8	42.00		
	18	210.8	29.01	251.1	36.43	269.0	42.46	276.8	43.38	284.4	43.73	298.2	44.16	305.8	44.45		
	20	210.8	30.30	251.1	38.81	269.0	44.56	276.8	47.70	284.4	48.10	293.8	48.56	301.6	48.90		
	21	210.8	31.08	251.1	40.17	269.0	45.48	276.8	50.49	284.4	50.89	292.3	51.40	299.9	51.75		
	23	210.8	33.35	251.1	42.26	269.0	47.84	276.8	55.71	280.9	56.15	287.9	56.72	295.5	57.10		
	25	210.8	35.62	251.1	44.68	269.0	51.12	273.4	61.78	276.8	62.27	284.4	62.90	292.3	63.33		
	27	210.8	38.12	251.1	47.78	265.7	54.48	269.0	68.02	273.4	68.57	280.9	69.23	287.9	69.72		
	29	210.8	40.62	251.1	51.06	261.3	58.62	265.1	74.75	269.0	75.21	276.8	75.87	284.4	76.16		
	31	210.8	43.35	250.2	53.79	257.0	62.36	261.3	74.43	265.1	74.89	272.4	75.55	280.1	75.85		
	33	210.8	46.18	245.8	57.01	253.7	66.87	257.8	73.75	261.3	74.20	269.0	74.86	275.9	75.15		
	35	210.8	49.25	241.5	59.69	249.3	72.42	253.7	72.80	257.8	73.23	264.8	73.89	272.4	74.18		
	37	210.8	52.52	238.2	62.64	245.8	71.47	249.3	71.84	253.7	72.27	260.5	72.91	268.3	73.20		
	39	210.8	55.92	233.9	65.93	241.5	70.52	245.8	70.87	249.3	71.30	257.0	71.93	264.8	72.22		
	41	205.5	59.32	224.2	69.23	231.8	69.57	235.3	69.92	239.9	70.33	247.0	70.96	253.7	71.24		
	43	200.3	62.56	214.9	68.25	222.4	68.60	225.7	68.94	230.3	69.37	237.3	69.98	243.8	70.26		
	46	187.7	66.96	196.1	66.84	203.1	67.16	206.3	67.51	210.5	67.91	217.2	68.51	223.3	68.80		
	48	166.0	65.09	170.2	65.29	176.6	65.44	179.5	65.61	183.3	66.18	189.1	66.61	194.4	66.87		
120	10	190.6	22.83	226.8	27.98	247.9	33.26	255.4	35.94	262.8	36.51	277.1	36.65	283.9	36.94		
	12	190.6	23.43	226.8	28.92	247.9	34.59	255.4	36.69	262.8	37.86	277.1	38.32	283.9	38.61		
	14	190.6	24.24	226.8	29.90	247.9	35.99	255.4	38.09	262.8	39.24	277.1	39.82	283.9	40.14		
	16	190.6	25.12	226.8	31.13	247.9	37.38	255.4	39.50	262.8	41.06	277.1	41.57	283.9	41.89		
	18	190.6	26.10	226.8	32.54	247.9	38.87	255.4	41.60	262.8	43.16	277.1	43.65	283.9	44.01		
	20	190.6	27.09	226.8	34.50	247.9	40.97	255.4	43.76	262.8	45.45	277.1	46.05	283.9	46.41		
	21	190.6	27.92	226.8	35.74	247.9	42.12	255.4	45.05	262.8	46.95	277.1	47.55	283.9	47.92		
	23	190.6	29.84	226.8	38.24	247.9	45.11	255.4	47.87	262.8	50.05	277.1	50.55	283.9	50.95		
	25	190.6	31.88	226.8	40.97	247.9	47.58	255.4	51.03	262.8	53.67	273.9	54.11	280.6	54.54		
	27	190.6	34.04	226.8	43.79	247.9	50.65	255.4	54.53	262.8	57.67	269.8	58.07	276.5	58.53		
	29	190.6	36.31	226.8	46.75	247.9	53.30	255.4	58.36	258.7	61.47	265.4	62.39	273.0	62.90		
	31	190.6	38.70	226.8	49.94	247.9	56.06	252.0	62.51	255.4	65.95	262.2	67.10	268.7	67.65		
	33	190.6	41.20	226.8	53.22	244.4	59.29	247.9	67.85	251.1	70.81	257.8	71.61	264.6	72.19		
	35	190.6	43.79	226.8	56.73	240.3	62.76	243.5	74.75	247.9	75.12	254.6	75.35	261.3	75.95		
	37	190.6	47.12	226.8	59.86	236.8	66.90	240.3	73.17	243.5	73.54	250.3	73.77	257.2	74.35		
	39	190.6	50.72	226.0	63.28	232.7	70.96	236.1	71.67	239.4	72.04	247.0	72.25	253.7	72.82		
	41	185.9	54.33	216.0	66.67	223.3	69.57	226.5	70.18	229.8	70.52	236.5	70.73	243.2	71.30		
	43	181.2	57.99	207.0	65.72	214.3	68.02	217.2	68.66	220.4	69.00	227.1	69.23	233.6	69.77		
	46	169.8	62.36	188.8	64.17	195.6	65.87	198.5	66.41	201.6	66.75	207.6	66.95	213.7	67.48		
	48	150.3	61.07	164.0	63.02	170.1	64.60	172.7	64.98	175.3	65.18	180.7	65.44	186.2	65.72		
110	10	170.8	20.53	203.7	25.01	227.5	29.72	234.1	32.17	248.8	34.62	254.6	35.59	271.8	36.17		
	12	170.8	21.16	203.7	25.87	227.5	30.96	234.1	33.07	248.8	35.91	254.6	37.08	271.8	37.93		
	14	170.8	21.82	203.7	27.03	227.5	32.35	234.1	34.70	248.8	37.72	254.6	38.81	271.8	39.62		
	16	170.8	22.60	203.7	28.01	227.5	33.69	234.1	36.23	248.8	39.47	254.6	40.54	271.8	41.26		
	18	170.8	23.43	203.7	29.18	227.5	35.62	234.1	38.15	248.8	41.63	254.6	42.46	271.8	43.24		
	20	170.8	24.27	203.7	30.64	227.5	37.78	234.1	39.90	248.8	43.65	254.6	44.73	271.8	45.45		
	21	170.8	24.81	203.7	31.54	227.5	38.76	234.1	40.97	248.8	44.88	254.6	46.00	271.8	46.72		
	23	170.8	26.45	203.7	33.81	227.5	40.91	234.1	43.27	248.8	47.41	254.6	48.42	271.8	49.22		
	25	170.8	28.26	203.7	36.08	227.5	43.24	234.1	45.74	248.8	50.08	254.6	50.80	268.6	51.84		
	27	170.8	30.19	203.7	38.58	227.5	45.68	234.1	48.41	248.8	52.30	254.6	53.50	264.5	54.42		
	29	170.8	32.23	203.7	41.20	227.5	48.27	234.1	51.26	248.8	55.28	254.6	56.23	261.3	57.07		
	31	170.8	34.27	203.7	43.91	227.5	51.01	234.1	54.31	244.7	58.08	251.4	59.22	257.2	59.83		
	33	170.8	36.54	203.7	46.75	227.5	53.90	234.1	57.56	241.4	61.33	247.3	62.36	253.7	62.70		
	35	170.8	38.81	203.7	49.94	227.5	56.92	234.1	60.98	237.4	64.74	243.2	65.32	249.7	65.66		
	37	170.8	41.14	203.7	52.99	227.5	60.09	230.9	64.60	233.3	68.28	239.9	68.51	245.6	68.71		
	39	170.8	44.34	203.7	56.32	223.3	63.40	226.6	69.11	230.0	71.65	235.6	71.79	242.3	71.85		
	41	166.6	47.55	198.5	59.63	213.9	66.87	217.2	74.75	220.1	74.75	226.5	75.35	232.1	75.95		
	43	162.3	49.94	193.5	62.13	204.9	70.90	208.4	71.70	211.0	71.56	217.2	71.96	222.7	72.16		
	46	152.2	48.73	181.5	59.97	187.0	67.30	190.3	67.30	192.7	67.88	198.5	68.25	203.7	68.43		
	48	134.5	47.33	157.6	57.78	162.5	64.03	165.4	64.46	167.5	64.77	172.7	64.95	177.2	65.21		

Note

1. TC: Total Capacity(kW), PI : Power Input(kW, Comp. + Outdoor fan motor)
2. Capacity tables show the average value of conditions which may occur.

7. Capacity Tables

Combination (%)	Outdoor air temp (°C DB)	Cooling Capacity(76HP)													
		Indoor air temp. (DB/WB, °C)													
		20		23		26		27		28		30		32	
		14	16	18	19	20	22	24							
	TC	PI	TC	PI	TC	PI	TC	PI	TC	PI	TC	PI	TC	PI	
100	10	143.6	18.49	171.0	22.46	199.1	26.65	212.8	28.81	226.5	30.94	251.1	34.44	256.6	34.73
	12	143.6	19.09	171.0	23.38	199.1	27.55	212.8	29.58	226.5	31.94	251.1	36.31	256.6	36.66
	14	143.6	19.67	171.0	24.32	199.1	28.72	212.8	30.85	226.5	33.32	251.1	38.33	256.6	38.70
	16	143.6	20.27	171.0	25.13	199.1	29.93	212.8	32.32	226.5	35.10	251.1	40.19	256.6	40.74
	18	143.6	20.87	171.0	26.05	199.1	31.11	212.8	33.90	226.5	37.23	251.1	42.46	256.6	42.78
	20	143.6	21.62	171.0	27.05	199.1	32.92	212.8	36.31	226.5	39.82	251.1	44.48	256.6	44.85
	21	143.6	22.08	171.0	27.69	199.1	34.04	212.8	37.55	226.5	41.31	251.1	45.51	256.6	45.86
	23	143.6	23.37	171.0	29.61	199.1	36.54	212.8	40.28	226.5	44.25	251.1	47.64	256.6	48.04
	25	143.6	24.84	171.0	31.54	199.1	39.04	212.8	43.12	226.5	47.32	251.1	49.68	254.4	50.08
	27	143.6	26.56	171.0	33.70	199.1	41.75	212.8	46.06	226.5	50.31	246.2	52.01	251.4	52.44
	29	143.6	28.26	171.0	35.97	199.1	44.59	212.8	49.25	226.5	53.25	241.7	54.11	247.6	54.54
	31	143.6	30.19	171.0	38.35	199.1	47.55	212.8	52.53	226.5	55.95	238.0	55.21	243.8	56.66
	33	143.6	32.00	171.0	40.85	199.1	50.72	212.8	56.06	226.5	58.05	234.2	58.30	240.0	58.77
	35	143.6	34.04	171.0	43.47	199.1	54.02	212.8	59.80	223.0	60.15	230.0	60.40	235.9	60.87
	37	143.6	36.46	171.0	46.61	199.1	57.21	212.8	62.65	219.3	62.96	225.7	63.22	231.0	63.80
	39	143.6	39.10	171.0	50.08	199.1	60.63	212.8	65.72	215.7	66.01	222.1	66.24	227.2	66.87
	41	141.4	41.72	168.3	53.53	195.9	64.05	204.3	68.77	208.7	69.05	213.6	69.29	220.4	69.94
	43	136.5	44.16	162.5	56.75	189.2	67.10	195.8	71.41	197.9	71.65	204.1	71.90	209.6	72.57
46	128.0	47.49	152.3	61.18	177.4	71.18	178.8	74.75	180.7	74.98	186.5	75.18	191.5	75.90	
48	113.1	41.00	134.7	52.93	153.1	60.84	155.3	63.42	157.0	63.63	162.2	63.77	166.6	64.28	
90	10	129.2	16.05	154.3	19.28	179.4	22.73	191.5	24.51	203.7	26.38	228.8	29.52	253.8	32.82
	12	129.2	16.23	154.3	19.59	179.4	23.13	191.5	25.00	203.7	26.96	228.8	30.09	253.8	33.40
	14	129.2	16.54	154.3	19.97	179.4	23.62	191.5	25.49	203.7	27.45	228.8	30.69	253.8	34.09
	16	129.2	16.83	154.3	20.37	179.4	24.11	191.5	25.98	203.7	27.96	228.8	31.27	253.8	34.67
	18	129.2	17.12	154.3	20.77	179.4	24.51	191.5	26.58	203.7	28.54	228.8	31.96	253.8	36.42
	20	129.2	17.41	154.3	21.15	179.4	25.00	191.5	27.07	203.7	29.63	228.8	34.20	253.8	38.15
	21	129.2	17.61	154.3	21.35	179.4	25.49	191.5	27.96	203.7	30.70	228.8	34.75	253.8	39.03
	23	129.2	18.01	154.3	22.24	179.4	27.27	191.5	30.01	203.7	32.88	228.8	36.85	250.3	40.87
	25	129.2	18.90	154.3	23.71	179.4	29.14	191.5	32.08	203.7	35.13	228.8	39.41	246.7	42.61
	27	129.2	20.17	154.3	25.29	179.4	31.10	191.5	34.24	203.7	37.60	228.8	41.89	243.2	44.62
	29	129.2	21.35	154.3	26.96	179.4	33.26	191.5	36.62	203.7	40.16	228.8	44.39	239.4	46.40
	31	129.2	22.73	154.3	28.74	179.4	35.44	191.5	38.98	203.7	42.81	228.8	46.60	235.9	48.21
	33	129.2	24.22	154.3	30.61	179.4	37.80	191.5	41.54	203.7	45.40	228.8	48.85	232.3	50.00
	35	129.2	25.69	154.3	32.48	179.4	40.16	191.5	44.28	203.7	48.15	224.8	51.64	228.6	52.84
	37	129.2	27.27	154.3	34.55	179.4	42.81	191.5	47.04	203.7	50.83	221.3	53.99	225.1	55.20
	39	129.2	28.86	154.3	36.74	179.4	45.31	191.5	50.06	203.7	53.45	217.5	56.93	221.3	57.62
	41	126.0	32.30	150.3	40.73	174.8	49.74	186.5	54.74	198.5	57.70	208.4	59.98	212.2	61.36
	43	122.8	34.86	146.7	44.01	170.4	54.32	182.1	58.97	193.5	61.87	199.9	64.24	203.5	65.01
46	115.1	39.24	137.4	50.12	159.6	61.90	170.7	66.85	175.9	68.73	182.4	70.51	185.9	70.62	
48	101.7	34.29	121.6	43.84	141.2	54.14	150.8	58.31	152.6	59.23	158.7	60.70	161.6	60.78	
80	10	114.8	13.38	136.8	16.08	158.8	18.87	170.2	20.36	181.6	21.83	203.7	24.91	225.7	27.04
	12	114.8	13.66	136.8	16.25	158.8	19.24	170.2	20.71	181.6	22.21	203.7	25.37	225.7	27.58
	14	114.8	13.84	136.8	16.63	158.8	19.51	170.2	21.09	181.6	22.58	203.7	25.83	225.7	28.10
	16	114.8	14.04	136.8	16.91	158.8	19.88	170.2	21.46	181.6	23.04	203.7	26.40	225.7	28.65
	18	114.8	14.32	136.8	17.20	158.8	20.25	170.2	21.83	181.6	23.50	203.7	26.86	225.7	29.28
	20	114.8	14.59	136.8	17.57	158.8	20.71	170.2	22.29	181.6	23.98	203.7	27.87	225.7	31.01
	21	114.8	14.67	136.8	17.75	158.8	20.91	170.2	22.58	181.6	24.53	203.7	28.76	225.7	31.84
	23	114.8	14.96	136.8	18.03	158.8	21.83	170.2	23.98	181.6	26.20	203.7	30.37	225.7	33.42
	25	114.8	15.53	136.8	19.24	158.8	23.41	170.2	25.65	181.6	28.07	203.7	32.50	225.7	35.72
	27	114.8	16.45	136.8	20.45	158.8	25.00	170.2	27.41	181.6	29.92	203.7	34.52	225.7	37.59
	29	114.8	17.46	136.8	21.83	158.8	26.58	170.2	29.19	181.6	31.96	203.7	36.99	225.7	40.24
	31	114.8	18.58	136.8	23.13	158.8	28.34	170.2	31.12	181.6	34.02	203.7	39.26	225.7	42.25
	33	114.8	19.70	136.8	24.71	158.8	30.20	170.2	33.17	181.6	36.24	203.7	41.36	225.7	44.29
	35	114.8	20.91	136.8	26.20	158.8	32.16	170.2	35.32	181.6	38.66	203.7	43.86	223.3	45.90
	37	114.8	22.12	136.8	27.87	158.8	34.11	170.2	37.54	181.6	41.07	203.7	46.28	219.8	47.98
	39	114.8	23.38	136.8	29.45	158.8	36.48	170.2	40.36	181.6	44.15	203.7	48.90	216.0	50.62
	41	111.9	25.86	133.3	32.64	154.7	40.04	165.8	44.24	176.9	48.50	198.5	54.42	207.0	56.09
	43	109.0	28.47	130.1	35.61	150.9	43.72	161.7	48.21	172.7	53.01	193.5	58.24	198.5	60.06
46	102.3	31.67	121.9	40.12	141.5	49.24	151.7	53.67	161.7	59.80	177.1	63.57	181.2	64.60	
48	90.4	27.67	107.8	35.09	125.1	43.06	134.2	46.88	143.2	52.35	153.7	55.02	157.5	55.60	

Note

1. TC: Total Capacity(kW), PI : Power Input(kW, Comp. + Outdoor fan motor)
2. Capacity tables show the average value of conditions which may occur.

7. Capacity Tables

Combination (%)	Outdoor air temp (°C DB)	Cooling Capacity(76HP)													
		Indoor air temp. (DB/WB, °C)													
		20		23		26		27		28		30		32	
		14	16	18	19	20	22	24							
	TC	PI	TC	PI	TC	PI	TC	PI	TC	PI	TC	PI	TC	PI	
70	10	100.3	11.70	120.1	13.92	139.1	16.13	149.0	17.42	158.8	18.61	177.8	21.19	197.6	23.70
	12	100.3	11.88	120.1	14.09	139.1	16.48	149.0	17.69	158.8	18.98	177.8	21.57	197.6	24.15
	14	100.3	12.08	120.1	14.29	139.1	16.77	149.0	17.97	158.8	19.26	177.8	22.03	197.6	24.59
	16	100.3	12.25	120.1	14.55	139.1	17.05	149.0	18.34	158.8	19.62	177.8	22.40	197.6	25.11
	18	100.3	12.45	120.1	14.84	139.1	17.42	149.0	18.70	158.8	19.99	177.8	22.75	197.6	25.57
	20	100.3	12.62	120.1	15.10	139.1	17.69	149.0	19.07	158.8	20.45	177.8	23.32	197.6	26.54
	21	100.3	12.80	120.1	15.21	139.1	17.88	149.0	19.26	158.8	20.65	177.8	23.67	197.6	27.09
	23	100.3	13.00	120.1	15.56	139.1	18.24	149.0	19.90	158.8	21.65	177.8	25.34	197.6	28.61
	25	100.3	13.17	120.1	16.13	139.1	19.44	149.0	21.28	158.8	23.12	177.8	27.09	197.6	30.00
	27	100.3	13.92	120.1	17.23	139.1	20.73	149.0	22.58	158.8	24.70	177.8	28.93	197.6	31.89
	29	100.3	14.84	120.1	18.24	139.1	22.03	149.0	24.04	158.8	26.26	177.8	30.86	197.6	34.16
	31	100.3	15.76	120.1	19.44	139.1	23.50	149.0	25.71	158.8	28.01	177.8	32.90	197.6	36.24
	33	100.3	16.68	120.1	20.54	139.1	24.96	149.0	27.27	158.8	29.76	177.8	35.00	197.6	38.59
	35	100.3	17.60	120.1	21.94	139.1	26.54	149.0	29.02	158.8	31.69	177.8	37.33	197.6	40.92
	37	100.3	18.70	120.1	23.23	139.1	28.19	149.0	30.86	158.8	33.73	177.8	39.71	197.6	43.17
	39	100.3	19.87	120.1	24.76	139.1	30.14	149.0	33.21	158.8	36.43	177.8	42.50	197.6	46.56
	41	97.7	21.97	116.9	27.12	135.6	33.07	145.2	36.43	154.7	39.60	173.3	46.68	192.6	50.22
	43	95.3	23.90	114.0	29.57	132.1	36.09	141.5	39.72	150.9	43.25	169.0	50.99	187.7	54.30
46	89.4	26.57	107.0	33.25	123.9	40.64	132.7	44.23	141.5	48.75	158.4	57.52	176.0	60.51	
48	79.0	23.18	94.7	29.05	109.6	35.52	117.3	38.66	125.1	42.65	140.0	50.33	155.8	52.37	
60	10	85.9	10.04	102.6	11.79	119.3	13.71	127.7	14.70	136.0	15.62	152.8	17.72	169.5	19.82
	12	85.9	10.23	102.6	11.96	119.3	13.89	127.7	14.89	136.0	15.90	152.8	18.00	169.5	20.19
	14	85.9	10.32	102.6	12.16	119.3	14.15	127.7	15.16	136.0	16.16	152.8	18.37	169.5	20.56
	16	85.9	10.50	102.6	12.42	119.3	14.35	127.7	15.44	136.0	16.53	152.8	18.72	169.5	20.91
	18	85.9	10.69	102.6	12.60	119.3	14.61	127.7	15.70	136.0	16.82	152.8	19.00	169.5	21.37
	20	85.9	10.87	102.6	12.79	119.3	14.89	127.7	15.99	136.0	17.08	152.8	19.36	169.5	21.83
	21	85.9	10.96	102.6	12.88	119.3	15.07	127.7	16.16	136.0	17.26	152.8	19.64	169.5	22.02
	23	85.9	11.15	102.6	13.14	119.3	15.26	127.7	16.45	136.0	17.63	152.8	20.36	169.5	23.38
	25	85.9	11.33	102.6	13.43	119.3	15.90	127.7	17.26	136.0	18.72	152.8	21.74	169.5	25.02
	27	85.9	11.70	102.6	14.15	119.3	16.91	127.7	18.37	136.0	19.92	152.8	23.12	169.5	26.68
	29	85.9	12.42	102.6	15.07	119.3	18.00	127.7	19.55	136.0	21.19	152.8	24.67	169.5	28.50
	31	85.9	13.14	102.6	15.99	119.3	19.09	127.7	20.82	136.0	22.57	152.8	26.31	169.5	30.33
	33	85.9	13.89	102.6	16.91	119.3	20.27	127.7	22.11	136.0	24.01	152.8	27.95	169.5	32.35
	35	85.9	14.70	102.6	18.00	119.3	21.56	127.7	23.47	136.0	25.48	152.8	29.79	169.5	34.34
	37	85.9	15.53	102.6	18.98	119.3	22.83	127.7	24.93	136.0	27.03	152.8	31.60	169.5	36.54
	39	85.9	16.51	102.6	20.22	119.3	24.64	127.7	26.75	136.0	29.10	152.8	33.90	169.5	39.16
	41	83.6	17.91	100.0	22.14	116.3	26.77	124.5	29.22	132.5	31.58	148.8	37.18	165.2	42.55
	43	81.6	19.47	97.6	24.09	113.4	29.18	121.3	31.86	129.2	34.45	145.2	40.60	161.1	46.47
46	76.6	21.80	91.5	27.06	106.4	32.81	113.7	35.80	121.1	38.76	136.0	45.75	150.9	52.94	
48	67.6	19.00	80.9	23.61	94.1	28.67	100.6	31.26	107.2	33.87	120.4	40.00	133.6	46.32	
50	10	71.9	8.60	85.9	9.95	99.6	11.33	106.4	12.13	113.2	12.85	126.9	14.49	141.4	16.13
	12	71.9	8.69	85.9	10.06	99.6	11.50	106.4	12.31	113.2	13.14	126.9	14.75	141.4	16.39
	14	71.9	8.79	85.9	10.23	99.6	11.68	106.4	12.50	113.2	13.31	126.9	14.95	141.4	16.67
	16	71.9	8.97	85.9	10.41	99.6	11.87	106.4	12.77	113.2	13.49	126.9	15.21	141.4	16.93
	18	71.9	9.06	85.9	10.50	99.6	12.05	106.4	12.94	113.2	13.77	126.9	15.49	141.4	17.30
	20	71.9	9.14	85.9	10.69	99.6	12.31	106.4	13.14	113.2	14.03	126.9	15.76	141.4	17.65
	21	71.9	9.23	85.9	10.78	99.6	12.42	106.4	13.31	113.2	14.12	126.9	15.93	141.4	17.83
	23	71.9	9.43	85.9	10.95	99.6	12.59	106.4	13.49	113.2	14.40	126.9	16.21	141.4	18.20
	25	71.9	9.51	85.9	11.13	99.6	12.85	106.4	13.77	113.2	14.86	126.9	17.02	141.4	19.47
	27	71.9	9.69	85.9	11.50	99.6	13.57	106.4	14.66	113.2	15.76	126.9	18.20	141.4	20.73
	29	71.9	10.23	85.9	12.22	99.6	14.40	106.4	15.58	113.2	16.76	126.9	19.29	141.4	22.00
	31	71.9	10.78	85.9	12.94	99.6	15.30	106.4	16.48	113.2	17.83	126.9	20.56	141.4	23.46
	33	71.9	11.41	85.9	13.68	99.6	16.21	106.4	17.48	113.2	18.92	126.9	21.82	141.4	24.99
	35	71.9	12.05	85.9	14.49	99.6	17.11	106.4	18.57	113.2	20.01	126.9	23.09	141.4	26.54
	37	71.9	12.77	85.9	15.30	99.6	18.11	106.4	19.64	113.2	21.19	126.9	24.64	141.4	28.17
	39	71.9	13.63	85.9	16.41	99.6	19.41	106.4	21.16	113.2	22.74	126.9	26.24	141.4	30.42
	41	69.9	14.72	83.6	17.76	97.0	21.22	103.7	22.91	110.2	24.64	123.7	28.75	137.7	33.03
	43	68.2	16.01	81.6	19.32	94.7	23.09	101.1	24.95	107.6	26.82	120.7	31.36	134.4	36.03
46	64.0	17.94	76.6	21.67	88.6	25.90	94.7	28.01	100.8	30.10	113.1	35.28	126.0	40.57	
48	56.7	15.61	67.6	18.89	78.4	22.60	83.9	24.44	89.2	26.28	100.0	30.82	111.4	35.45	

Note

1. TC: Total Capacity(kW), PI : Power Input(kW, Comp. + Outdoor fan motor)
2. Capacity tables show the average value of conditions which may occur.

7. Capacity Tables

◆ A(C)RUN780LLS5

Combination (%)	Outdoor air temp (°C DB)	Indoor air temp. (DB/WB, °C)														Cooling Capacity(78HP)	
		20		23		26		27		28		30		32		TC	PI
		14		16		18		19		20		22		24			
		TC	PI	TC	PI	TC	PI	TC	PI	TC	PI	TC	PI	TC	PI		
130	10	216.3	26.46	257.7	32.34	276.0	37.53	284.1	38.28	291.9	38.61	306.0	38.91	313.8	39.06		
	12	216.3	27.12	257.7	33.51	276.0	39.06	284.1	39.33	291.9	39.63	306.0	39.96	313.8	40.32		
	14	216.3	28.05	257.7	34.71	276.0	40.53	284.1	40.83	291.9	41.16	306.0	41.49	313.8	41.85		
	16	216.3	29.07	257.7	35.94	276.0	42.36	284.1	42.75	291.9	43.08	306.0	43.47	313.8	43.83		
	18	216.3	30.27	257.7	38.01	276.0	44.31	284.1	45.27	291.9	45.63	306.0	46.08	313.8	46.38		
	20	216.3	31.62	257.7	40.50	276.0	46.50	284.1	49.77	291.9	50.19	301.5	50.67	309.6	51.03		
	21	216.3	32.43	257.7	41.91	276.0	47.46	284.1	52.68	291.9	53.10	300.0	53.64	307.8	54.00		
	23	216.3	34.80	257.7	44.10	276.0	49.92	284.1	58.14	288.3	58.59	295.5	59.19	303.3	59.58		
	25	216.3	37.17	257.7	46.62	276.0	53.34	280.5	64.47	284.1	64.98	291.9	65.64	300.0	66.09		
	27	216.3	39.78	257.7	49.86	272.7	56.85	276.0	70.98	280.5	71.55	288.3	72.24	295.5	72.75		
	29	216.3	42.39	257.7	53.28	268.2	61.17	272.1	78.00	276.0	78.48	284.1	79.17	291.9	79.47		
	31	216.3	45.24	256.8	56.13	263.7	65.07	268.2	77.67	272.1	78.15	279.6	78.84	287.4	79.14		
	33	216.3	48.18	252.3	59.49	260.4	69.78	264.6	76.95	268.2	77.43	276.0	78.12	283.2	78.42		
	35	216.3	51.39	247.8	62.28	255.9	75.57	260.4	75.96	264.6	76.41	271.8	77.10	279.6	77.40		
	37	216.3	54.81	244.5	65.37	252.3	74.58	255.9	74.97	260.4	75.42	267.3	76.08	275.4	76.38		
	39	216.3	58.35	240.0	68.79	247.8	73.59	252.3	73.95	255.9	74.40	263.7	75.06	271.8	75.36		
	41	210.9	61.89	230.1	72.24	237.9	72.60	241.5	72.96	246.3	73.38	253.5	74.04	260.4	74.34		
	43	205.5	65.28	220.5	71.22	228.3	71.58	231.6	71.94	236.4	72.39	243.6	73.02	250.2	73.32		
	46	192.6	69.87	201.3	69.75	208.5	70.08	211.8	70.44	216.0	70.86	222.9	71.49	229.2	71.79		
	48	170.4	67.92	174.6	68.13	181.2	68.28	184.2	68.46	188.1	69.06	194.1	69.51	199.5	69.78		
120	10	195.6	23.82	232.8	29.19	254.4	34.71	262.2	37.50	269.7	38.10	284.4	38.25	291.3	38.55		
	12	195.6	24.45	232.8	30.18	254.4	36.09	262.2	38.28	269.7	39.51	284.4	39.99	291.3	40.29		
	14	195.6	25.29	232.8	31.20	254.4	37.56	262.2	39.75	269.7	40.95	284.4	41.55	291.3	41.88		
	16	195.6	26.22	232.8	32.49	254.4	39.00	262.2	41.22	269.7	42.84	284.4	43.38	291.3	43.71		
	18	195.6	27.24	232.8	33.96	254.4	40.56	262.2	43.41	269.7	45.03	284.4	45.54	291.3	45.93		
	20	195.6	28.26	232.8	36.00	254.4	42.75	262.2	45.66	269.7	47.43	284.4	48.06	291.3	48.42		
	21	195.6	29.13	232.8	37.29	254.4	43.95	262.2	47.01	269.7	48.99	284.4	49.62	291.3	50.01		
	23	195.6	31.14	232.8	39.90	254.4	47.07	262.2	49.95	269.7	52.23	284.4	52.74	291.3	53.16		
	25	195.6	33.27	232.8	42.75	254.4	49.65	262.2	53.25	269.7	56.01	281.1	56.46	288.0	56.91		
	27	195.6	35.52	232.8	45.69	254.4	52.86	262.2	56.91	269.7	60.18	276.9	60.60	283.8	61.08		
	29	195.6	37.89	232.8	48.78	254.4	55.62	262.2	60.90	265.5	64.14	272.4	65.10	280.2	65.64		
	31	195.6	40.38	232.8	52.11	254.4	58.50	258.6	65.22	262.2	68.82	269.1	70.02	275.7	70.59		
	33	195.6	42.99	232.8	55.53	250.8	61.86	254.4	70.80	257.7	73.89	264.6	74.73	271.5	75.33		
	35	195.6	45.69	232.8	59.19	246.6	65.49	249.9	78.00	254.4	78.39	261.3	78.63	268.2	79.26		
	37	195.6	49.17	232.8	62.46	243.0	69.81	246.6	76.35	249.9	76.74	256.8	76.98	264.0	77.58		
	39	195.6	52.92	231.9	66.03	238.8	74.04	242.4	74.79	245.7	75.18	253.5	75.39	260.4	75.99		
	41	190.8	56.70	221.7	69.57	229.2	72.60	232.5	73.23	235.8	73.59	242.7	73.80	249.6	74.40		
	43	186.0	60.51	212.4	68.58	219.9	70.98	222.9	71.64	226.2	72.00	233.1	72.24	239.7	72.81		
	46	174.3	65.07	193.8	66.96	200.7	68.73	203.7	69.30	207.0	69.66	213.0	69.87	219.3	70.41		
	48	154.2	63.72	168.3	65.76	174.6	67.41	177.3	67.80	180.0	68.01	185.4	68.28	191.1	68.58		
110	10	175.2	21.42	209.1	26.10	233.4	31.02	240.3	33.57	255.3	36.12	261.3	37.14	279.0	37.74		
	12	175.2	22.08	209.1	27.00	233.4	32.31	240.3	34.50	255.3	37.47	261.3	38.70	279.0	39.57		
	14	175.2	22.77	209.1	28.20	233.4	33.75	240.3	36.21	255.3	39.36	261.3	40.50	279.0	41.34		
	16	175.2	23.58	209.1	29.22	233.4	35.16	240.3	37.80	255.3	41.19	261.3	42.30	279.0	43.05		
	18	175.2	24.45	209.1	30.45	233.4	37.17	240.3	39.81	255.3	43.44	261.3	44.31	279.0	45.12		
	20	175.2	25.32	209.1	31.98	233.4	39.42	240.3	41.64	255.3	45.54	261.3	46.68	279.0	47.43		
	21	175.2	25.89	209.1	32.91	233.4	40.44	240.3	42.75	255.3	46.83	261.3	48.00	279.0	48.75		
	23	175.2	27.60	209.1	35.28	233.4	42.69	240.3	45.15	255.3	49.47	261.3	50.52	279.0	51.36		
	25	175.2	29.49	209.1	37.65	233.4	45.12	240.3	47.73	255.3	52.26	261.3	53.01	275.7	54.09		
	27	175.2	31.50	209.1	40.26	233.4	47.67	240.3	50.52	255.3	54.57	261.3	55.83	271.5	56.79		
	29	175.2	33.63	209.1	42.99	233.4	50.37	240.3	53.49	255.3	57.69	261.3	58.68	268.2	59.55		
	31	175.2	35.76	209.1	45.81	233.4	53.22	240.3	56.67	251.1	60.60	258.0	61.80	264.0	62.43		
	33	175.2	38.13	209.1	48.78	233.4	56.25	240.3	60.06	247.8	63.99	253.8	65.07	260.4	65.43		
	35	175.2	40.50	209.1	52.11	233.4	59.40	240.3	63.63	243.6	67.56	249.6	68.16	256.2	68.52		
	37	175.2	42.93	209.1	55.29	233.4	62.70	237.0	67.41	239.4	71.25	246.3	71.49	252.0	71.70		
	39	175.2	46.26	209.1	58.77	229.2	66.15	232.5	72.12	236.1	74.76	241.8	74.91	248.7	74.97		
	41	171.0	49.62	203.7	62.22	219.6	69.78	222.9	78.00	225.9	78.00	232.5	78.63	238.2	79.26		
	43	166.5	52.11	198.6	64.83	210.3	73.98	213.9	74.82	216.6	74.67	222.9	75.09	228.6	75.30		
	46	156.3	50.85	186.3	62.58	192.0	70.23	195.3	70.23	197.7	70.83	203.7	71.22	209.1	71.40		
	48	138.0	49.38	161.7	60.30	166.8	66.81	169.8	67.26	171.9	67.59	177.3	67.77	181.8	68.04		

Note

1. TC: Total Capacity(kW), PI : Power Input(kW, Comp. + Outdoor fan motor)
2. Capacity tables show the average value of conditions which may occur.

7. Capacity Tables

Combination (%)	Outdoor air temp (°C DB)	Cooling Capacity(78HP)													
		Indoor air temp. (DB/WB, °C)													
		20		23		26		27		28		30		32	
		14	16	18	19	20	22	24							
	TC	PI	TC	PI	TC	PI	TC	PI	TC	PI	TC	PI	TC	PI	
100	10	147.3	19.29	175.5	23.43	204.3	27.81	218.4	30.06	232.5	32.28	257.7	35.94	263.4	36.24
	12	147.3	19.92	175.5	24.39	204.3	28.74	218.4	30.87	232.5	33.33	257.7	37.89	263.4	38.25
	14	147.3	20.52	175.5	25.38	204.3	29.97	218.4	32.19	232.5	34.77	257.7	39.99	263.4	40.38
	16	147.3	21.15	175.5	26.22	204.3	31.23	218.4	33.72	232.5	36.63	257.7	41.94	263.4	42.51
	18	147.3	21.78	175.5	27.18	204.3	32.46	218.4	35.37	232.5	38.85	257.7	44.31	263.4	44.64
	20	147.3	22.56	175.5	28.23	204.3	34.35	218.4	37.89	232.5	41.55	257.7	46.41	263.4	46.80
	21	147.3	23.04	175.5	28.89	204.3	35.52	218.4	39.18	232.5	43.11	257.7	47.49	263.4	47.85
	23	147.3	24.39	175.5	30.90	204.3	38.13	218.4	42.03	232.5	46.17	257.7	49.71	263.4	50.13
	25	147.3	25.92	175.5	32.91	204.3	40.74	218.4	45.00	232.5	49.38	257.7	51.84	261.0	52.26
	27	147.3	27.72	175.5	35.16	204.3	43.56	218.4	48.06	232.5	52.50	252.6	54.27	258.0	54.72
	29	147.3	29.49	175.5	37.53	204.3	46.53	218.4	51.39	232.5	55.56	248.1	56.46	254.1	56.91
	31	147.3	31.50	175.5	40.02	204.3	49.62	218.4	54.81	232.5	58.38	244.2	58.65	250.2	59.13
	33	147.3	33.39	175.5	42.63	204.3	52.92	218.4	58.50	232.5	60.57	240.3	60.84	246.3	61.32
	35	147.3	35.52	175.5	45.36	204.3	56.37	218.4	62.40	228.9	62.76	236.1	63.03	242.1	63.51
	37	147.3	38.04	175.5	48.63	204.3	59.70	218.4	65.37	225.0	65.70	231.6	65.97	237.0	66.57
	39	147.3	40.80	175.5	52.26	204.3	63.27	218.4	68.58	221.4	68.88	228.0	69.12	233.1	69.78
	41	145.2	43.53	172.8	55.86	201.0	66.84	209.7	71.76	214.2	72.06	219.3	72.30	226.2	72.99
	43	140.1	46.08	166.8	59.22	194.1	70.02	201.0	74.52	203.1	74.76	209.4	75.03	215.1	75.72
46	131.4	49.56	156.3	63.84	182.1	74.28	183.6	78.00	185.4	78.24	191.4	78.45	196.5	79.20	
48	116.1	42.78	138.3	55.23	157.2	63.48	159.3	66.18	161.1	66.39	166.5	66.54	171.0	67.08	
90	10	132.6	16.74	158.4	20.10	184.2	23.70	196.5	25.56	209.1	27.51	234.9	30.78	260.4	34.23
	12	132.6	16.92	158.4	20.43	184.2	24.12	196.5	26.07	209.1	28.11	234.9	31.38	260.4	34.83
	14	132.6	17.25	158.4	20.82	184.2	24.63	196.5	26.58	209.1	28.62	234.9	32.01	260.4	35.55
	16	132.6	17.55	158.4	21.24	184.2	25.14	196.5	27.09	209.1	29.16	234.9	32.61	260.4	36.15
	18	132.6	17.85	158.4	21.66	184.2	25.56	196.5	27.72	209.1	29.76	234.9	33.33	260.4	37.98
	20	132.6	18.15	158.4	22.05	184.2	26.07	196.5	28.23	209.1	30.90	234.9	35.67	260.4	39.78
	21	132.6	18.36	158.4	22.26	184.2	26.58	196.5	29.16	209.1	32.01	234.9	36.24	260.4	40.71
	23	132.6	18.78	158.4	23.19	184.2	28.44	196.5	31.29	209.1	34.29	234.9	38.43	256.8	42.63
	25	132.6	19.71	158.4	24.72	184.2	30.39	196.5	33.45	209.1	36.63	234.9	41.10	253.2	44.43
	27	132.6	21.03	158.4	26.37	184.2	32.43	196.5	35.70	209.1	39.21	234.9	43.68	249.6	46.53
	29	132.6	22.26	158.4	28.11	184.2	34.68	196.5	38.19	209.1	41.88	234.9	46.29	245.7	48.39
	31	132.6	23.70	158.4	29.97	184.2	36.96	196.5	40.65	209.1	44.64	234.9	48.60	242.1	50.28
	33	132.6	25.26	158.4	31.92	184.2	39.42	196.5	43.32	209.1	47.34	234.9	50.94	238.5	52.14
	35	132.6	26.79	158.4	33.87	184.2	41.88	196.5	46.17	209.1	50.22	230.7	53.85	234.6	55.11
	37	132.6	28.44	158.4	36.03	184.2	44.64	196.5	49.05	209.1	53.01	227.1	56.31	231.0	57.57
	39	132.6	30.09	158.4	38.31	184.2	47.25	196.5	52.20	209.1	55.74	223.2	59.37	227.1	60.09
	41	129.3	33.69	154.2	42.48	179.4	51.87	191.4	57.09	203.7	60.18	213.9	62.55	217.8	63.99
	43	126.0	36.36	150.6	45.90	174.9	56.64	186.9	61.50	198.6	64.53	205.2	66.99	208.8	67.80
46	118.2	40.92	141.0	52.26	163.8	64.56	175.2	69.72	180.6	71.67	187.2	73.53	190.8	73.65	
48	104.4	35.76	124.8	45.72	144.9	56.46	154.8	60.81	156.6	61.77	162.9	63.30	165.9	63.39	
80	10	117.9	13.95	140.4	16.77	162.9	19.68	174.6	21.24	186.3	22.77	209.1	25.98	231.6	28.20
	12	117.9	14.25	140.4	16.95	162.9	20.07	174.6	21.60	186.3	23.16	209.1	26.46	231.6	28.77
	14	117.9	14.43	140.4	17.34	162.9	20.34	174.6	21.99	186.3	23.55	209.1	26.94	231.6	29.31
	16	117.9	14.64	140.4	17.64	162.9	20.73	174.6	22.38	186.3	24.03	209.1	27.54	231.6	29.88
	18	117.9	14.94	140.4	17.94	162.9	21.12	174.6	22.77	186.3	24.51	209.1	28.02	231.6	30.54
	20	117.9	15.21	140.4	18.33	162.9	21.60	174.6	23.25	186.3	25.02	209.1	29.07	231.6	32.34
	21	117.9	15.30	140.4	18.51	162.9	21.81	174.6	23.55	186.3	25.59	209.1	30.00	231.6	33.21
	23	117.9	15.60	140.4	18.81	162.9	22.77	174.6	25.02	186.3	27.33	209.1	31.68	231.6	34.86
	25	117.9	16.20	140.4	20.07	162.9	24.42	174.6	26.76	186.3	29.28	209.1	33.90	231.6	37.26
	27	117.9	17.16	140.4	21.33	162.9	26.07	174.6	28.59	186.3	31.20	209.1	36.00	231.6	39.21
	29	117.9	18.21	140.4	22.77	162.9	27.72	174.6	30.45	186.3	33.33	209.1	38.58	231.6	41.97
	31	117.9	19.38	140.4	24.12	162.9	29.55	174.6	32.46	186.3	35.49	209.1	40.95	231.6	44.07
	33	117.9	20.55	140.4	25.77	162.9	31.50	174.6	34.59	186.3	37.80	209.1	43.14	231.6	46.20
	35	117.9	21.81	140.4	27.33	162.9	33.54	174.6	36.84	186.3	40.32	209.1	45.75	229.2	47.88
	37	117.9	23.07	140.4	29.07	162.9	35.58	174.6	39.15	186.3	42.84	209.1	48.27	225.6	50.04
	39	117.9	24.39	140.4	30.72	162.9	38.04	174.6	42.09	186.3	46.05	209.1	51.00	221.7	52.80
	41	114.9	26.97	136.8	34.05	158.7	41.76	170.1	46.14	181.5	50.58	203.7	56.76	212.4	58.50
	43	111.9	29.70	133.5	37.14	154.8	45.60	165.9	50.28	177.3	55.29	198.6	60.75	203.7	62.64
46	105.0	33.03	125.1	41.85	145.2	51.36	155.7	55.98	165.9	62.37	181.8	66.30	186.0	67.38	
48	92.7	28.86	110.7	36.60	128.4	44.91	137.7	48.90	147.0	54.60	157.8	57.39	161.7	57.99	

Note

1. TC: Total Capacity(kW), PI : Power Input(kW, Comp. + Outdoor fan motor)
2. Capacity tables show the average value of conditions which may occur.

7. Capacity Tables

Combination (%)	Outdoor air temp (°C DB)	Cooling Capacity(78HP)													
		Indoor air temp. (DB/WB, °C)													
		20		23		26		27		28		30		32	
		14	16	18	19	20	22	24							
	TC	PI	TC	PI	TC	PI	TC	PI	TC	PI	TC	PI	TC	PI	
70	10	102.9	12.21	123.3	14.52	142.8	16.83	153.0	18.18	162.9	19.41	182.4	22.11	202.8	24.72
	12	102.9	12.39	123.3	14.70	142.8	17.19	153.0	18.45	162.9	19.80	182.4	22.50	202.8	25.20
	14	102.9	12.60	123.3	14.91	142.8	17.49	153.0	18.75	162.9	20.10	182.4	22.98	202.8	25.65
	16	102.9	12.78	123.3	15.18	142.8	17.79	153.0	19.14	162.9	20.46	182.4	23.37	202.8	26.19
	18	102.9	12.99	123.3	15.48	142.8	18.18	153.0	19.50	162.9	20.85	182.4	23.73	202.8	26.67
	20	102.9	13.17	123.3	15.75	142.8	18.45	153.0	19.89	162.9	21.33	182.4	24.33	202.8	27.69
	21	102.9	13.35	123.3	15.87	142.8	18.66	153.0	20.10	162.9	21.54	182.4	24.69	202.8	28.26
	23	102.9	13.56	123.3	16.23	142.8	19.02	153.0	20.76	162.9	22.59	182.4	26.43	202.8	29.85
	25	102.9	13.74	123.3	16.83	142.8	20.28	153.0	22.20	162.9	24.12	182.4	28.26	202.8	31.29
	27	102.9	14.52	123.3	17.97	142.8	21.63	153.0	23.55	162.9	25.77	182.4	30.18	202.8	33.27
	29	102.9	15.48	123.3	19.02	142.8	22.98	153.0	25.08	162.9	27.39	182.4	32.19	202.8	35.64
	31	102.9	16.44	123.3	20.28	142.8	24.51	153.0	26.82	162.9	29.22	182.4	34.32	202.8	37.80
	33	102.9	17.40	123.3	21.42	142.8	26.04	153.0	28.44	162.9	31.05	182.4	36.51	202.8	40.26
	35	102.9	18.36	123.3	22.89	142.8	27.69	153.0	30.27	162.9	33.06	182.4	38.94	202.8	42.69
	37	102.9	19.50	123.3	24.24	142.8	29.40	153.0	32.19	162.9	35.19	182.4	41.43	202.8	45.03
	39	102.9	20.73	123.3	25.83	142.8	31.44	153.0	34.65	162.9	38.01	182.4	44.34	202.8	48.57
	41	100.2	22.92	120.0	28.29	139.2	34.50	149.1	38.01	158.7	41.31	177.9	48.69	197.7	52.38
	43	97.8	24.93	117.0	30.84	135.6	37.65	145.2	41.43	154.8	45.12	173.4	53.19	192.6	56.64
46	91.8	27.72	109.8	34.68	127.2	42.39	136.2	46.14	145.2	50.85	162.6	60.00	180.6	63.12	
48	81.0	24.18	97.2	30.30	112.5	37.05	120.3	40.32	128.4	44.49	143.7	52.50	159.9	54.63	
60	10	88.2	10.47	105.3	12.30	122.4	14.31	131.1	15.33	139.5	16.29	156.9	18.48	174.0	20.67
	12	88.2	10.68	105.3	12.48	122.4	14.49	131.1	15.54	139.5	16.59	156.9	18.78	174.0	21.06
	14	88.2	10.77	105.3	12.69	122.4	14.76	131.1	15.81	139.5	16.86	156.9	19.17	174.0	21.45
	16	88.2	10.95	105.3	12.96	122.4	14.97	131.1	16.11	139.5	17.25	156.9	19.53	174.0	21.81
	18	88.2	11.16	105.3	13.14	122.4	15.24	131.1	16.38	139.5	17.55	156.9	19.83	174.0	22.29
	20	88.2	11.34	105.3	13.35	122.4	15.54	131.1	16.68	139.5	17.82	156.9	20.19	174.0	22.77
	21	88.2	11.43	105.3	13.44	122.4	15.72	131.1	16.86	139.5	18.00	156.9	20.49	174.0	22.98
	23	88.2	11.64	105.3	13.71	122.4	15.93	131.1	17.16	139.5	18.39	156.9	21.24	174.0	24.39
	25	88.2	11.82	105.3	14.01	122.4	16.59	131.1	18.00	139.5	19.53	156.9	22.68	174.0	26.10
	27	88.2	12.21	105.3	14.76	122.4	17.64	131.1	19.17	139.5	20.79	156.9	24.12	174.0	27.84
	29	88.2	12.96	105.3	15.72	122.4	18.78	131.1	20.40	139.5	22.11	156.9	25.74	174.0	29.73
	31	88.2	13.71	105.3	16.68	122.4	19.92	131.1	21.72	139.5	23.55	156.9	27.45	174.0	31.65
	33	88.2	14.49	105.3	17.64	122.4	21.15	131.1	23.07	139.5	25.05	156.9	29.16	174.0	33.75
	35	88.2	15.33	105.3	18.78	122.4	22.50	131.1	24.48	139.5	26.58	156.9	31.08	174.0	35.82
	37	88.2	16.20	105.3	19.80	122.4	23.82	131.1	26.01	139.5	28.20	156.9	32.97	174.0	38.13
	39	88.2	17.22	105.3	21.09	122.4	25.71	131.1	27.90	139.5	30.36	156.9	35.37	174.0	40.86
	41	85.8	18.69	102.6	23.10	119.4	27.93	127.8	30.48	135.9	32.94	152.7	38.79	169.5	44.40
	43	83.7	20.31	100.2	25.14	116.4	30.45	124.5	33.24	132.6	35.94	149.1	42.36	165.3	48.48
46	78.6	22.74	93.9	28.23	109.2	34.23	116.7	37.35	124.2	40.44	139.5	47.73	154.8	55.23	
48	69.3	19.83	83.1	24.63	96.6	29.91	103.2	32.61	110.1	35.34	123.6	41.73	137.1	48.33	
50	10	73.8	8.97	88.2	10.38	102.3	11.82	109.2	12.66	116.1	13.41	130.2	15.12	145.2	16.83
	12	73.8	9.06	88.2	10.50	102.3	12.00	109.2	12.84	116.1	13.71	130.2	15.39	145.2	17.10
	14	73.8	9.18	88.2	10.68	102.3	12.18	109.2	13.05	116.1	13.89	130.2	15.60	145.2	17.40
	16	73.8	9.36	88.2	10.86	102.3	12.39	109.2	13.32	116.1	14.07	130.2	15.87	145.2	17.67
	18	73.8	9.45	88.2	10.95	102.3	12.57	109.2	13.50	116.1	14.37	130.2	16.17	145.2	18.06
	20	73.8	9.54	88.2	11.16	102.3	12.84	109.2	13.71	116.1	14.64	130.2	16.44	145.2	18.42
	21	73.8	9.63	88.2	11.25	102.3	12.96	109.2	13.89	116.1	14.73	130.2	16.62	145.2	18.60
	23	73.8	9.84	88.2	11.43	102.3	13.14	109.2	14.07	116.1	15.03	130.2	16.92	145.2	18.99
	25	73.8	9.93	88.2	11.61	102.3	13.41	109.2	14.37	116.1	15.51	130.2	17.76	145.2	20.31
	27	73.8	10.11	88.2	12.00	102.3	14.16	109.2	15.30	116.1	16.44	130.2	18.99	145.2	21.63
	29	73.8	10.68	88.2	12.75	102.3	15.03	109.2	16.26	116.1	17.49	130.2	20.13	145.2	22.95
	31	73.8	11.25	88.2	13.50	102.3	15.96	109.2	17.19	116.1	18.60	130.2	21.45	145.2	24.48
	33	73.8	11.91	88.2	14.28	102.3	16.92	109.2	18.24	116.1	19.74	130.2	22.77	145.2	26.07
	35	73.8	12.57	88.2	15.12	102.3	17.85	109.2	19.38	116.1	20.88	130.2	24.09	145.2	27.69
	37	73.8	13.32	88.2	15.96	102.3	18.90	109.2	20.49	116.1	22.11	130.2	25.71	145.2	29.40
	39	73.8	14.22	88.2	17.13	102.3	20.25	109.2	22.08	116.1	23.73	130.2	27.39	145.2	31.74
	41	71.7	15.36	85.8	18.54	99.6	22.14	106.5	23.91	113.1	25.71	126.9	30.00	141.3	34.47
	43	69.9	16.71	83.7	20.16	97.2	24.09	103.8	26.04	110.4	27.99	123.9	32.73	138.0	37.59
46	65.7	18.72	78.6	22.62	90.9	27.03	97.2	29.22	103.5	31.41	116.1	36.81	129.3	42.33	
48	58.2	16.29	69.3	19.71	80.4	23.58	86.1	25.50	91.5	27.42	102.6	32.16	114.3	36.99	

Note

1. TC: Total Capacity(kW), PI : Power Input(kW, Comp. + Outdoor fan motor)
2. Capacity tables show the average value of conditions which may occur.

7. Capacity Tables

7.1.4 Four Unit

◆ A(C)RUN800LLS5

Combination (%)	Outdoor air temp (°C DB)	Cooling Capacity(80HP)													
		Indoor air temp. (DB/WB, °C)													
		20		23		26		27		28		30		32	
		14	16	18	19	20	22	24							
		TC	PI	TC	PI	TC	PI	TC	PI	TC	PI	TC	PI	TC	PI
130	10	221.9	26.47	264.2	32.34	283.1	37.53	291.4	38.28	299.4	38.61	313.9	38.91	321.9	39.06
	12	221.9	27.12	264.2	33.51	283.1	39.06	291.4	39.33	299.4	39.63	313.9	39.96	321.9	40.32
	14	221.9	28.05	264.2	34.71	283.1	40.53	291.4	40.83	299.4	41.16	313.9	41.49	321.9	41.85
	16	221.9	29.06	264.2	35.93	283.1	42.36	291.4	42.75	299.4	43.09	313.9	43.47	321.9	43.83
	18	221.9	30.27	264.2	38.01	283.1	44.31	291.4	45.26	299.4	45.63	313.9	46.08	321.9	46.39
	20	221.9	31.62	264.2	40.50	283.1	46.50	291.4	49.77	299.4	50.19	309.3	50.67	317.5	51.03
	21	221.9	32.44	264.2	41.91	283.1	47.46	291.4	52.68	299.4	53.10	307.6	53.64	315.7	54.00
	23	221.9	34.81	264.2	44.10	283.1	49.92	291.4	58.14	295.6	58.59	303.1	59.19	311.1	59.58
	25	221.9	37.17	264.2	46.62	283.1	53.34	287.8	64.47	291.4	64.98	299.4	65.64	307.6	66.09
	27	221.9	39.78	264.2	49.86	279.6	56.85	283.1	70.97	287.8	71.54	295.6	72.24	303.1	72.75
	29	221.9	42.39	264.2	53.28	275.1	61.16	279.1	78.01	283.1	78.47	291.4	79.17	299.4	79.48
	31	221.9	45.24	263.4	56.13	270.5	65.07	275.1	77.67	279.1	78.15	286.8	78.84	294.8	79.14
	33	221.9	48.18	258.8	59.48	267.0	69.78	271.4	76.96	275.1	77.43	283.1	78.12	290.4	78.43
	35	221.9	51.39	254.2	62.28	262.5	75.57	267.0	75.96	271.4	76.41	278.7	77.10	286.8	77.40
	37	221.9	54.81	250.7	65.37	258.8	74.58	262.5	74.96	267.0	75.42	274.1	76.08	282.4	76.38
	39	221.9	58.35	246.1	68.79	254.2	73.59	258.8	73.95	262.5	74.40	270.5	75.07	278.7	75.36
	41	216.2	61.90	236.0	72.24	244.0	72.59	247.6	72.95	252.6	73.39	260.0	74.04	267.1	74.34
	43	210.8	65.28	226.1	71.22	234.1	71.58	237.5	71.94	242.5	72.38	249.9	73.03	256.6	73.32
46	197.5	69.88	206.4	69.75	213.9	70.09	217.2	70.44	221.6	70.86	228.6	71.50	235.0	71.79	
48	174.8	67.93	179.1	68.13	185.9	68.28	188.9	68.47	192.9	69.06	199.1	69.50	204.6	69.78	
120	10	200.7	23.82	238.7	29.19	260.9	34.71	268.9	37.50	276.7	38.09	291.8	38.24	298.8	38.55
	12	200.7	24.45	238.7	30.19	260.9	36.09	268.9	38.28	276.7	39.50	291.8	39.98	298.8	40.30
	14	200.7	25.29	238.7	31.20	260.9	37.56	268.9	39.75	276.7	40.95	291.8	41.55	298.8	41.88
	16	200.7	26.22	238.7	32.49	260.9	39.00	268.9	41.22	276.7	42.84	291.8	43.38	298.8	43.71
	18	200.7	27.23	238.7	33.95	260.9	40.57	268.9	43.41	276.7	45.03	291.8	45.55	298.8	45.93
	20	200.7	28.26	238.7	35.99	260.9	42.75	268.9	45.66	276.7	47.42	291.8	48.05	298.8	48.43
	21	200.7	29.12	238.7	37.29	260.9	43.95	268.9	47.02	276.7	48.99	291.8	49.62	298.8	50.01
	23	200.7	31.14	238.7	39.90	260.9	47.08	268.9	49.96	276.7	52.23	291.8	52.74	298.8	53.16
	25	200.7	33.28	238.7	42.75	260.9	49.65	268.9	53.26	276.7	56.01	288.3	56.46	295.4	56.92
	27	200.7	35.52	238.7	45.70	260.9	52.86	268.9	56.91	276.7	60.18	284.0	60.59	291.0	61.08
	29	200.7	37.89	238.7	48.78	260.9	55.62	268.9	60.89	272.3	64.14	279.4	65.11	287.4	65.64
	31	200.7	40.38	238.7	52.11	260.9	58.49	265.3	65.22	268.9	68.81	276.0	70.02	282.8	70.59
	33	200.7	42.99	238.7	55.53	257.3	61.86	260.9	70.80	264.4	73.89	271.4	74.73	278.5	75.32
	35	200.7	45.70	238.7	59.19	252.9	65.49	256.4	78.01	260.9	78.39	268.0	78.62	275.0	79.25
	37	200.7	49.17	238.7	62.46	249.3	69.81	252.9	76.35	256.4	76.75	263.4	76.98	270.7	77.59
	39	200.7	52.92	237.9	66.03	244.9	74.04	248.6	74.79	252.0	75.17	260.0	75.39	267.1	75.99
	41	195.6	56.70	227.4	69.57	235.1	72.59	238.5	73.22	241.9	73.59	248.9	73.81	256.0	74.40
	43	190.8	60.51	217.9	68.58	225.5	70.97	228.7	71.64	232.0	72.00	239.0	72.23	245.9	72.80
46	178.8	65.07	198.7	66.96	205.9	68.73	208.9	69.30	212.2	69.65	218.5	69.86	225.0	70.41	
48	158.1	63.72	172.6	65.76	179.0	67.40	181.8	67.80	184.6	68.01	190.1	68.28	196.0	68.58	
110	10	179.8	21.42	214.5	26.10	239.4	31.01	246.5	33.57	261.9	36.12	268.0	37.14	286.1	37.74
	12	179.8	22.08	214.5	27.00	239.4	32.31	246.5	34.50	261.9	37.48	268.0	38.70	286.1	39.58
	14	179.8	22.77	214.5	28.20	239.4	33.76	246.5	36.22	261.9	39.37	268.0	40.49	286.1	41.34
	16	179.8	23.58	214.5	29.22	239.4	35.15	246.5	37.80	261.9	41.18	268.0	42.30	286.1	43.05
	18	179.8	24.45	214.5	30.45	239.4	37.17	246.5	39.81	261.9	43.44	268.0	44.31	286.1	45.13
	20	179.8	25.32	214.5	31.98	239.4	39.42	246.5	41.64	261.9	45.55	268.0	46.68	286.1	47.42
	21	179.8	25.89	214.5	32.91	239.4	40.44	246.5	42.75	261.9	46.83	268.0	48.00	286.1	48.75
	23	179.8	27.59	214.5	35.28	239.4	42.69	246.5	45.15	261.9	49.47	268.0	50.53	286.1	51.36
	25	179.8	29.49	214.5	37.65	239.4	45.11	246.5	47.73	261.9	52.26	268.0	53.01	282.7	54.10
	27	179.8	31.50	214.5	40.26	239.4	47.67	246.5	50.51	261.9	54.57	268.0	55.83	278.5	56.79
	29	179.8	33.63	214.5	42.99	239.4	50.37	246.5	53.49	261.9	57.69	268.0	58.68	275.0	59.56
	31	179.8	35.76	214.5	45.82	239.4	53.22	246.5	56.67	257.6	60.60	264.6	61.79	270.7	62.44
	33	179.8	38.13	214.5	48.78	239.4	56.25	246.5	60.06	254.1	64.00	260.3	65.07	267.1	65.43
	35	179.8	40.50	214.5	52.11	239.4	59.40	246.5	63.64	249.9	67.55	256.0	68.16	262.8	68.52
	37	179.8	42.92	214.5	55.29	239.4	62.70	243.0	67.42	245.5	71.25	252.6	71.49	258.5	71.70
	39	179.8	46.26	214.5	58.77	235.1	66.16	238.5	72.12	242.1	74.76	248.0	74.90	255.1	74.97
	41	175.3	49.62	208.9	62.22	225.2	69.78	228.6	78.01	231.6	78.01	238.5	78.62	244.3	79.25
	43	170.8	52.11	203.7	64.83	215.7	73.98	219.3	74.82	222.1	74.67	228.6	75.09	234.5	75.30
46	160.2	50.85	191.0	62.58	196.9	70.22	200.2	70.22	202.8	70.83	209.0	71.22	214.5	71.40	
48	141.6	49.38	165.9	60.30	171.0	66.81	174.1	67.26	176.4	67.59	181.9	67.77	186.5	68.04	

Note

1. TC: Total Capacity(kW), PI: Power Input(kW, Comp. + Outdoor fan motor)
2. Capacity tables show the average value of conditions which may occur.

7. Capacity Tables

Combination (%)	Outdoor air temp (°C DB)	Cooling Capacity(80HP)													
		Indoor air temp. (DB/WB, °C)													
		20		23		26		27		28		30		32	
		14	16	18	19	20	22	24							
	TC	PI	TC	PI	TC	PI	TC	PI	TC	PI	TC	PI	TC	PI	
100	10	151.1	19.29	180.0	23.43	209.5	27.81	224.0	30.06	238.5	32.29	264.3	35.94	270.1	36.24
	12	151.1	19.92	180.0	24.39	209.5	28.74	224.0	30.87	238.5	33.32	264.3	37.88	270.1	38.25
	14	151.1	20.53	180.0	25.38	209.5	29.96	224.0	32.19	238.5	34.77	264.3	39.99	270.1	40.38
	16	151.1	21.15	180.0	26.22	209.5	31.24	224.0	33.72	238.5	36.63	264.3	41.94	270.1	42.51
	18	151.1	21.78	180.0	27.19	209.5	32.46	224.0	35.37	238.5	38.85	264.3	44.31	270.1	44.65
	20	151.1	22.56	180.0	28.22	209.5	34.35	224.0	37.89	238.5	41.56	264.3	46.41	270.1	46.79
	21	151.1	23.03	180.0	28.89	209.5	35.52	224.0	39.18	238.5	43.11	264.3	47.48	270.1	47.86
	23	151.1	24.39	180.0	30.90	209.5	38.13	224.0	42.04	238.5	46.18	264.3	49.71	270.1	50.13
	25	151.1	25.93	180.0	32.91	209.5	40.74	224.0	45.00	238.5	49.38	264.3	51.84	267.8	52.25
	27	151.1	27.71	180.0	35.17	209.5	43.56	224.0	48.07	238.5	52.50	259.1	54.27	264.6	54.71
	29	151.1	29.49	180.0	37.53	209.5	46.53	224.0	51.39	238.5	55.56	254.5	56.46	260.6	56.91
	31	151.1	31.50	180.0	40.02	209.5	49.62	224.0	54.81	238.5	58.38	250.5	58.64	256.6	59.12
	33	151.1	33.39	180.0	42.63	209.5	52.92	224.0	58.49	238.5	60.57	246.5	60.84	252.6	61.32
	35	151.1	35.52	180.0	45.36	209.5	56.37	224.0	62.40	234.8	62.76	242.1	63.03	248.2	63.51
	37	151.1	38.04	180.0	48.64	209.5	59.71	224.0	65.37	230.8	65.70	237.5	65.97	243.1	66.56
	39	151.1	40.80	180.0	52.25	209.5	63.26	224.0	68.58	227.1	68.87	233.8	69.12	239.1	69.78
	41	148.9	43.53	177.2	55.86	206.2	66.83	215.0	71.77	219.6	72.06	224.9	72.30	232.0	72.99
	43	143.7	46.08	171.1	59.22	199.1	70.02	206.1	74.52	208.4	74.76	214.8	75.03	220.6	75.72
46	134.7	49.56	160.3	63.84	186.7	74.27	188.2	78.01	190.1	78.24	196.3	78.45	201.5	79.20	
48	119.1	42.78	141.9	55.23	161.2	63.49	163.4	66.18	165.2	66.39	170.7	66.54	175.4	67.08	
90	10	136.0	16.61	162.5	19.96	188.9	23.53	201.5	25.37	214.5	27.31	240.9	30.55	267.1	33.98
	12	136.0	16.80	162.5	20.27	188.9	23.95	201.5	25.87	214.5	27.90	240.9	31.16	267.1	34.58
	14	136.0	17.12	162.5	20.67	188.9	24.45	201.5	26.39	214.5	28.42	240.9	31.77	267.1	35.29
	16	136.0	17.42	162.5	21.09	188.9	24.95	201.5	26.89	214.5	28.94	240.9	32.37	267.1	35.88
	18	136.0	17.72	162.5	21.50	188.9	25.37	201.5	27.52	214.5	29.55	240.9	33.08	267.1	37.70
	20	136.0	18.02	162.5	21.90	188.9	25.87	201.5	28.02	214.5	30.67	240.9	35.40	267.1	39.49
	21	136.0	18.23	162.5	22.11	188.9	26.39	201.5	28.94	214.5	31.78	240.9	35.98	267.1	40.41
	23	136.0	18.64	162.5	23.03	188.9	28.23	201.5	31.06	214.5	34.04	240.9	38.15	263.4	42.32
	25	136.0	19.56	162.5	24.54	188.9	30.16	201.5	33.21	214.5	36.36	240.9	40.80	259.7	44.11
	27	136.0	20.88	162.5	26.18	188.9	32.19	201.5	35.44	214.5	38.92	240.9	43.36	256.0	46.19
	29	136.0	22.11	162.5	27.90	188.9	34.42	201.5	37.91	214.5	41.57	240.9	45.95	252.0	48.04
	31	136.0	23.53	162.5	29.75	188.9	36.68	201.5	40.35	214.5	44.32	240.9	48.24	248.3	49.91
	33	136.0	25.07	162.5	31.68	188.9	39.12	201.5	43.00	214.5	47.00	240.9	50.57	244.6	51.76
	35	136.0	26.60	162.5	33.62	188.9	41.57	201.5	45.83	214.5	49.85	236.6	53.46	240.6	54.71
	37	136.0	28.23	162.5	35.76	188.9	44.32	201.5	48.69	214.5	52.62	232.9	55.90	236.9	57.15
	39	136.0	29.87	162.5	38.03	188.9	46.91	201.5	51.82	214.5	55.33	229.0	58.93	233.0	59.64
	41	132.6	33.44	158.1	42.17	184.0	51.49	196.4	56.67	208.9	59.74	219.4	62.09	223.4	63.53
	43	129.2	36.09	154.4	45.56	179.4	56.23	191.6	61.04	203.7	64.05	210.5	66.50	214.2	67.31
46	121.2	40.62	144.6	51.89	168.0	64.09	179.6	69.21	185.2	71.15	192.0	73.00	195.7	73.10	
48	107.1	35.50	128.0	45.39	148.6	56.05	158.8	60.37	160.7	61.32	167.0	62.84	170.1	62.92	
80	10	120.9	13.93	144.0	16.76	167.1	19.66	179.1	21.21	191.1	22.75	214.5	25.96	237.5	28.17
	12	120.9	14.24	144.0	16.93	167.1	20.05	179.1	21.59	191.1	23.13	214.5	26.44	237.5	28.73
	14	120.9	14.42	144.0	17.32	167.1	20.32	179.1	21.97	191.1	23.53	214.5	26.92	237.5	29.28
	16	120.9	14.62	144.0	17.62	167.1	20.71	179.1	22.36	191.1	24.01	214.5	27.50	237.5	29.85
	18	120.9	14.92	144.0	17.92	167.1	21.11	179.1	22.75	191.1	24.49	214.5	27.98	237.5	30.50
	20	120.9	15.20	144.0	18.30	167.1	21.59	179.1	23.23	191.1	24.99	214.5	29.04	237.5	32.31
	21	120.9	15.29	144.0	18.49	167.1	21.78	179.1	23.53	191.1	25.56	214.5	29.96	237.5	33.17
	23	120.9	15.59	144.0	18.78	167.1	22.75	179.1	24.99	191.1	27.30	214.5	31.64	237.5	34.82
	25	120.9	16.18	144.0	20.05	167.1	24.40	179.1	26.73	191.1	29.25	214.5	33.86	237.5	37.22
	27	120.9	17.14	144.0	21.30	167.1	26.04	179.1	28.56	191.1	31.17	214.5	35.97	237.5	39.16
	29	120.9	18.20	144.0	22.75	167.1	27.69	179.1	30.42	191.1	33.30	214.5	38.54	237.5	41.93
	31	120.9	19.36	144.0	24.10	167.1	29.52	179.1	32.43	191.1	35.45	214.5	40.91	237.5	44.02
	33	120.9	20.53	144.0	25.75	167.1	31.46	179.1	34.56	191.1	37.76	214.5	43.10	237.5	46.15
	35	120.9	21.78	144.0	27.30	167.1	33.50	179.1	36.80	191.1	40.28	214.5	45.70	235.1	47.82
	37	120.9	23.05	144.0	29.04	167.1	35.54	179.1	39.12	191.1	42.80	214.5	48.22	231.4	49.99
	39	120.9	24.36	144.0	30.69	167.1	38.00	179.1	42.05	191.1	45.99	214.5	50.95	227.4	52.74
	41	117.8	26.94	140.3	34.02	162.8	41.72	174.5	46.09	186.2	50.53	208.9	56.71	217.9	58.44
	43	114.8	29.67	136.9	37.10	158.8	45.55	170.2	50.23	181.8	55.23	203.7	60.69	208.9	62.58
46	107.6	33.00	128.2	41.81	148.9	51.30	159.6	55.92	170.2	62.31	186.4	66.23	190.7	67.31	
48	95.1	28.83	113.5	36.56	131.7	44.87	141.2	48.84	150.7	54.55	161.9	57.33	165.8	57.94	

Note

1. TC: Total Capacity(kW), PI : Power Input(kW, Comp. + Outdoor fan motor)
2. Capacity tables show the average value of conditions which may occur.

7. Capacity Tables

Combination (%)	Outdoor air temp (°C DB)	Cooling Capacity(80HP)													
		Indoor air temp. (DB/WB, °C)													
		20		23		26		27		28		30		32	
		14	16	18	19	20	22	24							
	TC	PI	TC	PI	TC	PI	TC	PI	TC	PI	TC	PI	TC	PI	
70	10	105.5	12.28	126.5	14.60	146.5	16.92	156.9	18.27	167.1	19.52	187.1	22.23	208.0	24.85
	12	105.5	12.46	126.5	14.78	146.5	17.28	156.9	18.55	167.1	19.91	187.1	22.61	208.0	25.33
	14	105.5	12.67	126.5	14.98	146.5	17.59	156.9	18.85	167.1	20.20	187.1	23.10	208.0	25.78
	16	105.5	12.84	126.5	15.26	146.5	17.88	156.9	19.24	167.1	20.57	187.1	23.49	208.0	26.34
	18	105.5	13.05	126.5	15.56	146.5	18.27	156.9	19.60	167.1	20.97	187.1	23.86	208.0	26.81
	20	105.5	13.24	126.5	15.84	146.5	18.55	156.9	20.00	167.1	21.45	187.1	24.45	208.0	27.83
	21	105.5	13.42	126.5	15.95	146.5	18.75	156.9	20.20	167.1	21.65	187.1	24.83	208.0	28.42
	23	105.5	13.63	126.5	16.32	146.5	19.12	156.9	20.87	167.1	22.71	187.1	26.57	208.0	30.01
	25	105.5	13.81	126.5	16.92	146.5	20.39	156.9	22.32	167.1	24.25	187.1	28.41	208.0	31.46
	27	105.5	14.60	126.5	18.07	146.5	21.74	156.9	23.67	167.1	25.90	187.1	30.34	208.0	33.44
	29	105.5	15.56	126.5	19.12	146.5	23.10	156.9	25.22	167.1	27.54	187.1	32.36	208.0	35.82
	31	105.5	16.53	126.5	20.39	146.5	24.64	156.9	26.96	167.1	29.37	187.1	34.50	208.0	38.00
	33	105.5	17.49	126.5	21.53	146.5	26.18	156.9	28.60	167.1	31.22	187.1	36.71	208.0	40.47
	35	105.5	18.46	126.5	23.01	146.5	27.83	156.9	30.43	167.1	33.23	187.1	39.14	208.0	42.91
	37	105.5	19.60	126.5	24.37	146.5	29.56	156.9	32.36	167.1	35.37	187.1	41.65	208.0	45.28
	39	105.5	20.84	126.5	25.97	146.5	31.61	156.9	34.83	167.1	38.21	187.1	44.57	208.0	48.83
	41	102.8	23.04	123.1	28.44	142.7	34.68	152.9	38.21	162.8	41.53	182.5	48.95	202.7	52.66
	43	100.4	25.06	120.0	31.01	139.1	37.85	149.0	41.65	158.8	45.36	177.9	53.47	197.5	56.94
46	94.1	27.86	112.6	34.87	130.5	42.62	139.6	46.39	148.9	51.13	166.7	60.32	185.2	63.46	
48	83.1	24.31	99.6	30.46	115.4	37.25	123.4	40.53	131.7	44.72	147.4	52.78	164.0	54.92	
60	10	90.5	10.60	108.0	12.44	125.5	14.47	134.5	15.52	143.1	16.49	160.9	18.70	178.5	20.92
	12	90.5	10.81	108.0	12.63	125.5	14.66	134.5	15.72	143.1	16.78	160.9	19.00	178.5	21.31
	14	90.5	10.89	108.0	12.83	125.5	14.94	134.5	16.00	143.1	17.07	160.9	19.39	178.5	21.70
	16	90.5	11.08	108.0	13.12	125.5	15.15	134.5	16.30	143.1	17.46	160.9	19.76	178.5	22.07
	18	90.5	11.29	108.0	13.30	125.5	15.42	134.5	16.58	143.1	17.75	160.9	20.06	178.5	22.56
	20	90.5	11.47	108.0	13.51	125.5	15.72	134.5	16.88	143.1	18.04	160.9	20.44	178.5	23.04
	21	90.5	11.57	108.0	13.60	125.5	15.91	134.5	17.07	143.1	18.22	160.9	20.73	178.5	23.25
	23	90.5	11.78	108.0	13.88	125.5	16.12	134.5	17.36	143.1	18.61	160.9	21.49	178.5	24.68
	25	90.5	11.96	108.0	14.18	125.5	16.78	134.5	18.22	143.1	19.76	160.9	22.95	178.5	26.41
	27	90.5	12.35	108.0	14.94	125.5	17.85	134.5	19.39	143.1	21.03	160.9	24.40	178.5	28.17
	29	90.5	13.12	108.0	15.91	125.5	19.00	134.5	20.64	143.1	22.38	160.9	26.04	178.5	30.08
	31	90.5	13.88	108.0	16.88	125.5	20.15	134.5	21.98	143.1	23.83	160.9	27.77	178.5	32.02
	33	90.5	14.66	108.0	17.85	125.5	21.41	134.5	23.35	143.1	25.35	160.9	29.51	178.5	34.14
	35	90.5	15.52	108.0	19.00	125.5	22.77	134.5	24.78	143.1	26.90	160.9	31.45	178.5	36.25
	37	90.5	16.39	108.0	20.04	125.5	24.10	134.5	26.32	143.1	28.54	160.9	33.36	178.5	38.58
	39	90.5	17.42	108.0	21.34	125.5	26.02	134.5	28.23	143.1	30.72	160.9	35.79	178.5	41.34
	41	88.0	18.91	105.2	23.37	122.5	28.26	131.0	30.85	139.4	33.33	156.6	39.26	173.9	44.92
	43	85.9	20.54	102.7	25.44	119.4	30.81	127.7	33.62	136.0	36.37	152.9	42.86	169.5	49.06
46	80.6	23.01	96.2	28.56	112.0	34.64	119.7	37.79	127.4	40.92	143.1	48.29	158.8	55.89	
48	71.1	20.06	85.2	24.92	99.0	30.27	105.9	33.00	112.9	35.75	126.7	42.23	140.6	48.91	
50	10	75.6	9.14	90.5	10.58	104.9	12.04	112.0	12.89	119.1	13.66	133.5	15.40	148.9	17.13
	12	75.6	9.23	90.5	10.69	104.9	12.22	112.0	13.08	119.1	13.96	133.5	15.68	148.9	17.42
	14	75.6	9.35	90.5	10.87	104.9	12.41	112.0	13.28	119.1	14.14	133.5	15.89	148.9	17.72
	16	75.6	9.53	90.5	11.06	104.9	12.62	112.0	13.57	119.1	14.33	133.5	16.16	148.9	17.99
	18	75.6	9.62	90.5	11.16	104.9	12.80	112.0	13.75	119.1	14.63	133.5	16.47	148.9	18.39
	20	75.6	9.72	90.5	11.36	104.9	13.08	112.0	13.96	119.1	14.91	133.5	16.74	148.9	18.76
	21	75.6	9.81	90.5	11.45	104.9	13.19	112.0	14.14	119.1	15.01	133.5	16.93	148.9	18.94
	23	75.6	10.02	90.5	11.65	104.9	13.38	112.0	14.33	119.1	15.30	133.5	17.23	148.9	19.34
	25	75.6	10.11	90.5	11.83	104.9	13.66	112.0	14.63	119.1	15.79	133.5	18.09	148.9	20.69
	27	75.6	10.29	90.5	12.22	104.9	14.43	112.0	15.58	119.1	16.74	133.5	19.34	148.9	22.03
	29	75.6	10.87	90.5	12.99	104.9	15.30	112.0	16.55	119.1	17.81	133.5	20.50	148.9	23.38
	31	75.6	11.45	90.5	13.75	104.9	16.26	112.0	17.51	119.1	18.94	133.5	21.84	148.9	24.93
	33	75.6	12.13	90.5	14.54	104.9	17.23	112.0	18.57	119.1	20.11	133.5	23.19	148.9	26.56
	35	75.6	12.80	90.5	15.40	104.9	18.18	112.0	19.74	119.1	21.27	133.5	24.54	148.9	28.20
	37	75.6	13.57	90.5	16.26	104.9	19.25	112.0	20.87	119.1	22.52	133.5	26.18	148.9	29.93
	39	75.6	14.48	90.5	17.44	104.9	20.63	112.0	22.48	119.1	24.17	133.5	27.89	148.9	32.32
	41	73.5	15.65	88.0	18.88	102.1	22.55	109.2	24.35	116.0	26.18	130.1	30.55	144.9	35.10
	43	71.8	17.02	85.9	20.53	99.6	24.54	106.5	26.52	113.3	28.51	127.0	33.33	141.5	38.29
46	67.4	19.06	80.6	23.03	93.3	27.53	99.7	29.77	106.1	31.99	119.0	37.49	132.6	43.11	
48	59.6	16.59	71.1	20.07	82.5	24.01	88.2	25.98	93.9	27.92	105.3	32.76	117.2	37.68	

Note

1. TC: Total Capacity(kW), PI : Power Input(kW, Comp. + Outdoor fan motor)
2. Capacity tables show the average value of conditions which may occur.

7. Capacity Tables

◆ A(C)RUN820LLS5

Combination (%)	Outdoor air temp (°C DB)	Indoor air temp. (DB/WB, °C)														Cooling Capacity(82HP)	
		20		23		26		27		28		30		32		TC	PI
		14		16		18		19		20		22		24			
		TC	PI	TC	PI	TC	PI	TC	PI	TC	PI	TC	PI	TC	PI		
130	10	227.4	26.64	270.9	32.55	290.2	37.77	298.6	38.53	306.9	38.86	321.7	39.16	329.9	39.31		
	12	227.4	27.30	270.9	33.72	290.2	39.31	298.6	39.58	306.9	39.88	321.7	40.22	329.9	40.58		
	14	227.4	28.23	270.9	34.93	290.2	40.79	298.6	41.09	306.9	41.42	321.7	41.76	329.9	42.12		
	16	227.4	29.25	270.9	36.16	290.2	42.63	298.6	43.03	306.9	43.36	321.7	43.75	329.9	44.11		
	18	227.4	30.47	270.9	38.25	290.2	44.59	298.6	45.55	306.9	45.92	321.7	46.37	329.9	46.68		
	20	227.4	31.82	270.9	40.76	290.2	46.79	298.6	50.09	306.9	50.51	317.0	51.00	325.4	51.36		
	21	227.4	32.65	270.9	42.18	290.2	47.77	298.6	53.01	306.9	53.44	315.3	53.98	323.6	54.34		
	23	227.4	35.03	270.9	44.38	290.2	50.24	298.6	58.51	303.0	58.97	310.7	59.56	318.9	59.97		
	25	227.4	37.41	270.9	46.92	290.2	53.69	295.0	64.89	298.6	65.40	306.9	66.06	315.3	66.52		
	27	227.4	40.03	270.9	50.18	286.6	57.22	290.2	71.43	295.0	72.00	303.0	72.70	310.7	73.22		
	29	227.4	42.67	270.9	53.62	282.0	61.56	286.1	78.51	290.2	78.98	298.6	79.68	306.9	79.99		
	31	227.4	45.53	270.0	56.49	277.3	65.48	282.0	78.17	286.1	78.65	293.9	79.34	302.1	79.65		
	33	227.4	48.49	265.2	59.86	273.7	70.22	278.1	77.45	282.0	77.92	290.2	78.62	297.6	78.93		
	35	227.4	51.72	260.5	62.68	269.0	76.06	273.7	76.44	278.1	76.90	285.7	77.60	293.9	77.90		
	37	227.4	55.16	257.0	65.78	265.2	75.06	269.0	75.45	273.7	75.90	281.0	76.57	289.4	76.87		
	39	227.4	58.72	252.3	69.23	260.5	74.06	265.2	74.43	269.0	74.87	277.3	75.55	285.7	75.84		
	41	221.6	62.29	241.9	72.70	250.1	73.06	253.8	73.42	258.9	73.86	266.5	74.52	273.8	74.81		
	43	216.0	65.70	231.8	71.68	240.0	72.04	243.5	72.40	248.5	72.85	256.1	73.49	263.0	73.79		
46	202.5	70.33	211.5	70.20	219.2	70.54	222.7	70.90	227.2	71.32	234.3	71.95	240.9	72.25			
48	179.1	68.36	183.6	68.57	190.5	68.72	193.6	68.91	197.7	69.50	204.1	69.95	209.7	70.22			
120	10	205.7	23.97	244.7	29.38	267.4	34.93	275.6	37.74	283.6	38.34	299.1	38.49	306.3	38.80		
	12	205.7	24.61	244.7	30.38	267.4	36.32	275.6	38.53	283.6	39.76	299.1	40.24	306.3	40.55		
	14	205.7	25.46	244.7	31.40	267.4	37.80	275.6	40.00	283.6	41.21	299.1	41.82	306.3	42.15		
	16	205.7	26.39	244.7	32.69	267.4	39.25	275.6	41.49	283.6	43.12	299.1	43.66	306.3	43.99		
	18	205.7	27.41	244.7	34.17	267.4	40.83	275.6	43.68	283.6	45.32	299.1	45.84	306.3	46.22		
	20	205.7	28.44	244.7	36.23	267.4	43.03	275.6	45.95	283.6	47.73	299.1	48.36	306.3	48.74		
	21	205.7	29.31	244.7	37.53	267.4	44.23	275.6	47.32	283.6	49.31	299.1	49.94	306.3	50.33		
	23	205.7	31.34	244.7	40.16	267.4	47.38	275.6	50.28	283.6	52.56	299.1	53.08	306.3	53.50		
	25	205.7	33.49	244.7	43.03	267.4	49.97	275.6	53.60	283.6	56.37	295.5	56.82	302.7	57.28		
	27	205.7	35.75	244.7	45.99	267.4	53.20	275.6	57.28	283.6	60.56	291.1	60.98	298.3	61.47		
	29	205.7	38.13	244.7	49.10	267.4	55.97	275.6	61.28	279.1	64.55	286.4	65.52	294.6	66.06		
	31	205.7	40.64	244.7	52.44	267.4	58.87	271.9	65.64	275.6	69.25	282.9	70.47	289.9	71.04		
	33	205.7	43.26	244.7	55.89	263.7	62.26	267.4	71.26	271.0	74.36	278.2	75.21	285.5	75.81		
	35	205.7	45.99	244.7	59.57	259.2	65.91	262.8	78.51	267.4	78.89	274.7	79.13	281.9	79.76		
	37	205.7	49.48	244.7	62.86	255.5	70.26	259.2	76.84	262.8	77.24	270.0	77.47	277.5	78.08		
	39	205.7	53.26	243.8	66.45	251.0	74.52	254.8	75.27	258.3	75.66	266.5	75.87	273.8	76.48		
	41	200.5	57.06	233.1	70.02	241.0	73.06	244.5	73.69	247.9	74.07	255.1	74.28	262.4	74.87		
	43	195.5	60.90	223.3	69.02	231.1	71.43	234.4	72.10	237.8	72.46	245.0	72.70	252.0	73.27		
46	183.2	65.48	203.7	67.39	211.0	69.17	214.1	69.74	217.5	70.10	224.0	70.31	230.6	70.86			
48	162.1	64.13	176.9	66.18	183.5	67.83	186.4	68.24	189.2	68.45	194.9	68.72	200.9	69.02			
110	10	184.3	21.56	219.8	26.27	245.4	31.21	252.6	33.79	268.4	36.35	274.7	37.38	293.3	37.98		
	12	184.3	22.22	219.8	27.17	245.4	32.52	252.6	34.72	268.4	37.72	274.7	38.95	293.3	39.83		
	14	184.3	22.92	219.8	28.38	245.4	33.97	252.6	36.45	268.4	39.62	274.7	40.75	293.3	41.61		
	16	184.3	23.73	219.8	29.41	245.4	35.38	252.6	38.04	268.4	41.45	274.7	42.57	293.3	43.33		
	18	184.3	24.61	219.8	30.64	245.4	37.41	252.6	40.07	268.4	43.72	274.7	44.59	293.3	45.42		
	20	184.3	25.48	219.8	32.18	245.4	39.67	252.6	41.91	268.4	45.84	274.7	46.98	293.3	47.73		
	21	184.3	26.05	219.8	33.12	245.4	40.70	252.6	43.03	268.4	47.13	274.7	48.31	293.3	49.06		
	23	184.3	27.77	219.8	35.51	245.4	42.97	252.6	45.44	268.4	49.79	274.7	50.85	293.3	51.69		
	25	184.3	29.68	219.8	37.89	245.4	45.40	252.6	48.04	268.4	52.59	274.7	53.35	289.8	54.44		
	27	184.3	31.70	219.8	40.52	245.4	47.98	252.6	50.84	268.4	54.92	274.7	56.18	285.5	57.15		
	29	184.3	33.85	219.8	43.26	245.4	50.69	252.6	53.83	268.4	58.06	274.7	59.06	281.9	59.94		
	31	184.3	35.99	219.8	46.11	245.4	53.56	252.6	57.03	264.1	60.99	271.2	62.19	277.5	62.84		
	33	184.3	38.38	219.8	49.10	245.4	56.61	252.6	60.45	260.5	64.41	266.8	65.49	273.8	65.85		
	35	184.3	40.76	219.8	52.44	245.4	59.78	252.6	64.04	256.1	67.98	262.4	68.60	269.3	68.95		
	37	184.3	43.20	219.8	55.65	245.4	63.10	249.1	67.85	251.6	71.70	258.9	71.95	265.0	72.16		
	39	184.3	46.56	219.8	59.14	241.0	66.58	244.5	72.58	248.2	75.24	254.2	75.38	261.5	75.45		
	41	179.7	49.94	214.1	62.61	230.8	70.22	234.3	78.51	237.4	78.51	244.4	79.13	250.4	79.76		
	43	175.1	52.44	208.8	65.25	221.1	74.45	224.8	75.30	227.7	75.15	234.4	75.57	240.4	75.78		
46	164.2	51.17	195.8	62.99	201.8	70.67	205.3	70.67	207.8	71.28	214.2	71.68	219.9	71.86			
48	145.2	49.70	170.0	60.68	175.3	67.24	178.5	67.69	180.8	68.02	186.4	68.21	191.2	68.47			

Note

1. TC: Total Capacity(kW), PI : Power Input(kW, Comp. + Outdoor fan motor)
2. Capacity tables show the average value of conditions which may occur.

7. Capacity Tables

Combination (%)	Outdoor air temp (°C DB)	Cooling Capacity(82HP)													
		Indoor air temp. (DB/WB, °C)													
		20		23		26		27		28		30		32	
		14	16	18	19	20	22	24	TC	PI	TC	PI	TC	PI	
100	10	154.9	19.41	184.5	23.58	214.8	27.99	229.6	30.25	244.4	32.49	270.9	36.18	276.9	36.47
	12	154.9	20.04	184.5	24.55	214.8	28.93	229.6	31.06	244.4	33.54	270.9	38.13	276.9	38.50
	14	154.9	20.66	184.5	25.54	214.8	30.16	229.6	32.40	244.4	34.99	270.9	40.24	276.9	40.64
	16	154.9	21.29	184.5	26.39	214.8	31.44	229.6	33.94	244.4	36.86	270.9	42.20	276.9	42.78
	18	154.9	21.92	184.5	27.36	214.8	32.67	229.6	35.59	244.4	39.10	270.9	44.59	276.9	44.93
	20	154.9	22.71	184.5	28.40	214.8	34.57	229.6	38.13	244.4	41.82	270.9	46.71	276.9	47.09
	21	154.9	23.18	184.5	29.07	214.8	35.75	229.6	39.44	244.4	43.39	270.9	47.79	276.9	48.16
	23	154.9	24.55	184.5	31.10	214.8	38.38	229.6	42.31	244.4	46.47	270.9	50.03	276.9	50.45
	25	154.9	26.09	184.5	33.12	214.8	41.00	229.6	45.29	244.4	49.69	270.9	52.17	274.5	52.59
	27	154.9	27.89	184.5	35.39	214.8	43.84	229.6	48.38	244.4	52.84	265.6	54.62	271.2	55.06
	29	154.9	29.68	184.5	37.77	214.8	46.83	229.6	51.72	244.4	55.91	260.8	56.82	267.1	57.28
	31	154.9	31.70	184.5	40.28	214.8	49.94	229.6	55.17	244.4	58.76	256.8	59.02	263.0	59.50
	33	154.9	33.60	184.5	42.90	214.8	53.26	229.6	58.87	244.4	60.96	252.7	61.23	258.9	61.72
	35	154.9	35.75	184.5	45.65	214.8	56.73	229.6	62.80	240.6	63.16	248.2	63.43	254.4	63.92
	37	154.9	38.29	184.5	48.95	214.8	60.09	229.6	65.79	236.6	66.12	243.4	66.39	249.2	66.99
	39	154.9	41.06	184.5	52.59	214.8	63.67	229.6	69.02	232.8	69.32	239.7	69.57	245.1	70.22
	41	152.6	43.81	181.7	56.22	211.3	67.26	220.4	72.23	225.1	72.52	230.5	72.76	237.8	73.45
	43	147.3	46.37	175.4	59.60	204.1	70.47	211.3	75.00	213.6	75.24	220.2	75.51	226.1	76.21
46	138.1	49.88	164.3	64.25	191.4	74.75	192.9	78.51	194.9	78.74	201.2	78.96	206.6	79.71	
48	122.1	43.05	145.4	55.59	165.3	63.90	167.5	66.61	169.4	66.82	175.0	66.97	179.7	67.51	
90	10	139.4	17.00	166.5	20.42	193.6	24.07	206.6	25.95	219.8	27.94	246.9	31.26	273.8	34.76
	12	139.4	17.19	166.5	20.74	193.6	24.50	206.6	26.47	219.8	28.55	246.9	31.87	273.8	35.38
	14	139.4	17.51	166.5	21.15	193.6	25.01	206.6	27.00	219.8	29.07	246.9	32.50	273.8	36.10
	16	139.4	17.83	166.5	21.57	193.6	25.53	206.6	27.51	219.8	29.61	246.9	33.12	273.8	36.71
	18	139.4	18.13	166.5	22.00	193.6	25.95	206.6	28.15	219.8	30.23	246.9	33.84	273.8	38.57
	20	139.4	18.43	166.5	22.40	193.6	26.47	206.6	28.67	219.8	31.38	246.9	36.22	273.8	40.40
	21	139.4	18.65	166.5	22.61	193.6	27.00	206.6	29.61	219.8	32.51	246.9	36.81	273.8	41.34
	23	139.4	19.07	166.5	23.55	193.6	28.88	206.6	31.77	219.8	34.82	246.9	39.03	270.0	43.29
	25	139.4	20.01	166.5	25.10	193.6	30.85	206.6	33.97	219.8	37.20	246.9	41.73	266.2	45.13
	27	139.4	21.36	166.5	26.78	193.6	32.93	206.6	36.26	219.8	39.81	246.9	44.36	262.4	47.25
	29	139.4	22.61	166.5	28.55	193.6	35.22	206.6	38.78	219.8	42.52	246.9	47.01	258.3	49.15
	31	139.4	24.07	166.5	30.44	193.6	37.52	206.6	41.28	219.8	45.34	246.9	49.35	254.5	51.05
	33	139.4	25.65	166.5	32.41	193.6	40.02	206.6	43.99	219.8	48.08	246.9	51.73	250.7	52.95
	35	139.4	27.21	166.5	34.40	193.6	42.52	206.6	46.89	219.8	50.99	242.5	54.69	246.7	55.96
	37	139.4	28.88	166.5	36.58	193.6	45.34	206.6	49.81	219.8	53.83	238.7	57.18	242.8	58.47
	39	139.4	30.56	166.5	38.91	193.6	47.99	206.6	53.01	219.8	56.61	234.7	60.29	238.8	61.02
	41	135.9	34.21	162.1	43.14	188.6	52.67	201.3	57.98	214.1	61.12	224.9	63.52	229.0	64.99
	43	132.5	36.92	158.2	46.61	183.9	57.53	196.4	62.45	208.8	65.53	215.7	68.03	219.5	68.86
46	124.3	41.56	148.2	53.08	172.2	65.56	184.1	70.80	189.9	72.79	196.8	74.67	200.6	74.79	
48	109.8	36.32	131.2	46.43	152.4	57.34	162.7	61.76	164.7	62.73	171.2	64.28	174.4	64.37	
80	10	123.9	14.26	147.6	17.14	171.3	20.11	183.6	21.70	195.9	23.28	219.8	26.56	243.5	28.82
	12	123.9	14.57	147.6	17.32	171.3	20.51	183.6	22.09	195.9	23.67	219.8	27.05	243.5	29.40
	14	123.9	14.76	147.6	17.72	171.3	20.79	183.6	22.48	195.9	24.07	219.8	27.54	243.5	29.96
	16	123.9	14.96	147.6	18.03	171.3	21.19	183.6	22.88	195.9	24.56	219.8	28.14	243.5	30.54
	18	123.9	15.27	147.6	18.34	171.3	21.59	183.6	23.28	195.9	25.05	219.8	28.63	243.5	31.21
	20	123.9	15.55	147.6	18.73	171.3	22.09	183.6	23.77	195.9	25.56	219.8	29.71	243.5	33.06
	21	123.9	15.64	147.6	18.92	171.3	22.29	183.6	24.07	195.9	26.16	219.8	30.66	243.5	33.94
	23	123.9	15.95	147.6	19.22	171.3	23.28	183.6	25.56	195.9	27.93	219.8	32.38	243.5	35.62
	25	123.9	16.55	147.6	20.51	171.3	24.96	183.6	27.35	195.9	29.93	219.8	34.64	243.5	38.08
	27	123.9	17.53	147.6	21.79	171.3	26.65	183.6	29.22	195.9	31.89	219.8	36.80	243.5	40.07
	29	123.9	18.62	147.6	23.28	171.3	28.33	183.6	31.12	195.9	34.07	219.8	39.43	243.5	42.90
	31	123.9	19.81	147.6	24.66	171.3	30.21	183.6	33.18	195.9	36.27	219.8	41.85	243.5	45.03
	33	123.9	21.00	147.6	26.35	171.3	32.19	183.6	35.36	195.9	38.64	219.8	44.09	243.5	47.22
	35	123.9	22.29	147.6	27.93	171.3	34.28	183.6	37.65	195.9	41.21	219.8	46.76	241.0	48.93
	37	123.9	23.58	147.6	29.71	171.3	36.36	183.6	40.02	195.9	43.79	219.8	49.34	237.1	51.15
	39	123.9	24.92	147.6	31.40	171.3	38.88	183.6	43.02	195.9	47.06	219.8	52.13	233.1	53.96
	41	120.8	27.56	143.8	34.80	166.9	42.68	178.9	47.16	190.8	51.70	214.1	58.02	223.3	59.79
	43	117.6	30.35	140.3	37.96	162.8	46.60	174.4	51.40	186.4	56.51	208.8	62.09	214.1	64.03
46	110.3	33.76	131.5	42.77	152.6	52.49	163.6	57.21	174.4	63.75	191.0	67.76	195.5	68.86	
48	97.5	29.50	116.3	37.40	135.0	45.90	144.8	49.97	154.5	55.81	165.9	58.66	170.0	59.28	

Note

1. TC: Total Capacity(kW), PI : Power Input(kW, Comp. + Outdoor fan motor)
2. Capacity tables show the average value of conditions which may occur.

7. Capacity Tables

Combination (%)	Outdoor air temp (°C DB)	Cooling Capacity(82HP)													
		Indoor air temp. (DB/WB, °C)													
		20		23		26		27		28		30		32	
		14	16	18	19	20	22	24							
	TC	PI	TC	PI	TC	PI	TC	PI	TC	PI	TC	PI	TC	PI	
70	10	108.2	12.56	129.6	14.94	150.1	17.31	160.8	18.70	171.3	19.97	191.8	22.75	213.2	25.43
	12	108.2	12.75	129.6	15.13	150.1	17.68	160.8	18.98	171.3	20.37	191.8	23.14	213.2	25.92
	14	108.2	12.96	129.6	15.33	150.1	18.00	160.8	19.29	171.3	20.67	191.8	23.64	213.2	26.38
	16	108.2	13.14	129.6	15.62	150.1	18.30	160.8	19.69	171.3	21.05	191.8	24.04	213.2	26.95
	18	108.2	13.35	129.6	15.92	150.1	18.70	160.8	20.06	171.3	21.45	191.8	24.41	213.2	27.44
	20	108.2	13.54	129.6	16.21	150.1	18.98	160.8	20.46	171.3	21.95	191.8	25.02	213.2	28.48
	21	108.2	13.73	129.6	16.32	150.1	19.19	160.8	20.67	171.3	22.16	191.8	25.40	213.2	29.08
	23	108.2	13.95	129.6	16.70	150.1	19.57	160.8	21.35	171.3	23.24	191.8	27.19	213.2	30.71
	25	108.2	14.14	129.6	17.31	150.1	20.86	160.8	22.84	171.3	24.81	191.8	29.07	213.2	32.19
	27	108.2	14.94	129.6	18.49	150.1	22.25	160.8	24.22	171.3	26.51	191.8	31.05	213.2	34.22
	29	108.2	15.92	129.6	19.57	150.1	23.64	160.8	25.81	171.3	28.18	191.8	33.11	213.2	36.66
	31	108.2	16.91	129.6	20.86	150.1	25.21	160.8	27.59	171.3	30.06	191.8	35.30	213.2	38.89
	33	108.2	17.90	129.6	22.04	150.1	26.79	160.8	29.26	171.3	31.94	191.8	37.57	213.2	41.41
	35	108.2	18.89	129.6	23.54	150.1	28.48	160.8	31.14	171.3	34.01	191.8	40.05	213.2	43.91
	37	108.2	20.06	129.6	24.94	150.1	30.25	160.8	33.11	171.3	36.19	191.8	42.62	213.2	46.33
	39	108.2	21.33	129.6	26.57	150.1	32.35	160.8	35.64	171.3	39.10	191.8	45.61	213.2	49.96
	41	105.4	23.58	126.2	29.10	146.3	35.49	156.7	39.10	166.9	42.49	187.0	50.09	207.8	53.89
	43	102.9	25.64	123.0	31.73	142.6	38.73	152.7	42.62	162.8	46.41	182.3	54.72	202.5	58.26
46	96.5	28.51	115.4	35.68	133.7	43.61	143.1	47.47	152.6	52.31	170.9	61.72	189.9	64.94	
48	85.2	24.87	102.1	31.17	118.3	38.12	126.5	41.48	135.0	45.76	151.1	54.01	168.1	56.20	
60	10	92.7	10.85	110.7	12.73	128.7	14.81	137.8	15.88	146.7	16.87	164.9	19.14	182.9	21.40
	12	92.7	11.06	110.7	12.92	128.7	15.00	137.8	16.09	146.7	17.17	164.9	19.44	182.9	21.81
	14	92.7	11.15	110.7	13.13	128.7	15.29	137.8	16.37	146.7	17.46	164.9	19.84	182.9	22.21
	16	92.7	11.34	110.7	13.42	128.7	15.50	137.8	16.68	146.7	17.87	164.9	20.22	182.9	22.59
	18	92.7	11.55	110.7	13.61	128.7	15.78	137.8	16.96	146.7	18.17	164.9	20.53	182.9	23.09
	20	92.7	11.74	110.7	13.83	128.7	16.09	137.8	17.27	146.7	18.46	164.9	20.91	182.9	23.58
	21	92.7	11.84	110.7	13.92	128.7	16.28	137.8	17.46	146.7	18.65	164.9	21.21	182.9	23.79
	23	92.7	12.05	110.7	14.21	128.7	16.49	137.8	17.77	146.7	19.05	164.9	22.00	182.9	25.25
	25	92.7	12.24	110.7	14.51	128.7	17.17	137.8	18.65	146.7	20.22	164.9	23.49	182.9	27.03
	27	92.7	12.64	110.7	15.29	128.7	18.27	137.8	19.84	146.7	21.52	164.9	24.97	182.9	28.82
	29	92.7	13.42	110.7	16.28	128.7	19.44	137.8	21.12	146.7	22.90	164.9	26.65	182.9	30.79
	31	92.7	14.21	110.7	17.27	128.7	20.62	137.8	22.50	146.7	24.38	164.9	28.42	182.9	32.77
	33	92.7	15.00	110.7	18.27	128.7	21.91	137.8	23.89	146.7	25.95	164.9	30.20	182.9	34.94
	35	92.7	15.88	110.7	19.44	128.7	23.30	137.8	25.35	146.7	27.53	164.9	32.18	182.9	37.09
	37	92.7	16.77	110.7	20.51	128.7	24.66	137.8	26.94	146.7	29.20	164.9	34.14	182.9	39.48
	39	92.7	17.83	110.7	21.84	128.7	26.62	137.8	28.89	146.7	31.44	164.9	36.62	182.9	42.31
	41	90.2	19.35	107.9	23.92	125.5	28.92	134.3	31.57	142.9	34.11	160.6	40.18	178.2	45.97
	43	88.0	21.03	105.3	26.03	122.4	31.53	130.9	34.41	139.4	37.22	156.7	43.86	173.7	50.20
46	82.6	23.55	98.6	29.23	114.8	35.45	122.7	38.68	130.6	41.87	146.7	49.42	162.7	57.20	
48	72.9	20.53	87.3	25.50	101.5	30.98	108.5	33.77	115.7	36.59	129.9	43.22	144.1	50.05	
50	10	77.5	9.35	92.7	10.83	107.5	12.32	114.8	13.19	122.1	13.99	136.9	15.76	152.6	17.53
	12	77.5	9.44	92.7	10.94	107.5	12.51	114.8	13.38	122.1	14.29	136.9	16.05	152.6	17.83
	14	77.5	9.56	92.7	11.13	107.5	12.70	114.8	13.59	122.1	14.48	136.9	16.26	152.6	18.14
	16	77.5	9.75	92.7	11.32	107.5	12.91	114.8	13.89	122.1	14.67	136.9	16.54	152.6	18.42
	18	77.5	9.85	92.7	11.42	107.5	13.10	114.8	14.08	122.1	14.98	136.9	16.85	152.6	18.82
	20	77.5	9.95	92.7	11.63	107.5	13.38	114.8	14.29	122.1	15.26	136.9	17.13	152.6	19.20
	21	77.5	10.05	92.7	11.72	107.5	13.50	114.8	14.48	122.1	15.36	136.9	17.32	152.6	19.39
	23	77.5	10.26	92.7	11.92	107.5	13.70	114.8	14.67	122.1	15.66	136.9	17.64	152.6	19.79
	25	77.5	10.35	92.7	12.11	107.5	13.99	114.8	14.98	122.1	16.16	136.9	18.52	152.6	21.17
	27	77.5	10.54	92.7	12.51	107.5	14.77	114.8	15.95	122.1	17.13	136.9	19.79	152.6	22.55
	29	77.5	11.13	92.7	13.29	107.5	15.66	114.8	16.94	122.1	18.23	136.9	20.98	152.6	23.93
	31	77.5	11.72	92.7	14.08	107.5	16.64	114.8	17.93	122.1	19.39	136.9	22.36	152.6	25.52
	33	77.5	12.41	92.7	14.88	107.5	17.64	114.8	19.01	122.1	20.58	136.9	23.73	152.6	27.18
	35	77.5	13.10	92.7	15.76	107.5	18.61	114.8	20.20	122.1	21.77	136.9	25.11	152.6	28.86
	37	77.5	13.89	92.7	16.64	107.5	19.70	114.8	21.36	122.1	23.05	136.9	26.80	152.6	30.64
	39	77.5	14.82	92.7	17.85	107.5	21.11	114.8	23.01	122.1	24.74	136.9	28.55	152.6	33.08
	41	75.4	16.01	90.2	19.32	104.7	23.08	112.0	24.92	118.9	26.80	133.4	31.27	148.5	35.93
	43	73.6	17.42	88.0	21.01	102.1	25.11	109.1	27.14	116.1	29.18	130.2	34.11	145.0	39.19
46	69.0	19.51	82.6	23.58	95.6	28.17	102.2	30.46	108.8	32.74	122.0	38.37	135.9	44.12	
48	61.1	16.98	72.9	20.55	84.6	24.57	90.5	26.59	96.2	28.58	107.9	33.53	120.2	38.56	

Note

1. TC: Total Capacity(kW), PI : Power Input(kW, Comp. + Outdoor fan motor)
2. Capacity tables show the average value of conditions which may occur.

7. Capacity Tables

◆ A(C)RUN840LLS5

Combination (%)	Outdoor air temp (°C DB)	Indoor air temp. (DB/WB, °C)														Cooling Capacity(84HP)	
		20		23		26		27		28		30		32		TC	PI
		14		16		18		19		20		22		24			
		TC	PI	TC	PI	TC	PI	TC	PI	TC	PI	TC	PI	TC	PI		
130	10	233.0	27.40	277.5	33.48	297.3	38.85	305.9	39.63	314.4	39.97	329.6	40.28	338.0	40.44		
	12	233.0	28.08	277.5	34.69	297.3	40.44	305.9	40.72	314.4	41.03	329.6	41.37	338.0	41.74		
	14	233.0	29.03	277.5	35.94	297.3	41.96	305.9	42.27	314.4	42.61	329.6	42.95	338.0	43.33		
	16	233.0	30.09	277.5	37.20	297.3	43.85	305.9	44.26	314.4	44.61	329.6	45.00	338.0	45.37		
	18	233.0	31.34	277.5	39.35	297.3	45.87	305.9	46.86	314.4	47.24	329.6	47.70	338.0	48.02		
	20	233.0	32.73	277.5	41.93	297.3	48.13	305.9	51.53	314.4	51.96	324.7	52.46	333.4	52.83		
	21	233.0	33.58	277.5	43.39	297.3	49.13	305.9	54.53	314.4	54.97	323.0	55.53	331.5	55.90		
	23	233.0	36.04	277.5	45.65	297.3	51.68	305.9	60.19	310.4	60.66	318.3	61.27	326.7	61.68		
	25	233.0	38.48	277.5	48.27	297.3	55.23	302.2	66.75	305.9	67.27	314.4	67.95	323.0	68.42		
	27	233.0	41.18	277.5	51.61	293.6	58.86	297.3	73.48	302.2	74.07	310.4	74.79	318.3	75.32		
	29	233.0	43.89	277.5	55.16	288.9	63.32	293.1	80.76	297.3	81.24	305.9	81.96	314.4	82.28		
	31	233.0	46.83	276.5	58.11	284.0	67.36	288.9	80.41	293.1	80.91	301.1	81.61	309.5	81.93		
	33	233.0	49.88	271.7	61.58	280.3	72.24	284.9	79.67	288.9	80.16	297.3	80.87	304.9	81.19		
	35	233.0	53.20	266.9	64.47	275.6	78.24	280.3	78.63	284.9	79.11	292.7	79.82	301.1	80.13		
	37	233.0	56.74	263.3	67.67	271.7	77.21	275.6	77.61	280.3	78.08	287.8	78.76	296.5	79.07		
	39	233.0	60.41	258.5	71.22	266.9	76.19	271.7	76.56	275.6	77.02	284.0	77.71	292.7	78.02		
	41	227.0	64.08	247.8	74.78	256.2	75.15	260.0	75.52	265.2	75.97	273.0	76.65	280.5	76.96		
	43	221.3	67.58	237.4	73.73	245.8	74.11	249.4	74.48	254.6	74.93	262.3	75.60	269.4	75.91		
46	207.4	72.34	216.7	72.21	224.6	72.56	228.1	72.93	232.7	73.36	240.1	74.02	246.7	74.32			
48	183.5	70.32	188.1	70.54	195.2	70.69	198.3	70.88	202.5	71.49	209.1	71.95	214.8	72.24			
120	10	210.7	24.66	250.7	30.22	273.9	35.93	282.3	38.82	290.5	39.44	306.4	39.59	313.7	39.91		
	12	210.7	25.32	250.7	31.25	273.9	37.37	282.3	39.63	290.5	40.90	306.4	41.39	313.7	41.72		
	14	210.7	26.19	250.7	32.30	273.9	38.89	282.3	41.15	290.5	42.39	306.4	43.02	313.7	43.35		
	16	210.7	27.14	250.7	33.63	273.9	40.37	282.3	42.68	290.5	44.35	306.4	44.91	313.7	45.25		
	18	210.7	28.19	250.7	35.15	273.9	42.00	282.3	44.94	290.5	46.62	306.4	47.15	313.7	47.55		
	20	210.7	29.26	250.7	37.26	273.9	44.26	282.3	47.27	290.5	49.10	306.4	49.75	313.7	50.13		
	21	210.7	30.15	250.7	38.61	273.9	45.50	282.3	48.67	290.5	50.72	306.4	51.37	313.7	51.77		
	23	210.7	32.24	250.7	41.31	273.9	48.74	282.3	51.72	290.5	54.07	306.4	54.60	313.7	55.04		
	25	210.7	34.45	250.7	44.26	273.9	51.40	282.3	55.13	290.5	57.98	302.7	58.45	310.1	58.92		
	27	210.7	36.78	250.7	47.31	273.9	54.72	282.3	58.92	290.5	62.30	298.2	62.73	305.5	63.23		
	29	210.7	39.22	250.7	50.50	273.9	57.58	282.3	63.04	285.9	66.40	293.4	67.40	301.7	67.95		
	31	210.7	41.80	250.7	53.94	273.9	60.56	278.5	67.52	282.3	71.24	289.8	72.49	296.9	73.08		
	33	210.7	44.50	250.7	57.49	270.1	64.04	273.9	73.30	277.6	76.49	285.0	77.36	292.4	77.98		
	35	210.7	47.31	250.7	61.28	265.5	67.80	269.2	80.76	273.9	81.15	281.4	81.40	288.7	82.05		
	37	210.7	50.90	250.7	64.67	261.7	72.28	265.5	79.04	269.2	79.45	276.6	79.69	284.3	80.32		
	39	210.7	54.79	249.8	68.36	257.1	76.65	261.0	77.43	264.6	77.82	273.0	78.05	280.5	78.67		
	41	205.4	58.70	238.8	72.02	246.9	75.15	250.4	75.81	254.0	76.19	261.3	76.41	268.8	77.02		
	43	200.3	62.64	228.8	71.00	236.8	73.48	240.1	74.17	243.6	74.54	250.9	74.78	258.2	75.37		
46	187.7	67.36	208.7	69.32	216.2	71.15	219.3	71.74	222.8	72.11	229.4	72.32	236.3	72.89			
48	166.0	65.97	181.2	68.08	187.9	69.78	190.9	70.19	193.8	70.41	199.6	70.69	205.8	70.99			
110	10	188.8	22.18	225.2	27.02	251.4	32.11	258.8	34.76	275.0	37.39	281.4	38.45	300.4	39.07		
	12	188.8	22.86	225.2	27.95	251.4	33.45	258.8	35.72	275.0	38.80	281.4	40.06	300.4	40.97		
	14	188.8	23.58	225.2	29.19	251.4	34.95	258.8	37.49	275.0	40.76	281.4	41.92	300.4	42.80		
	16	188.8	24.41	225.2	30.26	251.4	36.39	258.8	39.13	275.0	42.64	281.4	43.79	300.4	44.57		
	18	188.8	25.32	225.2	31.52	251.4	38.48	258.8	41.22	275.0	44.98	281.4	45.87	300.4	46.72		
	20	188.8	26.21	225.2	33.10	251.4	40.81	258.8	43.11	275.0	47.15	281.4	48.33	300.4	49.10		
	21	188.8	26.80	225.2	34.07	251.4	41.87	258.8	44.26	275.0	48.48	281.4	49.70	300.4	50.47		
	23	188.8	28.56	225.2	36.52	251.4	44.20	258.8	46.74	275.0	51.22	281.4	52.31	300.4	53.18		
	25	188.8	30.53	225.2	38.98	251.4	46.70	258.8	49.41	275.0	54.10	281.4	54.88	296.9	56.00		
	27	188.8	32.61	225.2	41.68	251.4	49.35	258.8	52.29	275.0	56.49	281.4	57.80	292.4	58.79		
	29	188.8	34.82	225.2	44.50	251.4	52.14	258.8	55.38	275.0	59.72	281.4	60.75	288.7	61.66		
	31	188.8	37.02	225.2	47.43	251.4	55.10	258.8	58.67	270.5	62.74	277.8	63.97	284.3	64.64		
	33	188.8	39.48	225.2	50.50	251.4	58.23	258.8	62.18	266.8	66.25	273.3	67.36	280.5	67.73		
	35	188.8	41.93	225.2	53.94	251.4	61.49	258.8	65.88	262.4	69.93	268.8	70.56	275.9	70.93		
	37	188.8	44.44	225.2	57.24	251.4	64.91	255.1	69.79	257.8	73.76	265.2	74.01	271.4	74.23		
	39	188.8	47.90	225.2	60.84	246.9	68.49	250.4	74.66	254.2	77.40	260.4	77.54	267.9	77.61		
	41	184.1	51.37	219.3	64.41	236.5	72.24	240.1	80.76	243.2	80.76	250.4	81.40	256.5	82.05		
	43	179.3	53.94	213.9	67.12	226.5	76.59	230.3	77.46	233.2	77.30	240.1	77.74	246.2	77.95		
46	168.2	52.64	200.5	64.79	206.7	72.70	210.3	72.70	212.9	73.32	219.5	73.73	225.2	73.92			
48	148.7	51.12	174.2	62.42	179.5	69.17	182.8	69.63	185.2	69.97	191.0	70.16	195.9	70.43			

Note

1. TC: Total Capacity(kW), PI : Power Input(kW, Comp. + Outdoor fan motor)
2. Capacity tables show the average value of conditions which may occur.

7. Capacity Tables

Combination (%)	Outdoor air temp (°C DB)	Cooling Capacity(84HP)													
		Indoor air temp. (DB/WB, °C)													
		20		23		26		27		28		30		32	
		14	16	18	19	20	22	24							
	TC	PI	TC	PI	TC	PI	TC	PI	TC	PI	TC	PI	TC	PI	
100	10	158.7	19.97	189.0	24.26	220.0	28.79	235.2	31.12	250.4	33.43	277.5	37.21	283.6	37.52
	12	158.7	20.62	189.0	25.25	220.0	29.76	235.2	31.95	250.4	34.50	277.5	39.22	283.6	39.60
	14	158.7	21.25	189.0	26.27	220.0	31.02	235.2	33.33	250.4	35.99	277.5	41.40	283.6	41.80
	16	158.7	21.90	189.0	27.14	220.0	32.34	235.2	34.91	250.4	37.92	277.5	43.41	283.6	44.01
	18	158.7	22.55	189.0	28.14	220.0	33.60	235.2	36.61	250.4	40.22	277.5	45.87	283.6	46.22
	20	158.7	23.36	189.0	29.22	220.0	35.56	235.2	39.22	250.4	43.02	277.5	48.05	283.6	48.44
	21	158.7	23.84	189.0	29.91	220.0	36.78	235.2	40.57	250.4	44.63	277.5	49.16	283.6	49.54
	23	158.7	25.25	189.0	31.99	220.0	39.48	235.2	43.52	250.4	47.80	277.5	51.46	283.6	51.89
	25	158.7	26.84	189.0	34.07	220.0	42.17	235.2	46.59	250.4	51.12	277.5	53.66	281.2	54.10
	27	158.7	28.69	189.0	36.41	220.0	45.10	235.2	49.76	250.4	54.35	272.1	56.18	277.9	56.64
	29	158.7	30.53	189.0	38.85	220.0	48.17	235.2	53.20	250.4	57.51	267.2	58.45	273.7	58.92
	31	158.7	32.61	189.0	41.43	220.0	51.37	235.2	56.75	250.4	60.44	263.0	60.71	269.5	61.21
	33	158.7	34.56	189.0	44.13	220.0	54.79	235.2	60.56	250.4	62.71	258.8	62.99	265.3	63.49
	35	158.7	36.78	189.0	46.96	220.0	58.36	235.2	64.60	246.5	64.97	254.2	65.25	260.6	65.75
	37	158.7	39.39	189.0	50.35	220.0	61.81	235.2	67.67	242.3	68.01	249.4	68.29	255.3	68.91
	39	158.7	42.24	189.0	54.10	220.0	65.50	235.2	70.99	238.5	71.30	245.5	71.56	251.1	72.24
	41	156.3	45.07	186.1	57.83	216.5	69.19	225.7	74.30	230.6	74.60	236.1	74.85	243.6	75.56
	43	150.9	47.70	179.7	61.31	209.1	72.49	216.4	77.15	218.8	77.40	225.5	77.67	231.6	78.39
46	141.5	51.31	168.3	66.10	196.1	76.89	197.6	80.76	199.6	81.00	206.1	81.22	211.6	82.00	
48	125.1	44.29	149.0	57.18	169.3	65.73	171.6	68.51	173.5	68.73	179.3	68.89	184.1	69.45	
90	10	142.8	17.38	170.6	20.88	198.3	24.62	211.6	26.54	225.2	28.57	252.9	31.97	280.5	35.55
	12	142.8	17.58	170.6	21.21	198.3	25.05	211.6	27.07	225.2	29.19	252.9	32.60	280.5	36.18
	14	142.8	17.91	170.6	21.63	198.3	25.58	211.6	27.61	225.2	29.73	252.9	33.24	280.5	36.92
	16	142.8	18.23	170.6	22.06	198.3	26.11	211.6	28.14	225.2	30.28	252.9	33.87	280.5	37.54
	18	142.8	18.54	170.6	22.49	198.3	26.54	211.6	28.79	225.2	30.91	252.9	34.61	280.5	39.44
	20	142.8	18.85	170.6	22.91	198.3	27.07	211.6	29.32	225.2	32.09	252.9	37.04	280.5	41.32
	21	142.8	19.07	170.6	23.13	198.3	27.61	211.6	30.28	225.2	33.25	252.9	37.64	280.5	42.28
	23	142.8	19.50	170.6	24.09	198.3	29.53	211.6	32.49	225.2	35.61	252.9	39.92	276.6	44.27
	25	142.8	20.47	170.6	25.67	198.3	31.55	211.6	34.74	225.2	38.04	252.9	42.68	272.7	46.15
	27	142.8	21.84	170.6	27.39	198.3	33.67	211.6	37.08	225.2	40.71	252.9	45.37	268.8	48.32
	29	142.8	23.13	170.6	29.19	198.3	36.01	211.6	39.66	225.2	43.49	252.9	48.07	264.6	50.26
	31	142.8	24.62	170.6	31.13	198.3	38.37	211.6	42.21	225.2	46.37	252.9	50.46	260.7	52.21
	33	142.8	26.23	170.6	33.15	198.3	40.93	211.6	44.99	225.2	49.17	252.9	52.91	256.8	54.15
	35	142.8	27.83	170.6	35.18	198.3	43.49	211.6	47.95	225.2	52.15	248.5	55.93	252.7	57.23
	37	142.8	29.53	170.6	37.41	198.3	46.37	211.6	50.94	225.2	55.05	244.5	58.48	248.7	59.79
	39	142.8	31.25	170.6	39.79	198.3	49.08	211.6	54.22	225.2	57.89	240.5	61.65	244.7	62.40
	41	139.2	34.98	166.1	44.12	193.2	53.87	206.2	59.29	219.3	62.50	230.4	64.96	234.5	66.46
	43	135.7	37.76	162.1	47.67	188.4	58.83	201.2	63.86	213.9	67.01	221.0	69.57	224.9	70.42
46	127.3	42.50	151.9	54.28	176.4	67.05	188.6	72.41	194.5	74.44	201.6	76.37	205.5	76.48	
48	112.5	37.14	134.4	47.48	156.1	58.64	166.7	63.16	168.7	64.15	175.3	65.74	178.6	65.83	
80	10	126.9	14.61	151.2	17.56	175.5	20.60	188.1	22.24	200.7	23.85	225.2	27.21	249.4	29.53
	12	126.9	14.92	151.2	17.75	175.5	21.01	188.1	22.63	200.7	24.25	225.2	27.71	249.4	30.12
	14	126.9	15.12	151.2	18.16	175.5	21.30	188.1	23.03	200.7	24.66	225.2	28.21	249.4	30.69
	16	126.9	15.32	151.2	18.47	175.5	21.71	188.1	23.44	200.7	25.16	225.2	28.83	249.4	31.29
	18	126.9	15.64	151.2	18.79	175.5	22.12	188.1	23.85	200.7	25.67	225.2	29.33	249.4	31.97
	20	126.9	15.93	151.2	19.19	175.5	22.63	188.1	24.35	200.7	26.19	225.2	30.44	249.4	33.87
	21	126.9	16.02	151.2	19.38	175.5	22.83	188.1	24.66	200.7	26.80	225.2	31.41	249.4	34.77
	23	126.9	16.34	151.2	19.69	175.5	23.85	188.1	26.19	200.7	28.61	225.2	33.17	249.4	36.49
	25	126.9	16.96	151.2	21.01	175.5	25.57	188.1	28.02	200.7	30.66	225.2	35.49	249.4	39.02
	27	126.9	17.96	151.2	22.33	175.5	27.30	188.1	29.94	200.7	32.67	225.2	37.71	249.4	41.05
	29	126.9	19.07	151.2	23.85	175.5	29.03	188.1	31.88	200.7	34.90	225.2	40.40	249.4	43.95
	31	126.9	20.30	151.2	25.27	175.5	30.95	188.1	34.00	200.7	37.16	225.2	42.88	249.4	46.14
	33	126.9	21.52	151.2	26.99	175.5	32.98	188.1	36.23	200.7	39.58	225.2	45.17	249.4	48.38
	35	126.9	22.83	151.2	28.61	175.5	35.12	188.1	38.58	200.7	42.22	225.2	47.90	246.9	50.13
	37	126.9	24.16	151.2	30.44	175.5	37.25	188.1	41.00	200.7	44.86	225.2	50.55	242.9	52.40
	39	126.9	25.53	151.2	32.17	175.5	39.83	188.1	44.08	200.7	48.21	225.2	53.40	238.8	55.28
	41	123.7	28.24	147.3	35.66	170.9	43.73	183.3	48.32	195.5	52.97	219.3	59.44	228.8	61.26
	43	120.5	31.10	143.7	38.89	166.7	47.75	178.7	52.66	190.9	57.89	213.9	63.61	219.3	65.59
46	113.0	34.59	134.7	43.82	156.3	53.78	167.6	58.62	178.7	65.31	195.7	69.42	200.3	70.55	
48	99.9	30.22	119.2	38.32	138.3	47.03	148.3	51.20	158.3	57.18	170.0	60.10	174.1	60.73	

Note

1. TC: Total Capacity(kW), PI : Power Input(kW, Comp. + Outdoor fan motor)
2. Capacity tables show the average value of conditions which may occur.

7. Capacity Tables

Combination (%)	Outdoor air temp (°C DB)	Cooling Capacity(84HP)													
		Indoor air temp. (DB/WB, °C)													
		20		23		26		27		28		30		32	
		14	16	18	19	20	22	24							
	TC	PI	TC	PI	TC	PI	TC	PI	TC	PI	TC	PI	TC	PI	
70	10	110.8	12.89	132.8	15.33	153.8	17.77	164.7	19.19	175.5	20.50	196.5	23.35	218.4	26.10
	12	110.8	13.09	132.8	15.53	153.8	18.15	164.7	19.48	175.5	20.91	196.5	23.75	218.4	26.60
	14	110.8	13.30	132.8	15.73	153.8	18.47	164.7	19.80	175.5	21.22	196.5	24.26	218.4	27.08
	16	110.8	13.49	132.8	16.03	153.8	18.78	164.7	20.21	175.5	21.61	196.5	24.67	218.4	27.66
	18	110.8	13.71	132.8	16.34	153.8	19.19	164.7	20.59	175.5	22.02	196.5	25.06	218.4	28.16
	20	110.8	13.90	132.8	16.64	153.8	19.48	164.7	21.00	175.5	22.52	196.5	25.68	218.4	29.23
	21	110.8	14.10	132.8	16.75	153.8	19.69	164.7	21.22	175.5	22.74	196.5	26.07	218.4	29.84
	23	110.8	14.31	132.8	17.14	153.8	20.09	164.7	21.92	175.5	23.85	196.5	27.91	218.4	31.52
	25	110.8	14.51	132.8	17.77	153.8	21.41	164.7	23.44	175.5	25.47	196.5	29.84	218.4	33.04
	27	110.8	15.33	132.8	18.97	153.8	22.83	164.7	24.86	175.5	27.21	196.5	31.87	218.4	35.12
	29	110.8	16.34	132.8	20.09	153.8	24.26	164.7	26.49	175.5	28.92	196.5	33.99	218.4	37.62
	31	110.8	17.36	132.8	21.41	153.8	25.88	164.7	28.32	175.5	30.85	196.5	36.23	218.4	39.91
	33	110.8	18.37	132.8	22.62	153.8	27.49	164.7	30.04	175.5	32.78	196.5	38.56	218.4	42.50
	35	110.8	19.39	132.8	24.16	153.8	29.23	164.7	31.96	175.5	34.90	196.5	41.11	218.4	45.07
	37	110.8	20.59	132.8	25.59	153.8	31.04	164.7	33.99	175.5	37.15	196.5	43.74	218.4	47.55
	39	110.8	21.89	132.8	27.27	153.8	33.20	164.7	36.58	175.5	40.13	196.5	46.81	218.4	51.28
	41	107.9	24.20	129.3	29.87	149.9	36.42	160.5	40.13	170.9	43.61	191.6	51.41	212.9	55.31
	43	105.4	26.32	126.0	32.57	146.1	39.75	156.5	43.74	166.7	47.64	186.8	56.16	207.4	59.80
46	98.8	29.26	118.2	36.62	137.0	44.76	146.6	48.72	156.3	53.69	175.1	63.35	194.5	66.65	
48	87.3	25.53	104.6	31.99	121.1	39.12	129.6	42.57	138.3	46.97	154.8	55.44	172.2	57.68	
60	10	95.0	11.15	113.4	13.09	131.8	15.23	141.2	16.33	150.3	17.35	168.9	19.68	187.4	22.01
	12	95.0	11.37	113.4	13.29	131.8	15.42	141.2	16.54	150.3	17.66	168.9	19.99	187.4	22.42
	14	95.0	11.46	113.4	13.50	131.8	15.72	141.2	16.83	150.3	17.96	168.9	20.40	187.4	22.83
	16	95.0	11.66	113.4	13.80	131.8	15.94	141.2	17.15	150.3	18.37	168.9	20.79	187.4	23.23
	18	95.0	11.88	113.4	14.00	131.8	16.23	141.2	17.44	150.3	18.68	168.9	21.11	187.4	23.74
	20	95.0	12.07	113.4	14.22	131.8	16.54	141.2	17.76	150.3	18.98	168.9	21.50	187.4	24.25
	21	95.0	12.17	113.4	14.31	131.8	16.74	141.2	17.96	150.3	19.17	168.9	21.81	187.4	24.46
	23	95.0	12.39	113.4	14.61	131.8	16.96	141.2	18.27	150.3	19.59	168.9	22.62	187.4	25.97
	25	95.0	12.59	113.4	14.92	131.8	17.66	141.2	19.17	150.3	20.79	168.9	24.15	187.4	27.79
	27	95.0	13.00	113.4	15.72	131.8	18.78	141.2	20.40	150.3	22.13	168.9	25.68	187.4	29.64
	29	95.0	13.80	113.4	16.74	131.8	19.99	141.2	21.72	150.3	23.54	168.9	27.40	187.4	31.66
	31	95.0	14.61	113.4	17.76	131.8	21.20	141.2	23.13	150.3	25.07	168.9	29.22	187.4	33.70
	33	95.0	15.42	113.4	18.78	131.8	22.52	141.2	24.56	150.3	26.68	168.9	31.05	187.4	35.92
	35	95.0	16.33	113.4	19.99	131.8	23.96	141.2	26.07	150.3	28.31	168.9	33.09	187.4	38.14
	37	95.0	17.25	113.4	21.09	131.8	25.36	141.2	27.70	150.3	30.03	168.9	35.10	187.4	40.59
	39	95.0	18.33	113.4	22.46	131.8	27.38	141.2	29.71	150.3	32.33	168.9	37.66	187.4	43.50
	41	92.4	19.90	110.5	24.59	128.6	29.74	137.5	32.46	146.4	35.08	164.5	41.31	182.6	47.27
	43	90.2	21.62	107.9	26.77	125.3	32.42	134.1	35.38	142.8	38.27	160.5	45.10	178.0	51.62
46	84.6	24.22	101.0	30.05	117.6	36.45	125.7	39.77	133.8	43.05	150.3	50.82	166.7	58.81	
48	74.7	21.11	89.5	26.22	103.9	31.85	111.2	34.73	118.5	37.62	133.1	44.44	147.6	51.46	
50	10	79.4	9.64	95.0	11.15	110.1	12.69	117.6	13.59	125.1	14.41	140.2	16.23	156.3	18.06
	12	79.4	9.73	95.0	11.27	110.1	12.89	117.6	13.79	125.1	14.72	140.2	16.53	156.3	18.36
	14	79.4	9.85	95.0	11.46	110.1	13.08	117.6	14.00	125.1	14.91	140.2	16.75	156.3	18.68
	16	79.4	10.05	95.0	11.66	110.1	13.30	117.6	14.30	125.1	15.11	140.2	17.04	156.3	18.97
	18	79.4	10.14	95.0	11.76	110.1	13.50	117.6	14.50	125.1	15.43	140.2	17.36	156.3	19.38
	20	79.4	10.24	95.0	11.98	110.1	13.79	117.6	14.72	125.1	15.72	140.2	17.65	156.3	19.78
	21	79.4	10.35	95.0	12.07	110.1	13.91	117.6	14.91	125.1	15.82	140.2	17.85	156.3	19.97
	23	79.4	10.56	95.0	12.28	110.1	14.11	117.6	15.11	125.1	16.13	140.2	18.17	156.3	20.39
	25	79.4	10.66	95.0	12.48	110.1	14.41	117.6	15.43	125.1	16.65	140.2	19.07	156.3	21.81
	27	79.4	10.85	95.0	12.89	110.1	15.21	117.6	16.43	125.1	17.65	140.2	20.39	156.3	23.23
	29	79.4	11.46	95.0	13.69	110.1	16.13	117.6	17.45	125.1	18.78	140.2	21.62	156.3	24.65
	31	79.4	12.07	95.0	14.50	110.1	17.14	117.6	18.47	125.1	19.97	140.2	23.03	156.3	26.28
	33	79.4	12.79	95.0	15.33	110.1	18.17	117.6	19.58	125.1	21.20	140.2	24.45	156.3	28.00
	35	79.4	13.50	95.0	16.23	110.1	19.17	117.6	20.81	125.1	22.42	140.2	25.87	156.3	29.73
	37	79.4	14.30	95.0	17.14	110.1	20.29	117.6	22.01	125.1	23.74	140.2	27.60	156.3	31.56
	39	79.4	15.26	95.0	18.39	110.1	21.75	117.6	23.70	125.1	25.48	140.2	29.41	156.3	34.08
	41	77.2	16.50	92.4	19.90	107.2	23.77	114.7	25.67	121.8	27.61	136.6	32.21	152.1	37.01
	43	75.4	17.94	90.2	21.64	104.6	25.87	111.8	27.96	118.9	30.06	133.3	35.14	148.6	40.37
46	70.7	20.10	84.6	24.28	97.9	29.02	104.7	31.38	111.4	33.73	124.9	39.53	139.2	45.45	
48	62.6	17.50	74.7	21.16	86.6	25.31	92.7	27.39	98.6	29.44	110.5	34.54	123.1	39.72	

Note

1. TC: Total Capacity(kW), PI : Power Input(kW, Comp. + Outdoor fan motor)
2. Capacity tables show the average value of conditions which may occur.

7. Capacity Tables

◆ A(C)RUN860LLS5

Combination (%)	Outdoor air temp (°C DB)	Indoor air temp. (DB/WB, °C)														Cooling Capacity(86HP)	
		20		23		26		27		28		30		32		TC	PI
		14		16		18		19		20		22		24			
		TC	PI	TC	PI	TC	PI	TC	PI	TC	PI	TC	PI	TC	PI		
130	10	238.5	28.55	284.1	34.88	304.4	40.47	313.2	41.29	321.8	41.64	337.4	41.96	346.0	42.13		
	12	238.5	29.25	284.1	36.14	304.4	42.13	313.2	42.42	321.8	42.74	337.4	43.10	346.0	43.48		
	14	238.5	30.25	284.1	37.44	304.4	43.71	313.2	44.03	321.8	44.39	337.4	44.75	346.0	45.14		
	16	238.5	31.34	284.1	38.75	304.4	45.68	313.2	46.11	321.8	46.47	337.4	46.89	346.0	47.27		
	18	238.5	32.65	284.1	40.99	304.4	47.79	313.2	48.81	321.8	49.21	337.4	49.69	346.0	50.03		
	20	238.5	34.10	284.1	43.68	304.4	50.15	313.2	53.68	321.8	54.13	332.5	54.65	341.3	55.04		
	21	238.5	34.98	284.1	45.21	304.4	51.19	313.2	56.81	321.8	57.27	330.7	57.85	339.4	58.24		
	23	238.5	37.54	284.1	47.56	304.4	53.84	313.2	62.70	317.8	63.20	325.8	63.83	334.5	64.26		
	25	238.5	40.09	284.1	50.28	304.4	57.53	309.4	69.54	313.2	70.09	321.8	70.79	330.7	71.28		
	27	238.5	42.90	284.1	53.77	300.6	61.31	304.4	76.55	309.4	77.16	317.8	77.91	325.8	78.47		
	29	238.5	45.72	284.1	57.47	295.7	65.97	300.0	84.13	304.4	84.64	313.2	85.39	321.8	85.72		
	31	238.5	48.79	283.1	60.54	290.8	70.18	295.7	83.77	300.0	84.29	308.3	85.03	316.9	85.36		
	33	238.5	51.96	278.2	64.15	287.0	75.26	291.7	83.00	295.7	83.51	304.4	84.25	312.1	84.58		
	35	238.5	55.43	273.2	67.17	282.2	81.51	287.0	81.92	291.7	82.41	299.6	83.16	308.3	83.48		
	37	238.5	59.11	269.5	70.50	278.2	80.44	282.2	80.85	287.0	81.34	294.7	82.05	303.5	82.37		
	39	238.5	62.93	264.6	74.19	273.2	79.37	278.2	79.76	282.2	80.24	290.8	80.96	299.6	81.28		
	41	232.5	66.76	253.7	77.91	262.3	78.29	266.2	78.68	271.5	79.15	279.5	79.86	287.2	80.17		
	43	226.6	70.41	243.1	76.82	251.7	77.20	255.3	77.59	260.6	78.07	268.6	78.76	275.9	79.08		
46	212.3	75.36	221.8	75.23	229.9	75.59	233.5	75.98	238.3	76.43	245.8	77.11	252.6	77.43			
48	187.9	73.26	192.6	73.48	199.8	73.64	203.0	73.84	207.3	74.48	214.0	74.96	220.0	75.25			
120	10	215.7	25.69	256.6	31.48	280.4	37.43	289.0	40.45	297.4	41.09	313.6	41.25	321.2	41.58		
	12	215.7	26.37	256.6	32.56	280.4	38.93	289.0	41.29	297.4	42.60	313.6	43.12	321.2	43.46		
	14	215.7	27.28	256.6	33.65	280.4	40.51	289.0	42.87	297.4	44.16	313.6	44.82	321.2	45.17		
	16	215.7	28.28	256.6	35.04	280.4	42.06	289.0	44.46	297.4	46.20	313.6	46.79	321.2	47.14		
	18	215.7	29.37	256.6	36.62	280.4	43.75	289.0	46.81	297.4	48.57	313.6	49.12	321.2	49.53		
	20	215.7	30.48	256.6	38.82	280.4	46.11	289.0	49.25	297.4	51.15	313.6	51.83	321.2	52.23		
	21	215.7	31.41	256.6	40.22	280.4	47.40	289.0	50.71	297.4	52.84	313.6	53.52	321.2	53.93		
	23	215.7	33.58	256.6	43.03	280.4	50.78	289.0	53.88	297.4	56.33	313.6	56.88	321.2	57.34		
	25	215.7	35.89	256.6	46.11	280.4	53.55	289.0	57.44	297.4	60.41	309.9	60.89	317.5	61.39		
	27	215.7	38.31	256.6	49.29	280.4	57.01	289.0	61.38	297.4	64.90	305.3	65.35	312.8	65.87		
	29	215.7	40.86	256.6	52.61	280.4	59.98	289.0	65.67	292.7	69.18	300.3	70.22	308.9	70.79		
	31	215.7	43.55	256.6	56.20	280.4	63.09	285.2	70.34	289.0	74.22	296.7	75.52	304.0	76.13		
	33	215.7	46.36	256.6	59.89	276.6	66.72	280.4	76.36	284.2	79.69	291.8	80.60	299.4	81.24		
	35	215.7	49.29	256.6	63.84	271.9	70.63	275.6	84.13	280.4	84.55	288.1	84.80	295.6	85.48		
	37	215.7	53.03	256.6	67.37	268.0	75.30	271.9	82.35	275.6	82.77	283.2	83.02	291.0	83.68		
	39	215.7	57.08	255.7	71.22	263.3	79.86	267.2	80.67	270.9	81.08	279.5	81.31	287.1	81.96		
	41	210.3	61.15	244.5	75.03	252.8	78.29	256.4	78.97	260.0	79.37	267.6	79.60	275.2	80.24		
	43	205.1	65.26	234.2	73.97	242.4	76.55	245.8	77.27	249.4	77.66	256.9	77.91	264.3	78.52		
46	192.2	70.18	213.7	72.22	221.3	74.13	224.6	74.74	228.1	75.12	234.9	75.35	241.9	75.94			
48	170.0	68.73	185.6	70.93	192.4	72.69	195.5	73.12	198.4	73.35	204.4	73.65	210.7	73.96			
110	10	193.3	23.11	230.6	28.15	257.4	33.45	264.9	36.21	281.5	38.96	288.1	40.06	307.6	40.70		
	12	193.3	23.82	230.6	29.12	257.4	34.85	264.9	37.21	281.5	40.42	288.1	41.74	307.6	42.69		
	14	193.3	24.56	230.6	30.41	257.4	36.41	264.9	39.06	281.5	42.46	288.1	43.67	307.6	44.59		
	16	193.3	25.43	230.6	31.52	257.4	37.92	264.9	40.77	281.5	44.42	288.1	45.62	307.6	46.43		
	18	193.3	26.38	230.6	32.84	257.4	40.09	264.9	42.94	281.5	46.86	288.1	47.79	307.6	48.67		
	20	193.3	27.31	230.6	34.49	257.4	42.52	264.9	44.91	281.5	49.12	288.1	50.35	307.6	51.15		
	21	193.3	27.92	230.6	35.49	257.4	43.62	264.9	46.11	281.5	50.51	288.1	51.77	307.6	52.58		
	23	193.3	29.76	230.6	38.05	257.4	46.05	264.9	48.69	281.5	53.36	288.1	54.49	307.6	55.40		
	25	193.3	31.81	230.6	40.61	257.4	48.65	264.9	51.48	281.5	56.36	288.1	57.17	303.9	58.34		
	27	193.3	33.97	230.6	43.42	257.4	51.41	264.9	54.48	281.5	58.85	288.1	60.21	299.4	61.25		
	29	193.3	36.27	230.6	46.36	257.4	54.32	264.9	57.69	281.5	62.22	288.1	63.29	295.6	64.24		
	31	193.3	38.57	230.6	49.42	257.4	57.40	264.9	61.12	277.0	65.36	284.4	66.65	291.0	67.34		
	33	193.3	41.12	230.6	52.61	257.4	60.66	264.9	64.78	273.2	69.02	279.8	70.18	287.2	70.56		
	35	193.3	43.68	230.6	56.20	257.4	64.06	264.9	68.63	268.6	72.86	275.2	73.51	282.5	73.89		
	37	193.3	46.29	230.6	59.64	257.4	67.62	261.2	72.71	263.9	76.84	271.5	77.11	277.9	77.33		
	39	193.3	49.90	230.6	63.38	252.8	71.35	256.4	77.78	260.3	80.63	266.6	80.79	274.2	80.86		
	41	188.5	53.52	224.6	67.10	242.1	75.25	245.8	84.13	249.0	84.13	256.3	84.80	262.6	85.48		
	43	183.6	56.20	219.0	69.92	231.9	79.79	235.8	80.69	238.8	80.53	245.8	80.98	252.1	81.21		
46	172.2	54.84	205.3	67.50	211.6	75.73	215.3	75.73	218.0	76.39	224.7	76.81	230.6	77.00			
48	152.3	53.26	178.3	65.03	183.8	72.06	187.2	72.54	189.6	72.89	195.5	73.10	200.5	73.38			

Note

1. TC: Total Capacity(kW), PI : Power Input(kW, Comp. + Outdoor fan motor)
2. Capacity tables show the average value of conditions which may occur.

7. Capacity Tables

Combination (%)	Outdoor air temp (°C DB)	Cooling Capacity(86HP)													
		Indoor air temp. (DB/WB, °C)													
		20		23		26		27		28		30		32	
		14	16	18	19	20	22	24	TC	PI	TC	PI	TC	PI	
100	10	162.5	20.80	193.5	25.27	225.2	30.00	240.8	32.42	256.4	34.82	284.1	38.77	290.4	39.08
	12	162.5	21.48	193.5	26.31	225.2	31.00	240.8	33.29	256.4	35.94	284.1	40.86	290.4	41.26
	14	162.5	22.14	193.5	27.37	225.2	32.32	240.8	34.72	256.4	37.50	284.1	43.13	290.4	43.55
	16	162.5	22.82	193.5	28.28	225.2	33.69	240.8	36.37	256.4	39.50	284.1	45.23	290.4	45.85
	18	162.5	23.49	193.5	29.32	225.2	35.01	240.8	38.14	256.4	41.90	284.1	47.79	290.4	48.15
	20	162.5	24.33	193.5	30.44	225.2	37.04	240.8	40.86	256.4	44.82	284.1	50.06	290.4	50.47
	21	162.5	24.84	193.5	31.16	225.2	38.31	240.8	42.26	256.4	46.49	284.1	51.21	290.4	51.62
	23	162.5	26.31	193.5	33.33	225.2	41.12	240.8	45.34	256.4	49.80	284.1	53.62	290.4	54.06
	25	162.5	27.96	193.5	35.49	225.2	43.94	240.8	48.53	256.4	53.25	284.1	55.91	287.9	56.36
	27	162.5	29.89	193.5	37.93	225.2	46.98	240.8	51.84	256.4	56.62	278.6	58.53	284.5	59.01
	29	162.5	31.81	193.5	40.48	225.2	50.19	240.8	55.43	256.4	59.92	273.5	60.89	280.2	61.38
	31	162.5	33.97	193.5	43.16	225.2	53.52	240.8	59.12	256.4	62.97	269.3	63.25	275.9	63.77
	33	162.5	36.01	193.5	45.98	225.2	57.08	240.8	63.09	256.4	65.33	265.0	65.62	271.6	66.14
	35	162.5	38.31	193.5	48.92	225.2	60.79	240.8	67.30	252.4	67.69	260.3	67.98	266.9	68.50
	37	162.5	41.03	193.5	52.46	225.2	64.39	240.8	70.50	248.1	70.86	255.3	71.15	261.4	71.79
	39	162.5	44.00	193.5	56.36	225.2	68.23	240.8	73.96	244.1	74.28	251.4	74.55	257.1	75.25
	41	160.0	46.95	190.5	60.25	221.6	72.08	231.1	77.40	236.1	77.72	241.7	77.98	249.4	78.72
	43	154.5	49.69	183.9	63.87	214.1	75.52	221.6	80.37	224.0	80.63	230.9	80.92	237.1	81.67
46	144.8	53.45	172.3	68.86	200.7	80.11	202.3	84.13	204.4	84.38	211.0	84.61	216.6	85.42	
48	128.1	46.14	152.5	59.57	173.3	68.47	175.7	71.38	177.6	71.61	183.5	71.77	188.5	72.35	
90	10	146.2	18.04	174.7	21.67	203.0	25.55	216.6	27.55	230.6	29.66	258.9	33.18	287.2	36.90
	12	146.2	18.25	174.7	22.02	203.0	26.00	216.6	28.10	230.6	30.30	258.9	33.83	287.2	37.55
	14	146.2	18.59	174.7	22.45	203.0	26.55	216.6	28.66	230.6	30.86	258.9	34.50	287.2	38.32
	16	146.2	18.92	174.7	22.90	203.0	27.10	216.6	29.20	230.6	31.43	258.9	35.15	287.2	38.97
	18	146.2	19.24	174.7	23.35	203.0	27.55	216.6	29.88	230.6	32.08	258.9	35.93	287.2	40.94
	20	146.2	19.57	174.7	23.78	203.0	28.10	216.6	30.43	230.6	33.31	258.9	38.45	287.2	42.89
	21	146.2	19.79	174.7	24.00	203.0	28.66	216.6	31.43	230.6	34.51	258.9	39.07	287.2	43.88
	23	146.2	20.24	174.7	25.00	203.0	30.65	216.6	33.73	230.6	36.96	258.9	41.43	283.2	45.95
	25	146.2	21.24	174.7	26.65	203.0	32.75	216.6	36.06	230.6	39.49	258.9	44.30	279.2	47.90
	27	146.2	22.67	174.7	28.43	203.0	34.95	216.6	38.49	230.6	42.26	258.9	47.09	275.2	50.15
	29	146.2	24.00	174.7	30.30	203.0	37.38	216.6	41.16	230.6	45.14	258.9	49.90	270.9	52.17
	31	146.2	25.55	174.7	32.31	203.0	39.83	216.6	43.82	230.6	48.13	258.9	52.38	266.9	54.19
	33	146.2	27.23	174.7	34.41	203.0	42.49	216.6	46.70	230.6	51.04	258.9	54.91	262.9	56.21
	35	146.2	28.88	174.7	36.51	203.0	45.14	216.6	49.77	230.6	54.13	254.4	58.05	258.7	59.41
	37	146.2	30.65	174.7	38.83	203.0	48.13	216.6	52.88	230.6	57.14	250.3	60.70	254.6	62.06
	39	146.2	32.44	174.7	41.30	203.0	50.94	216.6	56.28	230.6	60.09	246.2	64.00	250.5	64.77
	41	142.5	36.31	170.0	45.79	197.8	55.91	211.1	61.54	224.6	64.87	235.9	67.43	240.1	68.98
	43	138.9	39.19	165.9	49.48	192.8	61.06	206.0	66.29	219.0	69.56	226.3	72.21	230.2	73.09
46	130.3	44.11	155.5	56.34	180.6	69.59	193.1	75.16	199.1	77.27	206.4	79.27	210.4	79.39	
48	115.2	38.55	137.6	49.29	159.8	60.87	170.7	65.56	172.7	66.58	179.5	68.24	182.9	68.33	
80	10	129.9	15.10	154.8	18.16	179.7	21.30	192.6	22.99	205.5	24.66	230.6	28.13	255.3	30.53
	12	129.9	15.43	154.8	18.35	179.7	21.72	192.6	23.39	205.5	25.07	230.6	28.65	255.3	31.14
	14	129.9	15.63	154.8	18.77	179.7	22.02	192.6	23.81	205.5	25.49	230.6	29.17	255.3	31.73
	16	129.9	15.84	154.8	19.09	179.7	22.45	192.6	24.23	205.5	26.01	230.6	29.80	255.3	32.35
	18	129.9	16.17	154.8	19.42	179.7	22.87	192.6	24.66	205.5	26.54	230.6	30.32	255.3	33.05
	20	129.9	16.47	154.8	19.83	179.7	23.39	192.6	25.18	205.5	27.08	230.6	31.47	255.3	35.01
	21	129.9	16.56	154.8	20.04	179.7	23.60	192.6	25.49	205.5	27.70	230.6	32.47	255.3	35.94
	23	129.9	16.89	154.8	20.35	179.7	24.66	192.6	27.08	205.5	29.58	230.6	34.29	255.3	37.73
	25	129.9	17.53	154.8	21.72	179.7	26.44	192.6	28.97	205.5	31.69	230.6	36.69	255.3	40.34
	27	129.9	18.57	154.8	23.08	179.7	28.22	192.6	30.95	205.5	33.78	230.6	38.98	255.3	42.44
	29	129.9	19.72	154.8	24.66	179.7	30.01	192.6	32.96	205.5	36.08	230.6	41.76	255.3	45.43
	31	129.9	20.98	154.8	26.12	179.7	31.99	192.6	35.15	205.5	38.42	230.6	44.33	255.3	47.70
	33	129.9	22.24	154.8	27.90	179.7	34.09	192.6	37.45	205.5	40.92	230.6	46.70	255.3	50.01
	35	129.9	23.60	154.8	29.58	179.7	36.30	192.6	39.88	205.5	43.65	230.6	49.52	252.7	51.82
	37	129.9	24.97	154.8	31.47	179.7	38.51	192.6	42.39	205.5	46.38	230.6	52.25	248.7	54.17
	39	129.9	26.40	154.8	33.26	179.7	41.18	192.6	45.57	205.5	49.84	230.6	55.21	244.5	57.15
	41	126.7	29.19	150.8	36.86	175.0	45.21	187.6	49.95	200.1	54.76	224.6	61.45	234.2	63.33
	43	123.4	32.15	147.1	40.21	170.7	49.36	182.9	54.44	195.5	59.85	219.0	65.76	224.6	67.81
46	115.7	35.76	137.9	45.30	160.0	55.59	171.6	60.60	182.9	67.52	200.3	71.77	205.0	72.94	
48	102.3	31.24	122.0	39.62	141.6	48.62	151.8	52.93	162.0	59.11	174.0	62.13	178.3	62.78	

Note

1. TC: Total Capacity(kW), PI : Power Input(kW, Comp. + Outdoor fan motor)
2. Capacity tables show the average value of conditions which may occur.

7. Capacity Tables

Combination (%)	Outdoor air temp (°C DB)	Cooling Capacity(86HP)													
		Indoor air temp. (DB/WB, °C)													
		20		23		26		27		28		30		32	
		14	16	18	19	20	22	24							
	TC	PI	TC	PI	TC	PI	TC	PI	TC	PI	TC	PI	TC	PI	
70	10	113.4	13.27	136.0	15.79	157.5	18.30	168.6	19.76	179.7	21.10	201.2	24.04	223.6	26.87
	12	113.4	13.48	136.0	15.99	157.5	18.69	168.6	20.06	179.7	21.53	201.2	24.45	223.6	27.39
	14	113.4	13.70	136.0	16.20	157.5	19.02	168.6	20.38	179.7	21.84	201.2	24.98	223.6	27.88
	16	113.4	13.89	136.0	16.51	157.5	19.33	168.6	20.81	179.7	22.25	201.2	25.40	223.6	28.48
	18	113.4	14.11	136.0	16.82	157.5	19.76	168.6	21.20	179.7	22.67	201.2	25.80	223.6	28.99
	20	113.4	14.31	136.0	17.13	157.5	20.06	168.6	21.62	179.7	23.19	201.2	26.44	223.6	30.10
	21	113.4	14.51	136.0	17.25	157.5	20.28	168.6	21.84	179.7	23.41	201.2	26.85	223.6	30.73
	23	113.4	14.74	136.0	17.65	157.5	20.68	168.6	22.57	179.7	24.56	201.2	28.73	223.6	32.45
	25	113.4	14.94	136.0	18.30	157.5	22.05	168.6	24.13	179.7	26.22	201.2	30.72	223.6	34.02
	27	113.4	15.79	136.0	19.54	157.5	23.51	168.6	25.60	179.7	28.01	201.2	32.81	223.6	36.16
	29	113.4	16.82	136.0	20.68	157.5	24.98	168.6	27.27	179.7	29.78	201.2	34.99	223.6	38.74
	31	113.4	17.87	136.0	22.05	157.5	26.64	168.6	29.16	179.7	31.76	201.2	37.30	223.6	41.09
	33	113.4	18.91	136.0	23.29	157.5	28.31	168.6	30.92	179.7	33.75	201.2	39.70	223.6	43.76
	35	113.4	19.96	136.0	24.88	157.5	30.10	168.6	32.91	179.7	35.94	201.2	42.32	223.6	46.40
	37	113.4	21.20	136.0	26.35	157.5	31.96	168.6	34.99	179.7	38.25	201.2	45.04	223.6	48.96
	39	113.4	22.53	136.0	28.08	157.5	34.18	168.6	37.66	179.7	41.31	201.2	48.20	223.6	52.80
	41	110.5	24.91	132.4	30.76	153.4	37.50	164.3	41.31	175.0	44.91	196.2	52.93	217.9	56.95
	43	107.9	27.10	129.0	33.53	149.6	40.93	160.2	45.04	170.7	49.05	191.2	57.82	212.4	61.57
46	101.2	30.13	121.1	37.70	140.3	46.08	150.1	50.17	160.0	55.28	179.2	65.22	199.1	68.63	
48	89.4	26.29	107.1	32.94	124.0	40.28	132.7	43.83	141.6	48.36	158.5	57.08	176.3	59.39	
60	10	97.3	11.44	116.1	13.42	134.9	15.61	144.6	16.74	153.9	17.79	172.9	20.18	191.9	22.57
	12	97.3	11.66	116.1	13.63	134.9	15.81	144.6	16.97	153.9	18.11	172.9	20.50	191.9	22.99
	14	97.3	11.75	116.1	13.85	134.9	16.12	144.6	17.26	153.9	18.41	172.9	20.92	191.9	23.41
	16	97.3	11.96	116.1	14.15	134.9	16.34	144.6	17.59	153.9	18.84	172.9	21.32	191.9	23.82
	18	97.3	12.18	116.1	14.35	134.9	16.64	144.6	17.89	153.9	19.15	172.9	21.65	191.9	24.34
	20	97.3	12.38	116.1	14.58	134.9	16.97	144.6	18.21	153.9	19.46	172.9	22.05	191.9	24.86
	21	97.3	12.48	116.1	14.67	134.9	17.17	144.6	18.41	153.9	19.66	172.9	22.37	191.9	25.08
	23	97.3	12.71	116.1	14.98	134.9	17.39	144.6	18.73	153.9	20.08	172.9	22.19	191.9	26.63
	25	97.3	12.91	116.1	15.30	134.9	18.11	144.6	19.66	153.9	21.32	172.9	24.77	191.9	28.50
	27	97.3	13.33	116.1	16.12	134.9	19.26	144.6	20.92	153.9	22.69	172.9	26.33	191.9	30.39
	29	97.3	14.15	116.1	17.17	134.9	20.50	144.6	22.27	153.9	24.14	172.9	28.10	191.9	32.46
	31	97.3	14.98	116.1	18.21	134.9	21.74	144.6	23.72	153.9	25.71	172.9	29.97	191.9	34.55
	33	97.3	15.81	116.1	19.26	134.9	23.10	144.6	25.19	153.9	27.36	172.9	31.84	191.9	36.84
	35	97.3	16.74	116.1	20.50	134.9	24.57	144.6	26.73	153.9	29.03	172.9	33.93	191.9	39.11
	37	97.3	17.68	116.1	21.63	134.9	26.00	144.6	28.40	153.9	30.79	172.9	35.99	191.9	41.63
	39	97.3	18.80	116.1	23.03	134.9	28.07	144.6	30.46	153.9	33.15	172.9	38.61	191.9	44.61
	41	94.6	20.40	113.1	25.22	131.7	30.50	140.8	33.29	149.9	35.97	168.4	42.36	186.9	48.47
	43	92.3	22.17	110.4	27.45	128.3	33.24	137.3	36.28	146.2	39.24	164.3	46.24	182.2	52.93
46	86.6	24.83	103.5	30.82	120.4	37.37	128.7	40.78	137.0	44.15	153.9	52.11	170.7	60.31	
48	76.5	21.65	91.6	26.89	106.4	32.66	113.8	35.61	121.3	38.58	136.2	45.57	151.2	52.77	
50	10	81.3	9.84	97.3	11.39	112.7	12.96	120.4	13.88	128.1	14.71	143.5	16.58	160.0	18.45
	12	81.3	9.94	97.3	11.51	112.7	13.16	120.4	14.08	128.1	15.03	143.5	16.89	160.0	18.75
	14	81.3	10.06	97.3	11.71	112.7	13.36	120.4	14.30	128.1	15.23	143.5	17.11	160.0	19.08
	16	81.3	10.26	97.3	11.91	112.7	13.58	120.4	14.61	128.1	15.43	143.5	17.40	160.0	19.37
	18	81.3	10.36	97.3	12.01	112.7	13.78	120.4	14.81	128.1	15.76	143.5	17.73	160.0	19.80
	20	81.3	10.46	97.3	12.23	112.7	14.08	120.4	15.03	128.1	16.05	143.5	18.02	160.0	20.20
	21	81.3	10.57	97.3	12.33	112.7	14.21	120.4	15.23	128.1	16.16	143.5	18.23	160.0	20.40
	23	81.3	10.79	97.3	12.54	112.7	14.41	120.4	15.43	128.1	16.47	143.5	18.55	160.0	20.82
	25	81.3	10.88	97.3	12.74	112.7	14.71	120.4	15.76	128.1	17.00	143.5	19.48	160.0	22.27
	27	81.3	11.08	97.3	13.16	112.7	15.54	120.4	16.78	128.1	18.02	143.5	20.82	160.0	23.72
	29	81.3	11.71	97.3	13.98	112.7	16.47	120.4	17.82	128.1	19.17	143.5	22.07	160.0	25.17
	31	81.3	12.33	97.3	14.81	112.7	17.51	120.4	18.86	128.1	20.40	143.5	23.52	160.0	26.84
	33	81.3	13.06	97.3	15.65	112.7	18.55	120.4	20.00	128.1	21.65	143.5	24.96	160.0	28.59
	35	81.3	13.78	97.3	16.58	112.7	19.57	120.4	21.25	128.1	22.90	143.5	26.42	160.0	30.36
	37	81.3	14.61	97.3	17.51	112.7	20.72	120.4	22.48	128.1	24.25	143.5	28.19	160.0	32.23
	39	81.3	15.59	97.3	18.78	112.7	22.21	120.4	24.21	128.1	26.02	143.5	30.03	160.0	34.80
	41	79.1	16.85	94.6	20.32	109.8	24.27	117.4	26.22	124.7	28.19	139.9	32.90	155.8	37.79
	43	77.2	18.32	92.3	22.10	107.1	26.42	114.5	28.55	121.8	30.69	136.5	35.89	152.1	41.23
46	72.4	20.52	86.6	24.80	100.3	29.64	107.2	32.05	114.1	34.45	127.9	40.37	142.5	46.42	
48	64.1	17.87	76.5	21.61	88.7	25.85	94.9	27.97	100.9	30.06	113.1	35.27	126.0	40.56	

Note

1. TC: Total Capacity(kW), PI : Power Input(kW, Comp. + Outdoor fan motor)
2. Capacity tables show the average value of conditions which may occur.

7. Capacity Tables

◆ A(C)RUN880LLS5

Combination (%)	Outdoor air temp (°C DB)	Indoor air temp. (DB/WB, °C)														Cooling Capacity(88HP)	
		20		23		26		27		28		30		32		TC	PI
		14		16		18		19		20		22		24			
		TC	PI	TC	PI	TC	PI	TC	PI	TC	PI	TC	PI	TC	PI		
130	10	244.1	29.14	290.7	35.61	311.5	41.32	320.5	42.15	329.3	42.51	345.3	42.84	354.1	43.00		
	12	244.1	29.86	290.7	36.89	311.5	43.01	320.5	43.30	329.3	43.63	345.3	43.99	354.1	44.39		
	14	244.1	30.88	290.7	38.22	311.5	44.62	320.5	44.95	329.3	45.32	345.3	45.68	354.1	46.08		
	16	244.1	32.00	290.7	39.56	311.5	46.63	320.5	47.07	329.3	47.44	345.3	47.86	354.1	48.25		
	18	244.1	33.33	290.7	41.85	311.5	48.78	320.5	49.83	329.3	50.24	345.3	50.73	354.1	51.07		
	20	244.1	34.81	290.7	44.59	311.5	51.19	320.5	54.80	329.3	55.26	340.2	55.79	349.2	56.18		
	21	244.1	35.71	290.7	46.15	311.5	52.25	320.5	58.00	329.3	58.46	338.4	59.05	347.3	59.45		
	23	244.1	38.32	290.7	48.55	311.5	54.96	320.5	64.00	325.2	64.51	333.4	65.16	342.2	65.60		
	25	244.1	40.92	290.7	51.33	311.5	58.73	316.6	70.98	320.5	71.54	329.3	72.26	338.4	72.76		
	27	244.1	43.79	290.7	54.89	307.6	62.59	311.5	78.14	316.6	78.77	325.2	79.53	333.4	80.10		
	29	244.1	46.67	290.7	58.66	302.6	67.34	307.0	85.88	311.5	86.40	320.5	87.16	329.3	87.50		
	31	244.1	49.80	289.7	61.80	297.6	71.64	302.6	85.51	307.0	86.04	315.4	86.79	324.3	87.14		
	33	244.1	53.05	284.6	65.49	293.7	76.82	298.5	84.73	302.6	85.24	311.5	86.00	319.4	86.34		
	35	244.1	56.58	279.6	68.57	288.7	83.20	293.7	83.63	298.5	84.13	306.6	84.89	315.4	85.22		
	37	244.1	60.34	275.8	71.96	284.6	82.11	288.7	82.53	293.7	83.03	301.6	83.76	310.6	84.09		
	39	244.1	64.24	270.8	75.74	279.6	81.02	284.6	81.42	288.7	81.91	297.6	82.64	306.6	82.97		
	41	237.9	68.15	259.6	79.53	268.4	79.92	272.4	80.32	277.8	80.80	286.0	81.52	293.8	81.84		
	43	231.9	71.87	248.8	78.41	257.5	78.81	261.3	79.20	266.7	79.69	274.8	80.40	282.3	80.72		
	46	217.3	76.93	227.0	76.79	235.2	77.16	238.9	77.56	243.8	78.02	251.5	78.71	258.5	79.04		
	48	192.2	74.78	197.1	75.01	204.5	75.18	207.8	75.38	212.2	76.03	219.0	76.52	225.1	76.82		
120	10	220.7	26.23	262.6	32.14	287.0	38.21	295.7	41.29	304.3	41.94	320.9	42.10	328.7	42.44		
	12	220.7	26.92	262.6	33.23	287.0	39.74	295.7	42.15	304.3	43.49	320.9	44.02	328.7	44.36		
	14	220.7	27.85	262.6	34.35	287.0	41.35	295.7	43.76	304.3	45.08	320.9	45.75	328.7	46.11		
	16	220.7	28.86	262.6	35.76	287.0	42.94	295.7	45.38	304.3	47.17	320.9	47.76	328.7	48.12		
	18	220.7	29.98	262.6	37.38	287.0	44.66	295.7	47.79	304.3	49.58	320.9	50.15	328.7	50.56		
	20	220.7	31.12	262.6	39.63	287.0	47.07	295.7	50.27	304.3	52.21	320.9	52.90	328.7	53.32		
	21	220.7	32.07	262.6	41.06	287.0	48.39	295.7	51.76	304.3	53.94	320.9	54.63	328.7	55.05		
	23	220.7	34.28	262.6	43.93	287.0	51.83	295.7	55.00	304.3	57.50	320.9	58.07	328.7	58.53		
	25	220.7	36.63	262.6	47.07	287.0	54.66	295.7	58.63	304.3	61.66	317.1	62.16	324.9	62.66		
	27	220.7	39.11	262.6	50.31	287.0	58.19	295.7	62.65	304.3	66.25	312.4	66.71	320.1	67.24		
	29	220.7	41.71	262.6	53.71	287.0	61.23	295.7	67.04	299.5	70.62	307.3	71.68	316.1	72.26		
	31	220.7	44.46	262.6	57.37	287.0	64.40	291.8	71.81	295.7	75.76	303.6	77.09	311.1	77.72		
	33	220.7	47.33	262.6	61.14	283.0	68.11	287.0	77.95	290.8	81.35	298.5	82.27	306.4	82.93		
	35	220.7	50.31	262.6	65.17	278.2	72.10	282.0	85.88	287.0	86.30	294.8	86.56	302.5	87.25		
	37	220.7	54.13	262.6	68.77	274.2	76.86	278.2	84.06	282.0	84.49	289.8	84.75	297.8	85.42		
	39	220.7	58.27	261.7	72.70	269.4	81.52	273.4	82.34	277.2	82.76	286.0	83.00	293.8	83.66		
	41	215.2	62.42	250.1	76.59	258.6	79.92	262.3	80.62	266.1	81.02	273.8	81.26	281.6	81.91		
	43	209.8	66.62	239.7	75.50	248.1	78.14	251.5	78.88	255.2	79.27	262.9	79.53	270.5	80.15		
	46	196.6	71.64	218.6	73.72	226.5	75.67	229.8	76.29	233.4	76.68	240.4	76.91	247.5	77.52		
	48	174.0	70.16	189.9	72.40	196.9	74.21	200.0	74.65	203.0	74.88	209.2	75.18	215.6	75.50		
110	10	197.8	23.59	235.9	28.73	263.4	34.14	271.1	36.96	288.1	39.77	294.8	40.89	314.7	41.55		
	12	197.8	24.31	235.9	29.72	263.4	35.57	271.1	37.99	288.1	41.26	294.8	42.60	314.7	43.58		
	14	197.8	25.07	235.9	31.05	263.4	37.17	271.1	39.87	288.1	43.34	294.8	44.58	314.7	45.52		
	16	197.8	25.96	235.9	32.18	263.4	38.70	271.1	41.62	288.1	45.34	294.8	46.57	314.7	47.40		
	18	197.8	26.92	235.9	33.52	263.4	40.92	271.1	43.83	288.1	47.83	294.8	48.78	314.7	49.68		
	20	197.8	27.88	235.9	35.20	263.4	43.40	271.1	45.84	288.1	50.15	294.8	51.39	314.7	52.21		
	21	197.8	28.50	235.9	36.23	263.4	44.53	271.1	47.07	288.1	51.56	294.8	52.85	314.7	53.67		
	23	197.8	30.38	235.9	38.84	263.4	47.00	271.1	49.71	288.1	54.47	294.8	55.63	314.7	56.55		
	25	197.8	32.47	235.9	41.45	263.4	49.67	271.1	52.55	288.1	57.53	294.8	58.36	311.0	59.56		
	27	197.8	34.68	235.9	44.32	263.4	52.48	271.1	55.61	288.1	60.08	294.8	61.46	306.3	62.52		
	29	197.8	37.03	235.9	47.33	263.4	55.45	271.1	58.89	288.1	63.51	294.8	64.60	302.5	65.57		
	31	197.8	39.37	235.9	50.45	263.4	58.60	271.1	62.39	283.4	66.72	291.1	68.03	297.8	68.74		
	33	197.8	41.98	235.9	53.71	263.4	61.92	271.1	66.13	279.5	70.46	286.3	71.64	293.8	72.03		
	35	197.8	44.59	235.9	57.37	263.4	65.39	271.1	70.06	274.9	74.37	281.6	75.04	289.1	75.43		
	37	197.8	47.26	235.9	60.88	263.4	69.03	267.3	74.22	270.1	78.44	277.8	78.71	284.4	78.94		
	39	197.8	50.94	235.9	64.70	258.6	72.84	262.4	79.40	266.3	82.31	272.8	82.47	280.6	82.54		
	41	192.9	54.63	229.8	68.50	247.7	76.82	251.5	85.88	254.8	85.88	262.3	86.56	268.7	87.25		
	43	187.9	57.37	224.1	71.38	237.3	81.45	241.3	82.37	244.3	82.21	251.5	82.67	257.9	82.90		
	46	176.2	55.98	210.1	68.90	216.5	77.31	220.3	77.31	223.1	77.98	229.9	78.41	235.9	78.61		
	48	155.8	54.37	182.5	66.38	188.1	73.56	191.5	74.05	194.0	74.41	200.0	74.62	205.2	74.91		

Note

- 1. TC: Total Capacity(kW), PI : Power Input(kW, Comp. + Outdoor fan motor)
- 2. Capacity tables show the average value of conditions which may occur.

7. Capacity Tables

Combination (%)	Outdoor air temp (°C DB)	Cooling Capacity(88HP)													
		Indoor air temp. (DB/WB, °C)													
		20		23		26		27		28		30		32	
		14	16	18	19	20	22	24							
	TC	PI	TC	PI	TC	PI	TC	PI	TC	PI	TC	PI	TC	PI	
100	10	166.3	21.24	198.0	25.80	230.5	30.62	246.4	33.10	262.3	35.55	290.7	39.57	297.1	39.90
	12	166.3	21.93	198.0	26.86	230.5	31.65	246.4	33.98	262.3	36.69	290.7	41.71	297.1	42.12
	14	166.3	22.60	198.0	27.94	230.5	32.99	246.4	35.44	262.3	38.28	290.7	44.03	297.1	44.46
	16	166.3	23.29	198.0	28.87	230.5	34.39	246.4	37.13	262.3	40.32	290.7	46.17	297.1	46.80
	18	166.3	23.98	198.0	29.93	230.5	35.74	246.4	38.94	262.3	42.77	290.7	48.78	297.1	49.15
	20	166.3	24.84	198.0	31.07	230.5	37.82	246.4	41.71	262.3	45.75	290.7	51.10	297.1	51.52
	21	166.3	25.36	198.0	31.81	230.5	39.11	246.4	43.14	262.3	47.46	290.7	52.28	297.1	52.69
	23	166.3	26.85	198.0	34.02	230.5	41.98	246.4	46.28	262.3	50.84	290.7	54.73	297.1	55.19
	25	166.3	28.54	198.0	36.23	230.5	44.85	246.4	49.54	262.3	54.36	290.7	57.07	294.6	57.53
	27	166.3	30.51	198.0	38.72	230.5	47.96	246.4	52.92	262.3	57.80	285.1	59.75	291.1	60.24
	29	166.3	32.47	198.0	41.32	230.5	51.23	246.4	56.58	262.3	61.17	279.9	62.16	286.7	62.66
	31	166.3	34.68	198.0	44.06	230.5	54.63	246.4	60.35	262.3	64.28	275.6	64.57	282.3	65.09
	33	166.3	36.76	198.0	46.93	230.5	58.27	246.4	64.40	262.3	66.69	271.2	66.98	277.9	67.52
	35	166.3	39.11	198.0	49.94	230.5	62.06	246.4	68.70	258.2	69.10	266.3	69.39	273.1	69.93
	37	166.3	41.89	198.0	53.55	230.5	65.73	246.4	71.97	253.9	72.33	261.3	72.63	267.5	73.29
	39	166.3	44.92	198.0	57.53	230.5	69.65	246.4	75.50	249.8	75.83	257.2	76.10	263.1	76.82
	41	163.7	47.93	194.9	61.50	226.8	73.58	236.5	79.01	241.6	79.33	247.3	79.60	255.2	80.35
	43	158.1	50.73	188.2	65.20	219.1	77.09	226.7	82.04	229.2	82.31	236.3	82.60	242.7	83.37
46	148.2	54.56	176.3	70.29	205.4	81.77	207.0	85.88	209.2	86.14	215.9	86.37	221.7	87.20	
48	131.0	47.10	156.0	60.81	177.3	69.90	179.8	72.86	181.8	73.10	187.8	73.26	192.9	73.85	
90	10	149.6	18.42	178.7	22.13	207.7	26.09	221.7	28.13	235.9	30.28	264.9	33.88	293.9	37.67
	12	149.6	18.63	178.7	22.48	207.7	26.55	221.7	28.69	235.9	30.94	264.9	34.54	293.9	38.34
	14	149.6	18.98	178.7	22.92	207.7	27.11	221.7	29.26	235.9	31.51	264.9	35.22	293.9	39.13
	16	149.6	19.32	178.7	23.38	207.7	27.67	221.7	29.82	235.9	32.09	264.9	35.89	293.9	39.79
	18	149.6	19.65	178.7	23.84	207.7	28.13	221.7	30.51	235.9	32.76	264.9	36.68	293.9	41.80
	20	149.6	19.98	178.7	24.28	207.7	28.69	221.7	31.07	235.9	34.01	264.9	39.25	293.9	43.79
	21	149.6	20.21	178.7	24.51	207.7	29.26	221.7	32.09	235.9	35.24	264.9	39.89	293.9	44.80
	23	149.6	20.67	178.7	25.53	207.7	31.30	221.7	34.44	235.9	37.74	264.9	42.30	289.8	46.91
	25	149.6	21.69	178.7	27.21	207.7	33.44	221.7	36.82	235.9	40.32	264.9	45.23	285.7	48.91
	27	149.6	23.15	178.7	29.03	207.7	35.69	221.7	39.30	235.9	43.15	264.9	48.08	281.6	51.21
	29	149.6	24.51	178.7	30.94	207.7	38.17	221.7	42.03	235.9	46.09	264.9	50.95	277.2	53.26
	31	149.6	26.09	178.7	32.99	207.7	40.67	221.7	44.74	235.9	49.14	264.9	53.48	273.1	55.33
	33	149.6	27.80	178.7	35.13	207.7	43.38	221.7	47.68	235.9	52.11	264.9	56.07	269.0	57.39
	35	149.6	29.49	178.7	37.28	207.7	46.09	221.7	50.82	235.9	55.26	260.3	59.27	264.7	60.65
	37	149.6	31.30	178.7	39.65	207.7	49.14	221.7	53.99	235.9	58.34	256.2	61.97	260.6	63.36
	39	149.6	33.12	178.7	42.17	207.7	52.01	221.7	57.46	235.9	61.35	251.9	65.34	256.3	66.13
	41	145.9	37.07	174.0	46.75	202.4	57.09	216.0	62.83	229.8	66.23	241.3	68.84	245.7	70.43
	43	142.2	40.01	169.8	50.51	197.3	62.35	210.8	67.68	224.1	71.01	231.5	73.73	235.6	74.62
46	133.3	45.04	159.1	57.53	184.8	71.05	197.6	76.73	203.7	78.89	211.2	80.93	215.3	81.05	
48	117.8	39.36	140.8	50.32	163.5	62.14	174.6	66.93	176.7	67.98	183.7	69.67	187.1	69.76	
80	10	132.9	15.42	158.4	18.54	183.9	21.75	197.1	23.47	210.3	25.17	235.9	28.72	261.3	31.17
	12	132.9	15.75	158.4	18.73	183.9	22.18	197.1	23.88	210.3	25.60	235.9	29.25	261.3	31.79
	14	132.9	15.96	158.4	19.17	183.9	22.49	197.1	24.31	210.3	26.03	235.9	29.78	261.3	32.39
	16	132.9	16.18	158.4	19.49	183.9	22.92	197.1	24.74	210.3	26.56	235.9	30.43	261.3	33.03
	18	132.9	16.51	158.4	19.83	183.9	23.35	197.1	25.17	210.3	27.09	235.9	30.96	261.3	33.75
	20	132.9	16.82	158.4	20.25	183.9	23.88	197.1	25.70	210.3	27.64	235.9	32.13	261.3	35.75
	21	132.9	16.91	158.4	20.46	183.9	24.10	197.1	26.03	210.3	28.28	235.9	33.15	261.3	36.70
	23	132.9	17.25	158.4	20.78	183.9	25.17	197.1	27.64	210.3	30.20	235.9	35.01	261.3	38.52
	25	132.9	17.90	158.4	22.18	183.9	26.99	197.1	29.57	210.3	32.36	235.9	37.46	261.3	41.18
	27	132.9	18.96	158.4	23.57	183.9	28.82	197.1	31.60	210.3	34.49	235.9	39.80	261.3	43.33
	29	132.9	20.13	158.4	25.17	183.9	30.64	197.1	33.65	210.3	36.84	235.9	42.64	261.3	46.39
	31	132.9	21.42	158.4	26.67	183.9	32.67	197.1	35.88	210.3	39.22	235.9	45.26	261.3	48.70
	33	132.9	22.71	158.4	28.49	183.9	34.81	197.1	38.24	210.3	41.78	235.9	47.68	261.3	51.06
	35	132.9	24.10	158.4	30.20	183.9	37.07	197.1	40.72	210.3	44.57	235.9	50.56	258.6	52.91
	37	132.9	25.50	158.4	32.13	183.9	39.32	197.1	43.28	210.3	47.35	235.9	53.35	254.5	55.31
	39	132.9	26.95	158.4	33.95	183.9	42.05	197.1	46.53	210.3	50.89	235.9	56.37	250.1	58.35
	41	129.6	29.81	154.3	37.63	179.1	46.16	192.0	51.00	204.8	55.91	229.8	62.74	239.7	64.66
	43	126.2	32.82	150.6	41.05	174.7	50.40	187.2	55.58	200.0	61.11	224.1	67.14	229.8	69.24
46	118.4	36.51	141.1	46.25	163.8	56.76	175.6	61.87	187.2	68.94	205.0	73.28	209.8	74.47	
48	104.7	31.90	124.8	40.45	144.9	49.64	155.4	54.04	165.8	60.35	178.0	63.43	182.4	64.10	

Note

1. TC: Total Capacity(kW), PI : Power Input(kW, Comp. + Outdoor fan motor)
2. Capacity tables show the average value of conditions which may occur.

7. Capacity Tables

Combination (%)	Outdoor air temp (°C DB)	Cooling Capacity(88HP)													
		Indoor air temp. (DB/WB, °C)													
		20		23		26		27		28		30		32	
		14	16	18	19	20	22	24							
	TC	PI	TC	PI	TC	PI	TC	PI	TC	PI	TC	PI	TC	PI	
70	10	116.1	13.55	139.1	16.12	161.1	18.68	172.5	20.17	183.9	21.55	205.9	24.54	228.8	27.44
	12	116.1	13.76	139.1	16.32	161.1	19.08	172.5	20.48	183.9	21.98	205.9	24.97	228.8	27.96
	14	116.1	13.99	139.1	16.54	161.1	19.42	172.5	20.81	183.9	22.30	205.9	25.51	228.8	28.47
	16	116.1	14.18	139.1	16.85	161.1	19.74	172.5	21.24	183.9	22.72	205.9	25.94	228.8	29.08
	18	116.1	14.41	139.1	17.18	161.1	20.17	172.5	21.65	183.9	23.15	205.9	26.34	228.8	29.61
	20	116.1	14.61	139.1	17.49	161.1	20.48	172.5	22.08	183.9	23.68	205.9	27.00	228.8	30.73
	21	116.1	14.82	139.1	17.61	161.1	20.70	172.5	22.30	183.9	23.91	205.9	27.41	228.8	31.37
	23	116.1	15.05	139.1	18.02	161.1	21.12	172.5	23.04	183.9	25.07	205.9	29.34	228.8	33.13
	25	116.1	15.25	139.1	18.68	161.1	22.51	172.5	24.64	183.9	26.77	205.9	31.37	228.8	34.74
	27	116.1	16.12	139.1	19.95	161.1	24.00	172.5	26.14	183.9	28.60	205.9	33.50	228.8	36.92
	29	116.1	17.18	139.1	21.12	161.1	25.51	172.5	27.84	183.9	30.41	205.9	35.73	228.8	39.55
	31	116.1	18.25	139.1	22.51	161.1	27.21	172.5	29.77	183.9	32.43	205.9	38.09	228.8	41.96
	33	116.1	19.31	139.1	23.78	161.1	28.90	172.5	31.58	183.9	34.46	205.9	40.53	228.8	44.68
	35	116.1	20.38	139.1	25.40	161.1	30.73	172.5	33.60	183.9	36.69	205.9	43.22	228.8	47.38
	37	116.1	21.65	139.1	26.90	161.1	32.64	172.5	35.73	183.9	39.05	205.9	45.98	228.8	49.99
	39	116.1	23.01	139.1	28.67	161.1	34.90	172.5	38.45	183.9	42.18	205.9	49.21	228.8	53.91
	41	113.1	25.44	135.4	31.40	157.0	38.29	168.1	42.18	179.1	45.85	200.7	54.05	223.0	58.15
	43	110.4	27.67	132.0	34.24	153.0	41.79	163.9	45.99	174.7	50.08	195.7	59.04	217.3	62.87
46	103.5	30.76	123.9	38.50	143.5	47.06	153.6	51.22	163.8	56.45	183.4	66.60	203.8	70.07	
48	91.5	26.84	109.6	33.64	126.9	41.13	135.8	44.76	144.9	49.38	162.1	58.28	180.4	60.64	
60	10	99.5	11.68	118.8	13.71	138.1	15.94	147.9	17.10	157.5	18.17	176.9	20.61	196.3	23.05
	12	99.5	11.90	118.8	13.91	138.1	16.15	147.9	17.32	157.5	18.49	176.9	20.93	196.3	23.48
	14	99.5	12.00	118.8	14.14	138.1	16.46	147.9	17.63	157.5	18.80	176.9	21.36	196.3	23.91
	16	99.5	12.21	118.8	14.45	138.1	16.69	147.9	17.96	157.5	19.23	176.9	21.77	196.3	24.32
	18	99.5	12.43	118.8	14.66	138.1	16.99	147.9	18.26	157.5	19.56	176.9	22.10	196.3	24.86
	20	99.5	12.64	118.8	14.88	138.1	17.32	147.9	18.60	157.5	19.87	176.9	22.52	196.3	25.39
	21	99.5	12.75	118.8	14.98	138.1	17.53	147.9	18.80	157.5	20.08	176.9	22.84	196.3	25.61
	23	99.5	12.97	118.8	15.29	138.1	17.75	147.9	19.13	157.5	20.51	176.9	23.68	196.3	27.19
	25	99.5	13.18	118.8	15.62	138.1	18.49	147.9	20.08	157.5	21.77	176.9	25.29	196.3	29.10
	27	99.5	13.61	118.8	16.46	138.1	19.67	147.9	21.36	157.5	23.17	176.9	26.89	196.3	31.03
	29	99.5	14.45	118.8	17.53	138.1	20.93	147.9	22.74	157.5	24.65	176.9	28.69	196.3	33.15
	31	99.5	15.29	118.8	18.60	138.1	22.20	147.9	24.22	157.5	26.25	176.9	30.60	196.3	35.28
	33	99.5	16.15	118.8	19.67	138.1	23.58	147.9	25.72	157.5	27.93	176.9	32.51	196.3	37.62
	35	99.5	17.10	118.8	20.93	138.1	25.08	147.9	27.30	157.5	29.64	176.9	34.65	196.3	39.94
	37	99.5	18.06	118.8	22.08	138.1	26.55	147.9	29.00	157.5	31.44	176.9	36.75	196.3	42.50
	39	99.5	19.20	118.8	23.52	138.1	28.66	147.9	31.11	157.5	33.85	176.9	39.43	196.3	45.55
	41	96.8	20.83	115.8	25.75	134.7	31.14	144.1	33.99	153.4	36.73	172.3	43.25	191.3	49.49
	43	94.5	22.64	113.0	28.02	131.3	33.94	140.5	37.05	149.6	40.07	168.1	47.22	186.5	54.05
46	88.7	25.36	105.9	31.47	123.2	38.16	131.7	41.64	140.2	45.08	157.5	53.21	174.7	61.58	
48	78.3	22.10	93.7	27.46	108.9	33.35	116.5	36.36	124.1	39.39	139.4	46.53	154.7	53.88	
50	10	83.2	10.05	99.5	11.63	115.3	13.24	123.2	14.17	131.1	15.02	146.9	16.93	163.7	18.84
	12	83.2	10.15	99.5	11.75	115.3	13.44	123.2	14.38	131.1	15.35	146.9	17.24	163.7	19.15
	14	83.2	10.27	99.5	11.95	115.3	13.65	123.2	14.60	131.1	15.55	146.9	17.47	163.7	19.48
	16	83.2	10.48	99.5	12.16	115.3	13.87	123.2	14.92	131.1	15.76	146.9	17.77	163.7	19.78
	18	83.2	10.58	99.5	12.27	115.3	14.08	123.2	15.12	131.1	16.09	146.9	18.10	163.7	20.21
	20	83.2	10.68	99.5	12.49	115.3	14.38	123.2	15.35	131.1	16.39	146.9	18.41	163.7	20.62
	21	83.2	10.79	99.5	12.59	115.3	14.51	123.2	15.55	131.1	16.50	146.9	18.61	163.7	20.83
	23	83.2	11.02	99.5	12.80	115.3	14.71	123.2	15.76	131.1	16.82	146.9	18.94	163.7	21.26
	25	83.2	11.11	99.5	13.01	115.3	15.02	123.2	16.09	131.1	17.36	146.9	19.89	163.7	22.75
	27	83.2	11.32	99.5	13.44	115.3	15.86	123.2	17.13	131.1	18.41	146.9	21.26	163.7	24.22
	29	83.2	11.95	99.5	14.28	115.3	16.82	123.2	18.20	131.1	19.58	146.9	22.54	163.7	25.71
	31	83.2	12.59	99.5	15.12	115.3	17.88	123.2	19.26	131.1	20.83	146.9	24.02	163.7	27.41
	33	83.2	13.33	99.5	15.98	115.3	18.94	123.2	20.42	131.1	22.11	146.9	25.49	163.7	29.20
	35	83.2	14.08	99.5	16.93	115.3	19.99	123.2	21.70	131.1	23.38	146.9	26.98	163.7	31.01
	37	83.2	14.92	99.5	17.88	115.3	21.16	123.2	22.95	131.1	24.76	146.9	28.79	163.7	32.91
	39	83.2	15.92	99.5	19.17	115.3	22.68	123.2	24.72	131.1	26.57	146.9	30.66	163.7	35.54
	41	80.9	17.20	96.8	20.75	112.3	24.79	120.1	26.77	127.6	28.79	143.2	33.59	159.4	38.59
	43	79.0	18.71	94.5	22.57	109.6	26.98	117.1	29.15	124.6	31.34	139.7	36.64	155.6	42.10
46	74.1	20.96	88.7	25.32	102.6	30.26	109.7	32.73	116.7	35.17	130.9	41.22	145.9	47.40	
48	65.6	18.24	78.3	22.07	90.8	26.40	97.1	28.56	103.3	30.70	115.8	36.01	129.0	41.42	

Note

1. TC: Total Capacity(kW), PI : Power Input(kW, Comp. + Outdoor fan motor)
2. Capacity tables show the average value of conditions which may occur.

7. Capacity Tables

◆ A(C)RUN900LLS5

Combination (%)	Outdoor air temp (°C DB)	Indoor air temp. (DB/WB, °C)												Cooling Capacity(90HP)	
		20		23		26		27		28		30		32	
		14		16		18		19		20		22		24	
		TC	PI	TC	PI	TC	PI	TC	PI	TC	PI	TC	PI	TC	PI
130	10	249.6	30.24	297.3	36.95	318.5	42.88	327.8	43.74	336.8	44.12	353.1	44.46	362.1	44.63
	12	249.6	30.99	297.3	38.29	318.5	44.63	327.8	44.94	336.8	45.28	353.1	45.66	362.1	46.07
	14	249.6	32.05	297.3	39.66	318.5	46.31	327.8	46.65	336.8	47.03	353.1	47.41	362.1	47.82
	16	249.6	33.21	297.3	41.06	318.5	48.40	327.8	48.85	336.8	49.23	353.1	49.67	362.1	50.08
	18	249.6	34.59	297.3	43.43	318.5	50.63	327.8	51.72	336.8	52.14	353.1	52.65	362.1	53.00
	20	249.6	36.13	297.3	46.28	318.5	53.13	327.8	56.87	336.8	57.35	347.9	57.90	357.2	58.31
	21	249.6	37.06	297.3	47.89	318.5	54.23	327.8	60.19	336.8	60.67	346.1	61.29	355.2	61.70
	23	249.6	39.77	297.3	50.39	318.5	57.04	327.8	66.43	332.6	66.95	341.0	67.63	350.0	68.08
	25	249.6	42.47	297.3	53.27	318.5	60.95	323.7	73.67	327.8	74.25	336.8	75.00	346.1	75.52
	27	249.6	45.45	297.3	56.97	314.6	64.96	318.5	81.10	323.7	81.75	332.6	82.54	341.0	83.13
	29	249.6	48.44	297.3	60.88	309.5	69.89	314.0	89.13	318.5	89.67	327.8	90.46	336.8	90.81
	31	249.6	51.69	296.3	64.14	304.3	74.35	309.5	88.75	314.0	89.30	322.6	90.08	331.6	90.43
	33	249.6	55.05	291.1	67.97	300.4	79.73	305.3	87.93	309.5	88.47	318.5	89.26	326.7	89.61
	35	249.6	58.72	285.9	71.16	295.3	86.35	300.4	86.79	305.3	87.31	313.6	88.10	322.6	88.44
	37	249.6	62.63	282.1	74.69	291.1	85.22	295.3	85.66	300.4	86.18	308.4	86.93	317.7	87.27
	39	249.6	66.67	276.9	78.60	285.9	84.09	291.1	84.50	295.3	85.01	304.3	85.77	313.6	86.11
	41	243.3	70.72	265.5	82.54	274.5	82.95	278.6	83.36	284.2	83.85	292.5	84.60	300.5	84.94
	43	237.1	74.59	254.4	81.38	263.4	81.79	267.2	82.20	272.8	82.71	281.1	83.44	288.7	83.78
46	222.2	79.84	232.2	79.70	240.6	80.08	244.4	80.49	249.3	80.97	257.2	81.69	264.4	82.03	
48	196.6	77.61	201.5	77.85	209.1	78.02	212.5	78.23	217.0	78.91	224.0	79.42	230.2	79.73	
120	10	225.7	27.22	268.6	33.35	293.5	39.66	302.5	42.85	311.2	43.53	328.2	43.70	336.1	44.05
	12	225.7	27.94	268.6	34.49	293.5	41.24	302.5	43.74	311.2	45.14	328.2	45.69	336.1	46.04
	14	225.7	28.90	268.6	35.65	293.5	42.92	302.5	45.42	311.2	46.79	328.2	47.48	336.1	47.85
	16	225.7	29.96	268.6	37.12	293.5	44.56	302.5	47.10	311.2	48.95	328.2	49.57	336.1	49.94
	18	225.7	31.12	268.6	38.80	293.5	46.35	302.5	49.60	311.2	51.45	328.2	52.04	336.1	52.48
	20	225.7	32.29	268.6	41.13	293.5	48.85	302.5	52.17	311.2	54.19	328.2	54.91	336.1	55.33
	21	225.7	33.28	268.6	42.61	293.5	50.22	302.5	53.72	311.2	55.98	328.2	56.70	336.1	57.14
	23	225.7	35.58	268.6	45.59	293.5	53.79	302.5	57.08	311.2	59.68	328.2	60.26	336.1	60.74
	25	225.7	38.02	268.6	48.85	293.5	56.73	302.5	60.85	311.2	64.00	324.3	64.51	332.3	65.03
	27	225.7	40.59	268.6	52.21	293.5	60.40	302.5	65.03	311.2	68.76	319.5	69.24	327.4	69.79
	29	225.7	43.29	268.6	55.74	293.5	63.55	302.5	69.58	306.3	73.29	314.3	74.39	323.3	75.00
	31	225.7	46.14	268.6	59.54	293.5	66.84	298.4	74.52	302.5	78.63	310.5	80.01	318.1	80.66
	33	225.7	49.12	268.6	63.45	289.4	70.68	293.5	80.90	297.4	84.43	305.3	85.39	313.3	86.07
	35	225.7	52.21	268.6	67.63	284.5	74.83	288.4	89.13	293.5	89.57	301.5	89.84	309.4	90.56
	37	225.7	56.18	268.6	71.37	280.4	79.77	284.5	87.24	288.4	87.69	296.3	87.96	304.6	88.65
	39	225.7	60.47	267.6	75.45	275.5	84.60	279.7	85.46	283.5	85.90	292.5	86.14	300.5	86.83
	41	220.1	64.79	255.8	79.49	264.5	82.95	268.3	83.67	272.1	84.09	280.0	84.33	288.0	85.01
	43	214.6	69.14	245.1	78.36	253.7	81.10	257.2	81.86	261.0	82.27	268.9	82.54	276.6	83.19
46	201.1	74.35	223.6	76.51	231.6	78.53	235.0	79.18	238.8	79.59	245.8	79.83	253.1	80.45	
48	177.9	72.81	194.2	75.14	201.4	77.02	204.6	77.47	207.7	77.71	213.9	78.02	220.5	78.36	
110	10	202.2	24.48	241.3	29.82	269.3	35.44	277.3	38.36	294.6	41.27	301.5	42.44	321.9	43.12
	12	202.2	25.23	241.3	30.85	269.3	36.92	277.3	39.42	294.6	42.82	301.5	44.22	321.9	45.22
	14	202.2	26.02	241.3	32.22	269.3	38.57	277.3	41.38	294.6	44.98	301.5	46.27	321.9	47.24
	16	202.2	26.94	241.3	33.39	269.3	40.17	277.3	43.19	294.6	47.06	301.5	48.33	321.9	49.19
	18	202.2	27.94	241.3	34.79	269.3	42.47	277.3	45.49	294.6	49.64	301.5	50.63	321.9	51.56
	20	202.2	28.93	241.3	36.54	269.3	45.04	277.3	47.58	294.6	52.04	301.5	53.34	321.9	54.19
	21	202.2	29.58	241.3	37.60	269.3	46.21	277.3	48.85	294.6	53.51	301.5	54.85	321.9	55.70
	23	202.2	31.53	241.3	40.31	269.3	48.78	277.3	51.59	294.6	56.53	301.5	57.73	321.9	58.69
	25	202.2	33.70	241.3	43.02	269.3	51.55	277.3	54.54	294.6	59.71	301.5	60.57	318.1	61.81
	27	202.2	35.99	241.3	46.00	269.3	54.47	277.3	57.72	294.6	62.35	301.5	63.79	313.3	64.89
	29	202.2	38.43	241.3	49.12	269.3	57.55	277.3	61.12	294.6	65.92	301.5	67.05	309.4	68.05
	31	202.2	40.86	241.3	52.35	269.3	60.81	277.3	64.75	289.8	69.24	297.7	70.61	304.6	71.34
	33	202.2	43.57	241.3	55.74	269.3	64.27	277.3	68.63	285.9	73.12	292.8	74.35	300.5	74.76
	35	202.2	46.28	241.3	59.54	269.3	67.87	277.3	72.71	281.1	77.19	288.0	77.88	295.6	78.29
	37	202.2	49.05	241.3	63.18	269.3	71.64	273.4	77.03	276.2	81.41	284.2	81.69	290.8	81.93
	39	202.2	52.86	241.3	67.15	264.5	75.59	268.3	82.41	272.4	85.42	279.0	85.59	287.0	85.66
	41	197.3	56.70	235.0	71.09	253.4	79.73	257.2	89.13	260.6	89.13	268.3	89.84	274.8	90.56
	43	192.1	59.54	229.2	74.08	242.7	84.53	246.8	85.49	249.9	85.32	257.2	85.80	263.8	86.04
46	180.3	58.10	214.9	71.51	221.5	80.24	225.3	80.24	228.1	80.93	235.1	81.38	241.3	81.58	
48	159.3	56.42	186.6	68.90	192.4	76.34	195.9	76.85	198.4	77.23	204.6	77.44	209.8	77.74	

Note

1. TC: Total Capacity(kW), PI : Power Input(kW, Comp. + Outdoor fan motor)
2. Capacity tables show the average value of conditions which may occur.

7. Capacity Tables

Combination (%)	Outdoor air temp (°C DB)	Cooling Capacity(90HP)													
		Indoor air temp. (DB/WB, °C)													
		20		23		26		27		28		30		32	
		14	16	18	19	20	22	24	TC	PI	TC	PI	TC	PI	
100	10	170.0	22.04	202.5	26.77	235.7	31.78	252.0	34.35	268.3	36.89	297.3	41.07	303.9	41.41
	12	170.0	22.76	202.5	27.87	235.7	32.84	252.0	35.27	268.3	38.08	297.3	43.29	303.9	43.71
	14	170.0	23.45	202.5	29.00	235.7	34.24	252.0	36.78	268.3	39.73	297.3	45.69	303.9	46.14
	16	170.0	24.17	202.5	29.96	235.7	35.69	252.0	38.53	268.3	41.85	297.3	47.92	303.9	48.57
	18	170.0	24.89	202.5	31.06	235.7	37.09	252.0	40.41	268.3	44.39	297.3	50.63	303.9	51.01
	20	170.0	25.78	202.5	32.25	235.7	39.25	252.0	43.29	268.3	47.48	297.3	53.03	303.9	53.47
	21	170.0	26.32	202.5	33.01	235.7	40.59	252.0	44.77	268.3	49.26	297.3	54.26	303.9	54.68
	23	170.0	27.87	202.5	35.31	235.7	43.57	252.0	48.03	268.3	52.76	297.3	56.80	303.9	57.28
	25	170.0	29.62	202.5	37.60	235.7	46.55	252.0	51.42	268.3	56.42	297.3	59.23	301.2	59.71
	27	170.0	31.67	202.5	40.18	235.7	49.77	252.0	54.92	268.3	59.99	291.5	62.01	297.7	62.52
	29	170.0	33.70	202.5	42.88	235.7	53.17	252.0	58.72	268.3	63.48	286.3	64.51	293.2	65.03
	31	170.0	35.99	202.5	45.73	235.7	56.70	252.0	62.63	268.3	66.71	281.8	67.01	288.7	67.56
	33	170.0	38.15	202.5	48.71	235.7	60.47	252.0	66.84	268.3	69.21	277.3	69.52	284.2	70.07
	35	170.0	40.59	202.5	51.83	235.7	64.41	252.0	71.30	264.1	71.71	272.4	72.02	279.3	72.57
	37	170.0	43.47	202.5	55.57	235.7	68.22	252.0	74.69	259.6	75.07	267.2	75.38	273.5	76.06
	39	170.0	46.62	202.5	59.71	235.7	72.29	252.0	78.36	255.5	78.70	263.1	78.98	269.0	79.73
	41	167.5	49.74	199.4	63.83	231.9	76.37	241.9	82.00	247.1	82.34	253.0	82.61	261.0	83.40
	43	161.7	52.65	192.5	67.67	224.0	80.01	231.9	85.15	234.4	85.42	241.6	85.73	248.2	86.52
46	151.6	56.63	180.3	72.95	210.1	84.87	211.8	89.13	213.9	89.40	220.8	89.64	226.7	90.50	
48	134.0	48.88	159.6	63.11	181.4	72.54	183.8	75.62	185.9	75.86	192.1	76.03	197.3	76.65	
90	10	153.0	19.11	182.8	22.95	212.5	27.06	226.7	29.18	241.3	31.41	271.0	35.14	300.5	39.08
	12	153.0	19.32	182.8	23.32	212.5	27.54	226.7	29.76	241.3	32.09	271.0	35.83	300.5	39.77
	14	153.0	19.69	182.8	23.77	212.5	28.12	226.7	30.35	241.3	32.68	271.0	36.54	300.5	40.59
	16	153.0	20.04	182.8	24.25	212.5	28.70	226.7	30.93	241.3	33.29	271.0	37.23	300.5	41.27
	18	153.0	20.38	182.8	24.73	212.5	29.18	226.7	31.65	241.3	33.98	271.0	38.05	300.5	43.36
	20	153.0	20.72	182.8	25.18	212.5	29.76	226.7	32.23	241.3	35.28	271.0	40.72	300.5	45.42
	21	153.0	20.96	182.8	25.42	212.5	30.35	226.7	33.29	241.3	36.55	271.0	41.38	300.5	46.48
	23	153.0	21.44	182.8	26.48	212.5	32.47	226.7	35.72	241.3	39.15	271.0	43.88	296.3	48.67
	25	153.0	22.50	182.8	28.22	212.5	34.69	226.7	38.19	241.3	41.82	271.0	46.92	292.2	50.73
	27	153.0	24.01	182.8	30.11	212.5	37.02	226.7	40.76	241.3	44.76	271.0	49.87	288.0	53.12
	29	153.0	25.42	182.8	32.09	212.5	39.59	226.7	43.60	241.3	47.81	271.0	52.85	283.5	55.25
	31	153.0	27.06	182.8	34.22	212.5	42.19	226.7	46.41	241.3	50.97	271.0	55.48	279.3	57.40
	33	153.0	28.84	182.8	36.44	212.5	45.00	226.7	49.46	241.3	54.05	271.0	58.16	275.2	59.53
	35	153.0	30.59	182.8	38.67	212.5	47.81	226.7	52.71	241.3	57.33	266.2	61.48	270.7	62.92
	37	153.0	32.47	182.8	41.13	212.5	50.97	226.7	56.00	241.3	60.52	262.0	64.29	266.5	65.73
	39	153.0	34.35	182.8	43.74	212.5	53.95	226.7	59.60	241.3	63.64	257.6	67.78	262.1	68.60
	41	149.2	38.46	177.9	48.50	207.0	59.22	220.9	65.18	235.0	68.71	246.8	71.41	251.3	73.06
	43	145.4	41.51	173.7	52.40	201.8	64.67	215.6	70.21	229.2	73.67	236.8	76.48	240.9	77.41
46	136.4	46.72	162.7	59.67	189.0	73.71	202.1	79.60	208.4	81.83	216.0	83.95	220.2	84.08	
48	120.5	40.83	144.0	52.20	167.2	64.46	178.6	69.43	180.7	70.52	187.9	72.27	191.4	72.37	
80	10	136.0	15.99	162.0	19.23	188.0	22.56	201.5	24.35	215.0	26.11	241.3	29.79	267.2	32.33
	12	136.0	16.34	162.0	19.43	188.0	23.01	201.5	24.77	215.0	26.55	241.3	30.34	267.2	32.98
	14	136.0	16.55	162.0	19.88	188.0	23.32	201.5	25.21	215.0	27.00	241.3	30.89	267.2	33.60
	16	136.0	16.78	162.0	20.22	188.0	23.77	201.5	25.66	215.0	27.55	241.3	31.57	267.2	34.26
	18	136.0	17.13	162.0	20.57	188.0	24.22	201.5	26.11	215.0	28.10	241.3	32.12	267.2	35.01
	20	136.0	17.44	162.0	21.01	188.0	24.77	201.5	26.66	215.0	28.68	241.3	33.33	267.2	37.08
	21	136.0	17.54	162.0	21.22	188.0	25.00	201.5	27.00	215.0	29.34	241.3	34.39	267.2	38.07
	23	136.0	17.89	162.0	21.56	188.0	26.11	201.5	28.68	215.0	31.33	241.3	36.32	267.2	39.96
	25	136.0	18.57	162.0	23.01	188.0	28.00	201.5	30.68	215.0	33.57	241.3	38.86	267.2	42.72
	27	136.0	19.67	162.0	24.45	188.0	29.89	201.5	32.78	215.0	35.77	241.3	41.28	267.2	44.95
	29	136.0	20.88	162.0	26.11	188.0	31.78	201.5	34.91	215.0	38.21	241.3	44.23	267.2	48.12
	31	136.0	22.22	162.0	27.66	188.0	33.88	201.5	37.22	215.0	40.69	241.3	46.95	267.2	50.52
	33	136.0	23.56	162.0	29.55	188.0	36.11	201.5	39.66	215.0	43.34	241.3	49.46	267.2	52.97
	35	136.0	25.00	162.0	31.33	188.0	38.45	201.5	42.24	215.0	46.23	241.3	52.45	264.5	54.89
	37	136.0	26.45	162.0	33.33	188.0	40.79	201.5	44.89	215.0	49.12	241.3	55.34	260.3	57.37
	39	136.0	27.96	162.0	35.22	188.0	43.61	201.5	48.26	215.0	52.79	241.3	58.47	255.8	60.53
	41	132.6	30.92	157.8	39.04	183.1	47.88	196.3	52.90	209.4	57.99	235.0	65.08	245.1	67.07
	43	129.1	34.05	154.0	42.58	178.6	52.28	191.4	57.65	204.6	63.39	229.2	69.65	235.0	71.82
46	121.1	37.87	144.3	47.98	167.5	58.88	179.6	64.18	191.4	71.51	209.7	76.01	214.6	77.25	
48	107.0	33.09	127.7	41.96	148.2	51.49	158.9	56.06	169.6	62.60	182.1	65.80	186.6	66.49	

Note

1. TC: Total Capacity(kW), PI : Power Input(kW, Comp. + Outdoor fan motor)
2. Capacity tables show the average value of conditions which may occur.

7. Capacity Tables

Combination (%)	Outdoor air temp (°C DB)	Cooling Capacity(90HP)													
		Indoor air temp. (DB/WB, °C)													
		20		23		26		27		28		30		32	
		14	16	18	19	20	22	24	TC	PI	TC	PI	TC	PI	
70	10	118.7	14.06	142.3	16.72	164.8	19.38	176.5	20.93	188.0	22.35	210.5	25.46	234.0	28.46
	12	118.7	14.27	142.3	16.93	164.8	19.79	176.5	21.24	188.0	22.80	210.5	25.90	234.0	29.01
	14	118.7	14.51	142.3	17.16	164.8	20.14	176.5	21.59	188.0	23.14	210.5	26.46	234.0	29.53
	16	118.7	14.71	142.3	17.48	164.8	20.48	176.5	22.04	188.0	23.56	210.5	26.91	234.0	30.16
	18	118.7	14.95	142.3	17.82	164.8	20.93	176.5	22.45	188.0	24.01	210.5	27.32	234.0	30.71
	20	118.7	15.16	142.3	18.14	164.8	21.24	176.5	22.90	188.0	24.56	210.5	28.01	234.0	31.88
	21	118.7	15.37	142.3	18.27	164.8	21.48	176.5	23.14	188.0	24.80	210.5	28.43	234.0	32.54
	23	118.7	15.61	142.3	18.69	164.8	21.90	176.5	23.90	188.0	26.01	210.5	30.43	234.0	34.37
	25	118.7	15.82	142.3	19.38	164.8	23.35	176.5	25.56	188.0	27.77	210.5	32.54	234.0	36.03
	27	118.7	16.72	142.3	20.69	164.8	24.90	176.5	27.11	188.0	29.67	210.5	34.75	234.0	38.30
	29	118.7	17.82	142.3	21.90	164.8	26.46	176.5	28.88	188.0	31.54	210.5	37.06	234.0	41.03
	31	118.7	18.93	142.3	23.35	164.8	28.22	176.5	30.88	188.0	33.64	210.5	39.51	234.0	43.52
	33	118.7	20.03	142.3	24.66	164.8	29.98	176.5	32.75	188.0	35.75	210.5	42.04	234.0	46.35
	35	118.7	21.14	142.3	26.35	164.8	31.88	176.5	34.85	188.0	38.06	210.5	44.83	234.0	49.15
	37	118.7	22.45	142.3	27.91	164.8	33.85	176.5	37.06	188.0	40.51	210.5	47.70	234.0	51.85
	39	118.7	23.87	142.3	29.74	164.8	36.20	176.5	39.89	188.0	43.76	210.5	51.05	234.0	55.92
	41	115.6	26.39	138.5	32.57	160.6	39.72	172.0	43.76	183.1	47.56	205.3	56.06	228.1	60.31
	43	112.9	28.70	135.0	35.51	156.5	43.35	167.6	47.70	178.6	51.95	200.1	61.24	222.2	65.21
46	105.9	31.91	126.7	39.93	146.8	48.81	157.1	53.13	167.5	58.55	187.6	69.08	208.4	72.68	
48	93.5	27.84	112.1	34.89	129.8	42.66	138.8	46.42	148.2	51.22	165.8	60.45	184.5	62.90	
60	10	101.8	12.11	121.5	14.22	141.2	16.54	151.3	17.73	161.0	18.84	181.0	21.37	200.8	23.90
	12	101.8	12.35	121.5	14.43	141.2	16.75	151.3	17.97	161.0	19.18	181.0	21.71	200.8	24.35
	14	101.8	12.45	121.5	14.67	141.2	17.07	151.3	18.28	161.0	19.50	181.0	22.16	200.8	24.80
	16	101.8	12.66	121.5	14.99	141.2	17.31	151.3	18.63	161.0	19.95	181.0	22.58	200.8	25.22
	18	101.8	12.90	121.5	15.20	141.2	17.62	151.3	18.94	161.0	20.29	181.0	22.93	200.8	25.78
	20	101.8	13.11	121.5	15.44	141.2	17.97	151.3	19.29	161.0	20.61	181.0	23.35	200.8	26.33
	21	101.8	13.22	121.5	15.54	141.2	18.18	151.3	19.50	161.0	20.82	181.0	23.69	200.8	26.57
	23	101.8	13.46	121.5	15.86	141.2	18.42	151.3	19.84	161.0	21.27	181.0	24.56	200.8	28.20
	25	101.8	13.67	121.5	16.20	141.2	19.18	151.3	20.82	161.0	22.58	181.0	26.23	200.8	30.18
	27	101.8	14.12	121.5	17.07	141.2	20.40	151.3	22.16	161.0	24.04	181.0	27.89	200.8	32.19
	29	101.8	14.99	121.5	18.18	141.2	21.71	151.3	23.59	161.0	25.57	181.0	29.76	200.8	34.38
	31	101.8	15.86	121.5	19.29	141.2	23.03	151.3	25.12	161.0	27.23	181.0	31.74	200.8	36.60
	33	101.8	16.75	121.5	20.40	141.2	24.46	151.3	26.68	161.0	28.97	181.0	33.72	200.8	39.02
	35	101.8	17.73	121.5	21.71	141.2	26.02	151.3	28.31	161.0	30.74	181.0	35.94	200.8	41.42
	37	101.8	18.73	121.5	22.90	141.2	27.54	151.3	30.08	161.0	32.61	181.0	38.12	200.8	44.09
	39	101.8	19.91	121.5	24.39	141.2	29.73	151.3	32.26	161.0	35.11	181.0	40.90	200.8	47.25
	41	99.0	21.61	118.4	26.71	137.8	32.30	147.4	35.25	156.8	38.09	176.2	44.86	195.6	51.34
	43	96.6	23.48	115.6	29.07	134.3	35.21	143.7	38.43	153.0	41.56	172.0	48.98	190.7	56.06
46	90.7	26.30	108.3	32.64	126.0	39.58	134.7	43.19	143.3	46.76	161.0	55.19	178.6	63.87	
48	80.0	22.93	95.9	28.48	111.4	34.59	119.1	37.71	127.0	40.86	142.6	48.26	158.2	55.89	
50	10	85.1	10.42	101.8	12.06	118.0	13.73	126.0	14.70	134.0	15.58	150.2	17.56	167.5	19.54
	12	85.1	10.52	101.8	12.19	118.0	13.94	126.0	14.91	134.0	15.92	150.2	17.88	167.5	19.86
	14	85.1	10.66	101.8	12.40	118.0	14.15	126.0	15.15	134.0	16.13	150.2	18.12	167.5	20.21
	16	85.1	10.87	101.8	12.61	118.0	14.39	126.0	15.47	134.0	16.34	150.2	18.43	167.5	20.52
	18	85.1	10.97	101.8	12.72	118.0	14.60	126.0	15.68	134.0	16.69	150.2	18.78	167.5	20.97
	20	85.1	11.08	101.8	12.96	118.0	14.91	126.0	15.92	134.0	17.00	150.2	19.09	167.5	21.39
	21	85.1	11.19	101.8	13.06	118.0	15.05	126.0	16.13	134.0	17.11	150.2	19.30	167.5	21.60
	23	85.1	11.43	101.8	13.28	118.0	15.26	126.0	16.34	134.0	17.45	150.2	19.65	167.5	22.05
	25	85.1	11.53	101.8	13.49	118.0	15.58	126.0	16.69	134.0	18.01	150.2	20.63	167.5	23.59
	27	85.1	11.74	101.8	13.94	118.0	16.45	126.0	17.77	134.0	19.09	150.2	22.05	167.5	25.12
	29	85.1	12.40	101.8	14.81	118.0	17.45	126.0	18.88	134.0	20.31	150.2	23.38	167.5	26.66
	31	85.1	13.06	101.8	15.68	118.0	18.54	126.0	19.97	134.0	21.60	150.2	24.91	167.5	28.43
	33	85.1	13.83	101.8	16.58	118.0	19.65	126.0	21.18	134.0	22.93	150.2	26.44	167.5	30.28
	35	85.1	14.60	101.8	17.56	118.0	20.73	126.0	22.51	134.0	24.25	150.2	27.98	167.5	32.16
	37	85.1	15.47	101.8	18.54	118.0	21.95	126.0	23.80	134.0	25.68	150.2	29.86	167.5	34.14
	39	85.1	16.51	101.8	19.89	118.0	23.52	126.0	25.64	134.0	27.56	150.2	31.81	167.5	36.86
	41	82.7	17.84	99.0	21.53	114.9	25.71	122.9	27.77	130.5	29.86	146.4	34.84	163.0	40.03
	43	80.7	19.41	96.6	23.41	112.1	27.98	119.8	30.24	127.4	32.51	142.9	38.01	159.2	43.66
46	75.8	21.74	90.7	26.27	104.9	31.39	112.2	33.94	119.4	36.48	133.9	42.75	149.2	49.16	
48	67.1	18.92	80.0	22.89	92.8	27.38	99.3	29.62	105.6	31.84	118.4	37.35	131.9	42.96	

Note

1. TC: Total Capacity(kW), PI : Power Input(kW, Comp. + Outdoor fan motor)
2. Capacity tables show the average value of conditions which may occur.

7. Capacity Tables

◆ A(C)RUN920LLS5

Combination (%)	Outdoor air temp (°C DB)	Indoor air temp. (DB/WB, °C)														Cooling Capacity(92HP)	
		20		23		26		27		28		30		32		TC	PI
		14		16		18		19		20		22		24			
		TC	PI	TC	PI	TC	PI	TC	PI	TC	PI	TC	PI	TC	PI		
130	10	255.1	30.96	303.9	37.84	325.6	43.91	335.1	44.78	344.3	45.17	360.9	45.52	370.1	45.69		
	12	255.1	31.73	303.9	39.20	325.6	45.70	335.1	46.01	344.3	46.36	360.9	46.75	370.1	47.17		
	14	255.1	32.81	303.9	40.61	325.6	47.42	335.1	47.77	344.3	48.15	360.9	48.54	370.1	48.96		
	16	255.1	34.01	303.9	42.04	325.6	49.56	335.1	50.01	344.3	50.40	360.9	50.86	370.1	51.27		
	18	255.1	35.41	303.9	44.47	325.6	51.84	335.1	52.96	344.3	53.38	360.9	53.91	370.1	54.26		
	20	255.1	36.99	303.9	47.38	325.6	54.40	335.1	58.23	344.3	58.71	355.6	59.28	365.1	59.70		
	21	255.1	37.94	303.9	49.03	325.6	55.52	335.1	61.63	344.3	62.12	353.8	62.75	363.0	63.17		
	23	255.1	40.71	303.9	51.59	325.6	58.40	335.1	68.01	340.0	68.54	348.5	69.24	357.7	69.70		
	25	255.1	43.49	303.9	54.54	325.6	62.40	330.9	75.42	335.1	76.02	344.3	76.79	353.8	77.32		
	27	255.1	46.54	303.9	58.33	321.6	66.51	325.6	83.04	330.9	83.70	340.0	84.51	348.5	85.11		
	29	255.1	49.59	303.9	62.33	316.3	71.56	320.9	91.25	325.6	91.81	335.1	92.62	344.3	92.97		
	31	255.1	52.92	302.9	65.67	311.0	76.12	316.3	90.86	320.9	91.42	329.8	92.23	339.0	92.59		
	33	255.1	56.37	297.6	69.59	307.1	81.63	312.1	90.02	316.3	90.58	325.6	91.39	334.0	91.74		
	35	255.1	60.12	292.3	72.86	301.8	88.41	307.1	88.86	312.1	89.39	320.6	90.20	329.8	90.55		
	37	255.1	64.12	288.4	76.47	297.6	87.25	301.8	87.70	307.1	88.23	315.3	89.00	324.8	89.36		
	39	255.1	68.26	283.1	80.48	292.3	86.09	297.6	86.51	301.8	87.04	311.0	87.81	320.6	88.16		
	41	248.7	72.41	271.4	84.51	280.6	84.93	284.8	85.35	290.5	85.85	299.0	86.62	307.1	86.97		
	43	242.4	76.37	260.1	83.32	269.3	83.74	273.2	84.16	278.8	84.69	287.3	85.43	295.1	85.77		
46	227.2	81.74	237.4	81.60	245.9	81.99	249.8	82.41	254.8	82.90	262.9	83.64	270.3	83.98			
48	201.0	79.46	206.0	79.70	213.7	79.88	217.2	80.09	221.9	80.79	228.9	81.32	235.3	81.63			
120	10	230.7	27.87	274.6	34.15	300.1	40.60	309.2	43.87	318.1	44.57	335.5	44.75	343.6	45.10		
	12	230.7	28.60	274.6	35.31	300.1	42.22	309.2	44.78	318.1	46.22	335.5	46.78	343.6	47.14		
	14	230.7	29.59	274.6	36.50	300.1	43.94	309.2	46.50	318.1	47.91	335.5	48.61	343.6	49.00		
	16	230.7	30.67	274.6	38.01	300.1	45.63	309.2	48.22	318.1	50.12	335.5	50.75	343.6	51.14		
	18	230.7	31.87	274.6	39.73	300.1	47.45	309.2	50.78	318.1	52.68	335.5	53.28	343.6	53.73		
	20	230.7	33.06	274.6	42.11	300.1	50.01	309.2	53.42	318.1	55.49	335.5	56.22	343.6	56.65		
	21	230.7	34.08	274.6	43.63	300.1	51.41	309.2	55.00	318.1	57.31	335.5	58.05	343.6	58.50		
	23	230.7	36.43	274.6	46.68	300.1	55.07	309.2	58.44	318.1	61.10	335.5	61.70	343.6	62.19		
	25	230.7	38.92	274.6	50.01	300.1	58.09	309.2	62.30	318.1	65.52	331.6	66.05	339.7	66.58		
	27	230.7	41.55	274.6	53.45	300.1	61.84	309.2	66.58	318.1	70.40	326.6	70.89	334.7	71.45		
	29	230.7	44.33	274.6	57.07	300.1	65.07	309.2	71.24	313.2	75.04	321.3	76.16	330.5	76.79		
	31	230.7	47.24	274.6	60.96	300.1	68.44	305.0	76.30	309.2	80.51	317.4	81.92	325.2	82.58		
	33	230.7	50.29	274.6	64.96	295.8	72.37	300.1	82.83	304.0	86.44	312.1	87.42	320.2	88.12		
	35	230.7	53.45	274.6	69.25	290.9	76.61	294.8	91.25	300.1	91.71	308.2	91.99	316.3	92.72		
	37	230.7	57.52	274.6	73.07	286.6	81.67	290.9	89.32	294.8	89.78	302.9	90.06	311.4	90.76		
	39	230.7	61.91	273.5	77.25	281.7	86.62	285.9	87.49	289.8	87.95	299.0	88.20	307.1	88.90		
	41	225.0	66.33	261.5	81.39	270.4	84.93	274.2	85.67	278.1	86.09	286.3	86.34	294.4	87.04		
	43	219.4	70.79	250.5	80.23	259.4	83.03	262.9	83.81	266.8	84.23	274.9	84.51	282.7	85.18		
46	205.6	76.12	228.6	78.33	236.7	80.41	240.3	81.07	244.1	81.49	251.2	81.74	258.7	82.37			
48	181.9	74.55	198.5	76.93	205.9	78.86	209.1	79.32	212.3	79.56	218.7	79.88	225.4	80.23			
110	10	206.7	25.06	246.6	30.54	275.3	36.29	283.4	39.27	301.1	42.26	308.2	43.45	329.1	44.15		
	12	206.7	25.83	246.6	31.58	275.3	37.80	283.4	40.36	301.1	43.84	308.2	45.27	329.1	46.29		
	14	206.7	26.64	246.6	32.99	275.3	39.49	283.4	42.36	301.1	46.05	308.2	47.38	329.1	48.36		
	16	206.7	27.59	246.6	34.19	275.3	41.13	283.4	44.22	301.1	48.19	308.2	49.49	329.1	50.36		
	18	206.7	28.61	246.6	35.62	275.3	43.49	283.4	46.57	301.1	50.82	308.2	51.84	329.1	52.79		
	20	206.7	29.62	246.6	37.41	275.3	46.12	283.4	48.71	301.1	53.28	308.2	54.61	329.1	55.49		
	21	206.7	30.29	246.6	38.50	275.3	47.31	283.4	50.01	301.1	54.78	308.2	56.15	329.1	57.03		
	23	206.7	32.29	246.6	41.27	275.3	49.94	283.4	52.82	301.1	57.87	308.2	59.10	329.1	60.08		
	25	206.7	34.50	246.6	44.05	275.3	52.78	283.4	55.84	301.1	61.14	308.2	62.01	325.2	63.28		
	27	206.7	36.85	246.6	47.10	275.3	55.77	283.4	59.10	301.1	63.84	308.2	65.31	320.2	66.43		
	29	206.7	39.34	246.6	50.29	275.3	58.93	283.4	62.58	301.1	67.49	308.2	68.65	316.3	69.67		
	31	206.7	41.83	246.6	53.59	275.3	62.26	283.4	66.30	296.2	70.90	304.3	72.30	311.4	73.04		
	33	206.7	44.61	246.6	57.07	275.3	65.80	283.4	70.26	292.3	74.86	299.3	76.12	307.1	76.54		
	35	206.7	47.38	246.6	60.96	275.3	69.49	283.4	74.44	287.3	79.03	294.4	79.74	302.2	80.16		
	37	206.7	50.22	246.6	64.68	275.3	73.35	279.5	78.86	282.4	83.35	290.5	83.63	297.2	83.88		
	39	206.7	54.12	246.6	68.75	270.4	77.39	274.3	84.37	278.5	87.46	285.2	87.63	293.3	87.71		
	41	201.7	58.05	240.3	72.79	259.0	81.63	262.9	91.25	266.4	91.25	274.2	91.99	280.9	92.72		
	43	196.4	60.96	234.3	75.84	248.0	86.55	252.3	87.53	255.5	87.35	262.9	87.84	269.6	88.09		
46	184.3	59.49	219.7	73.21	226.4	82.16	230.3	82.16	233.2	82.86	240.3	83.32	246.6	83.53			
48	162.8	57.77	190.7	70.54	196.7	78.16	200.3	78.68	202.8	79.07	209.1	79.28	214.5	79.60			

Note

1. TC: Total Capacity(kW), PI : Power Input(kW, Comp. + Outdoor fan motor)
2. Capacity tables show the average value of conditions which may occur.

7. Capacity Tables

Combination (%)	Outdoor air temp (°C DB)	Cooling Capacity(92HP)													
		Indoor air temp. (DB/WB, °C)													
		20		23		26		27		28		30		32	
		14	16	18	19	20	22	24	TC	PI	TC	PI	TC	PI	
100	10	173.8	22.57	207.0	27.41	241.0	32.53	257.6	35.16	274.2	37.77	304.0	42.05	310.7	42.39
	12	173.8	23.30	207.0	28.54	241.0	33.62	257.6	36.11	274.2	38.99	304.0	44.32	310.7	44.75
	14	173.8	24.01	207.0	29.69	241.0	35.06	257.6	37.66	274.2	40.67	304.0	46.78	310.7	47.24
	16	173.8	24.74	207.0	30.67	241.0	36.54	257.6	39.45	274.2	42.85	304.0	49.06	310.7	49.73
	18	173.8	25.48	207.0	31.80	241.0	37.97	257.6	41.38	274.2	45.45	304.0	51.83	310.7	52.23
	20	173.8	26.39	207.0	33.02	241.0	40.18	257.6	44.33	274.2	48.61	304.0	54.30	310.7	54.75
	21	173.8	26.95	207.0	33.80	241.0	41.55	257.6	45.84	274.2	50.43	304.0	55.56	310.7	55.98
	23	173.8	28.53	207.0	36.15	241.0	44.61	257.6	49.17	274.2	54.01	304.0	58.16	310.7	58.64
	25	173.8	30.32	207.0	38.50	241.0	47.66	257.6	52.64	274.2	57.77	304.0	60.65	307.9	61.14
	27	173.8	32.43	207.0	41.13	241.0	50.96	257.6	56.23	274.2	61.42	298.0	63.49	304.3	64.01
	29	173.8	34.50	207.0	43.91	241.0	54.43	257.6	60.12	274.2	65.00	292.6	66.05	299.7	66.58
	31	173.8	36.85	207.0	46.82	241.0	58.05	257.6	64.12	274.2	68.30	288.0	68.61	295.1	69.17
	33	173.8	39.06	207.0	49.87	241.0	61.91	257.6	68.44	274.2	70.86	283.4	71.17	290.5	71.74
	35	173.8	41.55	207.0	53.06	241.0	65.94	257.6	73.00	270.0	73.42	278.5	73.74	285.5	74.30
	37	173.8	44.50	207.0	56.89	241.0	69.84	257.6	76.47	265.4	76.86	273.2	77.17	279.6	77.88
	39	173.8	47.73	207.0	61.14	241.0	74.02	257.6	80.23	261.1	80.58	268.9	80.86	275.0	81.63
	41	171.2	50.92	203.8	65.35	237.1	78.19	247.3	83.95	252.6	84.30	258.6	84.58	266.8	85.39
	43	165.2	53.91	196.7	69.28	229.0	81.91	237.1	87.18	239.6	87.46	247.0	87.77	253.7	88.58
46	155.0	57.98	184.4	74.68	214.8	86.90	216.5	91.25	218.7	91.53	225.8	91.78	231.8	92.65	
48	136.9	50.05	163.1	64.61	185.4	74.27	187.9	77.42	190.0	77.67	196.4	77.84	201.7	78.47	
90	10	156.4	19.49	186.8	23.41	217.2	27.60	231.8	29.76	246.6	32.03	277.0	35.84	307.2	39.86
	12	156.4	19.71	186.8	23.79	217.2	28.09	231.8	30.36	246.6	32.74	277.0	36.54	307.2	40.56
	14	156.4	20.09	186.8	24.25	217.2	28.68	231.8	30.95	246.6	33.33	277.0	37.27	307.2	41.40
	16	156.4	20.44	186.8	24.73	217.2	29.28	231.8	31.55	246.6	33.95	277.0	37.97	307.2	42.10
	18	156.4	20.79	186.8	25.22	217.2	29.76	231.8	32.28	246.6	34.66	277.0	38.81	307.2	44.23
	20	156.4	21.14	186.8	25.68	217.2	30.36	231.8	32.87	246.6	35.98	277.0	41.54	307.2	46.33
	21	156.4	21.38	186.8	25.92	217.2	30.95	231.8	33.95	246.6	37.28	277.0	42.20	307.2	47.40
	23	156.4	21.87	186.8	27.01	217.2	33.12	231.8	36.44	246.6	39.93	277.0	44.75	302.9	49.64
	25	156.4	22.95	186.8	28.79	217.2	35.39	231.8	38.95	246.6	42.66	277.0	47.86	298.7	51.74
	27	156.4	24.49	186.8	30.71	217.2	37.76	231.8	41.57	246.6	45.66	277.0	50.87	294.4	54.18
	29	156.4	25.92	186.8	32.74	217.2	40.39	231.8	44.47	246.6	48.77	277.0	53.90	289.8	56.35
	31	156.4	27.60	186.8	34.90	217.2	43.04	231.8	47.34	246.6	51.98	277.0	56.59	285.6	58.55
	33	156.4	29.41	186.8	37.17	217.2	45.90	231.8	50.44	246.6	55.13	277.0	59.32	281.3	60.72
	35	156.4	31.20	186.8	39.44	217.2	48.77	231.8	53.77	246.6	58.48	272.1	62.71	276.7	64.17
	37	156.4	33.12	186.8	41.96	217.2	51.98	231.8	57.12	246.6	61.73	267.8	65.57	272.5	67.04
	39	156.4	35.04	186.8	44.61	217.2	55.02	231.8	60.79	246.6	64.91	263.3	69.14	267.9	69.97
	41	152.5	39.23	181.9	49.47	211.6	60.40	225.8	66.48	240.3	70.08	252.3	72.84	256.9	74.52
	43	148.6	42.34	177.6	53.45	206.3	65.96	220.4	71.61	234.3	75.14	242.0	78.01	246.3	78.95
46	139.4	47.65	166.3	60.86	193.2	75.18	206.6	81.19	213.0	83.46	220.8	85.63	225.0	85.76	
48	123.2	41.64	147.2	53.24	170.9	65.75	182.6	70.81	184.7	71.93	192.1	73.71	195.7	73.82	
80	10	139.0	16.26	165.6	19.55	192.2	22.94	206.0	24.76	219.8	26.55	246.6	30.29	273.2	32.88
	12	139.0	16.61	165.6	19.76	192.2	23.40	206.0	25.18	219.8	27.00	246.6	30.85	273.2	33.54
	14	139.0	16.82	165.6	20.22	192.2	23.71	206.0	25.64	219.8	27.45	246.6	31.41	273.2	34.17
	16	139.0	17.07	165.6	20.56	192.2	24.17	206.0	26.09	219.8	28.01	246.6	32.10	273.2	34.83
	18	139.0	17.41	165.6	20.91	192.2	24.62	206.0	26.55	219.8	28.58	246.6	32.66	273.2	35.60
	20	139.0	17.73	165.6	21.37	192.2	25.18	206.0	27.11	219.8	29.17	246.6	33.89	273.2	37.70
	21	139.0	17.84	165.6	21.58	192.2	25.43	206.0	27.45	219.8	29.83	246.6	34.97	273.2	38.71
	23	139.0	18.19	165.6	21.93	192.2	26.55	206.0	29.17	219.8	31.86	246.6	36.93	273.2	40.64
	25	139.0	18.88	165.6	23.40	192.2	28.47	206.0	31.19	219.8	34.13	246.6	39.52	273.2	43.44
	27	139.0	20.00	165.6	24.86	192.2	30.39	206.0	33.33	219.8	36.37	246.6	41.97	273.2	45.71
	29	139.0	21.23	165.6	26.55	192.2	32.32	206.0	35.50	219.8	38.86	246.6	44.98	273.2	48.93
	31	139.0	22.59	165.6	28.12	192.2	34.45	206.0	37.84	219.8	41.37	246.6	47.74	273.2	51.37
	33	139.0	23.96	165.6	30.04	192.2	36.72	206.0	40.33	219.8	44.07	246.6	50.29	273.2	53.86
	35	139.0	25.43	165.6	31.86	192.2	39.10	206.0	42.95	219.8	47.00	246.6	53.33	270.3	55.81
	37	139.0	26.89	165.6	33.89	192.2	41.48	206.0	45.64	219.8	49.94	246.6	56.27	266.1	58.34
	39	139.0	28.43	165.6	35.81	192.2	44.35	206.0	49.07	219.8	53.68	246.6	59.46	261.5	61.55
	41	135.5	31.44	161.4	39.69	187.2	48.68	200.7	53.79	214.1	58.97	240.3	66.17	250.5	68.20
	43	132.0	34.62	157.4	43.30	182.6	53.16	195.7	58.62	209.1	64.45	234.3	70.82	240.3	73.02
46	123.8	38.51	147.5	48.79	171.3	59.87	183.6	65.26	195.7	72.71	214.4	77.29	219.4	78.55	
48	109.4	33.64	130.6	42.67	151.5	52.36	162.4	57.00	173.4	63.65	186.1	66.90	190.7	67.60	

Note

1. TC: Total Capacity(kW), PI : Power Input(kW, Comp. + Outdoor fan motor)
2. Capacity tables show the average value of conditions which may occur.

7. Capacity Tables

Combination (%)	Outdoor air temp (°C DB)	Cooling Capacity(92HP)													
		Indoor air temp. (DB/WB, °C)													
		20		23		26		27		28		30		32	
		14	16	18	19	20	22	24	14	16	18	19	20	22	24
	TC	PI	TC	PI	TC	PI	TC	PI	TC	PI	TC	PI	TC	PI	
70	10	121.4	14.25	145.4	16.94	168.4	19.64	180.4	21.21	192.2	22.65	215.2	25.80	239.2	28.85
	12	121.4	14.46	145.4	17.16	168.4	20.06	180.4	21.53	192.2	23.11	215.2	26.26	239.2	29.41
	14	121.4	14.70	145.4	17.40	168.4	20.41	180.4	21.88	192.2	23.46	215.2	26.82	239.2	29.94
	16	121.4	14.92	145.4	17.72	168.4	20.76	180.4	22.34	192.2	23.88	215.2	27.27	239.2	30.57
	18	121.4	15.16	145.4	18.07	168.4	21.21	180.4	22.76	192.2	24.33	215.2	27.70	239.2	31.12
	20	121.4	15.37	145.4	18.38	168.4	21.53	180.4	23.21	192.2	24.89	215.2	28.39	239.2	32.31
	21	121.4	15.58	145.4	18.52	168.4	21.78	180.4	23.46	192.2	25.14	215.2	28.82	239.2	32.98
	23	121.4	15.82	145.4	18.94	168.4	22.20	180.4	24.23	192.2	26.36	215.2	30.85	239.2	34.84
	25	121.4	16.04	145.4	19.64	168.4	23.67	180.4	25.91	192.2	28.15	215.2	32.98	239.2	36.52
	27	121.4	16.94	145.4	20.97	168.4	25.24	180.4	27.48	192.2	30.07	215.2	35.22	239.2	38.83
	29	121.4	18.07	145.4	22.20	168.4	26.82	180.4	29.27	192.2	31.97	215.2	37.57	239.2	41.59
	31	121.4	19.19	145.4	23.67	168.4	28.60	180.4	31.30	192.2	34.10	215.2	40.05	239.2	44.12
	33	121.4	20.31	145.4	25.00	168.4	30.39	180.4	33.19	192.2	36.24	215.2	42.61	239.2	46.98
	35	121.4	21.43	145.4	26.71	168.4	32.31	180.4	35.33	192.2	38.58	215.2	45.44	239.2	49.82
	37	121.4	22.76	145.4	28.29	168.4	34.31	180.4	37.57	192.2	41.07	215.2	48.35	239.2	52.55
	39	121.4	24.19	145.4	30.15	168.4	36.69	180.4	40.44	192.2	44.36	215.2	51.75	239.2	56.68
	41	118.2	26.75	141.6	33.02	164.2	40.26	175.8	44.36	187.2	48.21	209.8	56.82	233.2	61.13
	43	115.4	29.10	138.0	35.99	159.9	43.94	171.3	48.35	182.6	52.66	204.5	62.08	227.2	66.10
46	108.3	32.35	129.5	40.47	150.0	49.47	160.6	53.85	171.3	59.35	191.8	70.02	213.0	73.67	
48	95.6	28.22	114.6	35.36	132.7	43.24	141.9	47.06	151.5	51.92	169.5	61.27	188.6	63.76	
60	10	104.0	12.24	124.2	14.37	144.4	16.72	154.6	17.91	164.6	19.03	185.0	21.59	205.2	24.15
	12	104.0	12.48	124.2	14.58	144.4	16.93	154.6	18.16	164.6	19.38	185.0	21.94	205.2	24.61
	14	104.0	12.58	124.2	14.82	144.4	17.25	154.6	18.47	164.6	19.70	185.0	22.40	205.2	25.06
	16	104.0	12.80	124.2	15.14	144.4	17.49	154.6	18.82	164.6	20.15	185.0	22.82	205.2	25.48
	18	104.0	13.04	124.2	15.35	144.4	17.81	154.6	19.14	164.6	20.50	185.0	23.17	205.2	26.04
	20	104.0	13.25	124.2	15.60	144.4	18.16	154.6	19.49	164.6	20.82	185.0	23.59	205.2	26.61
	21	104.0	13.36	124.2	15.70	144.4	18.37	154.6	19.70	164.6	21.03	185.0	23.94	205.2	26.85
	23	104.0	13.60	124.2	16.02	144.4	18.61	154.6	20.05	164.6	21.49	185.0	24.82	205.2	28.50
	25	104.0	13.81	124.2	16.37	144.4	19.38	154.6	21.03	164.6	22.82	185.0	26.50	205.2	30.50
	27	104.0	14.26	124.2	17.25	144.4	20.61	154.6	22.40	164.6	24.29	185.0	28.18	205.2	32.53
	29	104.0	15.14	124.2	18.37	144.4	21.94	154.6	23.83	164.6	25.83	185.0	30.07	205.2	34.74
	31	104.0	16.02	124.2	19.49	144.4	23.27	154.6	25.38	164.6	27.51	185.0	32.07	205.2	36.98
	33	104.0	16.93	124.2	20.61	144.4	24.71	154.6	26.95	164.6	29.27	185.0	34.07	205.2	39.43
	35	104.0	17.91	124.2	21.94	144.4	26.29	154.6	28.60	164.6	31.06	185.0	36.31	205.2	41.85
	37	104.0	18.93	124.2	23.14	144.4	27.83	154.6	30.39	164.6	32.95	185.0	38.52	205.2	44.55
	39	104.0	20.12	124.2	24.64	144.4	30.04	154.6	32.60	164.6	35.47	185.0	41.32	205.2	47.74
	41	101.2	21.84	121.0	26.99	140.8	32.63	150.7	35.61	160.3	38.49	180.1	45.32	199.9	51.87
	43	98.7	23.73	118.2	29.37	137.3	35.58	146.9	38.83	156.4	41.99	175.8	49.49	195.0	56.64
46	92.7	26.57	110.7	32.98	128.8	40.00	137.6	43.64	146.5	47.25	164.6	55.77	182.6	64.53	
48	81.8	23.17	98.0	28.78	113.9	34.95	121.7	38.10	129.8	41.29	145.8	48.76	161.7	56.47	
50	10	87.0	10.49	104.0	12.14	120.6	13.82	128.8	14.81	137.0	15.69	153.6	17.69	171.2	19.68
	12	87.0	10.60	104.0	12.28	120.6	14.04	128.8	15.02	137.0	16.04	153.6	18.00	171.2	20.00
	14	87.0	10.74	104.0	12.49	120.6	14.25	128.8	15.26	137.0	16.25	153.6	18.25	171.2	20.35
	16	87.0	10.95	104.0	12.70	120.6	14.49	128.8	15.58	137.0	16.46	153.6	18.56	171.2	20.67
	18	87.0	11.05	104.0	12.81	120.6	14.70	128.8	15.79	137.0	16.81	153.6	18.91	171.2	21.12
	20	87.0	11.16	104.0	13.05	120.6	15.02	128.8	16.04	137.0	17.13	153.6	19.23	171.2	21.55
	21	87.0	11.27	104.0	13.16	120.6	15.16	128.8	16.25	137.0	17.23	153.6	19.44	171.2	21.76
	23	87.0	11.51	104.0	13.37	120.6	15.37	128.8	16.46	137.0	17.58	153.6	19.79	171.2	22.21
	25	87.0	11.61	104.0	13.58	120.6	15.69	128.8	16.81	137.0	18.14	153.6	20.77	171.2	23.76
	27	87.0	11.83	104.0	14.04	120.6	16.57	128.8	17.90	137.0	19.23	153.6	22.21	171.2	25.30
	29	87.0	12.49	104.0	14.91	120.6	17.58	128.8	19.02	137.0	20.46	153.6	23.55	171.2	26.85
	31	87.0	13.16	104.0	15.79	120.6	18.67	128.8	20.11	137.0	21.76	153.6	25.09	171.2	28.63
	33	87.0	13.93	104.0	16.70	120.6	19.79	128.8	21.33	137.0	23.09	153.6	26.63	171.2	30.50
	35	87.0	14.70	104.0	17.69	120.6	20.88	128.8	22.67	137.0	24.42	153.6	28.18	171.2	32.39
	37	87.0	15.58	104.0	18.67	120.6	22.11	128.8	23.97	137.0	25.86	153.6	30.07	171.2	34.39
	39	87.0	16.63	104.0	20.03	120.6	23.69	128.8	25.83	137.0	27.76	153.6	32.04	171.2	37.13
	41	84.6	17.97	101.2	21.68	117.5	25.90	125.6	27.97	133.4	30.07	149.7	35.09	166.7	40.32
	43	82.5	19.54	98.7	23.58	114.6	28.18	122.4	30.46	130.2	32.74	146.1	38.28	162.7	43.97
46	77.5	21.89	92.7	26.46	107.2	31.62	114.7	34.18	122.1	36.74	136.9	43.06	152.5	49.51	
48	68.6	19.06	81.8	23.06	94.8	27.58	101.5	29.83	107.9	32.07	121.0	37.62	134.8	43.27	

Note

1. TC: Total Capacity(kW), PI : Power Input(kW, Comp. + Outdoor fan motor)
2. Capacity tables show the average value of conditions which may occur.

7. Capacity Tables

◆ A(C)RUN940LLS5

Combination (%)	Outdoor air temp (°C DB)	Indoor air temp. (DB/WB, °C)												Cooling Capacity(94HP)			
		20		23		26		27		28		30		32			
		14		16		18		19		20		22		24			
		TC	PI	TC	PI	TC	PI	TC	PI	TC	PI	TC	PI	TC	PI		
130	10	260.7	31.51	310.5	38.51	332.6	44.69	342.4	45.58	351.8	45.97	368.8	46.33	378.2	46.51		
	12	260.7	32.29	310.5	39.90	332.6	46.51	342.4	46.83	351.8	47.19	368.8	47.58	378.2	48.01		
	14	260.7	33.40	310.5	41.33	332.6	48.26	342.4	48.62	351.8	49.01	368.8	49.40	378.2	49.83		
	16	260.7	34.61	310.5	42.79	332.6	50.44	342.4	50.90	351.8	51.30	368.8	51.76	378.2	52.19		
	18	260.7	36.04	310.5	45.26	332.6	52.76	342.4	53.90	351.8	54.33	368.8	54.87	378.2	55.23		
	20	260.7	37.65	310.5	48.22	332.6	55.37	342.4	59.26	351.8	59.76	363.4	60.33	373.1	60.76		
	21	260.7	38.62	310.5	49.90	332.6	56.51	342.4	62.73	351.8	63.23	361.5	63.87	370.9	64.30		
	23	260.7	41.44	310.5	52.51	332.6	59.44	342.4	69.23	347.4	69.76	356.1	70.48	365.5	70.94		
	25	260.7	44.26	310.5	55.51	332.6	63.51	338.1	76.76	342.4	77.37	351.8	78.16	361.5	78.69		
	27	260.7	47.37	310.5	59.37	328.6	67.69	332.6	84.51	338.1	85.19	347.4	86.02	356.1	86.62		
	29	260.7	50.47	310.5	63.44	323.2	72.83	327.9	92.88	332.6	93.44	342.4	94.27	351.8	94.63		
	31	260.7	53.87	309.5	66.83	317.8	77.48	323.2	92.48	327.9	93.05	337.0	93.88	346.4	94.23		
	33	260.7	57.37	304.1	70.83	313.8	83.09	318.9	91.63	323.2	92.20	332.6	93.02	341.3	93.38		
	35	260.7	61.19	298.7	74.16	308.4	89.98	313.8	90.45	318.9	90.98	327.5	91.80	337.0	92.16		
	37	260.7	65.26	294.6	77.84	304.1	88.80	308.4	89.26	313.8	89.80	322.1	90.59	331.9	90.95		
	39	260.7	69.48	289.2	81.91	298.7	87.62	304.1	88.05	308.4	88.59	317.8	89.38	327.5	89.73		
	41	254.1	73.70	277.3	86.02	286.7	86.44	291.0	86.87	296.8	87.38	305.5	88.16	313.8	88.52		
	43	247.7	77.73	265.7	84.80	275.1	85.23	279.1	85.66	284.9	86.19	293.6	86.95	301.5	87.30		
46	232.1	83.20	242.6	83.05	251.3	83.45	255.2	83.87	260.3	84.37	268.6	85.13	276.2	85.48			
48	205.4	80.88	210.4	81.12	218.4	81.30	222.0	81.52	226.7	82.23	233.9	82.76	240.4	83.09			
120	10	235.8	28.36	280.5	34.76	306.6	41.33	316.0	44.65	325.1	45.36	342.8	45.54	351.1	45.90		
	12	235.8	29.11	280.5	35.94	306.6	42.97	316.0	45.58	325.1	47.04	342.8	47.61	351.1	47.98		
	14	235.8	30.11	280.5	37.15	306.6	44.72	316.0	47.33	325.1	48.76	342.8	49.47	351.1	49.87		
	16	235.8	31.22	280.5	38.69	306.6	46.44	316.0	49.08	325.1	51.01	342.8	51.65	351.1	52.05		
	18	235.8	32.43	280.5	40.43	306.6	48.30	316.0	51.69	325.1	53.62	342.8	54.23	351.1	54.69		
	20	235.8	33.65	280.5	42.86	306.6	50.90	316.0	54.37	325.1	56.47	342.8	57.22	351.1	57.66		
	21	235.8	34.68	280.5	44.40	306.6	52.33	316.0	55.98	325.1	58.33	342.8	59.08	351.1	59.55		
	23	235.8	37.08	280.5	47.51	306.6	56.05	316.0	59.48	325.1	62.19	342.8	62.80	351.1	63.30		
	25	235.8	39.62	280.5	50.90	306.6	59.12	316.0	63.41	325.1	66.69	338.8	67.23	347.1	67.77		
	27	235.8	42.29	280.5	54.41	306.6	62.94	316.0	67.76	325.1	71.66	333.7	72.15	342.0	72.73		
	29	235.8	45.12	280.5	58.08	306.6	66.23	316.0	72.51	320.0	76.37	328.3	77.52	337.7	78.16		
	31	235.8	48.08	280.5	62.05	306.6	69.65	311.7	77.66	316.0	81.94	324.3	83.37	332.3	84.05		
	33	235.8	51.19	280.5	66.12	302.3	73.66	306.6	84.30	310.6	87.98	318.9	88.98	327.2	89.69		
	35	235.8	54.41	280.5	70.48	297.2	77.98	301.2	92.88	306.6	93.34	314.9	93.62	323.2	94.37		
	37	235.8	58.55	280.5	74.37	292.9	83.12	297.2	90.91	301.2	91.38	309.5	91.66	318.1	92.38		
	39	235.8	63.01	279.5	78.62	287.8	88.16	292.1	89.05	296.1	89.51	305.5	89.77	313.8	90.48		
	41	229.9	67.51	267.2	82.84	276.2	86.44	280.2	87.19	284.2	87.62	292.5	87.88	300.8	88.59		
	43	224.2	72.05	256.0	81.66	265.0	84.51	268.7	85.30	272.6	85.73	280.9	86.01	288.9	86.69		
46	210.1	77.48	233.5	79.73	241.9	81.84	245.5	82.52	249.4	82.94	256.7	83.19	264.3	83.84			
48	185.8	75.87	202.8	78.30	210.4	80.26	213.6	80.73	216.9	80.98	223.4	81.30	230.3	81.66			
110	10	211.2	25.50	252.0	31.08	281.3	36.93	289.6	39.97	307.7	43.01	314.9	44.22	336.2	44.94		
	12	211.2	26.29	252.0	32.15	281.3	38.47	289.6	41.08	307.7	44.62	314.9	46.08	336.2	47.12		
	14	211.2	27.11	252.0	33.58	281.3	40.19	289.6	43.12	307.7	46.87	314.9	48.22	336.2	49.22		
	16	211.2	28.08	252.0	34.79	281.3	41.86	289.6	45.01	307.7	49.04	314.9	50.37	336.2	51.26		
	18	211.2	29.11	252.0	36.26	281.3	44.26	289.6	47.40	307.7	51.72	314.9	52.76	336.2	53.73		
	20	211.2	30.15	252.0	38.08	281.3	46.94	289.6	49.58	307.7	54.23	314.9	55.58	336.2	56.47		
	21	211.2	30.83	252.0	39.19	281.3	48.15	289.6	50.90	307.7	55.76	314.9	57.15	336.2	58.05		
	23	211.2	32.86	252.0	42.01	281.3	50.83	289.6	53.76	307.7	58.90	314.9	60.16	336.2	61.15		
	25	211.2	35.11	252.0	44.83	281.3	53.72	289.6	56.83	307.7	62.23	314.9	63.12	332.2	64.41		
	27	211.2	37.51	252.0	47.94	281.3	56.76	289.6	60.15	307.7	64.98	314.9	66.48	327.2	67.62		
	29	211.2	40.04	252.0	51.19	281.3	59.98	289.6	63.69	307.7	68.69	314.9	69.87	323.2	70.91		
	31	211.2	42.58	252.0	54.55	281.3	63.37	289.6	67.48	302.6	72.16	310.9	73.58	318.1	74.34		
	33	211.2	45.40	252.0	58.08	281.3	66.98	289.6	71.51	298.6	76.20	305.9	77.48	313.8	77.91		
	35	211.2	48.22	252.0	62.05	281.3	70.73	289.6	75.77	293.6	80.44	300.8	81.16	308.8	81.59		
	37	211.2	51.11	252.0	65.83	281.3	74.66	285.6	80.27	288.5	84.84	296.8	85.12	303.7	85.37		
	39	211.2	55.08	252.0	69.98	276.2	78.77	280.2	85.87	284.5	89.02	291.4	89.19	299.7	89.27		
	41	206.0	59.08	245.5	74.09	264.6	83.09	268.6	92.88	272.2	92.88	280.2	93.62	287.1	94.37		
	43	200.7	62.05	239.3	77.19	253.4	88.09	257.7	89.09	261.0	88.91	268.6	89.41	275.5	89.66		
46	188.3	60.55	224.5	74.51	231.4	83.62	235.3	83.62	238.3	84.34	245.5	84.80	252.0	85.02			
48	166.3	58.80	194.9	71.80	201.0	79.55	204.6	80.09	207.2	80.48	213.7	80.69	219.1	81.02			

Note

1. TC: Total Capacity(kW), PI : Power Input(kW, Comp. + Outdoor fan motor)
2. Capacity tables show the average value of conditions which may occur.

7. Capacity Tables

Combination (%)	Outdoor air temp (°C DB)	Cooling Capacity(94HP)													
		Indoor air temp. (DB/WB, °C)													
		20		23		26		27		28		30		32	
		14	PI	16	PI	18	PI	19	PI	20	PI	22	PI	24	PI
100	10	177.5	22.97	211.5	27.90	246.2	33.11	263.2	35.79	280.2	38.44	310.6	42.79	317.4	43.15
	12	177.5	23.72	211.5	29.04	246.2	34.22	263.2	36.76	280.2	39.68	310.6	45.11	317.4	45.54
	14	177.5	24.44	211.5	30.22	246.2	35.68	263.2	38.33	280.2	41.40	310.6	47.62	317.4	48.08
	16	177.5	25.18	211.5	31.22	246.2	37.19	263.2	40.15	280.2	43.62	310.6	49.94	317.4	50.62
	18	177.5	25.93	211.5	32.37	246.2	38.65	263.2	42.12	280.2	46.26	310.6	52.76	317.4	53.16
	20	177.5	26.86	211.5	33.61	246.2	40.90	263.2	45.12	280.2	49.48	310.6	55.26	317.4	55.72
	21	177.5	27.43	211.5	34.40	246.2	42.29	263.2	46.65	280.2	51.33	310.6	56.54	317.4	56.98
	23	177.5	29.04	211.5	36.79	246.2	45.40	263.2	50.05	280.2	54.98	310.6	59.19	317.4	59.69
	25	177.5	30.87	211.5	39.19	246.2	48.51	263.2	53.58	280.2	58.80	310.6	61.73	314.6	62.22
	27	177.5	33.00	211.5	41.87	246.2	51.87	263.2	57.23	280.2	62.51	304.4	64.62	310.9	65.15
	29	177.5	35.11	211.5	44.69	246.2	55.40	263.2	61.19	280.2	66.16	299.0	67.23	306.2	67.76
	31	177.5	37.51	211.5	47.65	246.2	59.08	263.2	65.26	280.2	69.51	294.3	69.83	301.5	70.40
	33	177.5	39.76	211.5	50.76	246.2	63.01	263.2	69.65	280.2	72.12	289.6	72.44	296.8	73.01
	35	177.5	42.29	211.5	54.01	246.2	67.12	263.2	74.30	275.9	74.73	284.5	75.05	291.7	75.62
	37	177.5	45.29	211.5	57.91	246.2	71.09	263.2	77.84	271.2	78.23	279.1	78.55	285.6	79.26
	39	177.5	48.58	211.5	62.22	246.2	75.33	263.2	81.66	266.8	82.01	274.7	82.30	280.9	83.09
	41	175.0	51.83	208.2	66.51	242.3	79.58	252.7	85.45	258.1	85.80	264.3	86.09	272.6	86.91
	43	168.8	54.87	201.0	70.51	233.9	83.37	242.2	88.73	244.8	89.02	252.4	89.34	259.2	90.16
46	158.3	59.01	188.4	76.01	219.4	88.44	221.2	92.88	223.4	93.16	230.7	93.41	236.8	94.30	
48	139.9	50.94	166.7	65.76	189.4	75.59	192.0	78.80	194.1	79.05	200.6	79.23	206.1	79.87	
90	10	159.8	19.82	190.9	23.81	222.0	28.07	236.8	30.27	252.0	32.58	283.1	36.45	313.8	40.54
	12	159.8	20.04	190.9	24.19	222.0	28.57	236.8	30.87	252.0	33.29	283.1	37.17	313.8	41.25
	14	159.8	20.43	190.9	24.66	222.0	29.17	236.8	31.48	252.0	33.90	283.1	37.91	313.8	42.10
	16	159.8	20.78	190.9	25.16	222.0	29.77	236.8	32.08	252.0	34.53	283.1	38.62	313.8	42.81
	18	159.8	21.14	190.9	25.65	222.0	30.27	236.8	32.83	252.0	35.25	283.1	39.47	313.8	44.98
	20	159.8	21.50	190.9	26.12	222.0	30.87	236.8	33.43	252.0	36.59	283.1	42.24	313.8	47.11
	21	159.8	21.75	190.9	26.37	222.0	31.48	236.8	34.53	252.0	37.91	283.1	42.92	313.8	48.21
	23	159.8	22.24	190.9	27.47	222.0	33.68	236.8	37.06	252.0	40.61	283.1	45.51	309.5	50.49
	25	159.8	23.34	190.9	29.28	222.0	35.99	236.8	39.62	252.0	43.38	283.1	48.68	305.1	52.62
	27	159.8	24.91	190.9	31.23	222.0	38.41	236.8	42.28	252.0	46.44	283.1	51.73	300.8	55.11
	29	159.8	26.37	190.9	33.29	222.0	41.07	236.8	45.23	252.0	49.60	283.1	54.82	296.1	57.31
	31	159.8	28.07	190.9	35.49	222.0	43.77	236.8	48.14	252.0	52.87	283.1	57.56	291.8	59.55
	33	159.8	29.91	190.9	37.80	222.0	46.68	236.8	51.30	252.0	56.07	283.1	60.33	287.4	61.75
	35	159.8	31.73	190.9	40.11	222.0	49.60	236.8	54.68	252.0	59.48	278.0	63.78	282.7	65.27
	37	159.8	33.68	190.9	42.67	222.0	52.87	236.8	58.09	252.0	62.78	273.7	66.69	278.4	68.18
	39	159.8	35.64	190.9	45.37	222.0	55.96	236.8	61.82	252.0	66.01	269.0	70.31	273.7	71.16
	41	155.8	39.90	185.8	50.31	216.2	61.43	230.7	67.61	245.5	71.27	257.8	74.08	262.5	75.79
	43	151.8	43.06	181.5	54.36	210.8	67.08	225.2	72.83	239.3	76.42	247.3	79.34	251.7	80.30
46	142.4	48.46	169.9	61.90	197.4	76.46	211.1	82.57	217.6	84.88	225.6	87.09	229.9	87.22	
48	125.8	42.35	150.4	54.15	174.6	66.87	186.6	72.02	188.8	73.16	196.3	74.97	199.9	75.07	
80	10	142.1	16.54	169.2	19.89	196.3	23.34	210.4	25.18	224.5	27.00	252.0	30.81	279.1	33.44
	12	142.1	16.90	169.2	20.10	196.3	23.80	210.4	25.62	224.5	27.46	252.0	31.38	279.1	34.11
	14	142.1	17.11	169.2	20.56	196.3	24.12	210.4	26.08	224.5	27.93	252.0	31.95	279.1	34.76
	16	142.1	17.36	169.2	20.92	196.3	24.58	210.4	26.54	224.5	28.50	252.0	32.65	279.1	35.43
	18	142.1	17.71	169.2	21.27	196.3	25.05	210.4	27.00	224.5	29.07	252.0	33.22	279.1	36.21
	20	142.1	18.04	169.2	21.73	196.3	25.62	210.4	27.57	224.5	29.67	252.0	34.47	279.1	38.35
	21	142.1	18.15	169.2	21.95	196.3	25.86	210.4	27.93	224.5	30.34	252.0	35.57	279.1	39.38
	23	142.1	18.50	169.2	22.30	196.3	27.00	210.4	29.67	224.5	32.41	252.0	37.56	279.1	41.34
	25	142.1	19.21	169.2	23.80	196.3	28.96	210.4	31.73	224.5	34.72	252.0	40.20	279.1	44.18
	27	142.1	20.35	169.2	25.29	196.3	30.91	210.4	33.90	224.5	37.00	252.0	42.69	279.1	46.49
	29	142.1	21.60	169.2	27.00	196.3	32.87	210.4	36.11	224.5	39.53	252.0	45.75	279.1	49.77
	31	142.1	22.98	169.2	28.60	196.3	35.04	210.4	38.49	224.5	42.08	252.0	48.56	279.1	52.26
	33	142.1	24.37	169.2	30.56	196.3	37.35	210.4	41.02	224.5	44.82	252.0	51.16	279.1	54.78
	35	142.1	25.86	169.2	32.41	196.3	39.77	210.4	43.68	224.5	47.81	252.0	54.25	276.2	56.77
	37	142.1	27.36	169.2	34.47	196.3	42.19	210.4	46.43	224.5	50.80	252.0	57.24	271.9	59.34
	39	142.1	28.92	169.2	36.43	196.3	45.11	210.4	49.91	224.5	54.60	252.0	60.48	267.2	62.61
	41	138.4	31.98	164.9	40.38	191.3	49.52	205.0	54.71	218.8	59.98	245.5	67.31	256.0	69.37
	43	134.9	35.22	160.9	44.04	186.6	54.07	200.0	59.62	213.6	65.56	239.3	72.04	245.5	74.28
46	126.5	39.17	150.7	49.63	175.0	60.90	187.6	66.38	200.0	73.96	219.1	78.62	224.1	79.90	
48	111.7	34.22	133.4	43.40	154.7	53.26	165.9	57.98	177.1	64.75	190.2	68.05	194.8	68.77	

Note

1. TC: Total Capacity(kW), PI : Power Input(kW, Comp. + Outdoor fan motor)
2. Capacity tables show the average value of conditions which may occur.

7. Capacity Tables

Combination (%)	Outdoor air temp (°C DB)	Cooling Capacity(94HP)													
		Indoor air temp. (DB/WB, °C)													
		20		23		26		27		28		30		32	
		14	16	18	19	20	22	24	24	24	24	24	24	24	24
	TC	PI	TC	PI	TC	PI	TC	PI	TC	PI	TC	PI	TC	PI	
70	10	124.0	14.50	148.6	17.24	172.1	19.98	184.4	21.58	196.3	23.05	219.8	26.25	244.4	29.35
	12	124.0	14.71	148.6	17.45	172.1	20.41	184.4	21.91	196.3	23.51	219.8	26.71	244.4	29.92
	14	124.0	14.96	148.6	17.70	172.1	20.77	184.4	22.26	196.3	23.86	219.8	27.28	244.4	30.45
	16	124.0	15.17	148.6	18.02	172.1	21.12	184.4	22.72	196.3	24.29	219.8	27.74	244.4	31.10
	18	124.0	15.42	148.6	18.38	172.1	21.58	184.4	23.15	196.3	24.76	219.8	28.18	244.4	31.66
	20	124.0	15.64	148.6	18.70	172.1	21.91	184.4	23.62	196.3	25.33	219.8	28.88	244.4	32.87
	21	124.0	15.85	148.6	18.84	172.1	22.15	184.4	23.86	196.3	25.57	219.8	29.32	244.4	33.56
	23	124.0	16.10	148.6	19.27	172.1	22.58	184.4	24.65	196.3	26.82	219.8	31.38	244.4	35.44
	25	124.0	16.31	148.6	19.98	172.1	24.08	184.4	26.36	196.3	28.64	219.8	33.55	244.4	37.15
	27	124.0	17.24	148.6	21.34	172.1	25.68	184.4	27.96	196.3	30.59	219.8	35.83	244.4	39.50
	29	124.0	18.38	148.6	22.58	172.1	27.28	184.4	29.78	196.3	32.52	219.8	38.22	244.4	42.31
	31	124.0	19.52	148.6	24.08	172.1	29.10	184.4	31.84	196.3	34.69	219.8	40.75	244.4	44.88
	33	124.0	20.66	148.6	25.43	172.1	30.92	184.4	33.77	196.3	36.87	219.8	43.35	244.4	47.80
	35	124.0	21.80	148.6	27.18	172.1	32.87	184.4	35.94	196.3	39.25	219.8	46.23	244.4	50.68
	37	124.0	23.15	148.6	28.78	172.1	34.91	184.4	38.22	196.3	41.78	219.8	49.19	244.4	53.47
	39	124.0	24.61	148.6	30.67	172.1	37.33	184.4	41.14	196.3	45.13	219.8	52.64	244.4	57.67
	41	120.8	27.21	144.6	33.59	167.7	40.96	179.7	45.13	191.3	49.05	214.4	57.81	238.2	62.19
	43	117.9	29.60	141.0	36.62	163.4	44.70	175.0	49.19	186.6	53.57	209.0	63.15	232.1	67.25
46	110.6	32.91	132.3	41.18	153.3	50.33	164.1	54.78	175.0	60.38	195.9	71.24	217.6	74.94	
48	97.6	28.71	117.1	35.97	135.6	43.99	145.0	47.87	154.7	52.82	173.2	62.33	192.7	64.86	
60	10	106.3	12.45	126.9	14.62	147.5	17.01	158.0	18.23	168.1	19.37	189.1	21.97	209.7	24.58
	12	106.3	12.70	126.9	14.84	147.5	17.23	158.0	18.47	168.1	19.72	189.1	22.33	209.7	25.04
	14	106.3	12.80	126.9	15.08	147.5	17.55	158.0	18.80	168.1	20.05	189.1	22.79	209.7	25.50
	16	106.3	13.02	126.9	15.41	147.5	17.80	158.0	19.15	168.1	20.51	189.1	23.22	209.7	25.93
	18	106.3	13.27	126.9	15.62	147.5	18.12	158.0	19.48	168.1	20.86	189.1	23.57	209.7	26.50
	20	106.3	13.48	126.9	15.87	147.5	18.47	158.0	19.83	168.1	21.19	189.1	24.01	209.7	27.07
	21	106.3	13.59	126.9	15.98	147.5	18.69	158.0	20.05	168.1	21.40	189.1	24.36	209.7	27.32
	23	106.3	13.84	126.9	16.30	147.5	18.94	158.0	20.40	168.1	21.86	189.1	25.25	209.7	29.00
	25	106.3	14.05	126.9	16.66	147.5	19.72	158.0	21.40	168.1	23.22	189.1	26.96	209.7	31.03
	27	106.3	14.51	126.9	17.55	147.5	20.97	158.0	22.79	168.1	24.71	189.1	28.67	209.7	33.10
	29	106.3	15.41	126.9	18.69	147.5	22.33	158.0	24.25	168.1	26.29	189.1	30.60	209.7	35.34
	31	106.3	16.30	126.9	19.83	147.5	23.68	158.0	25.82	168.1	28.00	189.1	32.63	209.7	37.62
	33	106.3	17.23	126.9	20.97	147.5	25.15	158.0	27.43	168.1	29.78	189.1	34.67	209.7	40.12
	35	106.3	18.23	126.9	22.33	147.5	26.75	158.0	29.11	168.1	31.60	189.1	36.95	209.7	42.59
	37	106.3	19.26	126.9	23.54	147.5	28.32	158.0	30.92	168.1	33.53	189.1	39.20	209.7	45.33
	39	106.3	20.47	126.9	25.07	147.5	30.57	158.0	33.17	168.1	36.09	189.1	42.05	209.7	48.57
	41	103.4	22.22	123.6	27.46	143.9	33.20	154.0	36.24	163.8	39.16	184.0	46.12	204.3	52.78
	43	100.9	24.14	120.7	29.89	140.3	36.20	150.0	39.51	159.8	42.73	179.7	50.36	199.2	57.64
46	94.7	27.03	113.1	33.56	131.6	40.70	140.6	44.40	149.7	48.08	168.1	56.74	186.6	65.66	
48	83.5	23.57	100.1	29.28	116.4	35.56	124.4	38.77	132.7	42.01	148.9	49.61	165.2	57.46	
50	10	88.9	10.68	106.3	12.36	123.3	14.07	131.6	15.07	139.9	15.96	156.9	18.00	175.0	20.03
	12	88.9	10.79	106.3	12.50	123.3	14.28	131.6	15.29	139.9	16.32	156.9	18.32	175.0	20.36
	14	88.9	10.93	106.3	12.71	123.3	14.50	131.6	15.53	139.9	16.53	156.9	18.57	175.0	20.71
	16	88.9	11.14	106.3	12.93	123.3	14.75	131.6	15.86	139.9	16.75	156.9	18.89	175.0	21.03
	18	88.9	11.25	106.3	13.04	123.3	14.96	131.6	16.07	139.9	17.10	156.9	19.25	175.0	21.50
	20	88.9	11.36	106.3	13.28	123.3	15.29	131.6	16.32	139.9	17.43	156.9	19.57	175.0	21.93
	21	88.9	11.46	106.3	13.39	123.3	15.42	131.6	16.53	139.9	17.54	156.9	19.79	175.0	22.14
	23	88.9	11.71	106.3	13.61	123.3	15.64	131.6	16.75	139.9	17.89	156.9	20.14	175.0	22.61
	25	88.9	11.82	106.3	13.82	123.3	15.96	131.6	17.10	139.9	18.46	156.9	21.14	175.0	24.18
	27	88.9	12.03	106.3	14.28	123.3	16.86	131.6	18.21	139.9	19.57	156.9	22.61	175.0	25.75
	29	88.9	12.71	106.3	15.18	123.3	17.89	131.6	19.35	139.9	20.82	156.9	23.96	175.0	27.32
	31	88.9	13.39	106.3	16.07	123.3	19.00	131.6	20.46	139.9	22.14	156.9	25.53	175.0	29.14
	33	88.9	14.18	106.3	17.00	123.3	20.14	131.6	21.71	139.9	23.50	156.9	27.11	175.0	31.04
	35	88.9	14.96	106.3	18.00	123.3	21.25	131.6	23.07	139.9	24.86	156.9	28.68	175.0	32.96
	37	88.9	15.86	106.3	19.00	123.3	22.50	131.6	24.39	139.9	26.32	156.9	30.60	175.0	34.99
	39	88.9	16.93	106.3	20.39	123.3	24.11	131.6	26.28	139.9	28.25	156.9	32.60	175.0	37.78
	41	86.4	18.29	103.4	22.07	120.0	26.36	128.3	28.46	136.3	30.60	152.9	35.71	170.3	41.03
	43	84.3	19.89	100.9	24.00	117.1	28.68	125.1	31.00	133.1	33.32	149.3	38.96	166.3	44.75
46	79.2	22.28	94.7	26.92	109.6	32.18	117.1	34.79	124.7	37.39	139.9	43.82	155.8	50.39	
48	70.1	19.39	83.5	23.46	96.9	28.07	103.7	30.36	110.3	32.64	123.7	38.29	137.7	44.04	

Note

1. TC: Total Capacity(kW), PI : Power Input(kW, Comp. + Outdoor fan motor)
2. Capacity tables show the average value of conditions which may occur.

7. Capacity Tables

◆ A(C)RUN960LLS5

Combination (%)	Outdoor air temp (°C DB)	Indoor air temp. (DB/WB, °C)														Cooling Capacity(96HP)	
		20		23		26		27		28		30		32		TC	PI
		14		16		18		19		20		22		24			
		TC	PI	TC	PI	TC	PI	TC	PI	TC	PI	TC	PI	TC	PI		
130	10	266.2	31.68	317.2	38.72	339.7	44.93	349.6	45.83	359.3	46.22	376.6	46.58	386.2	46.76		
	12	266.2	32.47	317.2	40.11	339.7	46.76	349.6	47.08	359.3	47.44	376.6	47.84	386.2	48.27		
	14	266.2	33.58	317.2	41.55	339.7	48.52	349.6	48.88	359.3	49.27	376.6	49.67	386.2	50.10		
	16	266.2	34.80	317.2	43.02	339.7	50.71	349.6	51.18	359.3	51.57	376.6	52.04	386.2	52.47		
	18	266.2	36.24	317.2	45.50	339.7	53.04	349.6	54.19	359.3	54.62	376.6	55.16	386.2	55.52		
	20	266.2	37.85	317.2	48.48	339.7	55.66	349.6	59.58	359.3	60.08	371.1	60.66	381.0	61.09		
	21	266.2	38.83	317.2	50.17	339.7	56.82	349.6	63.06	359.3	63.57	369.2	64.21	378.8	64.64		
	23	266.2	41.66	317.2	52.79	339.7	59.76	349.6	69.60	354.8	70.14	363.7	70.85	373.3	71.33		
	25	266.2	44.50	317.2	55.81	339.7	63.86	345.3	77.18	349.6	77.79	359.3	78.58	369.2	79.12		
	27	266.2	47.62	317.2	59.69	335.6	68.06	339.7	84.97	345.3	85.65	354.8	86.48	363.7	87.09		
	29	266.2	50.75	317.2	63.78	330.1	73.23	334.9	93.38	339.7	93.95	349.6	94.78	359.3	95.14		
	31	266.2	54.16	316.1	67.19	324.6	77.89	330.1	92.98	334.9	93.55	344.1	94.38	353.7	94.74		
	33	266.2	57.68	310.5	71.21	320.5	83.53	325.6	92.12	330.1	92.69	339.7	93.52	348.5	93.88		
	35	266.2	61.52	305.0	74.56	314.9	90.47	320.5	90.93	325.6	91.47	334.5	92.30	344.1	92.66		
	37	266.2	65.61	300.9	78.25	310.5	89.28	314.9	89.75	320.5	90.28	329.0	91.08	338.9	91.44		
	39	266.2	69.85	295.4	82.35	305.0	88.09	310.5	88.53	314.9	89.06	324.6	89.86	334.5	90.21		
	41	259.5	74.09	283.2	86.48	292.8	86.91	297.2	87.34	303.1	87.85	312.0	88.64	320.5	88.99		
	43	252.9	78.15	271.4	85.26	281.0	85.69	285.1	86.12	290.9	86.66	299.8	87.41	307.9	87.77		
46	237.1	83.65	247.7	83.50	256.6	83.90	260.7	84.33	265.9	84.83	274.3	85.58	282.1	85.94			
48	209.7	81.31	214.9	81.56	223.0	81.74	226.7	81.96	231.5	82.67	238.9	83.21	245.5	83.53			
120	10	240.8	28.51	286.5	34.95	313.1	41.55	322.7	44.89	332.0	45.61	350.1	45.79	358.6	46.15		
	12	240.8	29.27	286.5	36.13	313.1	43.20	322.7	45.83	332.0	47.30	350.1	47.87	358.6	48.23		
	14	240.8	30.28	286.5	37.35	313.1	44.96	322.7	47.58	332.0	49.02	350.1	49.74	358.6	50.14		
	16	240.8	31.39	286.5	38.89	313.1	46.69	322.7	49.35	332.0	51.29	350.1	51.93	358.6	52.33		
	18	240.8	32.61	286.5	40.65	313.1	48.56	322.7	51.96	332.0	53.91	350.1	54.52	358.6	54.98		
	20	240.8	33.83	286.5	43.10	313.1	51.18	322.7	54.66	332.0	56.78	350.1	57.53	358.6	57.97		
	21	240.8	34.87	286.5	44.64	313.1	52.61	322.7	56.28	332.0	58.65	350.1	59.40	358.6	59.87		
	23	240.8	37.28	286.5	47.77	313.1	56.35	322.7	59.80	332.0	62.52	350.1	63.14	358.6	63.64		
	25	240.8	39.83	286.5	51.18	313.1	59.44	322.7	63.75	332.0	67.05	346.0	67.59	354.4	68.13		
	27	240.8	42.52	286.5	54.70	313.1	63.28	322.7	68.13	332.0	72.04	340.8	72.54	349.3	73.12		
	29	240.8	45.36	286.5	58.40	313.1	66.58	322.7	72.90	326.8	76.78	335.3	77.93	344.9	78.58		
	31	240.8	48.34	286.5	62.38	313.1	70.03	318.3	78.08	322.7	82.38	331.2	83.82	339.4	84.50		
	33	240.8	51.46	286.5	66.48	308.7	74.06	313.1	84.76	317.2	88.45	325.7	89.46	334.2	90.18		
	35	240.8	54.70	286.5	70.86	303.5	78.40	307.6	93.38	313.1	93.84	321.6	94.13	330.1	94.88		
	37	240.8	58.86	286.5	74.77	299.1	83.57	303.5	91.40	307.6	91.87	316.1	92.15	324.9	92.87		
	39	240.8	63.35	285.4	79.04	293.9	88.64	298.3	89.53	302.4	90.00	312.0	90.25	320.5	90.97		
	41	234.8	67.87	272.9	83.29	282.1	86.91	286.2	87.66	290.2	88.10	298.7	88.35	307.2	89.06		
	43	228.9	72.44	261.4	82.10	270.6	84.97	274.4	85.76	278.4	86.19	286.9	86.48	295.0	87.16		
46	214.5	77.89	238.5	80.16	247.0	82.28	250.7	82.96	254.7	83.39	262.2	83.64	269.9	84.29			
48	189.8	76.28	207.1	78.72	214.9	80.69	218.2	81.17	221.5	81.42	228.2	81.74	235.2	82.10			
110	10	215.7	25.64	257.3	31.25	287.3	37.13	295.7	40.19	314.2	43.24	321.6	44.46	343.4	45.18		
	12	215.7	26.43	257.3	32.32	287.3	38.68	295.7	41.30	314.2	44.86	321.6	46.33	343.4	47.37		
	14	215.7	27.26	257.3	33.76	287.3	40.40	295.7	43.35	314.2	47.12	321.6	48.48	343.4	49.49		
	16	215.7	28.23	257.3	34.98	287.3	42.09	295.7	45.25	314.2	49.31	321.6	50.64	343.4	51.54		
	18	215.7	29.27	257.3	36.45	287.3	44.50	295.7	47.66	314.2	52.00	321.6	53.04	343.4	54.02		
	20	215.7	30.31	257.3	38.28	287.3	47.19	295.7	49.85	314.2	54.52	321.6	55.88	343.4	56.78		
	21	215.7	30.99	257.3	39.40	287.3	48.41	295.7	51.18	314.2	56.06	321.6	57.46	343.4	58.36		
	23	215.7	33.04	257.3	42.24	287.3	51.11	295.7	54.05	314.2	59.22	321.6	60.48	343.4	61.48		
	25	215.7	35.30	257.3	45.07	287.3	54.01	295.7	57.14	314.2	62.56	321.6	63.46	339.3	64.75		
	27	215.7	37.71	257.3	48.20	287.3	57.07	295.7	60.48	314.2	65.33	321.6	66.83	334.2	67.98		
	29	215.7	40.26	257.3	51.46	287.3	60.30	295.7	64.03	314.2	69.06	321.6	70.25	330.1	71.29		
	31	215.7	42.81	257.3	54.84	287.3	63.71	295.7	67.84	309.1	72.55	317.5	73.98	324.9	74.74		
	33	215.7	45.65	257.3	58.40	287.3	67.34	295.7	71.90	305.0	76.61	312.4	77.90	320.5	78.33		
	35	215.7	48.48	257.3	62.38	287.3	71.11	295.7	76.17	299.8	80.87	307.2	81.60	315.3	82.02		
	37	215.7	51.39	257.3	66.19	287.3	75.06	291.7	80.70	294.6	85.29	303.1	85.58	310.2	85.83		
	39	215.7	55.38	257.3	70.35	282.1	79.19	286.2	86.33	290.6	89.50	297.6	89.67	306.1	89.75		
	41	210.4	59.40	250.7	74.48	270.2	83.53	274.3	93.38	278.0	93.38	286.1	94.13	293.2	94.88		
	43	205.0	62.38	244.4	77.61	258.8	88.56	263.2	89.57	266.6	89.39	274.4	89.89	281.4	90.14		
46	192.3	60.87	229.3	74.92	236.3	84.07	240.4	84.07	243.3	84.79	250.7	85.26	257.4	85.48			
48	169.9	59.12	199.0	72.18	205.3	79.98	209.0	80.52	211.6	80.91	218.2	81.13	223.8	81.45			

Note

1. TC: Total Capacity(kW), PI : Power Input(kW, Comp. + Outdoor fan motor)
2. Capacity tables show the average value of conditions which may occur.

7. Capacity Tables

Combination (%)	Outdoor air temp (°C DB)	Cooling Capacity(96HP)													
		Indoor air temp. (DB/WB, °C)													
		20		23		26		27		28		30		32	
		14	16	18	19	20	22	24							
	TC	PI	TC	PI	TC	PI	TC	PI	TC	PI	TC	PI	TC	PI	
100	10	181.3	23.09	216.0	28.05	251.5	33.29	268.8	35.98	286.1	38.64	317.2	43.03	324.2	43.38
	12	181.3	23.84	216.0	29.20	251.5	34.41	268.8	36.95	286.1	39.90	317.2	45.36	324.2	45.79
	14	181.3	24.57	216.0	30.38	251.5	35.88	268.8	38.54	286.1	41.62	317.2	47.87	324.2	48.34
	16	181.3	25.32	216.0	31.39	251.5	37.39	268.8	40.37	286.1	43.85	317.2	50.20	324.2	50.89
	18	181.3	26.07	216.0	32.54	251.5	38.86	268.8	42.34	286.1	46.51	317.2	53.04	324.2	53.44
	20	181.3	27.01	216.0	33.79	251.5	41.12	268.8	45.36	286.1	49.74	317.2	55.56	324.2	56.02
	21	181.3	27.58	216.0	34.58	251.5	42.52	268.8	46.91	286.1	51.61	317.2	56.85	324.2	57.28
	23	181.3	29.20	216.0	36.99	251.5	45.65	268.8	50.32	286.1	55.27	317.2	59.51	324.2	60.01
	25	181.3	31.03	216.0	39.40	251.5	48.77	268.8	53.87	286.1	59.11	317.2	62.06	324.2	62.56
	27	181.3	33.18	216.0	42.09	251.5	52.15	268.8	57.54	286.1	62.85	310.9	64.97	317.5	65.50
	29	181.3	35.30	216.0	44.93	251.5	55.70	268.8	61.52	286.1	66.51	305.3	67.59	312.7	68.13
	31	181.3	37.71	216.0	47.91	251.5	59.40	268.8	65.62	286.1	69.89	300.6	70.21	307.9	70.78
	33	181.3	39.97	216.0	51.03	251.5	63.35	268.8	70.03	286.1	72.51	295.8	72.83	303.1	73.41
	35	181.3	42.52	216.0	54.30	251.5	67.48	268.8	74.70	281.7	75.13	290.6	75.45	297.9	76.03
	37	181.3	45.54	216.0	58.22	251.5	71.47	268.8	78.26	277.0	78.65	285.0	78.97	291.7	79.69
	39	181.3	48.84	216.0	62.56	251.5	75.74	268.8	82.10	272.5	82.46	280.6	82.75	286.9	83.53
	41	178.7	52.11	212.7	66.87	247.4	80.01	258.1	85.91	263.6	86.26	269.9	86.55	278.4	87.37
	43	172.4	55.16	205.3	70.89	238.9	83.82	247.4	89.21	250.0	89.50	257.8	89.82	264.7	90.65
46	161.7	59.33	192.4	76.42	224.1	88.92	225.9	93.38	228.2	93.66	235.6	93.92	241.9	94.81	
48	142.9	51.21	170.2	66.12	193.5	76.00	196.1	79.23	198.3	79.48	204.9	79.66	210.4	80.30	
90	10	163.2	20.21	194.9	24.27	226.7	28.61	241.9	30.85	257.3	33.21	289.1	37.16	320.5	41.32
	12	163.2	20.43	194.9	24.66	226.7	29.12	241.9	31.47	257.3	33.94	289.1	37.88	320.5	42.05
	14	163.2	20.82	194.9	25.14	226.7	29.73	241.9	32.09	257.3	34.55	289.1	38.64	320.5	42.91
	16	163.2	21.19	194.9	25.64	226.7	30.35	241.9	32.70	257.3	35.20	289.1	39.37	320.5	43.64
	18	163.2	21.55	194.9	26.15	226.7	30.85	241.9	33.46	257.3	35.93	289.1	40.23	320.5	45.85
	20	163.2	21.91	194.9	26.62	226.7	31.47	241.9	34.08	257.3	37.30	289.1	43.06	320.5	48.02
	21	163.2	22.17	194.9	26.87	226.7	32.09	241.9	35.20	257.3	38.64	289.1	43.75	320.5	49.14
	23	163.2	22.67	194.9	27.99	226.7	34.33	241.9	37.77	257.3	41.39	289.1	46.39	316.1	51.46
	25	163.2	23.79	194.9	29.84	226.7	36.68	241.9	40.38	257.3	44.22	289.1	49.61	311.6	53.64
	27	163.2	25.39	194.9	31.83	226.7	39.15	241.9	43.10	257.3	47.33	289.1	52.73	307.2	56.17
	29	163.2	26.87	194.9	33.94	226.7	41.87	241.9	46.10	257.3	50.55	289.1	55.88	302.4	58.42
	31	163.2	28.61	194.9	36.18	226.7	44.61	241.9	49.07	257.3	53.89	289.1	58.67	298.0	60.69
	33	163.2	30.49	194.9	38.53	226.7	47.58	241.9	52.29	257.3	57.15	289.1	61.49	293.5	62.94
	35	163.2	32.34	194.9	40.89	226.7	50.55	241.9	55.74	257.3	60.62	283.9	65.01	288.8	66.52
	37	163.2	34.33	194.9	43.49	226.7	53.89	241.9	59.21	257.3	63.99	279.5	67.97	284.3	69.50
	39	163.2	36.33	194.9	46.25	226.7	57.04	241.9	63.01	257.3	67.29	274.7	71.67	279.5	72.54
	41	159.1	40.67	189.8	51.28	220.8	62.61	235.6	68.92	250.7	72.65	263.3	75.51	268.1	77.25
	43	155.1	43.89	185.3	55.41	215.3	68.38	230.0	74.24	244.4	77.90	252.5	80.87	257.0	81.85
46	145.5	49.40	173.5	63.09	201.6	77.93	215.6	84.16	222.3	86.52	230.4	88.76	234.8	88.91	
48	128.5	43.17	153.6	55.19	178.4	68.16	190.5	73.41	192.8	74.57	200.5	76.41	204.2	76.52	
80	10	145.1	16.87	172.8	20.27	200.5	23.79	214.9	25.67	229.3	27.53	257.3	31.41	285.1	34.09
	12	145.1	17.23	172.8	20.49	200.5	24.26	214.9	26.12	229.3	28.00	257.3	31.99	285.1	34.78
	14	145.1	17.45	172.8	20.96	200.5	24.59	214.9	26.59	229.3	28.47	257.3	32.57	285.1	35.44
	16	145.1	17.70	172.8	21.33	200.5	25.06	214.9	27.06	229.3	29.05	257.3	33.29	285.1	36.12
	18	145.1	18.06	172.8	21.69	200.5	25.53	214.9	27.53	229.3	29.63	257.3	33.87	285.1	36.92
	20	145.1	18.39	172.8	22.16	200.5	26.12	214.9	28.11	229.3	30.24	257.3	35.14	285.1	39.10
	21	145.1	18.50	172.8	22.38	200.5	26.37	214.9	28.47	229.3	30.94	257.3	36.27	285.1	40.15
	23	145.1	18.86	172.8	22.74	200.5	27.53	214.9	30.24	229.3	33.04	257.3	38.30	285.1	42.14
	25	145.1	19.58	172.8	24.26	200.5	29.52	214.9	32.35	229.3	35.40	257.3	40.98	285.1	45.04
	27	145.1	20.74	172.8	25.78	200.5	31.52	214.9	34.56	229.3	37.72	257.3	43.52	285.1	47.40
	29	145.1	22.02	172.8	27.53	200.5	33.51	214.9	36.81	229.3	40.30	257.3	46.64	285.1	50.74
	31	145.1	23.43	172.8	29.16	200.5	35.73	214.9	39.24	229.3	42.90	257.3	49.50	285.1	53.27
	33	145.1	24.84	172.8	31.16	200.5	38.08	214.9	41.82	229.3	45.70	257.3	52.15	285.1	55.85
	35	145.1	26.37	172.8	33.04	200.5	40.55	214.9	44.53	229.3	48.74	257.3	55.31	282.1	57.88
	37	145.1	27.89	172.8	35.14	200.5	43.01	214.9	47.33	229.3	51.79	257.3	58.36	277.6	60.50
	39	145.1	29.48	172.8	37.14	200.5	45.99	214.9	50.88	229.3	55.67	257.3	61.66	272.9	63.83
	41	141.4	32.60	168.4	41.16	195.4	50.48	209.4	55.78	223.4	61.15	250.7	68.62	261.4	70.72
	43	137.7	35.90	164.3	44.90	190.6	55.12	204.2	60.79	218.2	66.84	244.4	73.44	250.7	75.73
46	129.2	39.93	154.0	50.59	178.7	62.09	191.6	67.67	204.2	75.40	223.7	80.15	228.9	81.45	
48	114.1	34.89	136.2	44.24	158.0	54.29	169.5	59.11	180.9	66.01	194.2	69.38	199.0	70.11	

Note

1. TC: Total Capacity(kW), PI : Power Input(kW, Comp. + Outdoor fan motor)
2. Capacity tables show the average value of conditions which may occur.

7. Capacity Tables

Combination (%)	Outdoor air temp (°C DB)	Cooling Capacity(96HP)													
		Indoor air temp. (DB/WB, °C)													
		20		23		26		27		28		30		32	
		14	16	18	19	20	22	24	24	24	24	24	24	24	24
	TC	PI	TC	PI	TC	PI	TC	PI	TC	PI	TC	PI	TC	PI	
70	10	126.7	14.78	151.7	17.58	175.7	20.37	188.3	22.01	200.5	23.50	224.5	26.77	249.6	29.93
	12	126.7	15.00	151.7	17.80	175.7	20.81	188.3	22.34	200.5	23.97	224.5	27.24	249.6	30.51
	14	126.7	15.25	151.7	18.05	175.7	21.18	188.3	22.70	200.5	24.33	224.5	27.82	249.6	31.05
	16	126.7	15.47	151.7	18.38	175.7	21.54	188.3	23.17	200.5	24.77	224.5	28.29	249.6	31.71
	18	126.7	15.72	151.7	18.74	175.7	22.01	188.3	23.61	200.5	25.24	224.5	28.73	249.6	32.29
	20	126.7	15.94	151.7	19.07	175.7	22.34	188.3	24.08	200.5	25.83	224.5	29.45	249.6	33.52
	21	126.7	16.16	151.7	19.21	175.7	22.59	188.3	24.33	200.5	26.08	224.5	29.89	249.6	34.22
	23	126.7	16.42	151.7	19.65	175.7	23.03	188.3	25.13	200.5	27.35	224.5	32.00	249.6	36.14
	25	126.7	16.64	151.7	20.37	175.7	24.55	188.3	26.88	200.5	29.20	224.5	34.21	249.6	37.88
	27	126.7	17.58	151.7	21.76	175.7	26.19	188.3	28.51	200.5	31.20	224.5	36.54	249.6	40.28
	29	126.7	18.74	151.7	23.03	175.7	27.82	188.3	30.37	200.5	33.16	224.5	38.97	249.6	43.15
	31	126.7	19.90	151.7	24.55	175.7	29.67	188.3	32.47	200.5	35.38	224.5	41.55	249.6	45.77
	33	126.7	21.07	151.7	25.94	175.7	31.53	188.3	34.43	200.5	37.59	224.5	44.21	249.6	48.74
	35	126.7	22.23	151.7	27.71	175.7	33.52	188.3	36.65	200.5	40.03	224.5	47.14	249.6	51.68
	37	126.7	23.61	151.7	29.35	175.7	35.60	188.3	38.97	200.5	42.60	224.5	50.16	249.6	54.52
	39	126.7	25.10	151.7	31.27	175.7	38.07	188.3	41.95	200.5	46.02	224.5	53.68	249.6	58.80
	41	123.4	27.75	147.7	34.25	171.3	41.77	183.5	46.02	195.4	50.01	218.9	58.95	243.3	63.42
	43	120.4	30.18	144.0	37.34	166.9	45.58	178.7	50.16	190.6	54.62	213.4	64.40	237.1	68.57
46	110.0	33.56	135.1	41.99	156.5	51.32	167.6	55.86	178.7	61.56	200.1	72.64	222.3	76.42	
48	99.7	29.27	119.6	36.68	138.5	44.86	148.1	48.82	158.0	53.86	176.9	63.56	196.8	66.14	
60	10	108.5	12.70	129.6	14.91	150.7	17.35	161.3	18.59	171.7	19.75	193.1	22.41	214.1	25.06
	12	108.5	12.95	129.6	15.13	150.7	17.57	161.3	18.84	171.7	20.11	193.1	22.77	214.1	25.54
	14	108.5	13.06	129.6	15.38	150.7	17.90	161.3	19.17	171.7	20.44	193.1	23.24	214.1	26.01
	16	108.5	13.28	129.6	15.71	150.7	18.15	161.3	19.53	171.7	20.92	193.1	23.68	214.1	26.45
	18	108.5	13.53	129.6	15.93	150.7	18.48	161.3	19.86	171.7	21.28	193.1	24.04	214.1	27.03
	20	108.5	13.75	129.6	16.19	150.7	18.84	161.3	20.22	171.7	21.61	193.1	24.48	214.1	27.61
	21	108.5	13.86	129.6	16.30	150.7	19.06	161.3	20.44	171.7	21.83	193.1	24.84	214.1	27.86
	23	108.5	14.11	129.6	16.63	150.7	19.31	161.3	20.81	171.7	22.30	193.1	25.76	214.1	29.57
	25	108.5	14.33	129.6	16.99	150.7	20.11	161.3	21.83	171.7	23.68	193.1	27.50	214.1	31.65
	27	108.5	14.80	129.6	17.90	150.7	21.39	161.3	23.24	171.7	25.20	193.1	29.24	214.1	33.75
	29	108.5	15.71	129.6	19.06	150.7	22.77	161.3	24.73	171.7	26.81	193.1	31.21	214.1	36.05
	31	108.5	16.63	129.6	20.22	150.7	24.15	161.3	26.34	171.7	28.55	193.1	33.28	214.1	38.37
	33	108.5	17.57	129.6	21.39	150.7	25.65	161.3	27.97	171.7	30.38	193.1	35.36	214.1	40.92
	35	108.5	18.59	129.6	22.77	150.7	27.28	161.3	29.68	171.7	32.23	193.1	37.68	214.1	43.43
	37	108.5	19.64	129.6	24.01	150.7	28.88	161.3	31.54	171.7	34.19	193.1	39.98	214.1	46.23
	39	108.5	20.88	129.6	25.57	150.7	31.17	161.3	33.83	171.7	36.81	193.1	42.88	214.1	49.54
	41	105.6	22.66	126.3	28.01	146.9	33.86	157.3	36.96	167.3	39.94	188.0	47.04	208.6	53.83
	43	103.0	24.63	123.3	30.48	143.3	36.92	153.2	40.30	163.2	43.58	183.5	51.36	203.4	58.78
46	96.7	27.57	115.5	34.23	134.4	41.51	143.6	45.29	152.9	49.03	171.7	57.87	190.5	66.97	
48	85.3	24.04	102.2	29.86	118.9	36.27	127.0	39.54	135.5	42.85	152.1	50.60	168.7	58.60	
50	10	90.8	10.89	108.5	12.61	125.9	14.35	134.4	15.37	142.9	16.29	160.3	18.36	178.7	20.43
	12	90.8	11.00	108.5	12.75	125.9	14.57	134.4	15.59	142.9	16.65	160.3	18.69	178.7	20.77
	14	90.8	11.14	108.5	12.97	125.9	14.79	134.4	15.84	142.9	16.87	160.3	18.94	178.7	21.13
	16	90.8	11.36	108.5	13.19	125.9	15.04	134.4	16.18	142.9	17.09	160.3	19.27	178.7	21.46
	18	90.8	11.48	108.5	13.30	125.9	15.26	134.4	16.40	142.9	17.45	160.3	19.63	178.7	21.93
	20	90.8	11.59	108.5	13.55	125.9	15.59	134.4	16.65	142.9	17.78	160.3	19.96	178.7	22.37
	21	90.8	11.70	108.5	13.66	125.9	15.73	134.4	16.87	142.9	17.89	160.3	20.18	178.7	22.59
	23	90.8	11.95	108.5	13.88	125.9	15.96	134.4	17.09	142.9	18.25	160.3	20.55	178.7	23.06
	25	90.8	12.06	108.5	14.10	125.9	16.29	134.4	17.45	142.9	18.83	160.3	21.57	178.7	24.66
	27	90.8	12.28	108.5	14.57	125.9	17.20	134.4	18.58	142.9	19.96	160.3	23.06	178.7	26.27
	29	90.8	12.97	108.5	15.48	125.9	18.25	134.4	19.74	142.9	21.24	160.3	24.44	178.7	27.87
	31	90.8	13.66	108.5	16.40	125.9	19.38	134.4	20.88	142.9	22.59	160.3	26.05	178.7	29.73
	33	90.8	14.46	108.5	17.34	125.9	20.55	134.4	22.15	142.9	23.97	160.3	27.65	178.7	31.66
	35	90.8	15.26	108.5	18.36	125.9	21.68	134.4	23.53	142.9	25.36	160.3	29.25	178.7	33.62
	37	90.8	16.18	108.5	19.38	125.9	22.95	134.4	24.88	142.9	26.85	160.3	31.22	178.7	35.70
	39	90.8	17.27	108.5	20.80	125.9	24.59	134.4	26.81	142.9	28.82	160.3	33.26	178.7	38.54
	41	88.3	18.65	105.6	22.51	122.6	26.89	131.1	29.03	139.2	31.22	156.2	36.43	173.9	41.86
	43	86.1	20.29	103.0	24.48	119.6	29.25	127.7	31.62	135.9	33.99	152.5	39.74	169.8	45.65
46	80.8	22.73	96.7	27.47	111.9	32.82	119.6	35.48	127.4	38.14	142.9	44.70	159.1	51.40	
48	71.6	19.78	85.3	23.94	99.0	28.63	106.0	30.97	112.6	33.30	126.3	39.06	140.7	44.92	

Note

1. TC: Total Capacity(kW), PI : Power Input(kW, Comp. + Outdoor fan motor)
2. Capacity tables show the average value of conditions which may occur.

7. Capacity Tables

◆ A(C)RUN980LLS5

Combination (%)	Outdoor air temp (°C DB)	Indoor air temp. (DB/WB, °C)														Cooling Capacity(98HP)	
		20		23		26		27		28		30		32		TC	PI
		14		16		18		19		20		22		24			
		TC	PI	TC	PI	TC	PI	TC	PI	TC	PI	TC	PI	TC	PI		
130	10	271.8	32.44	323.8	39.65	346.8	46.01	356.9	46.93	366.8	47.33	384.5	47.70	394.3	47.89		
	12	271.8	33.25	323.8	41.08	346.8	47.89	356.9	48.22	366.8	48.59	384.5	48.99	394.3	49.43		
	14	271.8	34.38	323.8	42.56	346.8	49.69	356.9	50.06	366.8	50.46	384.5	50.86	394.3	51.31		
	16	271.8	35.64	323.8	44.06	346.8	51.93	356.9	52.41	366.8	52.82	384.5	53.29	394.3	53.73		
	18	271.8	37.11	323.8	46.60	346.8	54.32	356.9	55.50	366.8	55.94	384.5	56.49	394.3	56.86		
	20	271.8	38.76	323.8	49.65	346.8	57.00	356.9	61.02	366.8	61.53	378.8	62.12	389.0	62.56		
	21	271.8	39.76	323.8	51.38	346.8	58.18	356.9	64.58	366.8	65.10	376.9	65.76	386.7	66.20		
	23	271.8	42.67	323.8	54.06	346.8	61.20	356.9	71.28	362.2	71.83	371.3	72.56	381.1	73.04		
	25	271.8	45.57	323.8	57.16	346.8	65.40	352.5	79.04	356.9	79.66	366.8	80.47	376.9	81.02		
	27	271.8	48.77	323.8	61.12	342.6	69.70	346.8	87.02	352.5	87.72	362.2	88.57	371.3	89.19		
	29	271.8	51.97	323.8	65.32	337.0	74.99	341.9	95.63	346.8	96.21	356.9	97.06	366.8	97.43		
	31	271.8	55.46	322.6	68.81	331.3	79.77	337.0	95.22	341.9	95.81	351.3	96.65	361.1	97.02		
	33	271.8	59.07	317.0	72.93	327.1	85.55	332.4	94.34	337.0	94.93	346.8	95.77	355.8	96.14		
	35	271.8	63.00	311.4	76.35	321.5	92.65	327.1	93.12	332.4	93.68	341.5	94.52	351.3	94.89		
	37	271.8	67.19	307.2	80.14	317.0	91.43	321.5	91.91	327.1	92.46	335.8	93.27	346.0	93.64		
	39	271.8	71.54	301.6	84.34	311.4	90.22	317.0	90.66	321.5	91.21	331.3	92.02	341.5	92.39		
	41	264.9	75.88	289.1	88.56	298.9	89.00	303.4	89.44	309.4	89.96	318.5	90.77	327.2	91.14		
	43	258.2	80.03	277.0	87.31	286.8	87.76	291.0	88.20	297.0	88.74	306.0	89.52	314.3	89.89		
	46	242.0	85.66	252.9	85.51	262.0	85.92	266.1	86.36	271.4	86.87	280.1	87.65	287.9	88.01		
	48	214.1	83.27	219.4	83.53	227.7	83.71	231.4	83.93	236.3	84.66	243.9	85.21	250.6	85.55		
120	10	245.8	29.20	292.5	35.79	319.6	42.55	329.4	45.97	338.9	46.71	357.4	46.89	366.0	47.26		
	12	245.8	29.98	292.5	37.00	319.6	44.25	329.4	46.93	338.9	48.44	357.4	49.02	366.0	49.40		
	14	245.8	31.01	292.5	38.25	319.6	46.05	329.4	48.73	338.9	50.20	357.4	50.94	366.0	51.34		
	16	245.8	32.14	292.5	39.83	319.6	47.81	329.4	50.54	338.9	52.52	357.4	53.18	366.0	53.59		
	18	245.8	33.39	292.5	41.63	319.6	49.73	329.4	53.22	338.9	55.21	357.4	55.83	366.0	56.31		
	20	245.8	34.65	292.5	44.13	319.6	52.41	329.4	55.98	338.9	58.15	357.4	58.92	366.0	59.36		
	21	245.8	35.71	292.5	45.72	319.6	53.88	329.4	57.63	338.9	60.06	357.4	60.83	366.0	61.31		
	23	245.8	38.18	292.5	48.92	319.6	57.71	329.4	61.24	338.9	64.03	357.4	64.66	366.0	65.18		
	25	245.8	40.79	292.5	52.41	319.6	60.87	329.4	65.28	338.9	68.66	353.2	69.22	361.8	69.77		
	27	245.8	43.55	292.5	56.02	319.6	64.80	329.4	69.77	338.9	73.78	347.9	74.29	356.5	74.88		
	29	245.8	46.45	292.5	59.80	319.6	68.19	329.4	74.66	333.6	78.63	342.3	79.81	352.0	80.47		
	31	245.8	49.50	292.5	63.88	319.6	71.72	324.9	79.96	329.4	84.37	338.1	85.84	346.4	86.54		
	33	245.8	52.70	292.5	68.08	315.1	75.84	319.6	86.80	323.8	90.58	332.5	91.61	341.1	92.35		
	35	245.8	56.02	292.5	72.57	309.8	80.29	314.0	95.63	319.6	96.10	328.3	96.40	336.9	97.17		
	37	245.8	60.28	292.5	76.58	305.3	85.59	309.8	93.60	314.0	94.08	322.7	94.37	331.7	95.11		
	39	245.8	64.88	291.4	80.95	300.0	90.77	304.5	91.69	308.7	92.16	318.5	92.43	327.2	93.16		
	41	239.7	69.51	278.6	85.29	288.0	89.00	292.1	89.78	296.3	90.22	304.9	90.48	313.6	91.21		
	43	233.7	74.18	266.9	84.08	276.3	87.02	280.1	87.83	284.2	88.27	292.8	88.56	301.2	89.26		
	46	219.0	79.77	243.5	82.09	252.2	84.26	255.9	84.96	260.0	85.40	267.6	85.65	275.6	86.32		
	48	193.7	78.12	211.4	80.62	219.3	82.64	222.7	83.12	226.1	83.38	232.9	83.71	240.1	84.07		
110	10	220.2	26.26	262.7	32.00	293.3	38.03	301.9	41.16	320.8	44.28	328.3	45.53	350.5	46.27		
	12	220.2	27.07	262.7	33.10	293.3	39.61	301.9	42.30	320.8	45.94	328.3	47.44	350.5	48.51		
	14	220.2	27.92	262.7	34.57	293.3	41.38	301.9	44.39	320.8	48.26	328.3	49.65	350.5	50.68		
	16	220.2	28.91	262.7	35.83	293.3	43.10	301.9	46.34	320.8	50.50	328.3	51.86	350.5	52.78		
	18	220.2	29.98	262.7	37.33	293.3	45.57	301.9	48.81	320.8	53.26	328.3	54.32	350.5	55.32		
	20	220.2	31.04	262.7	39.20	293.3	48.33	301.9	51.05	320.8	55.83	328.3	57.23	350.5	58.15		
	21	220.2	31.74	262.7	40.35	293.3	49.58	301.9	52.41	320.8	57.41	328.3	58.85	350.5	59.77		
	23	220.2	33.83	262.7	43.25	293.3	52.34	301.9	55.35	320.8	60.65	328.3	61.94	350.5	62.97		
	25	220.2	36.15	262.7	46.16	293.3	55.31	301.9	58.51	320.8	64.07	328.3	64.99	346.4	66.31		
	27	220.2	38.62	262.7	49.36	293.3	58.44	301.9	61.93	320.8	66.90	328.3	68.45	341.1	69.62		
	29	220.2	41.23	262.7	52.70	293.3	61.75	301.9	65.58	320.8	70.72	328.3	71.94	336.9	73.01		
	31	220.2	43.84	262.7	56.16	293.3	65.25	301.9	69.48	315.5	74.30	324.1	75.76	331.7	76.54		
	33	220.2	46.75	262.7	59.80	293.3	68.96	301.9	73.63	311.3	78.45	318.9	79.77	327.2	80.21		
	35	220.2	49.65	262.7	63.88	293.3	72.82	301.9	78.01	306.1	82.82	313.6	83.56	321.9	84.00		
	37	220.2	52.63	262.7	67.78	293.3	76.87	297.7	82.64	300.8	87.35	309.4	87.64	316.6	87.90		
	39	220.2	56.72	262.7	72.05	288.0	81.10	292.1	88.41	296.6	91.66	303.8	91.83	312.5	91.91		
	41	214.8	60.83	255.9	76.28	275.9	85.55	280.1	95.63	283.8	95.63	292.1	96.40	299.3	97.17		
	43	209.2	63.88	249.5	79.48	264.2	90.70	268.7	91.73	272.1	91.54	280.1	92.06	287.2	92.31		
	46	196.3	62.34	234.0	76.72	241.2	86.10	245.4	86.10	248.4	86.83	256.0	87.31	262.7	87.54		
	48	173.4	60.54	203.2	73.92	209.5	81.91	213.3	82.46	216.0	82.86	222.8	83.08	228.5	83.41		

Note

- TC: Total Capacity(kW), PI: Power Input(kW, Comp. + Outdoor fan motor)
- Capacity tables show the average value of conditions which may occur.

7. Capacity Tables

Combination (%)	Outdoor air temp (°C DB)	Cooling Capacity(98HP)													
		Indoor air temp. (DB/WB, °C)													
		20		23		26		27		28		30		32	
		14	16	18	19	20	22	24							
	TC	PI	TC	PI	TC	PI	TC	PI	TC	PI	TC	PI	TC	PI	
100	10	185.1	23.65	220.5	28.73	256.7	34.09	274.4	36.85	292.1	39.58	323.8	44.06	330.9	44.43
	12	185.1	24.42	220.5	29.90	256.7	35.24	274.4	37.84	292.1	40.86	323.8	46.45	330.9	46.89
	14	185.1	25.16	220.5	31.11	256.7	36.74	274.4	39.47	292.1	42.62	323.8	49.03	330.9	49.50
	16	185.1	25.93	220.5	32.14	256.7	38.29	274.4	41.34	292.1	44.91	323.8	51.41	330.9	52.12
	18	185.1	26.70	220.5	33.32	256.7	39.79	274.4	43.36	292.1	47.63	323.8	54.32	330.9	54.73
	20	185.1	27.66	220.5	34.61	256.7	42.11	274.4	46.45	292.1	50.94	323.8	56.90	330.9	57.37
	21	185.1	28.24	220.5	35.42	256.7	43.55	274.4	48.04	292.1	52.85	323.8	58.22	330.9	58.66
	23	185.1	29.90	220.5	37.88	256.7	46.75	274.4	51.53	292.1	56.60	323.8	60.94	330.9	61.45
	25	185.1	31.78	220.5	40.35	256.7	49.94	274.4	55.17	292.1	60.54	323.8	63.55	328.0	64.07
	27	185.1	33.98	220.5	43.11	256.7	53.41	274.4	58.92	292.1	64.36	317.4	66.53	324.2	67.08
	29	185.1	36.15	220.5	46.01	256.7	57.04	274.4	63.00	292.1	68.11	311.7	69.22	319.3	69.77
	31	185.1	38.62	220.5	49.06	256.7	60.83	274.4	67.20	292.1	71.57	306.8	71.90	314.4	72.49
	33	185.1	40.93	220.5	52.26	256.7	64.88	274.4	71.72	292.1	74.26	301.9	74.59	309.5	75.18
	35	185.1	43.55	220.5	55.61	256.7	69.11	274.4	76.50	287.6	76.94	296.6	77.27	304.1	77.86
	37	185.1	46.64	220.5	59.62	256.7	73.19	274.4	80.14	282.7	80.54	291.0	80.87	297.8	81.61
	39	185.1	50.02	220.5	64.07	256.7	77.57	274.4	84.07	278.2	84.44	286.4	84.74	292.9	85.55
	41	182.4	53.37	217.1	68.48	252.6	81.94	263.4	87.98	269.1	88.34	275.5	88.64	284.2	89.48
	43	176.0	56.49	209.6	72.60	243.9	85.84	252.5	91.36	255.2	91.66	263.1	91.98	270.2	92.83
46	165.1	60.76	196.4	78.27	228.8	91.06	230.6	95.63	232.9	95.92	240.5	96.18	246.9	97.10	
48	145.9	52.45	173.8	67.71	197.5	77.83	200.2	81.13	202.4	81.39	209.2	81.58	214.8	82.24	
90	10	166.6	20.59	199.0	24.73	231.4	29.16	246.9	31.44	262.7	33.84	295.1	37.87	327.2	42.11
	12	166.6	20.82	199.0	25.13	231.4	29.67	246.9	32.07	262.7	34.58	295.1	38.61	327.2	42.85
	14	166.6	21.22	199.0	25.62	231.4	30.30	246.9	32.70	262.7	35.21	295.1	39.38	327.2	43.73
	16	166.6	21.59	199.0	26.13	231.4	30.93	246.9	33.33	262.7	35.87	295.1	40.12	327.2	44.47
	18	166.6	21.96	199.0	26.64	231.4	31.44	246.9	34.10	262.7	36.61	295.1	41.00	327.2	46.72
	20	166.6	22.33	199.0	27.13	231.4	32.07	246.9	34.73	262.7	38.01	295.1	43.88	327.2	48.94
	21	166.6	22.59	199.0	27.39	231.4	32.70	246.9	35.87	262.7	39.38	295.1	44.58	327.2	50.08
	23	166.6	23.10	199.0	28.53	231.4	34.98	246.9	38.49	262.7	42.18	295.1	47.28	322.7	52.44
	25	166.6	24.25	199.0	30.41	231.4	37.38	246.9	41.15	262.7	45.06	295.1	50.56	318.1	54.66
	27	166.6	25.87	199.0	32.44	231.4	39.89	246.9	43.92	262.7	48.23	295.1	53.74	313.6	57.24
	29	166.6	27.39	199.0	34.58	231.4	42.66	246.9	46.98	262.7	51.52	295.1	56.94	308.7	59.53
	31	166.6	29.16	199.0	36.87	231.4	45.46	246.9	50.00	262.7	54.92	295.1	59.78	304.2	61.85
	33	166.6	31.07	199.0	39.27	231.4	48.49	246.9	53.29	262.7	58.24	295.1	62.67	299.6	64.14
	35	166.6	32.96	199.0	41.67	231.4	51.52	246.9	56.80	262.7	61.78	289.9	66.25	294.8	67.79
	37	166.6	34.98	199.0	44.32	231.4	54.92	246.9	60.34	262.7	65.21	285.3	69.27	290.2	70.82
	39	166.6	37.02	199.0	47.13	231.4	58.13	246.9	64.22	262.7	68.57	280.5	73.03	285.4	73.92
	41	162.4	41.44	193.8	52.26	225.4	63.81	240.5	70.23	255.9	74.03	268.8	76.95	273.6	78.72
	43	158.3	44.73	189.2	56.47	219.8	69.68	234.8	75.65	249.5	79.38	257.8	82.41	262.4	83.41
46	148.5	50.34	177.2	64.29	205.8	79.42	220.1	85.77	226.9	88.17	235.2	90.46	239.7	90.60	
48	131.2	43.99	156.8	56.24	182.1	69.46	194.5	74.81	196.8	75.99	204.6	77.87	208.4	77.98	
80	10	148.1	17.22	176.4	20.69	204.7	24.28	219.4	26.21	234.1	28.10	262.7	32.06	291.0	34.80
	12	148.1	17.58	176.4	20.92	204.7	24.76	219.4	26.66	234.1	28.58	262.7	32.65	291.0	35.50
	14	148.1	17.81	176.4	21.40	204.7	25.10	219.4	27.14	234.1	29.06	262.7	33.24	291.0	36.17
	16	148.1	18.06	176.4	21.77	204.7	25.58	219.4	27.62	234.1	29.65	262.7	33.98	291.0	36.87
	18	148.1	18.43	176.4	22.14	204.7	26.06	219.4	28.10	234.1	30.25	262.7	34.57	291.0	37.68
	20	148.1	18.77	176.4	22.62	204.7	26.66	219.4	28.69	234.1	30.87	262.7	35.87	291.0	39.91
	21	148.1	18.88	176.4	22.84	204.7	26.91	219.4	29.06	234.1	31.58	262.7	37.02	291.0	40.98
	23	148.1	19.25	176.4	23.21	204.7	28.10	219.4	30.87	234.1	33.72	262.7	39.09	291.0	43.01
	25	148.1	19.99	176.4	24.76	204.7	30.13	219.4	33.02	234.1	36.13	262.7	41.83	291.0	45.98
	27	148.1	21.17	176.4	26.32	204.7	32.17	219.4	35.28	234.1	38.50	262.7	44.43	291.0	48.38
	29	148.1	22.47	176.4	28.10	204.7	34.21	219.4	37.57	234.1	41.13	262.7	47.61	291.0	51.79
	31	148.1	23.92	176.4	29.77	204.7	36.47	219.4	40.06	234.1	43.79	262.7	50.53	291.0	54.38
	33	148.1	25.36	176.4	31.80	204.7	38.87	219.4	42.69	234.1	46.64	262.7	53.23	291.0	57.01
	35	148.1	26.91	176.4	33.72	204.7	41.39	219.4	45.46	234.1	49.75	262.7	56.45	288.0	59.08
	37	148.1	28.47	176.4	35.87	204.7	43.90	219.4	48.31	234.1	52.86	262.7	59.57	283.4	61.75
	39	148.1	30.09	176.4	37.91	204.7	46.94	219.4	51.94	234.1	56.82	262.7	62.93	278.6	65.15
	41	144.3	33.28	171.9	42.02	199.4	51.53	213.8	56.94	228.1	62.42	255.9	70.04	266.9	72.19
	43	140.6	36.65	167.7	45.83	194.5	56.27	208.5	62.05	222.7	68.22	249.5	74.96	255.9	77.29
46	131.9	40.76	157.2	51.64	182.4	63.38	195.6	69.08	208.5	76.96	228.4	81.81	233.7	83.14	
48	116.5	35.61	139.1	45.16	161.3	55.42	173.0	60.34	184.7	67.38	198.3	70.82	203.1	71.56	

Note

1. TC: Total Capacity(kW), PI : Power Input(kW, Comp. + Outdoor fan motor)
2. Capacity tables show the average value of conditions which may occur.

7. Capacity Tables

Combination (%)	Outdoor air temp (°C DB)	Cooling Capacity(98HP)													
		Indoor air temp. (DB/WB, °C)													
		20		23		26		27		28		30		32	
		14	16	18	19	20	22	24	24	24	22	24			
	TC	PI	TC	PI	TC	PI	TC	PI	TC	PI	TC	PI	TC	PI	
70	10	129.3	15.11	154.9	17.97	179.4	20.83	192.2	22.50	204.7	24.03	229.2	27.37	254.8	30.60
	12	129.3	15.34	154.9	18.20	179.4	21.28	192.2	22.84	204.7	24.51	229.2	27.85	254.8	31.19
	14	129.3	15.59	154.9	18.45	179.4	21.65	192.2	23.21	204.7	24.88	229.2	28.44	254.8	31.75
	16	129.3	15.82	154.9	18.79	179.4	22.02	192.2	23.69	204.7	25.33	229.2	28.92	254.8	32.42
	18	129.3	16.08	154.9	19.16	179.4	22.50	192.2	24.14	204.7	25.81	229.2	29.38	254.8	33.01
	20	129.3	16.30	154.9	19.50	179.4	22.84	192.2	24.62	204.7	26.40	229.2	30.11	254.8	34.27
	21	129.3	16.53	154.9	19.64	179.4	23.09	192.2	24.88	204.7	26.66	229.2	30.56	254.8	34.98
	23	129.3	16.78	154.9	20.09	179.4	23.55	192.2	25.70	204.7	27.96	229.2	32.72	254.8	36.95
	25	129.3	17.01	154.9	20.83	179.4	25.10	192.2	27.48	204.7	29.86	229.2	34.98	254.8	38.73
	27	129.3	17.97	154.9	22.24	179.4	26.77	192.2	29.15	204.7	31.90	229.2	37.36	254.8	41.18
	29	129.3	19.16	154.9	23.55	179.4	28.44	192.2	31.05	204.7	33.90	229.2	39.85	254.8	44.11
	31	129.3	20.35	154.9	25.10	179.4	30.34	192.2	33.20	204.7	36.17	229.2	42.48	254.8	46.79
	33	129.3	21.54	154.9	26.52	179.4	32.23	192.2	35.21	204.7	38.43	229.2	45.20	254.8	49.83
	35	129.3	22.73	154.9	28.33	179.4	34.27	192.2	37.47	204.7	40.92	229.2	48.20	254.8	52.84
	37	129.3	24.14	154.9	30.00	179.4	36.39	192.2	39.85	204.7	43.56	229.2	51.28	254.8	55.74
	39	129.3	25.66	154.9	31.97	179.4	38.92	192.2	42.89	204.7	47.05	229.2	54.88	254.8	60.12
	41	125.9	28.37	150.8	35.02	174.9	42.70	187.3	47.05	199.4	51.13	223.5	60.27	248.4	64.84
	43	122.9	30.86	147.0	38.18	170.4	46.60	182.5	51.28	194.5	55.85	217.9	65.84	242.0	70.11
46	115.3	34.31	137.9	42.93	159.8	52.47	171.1	57.11	182.4	62.94	204.3	74.27	226.9	78.13	
48	101.8	29.93	122.1	37.50	141.3	45.86	151.2	49.91	161.3	55.07	180.6	64.99	200.9	67.62	
60	10	110.8	13.00	132.3	15.27	153.8	17.77	164.7	19.04	175.3	20.23	197.1	22.95	218.6	25.67
	12	110.8	13.26	132.3	15.50	153.8	17.99	164.7	19.29	175.3	20.60	197.1	23.32	218.6	26.15
	14	110.8	13.37	132.3	15.75	153.8	18.33	164.7	19.63	175.3	20.94	197.1	23.80	218.6	26.63
	16	110.8	13.60	132.3	16.09	153.8	18.59	164.7	20.00	175.3	21.42	197.1	24.25	218.6	27.09
	18	110.8	13.86	132.3	16.32	153.8	18.93	164.7	20.34	175.3	21.79	197.1	24.62	218.6	27.68
	20	110.8	14.08	132.3	16.58	153.8	19.29	164.7	20.71	175.3	22.13	197.1	25.07	218.6	28.28
	21	110.8	14.19	132.3	16.69	153.8	19.52	164.7	20.94	175.3	22.35	197.1	25.44	218.6	28.53
	23	110.8	14.45	132.3	17.03	153.8	19.78	164.7	21.31	175.3	22.84	197.1	26.38	218.6	30.29
	25	110.8	14.68	132.3	17.40	153.8	20.60	164.7	22.35	175.3	24.25	197.1	28.16	218.6	32.41
	27	110.8	15.16	132.3	18.33	153.8	21.90	164.7	23.80	175.3	25.81	197.1	29.95	218.6	34.57
	29	110.8	16.09	132.3	19.52	153.8	23.32	164.7	25.33	175.3	27.45	197.1	31.96	218.6	36.92
	31	110.8	17.03	132.3	20.71	153.8	24.73	164.7	26.97	175.3	29.24	197.1	34.08	218.6	39.30
	33	110.8	17.99	132.3	21.90	153.8	26.26	164.7	28.64	175.3	31.11	197.1	36.21	218.6	41.90
	35	110.8	19.04	132.3	23.32	153.8	27.94	164.7	30.40	175.3	33.01	197.1	38.59	218.6	44.48
	37	110.8	20.12	132.3	24.59	153.8	29.58	164.7	32.30	175.3	35.02	197.1	40.94	218.6	47.34
	39	110.8	21.38	132.3	26.19	153.8	31.93	164.7	34.65	175.3	37.70	197.1	43.92	218.6	50.73
	41	107.8	23.21	128.9	28.68	150.0	34.68	160.5	37.85	170.8	40.91	191.9	48.17	213.0	55.13
	43	105.2	25.22	125.9	31.22	146.2	37.81	156.4	41.27	166.6	44.63	187.3	52.60	207.7	60.20
46	98.7	28.24	117.9	35.05	137.2	42.51	146.6	46.38	156.1	50.21	175.3	59.27	194.5	68.58	
48	87.1	24.62	104.4	30.58	121.3	37.14	129.7	40.50	138.3	43.88	155.3	51.82	172.2	60.01	
50	10	92.7	11.18	110.8	12.93	128.5	14.72	137.2	15.77	145.9	16.71	163.6	18.83	182.4	20.96
	12	92.7	11.29	110.8	13.08	128.5	14.95	137.2	16.00	145.9	17.08	163.6	19.17	182.4	21.30
	14	92.7	11.43	110.8	13.30	128.5	15.17	137.2	16.25	145.9	17.30	163.6	19.43	182.4	21.67
	16	92.7	11.66	110.8	13.53	128.5	15.43	137.2	16.59	145.9	17.53	163.6	19.77	182.4	22.01
	18	92.7	11.77	110.8	13.64	128.5	15.66	137.2	16.82	145.9	17.90	163.6	20.14	182.4	22.49
	20	92.7	11.88	110.8	13.90	128.5	16.00	137.2	17.08	145.9	18.24	163.6	20.48	182.4	22.95
	21	92.7	12.00	110.8	14.01	128.5	16.14	137.2	17.30	145.9	18.35	163.6	20.71	182.4	23.17
	23	92.7	12.25	110.8	14.24	128.5	16.37	137.2	17.53	145.9	18.72	163.6	21.08	182.4	23.66
	25	92.7	12.37	110.8	14.47	128.5	16.71	137.2	17.90	145.9	19.32	163.6	22.12	182.4	25.30
	27	92.7	12.59	110.8	14.95	128.5	17.64	137.2	19.06	145.9	20.48	163.6	23.66	182.4	26.95
	29	92.7	13.30	110.8	15.88	128.5	18.72	137.2	20.25	145.9	21.79	163.6	25.08	182.4	28.59
	31	92.7	14.01	110.8	16.82	128.5	19.88	137.2	21.42	145.9	23.17	163.6	26.72	182.4	30.49
	33	92.7	14.84	110.8	17.79	128.5	21.08	137.2	22.72	145.9	24.59	163.6	28.37	182.4	32.48
	35	92.7	15.66	110.8	18.83	128.5	22.24	137.2	24.14	145.9	26.01	163.6	30.01	182.4	34.49
	37	92.7	16.59	110.8	19.88	128.5	23.54	137.2	25.53	145.9	27.54	163.6	32.02	182.4	36.62
	39	92.7	17.71	110.8	21.34	128.5	25.23	137.2	27.50	145.9	29.56	163.6	34.12	182.4	39.54
	41	90.1	19.14	107.8	23.09	125.1	27.58	133.8	29.78	142.1	32.03	159.4	37.37	177.5	42.94
	43	87.9	20.81	105.2	25.11	122.1	30.01	130.4	32.44	138.7	34.87	155.6	40.77	173.4	46.83
46	82.5	23.32	98.7	28.17	114.2	33.67	122.1	36.40	130.0	39.13	145.8	45.86	162.4	52.73	
48	73.1	20.30	87.1	24.55	101.0	29.37	108.2	31.77	115.0	34.16	128.9	40.07	143.6	46.08	

Note

1. TC: Total Capacity(kW), PI : Power Input(kW, Comp. + Outdoor fan motor)
2. Capacity tables show the average value of conditions which may occur.

7. Capacity Tables

◆ A(C)RUN1000LLS5

Combination (%)	Outdoor air temp (°C DB)	Cooling Capacity(100HP)													
		Indoor air temp. (DB/WB, °C)													
		20		23		26		27		28		30		32	
		14	16	18	19	20	22	24	TC	PI	TC	PI	TC	PI	
130	10	277.3	33.59	330.4	41.05	353.9	47.63	364.2	48.59	374.2	49.00	392.3	49.38	402.3	49.58
	12	277.3	34.42	330.4	42.53	353.9	49.58	364.2	49.92	374.2	50.30	392.3	50.72	402.3	51.17
	14	277.3	35.60	330.4	44.06	353.9	51.44	364.2	51.82	374.2	52.24	392.3	52.66	402.3	53.12
	16	277.3	36.89	330.4	45.61	353.9	53.76	364.2	54.26	374.2	54.68	392.3	55.18	402.3	55.63
	18	277.3	38.42	330.4	48.24	353.9	56.24	364.2	57.45	374.2	57.91	392.3	58.48	402.3	58.87
	20	277.3	40.13	330.4	51.40	353.9	59.02	364.2	63.17	374.2	63.70	386.6	64.31	396.9	64.77
	21	277.3	41.16	330.4	53.20	353.9	60.24	364.2	66.86	374.2	67.40	384.6	68.08	394.6	68.54
	23	277.3	44.17	330.4	55.97	353.9	63.36	364.2	73.79	369.6	74.37	378.8	75.12	388.9	75.62
	25	277.3	47.18	330.4	59.17	353.9	67.70	359.7	81.83	364.2	82.48	374.2	83.31	384.6	83.88
	27	277.3	50.49	330.4	63.28	349.6	72.15	353.9	90.09	359.7	90.81	369.6	91.69	378.8	92.34
	29	277.3	53.80	330.4	67.63	343.8	77.64	348.8	99.00	353.9	99.61	364.2	100.49	374.2	100.87
	31	277.3	57.42	329.2	71.24	338.1	82.59	343.8	98.58	348.8	99.19	358.5	100.07	368.5	100.45
	33	277.3	61.15	323.5	75.50	333.8	88.57	339.2	97.67	343.8	98.28	353.9	99.15	363.0	99.53
	35	277.3	65.23	317.7	79.05	328.1	95.92	333.8	96.41	339.2	96.98	348.4	97.86	358.5	98.24
	37	277.3	69.56	313.4	82.97	323.5	94.66	328.1	95.15	333.8	95.72	342.7	96.56	353.0	96.94
	39	277.3	74.06	307.7	87.31	317.7	93.40	323.5	93.86	328.1	94.43	338.1	95.27	348.4	95.65
	41	270.4	78.56	295.0	91.69	305.0	92.14	309.6	92.60	315.7	93.14	325.0	93.98	333.9	94.35
	43	263.5	82.86	282.7	90.40	292.7	90.85	296.9	91.31	303.0	91.88	312.3	92.68	320.8	93.06
	46	246.9	88.68	258.0	88.53	267.3	88.95	271.5	89.41	277.0	89.94	285.8	90.74	293.8	91.12
	48	218.5	86.21	223.9	86.47	232.3	86.66	236.1	86.89	241.1	87.65	248.8	88.22	255.8	88.56
120	10	250.8	30.23	298.4	37.05	326.1	44.05	336.1	47.60	345.8	48.36	364.6	48.55	373.5	48.93
	12	250.8	31.03	298.4	38.31	326.1	45.81	336.1	48.59	345.8	50.14	364.6	50.75	373.5	51.14
	14	250.8	32.10	298.4	39.60	326.1	47.67	336.1	50.45	345.8	51.97	364.6	52.74	373.5	53.16
	16	250.8	33.28	298.4	41.24	326.1	49.50	336.1	52.32	345.8	54.37	364.6	55.06	373.5	55.48
	18	250.8	34.57	298.4	43.10	326.1	51.48	336.1	55.09	345.8	57.16	364.6	57.80	373.5	58.29
	20	250.8	35.87	298.4	45.69	326.1	54.26	336.1	57.96	345.8	60.20	364.6	61.00	373.5	61.46
	21	250.8	36.97	298.4	47.33	326.1	55.78	336.1	59.67	345.8	62.18	364.6	62.98	373.5	63.47
	23	250.8	39.52	298.4	50.64	326.1	59.75	336.1	63.40	345.8	66.29	364.6	66.94	373.5	67.48
	25	250.8	42.23	298.4	54.26	326.1	63.02	336.1	67.59	345.8	71.09	360.4	71.66	369.2	72.24
	27	250.8	45.08	298.4	58.00	326.1	67.09	336.1	72.23	345.8	76.38	355.0	76.91	363.8	77.52
	29	250.8	48.09	298.4	61.91	326.1	70.59	336.1	77.29	340.4	81.41	349.2	82.63	359.2	83.31
	31	250.8	51.25	298.4	66.14	326.1	74.25	331.6	82.78	336.1	87.35	345.0	88.87	353.5	89.59
	33	250.8	54.56	298.4	70.48	321.6	78.52	326.1	89.86	330.4	93.78	339.3	94.85	348.1	95.61
	35	250.8	58.00	298.4	75.13	316.2	83.12	320.4	99.00	326.1	99.50	335.0	99.80	343.8	100.60
	37	250.8	62.41	298.4	79.28	311.6	88.61	316.2	96.91	320.4	97.40	329.3	97.70	338.4	98.47
	39	250.8	67.17	297.3	83.81	306.2	93.98	310.7	94.93	315.0	95.42	325.0	95.69	333.8	96.45
	41	244.6	71.96	284.3	88.30	293.9	92.14	298.1	92.94	302.3	93.40	311.2	93.67	320.0	94.43
	43	238.5	76.80	272.3	87.05	281.9	90.09	285.8	90.93	290.0	91.39	298.8	91.69	307.3	92.41
	46	223.5	82.59	248.5	84.99	257.3	87.24	261.2	87.96	265.3	88.41	273.1	88.68	281.2	89.37
	48	197.7	80.88	215.8	83.47	223.8	85.55	227.3	86.05	230.7	86.32	237.7	86.67	245.0	87.04
110	10	224.7	27.19	268.1	33.13	299.3	39.37	308.0	42.61	327.3	45.85	335.0	47.14	357.7	47.90
	12	224.7	28.03	268.1	34.27	299.3	41.01	308.0	43.79	327.3	47.56	335.0	49.12	357.7	50.23
	14	224.7	28.90	268.1	35.79	299.3	42.84	308.0	45.96	327.3	49.96	335.0	51.40	357.7	52.47
	16	224.7	29.93	268.1	37.09	299.3	44.63	308.0	47.98	327.3	52.28	335.0	53.69	357.7	54.64
	18	224.7	31.04	268.1	38.65	299.3	47.18	308.0	50.53	327.3	55.14	335.0	56.24	357.7	57.27
	20	224.7	32.14	268.1	40.59	299.3	50.04	308.0	52.85	327.3	57.80	335.0	59.25	357.7	60.20
	21	224.7	32.86	268.1	41.77	299.3	51.33	308.0	54.26	327.3	59.44	335.0	60.92	357.7	61.88
	23	224.7	35.03	268.1	44.78	299.3	54.19	308.0	57.30	327.3	62.79	335.0	64.12	357.7	65.19
	25	224.7	37.43	268.1	47.79	299.3	57.26	308.0	60.58	327.3	66.33	335.0	67.28	353.4	68.65
	27	224.7	39.98	268.1	51.10	299.3	60.50	308.0	64.12	327.3	69.26	335.0	70.86	348.1	72.08
	29	224.7	42.68	268.1	54.56	299.3	63.93	308.0	67.89	327.3	73.22	335.0	74.48	343.8	75.59
	31	224.7	45.39	268.1	58.15	299.3	67.55	308.0	71.93	322.0	76.92	330.7	78.44	338.4	79.24
	33	224.7	48.39	268.1	61.91	299.3	71.39	308.0	76.23	317.7	81.22	325.4	82.59	333.9	83.04
	35	224.7	51.40	268.1	66.14	299.3	75.39	308.0	80.76	312.3	85.75	320.0	86.51	328.5	86.96
	37	224.7	54.48	268.1	70.18	299.3	79.58	303.8	85.56	306.9	90.43	315.7	90.74	323.1	91.00
	39	224.7	58.72	268.1	74.59	293.9	83.96	298.1	91.53	302.7	94.89	310.0	95.08	318.8	95.16
	41	219.2	62.98	261.2	78.97	281.5	88.56	285.8	99.00	289.6	99.00	298.0	99.80	305.4	100.60
	43	213.5	66.14	254.6	82.28	269.6	93.90	274.2	94.96	277.7	94.77	285.8	95.30	293.1	95.57
	46	200.3	64.54	238.8	79.43	246.1	89.13	250.4	89.13	253.5	89.90	261.2	90.39	268.1	90.62
	48	177.0	62.68	207.3	76.53	213.8	84.80	217.7	85.37	220.4	85.78	227.3	86.02	233.1	86.36

Note

1. TC: Total Capacity(kW), PI : Power Input(kW, Comp. + Outdoor fan motor)
2. Capacity tables show the average value of conditions which may occur.

7. Capacity Tables

Combination (%)	Outdoor air temp (°C DB)	Cooling Capacity(100HP)													
		Indoor air temp. (DB/WB, °C)													
		20		23		26		27		28		30		32	
		14	16	18	19	20	22	24	TC	PI	TC	PI	TC	PI	
100	10	188.9	24.48	225.0	29.74	261.9	35.30	280.0	38.15	298.1	40.97	330.4	45.62	337.7	45.99
	12	188.9	25.28	225.0	30.96	261.9	36.48	280.0	39.18	298.1	42.30	330.4	48.09	337.7	48.55
	14	188.9	26.05	225.0	32.21	261.9	38.04	280.0	40.86	298.1	44.13	330.4	50.76	337.7	51.25
	16	188.9	26.85	225.0	33.28	261.9	39.64	280.0	42.80	298.1	46.49	330.4	53.23	337.7	53.96
	18	188.9	27.64	225.0	34.50	261.9	41.20	280.0	44.89	298.1	49.31	330.4	56.24	337.7	56.66
	20	188.9	28.63	225.0	35.83	261.9	43.59	280.0	48.09	298.1	52.74	330.4	58.91	337.7	59.40
	21	188.9	29.24	225.0	36.67	261.9	45.08	280.0	49.73	298.1	54.71	330.4	60.27	337.7	60.74
	23	188.9	30.96	225.0	39.22	261.9	48.39	280.0	53.35	298.1	58.60	330.4	63.10	337.7	63.62
	25	188.9	32.90	225.0	41.77	261.9	51.71	280.0	57.11	298.1	62.67	330.4	65.80	334.7	66.33
	27	188.9	35.18	225.0	44.63	261.9	55.29	280.0	61.00	298.1	66.63	323.9	68.88	330.8	69.45
	29	188.9	37.43	225.0	47.64	261.9	59.06	280.0	65.23	298.1	70.52	318.0	71.66	325.8	72.23
	31	188.9	39.98	225.0	50.79	261.9	62.98	280.0	69.57	298.1	74.10	313.1	74.44	320.8	75.05
	33	188.9	42.38	225.0	54.11	261.9	67.17	280.0	74.25	298.1	76.88	308.1	77.22	315.8	77.83
	35	188.9	45.08	225.0	57.57	261.9	71.54	280.0	79.20	293.5	79.66	302.7	80.00	310.4	80.61
	37	188.9	48.28	225.0	61.73	261.9	75.77	280.0	82.97	288.5	83.39	296.9	83.73	303.9	84.49
	39	188.9	51.78	225.0	66.33	261.9	80.30	280.0	87.04	283.8	87.42	292.3	87.73	298.9	88.56
	41	186.1	55.25	221.5	70.90	257.7	84.83	268.8	91.08	274.6	91.46	281.1	91.77	290.0	92.64
	43	179.6	58.48	213.8	75.16	248.9	88.87	257.7	94.58	260.4	94.89	268.5	95.23	275.7	96.11
46	168.4	62.90	200.4	81.03	233.4	94.28	235.3	99.00	237.7	99.30	245.4	99.57	251.9	100.52	
48	148.9	54.30	177.3	70.10	201.5	80.57	204.3	84.00	206.5	84.27	213.4	84.46	219.2	85.14	
90	10	170.0	21.25	203.1	25.52	236.1	30.09	251.9	32.45	268.1	34.93	301.1	39.08	333.9	43.46
	12	170.0	21.49	203.1	25.94	236.1	30.62	251.9	33.10	268.1	35.69	301.1	39.84	333.9	44.22
	14	170.0	21.90	203.1	26.44	236.1	31.27	251.9	33.75	268.1	36.34	301.1	40.64	333.9	45.13
	16	170.0	22.28	203.1	26.97	236.1	31.92	251.9	34.39	268.1	37.02	301.1	41.40	333.9	45.90
	18	170.0	22.66	203.1	27.50	236.1	32.45	251.9	35.19	268.1	37.78	301.1	42.32	333.9	48.22
	20	170.0	23.05	203.1	28.00	236.1	33.10	251.9	35.84	268.1	39.23	301.1	45.29	333.9	50.51
	21	170.0	23.31	203.1	28.26	236.1	33.75	251.9	37.02	268.1	40.64	301.1	46.01	333.9	51.68
	23	170.0	23.84	203.1	29.44	236.1	36.10	251.9	39.73	268.1	43.53	301.1	48.79	329.3	54.12
	25	170.0	25.02	203.1	31.39	236.1	38.58	251.9	42.47	268.1	46.51	301.1	52.18	324.6	56.41
	27	170.0	26.70	203.1	33.48	236.1	41.17	251.9	45.33	268.1	49.78	301.1	55.46	320.0	59.07
	29	170.0	28.26	203.1	35.69	236.1	44.03	251.9	48.48	268.1	53.17	301.1	58.77	315.0	61.44
	31	170.0	30.09	203.1	38.05	236.1	46.92	251.9	51.61	268.1	56.68	301.1	61.70	310.4	63.83
	33	170.0	32.07	203.1	40.53	236.1	50.05	251.9	55.00	268.1	60.11	301.1	64.67	305.7	66.20
	35	170.0	34.01	203.1	43.00	236.1	53.17	251.9	58.62	268.1	63.76	295.8	68.37	300.8	69.97
	37	170.0	36.10	203.1	45.74	236.1	56.68	251.9	62.28	268.1	67.30	291.1	71.49	296.1	73.09
	39	170.0	38.21	203.1	48.64	236.1	59.99	251.9	66.28	268.1	70.77	286.2	75.38	291.2	76.29
	41	165.7	42.77	197.7	53.93	230.0	65.85	245.4	72.48	261.2	76.40	274.3	79.42	279.2	81.24
	43	161.5	46.16	193.0	58.28	224.2	71.91	239.6	78.08	254.6	81.93	263.1	85.05	267.7	86.08
46	151.5	51.95	180.8	66.35	210.0	81.96	224.6	88.52	231.5	91.00	240.0	93.36	244.6	93.51	
48	133.9	45.40	160.0	58.05	185.8	71.69	198.5	77.21	200.8	78.42	208.8	80.37	212.7	80.48	
80	10	151.1	17.71	180.0	21.29	208.9	24.98	223.9	26.96	238.9	28.91	268.1	32.98	296.9	35.80
	12	151.1	18.09	180.0	21.52	208.9	25.47	223.9	27.42	238.9	29.40	268.1	33.59	296.9	36.52
	14	151.1	18.32	180.0	22.01	208.9	25.82	223.9	27.92	238.9	29.89	268.1	34.20	296.9	37.21
	16	151.1	18.58	180.0	22.39	208.9	26.32	223.9	28.41	238.9	30.50	268.1	34.95	296.9	37.93
	18	151.1	18.96	180.0	22.77	208.9	26.81	223.9	28.91	238.9	31.12	268.1	35.56	296.9	38.76
	20	151.1	19.31	180.0	23.26	208.9	27.42	223.9	29.52	238.9	31.76	268.1	36.90	296.9	41.05
	21	151.1	19.42	180.0	23.50	208.9	27.68	223.9	29.89	238.9	32.48	268.1	38.08	296.9	42.15
	23	151.1	19.80	180.0	23.87	208.9	28.91	223.9	31.76	238.9	34.69	268.1	40.21	296.9	44.25
	25	151.1	20.56	180.0	25.47	208.9	31.00	223.9	33.97	238.9	37.16	268.1	43.03	296.9	47.30
	27	151.1	21.78	180.0	27.07	208.9	33.09	223.9	36.29	238.9	39.61	268.1	45.70	296.9	49.77
	29	151.1	23.12	180.0	28.91	208.9	35.19	223.9	38.65	238.9	42.31	268.1	48.97	296.9	53.27
	31	151.1	24.60	180.0	30.62	208.9	37.51	223.9	41.21	238.9	45.05	268.1	51.98	296.9	55.94
	33	151.1	26.08	180.0	32.71	208.9	39.98	223.9	43.91	238.9	47.98	268.1	54.76	296.9	58.64
	35	151.1	27.68	180.0	34.69	208.9	42.57	223.9	46.76	238.9	51.18	268.1	58.07	293.8	60.77
	37	151.1	29.28	180.0	36.90	208.9	45.16	223.9	49.70	238.9	54.38	268.1	61.27	289.2	63.52
	39	151.1	30.96	180.0	39.00	208.9	48.29	223.9	53.43	238.9	58.45	268.1	64.74	284.3	67.02
	41	147.3	34.23	175.4	43.22	203.5	53.01	218.1	58.57	232.7	64.21	261.2	72.05	272.3	74.26
	43	143.5	37.70	171.1	47.15	198.5	57.88	212.7	63.83	227.3	70.18	254.6	77.11	261.2	79.51
46	134.6	41.93	160.4	53.12	186.1	65.19	199.6	71.06	212.7	79.17	233.0	84.16	238.4	85.53	
48	118.9	36.63	141.9	46.46	164.6	57.01	176.5	62.07	188.4	69.31	202.3	72.85	207.3	73.61	

Note

1. TC: Total Capacity(kW), PI : Power Input(kW, Comp. + Outdoor fan motor)
2. Capacity tables show the average value of conditions which may occur.

7. Capacity Tables

Combination (%)	Outdoor air temp (°C DB)	Indoor air temp. (DB/WB, °C)														Cooling Capacity(100HP)	
		20		23		26		27		28		30		32		TC	PI
		14		16		18		19		20		22		24			
		TC	PI	TC	PI	TC	PI	TC	PI	TC	PI	TC	PI	TC	PI		
70	10	131.9	15.49	158.1	18.43	183.1	21.36	196.1	23.07	208.9	24.63	233.9	28.06	260.0	31.37		
	12	131.9	15.73	158.1	18.66	183.1	21.82	196.1	23.42	208.9	25.13	233.9	28.55	260.0	31.98		
	14	131.9	15.99	158.1	18.92	183.1	22.20	196.1	23.79	208.9	25.50	233.9	29.16	260.0	32.55		
	16	131.9	16.22	158.1	19.27	183.1	22.57	196.1	24.29	208.9	25.97	233.9	29.65	260.0	33.24		
	18	131.9	16.48	158.1	19.64	183.1	23.07	196.1	24.75	208.9	26.46	233.9	30.12	260.0	33.84		
	20	131.9	16.71	158.1	19.99	183.1	23.42	196.1	25.24	208.9	27.07	233.9	30.87	260.0	35.14		
	21	131.9	16.94	158.1	20.14	183.1	23.68	196.1	25.50	208.9	27.33	233.9	31.34	260.0	35.87		
	23	131.9	17.21	158.1	20.60	183.1	24.14	196.1	26.35	208.9	28.67	233.9	33.54	260.0	37.88		
	25	131.9	17.44	158.1	21.36	183.1	25.74	196.1	28.17	208.9	30.61	233.9	35.86	260.0	39.71		
	27	131.9	18.43	158.1	22.81	183.1	27.45	196.1	29.89	208.9	32.70	233.9	38.30	260.0	42.22		
	29	131.9	19.64	158.1	24.14	183.1	29.16	196.1	31.83	208.9	34.76	233.9	40.85	260.0	45.23		
	31	131.9	20.86	158.1	25.74	183.1	31.10	196.1	34.04	208.9	37.08	233.9	43.55	260.0	47.97		
	33	131.9	22.08	158.1	27.19	183.1	33.05	196.1	36.09	208.9	39.40	233.9	46.34	260.0	51.09		
	35	131.9	23.30	158.1	29.05	183.1	35.14	196.1	38.42	208.9	41.96	233.9	49.41	260.0	54.17		
	37	131.9	24.75	158.1	30.76	183.1	37.31	196.1	40.85	208.9	44.66	233.9	52.58	260.0	57.15		
	39	131.9	26.30	158.1	32.78	183.1	39.90	196.1	43.97	208.9	48.23	233.9	56.27	260.0	61.64		
	41	128.5	29.08	153.9	35.91	178.4	43.78	191.1	48.23	203.5	52.43	228.1	61.79	253.4	66.48		
	43	125.4	31.64	150.0	39.14	173.9	47.78	186.2	52.58	198.5	57.26	222.3	67.50	247.0	71.88		
46	117.7	35.18	140.8	44.01	163.1	53.79	174.6	58.56	186.1	64.53	208.4	76.14	231.5	80.11			
48	103.9	30.69	124.6	38.45	144.2	47.02	154.3	51.17	164.6	56.46	184.3	66.63	205.0	69.33			
60	10	113.1	13.29	135.0	15.60	156.9	18.15	168.1	19.45	178.9	20.67	201.1	23.45	223.1	26.23		
	12	113.1	13.55	135.0	15.84	156.9	18.38	168.1	19.72	178.9	21.05	201.1	23.83	223.1	26.72		
	14	113.1	13.66	135.0	16.10	156.9	18.73	168.1	20.06	178.9	21.39	201.1	24.32	223.1	27.21		
	16	113.1	13.90	135.0	16.44	156.9	18.99	168.1	20.44	178.9	21.89	201.1	24.78	223.1	27.68		
	18	113.1	14.16	135.0	16.67	156.9	19.34	168.1	20.79	178.9	22.26	201.1	25.16	223.1	28.28		
	20	113.1	14.39	135.0	16.94	156.9	19.72	168.1	21.16	178.9	22.61	201.1	25.62	223.1	28.89		
	21	113.1	14.50	135.0	17.05	156.9	19.95	168.1	21.39	178.9	22.84	201.1	26.00	223.1	29.15		
	23	113.1	14.77	135.0	17.40	156.9	20.21	168.1	21.77	178.9	23.33	201.1	26.95	223.1	30.95		
	25	113.1	15.00	135.0	17.78	156.9	21.05	168.1	22.84	178.9	24.78	201.1	28.78	223.1	33.12		
	27	113.1	15.49	135.0	18.73	156.9	22.38	168.1	24.32	178.9	26.37	201.1	30.60	223.1	35.32		
	29	113.1	16.44	135.0	19.95	156.9	23.83	168.1	25.88	178.9	28.05	201.1	32.66	223.1	37.72		
	31	113.1	17.40	135.0	21.16	156.9	25.27	168.1	27.56	178.9	29.88	201.1	34.83	223.1	40.15		
	33	113.1	18.38	135.0	22.38	156.9	26.84	168.1	29.27	178.9	31.79	201.1	37.00	223.1	42.82		
	35	113.1	19.45	135.0	23.83	156.9	28.55	168.1	31.06	178.9	33.73	201.1	39.43	223.1	45.45		
	37	113.1	20.55	135.0	25.13	156.9	30.22	168.1	33.00	178.9	35.78	201.1	41.83	223.1	48.38		
	39	113.1	21.85	135.0	26.76	156.9	32.62	168.1	35.40	178.9	38.52	201.1	44.87	223.1	51.84		
	41	110.0	23.71	131.5	29.31	153.1	35.44	163.8	38.68	174.3	41.80	195.8	49.22	217.3	56.33		
	43	107.3	25.77	128.4	31.90	149.2	38.63	159.6	42.17	170.0	45.60	191.1	53.74	211.9	61.51		
46	100.7	28.85	120.4	35.82	140.0	43.43	149.6	47.39	159.3	51.31	178.9	60.56	198.5	70.08			
48	88.9	25.16	106.5	31.25	123.8	37.95	132.3	41.38	141.1	44.84	158.4	52.95	175.8	61.32			
50	10	94.6	11.38	113.1	13.17	131.1	14.99	140.0	16.06	148.9	17.01	166.9	19.18	186.1	21.35		
	12	94.6	11.50	113.1	13.32	131.1	15.22	140.0	16.29	148.9	17.39	166.9	19.53	186.1	21.69		
	14	94.6	11.64	113.1	13.55	131.1	15.45	140.0	16.55	148.9	17.62	166.9	19.79	186.1	22.07		
	16	94.6	11.87	113.1	13.78	131.1	15.71	140.0	16.90	148.9	17.85	166.9	20.13	186.1	22.41		
	18	94.6	11.99	113.1	13.89	131.1	15.94	140.0	17.13	148.9	18.23	166.9	20.51	186.1	22.91		
	20	94.6	12.10	113.1	14.15	131.1	16.29	140.0	17.39	148.9	18.57	166.9	20.85	186.1	23.37		
	21	94.6	12.22	113.1	14.27	131.1	16.44	140.0	17.62	148.9	18.69	166.9	21.09	186.1	23.60		
	23	94.6	12.48	113.1	14.50	131.1	16.67	140.0	17.85	148.9	19.06	166.9	21.46	186.1	24.09		
	25	94.6	12.59	113.1	14.73	131.1	17.01	140.0	18.23	148.9	19.67	166.9	22.53	186.1	25.76		
	27	94.6	12.82	113.1	15.22	131.1	17.97	140.0	19.41	148.9	20.85	166.9	24.09	186.1	27.44		
	29	94.6	13.55	113.1	16.17	131.1	19.06	140.0	20.62	148.9	22.18	166.9	25.53	186.1	29.11		
	31	94.6	14.27	113.1	17.13	131.1	20.25	140.0	21.81	148.9	23.60	166.9	27.21	186.1	31.05		
	33	94.6	15.11	113.1	18.11	131.1	21.46	140.0	23.14	148.9	25.04	166.9	28.88	186.1	33.07		
	35	94.6	15.94	113.1	19.18	131.1	22.64	140.0	24.58	148.9	26.49	166.9	30.56	186.1	35.12		
	37	94.6	16.90	113.1	20.25	131.1	23.97	140.0	26.00	148.9	28.05	166.9	32.61	186.1	37.29		
	39	94.6	18.04	113.1	21.73	131.1	25.69	140.0	28.01	148.9	30.10	166.9	34.74	186.1	40.26		
	41	92.0	19.49	110.0	23.51	127.7	28.08	136.5	30.33	145.0	32.61	162.7	38.06	181.2	43.72		
	43	89.7	21.19	107.3	25.57	124.6	30.56	133.1	33.03	141.6	35.50	158.8	41.52	176.9	47.69		
46	84.2	23.74	100.7	28.69	116.6	34.29	124.6	37.07	132.7	39.85	148.8	46.70	165.7	53.70			
48	74.6	20.67	88.9	25.00	103.1	29.91	110.4	32.35	117.3	34.78	131.5	40.80	146.5	46.92			

Note

1. TC: Total Capacity(kW), PI : Power Input(kW, Comp. + Outdoor fan motor)
2. Capacity tables show the average value of conditions which may occur.

7. Capacity Tables

◆ A(C)RUN1020LLS5

Combination (%)	Outdoor air temp (°C DB)	Cooling Capacity(102HP)													
		Indoor air temp. (DB/WB, °C)													
		20		23		26		27		28		30		32	
		14	16	18	19	20	22	24	TC	PI	TC	PI	TC	PI	
130	10	282.9	34.18	337.0	41.78	361.0	48.48	371.5	49.45	381.7	49.87	400.2	50.26	410.4	50.45
	12	282.9	35.03	337.0	43.28	361.0	50.46	371.5	50.80	381.7	51.19	400.2	51.61	410.4	52.08
	14	282.9	36.23	337.0	44.84	361.0	52.35	371.5	52.74	381.7	53.17	400.2	53.59	410.4	54.06
	16	282.9	37.55	337.0	46.42	361.0	54.71	371.5	55.22	381.7	55.65	400.2	56.15	410.4	56.61
	18	282.9	39.10	337.0	49.10	361.0	57.23	371.5	58.47	381.7	58.94	400.2	59.52	410.4	59.91
	20	282.9	40.84	337.0	52.31	361.0	60.06	371.5	64.29	381.7	64.83	394.3	65.45	404.8	65.91
	21	282.9	41.89	337.0	54.14	361.0	61.30	371.5	68.05	381.7	68.59	392.3	69.28	402.5	69.75
	23	282.9	44.95	337.0	56.96	361.0	64.48	371.5	75.09	377.0	75.68	386.4	76.45	396.6	76.96
	25	282.9	48.01	337.0	60.22	361.0	68.90	366.9	83.27	371.5	83.93	381.7	84.78	392.3	85.36
	27	282.9	51.38	337.0	64.40	356.6	73.43	361.0	91.68	366.9	92.42	377.0	93.31	386.4	93.97
	29	282.9	54.75	337.0	68.82	350.7	79.01	355.8	100.75	361.0	101.37	371.5	102.26	381.7	102.65
	31	282.9	58.43	335.8	72.50	344.9	84.05	350.7	100.32	355.8	100.94	365.6	101.83	375.9	102.23
	33	282.9	62.24	329.9	76.84	340.5	90.13	346.0	99.40	350.7	100.01	361.0	100.90	370.3	101.29
	35	282.9	66.38	324.1	80.45	334.6	97.61	340.5	98.12	346.0	98.70	355.4	99.59	365.6	99.98
	37	282.9	70.79	319.7	84.43	329.9	96.33	334.6	96.83	340.5	97.41	349.6	98.27	360.1	98.66
	39	282.9	75.37	313.9	88.86	324.1	95.05	329.9	95.52	334.6	96.10	344.9	96.95	355.4	97.34
	41	275.8	79.95	300.9	93.31	311.1	93.77	315.8	94.24	322.0	94.79	331.5	95.64	340.5	96.02
	43	268.8	84.32	288.4	91.99	298.5	92.46	302.9	92.92	309.1	93.50	318.5	94.32	327.2	94.70
46	251.9	90.25	263.2	90.09	272.6	90.52	276.9	90.99	282.5	91.53	291.5	92.34	299.7	92.73	
48	222.8	87.73	228.4	88.00	237.0	88.20	240.9	88.43	246.0	89.20	253.8	89.78	260.9	90.13	
120	10	255.8	30.77	304.4	37.71	332.7	44.83	342.8	48.44	352.7	49.21	371.9	49.40	381.0	49.79
	12	255.8	31.58	304.4	38.98	332.7	46.62	342.8	49.45	352.7	51.03	371.9	51.65	381.0	52.04
	14	255.8	32.67	304.4	40.30	332.7	48.51	342.8	51.34	352.7	52.89	371.9	53.67	381.0	54.10
	16	255.8	33.86	304.4	41.96	332.7	50.38	342.8	53.24	352.7	55.34	371.9	56.03	381.0	56.46
	18	255.8	35.18	304.4	43.86	332.7	52.39	342.8	56.07	352.7	58.17	371.9	58.83	381.0	59.32
	20	255.8	36.51	304.4	46.50	332.7	55.22	342.8	58.98	352.7	61.26	371.9	62.07	381.0	62.55
	21	255.8	37.63	304.4	48.17	332.7	56.77	342.8	60.72	352.7	63.28	371.9	64.09	381.0	64.59
	23	255.8	40.22	304.4	51.54	332.7	60.80	342.8	64.52	352.7	67.46	371.9	68.13	381.0	68.67
	25	255.8	42.97	304.4	55.22	332.7	64.13	342.8	68.78	352.7	72.34	367.6	72.93	376.6	73.51
	27	255.8	45.88	304.4	59.02	332.7	68.27	342.8	73.50	352.7	77.73	362.1	78.27	371.1	78.89
	29	255.8	48.94	304.4	63.01	332.7	71.84	342.8	78.66	347.2	82.85	356.2	84.09	366.4	84.78
	31	255.8	52.16	304.4	67.31	332.7	75.56	338.2	84.25	342.8	88.89	351.9	90.44	360.6	91.18
	33	255.8	55.53	304.4	71.73	328.0	79.91	332.7	91.45	337.0	95.44	346.0	96.52	355.1	97.30
	35	255.8	59.02	304.4	76.46	322.5	84.59	326.8	100.75	332.7	101.25	341.7	101.56	350.7	102.37
	37	255.8	63.51	304.4	80.68	317.8	90.17	322.5	98.62	326.8	99.12	335.9	99.43	345.2	100.21
	39	255.8	68.36	303.3	85.29	312.3	95.64	316.9	96.60	321.3	97.10	331.5	97.38	340.5	98.15
	41	249.5	73.23	289.9	89.86	299.7	93.77	304.0	94.59	308.4	95.05	317.4	95.33	326.4	96.10
	43	243.2	78.16	277.8	88.58	287.6	91.68	291.5	92.54	295.8	93.00	304.8	93.31	313.5	94.04
46	227.9	84.05	253.4	86.49	262.5	88.78	266.4	89.51	270.6	89.97	278.6	90.24	286.8	90.95	
48	201.7	82.31	220.1	84.94	228.3	87.07	231.8	87.58	235.3	87.85	242.5	88.20	249.9	88.58	
110	10	229.2	27.67	273.4	33.71	305.3	40.06	314.2	43.36	333.9	46.66	341.7	47.97	364.8	48.75
	12	229.2	28.52	273.4	34.87	305.3	41.73	314.2	44.57	333.9	48.40	341.7	49.98	364.8	51.12
	14	229.2	29.41	273.4	36.43	305.3	43.60	314.2	46.77	333.9	50.84	341.7	52.31	364.8	53.40
	16	229.2	30.46	273.4	37.75	305.3	45.41	314.2	48.83	333.9	53.20	341.7	54.64	364.8	55.61
	18	229.2	31.58	273.4	39.33	305.3	48.01	314.2	51.42	333.9	56.11	341.7	57.23	364.8	58.28
	20	229.2	32.71	273.4	41.30	305.3	50.92	314.2	53.78	333.9	58.83	341.7	60.29	364.8	61.26
	21	229.2	33.44	273.4	42.51	305.3	52.24	314.2	55.22	333.9	60.49	341.7	62.00	364.8	62.97
	23	229.2	35.65	273.4	45.57	305.3	55.14	314.2	58.32	333.9	63.90	341.7	65.26	364.8	66.34
	25	229.2	38.09	273.4	48.63	305.3	58.28	314.2	61.65	333.9	67.50	341.7	68.47	360.5	69.87
	27	229.2	40.69	273.4	52.00	305.3	61.57	314.2	65.25	333.9	70.49	341.7	72.11	355.0	73.35
	29	229.2	43.44	273.4	55.53	305.3	65.06	314.2	69.09	333.9	74.51	341.7	75.79	350.7	76.92
	31	229.2	46.19	273.4	59.18	305.3	68.75	314.2	73.20	328.4	78.28	337.4	79.82	345.2	80.64
	33	229.2	49.25	273.4	63.01	305.3	72.65	314.2	77.58	324.0	82.66	331.9	84.05	340.5	84.51
	35	229.2	52.31	273.4	67.31	305.3	76.72	314.2	82.19	318.6	87.26	326.4	88.04	335.1	88.50
	37	229.2	55.45	273.4	71.42	305.3	80.99	309.9	87.07	313.1	92.03	322.0	92.34	329.6	92.61
	39	229.2	59.76	273.4	75.91	299.7	85.45	304.1	93.15	308.7	96.57	316.2	96.76	325.2	96.84
	41	223.6	64.09	266.4	80.37	287.1	90.13	291.5	100.75	295.4	100.75	304.0	101.56	311.5	102.37
	43	217.8	67.31	259.7	83.74	275.0	95.56	279.7	96.64	283.2	96.45	291.5	96.99	298.9	97.26
46	204.3	65.68	243.6	80.83	251.0	90.71	255.4	90.71	258.6	91.49	266.4	91.99	273.4	92.23	
48	180.5	63.79	211.5	77.88	218.1	86.30	222.0	86.88	224.8	87.30	231.8	87.54	237.8	87.89	

Note

1. TC: Total Capacity(kW), PI : Power Input(kW, Comp. + Outdoor fan motor)
2. Capacity tables show the average value of conditions which may occur.

7. Capacity Tables

		Cooling Capacity(102HP)													
Combination (%)	Outdoor air temp (°C DB)	Indoor air temp. (DB/WB, °C)													
		20		23		26		27		28		30		32	
		14	16	18	19	20	22	24	TC	PI	TC	PI	TC	PI	
100	10	192.7	24.92	229.5	30.27	267.2	35.92	285.6	38.83	304.0	41.70	337.0	46.42	344.4	46.81
	12	192.7	25.73	229.5	31.51	267.2	37.13	285.6	39.87	304.0	43.05	337.0	48.94	344.4	49.41
	14	192.7	26.51	229.5	32.78	267.2	38.71	285.6	41.58	304.0	44.91	337.0	51.66	344.4	52.16
	16	192.7	27.32	229.5	33.87	267.2	40.34	285.6	43.56	304.0	47.31	337.0	54.17	344.4	54.91
	18	192.7	28.13	229.5	35.11	267.2	41.93	285.6	45.69	304.0	50.18	337.0	57.23	344.4	57.66
	20	192.7	29.14	229.5	36.46	267.2	44.37	285.6	48.94	304.0	53.67	337.0	59.95	344.4	60.45
	21	192.7	29.76	229.5	37.32	267.2	45.88	285.6	50.61	304.0	55.68	337.0	61.34	344.4	61.81
	23	192.7	31.50	229.5	39.91	267.2	49.25	285.6	54.29	304.0	59.64	337.0	64.21	344.4	64.75
	25	192.7	33.48	229.5	42.51	267.2	52.62	285.6	58.12	304.0	63.78	337.0	66.96	341.4	67.50
	27	192.7	35.80	229.5	45.42	267.2	56.27	285.6	62.08	304.0	67.81	330.4	70.10	337.4	70.68
	29	192.7	38.09	229.5	48.48	267.2	60.10	285.6	66.38	304.0	71.77	324.4	72.93	332.3	73.51
	31	192.7	40.69	229.5	51.69	267.2	64.09	285.6	70.80	304.0	75.41	319.4	75.76	327.2	76.37
	33	192.7	43.13	229.5	55.06	267.2	68.36	285.6	75.56	304.0	78.24	314.3	78.58	322.1	79.21
	35	192.7	45.88	229.5	58.59	267.2	72.81	285.6	80.60	299.3	81.07	308.7	81.41	316.6	82.04
	37	192.7	49.14	229.5	62.82	267.2	77.11	285.6	84.44	294.3	84.86	302.9	85.21	310.0	85.99
	39	192.7	52.70	229.5	67.50	267.2	81.72	285.6	88.58	289.5	88.97	298.1	89.28	304.9	90.13
	41	189.8	56.23	225.9	72.15	262.9	86.33	274.2	92.69	280.1	93.07	286.7	93.39	295.8	94.27
	43	183.2	59.52	218.1	76.49	253.9	90.44	262.8	96.25	265.6	96.57	273.9	96.91	281.3	97.81
46	171.8	64.01	204.4	82.46	238.1	95.94	240.0	100.75	242.5	101.06	250.3	101.33	257.0	102.30	
48	151.8	55.26	180.8	71.34	205.5	82.00	208.4	85.48	210.7	85.76	217.7	85.95	223.6	86.64	
90	10	173.4	21.63	207.1	25.98	240.8	30.63	257.0	33.03	273.4	35.55	307.1	39.78	340.6	44.23
	12	173.4	21.87	207.1	26.40	240.8	31.17	257.0	33.69	273.4	36.33	307.1	40.55	340.6	45.01
	14	173.4	22.29	207.1	26.91	240.8	31.83	257.0	34.35	273.4	36.99	307.1	41.36	340.6	45.94
	16	173.4	22.68	207.1	27.45	240.8	32.49	257.0	35.01	273.4	37.68	307.1	42.14	340.6	46.72
	18	173.4	23.07	207.1	27.99	240.8	33.03	257.0	35.82	273.4	38.46	307.1	43.07	340.6	49.08
	20	173.4	23.46	207.1	28.50	240.8	33.69	257.0	36.48	273.4	39.93	307.1	46.09	340.6	51.41
	21	173.4	23.73	207.1	28.77	240.8	34.35	257.0	37.68	273.4	41.37	307.1	46.83	340.6	52.60
	23	173.4	24.27	207.1	29.97	240.8	36.75	257.0	40.44	273.4	44.31	307.1	49.66	335.9	55.08
	25	173.4	25.47	207.1	31.95	240.8	39.27	257.0	43.23	273.4	47.34	307.1	53.11	331.1	57.42
	27	173.4	27.18	207.1	34.08	240.8	41.91	257.0	46.14	273.4	50.67	307.1	56.45	326.4	60.13
	29	173.4	28.77	207.1	36.33	240.8	44.82	257.0	49.35	273.4	54.12	307.1	59.82	321.3	62.53
	31	173.4	30.63	207.1	38.73	240.8	47.76	257.0	52.53	273.4	57.69	307.1	62.80	316.6	64.97
	33	173.4	32.64	207.1	41.25	240.8	50.94	257.0	55.98	273.4	61.18	307.1	65.83	311.8	67.38
	35	173.4	34.62	207.1	43.77	240.8	54.12	257.0	59.67	273.4	64.89	301.7	69.59	306.8	71.21
	37	173.4	36.75	207.1	46.56	240.8	57.69	257.0	63.39	273.4	68.50	297.0	72.76	302.1	74.39
	39	173.4	38.89	207.1	49.51	240.8	61.06	257.0	67.46	273.4	72.03	291.9	76.72	297.0	77.65
	41	169.1	43.53	201.7	54.89	234.6	67.03	250.3	73.77	266.4	77.76	279.7	80.83	284.8	82.69
	43	164.8	46.98	196.9	59.31	228.7	73.20	244.4	79.47	259.7	83.38	268.3	86.57	273.1	87.61
46	154.5	52.88	184.4	67.54	214.2	83.42	229.1	90.09	236.1	92.62	244.8	95.02	249.5	95.17	
48	136.5	46.21	163.2	59.08	189.5	72.96	202.4	78.58	204.8	79.82	213.0	81.80	216.9	81.91	
80	10	154.1	18.03	183.6	21.67	213.1	25.43	228.4	27.44	243.7	29.42	273.4	33.57	302.9	36.44
	12	154.1	18.41	183.6	21.90	213.1	25.93	228.4	27.91	243.7	29.93	273.4	34.19	302.9	37.17
	14	154.1	18.65	183.6	22.41	213.1	26.29	228.4	28.42	243.7	30.43	273.4	34.81	302.9	37.87
	16	154.1	18.92	183.6	22.79	213.1	26.79	228.4	28.92	243.7	31.05	273.4	35.58	302.9	38.61
	18	154.1	19.30	183.6	23.18	213.1	27.29	228.4	29.42	243.7	31.67	273.4	36.20	302.9	39.46
	20	154.1	19.66	183.6	23.68	213.1	27.91	228.4	30.04	243.7	32.32	273.4	37.56	302.9	41.79
	21	154.1	19.77	183.6	23.92	213.1	28.18	228.4	30.43	243.7	33.06	273.4	38.76	302.9	42.91
	23	154.1	20.16	183.6	24.30	213.1	29.42	228.4	32.32	243.7	35.31	273.4	40.93	302.9	45.04
	25	154.1	20.93	183.6	25.93	213.1	31.55	228.4	34.57	243.7	37.83	273.4	43.80	302.9	48.14
	27	154.1	22.17	183.6	27.56	213.1	33.69	228.4	36.94	243.7	40.32	273.4	46.52	302.9	50.66
	29	154.1	23.53	183.6	29.42	213.1	35.82	228.4	39.34	243.7	43.07	273.4	49.85	302.9	54.23
	31	154.1	25.04	183.6	31.17	213.1	38.19	228.4	41.94	243.7	45.85	273.4	52.91	302.9	56.94
	33	154.1	26.55	183.6	33.30	213.1	40.70	228.4	44.70	243.7	48.84	273.4	55.74	302.9	59.69
	35	154.1	28.18	183.6	35.31	213.1	43.34	228.4	47.60	243.7	52.10	273.4	59.11	299.7	61.86
	37	154.1	29.81	183.6	37.56	213.1	45.97	228.4	50.59	243.7	55.35	273.4	62.37	295.0	64.66
	39	154.1	31.51	183.6	39.69	213.1	49.16	228.4	54.39	243.7	59.50	273.4	65.90	289.9	68.22
	41	150.2	34.85	178.9	43.99	207.6	53.96	222.5	59.62	237.4	65.36	266.4	73.34	277.8	75.59
	43	146.3	38.37	174.6	47.99	202.5	58.92	217.0	64.97	231.8	71.44	259.7	78.49	266.4	80.94
46	137.3	42.68	163.6	54.07	189.9	66.36	203.6	72.33	217.0	80.59	237.7	85.67	243.2	87.06	
48	121.3	37.29	144.7	47.29	167.9	58.03	180.1	63.18	192.2	70.55	206.3	74.15	211.4	74.93	

Note

1. TC: Total Capacity(kW), PI : Power Input(kW, Comp. + Outdoor fan motor)
2. Capacity tables show the average value of conditions which may occur.

7. Capacity Tables

		Cooling Capacity(102HP)													
Combination (%)	Outdoor air temp (°C DB)	Indoor air temp. (DB/WB, °C)													
		20		23		26		27		28		30		32	
		14	16	18	19	20	22	24	TC	PI	TC	PI	TC	PI	
70	10	134.6	15.77	161.2	18.76	186.7	21.74	200.0	23.48	213.1	25.08	238.6	28.56	265.2	31.94
	12	134.6	16.01	161.2	18.99	186.7	22.21	200.0	23.84	213.1	25.58	238.6	29.07	265.2	32.55
	14	134.6	16.28	161.2	19.26	186.7	22.60	200.0	24.22	213.1	25.96	238.6	29.69	265.2	33.14
	16	134.6	16.51	161.2	19.61	186.7	22.98	200.0	24.72	213.1	26.44	238.6	30.19	265.2	33.84
	18	134.6	16.78	161.2	20.00	186.7	23.48	200.0	25.20	213.1	26.94	238.6	30.66	265.2	34.46
	20	134.6	17.01	161.2	20.35	186.7	23.84	200.0	25.70	213.1	27.56	238.6	31.43	265.2	35.77
	21	134.6	17.25	161.2	20.50	186.7	24.10	200.0	25.96	213.1	27.83	238.6	31.90	265.2	36.51
	23	134.6	17.52	161.2	20.97	186.7	24.58	200.0	26.82	213.1	29.18	238.6	34.15	265.2	38.56
	25	134.6	17.75	161.2	21.74	186.7	26.20	200.0	28.68	213.1	31.16	238.6	36.51	265.2	40.43
	27	134.6	18.76	161.2	23.22	186.7	27.94	200.0	30.43	213.1	33.29	238.6	38.99	265.2	42.98
	29	134.6	20.00	161.2	24.58	186.7	29.69	200.0	32.40	213.1	35.39	238.6	41.59	265.2	46.04
	31	134.6	21.24	161.2	26.20	186.7	31.67	200.0	34.65	213.1	37.75	238.6	44.34	265.2	48.84
	33	134.6	22.48	161.2	27.68	186.7	33.64	200.0	36.75	213.1	40.11	238.6	47.17	265.2	52.01
	35	134.6	23.72	161.2	29.57	186.7	35.77	200.0	39.11	213.1	42.71	238.6	50.31	265.2	55.15
	37	134.6	25.20	161.2	31.31	186.7	37.99	200.0	41.59	213.1	45.46	238.6	53.52	265.2	58.18
	39	134.6	26.78	161.2	33.37	186.7	40.62	200.0	44.76	213.1	49.10	238.6	57.28	265.2	62.75
	41	131.1	29.61	156.9	36.55	182.0	44.57	194.9	49.10	207.6	53.37	232.6	62.91	258.5	67.68
	43	127.9	32.21	153.0	39.85	177.3	48.64	189.9	53.53	202.5	58.29	226.8	68.72	251.9	73.18
46	120.0	35.81	143.6	44.81	166.3	54.77	178.1	59.61	189.9	65.70	212.6	77.52	236.2	81.55	
48	106.0	31.24	127.1	39.15	147.1	47.87	157.4	52.10	167.9	57.48	187.9	67.83	209.1	70.58	
60	10	115.3	13.53	137.7	15.89	160.1	18.48	171.4	19.81	182.5	21.05	205.1	23.88	227.5	26.71
	12	115.3	13.79	137.7	16.12	160.1	18.72	171.4	20.07	182.5	21.43	205.1	24.26	227.5	27.21
	14	115.3	13.91	137.7	16.39	160.1	19.07	171.4	20.43	182.5	21.78	205.1	24.76	227.5	27.71
	16	115.3	14.15	137.7	16.74	160.1	19.34	171.4	20.81	182.5	22.28	205.1	25.23	227.5	28.18
	18	115.3	14.41	137.7	16.98	160.1	19.69	171.4	21.16	182.5	22.67	205.1	25.61	227.5	28.80
	20	115.3	14.65	137.7	17.24	160.1	20.07	171.4	21.55	182.5	23.02	205.1	26.09	227.5	29.42
	21	115.3	14.77	137.7	17.36	160.1	20.31	171.4	21.78	182.5	23.26	205.1	26.47	227.5	29.68
	23	115.3	15.03	137.7	17.71	160.1	20.57	171.4	22.17	182.5	23.76	205.1	27.44	227.5	31.51
	25	115.3	15.27	137.7	18.10	160.1	21.43	171.4	23.26	182.5	25.23	205.1	29.30	227.5	33.72
	27	115.3	15.77	137.7	19.07	160.1	22.79	171.4	24.76	182.5	26.85	205.1	31.16	227.5	35.96
	29	115.3	16.74	137.7	20.31	160.1	24.26	171.4	26.35	182.5	28.56	205.1	33.25	227.5	38.41
	31	115.3	17.71	137.7	21.55	160.1	25.73	171.4	28.06	182.5	30.42	205.1	35.46	227.5	40.88
	33	115.3	18.72	137.7	22.79	160.1	27.32	171.4	29.80	182.5	32.36	205.1	37.67	227.5	43.60
	35	115.3	19.81	137.7	24.26	160.1	29.06	171.4	31.63	182.5	34.34	205.1	40.15	227.5	46.28
	37	115.3	20.93	137.7	25.58	160.1	30.77	171.4	33.60	182.5	36.43	205.1	42.59	227.5	49.25
	39	115.3	22.25	137.7	27.25	160.1	33.21	171.4	36.05	182.5	39.22	205.1	45.69	227.5	52.78
	41	112.2	24.14	134.2	29.84	156.1	36.08	167.1	39.38	177.8	42.56	199.7	50.11	221.7	57.35
	43	109.5	26.24	131.0	32.47	152.2	39.33	162.8	42.94	173.4	46.43	194.9	54.72	216.2	62.63
46	102.8	29.38	122.8	36.47	142.8	44.22	152.6	48.25	162.5	52.24	182.5	61.66	202.5	71.35	
48	90.7	25.61	108.6	31.82	126.3	38.64	135.0	42.13	143.9	45.65	161.6	53.91	179.3	62.43	
50	10	96.5	11.59	115.3	13.41	133.7	15.27	142.8	16.35	151.9	17.32	170.3	19.53	189.8	21.74
	12	96.5	11.71	115.3	13.56	133.7	15.50	142.8	16.59	151.9	17.71	170.3	19.88	189.8	22.09
	14	96.5	11.85	115.3	13.79	133.7	15.74	142.8	16.85	151.9	17.94	170.3	20.15	189.8	22.47
	16	96.5	12.09	115.3	14.03	133.7	16.00	142.8	17.21	151.9	18.18	170.3	20.50	189.8	22.82
	18	96.5	12.21	115.3	14.15	133.7	16.24	142.8	17.44	151.9	18.56	170.3	20.88	189.8	23.32
	20	96.5	12.32	115.3	14.41	133.7	16.59	142.8	17.71	151.9	18.91	170.3	21.24	189.8	23.79
	21	96.5	12.44	115.3	14.53	133.7	16.74	142.8	17.94	151.9	19.03	170.3	21.47	189.8	24.03
	23	96.5	12.71	115.3	14.76	133.7	16.97	142.8	18.18	151.9	19.41	170.3	21.85	189.8	24.53
	25	96.5	12.82	115.3	15.00	133.7	17.32	142.8	18.56	151.9	20.03	170.3	22.94	189.8	26.24
	27	96.5	13.06	115.3	15.50	133.7	18.29	142.8	19.76	151.9	21.24	170.3	24.53	189.8	27.94
	29	96.5	13.79	115.3	16.47	133.7	19.41	142.8	21.00	151.9	22.59	170.3	26.00	189.8	29.65
	31	96.5	14.53	115.3	17.44	133.7	20.62	142.8	22.21	151.9	24.03	170.3	27.71	189.8	31.62
	33	96.5	15.38	115.3	18.44	133.7	21.85	142.8	23.56	151.9	25.50	170.3	29.41	189.8	33.68
	35	96.5	16.24	115.3	19.53	133.7	23.06	142.8	25.03	151.9	26.97	170.3	31.12	189.8	35.77
	37	96.5	17.21	115.3	20.62	133.7	24.41	142.8	26.47	151.9	28.56	170.3	33.21	189.8	37.97
	39	96.5	18.37	115.3	22.12	133.7	26.16	142.8	28.52	151.9	30.65	170.3	35.37	189.8	41.00
	41	93.8	19.84	112.2	23.94	130.2	28.60	139.2	30.88	147.9	33.21	166.0	38.75	184.8	44.52
	43	91.5	21.58	109.5	26.04	127.1	31.12	135.7	33.63	144.4	36.15	162.0	42.27	180.4	48.56
46	85.9	24.18	102.8	29.21	118.9	34.91	127.1	37.75	135.3	40.57	151.8	47.55	169.1	54.68	
48	76.1	21.04	90.7	25.46	105.2	30.46	112.6	32.94	119.7	35.42	134.2	41.54	149.5	47.78	

Note

1. TC: Total Capacity(kW), PI : Power Input(kW, Comp. + Outdoor fan motor)
2. Capacity tables show the average value of conditions which may occur.

7. Capacity Tables

◆ A(C)RUN1040LLS5

Combination (%)	Outdoor air temp (°C DB)	Cooling Capacity(104HP)													
		Indoor air temp. (DB/WB, °C)													
		20		23		26		27		28		30		32	
		14	16	18	19	20	22	24	TC	PI	TC	PI	TC	PI	
130	10	288.4	35.28	343.6	43.12	368.0	50.04	378.8	51.04	389.2	51.48	408.0	51.88	418.4	52.08
	12	288.4	36.16	343.6	44.68	368.0	52.08	378.8	52.44	389.2	52.84	408.0	53.28	418.4	53.76
	14	288.4	37.40	343.6	46.28	368.0	54.04	378.8	54.44	389.2	54.88	408.0	55.32	418.4	55.80
	16	288.4	38.76	343.6	47.92	368.0	56.48	378.8	57.00	389.2	57.44	408.0	57.96	418.4	58.44
	18	288.4	40.36	343.6	50.68	368.0	59.08	378.8	60.36	389.2	60.84	408.0	61.44	418.4	61.84
	20	288.4	42.16	343.6	54.00	368.0	62.00	378.8	66.36	389.2	66.92	402.0	67.56	412.8	68.04
	21	288.4	43.24	343.6	55.88	368.0	63.28	378.8	70.24	389.2	70.80	400.0	71.52	410.4	72.00
	23	288.4	46.40	343.6	58.80	368.0	66.56	378.8	77.52	384.4	78.12	394.0	78.92	404.4	79.44
	25	288.4	49.56	343.6	62.16	368.0	71.12	374.0	85.96	378.8	86.64	389.2	87.52	400.0	88.12
	27	288.4	53.04	343.6	66.48	363.6	75.80	368.0	94.64	374.0	95.40	384.4	96.32	394.0	97.00
	29	288.4	56.52	343.6	71.04	357.6	81.56	362.8	104.00	368.0	104.64	378.8	105.56	389.2	105.96
	31	288.4	60.32	342.4	74.84	351.6	86.76	357.6	103.56	362.8	104.20	372.8	105.12	383.2	105.52
	33	288.4	64.24	336.4	79.32	347.2	93.04	352.8	102.60	357.6	103.24	368.0	104.16	377.6	104.56
	35	288.4	68.52	330.4	83.04	341.2	100.76	347.2	101.28	352.8	101.88	362.4	102.80	372.8	103.20
	37	288.4	73.08	326.0	87.16	336.4	99.44	341.2	99.96	347.2	100.56	356.4	101.44	367.2	101.84
	39	288.4	77.80	320.0	91.72	330.4	98.12	336.4	98.60	341.2	99.20	351.6	100.08	362.4	100.48
	41	281.2	82.52	306.8	96.32	317.2	96.80	322.0	97.28	328.4	97.84	338.0	98.72	347.2	99.12
	43	274.0	87.04	294.0	94.96	304.4	95.44	308.8	95.92	315.2	96.52	324.8	97.36	333.6	97.76
	46	256.8	93.16	268.4	93.00	278.0	93.44	282.4	93.92	288.0	94.48	297.2	95.32	305.6	95.72
	48	227.2	90.56	232.8	90.84	241.6	91.04	245.6	91.28	250.8	92.08	258.8	92.68	266.0	93.04
120	10	260.8	31.76	310.4	38.92	339.2	46.28	349.6	50.00	359.6	50.80	379.2	51.00	388.4	51.40
	12	260.8	32.60	310.4	40.24	339.2	48.12	349.6	51.04	359.6	52.68	379.2	53.32	388.4	53.72
	14	260.8	33.72	310.4	41.60	339.2	50.08	349.6	53.00	359.6	54.60	379.2	55.40	388.4	55.84
	16	260.8	34.96	310.4	43.32	339.2	52.00	349.6	54.96	359.6	57.12	379.2	57.84	388.4	58.28
	18	260.8	36.32	310.4	45.28	339.2	54.08	349.6	57.88	359.6	60.04	379.2	60.72	388.4	61.24
	20	260.8	37.68	310.4	48.00	339.2	57.00	349.6	60.88	359.6	63.24	379.2	64.08	388.4	64.56
	21	260.8	38.84	310.4	49.72	339.2	58.60	349.6	62.68	359.6	65.32	379.2	66.16	388.4	66.68
	23	260.8	41.52	310.4	53.20	339.2	62.76	349.6	66.60	359.6	69.64	379.2	70.32	388.4	70.88
	25	260.8	44.36	310.4	57.00	339.2	66.20	349.6	71.00	359.6	74.68	374.8	75.28	384.0	75.88
	27	260.8	47.36	310.4	60.92	339.2	70.48	349.6	75.88	359.6	80.24	369.2	80.80	378.4	81.44
	29	260.8	50.52	310.4	65.04	339.2	74.16	349.6	81.20	354.0	85.52	363.2	86.80	373.6	87.52
	31	260.8	53.84	310.4	69.48	339.2	78.00	344.8	86.96	349.6	91.76	358.8	93.36	367.6	94.12
	33	260.8	57.32	310.4	74.04	334.4	82.48	339.2	94.40	343.6	98.52	352.8	99.64	362.0	100.44
	35	260.8	60.92	310.4	78.92	328.8	87.32	333.2	104.00	339.2	104.52	348.4	104.84	357.6	105.68
	37	260.8	65.56	310.4	83.28	324.0	93.08	328.8	101.80	333.2	102.32	342.4	102.64	352.0	103.44
	39	260.8	70.56	309.2	88.04	318.4	98.72	323.2	99.72	327.6	100.24	338.0	100.52	347.2	101.32
	41	254.4	75.60	295.6	92.76	305.6	96.80	310.0	97.64	314.4	98.12	323.6	98.40	332.8	99.20
	43	248.0	80.68	283.2	91.44	293.2	94.64	297.2	95.52	301.6	96.00	310.8	96.32	319.6	97.08
	46	232.4	86.76	258.4	89.28	267.6	91.64	271.6	92.40	276.0	92.88	284.0	93.16	292.4	93.88
	48	205.6	84.96	224.4	87.68	232.8	89.88	236.4	90.40	240.0	90.68	247.2	91.04	254.8	91.44
110	10	233.6	28.56	278.8	34.80	311.2	41.36	320.4	44.76	340.4	48.16	348.4	49.52	372.0	50.32
	12	233.6	29.44	278.8	36.00	311.2	43.08	320.4	46.00	340.4	49.96	348.4	51.60	372.0	52.76
	14	233.6	30.36	278.8	37.60	311.2	45.00	320.4	48.28	340.4	52.48	348.4	54.00	372.0	55.12
	16	233.6	31.44	278.8	38.96	311.2	46.88	320.4	50.40	340.4	54.92	348.4	56.40	372.0	57.40
	18	233.6	32.60	278.8	40.60	311.2	49.56	320.4	53.08	340.4	57.92	348.4	59.08	372.0	60.16
	20	233.6	33.76	278.8	42.64	311.2	52.56	320.4	55.52	340.4	60.72	348.4	62.24	372.0	63.24
	21	233.6	34.52	278.8	43.88	311.2	53.92	320.4	57.00	340.4	62.44	348.4	64.00	372.0	65.00
	23	233.6	36.80	278.8	47.04	311.2	56.92	320.4	60.20	340.4	65.96	348.4	67.36	372.0	68.48
	25	233.6	39.32	278.8	50.20	311.2	60.16	320.4	63.64	340.4	69.68	348.4	70.68	367.6	72.12
	27	233.6	42.00	278.8	53.68	311.2	63.56	320.4	67.36	340.4	72.76	348.4	74.44	362.0	75.72
	29	233.6	44.84	278.8	57.32	311.2	67.16	320.4	71.32	340.4	76.92	348.4	78.24	357.6	79.40
	31	233.6	47.68	278.8	61.08	311.2	70.96	320.4	75.56	334.8	80.80	344.0	82.40	352.0	83.24
	33	233.6	50.84	278.8	65.04	311.2	75.00	320.4	80.08	330.4	85.32	338.4	86.76	347.2	87.24
	35	233.6	54.00	278.8	69.48	311.2	79.20	320.4	84.84	324.8	90.08	332.8	90.88	341.6	91.36
	37	233.6	57.24	278.8	73.72	311.2	83.60	316.0	89.88	319.2	95.00	328.4	95.32	336.0	95.60
	39	233.6	61.68	278.8	78.36	305.6	88.20	310.0	96.16	314.8	99.68	322.4	99.88	331.6	99.96
	41	228.0	66.16	271.6	82.96	292.8	93.04	297.2	104.00	301.2	104.00	310.0	104.84	317.6	105.68
	43	222.0	69.48	264.8	86.44	280.4	98.64	285.2	99.76	288.8	99.56	297.2	100.12	304.8	100.40
	46	208.4	67.80	248.4	83.44	256.0	93.64	260.4	93.64	263.6	94.44	271.6	94.96	278.8	95.20
	48	184.0	65.84	215.6	80.40	222.4	89.08	226.4	89.68	229.2	90.12	236.4	90.36	242.4	90.72

Note

1. TC: Total Capacity(kW), PI : Power Input(kW, Comp. + Outdoor fan motor)
2. Capacity tables show the average value of conditions which may occur.

7. Capacity Tables

		Cooling Capacity(104HP)													
Combination (%)	Outdoor air temp (°C DB)	Indoor air temp. (DB/WB, °C)													
		20		23		26		27		28		30		32	
		14	16	18	19	20	22	24	TC	PI	TC	PI	TC	PI	
100	10	196.4	25.72	234.0	31.24	272.4	37.08	291.2	40.08	310.0	43.04	343.6	47.92	351.2	48.32
	12	196.4	26.56	234.0	32.52	272.4	38.32	291.2	41.16	310.0	44.44	343.6	50.52	351.2	51.00
	14	196.4	27.36	234.0	33.84	272.4	39.96	291.2	42.92	310.0	46.36	343.6	53.32	351.2	53.84
	16	196.4	28.20	234.0	34.96	272.4	41.64	291.2	44.96	310.0	48.84	343.6	55.92	351.2	56.68
	18	196.4	29.04	234.0	36.24	272.4	43.28	291.2	47.16	310.0	51.80	343.6	59.08	351.2	59.52
	20	196.4	30.08	234.0	37.64	272.4	45.80	291.2	50.52	310.0	55.40	343.6	61.88	351.2	62.40
	21	196.4	30.72	234.0	38.52	272.4	47.36	291.2	52.24	310.0	57.48	343.6	63.32	351.2	63.80
	23	196.4	32.52	234.0	41.20	272.4	50.84	291.2	56.04	310.0	61.56	343.6	66.28	351.2	66.84
	25	196.4	34.56	234.0	43.88	272.4	54.32	291.2	60.00	310.0	65.84	343.6	69.12	348.0	69.68
	27	196.4	36.96	234.0	46.88	272.4	58.08	291.2	64.08	310.0	70.00	336.8	72.36	344.0	72.96
	29	196.4	39.32	234.0	50.04	272.4	62.04	291.2	68.52	310.0	74.08	330.8	75.28	338.8	75.88
	31	196.4	42.00	234.0	53.36	272.4	66.16	291.2	73.08	310.0	77.84	325.6	78.20	333.6	78.84
	33	196.4	44.52	234.0	56.84	272.4	70.56	291.2	78.00	310.0	80.76	320.4	81.12	328.4	81.76
	35	196.4	47.36	234.0	60.48	272.4	75.16	291.2	83.20	305.2	83.68	314.8	84.04	322.8	84.68
	37	196.4	50.72	234.0	64.84	272.4	79.60	291.2	87.16	300.0	87.60	308.8	87.96	316.0	88.76
	39	196.4	54.40	234.0	69.68	272.4	84.36	291.2	91.44	295.2	91.84	304.0	92.16	310.8	93.04
	41	193.6	58.04	230.4	74.48	268.0	89.12	279.6	95.68	285.6	96.08	292.4	96.40	301.6	97.32
	43	186.8	61.44	222.4	78.96	258.8	93.36	268.0	99.36	270.8	99.68	279.2	100.04	286.8	100.96
46	175.2	66.08	208.4	85.12	242.8	99.04	244.8	104.00	247.2	104.32	255.2	104.60	262.0	105.60	
48	154.8	57.04	184.4	73.64	209.6	84.64	212.4	88.24	214.8	88.52	222.0	88.72	228.0	89.44	
90	10	176.8	22.32	211.2	26.80	245.6	31.60	262.0	34.08	278.8	36.68	313.2	41.04	347.2	45.64
	12	176.8	22.56	211.2	27.24	245.6	32.16	262.0	34.76	278.8	37.48	313.2	41.84	347.2	46.44
	14	176.8	23.00	211.2	27.76	245.6	32.84	262.0	35.44	278.8	38.16	313.2	42.68	347.2	47.40
	16	176.8	23.40	211.2	28.32	245.6	33.52	262.0	36.12	278.8	38.88	313.2	43.48	347.2	48.20
	18	176.8	23.80	211.2	28.88	245.6	34.08	262.0	36.96	278.8	39.68	313.2	44.44	347.2	50.64
	20	176.8	24.20	211.2	29.40	245.6	34.76	262.0	37.64	278.8	41.20	313.2	47.56	347.2	53.04
	21	176.8	24.48	211.2	29.68	245.6	35.44	262.0	38.88	278.8	42.68	313.2	48.32	347.2	54.28
	23	176.8	25.04	211.2	30.92	245.6	37.92	262.0	41.72	278.8	45.72	313.2	51.24	342.4	56.84
	25	176.8	26.28	211.2	32.96	245.6	40.52	262.0	44.60	278.8	48.84	313.2	54.80	337.6	59.24
	27	176.8	28.04	211.2	35.16	245.6	43.24	262.0	47.60	278.8	52.28	313.2	58.24	332.8	62.04
	29	176.8	29.68	211.2	37.48	245.6	46.24	262.0	50.92	278.8	55.84	313.2	61.72	327.6	64.52
	31	176.8	31.60	211.2	39.96	245.6	49.28	262.0	54.20	278.8	59.52	313.2	64.80	322.8	67.04
	33	176.8	33.68	211.2	42.56	245.6	52.56	262.0	57.76	278.8	63.12	313.2	67.92	318.0	69.52
	35	176.8	35.72	211.2	45.16	245.6	55.84	262.0	61.56	278.8	66.96	307.6	71.80	312.8	73.48
	37	176.8	37.92	211.2	48.04	245.6	59.52	262.0	65.40	278.8	70.68	302.8	75.08	308.0	76.76
	39	176.8	40.12	211.2	51.08	245.6	63.00	262.0	69.60	278.8	74.32	297.6	79.16	302.8	80.12
	41	172.4	44.92	205.6	56.64	239.2	69.16	255.2	76.12	271.6	80.24	285.2	83.40	290.4	85.32
	43	168.0	48.48	200.8	61.20	233.2	75.52	249.2	82.00	264.8	86.04	273.6	89.32	278.4	90.40
46	157.6	54.56	188.0	69.68	218.4	86.08	233.6	92.96	240.8	95.56	249.6	98.04	254.4	98.20	
48	139.2	47.68	166.4	60.96	193.2	75.28	206.4	81.08	208.8	82.36	217.2	84.40	221.2	84.52	
80	10	157.2	18.60	187.2	22.36	217.2	26.24	232.8	28.32	248.4	30.36	278.8	34.64	308.8	37.60
	12	157.2	19.00	187.2	22.60	217.2	26.76	232.8	28.80	248.4	30.88	278.8	35.28	308.8	38.36
	14	157.2	19.24	187.2	23.12	217.2	27.12	232.8	29.32	248.4	31.40	278.8	35.92	308.8	39.08
	16	157.2	19.52	187.2	23.52	217.2	27.64	232.8	29.84	248.4	32.04	278.8	36.72	308.8	39.84
	18	157.2	19.92	187.2	23.92	217.2	28.16	232.8	30.36	248.4	32.68	278.8	37.36	308.8	40.72
	20	157.2	20.28	187.2	24.44	217.2	28.80	232.8	31.00	248.4	33.36	278.8	38.76	308.8	43.12
	21	157.2	20.40	187.2	24.68	217.2	29.08	232.8	31.40	248.4	34.12	278.8	40.00	308.8	44.28
	23	157.2	20.80	187.2	25.08	217.2	30.36	232.8	33.36	248.4	36.44	278.8	42.24	308.8	46.48
	25	157.2	21.60	187.2	26.76	217.2	32.56	232.8	35.68	248.4	39.04	278.8	45.20	308.8	49.68
	27	157.2	22.88	187.2	28.44	217.2	34.76	232.8	38.12	248.4	41.60	278.8	48.00	308.8	52.28
	29	157.2	24.28	187.2	30.36	217.2	36.96	232.8	40.60	248.4	44.44	278.8	51.44	308.8	55.96
	31	157.2	25.84	187.2	32.16	217.2	39.40	232.8	43.28	248.4	47.32	278.8	54.60	308.8	58.76
	33	157.2	27.40	187.2	34.36	217.2	42.00	232.8	46.12	248.4	50.40	278.8	57.52	308.8	61.60
	35	157.2	29.08	187.2	36.44	217.2	44.72	232.8	49.12	248.4	53.76	278.8	61.00	305.6	63.84
	37	157.2	30.76	187.2	38.76	217.2	47.44	232.8	52.20	248.4	57.12	278.8	64.36	300.8	66.72
	39	157.2	32.52	187.2	40.96	217.2	50.72	232.8	56.12	248.4	61.40	278.8	68.00	295.6	70.40
	41	153.2	35.96	182.4	45.40	211.6	55.68	226.8	61.52	242.0	67.44	271.6	75.68	283.2	78.00
	43	149.2	39.60	178.0	49.52	206.4	60.80	221.2	67.04	236.4	73.72	264.8	81.00	271.6	83.52
46	140.0	44.04	166.8	55.80	193.6	68.48	207.6	74.64	221.2	83.16	242.4	88.40	248.0	89.84	
48	123.6	38.48	147.6	48.80	171.2	59.88	183.6	65.20	196.0	72.80	210.4	76.52	215.6	77.32	

Note

1. TC: Total Capacity(kW), PI : Power Input(kW, Comp. + Outdoor fan motor)
2. Capacity tables show the average value of conditions which may occur.

7. Capacity Tables

		Cooling Capacity(104HP)													
Combination (%)	Outdoor air temp (°C DB)	Indoor air temp. (DB/WB, °C)													
		20		23		26		27		28		30		32	
		14	16	18	19	20	22	24	14	16	18	19	20	22	24
		TC	PI	TC	PI	TC	PI	TC	PI	TC	PI	TC	PI	TC	PI
70	10	137.2	16.28	164.4	19.36	190.4	22.44	204.0	24.24	217.2	25.88	243.2	29.48	270.4	32.96
	12	137.2	16.52	164.4	19.60	190.4	22.92	204.0	24.60	217.2	26.40	243.2	30.00	270.4	33.60
	14	137.2	16.80	164.4	19.88	190.4	23.32	204.0	25.00	217.2	26.80	243.2	30.64	270.4	34.20
	16	137.2	17.04	164.4	20.24	190.4	23.72	204.0	25.52	217.2	27.28	243.2	31.16	270.4	34.92
	18	137.2	17.32	164.4	20.64	190.4	24.24	204.0	26.00	217.2	27.80	243.2	31.64	270.4	35.56
	20	137.2	17.56	164.4	21.00	190.4	24.60	204.0	26.52	217.2	28.44	243.2	32.44	270.4	36.92
	21	137.2	17.80	164.4	21.16	190.4	24.88	204.0	26.80	217.2	28.72	243.2	32.92	270.4	37.68
	23	137.2	18.08	164.4	21.64	190.4	25.36	204.0	27.68	217.2	30.12	243.2	35.24	270.4	39.80
	25	137.2	18.32	164.4	22.44	190.4	27.04	204.0	29.60	217.2	32.16	243.2	37.68	270.4	41.72
	27	137.2	19.36	164.4	23.96	190.4	28.84	204.0	31.40	217.2	34.36	243.2	40.24	270.4	44.36
	29	137.2	20.64	164.4	25.36	190.4	30.64	204.0	33.44	217.2	36.52	243.2	42.92	270.4	47.52
	31	137.2	21.92	164.4	27.04	190.4	32.68	204.0	35.76	217.2	38.96	243.2	45.76	270.4	50.40
	33	137.2	23.20	164.4	28.56	190.4	34.72	204.0	37.92	217.2	41.40	243.2	48.68	270.4	53.68
	35	137.2	24.48	164.4	30.52	190.4	36.92	204.0	40.36	217.2	44.08	243.2	51.92	270.4	56.92
	37	137.2	26.00	164.4	32.32	190.4	39.20	204.0	42.92	217.2	46.92	243.2	55.24	270.4	60.04
	39	137.2	27.64	164.4	34.44	190.4	41.92	204.0	46.20	217.2	50.68	243.2	59.12	270.4	64.76
	41	133.6	30.56	160.0	37.72	185.6	46.00	198.8	50.68	211.6	55.08	237.2	64.92	263.6	69.84
	43	130.4	33.24	156.0	41.12	180.8	50.20	193.6	55.24	206.4	60.16	231.2	70.92	256.8	75.52
46	122.4	36.96	146.4	46.24	169.6	56.52	181.6	61.52	193.6	67.80	216.8	80.00	240.8	84.16	
48	108.0	32.24	129.6	40.40	150.0	49.40	160.4	53.76	171.2	59.32	191.6	70.00	213.2	72.84	
60	10	117.6	13.96	140.4	16.40	163.2	19.08	174.8	20.44	186.0	21.72	209.2	24.64	232.0	27.56
	12	117.6	14.24	140.4	16.64	163.2	19.32	174.8	20.72	186.0	22.12	209.2	25.04	232.0	28.08
	14	117.6	14.36	140.4	16.92	163.2	19.68	174.8	21.08	186.0	22.48	209.2	25.56	232.0	28.60
	16	117.6	14.60	140.4	17.28	163.2	19.96	174.8	21.48	186.0	23.00	209.2	26.04	232.0	29.08
	18	117.6	14.88	140.4	17.52	163.2	20.32	174.8	21.84	186.0	23.40	209.2	26.44	232.0	29.72
	20	117.6	15.12	140.4	17.80	163.2	20.72	174.8	22.24	186.0	23.76	209.2	26.92	232.0	30.36
	21	117.6	15.24	140.4	17.92	163.2	20.96	174.8	22.48	186.0	24.00	209.2	27.32	232.0	30.64
	23	117.6	15.52	140.4	18.28	163.2	21.24	174.8	22.88	186.0	24.52	209.2	28.32	232.0	32.52
	25	117.6	15.76	140.4	18.68	163.2	22.12	174.8	24.00	186.0	26.04	209.2	30.24	232.0	34.80
	27	117.6	16.28	140.4	19.68	163.2	23.52	174.8	25.56	186.0	27.72	209.2	32.16	232.0	37.12
	29	117.6	17.28	140.4	20.96	163.2	25.04	174.8	27.20	186.0	29.48	209.2	34.32	232.0	39.64
	31	117.6	18.28	140.4	22.24	163.2	26.56	174.8	28.96	186.0	31.40	209.2	36.60	232.0	42.20
	33	117.6	19.32	140.4	23.52	163.2	28.20	174.8	30.76	186.0	33.40	209.2	38.88	232.0	45.00
	35	117.6	20.44	140.4	25.04	163.2	30.00	174.8	32.64	186.0	35.44	209.2	41.44	232.0	47.76
	37	117.6	21.60	140.4	26.40	163.2	31.76	174.8	34.68	186.0	37.60	209.2	43.96	232.0	50.84
	39	117.6	22.96	140.4	28.12	163.2	34.28	174.8	37.20	186.0	40.48	209.2	47.16	232.0	54.48
	41	114.4	24.92	136.8	30.80	159.2	37.24	170.4	40.64	181.2	43.92	203.6	51.72	226.0	59.20
	43	111.6	27.08	133.6	33.52	155.2	40.60	166.0	44.32	176.8	47.92	198.8	56.48	220.4	64.64
46	104.8	30.32	125.2	37.64	145.6	45.64	155.6	49.80	165.6	53.92	186.0	63.64	206.4	73.64	
48	92.4	26.44	110.8	32.84	128.8	39.88	137.6	43.48	146.8	47.12	164.8	55.64	182.8	64.44	
50	10	98.4	11.96	117.6	13.84	136.4	15.76	145.6	16.88	154.8	17.88	173.6	20.16	193.6	22.44
	12	98.4	12.08	117.6	14.00	136.4	16.00	145.6	17.12	154.8	18.28	173.6	20.52	193.6	22.80
	14	98.4	12.24	117.6	14.24	136.4	16.24	145.6	17.40	154.8	18.52	173.6	20.80	193.6	23.20
	16	98.4	12.48	117.6	14.48	136.4	16.52	145.6	17.76	154.8	18.76	173.6	21.16	193.6	23.56
	18	98.4	12.60	117.6	14.60	136.4	16.76	145.6	18.00	154.8	19.16	173.6	21.56	193.6	24.08
	20	98.4	12.72	117.6	14.88	136.4	17.12	145.6	18.28	154.8	19.52	173.6	21.92	193.6	24.56
	21	98.4	12.84	117.6	15.00	136.4	17.28	145.6	18.52	154.8	19.64	173.6	22.16	193.6	24.80
	23	98.4	13.12	117.6	15.24	136.4	17.52	145.6	18.76	154.8	20.04	173.6	22.56	193.6	25.32
	25	98.4	13.24	117.6	15.48	136.4	17.88	145.6	19.16	154.8	20.68	173.6	23.68	193.6	27.08
	27	98.4	13.48	117.6	16.00	136.4	18.88	145.6	20.40	154.8	21.92	173.6	25.32	193.6	28.84
	29	98.4	14.24	117.6	17.00	136.4	20.04	145.6	21.68	154.8	23.32	173.6	26.84	193.6	30.60
	31	98.4	15.00	117.6	18.00	136.4	21.28	145.6	22.92	154.8	24.80	173.6	28.60	193.6	32.64
	33	98.4	15.88	117.6	19.04	136.4	22.56	145.6	24.32	154.8	26.32	173.6	30.36	193.6	34.76
	35	98.4	16.76	117.6	20.16	136.4	23.80	145.6	25.84	154.8	27.84	173.6	32.12	193.6	36.92
	37	98.4	17.76	117.6	21.28	136.4	25.20	145.6	27.32	154.8	29.48	173.6	34.28	193.6	39.20
	39	98.4	18.96	117.6	22.84	136.4	27.00	145.6	29.44	154.8	31.64	173.6	36.52	193.6	42.32
	41	95.6	20.48	114.4	24.72	132.8	29.52	142.0	31.88	150.8	34.28	169.2	40.00	188.4	45.96
	43	93.2	22.28	111.6	26.88	129.6	32.12	138.4	34.72	147.2	37.32	165.2	43.64	184.0	50.12
46	87.6	24.96	104.8	30.16	121.2	36.04	129.6	38.96	138.0	41.88	154.8	49.08	172.4	56.44	
48	77.6	21.72	92.4	26.28	107.2	31.44	114.8	34.00	122.0	36.56	136.8	42.88	152.4	49.32	

Note

1. TC: Total Capacity(kW), PI : Power Input(kW, Comp. + Outdoor fan motor)
2. Capacity tables show the average value of conditions which may occur.

7. Capacity Tables

7.2 Capacity Tables_Heating

7.2.1 Single Unit

◆ ARUN080LLS5

Combination (%)	Outdoor air temp.		Indoor air temp. °C DB												Heating Capacity (8HP)	
			16		18		20		21		22		24			
	°C DB	°C WB	TC	PI	TC	PI	TC	PI	TC	PI	TC	PI	TC	PI		
130	-19.8	-20	13.0	4.44	13.0	4.61	12.9	4.76	12.9	4.99	12.9	5.20	12.9	5.55		
	-18.8	-19	13.6	4.55	13.6	4.73	13.6	4.87	13.6	5.10	13.6	5.32	13.6	5.66		
	-16.7	-17	14.9	4.79	14.9	4.96	14.8	5.11	14.8	5.34	14.8	5.56	14.8	5.90		
	-13.7	-15	16.8	5.14	16.8	5.31	16.7	5.45	16.7	5.68	16.7	5.90	16.7	5.83		
	-11.8	-13	17.7	5.35	17.7	5.52	17.6	5.67	17.6	5.90	17.6	5.87	17.6	5.79		
	-9.8	-11	18.7	5.58	18.7	5.75	18.6	5.90	18.6	5.88	18.6	5.83	18.6	5.75		
	-9.5	-10	19.2	5.61	19.2	5.79	19.0	5.90	19.0	5.88	18.7	5.83	18.7	5.74		
	-8.5	-9.1	20.7	5.73	20.7	5.90	20.5	5.90	20.5	5.87	19.2	5.81	19.2	5.72		
	-7.0	-7.6	22.9	5.90	22.9	5.92	22.8	5.90	22.8	5.85	22.8	5.78	20.8	5.69		
	-5.0	-5.6	25.9	5.95	25.9	5.94	25.8	5.90	25.8	5.83	25.8	5.75	22.1	5.64		
	-3.0	-3.7	28.9	6.00	28.9	5.96	28.7	5.89	28.1	5.81	27.2	5.72	23.3	5.60		
	0.0	-0.7	29.0	6.08	29.0	5.99	28.9	5.89	28.1	5.78	27.2	5.66	25.2	5.53		
	3.0	2.2	29.0	6.16	29.0	6.02	28.9	5.89	28.1	5.75	27.2	5.61	25.3	5.47		
	5.0	4.1	29.0	6.21	29.0	6.04	28.9	5.89	28.1	5.73	27.2	5.58	25.3	5.42		
	7.0	6	29.0	6.26	29.0	6.06	28.9	5.89	28.1	5.71	27.2	5.54	25.3	5.38		
	9.0	7.9	29.0	6.32	29.0	6.12	28.9	5.94	28.1	5.77	27.2	5.60	25.3	5.43		
11.0	9.8	29.0	6.45	29.0	6.24	28.9	6.06	28.1	5.88	27.2	5.71	25.3	5.54			
13.0	11.8	29.0	6.57	29.0	6.36	28.9	6.17	28.1	5.99	27.2	5.82	25.3	5.64			
15.0	13.7	29.0	6.69	29.0	6.48	28.9	6.29	28.1	6.11	27.2	5.93	25.3	5.75			
120	-19.8	-20	12.9	4.61	12.9	4.76	12.8	4.99	12.8	5.20	12.8	5.55	12.8	5.79		
	-18.8	-19	13.5	4.73	13.5	4.87	13.5	5.10	13.5	5.32	13.5	5.66	13.5	5.90		
	-16.7	-17	14.8	4.96	14.8	5.11	14.7	5.34	14.7	5.56	14.7	5.90	14.7	5.86		
	-13.7	-15	16.7	5.31	16.7	5.45	16.6	5.68	16.6	5.90	16.6	5.85	16.6	5.80		
	-11.8	-13	17.6	5.52	17.6	5.67	17.5	5.90	17.5	5.87	17.5	5.81	17.5	5.76		
	-9.8	-11	18.6	5.75	18.6	5.90	18.5	5.87	18.5	5.83	18.5	5.78	18.5	5.72		
	-9.5	-10	19.0	5.79	19.0	5.90	18.9	5.87	18.9	5.82	18.9	5.77	18.9	5.71		
	-8.5	-9.1	20.5	5.90	20.5	5.89	20.4	5.85	20.4	5.81	19.8	5.75	19.8	5.69		
	-7.0	-7.6	22.8	5.90	22.8	5.87	22.6	5.83	22.6	5.78	20.7	5.73	20.7	5.66		
	-5.0	-5.6	25.7	5.90	25.7	5.86	25.6	5.80	25.6	5.74	25.6	5.69	21.9	5.62		
	-3.0	-3.7	28.4	5.90	28.4	5.84	27.3	5.77	26.4	5.71	25.6	5.65	23.1	5.58		
	0.0	-0.7	28.7	5.90	28.4	5.81	27.3	5.73	26.4	5.65	25.6	5.60	23.7	5.52		
	3.0	2.2	28.7	5.90	28.4	5.78	27.3	5.69	26.4	5.60	25.6	5.55	23.7	5.46		
	5.0	4.1	28.7	5.91	28.4	5.76	27.3	5.66	26.4	5.56	25.6	5.51	23.7	5.42		
	7.0	6	28.7	5.91	28.4	5.75	27.3	5.63	26.4	5.53	25.6	5.47	23.7	5.38		
	9.0	7.9	28.7	5.94	28.4	5.78	27.3	5.66	26.4	5.55	25.6	5.50	23.7	5.40		
11.0	9.8	28.7	6.02	28.4	5.86	27.3	5.74	26.4	5.63	25.6	5.58	23.7	5.48			
13.0	11.8	28.7	6.11	28.4	5.94	27.3	5.83	26.4	5.71	25.6	5.66	23.7	5.56			
15.0	13.7	28.7	6.19	28.4	6.03	27.3	5.91	26.4	5.79	25.6	5.74	23.7	5.64			
110	-19.8	-20	12.9	4.76	12.9	4.99	12.8	5.20	12.8	5.55	12.8	5.79	12.8	5.90		
	-18.8	-19	13.5	4.87	13.5	5.10	13.4	5.32	13.4	5.66	13.4	5.90	13.4	5.87		
	-16.7	-17	14.8	5.11	14.8	5.34	14.7	5.56	14.7	5.90	14.7	5.84	14.7	5.80		
	-13.7	-15	16.6	5.45	16.6	5.68	16.5	5.90	16.5	5.82	16.5	5.76	16.5	5.70		
	-11.8	-13	17.5	5.67	17.5	5.90	17.4	5.85	17.4	5.77	17.4	5.71	17.4	5.64		
	-9.8	-11	18.5	5.90	18.5	5.84	18.4	5.79	18.4	5.71	18.4	5.65	18.4	5.57		
	-9.5	-10	18.9	5.89	18.9	5.84	18.8	5.78	18.8	5.70	18.8	5.64	18.8	5.56		
	-8.5	-9.1	20.4	5.87	20.4	5.81	20.3	5.75	20.3	5.68	19.7	5.61	19.7	5.53		
	-7.0	-7.6	22.6	5.83	22.6	5.77	22.5	5.71	22.5	5.63	20.7	5.57	20.7	5.48		
	-5.0	-5.6	24.6	5.77	24.6	5.71	24.5	5.65	23.7	5.58	21.6	5.52	21.4	5.42		
	-3.0	-3.7	26.1	5.72	26.1	5.65	24.5	5.60	23.7	5.53	22.9	5.46	21.4	5.35		
	0.0	-0.7	27.6	5.64	26.1	5.57	24.5	5.51	23.7	5.44	22.9	5.38	21.4	5.25		
	3.0	2.2	27.6	5.56	26.1	5.49	24.5	5.43	23.7	5.36	22.9	5.30	21.4	5.16		
	5.0	4.1	27.6	5.51	26.1	5.43	24.5	5.37	23.7	5.31	22.9	5.24	21.4	5.09		
	7.0	6	27.6	5.46	26.1	5.38	24.5	5.32	23.7	5.25	22.9	5.18	21.4	5.02		
	9.0	7.9	27.6	5.46	26.1	5.37	24.5	5.31	23.7	5.25	22.9	5.18	21.4	5.02		
11.0	9.8	27.6	5.50	26.1	5.42	24.5	5.36	23.7	5.30	22.9	5.23	21.4	5.07			
13.0	11.8	27.6	5.55	26.1	5.47	24.5	5.41	23.7	5.34	22.9	5.27	21.4	5.11			
15.0	13.7	27.6	5.59	26.1	5.51	24.5	5.45	23.7	5.38	22.9	5.31	21.4	5.15			

Note

1. TC: Total Capacity(kW), PI : Power Input(kW, Comp. + Outdoor fan motor)
2. Capacity tables show the average value of conditions which may occur.
3. In the range beyond the operation limit of the outdoor unit, continuous operation and performance can not be guaranteed. When selecting the outdoor units, avoid the air temperature range that is not guaranteed continuous operation.

7. Capacity Tables

Combination (%)		Heating Capacity (8HP)												
		Outdoor air temp.		Indoor air temp. °C DB										
		°C DB	°C WB	16		18		20		21		22		24
		TC	PI	TC	PI	TC	PI	TC	PI	TC	PI	TC	PI	
100	-19.8	-20	12.8	4.95	12.8	5.14	12.7	5.30	12.7	5.61	12.7	5.82	12.7	5.90
	-18.8	-19	13.4	5.05	13.3	5.24	13.3	5.42	13.3	5.70	13.3	5.90	13.3	5.84
	-16.7	-17	14.6	5.25	14.6	5.44	14.6	5.66	14.5	5.90	14.5	5.79	14.5	5.73
	-13.7	-15	16.5	5.53	16.5	5.72	16.4	5.90	16.4	5.76	16.4	5.64	16.4	5.56
	-11.8	-13	17.4	5.71	17.3	5.90	17.3	5.82	17.3	5.67	17.3	5.55	17.3	5.46
	-9.8	-11	18.4	5.90	18.4	5.82	18.3	5.74	18.3	5.58	18.3	5.45	18.3	5.35
	-9.5	-10	18.8	5.89	18.8	5.80	18.7	5.72	18.7	5.57	18.7	5.43	18.7	5.33
	-8.5	-9.1	20.3	5.85	20.3	5.76	20.2	5.68	21.7	5.52	21.0	5.38	19.5	5.28
	-7.0	-7.6	22.9	5.80	22.8	5.70	22.4	5.62	21.7	5.45	21.0	5.31	19.5	5.20
	-5.0	-5.6	23.9	5.72	23.6	5.62	22.4	5.53	21.7	5.36	21.0	5.21	19.5	5.09
	-3.0	-3.7	24.6	5.65	23.8	5.53	22.4	5.45	21.7	5.27	21.0	5.11	19.5	4.98
	0.0	-0.7	25.3	5.54	23.8	5.41	22.4	5.32	21.7	5.13	21.0	4.96	19.5	4.81
	3.0	2.2	25.3	5.43	23.8	5.29	22.4	5.20	21.7	5.00	21.0	4.80	19.5	4.65
	5.0	4.1	25.3	5.36	23.8	5.20	22.4	5.11	21.7	4.90	21.0	4.70	19.5	4.54
	7.0	6	25.3	5.28	23.8	5.12	22.4	5.03	21.7	4.81	21.0	4.60	19.5	4.43
	9.0	7.9	25.3	5.21	23.8	5.05	22.4	4.96	21.7	4.75	21.0	4.54	19.5	4.37
11.0	9.8	25.3	5.19	23.8	5.02	22.4	4.94	21.7	4.72	21.0	4.52	19.5	4.35	
13.0	11.8	25.3	5.16	23.8	4.99	22.4	4.91	21.7	4.69	21.0	4.49	19.5	4.32	
15.0	13.7	25.3	5.12	23.8	4.96	22.4	4.87	21.7	4.66	21.0	4.46	19.5	4.29	
90	-19.8	-20	12.7	4.67	12.7	5.01	12.7	5.25	12.7	5.36	12.7	5.29	12.7	5.15
	-18.8	-19	13.4	4.78	13.3	5.12	13.3	5.36	13.3	5.33	13.3	5.25	13.3	5.11
	-16.7	-17	14.6	5.02	14.6	5.36	14.5	5.30	14.5	5.25	14.5	5.17	14.5	5.02
	-13.7	-15	16.5	5.36	16.5	5.28	16.4	5.20	16.4	5.14	16.4	5.05	16.4	4.90
	-11.8	-13	17.4	5.31	17.3	5.22	17.3	5.14	17.3	5.08	17.3	4.98	17.3	4.82
	-9.8	-11	18.4	5.26	18.4	5.16	18.2	5.08	18.2	5.00	18.2	4.91	16.7	4.73
	-9.5	-10	18.8	5.25	18.8	5.16	18.7	5.07	18.7	4.99	18.7	4.90	17.1	4.72
	-8.5	-9.1	20.3	5.23	20.2	5.13	20.1	5.04	19.9	4.96	19.2	4.86	17.9	4.68
	-7.0	-7.6	22.9	5.19	21.8	5.08	20.5	4.99	19.9	4.90	19.2	4.80	17.9	4.61
	-5.0	-5.6	23.1	5.14	21.8	5.03	20.5	4.93	19.9	4.83	19.2	4.72	17.9	4.53
	-3.0	-3.7	23.1	5.09	21.8	4.97	20.5	4.87	19.9	4.76	19.2	4.65	17.9	4.45
	0.0	-0.7	23.1	5.01	21.8	4.88	20.5	4.77	19.9	4.65	19.2	4.53	17.9	4.32
	3.0	2.2	23.1	4.93	21.8	4.80	20.5	4.68	19.9	4.54	19.2	4.42	17.9	4.19
	5.0	4.1	23.1	4.88	21.8	4.74	20.5	4.62	19.9	4.47	19.2	4.35	17.9	4.11
	7.0	6	23.1	4.83	21.8	4.68	20.5	4.56	19.9	4.40	19.2	4.27	17.9	4.03
	9.0	7.9	23.1	4.76	21.8	4.62	20.5	4.49	19.9	4.34	19.2	4.21	17.9	3.97
11.0	9.8	23.1	4.70	21.8	4.55	20.5	4.43	19.9	4.28	19.2	4.15	17.9	3.92	
13.0	11.8	23.1	4.63	21.8	4.49	20.5	4.37	19.9	4.22	19.2	4.09	17.9	3.86	
15.0	13.7	23.1	4.56	21.8	4.42	20.5	4.31	19.9	4.16	19.2	4.03	17.9	3.80	
80	-19.8	-20	12.6	4.06	12.6	4.40	12.6	4.76	12.6	4.68	12.6	4.57	12.6	4.45
	-18.8	-19	13.2	4.17	13.2	4.76	13.2	4.72	13.2	4.65	13.2	4.54	13.2	4.42
	-16.7	-17	14.5	4.76	14.5	4.69	14.5	4.65	14.5	4.57	14.5	4.46	14.5	4.34
	-13.7	-15	17.1	4.67	16.8	4.60	16.4	4.56	16.4	4.46	16.4	4.35	16.0	4.22
	-11.8	-13	18.5	4.62	18.0	4.55	17.3	4.49	17.3	4.39	17.1	4.28	16.0	4.15
	-9.8	-11	19.0	4.57	18.5	4.49	18.2	4.43	17.8	4.32	17.1	4.21	16.0	4.07
	-9.5	-10	19.2	4.56	18.6	4.48	18.3	4.42	17.8	4.31	17.1	4.20	16.0	4.06
	-8.5	-9.1	19.9	4.53	19.5	4.45	18.3	4.38	17.8	4.27	17.1	4.16	16.0	4.02
	-7.0	-7.6	20.7	4.49	19.5	4.41	18.3	4.34	17.8	4.22	17.1	4.10	16.0	3.97
	-5.0	-5.6	20.7	4.44	19.5	4.35	18.3	4.27	17.8	4.15	17.1	4.03	16.0	3.89
	-3.0	-3.7	20.7	4.38	19.5	4.29	18.3	4.20	17.8	4.08	17.1	3.96	16.0	3.81
	0.0	-0.7	20.7	4.30	19.5	4.20	18.3	4.11	17.8	3.97	17.1	3.85	16.0	3.70
	3.0	2.2	20.7	4.22	19.5	4.11	18.3	4.01	17.8	3.86	17.1	3.74	16.0	3.58
	5.0	4.1	20.7	4.17	19.5	4.05	18.3	3.94	17.8	3.79	17.1	3.67	16.0	3.51
	7.0	6	20.7	4.11	19.5	3.99	18.3	3.88	17.8	3.72	17.1	3.59	16.0	3.43
	9.0	7.9	20.7	3.86	19.5	3.75	18.3	3.64	17.8	3.49	17.1	3.37	16.0	3.22
11.0	9.8	20.7	3.58	19.5	3.48	18.3	3.38	17.8	3.24	17.1	3.13	16.0	2.99	
13.0	11.8	20.7	3.35	19.5	3.25	18.3	3.15	17.8	3.02	17.1	2.92	16.0	2.79	
15.0	13.7	20.7	3.15	19.5	3.06	18.3	2.97	17.8	2.84	17.1	2.75	16.0	2.63	

Note

1. TC: Total Capacity(kW), PI: Power Input(kW, Comp. + Outdoor fan motor)
2. Capacity tables show the average value of conditions which may occur.
3. In the range beyond the operation limit of the outdoor unit, continuous operation and performance can not be guaranteed. When selecting the outdoor units, avoid the air temperature range that is not guaranteed continuous operation.

7. Capacity Tables

Combination (%)		Heating Capacity (8HP)												
		Outdoor air temp.		Indoor air temp. °C DB										
		°C DB	°C WB	16		18		20		21		22		24
		TC	PI	TC	PI	TC	PI	TC	PI	TC	PI	TC	PI	
70	-19.8	-20	12.6	4.30	12.6	4.41	12.6	4.34	12.6	4.22	12.6	4.10	12.6	3.98
	-18.8	-19	13.2	4.41	13.2	4.38	13.2	4.30	13.2	4.18	13.2	4.07	13.2	3.94
	-16.7	-17	14.5	4.35	14.5	4.30	14.5	4.22	14.5	4.10	14.5	3.99	13.6	3.85
	-13.7	-15	17.6	4.25	16.6	4.19	15.6	4.11	15.1	3.98	14.6	3.87	13.6	3.73
	-11.8	-13	17.6	4.19	16.6	4.12	15.6	4.03	15.1	3.91	14.6	3.80	13.6	3.65
	-9.8	-11	17.6	4.12	16.6	4.05	15.6	3.96	15.1	3.83	14.6	3.72	13.6	3.57
	-9.5	-10	17.6	4.11	16.6	4.04	15.6	3.95	15.1	3.82	14.6	3.71	13.6	3.56
	-8.5	-9.1	17.6	4.08	16.6	4.00	15.6	3.91	15.1	3.78	14.6	3.67	13.6	3.52
	-7.0	-7.6	17.6	4.03	16.6	3.95	15.6	3.85	15.1	3.72	14.6	3.61	13.6	3.46
	-5.0	-5.6	17.6	3.97	16.6	3.87	15.6	3.78	15.1	3.64	14.6	3.54	13.6	3.38
	-3.0	-3.7	17.6	3.90	16.6	3.80	15.6	3.70	15.1	3.56	14.6	3.46	13.6	3.30
	0.0	-0.7	17.6	3.81	16.6	3.69	15.6	3.59	15.1	3.45	14.6	3.35	13.6	3.18
	3.0	2.2	17.6	3.71	16.6	3.58	15.6	3.47	15.1	3.33	14.6	3.23	13.6	3.05
	5.0	4.1	17.6	3.65	16.6	3.51	15.6	3.40	15.1	3.25	14.6	3.15	13.6	2.97
	7.0	6	17.6	3.58	16.6	3.44	15.6	3.32	15.1	3.17	14.6	3.08	13.6	2.89
	9.0	7.9	17.6	3.23	16.6	3.10	15.6	3.00	15.1	2.87	14.6	2.78	13.6	2.61
	11.0	9.8	17.6	3.01	16.6	2.89	15.6	2.79	15.1	2.67	14.6	2.59	13.6	2.43
13.0	11.8	17.6	2.82	16.6	2.70	15.6	2.61	15.1	2.50	14.6	2.42	13.6	2.28	
15.0	13.7	17.6	2.66	16.6	2.55	15.6	2.46	15.1	2.35	14.6	2.28	13.6	2.15	
60	-19.8	-20	15.1	4.07	14.3	3.99	12.6	3.88	12.6	3.76	12.5	3.65	11.7	3.52
	-18.8	-19	15.1	4.04	14.3	3.96	13.2	3.84	12.9	3.72	12.5	3.61	11.7	3.48
	-16.7	-17	15.1	3.97	14.3	3.88	13.4	3.76	12.9	3.64	12.5	3.53	11.7	3.39
	-13.7	-15	15.1	3.87	14.3	3.76	13.4	3.64	12.9	3.53	12.5	3.41	11.7	3.27
	-11.8	-13	15.1	3.80	14.3	3.69	13.4	3.57	12.9	3.45	12.5	3.34	11.7	3.20
	-9.8	-11	15.1	3.74	14.3	3.61	13.4	3.49	12.9	3.38	12.5	3.26	11.7	3.11
	-9.5	-10	15.1	3.73	14.3	3.60	13.4	3.48	12.9	3.36	12.5	3.25	11.7	3.10
	-8.5	-9.1	15.1	3.69	14.3	3.57	13.4	3.44	12.9	3.33	12.5	3.21	11.7	3.06
	-7.0	-7.6	15.1	3.64	14.3	3.51	13.4	3.38	12.9	3.27	12.5	3.15	11.7	3.00
	-5.0	-5.6	15.1	3.58	14.3	3.43	13.4	3.30	12.9	3.19	12.5	3.08	11.7	2.92
	-3.0	-3.7	15.1	3.51	14.3	3.36	13.4	3.23	12.9	3.11	12.5	3.00	11.7	2.84
	0.0	-0.7	15.1	3.41	14.3	3.24	13.4	3.11	12.9	3.00	12.5	2.89	11.7	2.72
	3.0	2.2	15.1	3.31	14.3	3.13	13.4	2.99	12.9	2.88	12.5	2.77	11.7	2.59
	5.0	4.1	15.1	3.24	14.3	3.05	13.4	2.92	12.9	2.80	12.5	2.69	11.7	2.51
	7.0	6	15.1	3.18	14.3	2.98	13.4	2.84	12.9	2.73	12.5	2.62	11.7	2.43
	9.0	7.9	15.1	2.84	14.3	2.66	13.4	2.53	12.9	2.43	12.5	2.33	11.7	2.17
	11.0	9.8	15.1	2.65	14.3	2.48	13.4	2.36	12.9	2.27	12.5	2.18	11.7	2.03
13.0	11.8	15.1	2.48	14.3	2.32	13.4	2.21	12.9	2.13	12.5	2.04	11.7	1.90	
15.0	13.7	15.1	2.34	14.3	2.20	13.4	2.09	12.9	2.01	12.5	1.93	11.7	1.79	
50	-19.8	-20	12.6	3.65	11.9	3.52	11.1	3.40	10.8	3.28	10.4	3.17	9.7	3.05
	-18.8	-19	12.6	3.61	11.9	3.48	11.1	3.36	10.8	3.24	10.4	3.13	9.7	3.01
	-16.7	-17	12.6	3.52	11.9	3.39	11.1	3.27	10.8	3.15	10.4	3.05	9.7	2.92
	-13.7	-15	12.6	3.40	11.9	3.27	11.1	3.15	10.8	3.03	10.4	2.93	9.7	2.80
	-11.8	-13	12.6	3.32	11.9	3.19	11.1	3.08	10.8	2.96	10.4	2.86	9.7	2.73
	-9.8	-11	12.6	3.24	11.9	3.10	11.1	2.99	10.8	2.88	10.4	2.78	9.7	2.65
	-9.5	-10	12.6	3.23	11.9	3.09	11.1	2.98	10.8	2.86	10.4	2.77	9.7	2.64
	-8.5	-9.1	12.6	3.19	11.9	3.05	11.1	2.94	10.8	2.82	10.4	2.73	9.7	2.60
	-7.0	-7.6	12.6	3.13	11.9	2.99	11.1	2.88	10.8	2.76	10.4	2.67	9.7	2.54
	-5.0	-5.6	12.6	3.05	11.9	2.90	11.1	2.80	10.8	2.68	10.4	2.59	9.7	2.46
	-3.0	-3.7	12.6	2.97	11.9	2.82	11.1	2.72	10.8	2.60	10.4	2.52	9.7	2.38
	0.0	-0.7	12.6	2.85	11.9	2.69	11.1	2.60	10.8	2.48	10.4	2.40	9.7	2.26
	3.0	2.2	12.6	2.73	11.9	2.57	11.1	2.47	10.8	2.36	10.4	2.28	9.7	2.14
	5.0	4.1	12.6	2.64	11.9	2.48	11.1	2.39	10.8	2.28	10.4	2.21	9.7	2.06
	7.0	6	12.6	2.56	11.9	2.40	11.1	2.31	10.8	2.20	10.4	2.13	9.7	1.99
	9.0	7.9	12.6	2.31	11.9	2.17	11.1	2.09	10.8	1.98	10.4	1.92	9.7	1.79
	11.0	9.8	12.6	2.17	11.9	2.03	11.1	1.95	10.8	1.86	10.4	1.80	9.7	1.68
13.0	11.8	12.6	2.03	11.9	1.90	11.1	1.83	10.8	1.74	10.4	1.69	9.7	1.58	
15.0	13.7	12.6	1.92	11.9	1.80	11.1	1.74	10.8	1.65	10.4	1.60	9.7	1.49	

Note

1. TC: Total Capacity(kW), PI : Power Input(kW, Comp. + Outdoor fan motor)
2. Capacity tables show the average value of conditions which may occur.
3. In the range beyond the operation limit of the outdoor unit, continuous operation and performance can not be guaranteed. When selecting the outdoor units, avoid the air temperature range that is not guaranteed continuous operation.

7. Capacity Tables

◆ A(C)RUN100LLS5

Combination (%)	Outdoor air temp.		Indoor air temp. °C DB											
	°C DB	°C WB	16		18		20		21		22		24	
			TC	PI	TC	PI	TC	PI	TC	PI	TC	PI	TC	PI
130	-19.8	-20	16.2	6.24	16.2	6.48	16.1	6.69	16.1	7.01	16.1	7.31	16.1	7.79
	-18.8	-19	17.0	6.40	17.0	6.64	16.9	6.85	16.9	7.17	16.9	7.47	16.9	7.95
	-16.7	-17	18.6	6.74	18.6	6.98	18.5	7.19	18.5	7.51	18.5	7.81	18.5	8.29
	-13.7	-15	21.0	7.22	21.0	7.46	20.8	7.67	20.8	7.99	20.8	8.29	20.8	8.20
	-11.8	-13	22.2	7.52	22.2	7.76	22.0	7.97	22.0	8.29	22.0	8.24	22.0	8.14
	-9.8	-11	23.4	7.84	23.4	8.08	23.3	8.29	23.3	8.26	23.3	8.20	23.3	8.08
	-9.5	-10	24.0	7.89	24.0	8.13	23.8	8.29	23.8	8.26	23.4	8.19	23.4	8.07
	-8.5	-9.1	25.8	8.05	25.8	8.29	25.7	8.29	25.7	8.24	24.1	8.17	24.1	8.04
	-7.0	-7.6	28.6	8.29	28.6	8.31	28.5	8.29	28.5	8.22	28.5	8.13	26.0	7.99
	-5.0	-5.6	32.4	8.36	32.4	8.34	32.2	8.28	32.2	8.20	32.2	8.08	27.6	7.93
	-3.0	-3.7	36.2	8.44	36.2	8.37	35.9	8.28	35.2	8.17	34.0	8.03	29.1	7.87
	0.0	-0.7	36.2	8.55	36.2	8.42	36.1	8.28	35.2	8.13	34.0	7.96	31.4	7.77
	3.0	2.2	36.2	8.66	36.2	8.46	36.1	8.28	35.2	8.09	34.0	7.89	31.6	7.68
	5.0	4.1	36.2	8.73	36.2	8.49	36.1	8.27	35.2	8.06	34.0	7.84	31.6	7.62
	7.0	6	36.2	8.80	36.2	8.52	36.1	8.27	35.2	8.03	34.0	7.79	31.6	7.56
	9.0	7.9	36.2	8.89	36.2	8.60	36.1	8.35	35.2	8.11	34.0	7.87	31.6	7.63
	11.0	9.8	36.2	9.06	36.2	8.77	36.1	8.52	35.2	8.27	34.0	8.02	31.6	7.78
13.0	11.8	36.2	9.24	36.2	8.94	36.1	8.68	35.2	8.43	34.0	8.18	31.6	7.93	
15.0	13.7	36.2	9.41	36.2	9.11	36.1	8.84	35.2	8.58	34.0	8.33	31.6	8.08	
120	-19.8	-20	16.1	6.48	16.1	6.69	16.0	7.01	16.0	7.31	16.0	7.79	16.0	8.13
	-18.8	-19	16.9	6.64	16.9	6.85	16.8	7.17	16.8	7.47	16.8	7.95	16.8	8.29
	-16.7	-17	18.5	6.98	18.5	7.19	18.4	7.51	18.4	7.81	18.4	8.29	18.4	8.23
	-13.7	-15	20.8	7.46	20.8	7.67	20.7	7.99	20.7	8.29	20.7	8.21	20.7	8.15
	-11.8	-13	22.0	7.76	22.0	7.97	21.9	8.29	21.9	8.24	21.9	8.17	21.9	8.09
	-9.8	-11	23.2	8.08	23.2	8.29	23.1	8.25	23.1	8.19	23.1	8.12	23.1	8.03
	-9.5	-10	23.8	8.13	23.8	8.29	23.6	8.24	23.6	8.18	23.6	8.11	23.6	8.03
	-8.5	-9.1	25.7	8.29	25.7	8.27	25.5	8.22	25.5	8.16	24.7	8.08	24.7	8.00
	-7.0	-7.6	28.4	8.29	28.4	8.25	28.3	8.20	28.3	8.12	25.8	8.05	25.8	7.95
	-5.0	-5.6	32.2	8.29	32.2	8.23	32.0	8.16	32.0	8.07	32.0	8.00	27.4	7.90
	-3.0	-3.7	35.5	8.29	35.5	8.20	34.1	8.12	33.0	8.02	32.0	7.95	28.9	7.84
	0.0	-0.7	35.9	8.30	35.5	8.17	34.1	8.06	33.0	7.94	32.0	7.87	29.7	7.76
	3.0	2.2	35.9	8.30	35.5	8.13	34.1	8.00	33.0	7.87	32.0	7.79	29.7	7.67
	5.0	4.1	35.9	8.30	35.5	8.10	34.1	7.96	33.0	7.82	32.0	7.74	29.7	7.61
	7.0	6	35.9	8.30	35.5	8.08	34.1	7.92	33.0	7.77	32.0	7.69	29.7	7.56
	9.0	7.9	35.9	8.34	35.5	8.12	34.1	7.96	33.0	7.81	32.0	7.73	29.7	7.59
	11.0	9.8	35.9	8.47	35.5	8.24	34.1	8.07	33.0	7.92	32.0	7.85	29.7	7.71
13.0	11.8	35.9	8.59	35.5	8.35	34.1	8.19	33.0	8.03	32.0	7.96	29.7	7.82	
15.0	13.7	35.9	8.71	35.5	8.47	34.1	8.30	33.0	8.14	32.0	8.07	29.7	7.92	
110	-19.8	-20	16.0	6.69	16.0	7.01	15.9	7.31	15.9	7.79	15.9	8.13	15.9	8.29
	-18.8	-19	16.8	6.85	16.8	7.17	16.7	7.47	16.7	7.95	16.7	8.29	16.7	8.24
	-16.7	-17	18.4	7.19	18.4	7.51	18.3	7.81	18.3	8.29	18.3	8.21	18.3	8.15
	-13.7	-15	20.7	7.67	20.7	7.99	20.6	8.29	20.6	8.18	20.6	8.09	20.6	8.01
	-11.8	-13	21.9	7.97	21.9	8.29	21.7	8.22	21.7	8.10	21.7	8.02	21.7	7.92
	-9.8	-11	23.1	8.29	23.1	8.21	23.0	8.14	23.0	8.03	23.0	7.94	23.0	7.83
	-9.5	-10	23.7	8.28	23.7	8.20	23.5	8.12	23.5	8.01	23.5	7.93	23.5	7.82
	-8.5	-9.1	25.5	8.24	25.5	8.16	25.4	8.08	25.4	7.98	24.7	7.89	24.7	7.77
	-7.0	-7.6	28.3	8.19	28.3	8.10	28.1	8.03	28.1	7.92	25.9	7.83	25.9	7.70
	-5.0	-5.6	30.8	8.11	30.8	8.03	30.6	7.95	29.6	7.84	27.1	7.75	26.7	7.61
	-3.0	-3.7	32.6	8.04	32.6	7.95	30.6	7.87	29.6	7.77	28.6	7.68	26.7	7.52
	0.0	-0.7	34.5	7.93	32.6	7.83	30.6	7.75	29.6	7.65	28.6	7.56	26.7	7.38
	3.0	2.2	34.5	7.82	32.6	7.71	30.6	7.63	29.6	7.54	28.6	7.44	26.7	7.25
	5.0	4.1	34.5	7.75	32.6	7.64	30.6	7.55	29.6	7.46	28.6	7.37	26.7	7.15
	7.0	6	34.5	7.67	32.6	7.56	30.6	7.47	29.6	7.38	28.6	7.29	26.7	7.06
	9.0	7.9	34.5	7.67	32.6	7.55	30.6	7.47	29.6	7.38	28.6	7.28	26.7	7.06
	11.0	9.8	34.5	7.74	32.6	7.62	30.6	7.53	29.6	7.44	28.6	7.35	26.7	7.12
13.0	11.8	34.5	7.80	32.6	7.68	30.6	7.60	29.6	7.51	28.6	7.41	26.7	7.18	
15.0	13.7	34.5	7.86	32.6	7.75	30.6	7.66	29.6	7.57	28.6	7.47	26.7	7.24	

Note

1. TC: Total Capacity(kW), PI : Power Input(kW, Comp. + Outdoor fan motor)
2. Capacity tables show the average value of conditions which may occur.
3. In the range beyond the operation limit of the outdoor unit, continuous operation and performance can not be guaranteed. When selecting the outdoor units, avoid the air temperature range that is not guaranteed continuous operation.

7. Capacity Tables

Combination (%)		Heating Capacity (10HP)												
		Outdoor air temp.		Indoor air temp. °C DB										
		°C DB	°C WB	16		18		20		21		22		24
		TC	PI	TC	PI	TC	PI	TC	PI	TC	PI	TC	PI	
100	-19.8	-20	16.0	6.96	16.0	7.23	15.9	7.45	15.9	7.88	15.9	8.18	15.9	8.29
	-18.8	-19	16.7	7.09	16.6	7.36	16.6	7.61	16.6	8.01	16.6	8.29	16.6	8.21
	-16.7	-17	18.2	7.37	18.2	7.64	18.2	7.95	18.1	8.29	18.1	8.14	18.1	8.05
	-13.7	-15	20.6	7.77	20.6	8.04	20.5	8.29	20.5	8.10	20.5	7.93	20.5	7.82
	-11.8	-13	21.8	8.02	21.6	8.29	21.6	8.18	21.6	7.97	21.6	7.80	21.6	7.67
	-9.8	-11	23.0	8.29	23.0	8.17	22.9	8.06	22.9	7.85	22.9	7.66	22.9	7.52
	-9.5	-10	23.5	8.27	23.5	8.16	23.4	8.04	23.4	7.83	23.4	7.63	23.4	7.50
	-8.5	-9.1	25.4	8.22	25.4	8.10	25.3	7.98	27.1	7.76	26.2	7.56	24.4	7.42
	-7.0	-7.6	28.6	8.15	28.5	8.01	28.0	7.90	27.1	7.67	26.2	7.46	24.4	7.30
	-5.0	-5.6	29.9	8.04	29.6	7.89	28.0	7.78	27.1	7.54	26.2	7.32	24.4	7.15
	-3.0	-3.7	30.7	7.94	29.8	7.78	28.0	7.66	27.1	7.41	26.2	7.18	24.4	6.99
	0.0	-0.7	31.6	7.79	29.8	7.60	28.0	7.48	27.1	7.21	26.2	6.96	24.4	6.76
	3.0	2.2	31.6	7.63	29.8	7.43	28.0	7.31	27.1	7.02	26.2	6.75	24.4	6.53
	5.0	4.1	31.6	7.53	29.8	7.31	28.0	7.19	27.1	6.89	26.2	6.61	24.4	6.38
	7.0	6	31.6	7.43	29.8	7.20	28.0	7.07	27.1	6.76	26.2	6.47	24.4	6.22
	9.0	7.9	31.6	7.33	29.8	7.10	28.0	6.97	27.1	6.67	26.2	6.38	24.4	6.14
	11.0	9.8	31.6	7.29	29.8	7.06	28.0	6.94	27.1	6.64	26.2	6.35	24.4	6.11
	13.0	11.8	31.6	7.25	29.8	7.02	28.0	6.90	27.1	6.60	26.2	6.31	24.4	6.07
15.0	13.7	31.6	7.20	29.8	6.97	28.0	6.85	27.1	6.55	26.2	6.27	24.4	6.03	
90	-19.8	-20	15.9	6.56	15.9	7.04	15.8	7.38	15.8	7.54	15.8	7.43	15.8	7.24
	-18.8	-19	16.7	6.72	16.6	7.20	16.5	7.54	16.5	7.48	16.5	7.38	16.5	7.18
	-16.7	-17	18.2	7.06	18.2	7.54	18.1	7.44	18.1	7.38	18.1	7.26	18.1	7.06
	-13.7	-15	20.6	7.54	20.6	7.41	20.4	7.31	20.4	7.23	20.4	7.10	20.4	6.88
	-11.8	-13	21.8	7.47	21.6	7.34	21.6	7.23	21.6	7.13	21.6	7.00	21.6	6.77
	-9.8	-11	23.0	7.39	23.0	7.26	22.8	7.14	22.8	7.03	22.8	6.90	20.9	6.65
	-9.5	-10	23.5	7.38	23.5	7.24	23.3	7.13	23.3	7.02	23.3	6.88	21.4	6.63
	-8.5	-9.1	25.4	7.35	25.2	7.20	25.1	7.08	24.8	6.97	24.0	6.83	22.3	6.57
	-7.0	-7.6	28.6	7.29	27.2	7.14	25.6	7.02	24.8	6.89	24.0	6.75	22.3	6.48
	-5.0	-5.6	28.9	7.22	27.2	7.06	25.6	6.93	24.8	6.79	24.0	6.64	22.3	6.37
	-3.0	-3.7	28.9	7.15	27.2	6.98	25.6	6.84	24.8	6.69	24.0	6.53	22.3	6.25
	0.0	-0.7	28.9	7.04	27.2	6.86	25.6	6.71	24.8	6.54	24.0	6.37	22.3	6.07
	3.0	2.2	28.9	6.93	27.2	6.74	25.6	6.58	24.8	6.39	24.0	6.21	22.3	5.89
	5.0	4.1	28.9	6.86	27.2	6.66	25.6	6.49	24.8	6.29	24.0	6.11	22.3	5.78
	7.0	6	28.9	6.79	27.2	6.58	25.6	6.40	24.8	6.18	24.0	6.00	22.3	5.66
	9.0	7.9	28.9	6.70	27.2	6.49	25.6	6.32	24.8	6.10	24.0	5.92	22.3	5.58
	11.0	9.8	28.9	6.60	27.2	6.40	25.6	6.23	24.8	6.01	24.0	5.84	22.3	5.50
	13.0	11.8	28.9	6.51	27.2	6.31	25.6	6.14	24.8	5.93	24.0	5.75	22.3	5.43
15.0	13.7	28.9	6.42	27.2	6.22	25.6	6.05	24.8	5.85	24.0	5.67	22.3	5.35	
80	-19.8	-20	15.7	5.71	15.7	6.19	15.7	6.68	15.7	6.58	15.7	6.43	15.7	6.26
	-18.8	-19	16.5	5.87	16.5	6.68	16.5	6.64	16.5	6.53	16.5	6.37	16.5	6.21
	-16.7	-17	18.1	6.68	18.1	6.59	18.1	6.54	18.1	6.42	18.1	6.27	18.1	6.09
	-13.7	-15	21.3	6.57	20.9	6.47	20.4	6.40	20.4	6.27	20.4	6.11	19.9	5.93
	-11.8	-13	23.1	6.50	22.4	6.39	21.6	6.31	21.6	6.17	21.4	6.01	19.9	5.83
	-9.8	-11	23.8	6.42	23.1	6.31	22.8	6.22	22.2	6.07	21.4	5.91	19.9	5.72
	-9.5	-10	24.0	6.41	23.3	6.30	22.9	6.21	22.2	6.06	21.4	5.90	19.9	5.71
	-8.5	-9.1	24.9	6.37	24.4	6.26	22.9	6.16	22.2	6.01	21.4	5.85	19.9	5.65
	-7.0	-7.6	25.9	6.31	24.4	6.19	22.9	6.09	22.2	5.93	21.4	5.77	19.9	5.57
	-5.0	-5.6	25.9	6.24	24.4	6.11	22.9	6.00	22.2	5.83	21.4	5.67	19.9	5.47
	-3.0	-3.7	25.9	6.16	24.4	6.03	22.9	5.91	22.2	5.73	21.4	5.56	19.9	5.36
	0.0	-0.7	25.9	6.05	24.4	5.90	22.9	5.77	22.2	5.58	21.4	5.41	19.9	5.20
	3.0	2.2	25.9	5.93	24.4	5.78	22.9	5.63	22.2	5.42	21.4	5.26	19.9	5.04
	5.0	4.1	25.9	5.86	24.4	5.70	22.9	5.54	22.2	5.32	21.4	5.15	19.9	4.93
	7.0	6	25.9	5.78	24.4	5.61	22.9	5.45	22.2	5.22	21.4	5.05	19.9	4.82
	9.0	7.9	25.9	5.43	24.4	5.27	22.9	5.12	22.2	4.90	21.4	4.74	19.9	4.53
	11.0	9.8	25.9	5.04	24.4	4.89	22.9	4.75	22.2	4.55	21.4	4.40	19.9	4.20
	13.0	11.8	25.9	4.70	24.4	4.57	22.9	4.43	22.2	4.25	21.4	4.11	19.9	3.92
15.0	13.7	25.9	4.43	24.4	4.30	22.9	4.17	22.2	4.00	21.4	3.87	19.9	3.69	

Note

1. TC: Total Capacity(kW), PI: Power Input(kW, Comp. + Outdoor fan motor)
2. Capacity tables show the average value of conditions which may occur.
3. In the range beyond the operation limit of the outdoor unit, continuous operation and performance can not be guaranteed. When selecting the outdoor units, avoid the air temperature range that is not guaranteed continuous operation.

7. Capacity Tables

Combination (%)		Heating Capacity (10HP)												
		Outdoor air temp.		Indoor air temp. °C DB										
		°C DB	°C WB	16		18		20		21		22		24
		TC	PI	TC	PI	TC	PI	TC	PI	TC	PI	TC	PI	
70	-19.8	-20	15.7	6.04	15.7	6.20	15.7	6.10	15.7	5.93	15.7	5.77	15.7	5.59
	-18.8	-19	16.5	6.20	16.5	6.15	16.5	6.04	16.5	5.87	16.5	5.71	16.5	5.53
	-16.7	-17	18.1	6.11	18.1	6.04	18.1	5.93	18.1	5.76	18.1	5.60	17.1	5.41
	-13.7	-15	22.0	5.97	20.7	5.89	19.5	5.77	18.8	5.59	18.3	5.44	17.1	5.24
	-11.8	-13	22.0	5.89	20.7	5.79	19.5	5.67	18.8	5.49	18.3	5.34	17.1	5.14
	-9.8	-11	22.0	5.79	20.7	5.69	19.5	5.56	18.8	5.38	18.3	5.23	17.1	5.02
	-9.5	-10	22.0	5.78	20.7	5.68	19.5	5.55	18.8	5.36	18.3	5.21	17.1	5.00
	-8.5	-9.1	22.0	5.74	20.7	5.62	19.5	5.49	18.8	5.31	18.3	5.16	17.1	4.95
	-7.0	-7.6	22.0	5.67	20.7	5.55	19.5	5.41	18.8	5.23	18.3	5.08	17.1	4.86
	-5.0	-5.6	22.0	5.58	20.7	5.45	19.5	5.31	18.8	5.12	18.3	4.97	17.1	4.75
	-3.0	-3.7	22.0	5.49	20.7	5.34	19.5	5.20	18.8	5.01	18.3	4.86	17.1	4.64
	0.0	-0.7	22.0	5.35	20.7	5.19	19.5	5.04	18.8	4.84	18.3	4.70	17.1	4.46
	3.0	2.2	22.0	5.22	20.7	5.04	19.5	4.88	18.8	4.68	18.3	4.54	17.1	4.29
	5.0	4.1	22.0	5.13	20.7	4.93	19.5	4.78	18.8	4.57	18.3	4.43	17.1	4.18
	7.0	6	22.0	5.03	20.7	4.83	19.5	4.67	18.8	4.46	18.3	4.32	17.1	4.07
	9.0	7.9	22.0	4.55	20.7	4.36	19.5	4.22	18.8	4.03	18.3	3.91	17.1	3.67
	11.0	9.8	22.0	4.23	20.7	4.06	19.5	3.93	18.8	3.75	18.3	3.64	17.1	3.42
13.0	11.8	22.0	3.96	20.7	3.80	19.5	3.67	18.8	3.51	18.3	3.40	17.1	3.20	
15.0	13.7	22.0	3.73	20.7	3.58	19.5	3.46	18.8	3.31	18.3	3.21	17.1	3.02	
60	-19.8	-20	18.8	5.72	17.8	5.61	15.7	5.45	15.7	5.29	15.6	5.13	14.6	4.95
	-18.8	-19	18.8	5.67	17.8	5.56	16.5	5.39	16.2	5.23	15.6	5.07	14.6	4.89
	-16.7	-17	18.8	5.58	17.8	5.45	16.7	5.28	16.2	5.12	15.6	4.96	14.6	4.77
	-13.7	-15	18.8	5.44	17.8	5.29	16.7	5.12	16.2	4.96	15.6	4.80	14.6	4.60
	-11.8	-13	18.8	5.35	17.8	5.19	16.7	5.01	16.2	4.85	15.6	4.69	14.6	4.49
	-9.8	-11	18.8	5.25	17.8	5.08	16.7	4.90	16.2	4.74	15.6	4.58	14.6	4.38
	-9.5	-10	18.8	5.24	17.8	5.06	16.7	4.89	16.2	4.73	15.6	4.57	14.6	4.36
	-8.5	-9.1	18.8	5.19	17.8	5.01	16.7	4.83	16.2	4.67	15.6	4.51	14.6	4.30
	-7.0	-7.6	18.8	5.12	17.8	4.93	16.7	4.75	16.2	4.59	15.6	4.43	14.6	4.22
	-5.0	-5.6	18.8	5.03	17.8	4.82	16.7	4.64	16.2	4.48	15.6	4.33	14.6	4.10
	-3.0	-3.7	18.8	4.93	17.8	4.72	16.7	4.53	16.2	4.38	15.6	4.22	14.6	3.99
	0.0	-0.7	18.8	4.79	17.8	4.56	16.7	4.37	16.2	4.21	15.6	4.06	14.6	3.82
	3.0	2.2	18.8	4.65	17.8	4.40	16.7	4.21	16.2	4.05	15.6	3.89	14.6	3.65
	5.0	4.1	18.8	4.56	17.8	4.29	16.7	4.10	16.2	3.94	15.6	3.79	14.6	3.53
	7.0	6	18.8	4.47	17.8	4.18	16.7	3.99	16.2	3.83	15.6	3.68	14.6	3.42
	9.0	7.9	18.8	3.99	17.8	3.73	16.7	3.56	16.2	3.42	15.6	3.28	14.6	3.05
	11.0	9.8	18.8	3.72	17.8	3.49	16.7	3.32	16.2	3.19	15.6	3.06	14.6	2.85
13.0	11.8	18.8	3.49	17.8	3.26	16.7	3.11	16.2	2.99	15.6	2.87	14.6	2.67	
15.0	13.7	18.8	3.29	17.8	3.09	16.7	2.94	16.2	2.83	15.6	2.71	14.6	2.52	
50	-19.8	-20	15.7	5.13	14.8	4.95	13.9	4.78	13.5	4.61	13.0	4.45	12.2	4.28
	-18.8	-19	15.7	5.07	14.8	4.89	13.9	4.72	13.5	4.55	13.0	4.40	12.2	4.23
	-16.7	-17	15.7	4.95	14.8	4.77	13.9	4.60	13.5	4.43	13.0	4.28	12.2	4.11
	-13.7	-15	15.7	4.78	14.8	4.59	13.9	4.43	13.5	4.26	13.0	4.12	12.2	3.94
	-11.8	-13	15.7	4.67	14.8	4.48	13.9	4.32	13.5	4.16	13.0	4.02	12.2	3.84
	-9.8	-11	15.7	4.56	14.8	4.36	13.9	4.21	13.5	4.04	13.0	3.91	12.2	3.73
	-9.5	-10	15.7	4.54	14.8	4.34	13.9	4.19	13.5	4.02	13.0	3.89	12.2	3.71
	-8.5	-9.1	15.7	4.48	14.8	4.28	13.9	4.13	13.5	3.97	13.0	3.84	12.2	3.65
	-7.0	-7.6	15.7	4.40	14.8	4.20	13.9	4.05	13.5	3.88	13.0	3.75	12.2	3.57
	-5.0	-5.6	15.7	4.29	14.8	4.08	13.9	3.93	13.5	3.77	13.0	3.64	12.2	3.46
	-3.0	-3.7	15.7	4.17	14.8	3.96	13.9	3.82	13.5	3.66	13.0	3.54	12.2	3.35
	0.0	-0.7	15.7	4.00	14.8	3.78	13.9	3.65	13.5	3.48	13.0	3.37	12.2	3.18
	3.0	2.2	15.7	3.83	14.8	3.61	13.9	3.48	13.5	3.31	13.0	3.21	12.2	3.01
	5.0	4.1	15.7	3.72	14.8	3.49	13.9	3.36	13.5	3.20	13.0	3.10	12.2	2.90
	7.0	6	15.7	3.60	14.8	3.37	13.9	3.25	13.5	3.09	13.0	2.99	12.2	2.79
	9.0	7.9	15.7	3.25	14.8	3.05	13.9	2.93	13.5	2.79	13.0	2.70	12.2	2.52
	11.0	9.8	15.7	3.04	14.8	2.85	13.9	2.75	13.5	2.61	13.0	2.53	12.2	2.36
13.0	11.8	15.7	2.86	14.8	2.68	13.9	2.58	13.5	2.45	13.0	2.37	12.2	2.21	
15.0	13.7	15.7	2.70	14.8	2.53	13.9	2.44	13.5	2.32	13.0	2.25	12.2	2.09	

Note

1. TC: Total Capacity(kW), PI : Power Input(kW, Comp. + Outdoor fan motor)
2. Capacity tables show the average value of conditions which may occur.
3. In the range beyond the operation limit of the outdoor unit, continuous operation and performance can not be guaranteed. When selecting the outdoor units, avoid the air temperature range that is not guaranteed continuous operation.

7. Capacity Tables

◆ A(C)RUN120LLS5

Combination (%)	Outdoor air temp.		Indoor air temp. °C DB											
	°C DB	°C WB	16		18		20		21		22		24	
			TC	PI	TC	PI	TC	PI	TC	PI	TC	PI	TC	PI
130	-19.8	-20	19.4	8.03	19.4	8.34	19.3	8.61	19.3	9.02	19.3	9.41	19.3	10.03
	-18.8	-19	20.4	8.24	20.4	8.55	20.2	8.81	20.2	9.23	20.2	9.62	20.2	10.24
	-16.7	-17	22.4	8.67	22.4	8.98	22.2	9.25	22.2	9.66	22.2	10.05	22.2	10.67
	-13.7	-15	25.2	9.29	25.2	9.60	25.0	9.87	25.0	10.28	25.0	10.67	25.0	10.55
	-11.8	-13	26.6	9.68	26.6	9.99	26.4	10.26	26.4	10.67	26.4	10.61	26.4	10.47
	-9.8	-11	28.1	10.09	28.1	10.40	27.9	10.67	27.9	10.63	27.9	10.55	27.9	10.39
	-9.5	-10	28.8	10.15	28.8	10.46	28.6	10.67	28.6	10.63	28.1	10.54	28.1	10.38
	-8.5	-9.1	31.0	10.36	31.0	10.67	30.8	10.67	30.8	10.61	28.9	10.51	28.9	10.34
	-7.0	-7.6	34.4	10.67	34.4	10.70	34.2	10.66	34.2	10.58	34.2	10.46	31.4	10.28
	-5.0	-5.6	38.9	10.76	38.9	10.74	38.6	10.66	38.6	10.55	38.6	10.40	33.2	10.20
	-3.0	-3.7	43.4	10.86	43.4	10.77	43.1	10.66	42.2	10.51	40.7	10.34	35.1	10.13
	0.0	-0.7	43.4	11.00	43.4	10.83	43.3	10.66	42.2	10.46	40.7	10.25	37.9	10.01
	3.0	2.2	43.4	11.14	43.4	10.89	43.3	10.65	42.2	10.41	40.7	10.15	37.9	9.89
	5.0	4.1	43.4	11.24	43.4	10.93	43.3	10.65	42.2	10.37	40.7	10.09	37.9	9.81
	7.0	6	43.4	11.33	43.4	10.97	43.3	10.65	42.2	10.34	40.7	10.03	37.9	9.73
	9.0	7.9	43.4	11.44	43.4	11.07	43.3	10.75	42.2	10.44	40.7	10.13	37.9	9.82
	11.0	9.8	43.4	11.67	43.4	11.29	43.3	10.96	42.2	10.64	40.7	10.33	37.9	10.02
13.0	11.8	43.4	11.89	43.4	11.51	43.3	11.17	42.2	10.85	40.7	10.52	37.9	10.21	
15.0	13.7	43.4	12.11	43.4	11.72	43.3	11.38	42.2	11.05	40.7	10.72	37.9	10.40	
120	-19.8	-20	19.3	8.34	19.3	8.61	19.2	9.02	19.2	9.41	19.2	10.03	19.2	10.46
	-18.8	-19	20.2	8.55	20.2	8.81	20.1	9.23	20.1	9.62	20.1	10.24	20.1	10.67
	-16.7	-17	22.2	8.98	22.2	9.25	22.1	9.66	22.1	10.05	22.1	10.67	22.1	10.59
	-13.7	-15	25.0	9.60	25.0	9.87	24.9	10.28	24.9	10.67	24.9	10.57	24.9	10.48
	-11.8	-13	26.4	9.99	26.4	10.26	26.3	10.67	26.3	10.61	26.3	10.51	26.3	10.41
	-9.8	-11	27.9	10.40	27.9	10.67	27.7	10.62	27.7	10.54	27.7	10.45	27.7	10.34
	-9.5	-10	28.5	10.46	28.5	10.66	28.4	10.61	28.4	10.53	28.4	10.44	28.4	10.33
	-8.5	-9.1	30.8	10.67	30.8	10.65	30.6	10.58	30.6	10.50	29.7	10.40	29.7	10.29
	-7.0	-7.6	34.1	10.67	34.1	10.62	33.9	10.55	33.9	10.45	31.1	10.35	31.1	10.24
	-5.0	-5.6	38.6	10.67	38.6	10.59	38.4	10.50	38.4	10.39	38.4	10.29	33.0	10.16
	-3.0	-3.7	42.6	10.67	42.6	10.56	40.9	10.45	39.6	10.32	38.4	10.23	34.9	10.09
	0.0	-0.7	43.1	10.68	42.6	10.51	40.9	10.37	39.6	10.22	38.4	10.13	35.6	9.98
	3.0	2.2	43.1	10.68	42.6	10.46	40.9	10.29	39.6	10.13	38.4	10.03	35.6	9.87
	5.0	4.1	43.1	10.68	42.6	10.43	40.9	10.24	39.6	10.06	38.4	9.97	35.6	9.80
	7.0	6	43.1	10.69	42.6	10.40	40.9	10.19	39.6	10.00	38.4	9.90	35.6	9.73
	9.0	7.9	43.1	10.74	42.6	10.45	40.9	10.24	39.6	10.05	38.4	9.95	35.6	9.77
	11.0	9.8	43.1	10.90	42.6	10.60	40.9	10.39	39.6	10.19	38.4	10.10	35.6	9.92
13.0	11.8	43.1	11.05	42.6	10.75	40.9	10.54	39.6	10.34	38.4	10.24	35.6	10.06	
15.0	13.7	43.1	11.21	42.6	10.90	40.9	10.69	39.6	10.48	38.4	10.38	35.6	10.20	
110	-19.8	-20	19.2	8.61	19.2	9.02	19.1	9.41	19.1	10.03	19.1	10.46	19.1	10.67
	-18.8	-19	20.1	8.81	20.1	9.23	20.0	9.62	20.0	10.24	20.0	10.67	20.0	10.61
	-16.7	-17	22.1	9.25	22.1	9.66	21.9	10.05	21.9	10.67	21.9	10.56	21.9	10.49
	-13.7	-15	24.9	9.87	24.9	10.28	24.7	10.67	24.7	10.52	24.7	10.41	24.7	10.31
	-11.8	-13	26.3	10.26	26.3	10.67	26.1	10.57	26.1	10.43	26.1	10.32	26.1	10.20
	-9.8	-11	27.7	10.67	27.7	10.57	27.6	10.47	27.6	10.33	27.6	10.22	27.6	10.08
	-9.5	-10	28.4	10.65	28.4	10.55	28.2	10.46	28.2	10.31	28.2	10.20	28.2	10.06
	-8.5	-9.1	30.6	10.61	30.6	10.50	30.4	10.40	30.4	10.26	29.6	10.15	29.6	10.00
	-7.0	-7.6	34.0	10.54	34.0	10.43	33.7	10.33	33.7	10.19	31.0	10.08	31.0	9.91
	-5.0	-5.6	37.0	10.44	37.0	10.33	36.7	10.23	35.5	10.09	32.5	9.98	32.1	9.80
	-3.0	-3.7	39.1	10.35	39.1	10.23	36.7	10.13	35.5	9.99	34.3	9.88	32.1	9.68
	0.0	-0.7	41.4	10.21	39.1	10.08	36.7	9.97	35.5	9.85	34.3	9.73	32.1	9.50
	3.0	2.2	41.4	10.06	39.1	9.93	36.7	9.82	35.5	9.70	34.3	9.58	32.1	9.33
	5.0	4.1	41.4	9.97	39.1	9.83	36.7	9.72	35.5	9.60	34.3	9.48	32.1	9.21
	7.0	6	41.4	9.88	39.1	9.73	36.7	9.62	35.5	9.50	34.3	9.38	32.1	9.09
	9.0	7.9	41.4	9.87	39.1	9.72	36.7	9.61	35.5	9.50	34.3	9.37	32.1	9.08
	11.0	9.8	41.4	9.96	39.1	9.81	36.7	9.70	35.5	9.58	34.3	9.46	32.1	9.17
13.0	11.8	41.4	10.04	39.1	9.89	36.7	9.78	35.5	9.66	34.3	9.54	32.1	9.24	
15.0	13.7	41.4	10.12	39.1	9.97	36.7	9.86	35.5	9.74	34.3	9.61	32.1	9.32	

Note

1. TC: Total Capacity(kW), PI : Power Input(kW, Comp. + Outdoor fan motor)
2. Capacity tables show the average value of conditions which may occur.
3. In the range beyond the operation limit of the outdoor unit, continuous operation and performance can not be guaranteed. When selecting the outdoor units, avoid the air temperature range that is not guaranteed continuous operation.

7. Capacity Tables

Combination (%)		Heating Capacity (12HP)												
		Outdoor air temp.		Indoor air temp. °C DB										
		°C DB	°C WB	16		18		20		21		22		24
		TC	PI	TC	PI	TC	PI	TC	PI	TC	PI	TC	PI	
100	-19.8	-20	19.1	8.96	19.1	9.30	19.0	9.59	19.0	10.14	19.0	10.52	19.0	10.67
	-18.8	-19	20.0	9.13	19.9	9.47	19.9	9.80	19.9	10.31	19.9	10.67	19.9	10.57
	-16.7	-17	21.9	9.49	21.9	9.83	21.9	10.23	21.7	10.67	21.7	10.48	21.7	10.36
	-13.7	-15	24.8	10.00	24.8	10.34	24.6	10.67	24.6	10.42	24.6	10.21	24.6	10.06
	-11.8	-13	26.1	10.33	26.0	10.67	26.0	10.52	26.0	10.26	26.0	10.03	26.0	9.88
	-9.8	-11	27.6	10.67	27.6	10.52	27.4	10.37	27.4	10.10	27.4	9.85	27.4	9.68
	-9.5	-10	28.2	10.65	28.2	10.50	28.1	10.35	28.1	10.07	28.1	9.83	28.1	9.65
	-8.5	-9.1	30.4	10.58	30.4	10.42	30.3	10.27	32.5	9.99	31.4	9.73	29.3	9.55
	-7.0	-7.6	34.3	10.48	34.2	10.31	33.6	10.16	32.5	9.87	31.4	9.60	29.3	9.40
	-5.0	-5.6	35.8	10.35	35.5	10.16	33.6	10.01	32.5	9.70	31.4	9.42	29.3	9.20
	-3.0	-3.7	36.9	10.22	35.8	10.01	33.6	9.86	32.5	9.53	31.4	9.24	29.3	9.00
	0.0	-0.7	37.9	10.02	35.8	9.79	33.6	9.63	32.5	9.29	31.4	8.96	29.3	8.71
	3.0	2.2	37.9	9.82	35.8	9.56	33.6	9.40	32.5	9.04	31.4	8.69	29.3	8.41
	5.0	4.1	37.9	9.69	35.8	9.41	33.6	9.25	32.5	8.87	31.4	8.51	29.3	8.21
	7.0	6	37.9	9.56	35.8	9.26	33.6	9.10	32.5	8.71	31.4	8.33	29.3	8.01
	9.0	7.9	37.9	9.43	35.8	9.13	33.6	8.97	32.5	8.59	31.4	8.21	29.3	7.90
	11.0	9.8	37.9	9.38	35.8	9.09	33.6	8.93	32.5	8.55	31.4	8.18	29.3	7.86
13.0	11.8	37.9	9.33	35.8	9.04	33.6	8.88	32.5	8.50	31.4	8.13	29.3	7.82	
15.0	13.7	37.9	9.27	35.8	8.98	33.6	8.82	32.5	8.44	31.4	8.07	29.3	7.77	
90	-19.8	-20	19.0	8.44	19.0	9.06	18.9	9.49	18.9	9.70	18.9	9.56	18.9	9.32
	-18.8	-19	20.0	8.65	19.9	9.27	19.8	9.70	19.8	9.63	19.8	9.49	19.8	9.24
	-16.7	-17	21.9	9.08	21.9	9.70	21.8	9.58	21.8	9.50	21.8	9.35	21.8	9.08
	-13.7	-15	24.8	9.70	24.8	9.54	24.5	9.41	24.5	9.30	24.5	9.14	24.5	8.86
	-11.8	-13	26.1	9.61	26.0	9.44	25.9	9.30	25.9	9.18	25.9	9.01	25.9	8.71
	-9.8	-11	27.6	9.52	27.6	9.34	27.3	9.19	27.3	9.05	27.3	8.88	25.1	8.56
	-9.5	-10	28.2	9.50	28.2	9.32	28.0	9.17	28.0	9.03	28.0	8.86	25.7	8.54
	-8.5	-9.1	30.4	9.46	30.2	9.27	30.2	9.12	29.8	8.97	28.8	8.79	26.8	8.46
	-7.0	-7.6	34.3	9.39	32.7	9.20	30.7	9.03	29.8	8.87	28.8	8.68	26.8	8.35
	-5.0	-5.6	34.7	9.29	32.7	9.09	30.7	8.92	29.8	8.74	28.8	8.55	26.8	8.19
	-3.0	-3.7	34.7	9.20	32.7	8.99	30.7	8.81	29.8	8.61	28.8	8.41	26.8	8.04
	0.0	-0.7	34.7	9.06	32.7	8.83	30.7	8.64	29.8	8.41	28.8	8.20	26.8	7.81
	3.0	2.2	34.7	8.92	32.7	8.68	30.7	8.47	29.8	8.22	28.8	8.00	26.8	7.59
	5.0	4.1	34.7	8.83	32.7	8.57	30.7	8.35	29.8	8.09	28.8	7.86	26.8	7.44
	7.0	6	34.7	8.74	32.7	8.47	30.7	8.24	29.8	7.96	28.8	7.72	26.8	7.28
	9.0	7.9	34.7	8.62	32.7	8.35	30.7	8.13	29.8	7.85	28.8	7.62	26.8	7.18
	11.0	9.8	34.7	8.50	32.7	8.24	30.7	8.02	29.8	7.74	28.8	7.51	26.8	7.08
13.0	11.8	34.7	8.38	32.7	8.12	30.7	7.90	29.8	7.63	28.8	7.41	26.8	6.98	
15.0	13.7	34.7	8.26	32.7	8.00	30.7	7.79	29.8	7.52	28.8	7.30	26.8	6.88	
80	-19.8	-20	18.8	7.34	18.8	7.96	18.8	8.60	18.8	8.47	18.8	8.27	18.8	8.06
	-18.8	-19	19.7	7.55	19.7	8.60	19.7	8.54	19.7	8.40	19.7	8.20	19.7	7.99
	-16.7	-17	21.8	8.60	21.8	8.49	21.8	8.42	21.8	8.27	21.8	8.07	21.8	7.84
	-13.7	-15	25.7	8.45	25.1	8.33	24.5	8.24	24.5	8.07	24.5	7.87	23.9	7.64
	-11.8	-13	27.7	8.36	26.9	8.23	25.9	8.13	25.9	7.95	25.7	7.74	23.9	7.50
	-9.8	-11	28.6	8.26	27.7	8.12	27.3	8.01	26.7	7.82	25.7	7.61	23.9	7.37
	-9.5	-10	28.8	8.25	28.0	8.10	27.5	7.99	26.7	7.80	25.7	7.59	23.9	7.35
	-8.5	-9.1	29.9	8.20	29.3	8.05	27.5	7.93	26.7	7.73	25.7	7.52	23.9	7.28
	-7.0	-7.6	31.1	8.13	29.3	7.97	27.5	7.84	26.7	7.63	25.7	7.42	23.9	7.17
	-5.0	-5.6	31.1	8.03	29.3	7.87	27.5	7.72	26.7	7.50	25.7	7.29	23.9	7.03
	-3.0	-3.7	31.1	7.93	29.3	7.76	27.5	7.60	26.7	7.37	25.7	7.16	23.9	6.90
	0.0	-0.7	31.1	7.78	29.3	7.60	27.5	7.43	26.7	7.18	25.7	6.96	23.9	6.69
	3.0	2.2	31.1	7.64	29.3	7.44	27.5	7.25	26.7	6.98	25.7	6.76	23.9	6.48
	5.0	4.1	31.1	7.54	29.3	7.33	27.5	7.13	26.7	6.85	25.7	6.63	23.9	6.34
	7.0	6	31.1	7.44	29.3	7.23	27.5	7.01	26.7	6.72	25.7	6.50	23.9	6.21
	9.0	7.9	31.1	7.34	29.3	7.13	27.5	6.90	26.7	6.59	25.7	6.38	23.9	6.08
	11.0	9.8	31.1	7.24	29.3	7.03	27.5	6.79	26.7	6.48	25.7	6.27	23.9	5.95
13.0	11.8	31.1	7.14	29.3	6.93	27.5	6.68	26.7	6.37	25.7	6.16	23.9	5.82	
15.0	13.7	31.1	7.04	29.3	6.83	27.5	6.57	26.7	6.26	25.7	6.05	23.9	5.69	

Note

1. TC: Total Capacity(kW), PI: Power Input(kW, Comp. + Outdoor fan motor)
2. Capacity tables show the average value of conditions which may occur.
3. In the range beyond the operation limit of the outdoor unit, continuous operation and performance can not be guaranteed. When selecting the outdoor units, avoid the air temperature range that is not guaranteed continuous operation.

7. Capacity Tables

Combination (%)		Heating Capacity (12HP)												
		Outdoor air temp.		Indoor air temp. °C DB										
		°C DB	°C WB	16		18		20		21		22		24
		TC	PI	TC	PI	TC	PI	TC	PI	TC	PI	TC	PI	
70	-19.8	-20	18.8	7.78	18.8	7.98	18.8	7.85	18.8	7.63	18.8	7.42	18.8	7.20
	-18.8	-19	19.7	7.98	19.7	7.92	19.7	7.78	19.7	7.56	19.7	7.35	19.7	7.12
	-16.7	-17	21.8	7.86	21.8	7.78	21.8	7.63	21.8	7.41	21.8	7.21	20.5	6.97
	-13.7	-15	26.4	7.69	24.9	7.58	23.4	7.43	22.6	7.20	21.9	7.00	20.5	6.75
	-11.8	-13	26.4	7.57	24.9	7.46	23.4	7.30	22.6	7.07	21.9	6.87	20.5	6.61
	-9.8	-11	26.4	7.46	24.9	7.32	23.4	7.16	22.6	6.92	21.9	6.73	20.5	6.46
	-9.5	-10	26.4	7.44	24.9	7.30	23.4	7.14	22.6	6.90	21.9	6.71	20.5	6.44
	-8.5	-9.1	26.4	7.38	24.9	7.24	23.4	7.07	22.6	6.83	21.9	6.64	20.5	6.37
	-7.0	-7.6	26.4	7.30	24.9	7.14	23.4	6.97	22.6	6.73	21.9	6.54	20.5	6.26
	-5.0	-5.6	26.4	7.18	24.9	7.01	23.4	6.83	22.6	6.59	21.9	6.40	20.5	6.11
	-3.0	-3.7	26.4	7.06	24.9	6.88	23.4	6.70	22.6	6.44	21.9	6.26	20.5	5.97
	0.0	-0.7	26.4	6.89	24.9	6.68	23.4	6.49	22.6	6.23	21.9	6.05	20.5	5.75
	3.0	2.2	26.4	6.71	24.9	6.48	23.4	6.29	22.6	6.02	21.9	5.84	20.5	5.53
	5.0	4.1	26.4	6.60	24.9	6.35	23.4	6.15	22.6	5.88	21.9	5.71	20.5	5.38
	7.0	6	26.4	6.48	24.9	6.22	23.4	6.01	22.6	5.74	21.9	5.57	20.5	5.23
	9.0	7.9	26.4	5.85	24.9	5.62	23.4	5.43	22.6	5.18	21.9	5.03	20.5	4.73
	11.0	9.8	26.4	5.45	24.9	5.23	23.4	5.05	22.6	4.83	21.9	4.68	20.5	4.40
	13.0	11.8	26.4	5.10	24.9	4.89	23.4	4.73	22.6	4.52	21.9	4.38	20.5	4.12
15.0	13.7	26.4	4.81	24.9	4.61	23.4	4.46	22.6	4.26	21.9	4.13	20.5	3.88	
60	-19.8	-20	22.6	7.36	21.4	7.23	18.8	7.01	18.8	6.80	18.7	6.60	17.5	6.37
	-18.8	-19	22.6	7.30	21.4	7.16	19.7	6.94	19.4	6.73	18.7	6.53	17.5	6.30
	-16.7	-17	22.6	7.18	21.4	7.01	20.1	6.80	19.4	6.59	18.7	6.38	17.5	6.14
	-13.7	-15	22.6	7.00	21.4	6.81	20.1	6.59	19.4	6.38	18.7	6.17	17.5	5.92
	-11.8	-13	22.6	6.88	21.4	6.68	20.1	6.45	19.4	6.25	18.7	6.04	17.5	5.78
	-9.8	-11	22.6	6.76	21.4	6.54	20.1	6.31	19.4	6.11	18.7	5.90	17.5	5.63
	-9.5	-10	22.6	6.74	21.4	6.52	20.1	6.29	19.4	6.09	18.7	5.88	17.5	5.61
	-8.5	-9.1	22.6	6.68	21.4	6.45	20.1	6.22	19.4	6.02	18.7	5.81	17.5	5.54
	-7.0	-7.6	22.6	6.59	21.4	6.35	20.1	6.12	19.4	5.91	18.7	5.71	17.5	5.43
	-5.0	-5.6	22.6	6.47	21.4	6.21	20.1	5.98	19.4	5.77	18.7	5.57	17.5	5.28
	-3.0	-3.7	22.6	6.35	21.4	6.07	20.1	5.83	19.4	5.63	18.7	5.43	17.5	5.14
	0.0	-0.7	22.6	6.17	21.4	5.87	20.1	5.62	19.4	5.42	18.7	5.22	17.5	4.91
	3.0	2.2	22.6	5.99	21.4	5.66	20.1	5.41	19.4	5.21	18.7	5.01	17.5	4.69
	5.0	4.1	22.6	5.87	21.4	5.52	20.1	5.27	19.4	5.07	18.7	4.87	17.5	4.55
	7.0	6	22.6	5.75	21.4	5.38	20.1	5.13	19.4	4.93	18.7	4.73	17.5	4.40
	9.0	7.9	22.6	5.13	21.4	4.80	20.1	4.58	19.4	4.40	18.7	4.22	17.5	3.93
	11.0	9.8	22.6	4.79	21.4	4.49	20.1	4.28	19.4	4.11	18.7	3.94	17.5	3.67
	13.0	11.8	22.6	4.49	21.4	4.20	20.1	4.01	19.4	3.85	18.7	3.69	17.5	3.43
15.0	13.7	22.6	4.24	21.4	3.97	20.1	3.79	19.4	3.64	18.7	3.49	17.5	3.25	
50	-19.8	-20	18.9	6.60	17.8	6.37	16.7	6.15	16.2	5.93	15.7	5.73	14.6	5.51
	-18.8	-19	18.9	6.53	17.8	6.29	16.7	6.08	16.2	5.86	15.7	5.66	14.6	5.44
	-16.7	-17	18.9	6.37	17.8	6.13	16.7	5.92	16.2	5.71	15.7	5.51	14.6	5.29
	-13.7	-15	18.9	6.15	17.8	5.91	16.7	5.70	16.2	5.49	15.7	5.30	14.6	5.07
	-11.8	-13	18.9	6.01	17.8	5.76	16.7	5.56	16.2	5.35	15.7	5.17	14.6	4.94
	-9.8	-11	18.9	5.87	17.8	5.61	16.7	5.42	16.2	5.20	15.7	5.03	14.6	4.79
	-9.5	-10	18.9	5.85	17.8	5.59	16.7	5.39	16.2	5.18	15.7	5.01	14.6	4.77
	-8.5	-9.1	18.9	5.77	17.8	5.51	16.7	5.32	16.2	5.11	15.7	4.94	14.6	4.70
	-7.0	-7.6	18.9	5.66	17.8	5.40	16.7	5.21	16.2	5.00	15.7	4.83	14.6	4.59
	-5.0	-5.6	18.9	5.52	17.8	5.25	16.7	5.06	16.2	4.85	15.7	4.69	14.6	4.45
	-3.0	-3.7	18.9	5.37	17.8	5.10	16.7	4.92	16.2	4.70	15.7	4.55	14.6	4.31
	0.0	-0.7	18.9	5.15	17.8	4.87	16.7	4.70	16.2	4.48	15.7	4.34	14.6	4.09
	3.0	2.2	18.9	4.93	17.8	4.64	16.7	4.48	16.2	4.27	15.7	4.13	14.6	3.88
	5.0	4.1	18.9	4.78	17.8	4.49	16.7	4.33	16.2	4.12	15.7	3.99	14.6	3.73
	7.0	6	18.9	4.64	17.8	4.34	16.7	4.18	16.2	3.97	15.7	3.85	14.6	3.59
	9.0	7.9	18.9	4.19	17.8	3.92	16.7	3.78	16.2	3.59	15.7	3.48	14.6	3.24
	11.0	9.8	18.9	3.92	17.8	3.67	16.7	3.53	16.2	3.36	15.7	3.25	14.6	3.03
	13.0	11.8	18.9	3.68	17.8	3.44	16.7	3.32	16.2	3.15	15.7	3.05	14.6	2.85
15.0	13.7	18.9	3.48	17.8	3.26	16.7	3.14	16.2	2.98	15.7	2.89	14.6	2.70	

Note

1. TC: Total Capacity(kW), PI : Power Input(kW, Comp. + Outdoor fan motor)
2. Capacity tables show the average value of conditions which may occur.
3. In the range beyond the operation limit of the outdoor unit, continuous operation and performance can not be guaranteed. When selecting the outdoor units, avoid the air temperature range that is not guaranteed continuous operation.

7. Capacity Tables

◆ A(C)RUN140LLS5

Combination (%)	Outdoor air temp.		Indoor air temp. °C DB											
	°C DB	°C WB	16		18		20		21		22		24	
			TC	PI	TC	PI	TC	PI	TC	PI	TC	PI	TC	PI
130	-19.8	-20	22.7	10.22	22.7	10.62	22.6	10.96	22.6	11.49	22.6	11.99	22.6	12.78
	-18.8	-19	23.8	10.49	23.8	10.88	23.7	11.23	23.7	11.75	23.7	12.26	23.7	13.05
	-16.7	-17	26.1	11.04	26.1	11.44	26.0	11.78	26.0	12.31	26.0	12.81	26.0	13.60
	-13.7	-15	29.4	11.83	29.4	12.23	29.2	12.57	29.2	13.10	29.2	13.60	29.2	13.45
	-11.8	-13	31.1	12.33	31.1	12.73	30.9	13.07	30.9	13.60	30.9	13.53	30.9	13.35
	-9.8	-11	32.9	12.86	32.9	13.26	32.6	13.60	32.6	13.56	32.6	13.45	32.6	13.25
	-9.5	-10	33.6	12.94	33.6	13.34	33.4	13.60	33.4	13.55	32.9	13.44	32.9	13.24
	-8.5	-9.1	36.2	13.21	36.2	13.60	36.0	13.60	36.0	13.53	33.8	13.40	33.8	13.19
	-7.0	-7.6	40.1	13.60	40.1	13.64	39.9	13.60	39.9	13.49	39.9	13.34	36.5	13.11
	-5.0	-5.6	45.3	13.72	45.3	13.69	45.0	13.59	45.0	13.45	45.0	13.26	38.7	13.01
	-3.0	-3.7	50.5	13.84	50.5	13.74	50.2	13.59	49.3	13.40	47.5	13.18	40.8	12.91
	0.0	-0.7	50.7	14.02	50.7	13.81	50.5	13.58	49.3	13.34	47.5	13.06	44.1	12.76
	3.0	2.2	50.7	14.20	50.7	13.88	50.5	13.58	49.3	13.27	47.5	12.94	44.3	12.60
	5.0	4.1	50.7	14.32	50.7	13.93	50.5	13.58	49.3	13.22	47.5	12.86	44.3	12.50
	7.0	6	50.7	14.44	50.7	13.98	50.5	13.57	49.3	13.18	47.5	12.79	44.3	12.40
	9.0	7.9	50.7	14.58	50.7	14.11	50.5	13.70	49.3	13.31	47.5	12.91	44.3	12.52
11.0	9.8	50.7	14.87	50.7	14.39	50.5	13.97	49.3	13.57	47.5	13.16	44.3	12.77	
13.0	11.8	50.7	15.15	50.7	14.67	50.5	14.24	49.3	13.82	47.5	13.41	44.3	13.01	
15.0	13.7	50.7	15.44	50.7	14.94	50.5	14.51	49.3	14.08	47.5	13.67	44.3	13.26	
120	-19.8	-20	22.6	10.62	22.6	10.96	22.4	11.49	22.4	11.99	22.4	12.78	22.4	13.34
	-18.8	-19	23.7	10.88	23.7	11.23	23.5	11.75	23.5	12.26	23.5	13.05	23.5	13.60
	-16.7	-17	25.9	11.44	25.9	11.78	25.8	12.31	25.8	12.81	25.8	13.60	25.8	13.50
	-13.7	-15	29.2	12.23	29.2	12.57	29.0	13.10	29.0	13.60	29.0	13.48	29.0	13.36
	-11.8	-13	30.9	12.73	30.9	13.07	30.7	13.60	30.7	13.52	30.7	13.40	30.7	13.28
	-9.8	-11	32.6	13.26	32.6	13.60	32.4	13.54	32.4	13.44	32.4	13.32	32.4	13.18
	-9.5	-10	33.4	13.34	33.4	13.60	33.2	13.53	33.2	13.43	33.2	13.30	33.2	13.17
	-8.5	-9.1	36.0	13.60	36.0	13.57	35.7	13.49	35.7	13.39	34.6	13.26	34.6	13.12
	-7.0	-7.6	39.8	13.60	39.8	13.54	39.6	13.45	39.6	13.32	36.2	13.20	36.2	13.05
	-5.0	-5.6	45.0	13.61	45.0	13.50	44.7	13.38	44.7	13.24	44.7	13.12	38.4	12.96
	-3.0	-3.7	49.7	13.61	49.7	13.46	47.8	13.32	46.2	13.16	44.7	13.04	40.5	12.86
	0.0	-0.7	50.3	13.61	49.7	13.40	47.8	13.22	46.2	13.03	44.7	12.91	41.6	12.72
	3.0	2.2	50.3	13.62	49.7	13.34	47.8	13.12	46.2	12.91	44.7	12.79	41.6	12.58
	5.0	4.1	50.3	13.62	49.7	13.29	47.8	13.06	46.2	12.83	44.7	12.71	41.6	12.49
	7.0	6	50.3	13.62	49.7	13.25	47.8	12.99	46.2	12.74	44.7	12.62	41.6	12.40
	9.0	7.9	50.3	13.69	49.7	13.32	47.8	13.06	46.2	12.81	44.7	12.69	41.6	12.46
11.0	9.8	50.3	13.89	49.7	13.51	47.8	13.25	46.2	12.99	44.7	12.87	41.6	12.64	
13.0	11.8	50.3	14.09	49.7	13.71	47.8	13.44	46.2	13.18	44.7	13.06	41.6	12.82	
15.0	13.7	50.3	14.28	49.7	13.90	47.8	13.62	46.2	13.36	44.7	13.24	41.6	13.00	
110	-19.8	-20	22.4	10.96	22.4	11.49	22.3	11.99	22.3	12.78	22.3	13.34	22.3	13.60
	-18.8	-19	23.5	11.23	23.5	11.75	23.4	12.26	23.4	13.05	23.4	13.60	23.4	13.53
	-16.7	-17	25.8	11.78	25.8	12.31	25.6	12.81	25.6	13.60	25.6	13.47	25.6	13.37
	-13.7	-15	29.0	12.57	29.0	13.10	28.8	13.60	28.8	13.41	28.8	13.28	28.8	13.14
	-11.8	-13	30.7	13.07	30.7	13.60	30.5	13.48	30.5	13.29	30.5	13.16	30.5	13.00
	-9.8	-11	32.4	13.60	32.4	13.47	32.2	13.35	32.2	13.17	32.2	13.03	32.2	12.85
	-9.5	-10	33.2	13.58	33.2	13.45	33.0	13.33	33.0	13.15	33.0	13.01	33.0	12.83
	-8.5	-9.1	35.8	13.52	35.8	13.39	35.5	13.27	35.5	13.09	34.7	12.95	34.7	12.75
	-7.0	-7.6	39.6	13.43	39.6	13.30	39.4	13.17	39.4	12.99	36.4	12.85	36.4	12.64
	-5.0	-5.6	43.1	13.31	43.1	13.17	42.9	13.04	41.5	12.87	38.2	12.72	37.4	12.49
	-3.0	-3.7	45.7	13.19	45.7	13.04	42.9	12.91	41.5	12.74	40.1	12.59	37.4	12.34
	0.0	-0.7	48.3	13.01	45.7	12.85	42.9	12.71	41.5	12.55	40.1	12.40	37.4	12.11
	3.0	2.2	48.3	12.83	45.7	12.66	42.9	12.52	41.5	12.36	40.1	12.21	37.4	11.89
	5.0	4.1	48.3	12.71	45.7	12.53	42.9	12.39	41.5	12.24	40.1	12.08	37.4	11.74
	7.0	6	48.3	12.59	45.7	12.40	42.9	12.26	41.5	12.11	40.1	11.96	37.4	11.59
	9.0	7.9	48.3	12.58	45.7	12.39	42.9	12.25	41.5	12.10	40.1	11.95	37.4	11.58
11.0	9.8	48.3	12.69	45.7	12.50	42.9	12.36	41.5	12.21	40.1	12.06	37.4	11.68	
13.0	11.8	48.3	12.80	45.7	12.61	42.9	12.47	41.5	12.31	40.1	12.16	37.4	11.78	
15.0	13.7	48.3	12.90	45.7	12.71	42.9	12.57	41.5	12.41	40.1	12.25	37.4	11.87	

Note

1. TC: Total Capacity(kW), PI : Power Input(kW, Comp. + Outdoor fan motor)
2. Capacity tables show the average value of conditions which may occur.
3. In the range beyond the operation limit of the outdoor unit, continuous operation and performance can not be guaranteed. When selecting the outdoor units, avoid the air temperature range that is not guaranteed continuous operation.

7. Capacity Tables

Combination (%)		Heating Capacity (14HP)												
		Outdoor air temp.		Indoor air temp. °C DB										
		°C DB	°C WB	16		18		20		21		22		24
		TC	PI	TC	PI	TC	PI	TC	PI	TC	PI	TC	PI	
100	-19.8	-20	22.4	11.42	22.4	11.85	22.2	12.22	22.2	12.92	22.2	13.41	22.2	13.60
	-18.8	-19	23.4	11.63	23.3	12.07	23.3	12.49	23.3	13.14	23.3	13.60	23.3	13.48
	-16.7	-17	25.5	12.09	25.5	12.53	25.5	13.04	25.4	13.60	25.4	13.36	25.4	13.21
	-13.7	-15	28.9	12.75	28.9	13.19	28.7	13.60	28.7	13.28	28.7	13.01	28.7	12.83
	-11.8	-13	30.5	13.16	30.4	13.60	30.4	13.42	30.4	13.08	30.4	12.79	30.4	12.59
	-9.8	-11	32.3	13.60	32.3	13.41	32.1	13.22	32.1	12.87	32.1	12.56	32.1	12.34
	-9.5	-10	33.0	13.58	33.0	13.38	32.9	13.20	32.9	12.84	32.9	12.53	32.9	12.30
	-8.5	-9.1	35.6	13.49	35.6	13.29	35.4	13.10	37.9	12.74	36.7	12.41	34.2	12.17
	-7.0	-7.6	40.1	13.37	39.9	13.14	39.2	12.95	37.9	12.58	36.7	12.24	34.2	11.98
	-5.0	-5.6	41.8	13.20	41.4	12.95	39.2	12.76	37.9	12.37	36.7	12.01	34.2	11.73
	-3.0	-3.7	43.0	13.03	41.7	12.76	39.2	12.57	37.9	12.15	36.7	11.77	34.2	11.48
	0.0	-0.7	44.2	12.78	41.7	12.47	39.2	12.28	37.9	11.84	36.7	11.43	34.2	11.10
	3.0	2.2	44.2	12.52	41.7	12.19	39.2	11.99	37.9	11.52	36.7	11.08	34.2	10.72
	5.0	4.1	44.2	12.36	41.7	12.00	39.2	11.79	37.9	11.31	36.7	10.85	34.2	10.46
	7.0	6	44.2	12.19	41.7	11.81	39.2	11.60	37.9	11.10	36.7	10.62	34.2	10.21
	9.0	7.9	44.2	12.02	41.7	11.64	39.2	11.44	37.9	10.94	36.7	10.47	34.2	10.07
11.0	9.8	44.2	11.96	41.7	11.59	39.2	11.39	37.9	10.89	36.7	10.42	34.2	10.02	
13.0	11.8	44.2	11.89	41.7	11.52	39.2	11.32	37.9	10.83	36.7	10.36	34.2	9.97	
15.0	13.7	44.2	11.81	41.7	11.44	39.2	11.24	37.9	10.76	36.7	10.29	34.2	9.90	
90	-19.8	-20	22.3	10.75	22.3	11.55	22.1	12.10	22.1	12.36	22.1	12.19	22.1	11.88
	-18.8	-19	23.4	11.02	23.3	11.81	23.2	12.36	23.2	12.28	23.2	12.10	23.2	11.78
	-16.7	-17	25.5	11.57	25.5	12.36	25.4	12.21	25.4	12.11	25.4	11.92	25.4	11.58
	-13.7	-15	28.9	12.36	28.9	12.17	28.6	12.00	28.6	11.86	28.6	11.66	28.6	11.29
	-11.8	-13	30.5	12.25	30.4	12.04	30.2	11.86	30.2	11.70	30.2	11.49	30.2	11.10
	-9.8	-11	32.3	12.13	32.3	11.91	32.0	11.72	32.0	11.54	32.0	11.31	29.3	10.91
	-9.5	-10	33.0	12.12	33.0	11.89	32.7	11.69	32.7	11.51	32.7	11.29	30.0	10.88
	-8.5	-9.1	35.6	12.06	35.3	11.82	35.3	11.62	34.8	11.43	33.6	11.20	31.2	10.79
	-7.0	-7.6	40.1	11.97	38.1	11.72	35.9	11.51	34.8	11.31	33.6	11.07	31.2	10.64
	-5.0	-5.6	40.5	11.85	38.1	11.59	35.9	11.37	34.8	11.14	33.6	10.89	31.2	10.45
	-3.0	-3.7	40.5	11.73	38.1	11.46	35.9	11.23	34.8	10.97	33.6	10.72	31.2	10.25
	0.0	-0.7	40.5	11.55	38.1	11.26	35.9	11.01	34.8	10.73	33.6	10.46	31.2	9.96
	3.0	2.2	40.5	11.38	38.1	11.06	35.9	10.79	34.8	10.48	33.6	10.20	31.2	9.67
	5.0	4.1	40.5	11.26	38.1	10.93	35.9	10.65	34.8	10.31	33.6	10.02	31.2	9.48
	7.0	6	40.5	11.14	38.1	10.80	35.9	10.51	34.8	10.15	33.6	9.85	31.2	9.28
	9.0	7.9	40.5	10.99	38.1	10.65	35.9	10.36	34.8	10.01	33.6	9.71	31.2	9.16
11.0	9.8	40.5	10.83	38.1	10.50	35.9	10.22	34.8	9.87	33.6	9.58	31.2	9.03	
13.0	11.8	40.5	10.68	38.1	10.35	35.9	10.07	34.8	9.73	33.6	9.44	31.2	8.90	
15.0	13.7	40.5	10.53	38.1	10.20	35.9	9.93	34.8	9.59	33.6	9.31	31.2	8.77	
80	-19.8	-20	22.0	9.35	22.0	10.14	22.0	10.96	22.0	10.80	22.0	10.54	22.0	10.27
	-18.8	-19	23.1	9.62	23.1	10.96	23.1	10.89	23.1	10.71	23.1	10.46	23.1	10.18
	-16.7	-17	25.4	10.96	25.4	10.82	25.4	10.73	25.4	10.54	25.4	10.28	25.4	10.00
	-13.7	-15	29.9	10.78	29.3	10.62	28.6	10.50	28.6	10.29	28.6	10.03	27.9	9.73
	-11.8	-13	32.4	10.66	31.5	10.49	30.2	10.36	30.2	10.13	30.0	9.87	27.9	9.57
	-9.8	-11	33.4	10.53	32.5	10.35	32.0	10.21	31.1	9.97	30.0	9.70	27.9	9.39
	-9.5	-10	33.6	10.51	32.6	10.33	32.1	10.19	31.1	9.94	30.0	9.68	27.9	9.36
	-8.5	-9.1	34.9	10.45	34.2	10.26	32.1	10.11	31.1	9.86	30.0	9.59	27.9	9.28
	-7.0	-7.6	36.3	10.36	34.2	10.16	32.1	10.00	31.1	9.73	30.0	9.46	27.9	9.14
	-5.0	-5.6	36.3	10.23	34.2	10.03	32.1	9.85	31.1	9.57	30.0	9.30	27.9	8.97
	-3.0	-3.7	36.3	10.11	34.2	9.89	32.1	9.69	31.1	9.40	30.0	9.13	27.9	8.79
	0.0	-0.7	36.3	9.92	34.2	9.69	32.1	9.47	31.1	9.15	30.0	8.88	27.9	8.53
	3.0	2.2	36.3	9.74	34.2	9.48	32.1	9.24	31.1	8.90	30.0	8.62	27.9	8.26
	5.0	4.1	36.3	9.61	34.2	9.35	32.1	9.09	31.1	8.73	30.0	8.45	27.9	8.09
	7.0	6	36.3	9.49	34.2	9.21	32.1	8.94	31.1	8.57	30.0	8.29	27.9	7.91
	9.0	7.9	36.3	8.91	34.2	8.65	32.1	8.39	31.1	8.04	30.0	7.78	27.9	7.43
11.0	9.8	36.3	8.27	34.2	8.03	32.1	7.79	31.1	7.47	30.0	7.22	27.9	6.89	
13.0	11.8	36.3	7.72	34.2	7.49	32.1	7.27	31.1	6.97	30.0	6.74	27.9	6.44	
15.0	13.7	36.3	7.26	34.2	7.05	32.1	6.85	31.1	6.56	30.0	6.35	27.9	6.06	

Note
 1. TC: Total Capacity(kW), PI: Power Input(kW, Comp. + Outdoor fan motor)
 2. Capacity tables show the average value of conditions which may occur.
 3. In the range beyond the operation limit of the outdoor unit, continuous operation and performance can not be guaranteed. When selecting the outdoor units, avoid the air temperature range that is not guaranteed continuous operation.

7. Capacity Tables

Combination (%)		Heating Capacity (14HP)												
		Outdoor air temp.		Indoor air temp. °C DB										
		°C DB	°C WB	16		18		20		21		22		24
		TC	PI	TC	PI	TC	PI	TC	PI	TC	PI	TC	PI	
70	-19.8	-20	22.0	9.91	22.0	10.17	22.0	10.00	22.0	9.72	22.0	9.46	22.0	9.17
	-18.8	-19	23.1	10.17	23.1	10.09	23.1	9.91	23.1	9.63	23.1	9.37	23.1	9.08
	-16.7	-17	25.4	10.02	25.4	9.91	25.4	9.73	25.4	9.44	25.4	9.19	23.9	8.88
	-13.7	-15	30.7	9.79	29.0	9.66	27.3	9.47	26.4	9.17	25.6	8.92	23.9	8.60
	-11.8	-13	30.7	9.65	29.0	9.50	27.3	9.30	26.4	9.00	25.6	8.75	23.9	8.42
	-9.8	-11	30.7	9.50	29.0	9.33	27.3	9.13	26.4	8.82	25.6	8.58	23.9	8.24
	-9.5	-10	30.7	9.48	29.0	9.31	27.3	9.10	26.4	8.80	25.6	8.55	23.9	8.21
	-8.5	-9.1	30.7	9.41	29.0	9.23	27.3	9.01	26.4	8.71	25.6	8.46	23.9	8.12
	-7.0	-7.6	30.7	9.30	29.0	9.10	27.3	8.88	26.4	8.57	25.6	8.33	23.9	7.98
	-5.0	-5.6	30.7	9.15	29.0	8.93	27.3	8.71	26.4	8.39	25.6	8.15	23.9	7.79
	-3.0	-3.7	30.7	9.00	29.0	8.77	27.3	8.53	26.4	8.21	25.6	7.98	23.9	7.60
	0.0	-0.7	30.7	8.78	29.0	8.51	27.3	8.27	26.4	7.95	25.6	7.71	23.9	7.32
	3.0	2.2	30.7	8.56	29.0	8.26	27.3	8.01	26.4	7.68	25.6	7.45	23.9	7.04
	5.0	4.1	30.7	8.41	29.0	8.10	27.3	7.84	26.4	7.50	25.6	7.27	23.9	6.86
	7.0	6	30.7	8.26	29.0	7.93	27.3	7.66	26.4	7.32	25.6	7.10	23.9	6.67
	9.0	7.9	30.7	7.46	29.0	7.16	27.3	6.92	26.4	6.61	25.6	6.41	23.9	6.02
	11.0	9.8	30.7	6.95	29.0	6.67	27.3	6.44	26.4	6.15	25.6	5.97	23.9	5.61
	13.0	11.8	30.7	6.50	29.0	6.24	27.3	6.03	26.4	5.76	25.6	5.58	23.9	5.25
15.0	13.7	30.7	6.13	29.0	5.88	27.3	5.68	26.4	5.43	25.6	5.26	23.9	4.95	
60	-19.8	-20	26.4	9.38	25.0	9.20	22.0	8.93	22.0	8.67	21.9	8.40	20.4	8.11
	-18.8	-19	26.4	9.30	25.0	9.12	23.1	8.84	22.6	8.58	21.9	8.31	20.4	8.02
	-16.7	-17	26.4	9.14	25.0	8.93	23.4	8.66	22.6	8.39	21.9	8.13	20.4	7.82
	-13.7	-15	26.4	8.91	25.0	8.67	23.4	8.39	22.6	8.13	21.9	7.86	20.4	7.54
	-11.8	-13	26.4	8.77	25.0	8.51	23.4	8.22	22.6	7.96	21.9	7.70	20.4	7.37
	-9.8	-11	26.4	8.61	25.0	8.33	23.4	8.04	22.6	7.78	21.9	7.52	20.4	7.18
	-9.5	-10	26.4	8.59	25.0	8.31	23.4	8.02	22.6	7.75	21.9	7.49	20.4	7.15
	-8.5	-9.1	26.4	8.51	25.0	8.22	23.4	7.93	22.6	7.67	21.9	7.40	20.4	7.06
	-7.0	-7.6	26.4	8.40	25.0	8.09	23.4	7.79	22.6	7.53	21.9	7.27	20.4	6.92
	-5.0	-5.6	26.4	8.25	25.0	7.91	23.4	7.61	22.6	7.35	21.9	7.09	20.4	6.73
	-3.0	-3.7	26.4	8.09	25.0	7.74	23.4	7.44	22.6	7.18	21.9	6.92	20.4	6.54
	0.0	-0.7	26.4	7.86	25.0	7.48	23.4	7.17	22.6	6.91	21.9	6.65	20.4	6.26
	3.0	2.2	26.4	7.63	25.0	7.21	23.4	6.90	22.6	6.64	21.9	6.39	20.4	5.98
	5.0	4.1	26.4	7.48	25.0	7.04	23.4	6.72	22.6	6.47	21.9	6.21	20.4	5.80
	7.0	6	26.4	7.33	25.0	6.86	23.4	6.54	22.6	6.29	21.9	6.03	20.4	5.61
	9.0	7.9	26.4	6.54	25.0	6.12	23.4	5.84	22.6	5.61	21.9	5.38	20.4	5.01
	11.0	9.8	26.4	6.11	25.0	5.72	23.4	5.45	22.6	5.24	21.9	5.03	20.4	4.67
	13.0	11.8	26.4	5.72	25.0	5.36	23.4	5.11	22.6	4.91	21.9	4.71	20.4	4.38
15.0	13.7	26.4	5.41	25.0	5.06	23.4	4.83	22.6	4.64	21.9	4.45	20.4	4.14	
50	-19.8	-20	22.0	8.40	20.8	8.11	19.5	7.83	18.9	7.55	18.3	7.30	17.0	7.02
	-18.8	-19	22.0	8.31	20.8	8.01	19.5	7.74	18.9	7.46	18.3	7.21	17.0	6.93
	-16.7	-17	22.0	8.11	20.8	7.81	19.5	7.54	18.9	7.27	18.3	7.02	17.0	6.74
	-13.7	-15	22.0	7.83	20.8	7.52	19.5	7.26	18.9	6.99	18.3	6.75	17.0	6.46
	-11.8	-13	22.0	7.66	20.8	7.34	19.5	7.09	18.9	6.81	18.3	6.58	17.0	6.29
	-9.8	-11	22.0	7.47	20.8	7.15	19.5	6.90	18.9	6.63	18.3	6.40	17.0	6.11
	-9.5	-10	22.0	7.44	20.8	7.12	19.5	6.87	18.9	6.60	18.3	6.38	17.0	6.08
	-8.5	-9.1	22.0	7.35	20.8	7.02	19.5	6.78	18.9	6.50	18.3	6.29	17.0	5.99
	-7.0	-7.6	22.0	7.21	20.8	6.88	19.5	6.64	18.9	6.37	18.3	6.15	17.0	5.85
	-5.0	-5.6	22.0	7.03	20.8	6.69	19.5	6.45	18.9	6.18	18.3	5.98	17.0	5.67
	-3.0	-3.7	22.0	6.84	20.8	6.49	19.5	6.26	18.9	5.99	18.3	5.80	17.0	5.49
	0.0	-0.7	22.0	6.56	20.8	6.21	19.5	5.98	18.9	5.71	18.3	5.53	17.0	5.22
	3.0	2.2	22.0	6.28	20.8	5.92	19.5	5.70	18.9	5.44	18.3	5.26	17.0	4.94
	5.0	4.1	22.0	6.10	20.8	5.73	19.5	5.52	18.9	5.25	18.3	5.09	17.0	4.76
	7.0	6	22.0	5.91	20.8	5.53	19.5	5.33	18.9	5.06	18.3	4.91	17.0	4.58
	9.0	7.9	22.0	5.34	20.8	5.00	19.5	4.81	18.9	4.57	18.3	4.43	17.0	4.13
	11.0	9.8	22.0	4.99	20.8	4.68	19.5	4.50	18.9	4.28	18.3	4.15	17.0	3.87
	13.0	11.8	22.0	4.69	20.8	4.39	19.5	4.23	18.9	4.02	18.3	3.89	17.0	3.63
15.0	13.7	22.0	4.44	20.8	4.15	19.5	4.00	18.9	3.80	18.3	3.68	17.0	3.44	

Note

1. TC: Total Capacity(kW), PI : Power Input(kW, Comp. + Outdoor fan motor)
2. Capacity tables show the average value of conditions which may occur.
3. In the range beyond the operation limit of the outdoor unit, continuous operation and performance can not be guaranteed. When selecting the outdoor units, avoid the air temperature range that is not guaranteed continuous operation.

7. Capacity Tables

◆ A(C)RUN160LLS5

Combination (%)	Outdoor air temp.		Indoor air temp. °C DB											
	°C DB	°C WB	16		18		20		21		22		24	
			TC	PI	TC	PI	TC	PI	TC	PI	TC	PI	TC	PI
130	-19.8	-20	25.9	10.65	25.9	11.07	25.8	11.43	25.8	11.98	25.8	12.50	25.8	13.33
	-18.8	-19	27.2	10.93	27.2	11.34	27.0	11.70	27.0	12.26	27.0	12.78	27.0	13.61
	-16.7	-17	29.8	11.51	29.8	11.92	29.7	12.28	29.7	12.83	29.7	13.36	29.7	14.19
	-13.7	-15	33.6	12.34	33.6	12.75	33.4	13.11	33.4	13.66	33.4	14.19	33.4	14.03
	-11.8	-13	35.5	12.86	35.5	13.28	35.3	13.64	35.3	14.19	35.3	14.11	35.3	13.93
	-9.8	-11	37.5	13.41	37.5	13.83	37.3	14.19	37.3	14.14	37.3	14.03	37.3	13.82
	-9.5	-10	38.4	13.50	38.4	13.91	38.2	14.19	38.2	14.13	37.6	14.01	37.6	13.81
	-8.5	-9.1	41.4	13.77	41.4	14.19	41.1	14.18	41.1	14.11	38.6	13.97	38.6	13.75
	-7.0	-7.6	45.8	14.19	45.8	14.23	45.6	14.18	45.6	14.07	45.6	13.91	41.8	13.68
	-5.0	-5.6	51.8	14.31	51.8	14.28	51.5	14.18	51.5	14.03	51.5	13.83	44.3	13.57
	-3.0	-3.7	57.7	14.44	57.7	14.33	57.3	14.17	56.3	13.98	54.3	13.75	46.8	13.46
	0.0	-0.7	57.9	14.63	57.9	14.40	57.7	14.17	56.3	13.91	54.3	13.62	50.6	13.31
	3.0	2.2	57.9	14.82	57.9	14.48	57.7	14.16	56.3	13.84	54.3	13.50	50.6	13.15
	5.0	4.1	57.9	14.94	57.9	14.53	57.7	14.16	56.3	13.79	54.3	13.42	50.6	13.04
	7.0	6	57.9	15.07	57.9	14.58	57.7	14.16	56.3	13.74	54.3	13.34	50.6	12.94
	9.0	7.9	57.9	15.21	57.9	14.72	57.7	14.29	56.3	13.88	54.3	13.47	50.6	13.06
	11.0	9.8	57.9	15.51	57.9	15.01	57.7	14.57	56.3	14.15	54.3	13.73	50.6	13.32
13.0	11.8	57.9	15.81	57.9	15.30	57.7	14.85	56.3	14.42	54.3	13.99	50.6	13.57	
15.0	13.7	57.9	16.10	57.9	15.59	57.7	15.13	56.3	14.69	54.3	14.26	50.6	13.83	
120	-19.8	-20	25.8	11.07	25.8	11.43	25.6	11.98	25.6	12.50	25.6	13.33	25.6	13.91
	-18.8	-19	27.0	11.34	27.0	11.70	26.8	12.26	26.8	12.78	26.8	13.61	26.8	14.19
	-16.7	-17	29.6	11.92	29.6	12.28	29.4	12.83	29.4	13.36	29.4	14.19	29.4	14.08
	-13.7	-15	33.4	12.75	33.4	13.11	33.2	13.66	33.2	14.19	33.2	14.06	33.2	13.94
	-11.8	-13	35.3	13.28	35.3	13.64	35.1	14.19	35.1	14.10	35.1	13.98	35.1	13.85
	-9.8	-11	37.3	13.83	37.3	14.19	37.0	14.12	37.0	14.02	37.0	13.89	37.0	13.75
	-9.5	-10	38.1	13.91	38.1	14.18	37.9	14.11	37.9	14.01	37.9	13.88	37.9	13.73
	-8.5	-9.1	41.1	14.19	41.1	14.16	40.8	14.08	40.8	13.96	39.7	13.83	39.7	13.69
	-7.0	-7.6	45.5	14.19	45.5	14.13	45.2	14.02	45.2	13.90	41.5	13.77	41.5	13.61
	-5.0	-5.6	51.4	14.19	51.4	14.08	51.1	13.96	51.1	13.81	51.1	13.68	44.0	13.52
	-3.0	-3.7	56.8	14.19	56.8	14.04	54.6	13.89	52.8	13.72	51.1	13.60	46.5	13.42
	0.0	-0.7	57.4	14.20	56.8	13.98	54.6	13.79	52.8	13.60	51.1	13.47	47.5	13.27
	3.0	2.2	57.4	14.20	56.8	13.91	54.6	13.69	52.8	13.47	51.1	13.34	47.5	13.13
	5.0	4.1	57.4	14.21	56.8	13.87	54.6	13.62	52.8	13.38	51.1	13.25	47.5	13.03
	7.0	6	57.4	14.21	56.8	13.82	54.6	13.55	52.8	13.29	51.1	13.17	47.5	12.93
	9.0	7.9	57.4	14.28	56.8	13.89	54.6	13.62	52.8	13.36	51.1	13.23	47.5	13.00
	11.0	9.8	57.4	14.49	56.8	14.10	54.6	13.82	52.8	13.56	51.1	13.43	47.5	13.19
13.0	11.8	57.4	14.70	56.8	14.30	54.6	14.02	52.8	13.75	51.1	13.62	47.5	13.38	
15.0	13.7	57.4	14.90	56.8	14.50	54.6	14.21	52.8	13.94	51.1	13.81	47.5	13.56	
110	-19.8	-20	25.6	11.43	25.6	11.98	25.5	12.50	25.5	13.33	25.5	13.91	25.5	14.19
	-18.8	-19	26.9	11.70	26.9	12.26	26.7	12.78	26.7	13.61	26.7	14.19	26.7	14.11
	-16.7	-17	29.5	12.28	29.5	12.83	29.3	13.36	29.3	14.19	29.3	14.05	29.3	13.94
	-13.7	-15	33.2	13.11	33.2	13.66	33.0	14.19	33.0	13.99	33.0	13.85	33.0	13.71
	-11.8	-13	35.1	13.64	35.1	14.19	34.9	14.06	34.9	13.87	34.9	13.72	34.9	13.56
	-9.8	-11	37.1	14.19	37.1	14.05	36.8	13.92	36.8	13.73	36.8	13.59	36.8	13.40
	-9.5	-10	37.9	14.17	37.9	14.03	37.7	13.90	37.7	13.72	37.7	13.57	37.7	13.38
	-8.5	-9.1	40.9	14.11	40.9	13.97	40.6	13.84	40.6	13.65	39.6	13.50	39.6	13.30
	-7.0	-7.6	45.3	14.01	45.3	13.87	45.0	13.73	45.0	13.55	41.5	13.40	41.5	13.18
	-5.0	-5.6	49.3	13.89	49.3	13.73	49.0	13.60	47.4	13.42	43.5	13.27	42.8	13.03
	-3.0	-3.7	52.2	13.76	52.2	13.60	49.0	13.46	47.4	13.29	45.8	13.14	42.8	12.87
	0.0	-0.7	55.2	13.57	52.2	13.40	49.0	13.26	47.4	13.09	45.8	12.94	42.8	12.64
	3.0	2.2	55.2	13.38	52.2	13.20	49.0	13.06	47.4	12.90	45.8	12.74	42.8	12.40
	5.0	4.1	55.2	13.26	52.2	13.07	49.0	12.92	47.4	12.77	45.8	12.61	42.8	12.24
	7.0	6	55.2	13.13	52.2	12.93	49.0	12.79	47.4	12.63	45.8	12.47	42.8	12.09
	9.0	7.9	55.2	13.12	52.2	12.93	49.0	12.78	47.4	12.63	45.8	12.46	42.8	12.08
	11.0	9.8	55.2	13.24	52.2	13.04	49.0	12.90	47.4	12.74	45.8	12.58	42.8	12.19
13.0	11.8	55.2	13.35	52.2	13.15	49.0	13.00	47.4	12.85	45.8	12.68	42.8	12.29	
15.0	13.7	55.2	13.46	52.2	13.26	49.0	13.11	47.4	12.95	45.8	12.78	42.8	12.39	

Note

1. TC: Total Capacity(kW), PI : Power Input(kW, Comp. + Outdoor fan motor)
2. Capacity tables show the average value of conditions which may occur.
3. In the range beyond the operation limit of the outdoor unit, continuous operation and performance can not be guaranteed. When selecting the outdoor units, avoid the air temperature range that is not guaranteed continuous operation.

7. Capacity Tables

Combination (%)		Heating Capacity (16HP)												
		Outdoor air temp.		Indoor air temp. °C DB										
		°C DB	°C WB	16		18		20		21		22		24
		TC	PI	TC	PI	TC	PI	TC	PI	TC	PI	TC	PI	
100	-19.8	-20	25.5	11.90	25.5	12.36	25.3	12.75	25.3	13.48	25.3	13.99	25.3	14.19
	-18.8	-19	26.7	12.13	26.6	12.59	26.6	13.02	26.6	13.71	26.6	14.19	26.6	14.06
	-16.7	-17	29.2	12.61	29.2	13.07	29.2	13.60	29.0	14.19	29.0	13.93	29.0	13.78
	-13.7	-15	33.0	13.30	33.0	13.75	32.9	14.19	32.9	13.86	32.9	13.57	32.9	13.38
	-11.8	-13	34.9	13.73	34.7	14.19	34.7	14.00	34.7	13.65	34.7	13.34	34.7	13.13
	-9.8	-11	36.9	14.19	36.9	13.99	36.7	13.79	36.7	13.43	36.7	13.10	36.7	12.87
	-9.5	-10	37.7	14.16	37.7	13.96	37.6	13.76	37.6	13.39	37.6	13.07	37.6	12.83
	-8.5	-9.1	40.6	14.07	40.6	13.86	40.5	13.66	43.4	13.28	41.9	12.94	39.1	12.70
	-7.0	-7.6	45.8	13.94	45.6	13.71	44.8	13.51	43.4	13.12	41.9	12.76	39.1	12.50
	-5.0	-5.6	47.8	13.77	47.3	13.51	44.8	13.31	43.4	12.90	41.9	12.52	39.1	12.23
	-3.0	-3.7	49.2	13.59	47.7	13.31	44.8	13.11	43.4	12.68	41.9	12.28	39.1	11.97
	0.0	-0.7	50.5	13.33	47.7	13.01	44.8	12.81	43.4	12.35	41.9	11.92	39.1	11.58
	3.0	2.2	50.5	13.06	47.7	12.71	44.8	12.50	43.4	12.02	41.9	11.56	39.1	11.18
	5.0	4.1	50.5	12.89	47.7	12.51	44.8	12.30	43.4	11.80	41.9	11.32	39.1	10.92
	7.0	6	50.5	12.71	47.7	12.31	44.8	12.10	43.4	11.58	41.9	11.08	39.1	10.65
	9.0	7.9	50.5	12.54	47.7	12.14	44.8	11.93	43.4	11.42	41.9	10.92	39.1	10.51
11.0	9.8	50.5	12.48	47.7	12.09	44.8	11.88	43.4	11.36	41.9	10.87	39.1	10.46	
13.0	11.8	50.5	12.41	47.7	12.02	44.8	11.81	43.4	11.30	41.9	10.81	39.1	10.40	
15.0	13.7	50.5	12.32	47.7	11.94	44.8	11.73	43.4	11.22	41.9	10.74	39.1	10.33	
90	-19.8	-20	25.4	11.21	25.4	12.04	25.2	12.62	25.2	12.89	25.2	12.71	25.2	12.39
	-18.8	-19	26.7	11.49	26.6	12.31	26.5	12.89	26.5	12.81	26.5	12.62	26.5	12.29
	-16.7	-17	29.2	12.07	29.2	12.89	29.1	12.74	29.1	12.63	29.1	12.43	29.1	12.08
	-13.7	-15	33.0	12.89	33.0	12.69	32.7	12.51	32.7	12.37	32.7	12.16	32.7	11.77
	-11.8	-13	34.9	12.78	34.7	12.56	34.6	12.37	34.6	12.20	34.6	11.98	34.6	11.58
	-9.8	-11	36.9	12.65	36.9	12.42	36.5	12.22	36.5	12.03	36.5	11.80	33.5	11.38
	-9.5	-10	37.7	12.64	37.7	12.40	37.4	12.20	37.4	12.01	37.4	11.77	34.3	11.35
	-8.5	-9.1	40.6	12.57	40.4	12.33	40.3	12.12	39.7	11.92	38.4	11.68	35.7	11.25
	-7.0	-7.6	45.8	12.48	43.5	12.23	41.0	12.01	39.7	11.79	38.4	11.55	35.7	11.10
	-5.0	-5.6	46.3	12.36	43.5	12.09	41.0	11.86	39.7	11.62	38.4	11.36	35.7	10.90
	-3.0	-3.7	46.3	12.23	43.5	11.95	41.0	11.71	39.7	11.45	38.4	11.18	35.7	10.69
	0.0	-0.7	46.3	12.05	43.5	11.74	41.0	11.48	39.7	11.19	38.4	10.91	35.7	10.39
	3.0	2.2	46.3	11.86	43.5	11.54	41.0	11.26	39.7	10.93	38.4	10.63	35.7	10.09
	5.0	4.1	46.3	11.74	43.5	11.40	41.0	11.11	39.7	10.76	38.4	10.45	35.7	9.89
	7.0	6	46.3	11.62	43.5	11.26	41.0	10.96	39.7	10.58	38.4	10.27	35.7	9.68
	9.0	7.9	46.3	11.46	43.5	11.11	41.0	10.81	39.7	10.44	38.4	10.13	35.7	9.55
11.0	9.8	46.3	11.30	43.5	10.95	41.0	10.66	39.7	10.29	38.4	9.99	35.7	9.42	
13.0	11.8	46.3	11.14	43.5	10.80	41.0	10.51	39.7	10.15	38.4	9.85	35.7	9.29	
15.0	13.7	46.3	10.98	43.5	10.64	41.0	10.36	39.7	10.00	38.4	9.71	35.7	9.15	
80	-19.8	-20	25.1	9.75	25.1	10.58	25.1	11.43	25.1	11.26	25.1	11.00	25.1	10.71
	-18.8	-19	26.4	10.03	26.4	11.43	26.4	11.36	26.4	11.17	26.4	10.91	26.4	10.62
	-16.7	-17	29.1	11.43	29.1	11.29	29.1	11.19	29.1	10.99	29.1	10.72	29.1	10.43
	-13.7	-15	34.2	11.24	33.6	11.07	32.7	10.95	32.7	10.73	32.7	10.46	31.9	10.15
	-11.8	-13	37.0	11.12	36.0	10.94	34.6	10.80	34.6	10.57	34.3	10.29	31.9	9.98
	-9.8	-11	38.2	10.99	37.1	10.80	36.5	10.65	35.6	10.39	34.3	10.12	31.9	9.79
	-9.5	-10	38.4	10.97	37.3	10.78	36.7	10.62	35.6	10.37	34.3	10.09	31.9	9.77
	-8.5	-9.1	39.8	10.90	39.1	10.71	36.7	10.54	35.6	10.28	34.3	10.00	31.9	9.67
	-7.0	-7.6	41.4	10.80	39.1	10.60	36.7	10.43	35.6	10.15	34.3	9.87	31.9	9.54
	-5.0	-5.6	41.4	10.67	39.1	10.46	36.7	10.27	35.6	9.98	34.3	9.70	31.9	9.35
	-3.0	-3.7	41.4	10.54	39.1	10.32	36.7	10.11	35.6	9.80	34.3	9.52	31.9	9.17
	0.0	-0.7	41.4	10.35	39.1	10.10	36.7	9.88	35.6	9.54	34.3	9.26	31.9	8.89
	3.0	2.2	41.4	10.16	39.1	9.89	36.7	9.64	35.6	9.28	34.3	8.99	31.9	8.62
	5.0	4.1	41.4	10.03	39.1	9.75	36.7	9.48	35.6	9.11	34.3	8.82	31.9	8.44
	7.0	6	41.4	9.90	39.1	9.61	36.7	9.32	35.6	8.94	34.3	8.64	31.9	8.25
	9.0	7.9	41.4	9.29	39.1	9.02	36.7	8.76	35.6	8.39	34.3	8.12	31.9	7.75
11.0	9.8	41.4	8.62	39.1	8.37	36.7	8.13	35.6	7.79	34.3	7.53	31.9	7.19	
13.0	11.8	41.4	8.05	39.1	7.82	36.7	7.59	35.6	7.27	34.3	7.03	31.9	6.71	
15.0	13.7	41.4	7.58	39.1	7.36	36.7	7.14	35.6	6.84	34.3	6.62	31.9	6.32	

Note

1. TC: Total Capacity(kW), PI: Power Input(kW, Comp. + Outdoor fan motor)
2. Capacity tables show the average value of conditions which may occur.
3. In the range beyond the operation limit of the outdoor unit, continuous operation and performance can not be guaranteed. When selecting the outdoor units, avoid the air temperature range that is not guaranteed continuous operation.

7. Capacity Tables

Combination (%)		Heating Capacity (16HP)												
		Outdoor air temp.		Indoor air temp. °C DB										
		°C DB	°C WB	16		18		20		21		22		24
		TC	PI	TC	PI	TC	PI	TC	PI	TC	PI	TC	PI	
70	-19.8	-20	25.1	10.33	25.1	10.61	25.1	10.42	25.1	10.14	25.1	9.87	25.1	9.56
	-18.8	-19	26.4	10.61	26.4	10.52	26.4	10.33	26.4	10.04	26.4	9.77	26.4	9.47
	-16.7	-17	29.1	10.44	29.1	10.34	29.1	10.14	29.1	9.85	29.1	9.58	27.3	9.26
	-13.7	-15	35.1	10.21	33.2	10.07	31.2	9.87	30.1	9.57	29.3	9.30	27.3	8.97
	-11.8	-13	35.1	10.07	33.2	9.91	31.2	9.70	30.1	9.39	29.3	9.13	27.3	8.79
	-9.8	-11	35.1	9.91	33.2	9.73	31.2	9.52	30.1	9.20	29.3	8.95	27.3	8.59
	-9.5	-10	35.1	9.89	33.2	9.71	31.2	9.49	30.1	9.17	29.3	8.92	27.3	8.56
	-8.5	-9.1	35.1	9.81	33.2	9.62	31.2	9.40	30.1	9.08	29.3	8.83	27.3	8.47
	-7.0	-7.6	35.1	9.70	33.2	9.49	31.2	9.26	30.1	8.94	29.3	8.69	27.3	8.32
	-5.0	-5.6	35.1	9.54	33.2	9.32	31.2	9.08	30.1	8.75	29.3	8.50	27.3	8.13
	-3.0	-3.7	35.1	9.39	33.2	9.14	31.2	8.90	30.1	8.57	29.3	8.32	27.3	7.93
	0.0	-0.7	35.1	9.16	33.2	8.88	31.2	8.63	30.1	8.29	29.3	8.05	27.3	7.64
	3.0	2.2	35.1	8.93	33.2	8.62	31.2	8.36	30.1	8.01	29.3	7.77	27.3	7.35
	5.0	4.1	35.1	8.77	33.2	8.44	31.2	8.18	30.1	7.82	29.3	7.59	27.3	7.15
	7.0	6	35.1	8.62	33.2	8.27	31.2	7.99	30.1	7.63	29.3	7.40	27.3	6.96
	9.0	7.9	35.1	7.78	33.2	7.47	31.2	7.22	30.1	6.89	29.3	6.68	27.3	6.28
	11.0	9.8	35.1	7.25	33.2	6.95	31.2	6.72	30.1	6.42	29.3	6.22	27.3	5.85
13.0	11.8	35.1	6.78	33.2	6.51	31.2	6.29	30.1	6.00	29.3	5.82	27.3	5.47	
15.0	13.7	35.1	6.39	33.2	6.13	31.2	5.93	30.1	5.66	29.3	5.49	27.3	5.16	
60	-19.8	-20	30.1	9.78	28.5	9.60	25.1	9.31	25.1	9.04	25.0	8.76	23.4	8.46
	-18.8	-19	30.1	9.70	28.5	9.51	26.4	9.22	25.9	8.94	25.0	8.67	23.4	8.36
	-16.7	-17	30.1	9.53	28.5	9.31	26.8	9.03	25.9	8.75	25.0	8.48	23.4	8.16
	-13.7	-15	30.1	9.29	28.5	9.04	26.8	8.75	25.9	8.47	25.0	8.20	23.4	7.87
	-11.8	-13	30.1	9.14	28.5	8.87	26.8	8.57	25.9	8.30	25.0	8.02	23.4	7.68
	-9.8	-11	30.1	8.98	28.5	8.69	26.8	8.39	25.9	8.11	25.0	7.84	23.4	7.49
	-9.5	-10	30.1	8.96	28.5	8.66	26.8	8.36	25.9	8.09	25.0	7.81	23.4	7.46
	-8.5	-9.1	30.1	8.88	28.5	8.57	26.8	8.26	25.9	7.99	25.0	7.72	23.4	7.36
	-7.0	-7.6	30.1	8.76	28.5	8.43	26.8	8.13	25.9	7.85	25.0	7.58	23.4	7.21
	-5.0	-5.6	30.1	8.60	28.5	8.25	26.8	7.94	25.9	7.67	25.0	7.40	23.4	7.02
	-3.0	-3.7	30.1	8.44	28.5	8.07	26.8	7.75	25.9	7.48	25.0	7.21	23.4	6.82
	0.0	-0.7	30.1	8.20	28.5	7.80	26.8	7.48	25.9	7.21	25.0	6.94	23.4	6.53
	3.0	2.2	30.1	7.96	28.5	7.52	26.8	7.20	25.9	6.93	25.0	6.66	23.4	6.24
	5.0	4.1	30.1	7.80	28.5	7.34	26.8	7.01	25.9	6.75	25.0	6.48	23.4	6.05
	7.0	6	30.1	7.64	28.5	7.16	26.8	6.83	25.9	6.56	25.0	6.29	23.4	5.85
	9.0	7.9	30.1	6.82	28.5	6.39	26.8	6.09	25.9	5.85	25.0	5.62	23.4	5.22
	11.0	9.8	30.1	6.37	28.5	5.97	26.8	5.69	25.9	5.47	25.0	5.24	23.4	4.88
13.0	11.8	30.1	5.97	28.5	5.59	26.8	5.33	25.9	5.12	25.0	4.91	23.4	4.57	
15.0	13.7	30.1	5.64	28.5	5.28	26.8	5.03	25.9	4.84	25.0	4.64	23.4	4.32	
50	-19.8	-20	25.2	8.76	23.7	8.45	22.3	8.16	21.6	7.88	20.9	7.60	19.4	7.32
	-18.8	-19	25.2	8.66	23.7	8.35	22.3	8.07	21.6	7.78	20.9	7.51	19.4	7.22
	-16.7	-17	25.2	8.46	23.7	8.14	22.3	7.86	21.6	7.58	20.9	7.32	19.4	7.02
	-13.7	-15	25.2	8.17	23.7	7.84	22.3	7.57	21.6	7.28	20.9	7.04	19.4	6.74
	-11.8	-13	25.2	7.98	23.7	7.65	22.3	7.39	21.6	7.10	20.9	6.86	19.4	6.56
	-9.8	-11	25.2	7.79	23.7	7.45	22.3	7.19	21.6	6.91	20.9	6.68	19.4	6.37
	-9.5	-10	25.2	7.76	23.7	7.42	22.3	7.16	21.6	6.88	20.9	6.65	19.4	6.34
	-8.5	-9.1	25.2	7.66	23.7	7.32	22.3	7.07	21.6	6.78	20.9	6.56	19.4	6.25
	-7.0	-7.6	25.2	7.52	23.7	7.17	22.3	6.92	21.6	6.64	20.9	6.42	19.4	6.10
	-5.0	-5.6	25.2	7.33	23.7	6.97	22.3	6.73	21.6	6.44	20.9	6.23	19.4	5.91
	-3.0	-3.7	25.2	7.13	23.7	6.77	22.3	6.53	21.6	6.25	20.9	6.05	19.4	5.72
	0.0	-0.7	25.2	6.84	23.7	6.47	22.3	6.24	21.6	5.96	20.9	5.77	19.4	5.44
	3.0	2.2	25.2	6.55	23.7	6.17	22.3	5.95	21.6	5.67	20.9	5.49	19.4	5.15
	5.0	4.1	25.2	6.36	23.7	5.97	22.3	5.76	21.6	5.48	20.9	5.30	19.4	4.97
	7.0	6	25.2	6.17	23.7	5.77	22.3	5.56	21.6	5.28	20.9	5.12	19.4	4.78
	9.0	7.9	25.2	5.57	23.7	5.21	22.3	5.02	21.6	4.77	20.9	4.62	19.4	4.31
	11.0	9.8	25.2	5.21	23.7	4.88	22.3	4.70	21.6	4.46	20.9	4.33	19.4	4.04
13.0	11.8	25.2	4.89	23.7	4.58	22.3	4.41	21.6	4.19	20.9	4.06	19.4	3.79	
15.0	13.7	25.2	4.63	23.7	4.33	22.3	4.17	21.6	3.97	20.9	3.84	19.4	3.59	

Note

1. TC: Total Capacity(kW), PI : Power Input(kW, Comp. + Outdoor fan motor)
2. Capacity tables show the average value of conditions which may occur.
3. In the range beyond the operation limit of the outdoor unit, continuous operation and performance can not be guaranteed. When selecting the outdoor units, avoid the air temperature range that is not guaranteed continuous operation.

7. Capacity Tables

◆ A(C)RUN180LLS5

Combination (%)	Outdoor air temp.		Indoor air temp. °C DB											
	°C DB	°C WB	16		18		20		21		22		24	
			TC	PI	TC	PI	TC	PI	TC	PI	TC	PI	TC	PI
130	-19.8	-20	29.2	10.65	29.2	11.07	29.1	11.43	29.1	11.98	29.1	12.50	29.1	13.33
	-18.8	-19	30.6	10.93	30.6	11.34	30.4	11.70	30.4	12.26	30.4	12.78	30.4	13.61
	-16.7	-17	33.6	11.51	33.6	11.92	33.4	12.28	33.4	12.83	33.4	13.36	33.4	14.19
	-13.7	-15	37.8	12.34	37.8	12.75	37.6	13.11	37.6	13.66	37.6	14.19	37.6	14.03
	-11.8	-13	39.9	12.86	39.9	13.28	39.7	13.64	39.7	14.19	39.7	14.11	39.7	13.93
	-9.8	-11	42.2	13.41	42.2	13.83	41.9	14.19	41.9	14.14	41.9	14.03	41.9	13.82
	-9.5	-10	43.2	13.50	43.2	13.91	42.9	14.19	42.9	14.13	42.3	14.01	42.3	13.81
	-8.5	-9.1	46.6	13.77	46.6	14.19	46.3	14.18	46.3	14.11	43.4	13.97	43.4	13.75
	-7.0	-7.6	51.6	14.19	51.6	14.23	51.2	14.18	51.2	14.07	51.2	13.91	46.9	13.68
	-5.0	-5.6	58.3	14.31	58.3	14.28	57.9	14.18	57.9	14.03	57.9	13.83	49.7	13.57
	-3.0	-3.7	64.9	14.44	64.9	14.33	64.5	14.17	63.3	13.98	61.1	13.75	52.5	13.46
	0.0	-0.7	65.1	14.63	65.1	14.40	64.9	14.17	63.3	13.91	61.1	13.62	56.7	13.31
	3.0	2.2	65.1	14.82	65.1	14.48	64.9	14.16	63.3	13.84	61.1	13.50	56.9	13.15
	5.0	4.1	65.1	14.94	65.1	14.53	64.9	14.16	63.3	13.79	61.1	13.42	56.9	13.04
	7.0	6	65.1	15.07	65.1	14.58	64.9	14.16	63.3	13.74	61.1	13.34	56.9	12.94
	9.0	7.9	65.1	15.21	65.1	14.72	64.9	14.29	63.3	13.88	61.1	13.47	56.9	13.06
	11.0	9.8	65.1	15.51	65.1	15.01	64.9	14.57	63.3	14.15	61.1	13.73	56.9	13.32
13.0	11.8	65.1	15.81	65.1	15.30	64.9	14.85	63.3	14.42	61.1	13.99	56.9	13.57	
15.0	13.7	65.1	16.10	65.1	15.59	64.9	15.13	63.3	14.69	61.1	14.26	56.9	13.83	
120	-19.8	-20	29.0	11.07	29.0	11.43	28.8	11.98	28.8	12.50	28.8	13.33	28.8	13.91
	-18.8	-19	30.4	11.34	30.4	11.70	30.2	12.26	30.2	12.78	30.2	13.61	30.2	14.19
	-16.7	-17	33.3	11.92	33.3	12.28	33.1	12.83	33.1	13.36	33.1	14.19	33.1	14.08
	-13.7	-15	37.5	12.75	37.5	13.11	37.3	13.66	37.3	14.19	37.3	14.06	37.3	13.94
	-11.8	-13	39.7	13.28	39.7	13.64	39.4	14.19	39.4	14.10	39.4	13.98	39.4	13.85
	-9.8	-11	41.9	13.83	41.9	14.19	41.6	14.12	41.6	14.02	41.6	13.89	41.6	13.75
	-9.5	-10	42.9	13.91	42.9	14.18	42.6	14.11	42.6	14.01	42.6	13.88	42.6	13.73
	-8.5	-9.1	46.2	14.19	46.2	14.16	45.9	14.08	45.9	13.96	44.5	13.83	44.5	13.69
	-7.0	-7.6	51.2	14.19	51.2	14.13	50.9	14.02	50.9	13.90	46.6	13.77	46.6	13.61
	-5.0	-5.6	57.8	14.19	57.8	14.08	57.5	13.96	57.5	13.81	57.5	13.68	49.3	13.52
	-3.0	-3.7	63.9	14.19	63.9	14.04	61.4	13.89	59.4	13.72	57.5	13.60	52.1	13.42
	0.0	-0.7	64.6	14.20	63.9	13.98	61.4	13.79	59.4	13.60	57.5	13.47	53.4	13.27
	3.0	2.2	64.6	14.20	63.9	13.91	61.4	13.69	59.4	13.47	57.5	13.34	53.4	13.13
	5.0	4.1	64.6	14.21	63.9	13.87	61.4	13.62	59.4	13.38	57.5	13.25	53.4	13.03
	7.0	6	64.6	14.21	63.9	13.82	61.4	13.55	59.4	13.29	57.5	13.17	53.4	12.93
	9.0	7.9	64.6	14.28	63.9	13.89	61.4	13.62	59.4	13.36	57.5	13.23	53.4	13.00
	11.0	9.8	64.6	14.49	63.9	14.10	61.4	13.82	59.4	13.56	57.5	13.43	53.4	13.19
13.0	11.8	64.6	14.70	63.9	14.30	61.4	14.02	59.4	13.75	57.5	13.62	53.4	13.38	
15.0	13.7	64.6	14.90	63.9	14.50	61.4	14.21	59.4	13.94	57.5	13.81	53.4	13.56	
110	-19.8	-20	28.9	11.43	28.9	11.98	28.7	12.50	28.7	13.33	28.7	13.91	28.7	14.19
	-18.8	-19	30.3	11.70	30.3	12.26	30.1	12.78	30.1	13.61	30.1	14.19	30.1	14.11
	-16.7	-17	33.2	12.28	33.2	12.83	33.0	13.36	33.0	14.19	33.0	14.05	33.0	13.94
	-13.7	-15	37.3	13.11	37.3	13.66	37.1	14.19	37.1	13.99	37.1	13.85	37.1	13.71
	-11.8	-13	39.4	13.64	39.4	14.19	39.2	14.06	39.2	13.87	39.2	13.72	39.2	13.56
	-9.8	-11	41.7	14.19	41.7	14.05	41.4	13.92	41.4	13.73	41.4	13.59	41.4	13.40
	-9.5	-10	42.7	14.17	42.7	14.03	42.4	13.90	42.4	13.72	42.4	13.57	42.4	13.38
	-8.5	-9.1	46.0	14.11	46.0	13.97	45.7	13.84	45.7	13.65	44.5	13.50	44.5	13.30
	-7.0	-7.6	50.9	14.01	50.9	13.87	50.6	13.73	50.6	13.55	46.8	13.40	46.8	13.18
	-5.0	-5.6	55.5	13.89	55.5	13.73	55.1	13.60	53.3	13.42	49.0	13.27	48.1	13.03
	-3.0	-3.7	58.7	13.76	58.7	13.60	55.1	13.46	53.3	13.29	51.5	13.14	48.1	12.87
	0.0	-0.7	62.1	13.57	58.7	13.40	55.1	13.26	53.3	13.09	51.5	12.94	48.1	12.64
	3.0	2.2	62.1	13.38	58.7	13.20	55.1	13.06	53.3	12.90	51.5	12.74	48.1	12.40
	5.0	4.1	62.1	13.26	58.7	13.07	55.1	12.92	53.3	12.77	51.5	12.61	48.1	12.24
	7.0	6	62.1	13.13	58.7	12.93	55.1	12.79	53.3	12.63	51.5	12.47	48.1	12.09
	9.0	7.9	62.1	13.12	58.7	12.93	55.1	12.78	53.3	12.63	51.5	12.46	48.1	12.08
	11.0	9.8	62.1	13.24	58.7	13.04	55.1	12.90	53.3	12.74	51.5	12.58	48.1	12.19
13.0	11.8	62.1	13.35	58.7	13.15	55.1	13.00	53.3	12.85	51.5	12.68	48.1	12.29	
15.0	13.7	62.1	13.46	58.7	13.26	55.1	13.11	53.3	12.95	51.5	12.78	48.1	12.39	

Note

1. TC: Total Capacity(kW), PI : Power Input(kW, Comp. + Outdoor fan motor)
2. Capacity tables show the average value of conditions which may occur.
3. In the range beyond the operation limit of the outdoor unit, continuous operation and performance can not be guaranteed. When selecting the outdoor units, avoid the air temperature range that is not guaranteed continuous operation.

7. Capacity Tables

Combination (%)		Heating Capacity (18HP)												
		Outdoor air temp.		Indoor air temp. °C DB										
		°C DB	°C WB	16		18		20		21		22		24
		TC	PI	TC	PI	TC	PI	TC	PI	TC	PI	TC	PI	
100	-19.8	-20	28.8	11.90	28.8	12.36	28.6	12.75	28.6	13.48	28.6	13.99	28.6	14.19
	-18.8	-19	30.1	12.13	29.9	12.59	29.9	13.02	29.9	13.71	29.9	14.19	29.9	14.06
	-16.7	-17	32.8	12.61	32.8	13.07	32.8	13.60	32.6	14.19	32.6	13.93	32.6	13.78
	-13.7	-15	37.1	13.30	37.1	13.75	36.9	14.19	36.9	13.86	36.9	13.57	36.9	13.38
	-11.8	-13	39.2	13.73	39.0	14.19	39.0	14.00	39.0	13.65	39.0	13.34	39.0	13.13
	-9.8	-11	41.5	14.19	41.5	13.99	41.3	13.79	41.3	13.43	41.3	13.10	41.3	12.87
	-9.5	-10	42.4	14.16	42.4	13.96	42.2	13.76	42.2	13.39	42.2	13.07	42.2	12.83
	-8.5	-9.1	45.7	14.07	45.7	13.86	45.5	13.66	48.8	13.28	47.2	12.94	43.9	12.70
	-7.0	-7.6	51.5	13.94	51.3	13.71	50.4	13.51	48.8	13.12	47.2	12.76	43.9	12.50
	-5.0	-5.6	53.8	13.77	53.2	13.51	50.4	13.31	48.8	12.90	47.2	12.52	43.9	12.23
	-3.0	-3.7	55.3	13.59	53.6	13.31	50.4	13.11	48.8	12.68	47.2	12.28	43.9	11.97
	0.0	-0.7	56.9	13.33	53.6	13.01	50.4	12.81	48.8	12.35	47.2	11.92	43.9	11.58
	3.0	2.2	56.9	13.06	53.6	12.71	50.4	12.50	48.8	12.02	47.2	11.56	43.9	11.18
	5.0	4.1	56.9	12.89	53.6	12.51	50.4	12.30	48.8	11.80	47.2	11.32	43.9	10.92
	7.0	6	56.9	12.71	53.6	12.31	50.4	12.10	48.8	11.58	47.2	11.08	43.9	10.65
	9.0	7.9	56.9	12.54	53.6	12.14	50.4	11.93	48.8	11.42	47.2	10.92	43.9	10.51
	11.0	9.8	56.9	12.48	53.6	12.09	50.4	11.88	48.8	11.36	47.2	10.87	43.9	10.46
13.0	11.8	56.9	12.41	53.6	12.02	50.4	11.81	48.8	11.30	47.2	10.81	43.9	10.40	
15.0	13.7	56.9	12.32	53.6	11.94	50.4	11.73	48.8	11.22	47.2	10.74	43.9	10.33	
90	-19.8	-20	28.6	11.21	28.6	12.04	28.5	12.62	28.5	12.89	28.5	12.71	28.5	12.39
	-18.8	-19	30.1	11.49	29.9	12.31	29.8	12.89	29.8	12.81	29.8	12.62	29.8	12.29
	-16.7	-17	32.8	12.07	32.8	12.89	32.7	12.74	32.7	12.63	32.7	12.43	32.7	12.08
	-13.7	-15	37.1	12.89	37.1	12.69	36.8	12.51	36.8	12.37	36.8	12.16	36.8	11.77
	-11.8	-13	39.2	12.78	39.0	12.56	38.9	12.37	38.9	12.20	38.9	11.98	38.9	11.58
	-9.8	-11	41.5	12.65	41.5	12.42	41.1	12.22	41.1	12.03	41.1	11.80	37.7	11.38
	-9.5	-10	42.4	12.64	42.4	12.40	42.1	12.20	42.1	12.01	42.1	11.77	38.6	11.35
	-8.5	-9.1	45.7	12.57	45.4	12.33	45.3	12.12	44.7	11.92	43.2	11.68	40.2	11.25
	-7.0	-7.6	51.5	12.48	49.0	12.23	46.1	12.01	44.7	11.79	43.2	11.55	40.2	11.10
	-5.0	-5.6	52.1	12.36	49.0	12.09	46.1	11.86	44.7	11.62	43.2	11.36	40.2	10.90
	-3.0	-3.7	52.1	12.23	49.0	11.95	46.1	11.71	44.7	11.45	43.2	11.18	40.2	10.69
	0.0	-0.7	52.1	12.05	49.0	11.74	46.1	11.48	44.7	11.19	43.2	10.91	40.2	10.39
	3.0	2.2	52.1	11.86	49.0	11.54	46.1	11.26	44.7	10.93	43.2	10.63	40.2	10.09
	5.0	4.1	52.1	11.74	49.0	11.40	46.1	11.11	44.7	10.76	43.2	10.45	40.2	9.89
	7.0	6	52.1	11.62	49.0	11.26	46.1	10.96	44.7	10.58	43.2	10.27	40.2	9.68
	9.0	7.9	52.1	11.46	49.0	11.11	46.1	10.81	44.7	10.44	43.2	10.13	40.2	9.55
	11.0	9.8	52.1	11.30	49.0	10.95	46.1	10.66	44.7	10.29	43.2	9.99	40.2	9.42
13.0	11.8	52.1	11.14	49.0	10.80	46.1	10.51	44.7	10.15	43.2	9.85	40.2	9.29	
15.0	13.7	52.1	10.98	49.0	10.64	46.1	10.36	44.7	10.00	43.2	9.71	40.2	9.15	
80	-19.8	-20	28.3	9.75	28.3	10.58	28.3	11.43	28.3	11.26	28.3	11.00	28.3	10.71
	-18.8	-19	29.7	10.03	29.7	11.43	29.7	11.36	29.7	11.17	29.7	10.91	29.7	10.62
	-16.7	-17	32.7	11.43	32.7	11.29	32.7	11.19	32.7	10.99	32.7	10.72	32.7	10.43
	-13.7	-15	38.5	11.24	37.7	11.07	36.8	10.95	36.8	10.73	36.8	10.46	35.9	10.15
	-11.8	-13	41.6	11.12	40.4	10.94	38.9	10.80	38.9	10.57	38.6	10.29	35.9	9.98
	-9.8	-11	43.0	10.99	41.7	10.80	41.1	10.65	40.0	10.39	38.6	10.12	35.9	9.79
	-9.5	-10	43.2	10.97	41.9	10.78	41.3	10.62	40.0	10.37	38.6	10.09	35.9	9.77
	-8.5	-9.1	44.8	10.90	43.9	10.71	41.3	10.54	40.0	10.28	38.6	10.00	35.9	9.67
	-7.0	-7.6	46.6	10.80	43.9	10.60	41.3	10.43	40.0	10.15	38.6	9.87	35.9	9.54
	-5.0	-5.6	46.6	10.67	43.9	10.46	41.3	10.27	40.0	9.98	38.6	9.70	35.9	9.35
	-3.0	-3.7	46.6	10.54	43.9	10.32	41.3	10.11	40.0	9.80	38.6	9.52	35.9	9.17
	0.0	-0.7	46.6	10.35	43.9	10.10	41.3	9.88	40.0	9.54	38.6	9.26	35.9	8.89
	3.0	2.2	46.6	10.16	43.9	9.89	41.3	9.64	40.0	9.28	38.6	8.99	35.9	8.62
	5.0	4.1	46.6	10.03	43.9	9.75	41.3	9.48	40.0	9.11	38.6	8.82	35.9	8.44
	7.0	6	46.6	9.90	43.9	9.61	41.3	9.32	40.0	8.94	38.6	8.64	35.9	8.25
	9.0	7.9	46.6	9.29	43.9	9.02	41.3	8.76	40.0	8.39	38.6	8.12	35.9	7.75
	11.0	9.8	46.6	8.62	43.9	8.37	41.3	8.13	40.0	7.79	38.6	7.53	35.9	7.19
13.0	11.8	46.6	8.05	43.9	7.82	41.3	7.59	40.0	7.27	38.6	7.03	35.9	6.71	
15.0	13.7	46.6	7.58	43.9	7.36	41.3	7.14	40.0	6.84	38.6	6.62	35.9	6.32	

Note

1. TC: Total Capacity(kW), PI: Power Input(kW, Comp. + Outdoor fan motor)
2. Capacity tables show the average value of conditions which may occur.
3. In the range beyond the operation limit of the outdoor unit, continuous operation and performance can not be guaranteed. When selecting the outdoor units, avoid the air temperature range that is not guaranteed continuous operation.

7. Capacity Tables

Combination (%)		Heating Capacity (18HP)												
		Outdoor air temp.		Indoor air temp. °C DB										
		°C DB	°C WB	16		18		20		21		22		24
		TC	PI	TC	PI	TC	PI	TC	PI	TC	PI	TC	PI	
70	-19.8	-20	28.3	10.33	28.3	10.61	28.3	10.42	28.3	10.14	28.3	9.87	28.3	9.56
	-18.8	-19	29.7	10.61	29.7	10.52	29.7	10.33	29.7	10.04	29.7	9.77	29.7	9.47
	-16.7	-17	32.7	10.44	32.7	10.34	32.7	10.14	32.7	9.85	32.7	9.58	30.7	9.26
	-13.7	-15	39.5	10.21	37.3	10.07	35.1	9.87	33.9	9.57	32.9	9.30	30.7	8.97
	-11.8	-13	39.5	10.07	37.3	9.91	35.1	9.70	33.9	9.39	32.9	9.13	30.7	8.79
	-9.8	-11	39.5	9.91	37.3	9.73	35.1	9.52	33.9	9.20	32.9	8.95	30.7	8.59
	-9.5	-10	39.5	9.89	37.3	9.71	35.1	9.49	33.9	9.17	32.9	8.92	30.7	8.56
	-8.5	-9.1	39.5	9.81	37.3	9.62	35.1	9.40	33.9	9.08	32.9	8.83	30.7	8.47
	-7.0	-7.6	39.5	9.70	37.3	9.49	35.1	9.26	33.9	8.94	32.9	8.69	30.7	8.32
	-5.0	-5.6	39.5	9.54	37.3	9.32	35.1	9.08	33.9	8.75	32.9	8.50	30.7	8.13
	-3.0	-3.7	39.5	9.39	37.3	9.14	35.1	8.90	33.9	8.57	32.9	8.32	30.7	7.93
	0.0	-0.7	39.5	9.16	37.3	8.88	35.1	8.63	33.9	8.29	32.9	8.05	30.7	7.64
	3.0	2.2	39.5	8.93	37.3	8.62	35.1	8.36	33.9	8.01	32.9	7.77	30.7	7.35
	5.0	4.1	39.5	8.77	37.3	8.44	35.1	8.18	33.9	7.82	32.9	7.59	30.7	7.15
	7.0	6	39.5	8.62	37.3	8.27	35.1	7.99	33.9	7.63	32.9	7.40	30.7	6.96
	9.0	7.9	39.5	7.78	37.3	7.47	35.1	7.22	33.9	6.89	32.9	6.68	30.7	6.28
	11.0	9.8	39.5	7.25	37.3	6.95	35.1	6.72	33.9	6.42	32.9	6.22	30.7	5.85
13.0	11.8	39.5	6.78	37.3	6.51	35.1	6.29	33.9	6.00	32.9	5.82	30.7	5.47	
15.0	13.7	39.5	6.39	37.3	6.13	35.1	5.93	33.9	5.66	32.9	5.49	30.7	5.16	
60	-19.8	-20	33.9	9.78	32.1	9.60	28.3	9.31	28.3	9.04	28.1	8.76	26.3	8.46
	-18.8	-19	33.9	9.70	32.1	9.51	29.7	9.22	29.1	8.94	28.1	8.67	26.3	8.36
	-16.7	-17	33.9	9.53	32.1	9.31	30.1	9.03	29.1	8.75	28.1	8.48	26.3	8.16
	-13.7	-15	33.9	9.29	32.1	9.04	30.1	8.75	29.1	8.47	28.1	8.20	26.3	7.87
	-11.8	-13	33.9	9.14	32.1	8.87	30.1	8.57	29.1	8.30	28.1	8.02	26.3	7.68
	-9.8	-11	33.9	8.98	32.1	8.69	30.1	8.39	29.1	8.11	28.1	7.84	26.3	7.49
	-9.5	-10	33.9	8.96	32.1	8.66	30.1	8.36	29.1	8.09	28.1	7.81	26.3	7.46
	-8.5	-9.1	33.9	8.88	32.1	8.57	30.1	8.26	29.1	7.99	28.1	7.72	26.3	7.36
	-7.0	-7.6	33.9	8.76	32.1	8.43	30.1	8.13	29.1	7.85	28.1	7.58	26.3	7.21
	-5.0	-5.6	33.9	8.60	32.1	8.25	30.1	7.94	29.1	7.67	28.1	7.40	26.3	7.02
	-3.0	-3.7	33.9	8.44	32.1	8.07	30.1	7.75	29.1	7.48	28.1	7.21	26.3	6.82
	0.0	-0.7	33.9	8.20	32.1	7.80	30.1	7.48	29.1	7.21	28.1	6.94	26.3	6.53
	3.0	2.2	33.9	7.96	32.1	7.52	30.1	7.20	29.1	6.93	28.1	6.66	26.3	6.24
	5.0	4.1	33.9	7.80	32.1	7.34	30.1	7.01	29.1	6.75	28.1	6.48	26.3	6.05
	7.0	6	33.9	7.64	32.1	7.16	30.1	6.83	29.1	6.56	28.1	6.29	26.3	5.85
	9.0	7.9	33.9	6.82	32.1	6.39	30.1	6.09	29.1	5.85	28.1	5.62	26.3	5.22
	11.0	9.8	33.9	6.37	32.1	5.97	30.1	5.69	29.1	5.47	28.1	5.24	26.3	4.88
13.0	11.8	33.9	5.97	32.1	5.59	30.1	5.33	29.1	5.12	28.1	4.91	26.3	4.57	
15.0	13.7	33.9	5.64	32.1	5.28	30.1	5.03	29.1	4.84	28.1	4.64	26.3	4.32	
50	-19.8	-20	28.3	8.76	26.7	8.45	25.1	8.16	24.3	7.88	23.5	7.60	21.9	7.32
	-18.8	-19	28.3	8.66	26.7	8.35	25.1	8.07	24.3	7.78	23.5	7.51	21.9	7.22
	-16.7	-17	28.3	8.46	26.7	8.14	25.1	7.86	24.3	7.58	23.5	7.32	21.9	7.02
	-13.7	-15	28.3	8.17	26.7	7.84	25.1	7.57	24.3	7.28	23.5	7.04	21.9	6.74
	-11.8	-13	28.3	7.98	26.7	7.65	25.1	7.39	24.3	7.10	23.5	6.86	21.9	6.56
	-9.8	-11	28.3	7.79	26.7	7.45	25.1	7.19	24.3	6.91	23.5	6.68	21.9	6.37
	-9.5	-10	28.3	7.76	26.7	7.42	25.1	7.16	24.3	6.88	23.5	6.65	21.9	6.34
	-8.5	-9.1	28.3	7.66	26.7	7.32	25.1	7.07	24.3	6.78	23.5	6.56	21.9	6.25
	-7.0	-7.6	28.3	7.52	26.7	7.17	25.1	6.92	24.3	6.64	23.5	6.42	21.9	6.10
	-5.0	-5.6	28.3	7.33	26.7	6.97	25.1	6.73	24.3	6.44	23.5	6.23	21.9	5.91
	-3.0	-3.7	28.3	7.13	26.7	6.77	25.1	6.53	24.3	6.25	23.5	6.05	21.9	5.72
	0.0	-0.7	28.3	6.84	26.7	6.47	25.1	6.24	24.3	5.96	23.5	5.77	21.9	5.44
	3.0	2.2	28.3	6.55	26.7	6.17	25.1	5.95	24.3	5.67	23.5	5.49	21.9	5.15
	5.0	4.1	28.3	6.36	26.7	5.97	25.1	5.76	24.3	5.48	23.5	5.30	21.9	4.97
	7.0	6	28.3	6.17	26.7	5.77	25.1	5.56	24.3	5.28	23.5	5.12	21.9	4.78
	9.0	7.9	28.3	5.57	26.7	5.21	25.1	5.02	24.3	4.77	23.5	4.62	21.9	4.31
	11.0	9.8	28.3	5.21	26.7	4.88	25.1	4.70	24.3	4.46	23.5	4.33	21.9	4.04
13.0	11.8	28.3	4.89	26.7	4.58	25.1	4.41	24.3	4.19	23.5	4.06	21.9	3.79	
15.0	13.7	28.3	4.63	26.7	4.33	25.1	4.17	24.3	3.97	23.5	3.84	21.9	3.59	

Note

1. TC: Total Capacity(kW), PI : Power Input(kW, Comp. + Outdoor fan motor)
2. Capacity tables show the average value of conditions which may occur.
3. In the range beyond the operation limit of the outdoor unit, continuous operation and performance can not be guaranteed. When selecting the outdoor units, avoid the air temperature range that is not guaranteed continuous operation.

7. Capacity Tables

◆ A(C)RUN200LLS5

Combination (%)	Outdoor air temp.		Indoor air temp. °C DB											
	°C DB	°C WB	16		18		20		21		22		24	
			TC	PI	TC	PI	TC	PI	TC	PI	TC	PI	TC	PI
130	-19.8	-20	32.4	12.78	32.4	13.27	32.2	13.70	32.2	14.36	32.2	14.99	32.2	15.98
	-18.8	-19	34.0	13.11	34.0	13.60	33.8	14.03	33.8	14.69	33.8	15.32	33.8	16.31
	-16.7	-17	37.3	13.80	37.3	14.30	37.1	14.73	37.1	15.39	37.1	16.01	37.1	17.00
	-13.7	-15	42.0	14.79	42.0	15.29	41.8	15.72	41.8	16.38	41.8	17.00	41.8	16.81
	-11.8	-13	44.4	15.42	44.4	15.91	44.1	16.34	44.1	17.00	44.1	16.91	44.1	16.69
	-9.8	-11	46.9	16.08	46.9	16.57	46.6	17.00	46.6	16.95	46.6	16.81	46.6	16.57
	-9.5	-10	48.0	16.18	48.0	16.67	47.7	17.00	47.7	16.94	47.0	16.80	47.0	16.55
	-8.5	-9.1	51.7	16.51	51.7	17.00	51.4	17.00	51.4	16.91	48.2	16.75	48.2	16.48
	-7.0	-7.6	57.3	17.00	57.3	17.05	56.9	17.00	56.9	16.87	56.9	16.67	52.2	16.39
	-5.0	-5.6	64.7	17.15	64.7	17.11	64.3	16.99	64.3	16.81	64.3	16.57	55.4	16.26
	-3.0	-3.7	72.2	17.30	72.2	17.17	71.7	16.99	70.4	16.75	67.9	16.47	58.5	16.14
	0.0	-0.7	72.4	17.53	72.4	17.26	72.2	16.98	70.4	16.67	67.9	16.33	63.2	15.95
	3.0	2.2	72.4	17.75	72.4	17.35	72.2	16.97	70.4	16.58	67.9	16.18	63.2	15.76
	5.0	4.1	72.4	17.90	72.4	17.41	72.2	16.97	70.4	16.53	67.9	16.08	63.2	15.63
	7.0	6	72.4	18.05	72.4	17.47	72.2	16.97	70.4	16.47	67.9	15.98	63.2	15.50
	9.0	7.9	72.4	18.23	72.4	17.64	72.2	17.13	70.4	16.63	67.9	16.14	63.2	15.65
	11.0	9.8	72.4	18.59	72.4	17.99	72.2	17.46	70.4	16.96	67.9	16.45	63.2	15.96
13.0	11.8	72.4	18.94	72.4	18.33	72.2	17.80	70.4	17.28	67.9	16.77	63.2	16.26	
15.0	13.7	72.4	19.30	72.4	18.68	72.2	18.13	70.4	17.61	67.9	17.08	63.2	16.57	
120	-19.8	-20	32.2	13.27	32.2	13.70	32.0	14.36	32.0	14.99	32.0	15.98	32.0	16.67
	-18.8	-19	33.8	13.60	33.8	14.03	33.6	14.69	33.6	15.32	33.6	16.31	33.6	17.00
	-16.7	-17	37.1	14.30	37.1	14.73	36.8	15.39	36.8	16.01	36.8	17.00	36.8	16.88
	-13.7	-15	41.7	15.29	41.7	15.72	41.5	16.38	41.5	17.00	41.5	16.85	41.5	16.71
	-11.8	-13	44.1	15.91	44.1	16.34	43.8	17.00	43.8	16.90	43.8	16.75	43.8	16.59
	-9.8	-11	46.6	16.57	46.6	17.00	46.3	16.92	46.3	16.80	46.3	16.65	46.3	16.48
	-9.5	-10	47.7	16.67	47.7	17.00	47.4	16.91	47.4	16.79	47.4	16.63	47.4	16.46
	-8.5	-9.1	51.4	17.00	51.4	16.97	51.0	16.87	51.0	16.73	49.5	16.58	49.5	16.40
	-7.0	-7.6	56.9	17.01	56.9	16.93	56.5	16.81	56.5	16.66	51.9	16.50	51.9	16.31
	-5.0	-5.6	64.3	17.01	64.3	16.88	63.9	16.73	63.9	16.55	63.9	16.40	55.0	16.20
	-3.0	-3.7	71.0	17.01	71.0	16.83	68.2	16.65	66.0	16.45	63.9	16.30	58.1	16.08
	0.0	-0.7	71.8	17.02	71.0	16.75	68.2	16.52	66.0	16.29	63.9	16.14	59.4	15.91
	3.0	2.2	71.8	17.02	71.0	16.67	68.2	16.40	66.0	16.14	63.9	15.99	59.4	15.73
	5.0	4.1	71.8	17.02	71.0	16.62	68.2	16.32	66.0	16.03	63.9	15.88	59.4	15.61
	7.0	6	71.8	17.03	71.0	16.57	68.2	16.24	66.0	15.93	63.9	15.78	59.4	15.50
	9.0	7.9	71.8	17.11	71.0	16.65	68.2	16.32	66.0	16.01	63.9	15.86	59.4	15.57
	11.0	9.8	71.8	17.36	71.0	16.89	68.2	16.56	66.0	16.24	63.9	16.09	59.4	15.80
13.0	11.8	71.8	17.61	71.0	17.13	68.2	16.80	66.0	16.48	63.9	16.32	59.4	16.03	
15.0	13.7	71.8	17.86	71.0	17.37	68.2	17.03	66.0	16.70	63.9	16.55	59.4	16.25	
110	-19.8	-20	32.0	13.70	32.0	14.36	31.8	14.99	31.8	15.98	31.8	16.67	31.8	17.00
	-18.8	-19	33.6	14.03	33.6	14.69	33.4	15.32	33.4	16.31	33.4	17.00	33.4	16.91
	-16.7	-17	36.9	14.73	36.9	15.39	36.6	16.01	36.6	17.00	36.6	16.84	36.6	16.71
	-13.7	-15	41.5	15.72	41.5	16.38	41.3	17.00	41.3	16.77	41.3	16.60	41.3	16.43
	-11.8	-13	43.8	16.34	43.8	17.00	43.6	16.85	43.6	16.62	43.6	16.44	43.6	16.25
	-9.8	-11	46.3	17.00	46.3	16.84	46.0	16.69	46.0	16.46	46.0	16.29	46.0	16.06
	-9.5	-10	47.4	16.98	47.4	16.82	47.1	16.66	47.1	16.44	47.1	16.26	47.1	16.03
	-8.5	-9.1	51.1	16.91	51.1	16.74	50.8	16.58	50.8	16.36	49.4	16.18	49.4	15.94
	-7.0	-7.6	56.6	16.79	56.6	16.62	56.2	16.46	56.2	16.24	51.9	16.06	51.9	15.80
	-5.0	-5.6	61.6	16.64	61.6	16.46	61.2	16.30	59.2	16.08	54.3	15.90	53.4	15.61
	-3.0	-3.7	65.2	16.49	65.2	16.30	61.2	16.14	59.2	15.93	57.2	15.74	53.4	15.42
	0.0	-0.7	69.0	16.26	65.2	16.06	61.2	15.89	59.2	15.69	57.2	15.50	53.4	15.14
	3.0	2.2	69.0	16.04	65.2	15.82	61.2	15.65	59.2	15.45	57.2	15.26	53.4	14.86
	5.0	4.1	69.0	15.89	65.2	15.66	61.2	15.49	59.2	15.30	57.2	15.11	53.4	14.67
	7.0	6	69.0	15.74	65.2	15.50	61.2	15.33	59.2	15.14	57.2	14.95	53.4	14.48
	9.0	7.9	69.0	15.73	65.2	15.49	61.2	15.32	59.2	15.13	57.2	14.94	53.4	14.47
	11.0	9.8	69.0	15.87	65.2	15.63	61.2	15.45	59.2	15.26	57.2	15.07	53.4	14.60
13.0	11.8	69.0	16.00	65.2	15.76	61.2	15.58	59.2	15.39	57.2	15.20	53.4	14.73	
15.0	13.7	69.0	16.13	65.2	15.88	61.2	15.71	59.2	15.52	57.2	15.32	53.4	14.84	

Note

1. TC: Total Capacity(kW), PI : Power Input(kW, Comp. + Outdoor fan motor)
2. Capacity tables show the average value of conditions which may occur.
3. In the range beyond the operation limit of the outdoor unit, continuous operation and performance can not be guaranteed. When selecting the outdoor units, avoid the air temperature range that is not guaranteed continuous operation.

7. Capacity Tables

Combination (%)		Heating Capacity (20HP)												
		Outdoor air temp.		Indoor air temp. °C DB										
		°C DB	°C WB	16		18		20		21		22		24
		TC	PI	TC	PI	TC	PI	TC	PI	TC	PI	TC	PI	
100	-19.8	-20	31.9	14.26	31.9	14.81	31.7	15.28	31.7	16.15	31.7	16.77	31.7	17.00
	-18.8	-19	33.4	14.54	33.2	15.09	33.2	15.61	33.2	16.43	33.2	17.00	33.2	16.84
	-16.7	-17	36.5	15.11	36.5	15.66	36.5	16.30	36.3	17.00	36.3	16.70	36.3	16.51
	-13.7	-15	41.3	15.93	41.3	16.48	41.1	17.00	41.1	16.61	41.1	16.27	41.1	16.04
	-11.8	-13	43.6	16.46	43.4	17.00	43.4	16.77	43.4	16.36	43.4	15.99	43.4	15.74
	-9.8	-11	46.1	17.00	46.1	16.76	45.8	16.53	45.8	16.09	45.8	15.70	45.8	15.42
	-9.5	-10	47.1	16.97	47.1	16.73	46.9	16.50	46.9	16.05	46.9	15.66	46.9	15.37
	-8.5	-9.1	50.8	16.87	50.8	16.61	50.6	16.37	54.2	15.92	52.4	15.51	48.8	15.22
	-7.0	-7.6	57.2	16.71	57.0	16.43	56.0	16.19	54.2	15.72	52.4	15.30	48.8	14.98
	-5.0	-5.6	59.7	16.50	59.1	16.19	56.0	15.95	54.2	15.46	52.4	15.01	48.8	14.66
	-3.0	-3.7	61.4	16.29	59.6	15.95	56.0	15.71	54.2	15.19	52.4	14.72	48.8	14.35
	0.0	-0.7	63.2	15.97	59.6	15.59	56.0	15.35	54.2	14.80	52.4	14.28	48.8	13.87
	3.0	2.2	63.2	15.66	59.6	15.23	56.0	14.98	54.2	14.40	52.4	13.85	48.8	13.40
	5.0	4.1	63.2	15.45	59.6	15.00	56.0	14.74	54.2	14.14	52.4	13.56	48.8	13.08
	7.0	6	63.2	15.23	59.6	14.76	56.0	14.50	54.2	13.87	52.4	13.27	48.8	12.77
	9.0	7.9	63.2	15.02	59.6	14.55	56.0	14.30	54.2	13.68	52.4	13.09	48.8	12.59
	11.0	9.8	63.2	14.95	59.6	14.48	56.0	14.23	54.2	13.61	52.4	13.03	48.8	12.53
13.0	11.8	63.2	14.86	59.6	14.40	56.0	14.15	54.2	13.53	52.4	12.95	48.8	12.45	
15.0	13.7	63.2	14.76	59.6	14.30	56.0	14.05	54.2	13.44	52.4	12.86	48.8	12.37	
90	-19.8	-20	31.8	13.44	31.8	14.43	31.6	15.12	31.6	15.45	31.6	15.23	31.6	14.85
	-18.8	-19	33.4	13.77	33.2	14.76	33.1	15.45	33.1	15.35	33.1	15.12	33.1	14.73
	-16.7	-17	36.5	14.46	36.5	15.45	36.3	15.26	36.3	15.13	36.3	14.90	36.3	14.47
	-13.7	-15	41.3	15.45	41.3	15.20	40.9	14.99	40.9	14.82	40.9	14.57	40.9	14.11
	-11.8	-13	43.6	15.31	43.4	15.05	43.2	14.82	43.2	14.63	43.2	14.36	43.2	13.88
	-9.8	-11	46.1	15.16	46.1	14.88	45.6	14.64	45.6	14.42	45.6	14.14	41.9	13.64
	-9.5	-10	47.1	15.14	47.1	14.86	46.7	14.62	46.7	14.39	46.7	14.11	42.9	13.60
	-8.5	-9.1	50.8	15.07	50.5	14.78	50.3	14.53	49.6	14.29	48.1	14.00	44.6	13.48
	-7.0	-7.6	57.2	14.96	54.4	14.65	51.2	14.39	49.6	14.13	48.1	13.84	44.6	13.30
	-5.0	-5.6	57.8	14.81	54.4	14.49	51.2	14.21	49.6	13.92	48.1	13.62	44.6	13.06
	-3.0	-3.7	57.8	14.66	54.4	14.32	51.2	14.03	49.6	13.72	48.1	13.40	44.6	12.82
	0.0	-0.7	57.8	14.44	54.4	14.07	51.2	13.76	49.6	13.41	48.1	13.07	44.6	12.45
	3.0	2.2	57.8	14.22	54.4	13.82	51.2	13.49	49.6	13.10	48.1	12.74	44.6	12.09
	5.0	4.1	57.8	14.07	54.4	13.66	51.2	13.31	49.6	12.89	48.1	12.53	44.6	11.85
	7.0	6	57.8	13.92	54.4	13.49	51.2	13.13	49.6	12.68	48.1	12.31	44.6	11.61
	9.0	7.9	57.8	13.73	54.4	13.31	51.2	12.95	49.6	12.51	48.1	12.14	44.6	11.45
	11.0	9.8	57.8	13.54	54.4	13.12	51.2	12.77	49.6	12.34	48.1	11.97	44.6	11.29
13.0	11.8	57.8	13.35	54.4	12.94	51.2	12.59	49.6	12.16	48.1	11.80	44.6	11.13	
15.0	13.7	57.8	13.16	54.4	12.75	51.2	12.41	49.6	11.99	48.1	11.63	44.6	10.97	
80	-19.8	-20	31.4	11.69	31.4	12.68	31.4	13.70	31.4	13.49	31.4	13.18	31.4	12.84
	-18.8	-19	33.0	12.02	33.0	13.70	33.0	13.61	33.0	13.39	33.0	13.07	33.0	12.73
	-16.7	-17	36.3	13.70	36.3	13.52	36.3	13.41	36.3	13.17	36.3	12.85	36.3	12.50
	-13.7	-15	42.8	13.47	41.9	13.27	40.9	13.13	40.9	12.86	40.9	12.53	39.9	12.17
	-11.8	-13	46.3	13.32	44.9	13.11	43.2	12.95	43.2	12.66	42.9	12.33	39.9	11.96
	-9.8	-11	47.7	13.17	46.3	12.94	45.6	12.76	44.5	12.46	42.9	12.12	39.9	11.74
	-9.5	-10	48.0	13.14	46.6	12.91	45.8	12.73	44.5	12.42	42.9	12.09	39.9	11.70
	-8.5	-9.1	49.8	13.06	48.8	12.83	45.8	12.64	44.5	12.32	42.9	11.99	39.9	11.59
	-7.0	-7.6	51.8	12.95	48.8	12.70	45.8	12.49	44.5	12.16	42.9	11.83	39.9	11.43
	-5.0	-5.6	51.8	12.79	48.8	12.53	45.8	12.31	44.5	11.96	42.9	11.62	39.9	11.21
	-3.0	-3.7	51.8	12.64	48.8	12.36	45.8	12.12	44.5	11.75	42.9	11.41	39.9	10.99
	0.0	-0.7	51.8	12.40	48.8	12.11	45.8	11.83	44.5	11.44	42.9	11.09	39.9	10.66
	3.0	2.2	51.8	12.17	48.8	11.85	45.8	11.55	44.5	11.13	42.9	10.78	39.9	10.33
	5.0	4.1	51.8	12.01	48.8	11.68	45.8	11.36	44.5	10.92	42.9	10.57	39.9	10.11
	7.0	6	51.8	11.86	48.8	11.51	45.8	11.17	44.5	10.71	42.9	10.36	39.9	9.89
	9.0	7.9	51.8	11.13	48.8	10.81	45.8	10.49	44.5	10.06	42.9	9.73	39.9	9.29
	11.0	9.8	51.8	10.33	48.8	10.03	45.8	9.74	44.5	9.33	42.9	9.03	39.9	8.62
13.0	11.8	51.8	9.65	48.8	9.37	45.8	9.09	44.5	8.71	42.9	8.43	39.9	8.05	
15.0	13.7	51.8	9.08	48.8	8.82	45.8	8.56	44.5	8.20	42.9	7.93	39.9	7.57	

Note

1. TC: Total Capacity(kW), PI: Power Input(kW, Comp. + Outdoor fan motor)
2. Capacity tables show the average value of conditions which may occur.
3. In the range beyond the operation limit of the outdoor unit, continuous operation and performance can not be guaranteed. When selecting the outdoor units, avoid the air temperature range that is not guaranteed continuous operation.

7. Capacity Tables

Combination (%)		Heating Capacity (20HP)												
		Outdoor air temp.		Indoor air temp. °C DB										
		°C DB	°C WB	16		18		20		21		22		24
		TC	PI	TC	PI	TC	PI	TC	PI	TC	PI	TC	PI	
70	-19.8	-20	31.4	12.38	31.4	12.71	31.4	12.49	31.4	12.15	31.4	11.82	31.4	11.46
	-18.8	-19	33.0	12.71	33.0	12.61	33.0	12.39	33.0	12.04	33.0	11.71	33.0	11.35
	-16.7	-17	36.3	12.52	36.3	12.39	36.3	12.16	36.3	11.80	36.3	11.48	34.1	11.10
	-13.7	-15	43.9	12.24	41.5	12.07	39.0	11.83	37.7	11.47	36.6	11.15	34.1	10.75
	-11.8	-13	43.9	12.06	41.5	11.88	39.0	11.62	37.7	11.25	36.6	10.94	34.1	10.53
	-9.8	-11	43.9	11.88	41.5	11.67	39.0	11.41	37.7	11.03	36.6	10.72	34.1	10.30
	-9.5	-10	43.9	11.85	41.5	11.64	39.0	11.37	37.7	11.00	36.6	10.69	34.1	10.26
	-8.5	-9.1	43.9	11.76	41.5	11.53	39.0	11.27	37.7	10.88	36.6	10.58	34.1	10.15
	-7.0	-7.6	43.9	11.62	41.5	11.37	39.0	11.10	37.7	10.72	36.6	10.41	34.1	9.97
	-5.0	-5.6	43.9	11.44	41.5	11.17	39.0	10.88	37.7	10.49	36.6	10.19	34.1	9.74
	-3.0	-3.7	43.9	11.25	41.5	10.96	39.0	10.67	37.7	10.27	36.6	9.97	34.1	9.50
	0.0	-0.7	43.9	10.97	41.5	10.64	39.0	10.34	37.7	9.93	36.6	9.64	34.1	9.15
	3.0	2.2	43.9	10.70	41.5	10.33	39.0	10.01	37.7	9.59	36.6	9.31	34.1	8.81
	5.0	4.1	43.9	10.51	41.5	10.12	39.0	9.80	37.7	9.37	36.6	9.09	34.1	8.57
	7.0	6	43.9	10.33	41.5	9.91	39.0	9.58	37.7	9.15	36.6	8.87	34.1	8.34
	9.0	7.9	43.9	9.32	41.5	8.95	39.0	8.65	37.7	8.26	36.6	8.01	34.1	7.53
	11.0	9.8	43.9	8.68	41.5	8.33	39.0	8.05	37.7	7.69	36.6	7.46	34.1	7.01
	13.0	11.8	43.9	8.12	41.5	7.80	39.0	7.54	37.7	7.19	36.6	6.98	34.1	6.56
15.0	13.7	43.9	7.66	41.5	7.35	39.0	7.10	37.7	6.78	36.6	6.58	34.1	6.18	
60	-19.8	-20	37.7	11.72	35.7	11.50	31.4	11.17	31.4	10.83	31.2	10.50	29.2	10.14
	-18.8	-19	37.7	11.63	35.7	11.39	33.0	11.05	32.3	10.72	31.2	10.39	29.2	10.02
	-16.7	-17	37.7	11.43	35.7	11.17	33.4	10.82	32.3	10.49	31.2	10.16	29.2	9.78
	-13.7	-15	37.7	11.14	35.7	10.84	33.4	10.49	32.3	10.16	31.2	9.83	29.2	9.43
	-11.8	-13	37.7	10.96	35.7	10.63	33.4	10.27	32.3	9.95	31.2	9.62	29.2	9.21
	-9.8	-11	37.7	10.77	35.7	10.41	33.4	10.05	32.3	9.72	31.2	9.40	29.2	8.97
	-9.5	-10	37.7	10.74	35.7	10.38	33.4	10.02	32.3	9.69	31.2	9.36	29.2	8.94
	-8.5	-9.1	37.7	10.64	35.7	10.27	33.4	9.91	32.3	9.58	31.2	9.25	29.2	8.82
	-7.0	-7.6	37.7	10.50	35.7	10.11	33.4	9.74	32.3	9.41	31.2	9.09	29.2	8.65
	-5.0	-5.6	37.7	10.31	35.7	9.89	33.4	9.52	32.3	9.19	31.2	8.87	29.2	8.41
	-3.0	-3.7	37.7	10.12	35.7	9.67	33.4	9.29	32.3	8.97	31.2	8.65	29.2	8.18
	0.0	-0.7	37.7	9.83	35.7	9.34	33.4	8.96	32.3	8.64	31.2	8.31	29.2	7.83
	3.0	2.2	37.7	9.54	35.7	9.02	33.4	8.63	32.3	8.31	31.2	7.98	29.2	7.48
	5.0	4.1	37.7	9.35	35.7	8.80	33.4	8.40	32.3	8.08	31.2	7.76	29.2	7.25
	7.0	6	37.7	9.16	35.7	8.58	33.4	8.18	32.3	7.86	31.2	7.54	29.2	7.01
	9.0	7.9	37.7	8.17	35.7	7.66	33.4	7.30	32.3	7.01	31.2	6.73	29.2	6.26
	11.0	9.8	37.7	7.63	35.7	7.15	33.4	6.81	32.3	6.55	31.2	6.28	29.2	5.84
	13.0	11.8	37.7	7.15	35.7	6.70	33.4	6.38	32.3	6.14	31.2	5.89	29.2	5.47
15.0	13.7	37.7	6.76	35.7	6.33	33.4	6.03	32.3	5.80	31.2	5.56	29.2	5.17	
50	-19.8	-20	31.4	10.50	29.7	10.13	27.9	9.79	27.0	9.44	26.1	9.12	24.3	8.77
	-18.8	-19	31.4	10.38	29.7	10.01	27.9	9.67	27.0	9.33	26.1	9.01	24.3	8.66
	-16.7	-17	31.4	10.14	29.7	9.76	27.9	9.43	27.0	9.08	26.1	8.77	24.3	8.42
	-13.7	-15	31.4	9.79	29.7	9.40	27.9	9.08	27.0	8.73	26.1	8.44	24.3	8.08
	-11.8	-13	31.4	9.57	29.7	9.17	27.9	8.86	27.0	8.51	26.1	8.23	24.3	7.86
	-9.8	-11	31.4	9.34	29.7	8.93	27.9	8.62	27.0	8.28	26.1	8.00	24.3	7.63
	-9.5	-10	31.4	9.30	29.7	8.90	27.9	8.59	27.0	8.25	26.1	7.97	24.3	7.60
	-8.5	-9.1	31.4	9.19	29.7	8.78	27.9	8.47	27.0	8.13	26.1	7.86	24.3	7.49
	-7.0	-7.6	31.4	9.01	29.7	8.60	27.9	8.30	27.0	7.96	26.1	7.69	24.3	7.32
	-5.0	-5.6	31.4	8.78	29.7	8.36	27.9	8.06	27.0	7.72	26.1	7.47	24.3	7.09
	-3.0	-3.7	31.4	8.55	29.7	8.12	27.9	7.83	27.0	7.49	26.1	7.25	24.3	6.86
	0.0	-0.7	31.4	8.20	29.7	7.76	27.9	7.48	27.0	7.14	26.1	6.91	24.3	6.52
	3.0	2.2	31.4	7.85	29.7	7.40	27.9	7.13	27.0	6.79	26.1	6.58	24.3	6.18
	5.0	4.1	31.4	7.62	29.7	7.16	27.9	6.90	27.0	6.56	26.1	6.36	24.3	5.95
	7.0	6	31.4	7.39	29.7	6.92	27.9	6.66	27.0	6.33	26.1	6.13	24.3	5.72
	9.0	7.9	31.4	6.67	29.7	6.25	27.9	6.02	27.0	5.72	26.1	5.54	24.3	5.17
	11.0	9.8	31.4	6.24	29.7	5.85	27.9	5.63	27.0	5.35	26.1	5.18	24.3	4.84
	13.0	11.8	31.4	5.86	29.7	5.49	27.9	5.29	27.0	5.02	26.1	4.87	24.3	4.54
15.0	13.7	31.4	5.55	29.7	5.19	27.9	5.00	27.0	4.75	26.1	4.61	24.3	4.30	

Note

1. TC: Total Capacity(kW), PI: Power Input(kW, Comp. + Outdoor fan motor)
2. Capacity tables show the average value of conditions which may occur.
3. In the range beyond the operation limit of the outdoor unit, continuous operation and performance can not be guaranteed. When selecting the outdoor units, avoid the air temperature range that is not guaranteed continuous operation.

7. Capacity Tables

◆ A(C)RUN220LLS5

Combination (%)	Outdoor air temp.		Indoor air temp. °C DB											
	°C DB	°C WB	16		18		20		21		22		24	
			TC	PI	TC	PI	TC	PI	TC	PI	TC	PI	TC	PI
130	-19.8	-20	35.6	15.68	35.6	16.29	35.4	16.81	35.4	17.63	35.4	18.40	35.4	19.62
	-18.8	-19	37.4	16.08	37.4	16.69	37.1	17.22	37.1	18.03	37.1	18.80	37.1	20.02
	-16.7	-17	41.0	16.94	41.0	17.55	40.8	18.07	40.8	18.88	40.8	19.66	40.8	20.87
	-13.7	-15	46.2	18.15	46.2	18.76	45.9	19.29	45.9	20.10	45.9	20.87	45.9	20.64
	-11.8	-13	48.8	18.93	48.8	19.53	48.5	20.06	48.5	20.87	48.5	20.76	48.5	20.49
	-9.8	-11	51.6	19.74	51.6	20.35	51.2	20.87	51.2	20.80	51.2	20.64	51.2	20.34
	-9.5	-10	52.8	19.86	52.8	20.47	52.5	20.87	52.5	20.79	51.7	20.62	51.7	20.31
	-8.5	-9.1	56.9	20.27	56.9	20.87	56.5	20.87	56.5	20.76	53.0	20.56	53.0	20.24
	-7.0	-7.6	63.0	20.87	63.0	20.93	62.6	20.87	62.6	20.71	62.6	20.47	57.4	20.12
	-5.0	-5.6	71.2	21.06	71.2	21.00	70.8	20.86	70.8	20.64	70.8	20.35	60.9	19.96
	-3.0	-3.7	79.4	21.24	79.4	21.08	78.9	20.85	77.4	20.57	74.7	20.23	64.3	19.81
	0.0	-0.7	79.6	21.52	79.6	21.19	79.4	20.85	77.4	20.46	74.7	20.04	69.5	19.57
	3.0	2.2	79.6	21.80	79.6	21.30	79.4	20.84	77.4	20.36	74.7	19.86	69.5	19.34
	5.0	4.1	79.6	21.98	79.6	21.37	79.4	20.83	77.4	20.29	74.7	19.74	69.5	19.19
	7.0	6	79.6	22.16	79.6	21.45	79.4	20.83	77.4	20.22	74.7	19.62	69.5	19.03
	9.0	7.9	79.6	22.38	79.6	21.66	79.4	21.03	77.4	20.42	74.7	19.81	69.5	19.22
	11.0	9.8	79.6	22.82	79.6	22.08	79.4	21.44	77.4	20.81	74.7	20.20	69.5	19.59
13.0	11.8	79.6	23.25	79.6	22.50	79.4	21.85	77.4	21.21	74.7	20.58	69.5	19.97	
15.0	13.7	79.6	23.69	79.6	22.93	79.4	22.26	77.4	21.61	74.7	20.97	69.5	20.34	
120	-19.8	-20	35.4	16.29	35.4	16.81	35.2	17.63	35.2	18.40	35.2	19.62	35.2	20.47
	-18.8	-19	37.1	16.69	37.1	17.22	36.9	18.03	36.9	18.80	36.9	20.02	36.9	20.87
	-16.7	-17	40.7	17.55	40.7	18.07	40.5	18.88	40.5	19.66	40.5	20.87	40.5	20.72
	-13.7	-15	45.9	18.76	45.9	19.29	45.6	20.10	45.6	20.87	45.6	20.68	45.6	20.51
	-11.8	-13	48.5	19.53	48.5	20.06	48.2	20.87	48.2	20.75	48.2	20.56	48.2	20.37
	-9.8	-11	51.2	20.35	51.2	20.87	50.9	20.77	50.9	20.63	50.9	20.44	50.9	20.23
	-9.5	-10	52.4	20.47	52.4	20.86	52.1	20.76	52.1	20.61	52.1	20.42	52.1	20.21
	-8.5	-9.1	56.5	20.87	56.5	20.83	56.1	20.71	56.1	20.54	54.5	20.35	54.5	20.14
	-7.0	-7.6	62.6	20.88	62.6	20.78	62.2	20.63	62.2	20.45	57.0	20.26	57.0	20.03
	-5.0	-5.6	70.7	20.88	70.7	20.72	70.3	20.53	70.3	20.32	70.3	20.13	60.4	19.88
	-3.0	-3.7	78.1	20.88	78.1	20.66	75.1	20.44	72.6	20.19	70.3	20.00	63.8	19.74
	0.0	-0.7	79.0	20.89	78.1	20.56	75.1	20.29	72.6	20.00	70.3	19.81	65.3	19.53
	3.0	2.2	79.0	20.90	78.1	20.46	75.1	20.14	72.6	19.81	70.3	19.62	65.3	19.31
	5.0	4.1	79.0	20.90	78.1	20.40	75.1	20.04	72.6	19.68	70.3	19.50	65.3	19.17
	7.0	6	79.0	20.90	78.1	20.34	75.1	19.94	72.6	19.55	70.3	19.37	65.3	19.02
	9.0	7.9	79.0	21.01	78.1	20.44	75.1	20.03	72.6	19.65	70.3	19.47	65.3	19.12
	11.0	9.8	79.0	21.31	78.1	20.74	75.1	20.33	72.6	19.94	70.3	19.75	65.3	19.40
13.0	11.8	79.0	21.62	78.1	21.03	75.1	20.62	72.6	20.22	70.3	20.03	65.3	19.68	
15.0	13.7	79.0	21.92	78.1	21.32	75.1	20.90	72.6	20.50	70.3	20.31	65.3	19.95	
110	-19.8	-20	35.2	16.81	35.2	17.63	35.0	18.40	35.0	19.62	35.0	20.47	35.0	20.87
	-18.8	-19	36.9	17.22	36.9	18.03	36.7	18.80	36.7	20.02	36.7	20.87	36.7	20.76
	-16.7	-17	40.5	18.07	40.5	18.88	40.2	19.66	40.2	20.87	40.2	20.67	40.2	20.52
	-13.7	-15	45.6	19.29	45.6	20.10	45.3	20.87	45.3	20.58	45.3	20.37	45.3	20.17
	-11.8	-13	48.2	20.06	48.2	20.87	47.9	20.69	47.9	20.40	47.9	20.19	47.9	19.95
	-9.8	-11	50.9	20.87	50.9	20.68	50.6	20.49	50.6	20.21	50.6	19.99	50.6	19.72
	-9.5	-10	52.1	20.85	52.1	20.65	51.8	20.46	51.8	20.18	51.8	19.96	51.8	19.69
	-8.5	-9.1	56.2	20.75	56.2	20.55	55.8	20.36	55.8	20.08	54.4	19.87	54.4	19.57
	-7.0	-7.6	62.2	20.61	62.2	20.40	61.9	20.21	61.9	19.94	57.1	19.72	57.1	19.40
	-5.0	-5.6	67.8	20.43	67.8	20.21	67.4	20.01	65.2	19.74	59.8	19.52	58.8	19.17
	-3.0	-3.7	71.8	20.24	71.8	20.01	67.4	19.81	65.2	19.55	63.0	19.33	58.8	18.93
	0.0	-0.7	75.9	19.97	71.8	19.72	67.4	19.51	65.2	19.26	63.0	19.03	58.8	18.59
	3.0	2.2	75.9	19.69	71.8	19.42	67.4	19.21	65.2	18.97	63.0	18.74	58.8	18.24
	5.0	4.1	75.9	19.50	71.8	19.22	67.4	19.01	65.2	18.78	63.0	18.54	58.8	18.01
	7.0	6	75.9	19.32	71.8	19.03	67.4	18.81	65.2	18.59	63.0	18.35	58.8	17.78
	9.0	7.9	75.9	19.31	71.8	19.02	67.4	18.80	65.2	18.57	63.0	18.34	58.8	17.77
	11.0	9.8	75.9	19.48	71.8	19.18	67.4	18.97	65.2	18.74	63.0	18.50	58.8	17.93
13.0	11.8	75.9	19.64	71.8	19.35	67.4	19.13	65.2	18.90	63.0	18.65	58.8	18.08	
15.0	13.7	75.9	19.80	71.8	19.50	67.4	19.28	65.2	19.05	63.0	18.80	58.8	18.22	

Note

1. TC: Total Capacity(kW), PI : Power Input(kW, Comp. + Outdoor fan motor)
2. Capacity tables show the average value of conditions which may occur.
3. In the range beyond the operation limit of the outdoor unit, continuous operation and performance can not be guaranteed. When selecting the outdoor units, avoid the air temperature range that is not guaranteed continuous operation.

7. Capacity Tables

Combination (%)		Heating Capacity (22HP)												
		Outdoor air temp.		Indoor air temp. °C DB										
		°C DB	°C WB	16		18		20		21		22		24
		TC	PI	TC	PI	TC	PI	TC	PI	TC	PI	TC	PI	
100	-19.8	-20	35.1	17.51	35.1	18.18	34.8	18.75	34.8	19.83	34.8	20.59	34.8	20.87
	-18.8	-19	36.8	17.84	36.5	18.52	36.5	19.16	36.5	20.17	36.5	20.87	36.5	20.68
	-16.7	-17	40.1	18.55	40.1	19.22	40.1	20.01	39.8	20.87	39.8	20.50	39.8	20.27
	-13.7	-15	45.4	19.56	45.4	20.23	45.2	20.87	45.2	20.39	45.2	19.97	45.2	19.69
	-11.8	-13	48.0	20.20	47.7	20.87	47.7	20.59	47.7	20.08	47.7	19.63	47.7	19.32
	-9.8	-11	50.6	20.87	50.6	20.58	50.4	20.30	50.4	19.75	50.4	19.28	50.4	18.93
	-9.5	-10	51.8	20.84	51.8	20.54	51.6	20.25	51.6	19.71	51.6	19.22	51.6	18.87
	-8.5	-9.1	55.9	20.71	55.9	20.39	55.6	20.10	59.6	19.54	57.7	19.05	53.7	18.68
	-7.0	-7.6	63.0	20.51	62.7	20.17	61.6	19.88	59.6	19.30	57.7	18.78	53.7	18.39
	-5.0	-5.6	65.7	20.25	65.0	19.88	61.6	19.58	59.6	18.98	57.7	18.42	53.7	18.00
	-3.0	-3.7	67.6	20.00	65.5	19.58	61.6	19.29	59.6	18.65	57.7	18.07	53.7	17.61
	0.0	-0.7	69.5	19.61	65.5	19.14	61.6	18.84	59.6	18.16	57.7	17.54	53.7	17.03
	3.0	2.2	69.5	19.22	65.5	18.70	61.6	18.39	59.6	17.68	57.7	17.00	53.7	16.45
	5.0	4.1	69.5	18.96	65.5	18.41	61.6	18.10	59.6	17.35	57.7	16.65	53.7	16.06
	7.0	6	69.5	18.70	65.5	18.11	61.6	17.80	59.6	17.03	57.7	16.29	53.7	15.67
	9.0	7.9	69.5	18.44	65.5	17.86	61.6	17.55	59.6	16.79	57.7	16.07	53.7	15.45
	11.0	9.8	69.5	18.35	65.5	17.78	61.6	17.47	59.6	16.71	57.7	15.99	53.7	15.38
	13.0	11.8	69.5	18.25	65.5	17.67	61.6	17.37	59.6	16.61	57.7	15.90	53.7	15.29
15.0	13.7	69.5	18.12	65.5	17.55	61.6	17.25	59.6	16.50	57.7	15.79	53.7	15.18	
90	-19.8	-20	34.9	16.49	34.9	17.71	34.7	18.56	34.7	18.97	34.7	18.70	34.7	18.23
	-18.8	-19	36.8	16.90	36.5	18.12	36.4	18.97	36.4	18.84	36.4	18.57	36.4	18.08
	-16.7	-17	40.1	17.75	40.1	18.97	39.9	18.74	39.9	18.58	39.9	18.29	39.9	17.77
	-13.7	-15	45.4	18.97	45.4	18.67	45.0	18.41	45.0	18.20	45.0	17.88	45.0	17.32
	-11.8	-13	48.0	18.80	47.7	18.47	47.5	18.20	47.5	17.96	47.5	17.63	47.5	17.04
	-9.8	-11	50.6	18.62	50.6	18.27	50.2	17.98	50.2	17.70	50.2	17.36	46.1	16.74
	-9.5	-10	51.8	18.59	51.8	18.24	51.4	17.94	51.4	17.66	51.4	17.32	47.2	16.70
	-8.5	-9.1	55.9	18.50	55.5	18.14	55.4	17.83	54.6	17.54	52.9	17.19	49.1	16.55
	-7.0	-7.6	63.0	18.36	59.9	17.99	56.4	17.67	54.6	17.35	52.9	16.99	49.1	16.33
	-5.0	-5.6	63.6	18.18	59.9	17.78	56.4	17.45	54.6	17.09	52.9	16.72	49.1	16.03
	-3.0	-3.7	63.6	18.00	59.9	17.58	56.4	17.23	54.6	16.84	52.9	16.45	49.1	15.73
	0.0	-0.7	63.6	17.73	59.9	17.28	56.4	16.89	54.6	16.46	52.9	16.05	49.1	15.29
	3.0	2.2	63.6	17.45	59.9	16.97	56.4	16.56	54.6	16.08	52.9	15.64	49.1	14.84
	5.0	4.1	63.6	17.27	59.9	16.77	56.4	16.34	54.6	15.82	52.9	15.38	49.1	14.54
	7.0	6	63.6	17.09	59.9	16.57	56.4	16.12	54.6	15.57	52.9	15.11	49.1	14.25
	9.0	7.9	63.6	16.86	59.9	16.34	56.4	15.90	54.6	15.36	52.9	14.90	49.1	14.05
	11.0	9.8	63.6	16.62	59.9	16.11	56.4	15.68	54.6	15.14	52.9	14.69	49.1	13.86
	13.0	11.8	63.6	16.39	59.9	15.88	56.4	15.46	54.6	14.93	52.9	14.49	49.1	13.66
15.0	13.7	63.6	16.15	59.9	15.66	56.4	15.24	54.6	14.72	52.9	14.28	49.1	13.47	
80	-19.8	-20	34.6	14.35	34.6	15.56	34.6	16.82	34.6	16.57	34.6	16.18	34.6	15.76
	-18.8	-19	36.2	14.75	36.2	16.82	36.2	16.71	36.2	16.44	36.2	16.05	36.2	15.62
	-16.7	-17	39.9	16.82	39.9	16.60	39.9	16.46	39.9	16.17	39.9	15.78	39.9	15.34
	-13.7	-15	47.0	16.54	46.1	16.29	45.0	16.12	45.0	15.79	45.0	15.39	43.9	14.94
	-11.8	-13	50.9	16.35	49.4	16.09	47.5	15.89	47.5	15.55	47.1	15.14	43.9	14.68
	-9.8	-11	52.5	16.16	50.9	15.88	50.2	15.66	48.9	15.29	47.1	14.88	43.9	14.41
	-9.5	-10	52.8	16.13	51.2	15.85	50.4	15.63	48.9	15.25	47.1	14.85	43.9	14.37
	-8.5	-9.1	54.8	16.04	53.7	15.75	50.4	15.51	48.9	15.12	47.1	14.72	43.9	14.23
	-7.0	-7.6	57.0	15.89	53.7	15.59	50.4	15.34	48.9	14.93	47.1	14.52	43.9	14.03
	-5.0	-5.6	57.0	15.70	53.7	15.38	50.4	15.11	48.9	14.68	47.1	14.26	43.9	13.76
	-3.0	-3.7	57.0	15.51	53.7	15.18	50.4	14.88	48.9	14.42	47.1	14.01	43.9	13.49
	0.0	-0.7	57.0	15.23	53.7	14.86	50.4	14.53	48.9	14.04	47.1	13.62	43.9	13.09
	3.0	2.2	57.0	14.94	53.7	14.55	50.4	14.18	48.9	13.66	47.1	13.23	43.9	12.68
	5.0	4.1	57.0	14.75	53.7	14.34	50.4	13.95	48.9	13.40	47.1	12.97	43.9	12.41
	7.0	6	57.0	14.56	53.7	14.13	50.4	13.72	48.9	13.15	47.1	12.71	43.9	12.14
	9.0	7.9	57.0	13.67	53.7	13.27	50.4	12.88	48.9	12.34	47.1	11.94	43.9	11.40
	11.0	9.8	57.0	12.69	53.7	12.32	50.4	11.95	48.9	11.46	47.1	11.08	43.9	10.58
	13.0	11.8	57.0	11.84	53.7	11.50	50.4	11.16	48.9	10.69	47.1	10.34	43.9	9.88
15.0	13.7	57.0	11.15	53.7	10.82	50.4	10.50	48.9	10.07	47.1	9.74	43.9	9.30	

Note

1. TC: Total Capacity(kW), PI: Power Input(kW, Comp. + Outdoor fan motor)
2. Capacity tables show the average value of conditions which may occur.
3. In the range beyond the operation limit of the outdoor unit, continuous operation and performance can not be guaranteed. When selecting the outdoor units, avoid the air temperature range that is not guaranteed continuous operation.

7. Capacity Tables

Combination (%)		Heating Capacity (22HP)												
		Outdoor air temp.		Indoor air temp. °C DB										
		°C DB	°C WB	16		18		20		21		22		24
		TC	PI	TC	PI	TC	PI	TC	PI	TC	PI	TC	PI	
70	-19.8	-20	34.6	15.20	34.6	15.60	34.6	15.34	34.6	14.92	34.6	14.51	34.6	14.07
	-18.8	-19	36.2	15.60	36.2	15.48	36.2	15.20	36.2	14.78	36.2	14.38	36.2	13.93
	-16.7	-17	39.9	15.37	39.9	15.21	39.9	14.92	39.9	14.49	39.9	14.09	37.5	13.63
	-13.7	-15	48.3	15.02	45.6	14.82	42.9	14.52	41.4	14.08	40.2	13.69	37.5	13.20
	-11.8	-13	48.3	14.81	45.6	14.58	42.9	14.27	41.4	13.81	40.2	13.43	37.5	12.93
	-9.8	-11	48.3	14.58	45.6	14.32	42.9	14.00	41.4	13.54	40.2	13.16	37.5	12.64
	-9.5	-10	48.3	14.55	45.6	14.28	42.9	13.96	41.4	13.50	40.2	13.12	37.5	12.60
	-8.5	-9.1	48.3	14.43	45.6	14.15	42.9	13.83	41.4	13.36	40.2	12.99	37.5	12.45
	-7.0	-7.6	48.3	14.26	45.6	13.96	42.9	13.63	41.4	13.15	40.2	12.78	37.5	12.24
	-5.0	-5.6	48.3	14.04	45.6	13.71	42.9	13.36	41.4	12.88	40.2	12.51	37.5	11.95
	-3.0	-3.7	48.3	13.81	45.6	13.45	42.9	13.09	41.4	12.60	40.2	12.24	37.5	11.67
	0.0	-0.7	48.3	13.47	45.6	13.06	42.9	12.69	41.4	12.19	40.2	11.84	37.5	11.24
	3.0	2.2	48.3	13.13	45.6	12.68	42.9	12.29	41.4	11.78	40.2	11.43	37.5	10.81
	5.0	4.1	48.3	12.90	45.6	12.42	42.9	12.03	41.4	11.50	40.2	11.16	37.5	10.52
	7.0	6	48.3	12.68	45.6	12.17	42.9	11.76	41.4	11.23	40.2	10.89	37.5	10.24
	9.0	7.9	48.3	11.45	45.6	10.99	42.9	10.62	41.4	10.14	40.2	9.83	37.5	9.24
	11.0	9.8	48.3	10.66	45.6	10.23	42.9	9.89	41.4	9.44	40.2	9.15	37.5	8.61
13.0	11.8	48.3	9.97	45.6	9.57	42.9	9.25	41.4	8.83	40.2	8.57	37.5	8.05	
15.0	13.7	48.3	9.40	45.6	9.02	42.9	8.72	41.4	8.33	40.2	8.08	37.5	7.59	
60	-19.8	-20	41.4	14.39	39.2	14.12	34.6	13.70	34.6	13.30	34.3	12.89	32.1	12.45
	-18.8	-19	41.4	14.27	39.2	13.98	36.2	13.57	35.6	13.16	34.3	12.75	32.1	12.30
	-16.7	-17	41.4	14.02	39.2	13.70	36.8	13.28	35.6	12.87	34.3	12.47	32.1	12.00
	-13.7	-15	41.4	13.67	39.2	13.30	36.8	12.87	35.6	12.47	34.3	12.06	32.1	11.57
	-11.8	-13	41.4	13.45	39.2	13.05	36.8	12.61	35.6	12.21	34.3	11.81	32.1	11.30
	-9.8	-11	41.4	13.21	39.2	12.78	36.8	12.34	35.6	11.94	34.3	11.53	32.1	11.01
	-9.5	-10	41.4	13.18	39.2	12.74	36.8	12.30	35.6	11.89	34.3	11.49	32.1	10.97
	-8.5	-9.1	41.4	13.06	39.2	12.61	36.8	12.16	35.6	11.76	34.3	11.36	32.1	10.83
	-7.0	-7.6	41.4	12.89	39.2	12.41	36.8	11.95	35.6	11.55	34.3	11.16	32.1	10.61
	-5.0	-5.6	41.4	12.65	39.2	12.14	36.8	11.68	35.6	11.28	34.3	10.88	32.1	10.33
	-3.0	-3.7	41.4	12.42	39.2	11.87	36.8	11.41	35.6	11.01	34.3	10.61	32.1	10.04
	0.0	-0.7	41.4	12.07	39.2	11.47	36.8	11.00	35.6	10.60	34.3	10.21	32.1	9.61
	3.0	2.2	41.4	11.71	39.2	11.07	36.8	10.59	35.6	10.19	34.3	9.80	32.1	9.18
	5.0	4.1	41.4	11.48	39.2	10.80	36.8	10.31	35.6	9.92	34.3	9.53	32.1	8.89
	7.0	6	41.4	11.24	39.2	10.53	36.8	10.04	35.6	9.65	34.3	9.26	32.1	8.61
	9.0	7.9	41.4	10.03	39.2	9.40	36.8	8.96	35.6	8.61	34.3	8.26	32.1	7.68
	11.0	9.8	41.4	9.37	39.2	8.78	36.8	8.37	35.6	8.04	34.3	7.71	32.1	7.17
13.0	11.8	41.4	8.78	39.2	8.22	36.8	7.84	35.6	7.53	34.3	7.23	32.1	6.72	
15.0	13.7	41.4	8.29	39.2	7.77	36.8	7.41	35.6	7.12	34.3	6.83	32.1	6.35	
50	-19.8	-20	34.6	12.88	32.6	12.43	30.7	12.01	29.7	11.59	28.7	11.19	26.7	10.76
	-18.8	-19	34.6	12.74	32.6	12.29	30.7	11.87	29.7	11.44	28.7	11.05	26.7	10.62
	-16.7	-17	34.6	12.44	32.6	11.98	30.7	11.57	29.7	11.14	28.7	10.77	26.7	10.33
	-13.7	-15	34.6	12.02	32.6	11.54	30.7	11.14	29.7	10.72	28.7	10.36	26.7	9.91
	-11.8	-13	34.6	11.75	32.6	11.26	30.7	10.87	29.7	10.45	28.7	10.10	26.7	9.65
	-9.8	-11	34.6	11.46	32.6	10.96	30.7	10.58	29.7	10.16	28.7	9.82	26.7	9.37
	-9.5	-10	34.6	11.42	32.6	10.92	30.7	10.54	29.7	10.12	28.7	9.78	26.7	9.33
	-8.5	-9.1	34.6	11.28	32.6	10.77	30.7	10.40	29.7	9.98	28.7	9.65	26.7	9.19
	-7.0	-7.6	34.6	11.06	32.6	10.55	30.7	10.18	29.7	9.76	28.7	9.44	26.7	8.98
	-5.0	-5.6	34.6	10.78	32.6	10.26	30.7	9.90	29.7	9.48	28.7	9.17	26.7	8.70
	-3.0	-3.7	34.6	10.49	32.6	9.96	30.7	9.61	29.7	9.19	28.7	8.90	26.7	8.42
	0.0	-0.7	34.6	10.07	32.6	9.52	30.7	9.18	29.7	8.77	28.7	8.49	26.7	8.00
	3.0	2.2	34.6	9.64	32.6	9.08	30.7	8.75	29.7	8.34	28.7	8.08	26.7	7.58
	5.0	4.1	34.6	9.35	32.6	8.79	30.7	8.47	29.7	8.06	28.7	7.80	26.7	7.30
	7.0	6	34.6	9.07	32.6	8.49	30.7	8.18	29.7	7.77	28.7	7.53	26.7	7.03
	9.0	7.9	34.6	8.19	32.6	7.67	30.7	7.39	29.7	7.02	28.7	6.80	26.7	6.34
	11.0	9.8	34.6	7.66	32.6	7.18	30.7	6.91	29.7	6.57	28.7	6.36	26.7	5.94
13.0	11.8	34.6	7.20	32.6	6.74	30.7	6.49	29.7	6.17	28.7	5.97	26.7	5.57	
15.0	13.7	34.6	6.81	32.6	6.38	30.7	6.14	29.7	5.83	28.7	5.65	26.7	5.27	

Note

1. TC: Total Capacity(kW), PI: Power Input(kW, Comp. + Outdoor fan motor)
2. Capacity tables show the average value of conditions which may occur.
3. In the range beyond the operation limit of the outdoor unit, continuous operation and performance can not be guaranteed. When selecting the outdoor units, avoid the air temperature range that is not guaranteed continuous operation.

7. Capacity Tables

◆ A(C)RUN240LLS5

Combination (%)	Outdoor air temp.		Indoor air temp. °C DB											
	°C DB	°C WB	16		18		20		21		22		24	
			TC	PI	TC	PI	TC	PI	TC	PI	TC	PI	TC	PI
130	-19.8	-20	38.9	15.77	38.9	16.38	38.6	16.91	38.6	17.73	38.6	18.51	38.6	19.73
	-18.8	-19	40.7	16.18	40.7	16.79	40.5	17.32	40.5	18.14	40.5	18.91	40.5	20.14
	-16.7	-17	44.7	17.04	44.7	17.65	44.4	18.18	44.4	19.00	44.4	19.77	44.4	20.99
	-13.7	-15	50.4	18.26	50.4	18.87	50.1	19.40	50.1	20.22	50.1	20.99	50.1	20.76
	-11.8	-13	53.2	19.04	53.2	19.65	52.9	20.18	52.9	20.99	52.9	20.88	52.9	20.61
	-9.8	-11	56.2	19.85	56.2	20.46	55.8	20.99	55.8	20.92	55.8	20.76	55.8	20.45
	-9.5	-10	57.5	19.97	57.5	20.59	57.1	20.99	57.1	20.91	56.2	20.74	56.2	20.43
	-8.5	-9.1	62.0	20.38	62.0	20.99	61.6	20.99	61.6	20.88	57.7	20.68	57.7	20.35
	-7.0	-7.6	68.8	20.99	68.8	21.05	68.3	20.99	68.3	20.83	68.3	20.58	62.7	20.23
	-5.0	-5.6	77.8	21.18	77.8	21.12	77.3	20.98	77.3	20.76	77.3	20.46	66.5	20.08
	-3.0	-3.7	86.8	21.36	86.8	21.20	86.2	20.97	84.4	20.68	81.5	20.34	70.3	19.92
	0.0	-0.7	86.9	21.64	86.9	21.31	86.6	20.96	84.4	20.58	81.5	20.16	75.9	19.69
	3.0	2.2	86.9	21.92	86.9	21.42	86.6	20.96	84.4	20.47	81.5	19.97	75.9	19.45
	5.0	4.1	86.9	22.10	86.9	21.50	86.6	20.95	84.4	20.40	81.5	19.85	75.9	19.29
	7.0	6	86.9	22.29	86.9	21.57	86.6	20.94	84.4	20.33	81.5	19.73	75.9	19.14
	9.0	7.9	86.9	22.50	86.9	21.78	86.6	21.15	84.4	20.53	81.5	19.92	75.9	19.32
	11.0	9.8	86.9	22.94	86.9	22.20	86.6	21.56	84.4	20.93	81.5	20.31	75.9	19.70
13.0	11.8	86.9	23.38	86.9	22.63	86.6	21.97	84.4	21.33	81.5	20.70	75.9	20.08	
15.0	13.7	86.9	23.82	86.9	23.05	86.6	22.38	84.4	21.73	81.5	21.09	75.9	20.45	
120	-19.8	-20	38.6	16.38	38.6	16.91	38.3	17.73	38.3	18.51	38.3	19.73	38.3	20.59
	-18.8	-19	40.5	16.79	40.5	17.32	40.2	18.14	40.2	18.91	40.2	20.14	40.2	20.99
	-16.7	-17	44.4	17.65	44.4	18.18	44.1	19.00	44.1	19.77	44.1	20.99	44.1	20.84
	-13.7	-15	50.1	18.87	50.1	19.40	49.7	20.22	49.7	20.99	49.7	20.80	49.7	20.63
	-11.8	-13	52.8	19.65	52.8	20.18	52.5	20.99	52.5	20.87	52.5	20.68	52.5	20.49
	-9.8	-11	55.8	20.46	55.8	20.99	55.4	20.89	55.4	20.74	55.4	20.55	55.4	20.34
	-9.5	-10	57.1	20.59	57.1	20.98	56.7	20.88	56.7	20.72	56.7	20.53	56.7	20.32
	-8.5	-9.1	61.6	20.99	61.6	20.95	61.2	20.83	61.2	20.66	59.5	20.47	59.5	20.25
	-7.0	-7.6	68.3	21.00	68.3	20.90	67.8	20.75	67.8	20.56	62.3	20.37	62.3	20.14
	-5.0	-5.6	77.2	21.00	77.2	20.84	76.7	20.65	76.7	20.44	76.7	20.25	66.0	20.00
	-3.0	-3.7	85.2	21.00	85.2	20.77	81.9	20.55	79.2	20.31	76.7	20.12	69.8	19.85
	0.0	-0.7	86.2	21.01	85.2	20.68	81.9	20.40	79.2	20.11	76.7	19.93	71.2	19.64
	3.0	2.2	86.2	21.01	85.2	20.58	81.9	20.25	79.2	19.92	76.7	19.73	71.2	19.42
	5.0	4.1	86.2	21.02	85.2	20.52	81.9	20.15	79.2	19.79	76.7	19.61	71.2	19.28
	7.0	6	86.2	21.02	85.2	20.45	81.9	20.05	79.2	19.66	76.7	19.48	71.2	19.13
	9.0	7.9	86.2	21.12	85.2	20.55	81.9	20.15	79.2	19.76	76.7	19.57	71.2	19.23
	11.0	9.8	86.2	21.43	85.2	20.85	81.9	20.44	79.2	20.05	76.7	19.86	71.2	19.51
13.0	11.8	86.2	21.74	85.2	21.15	81.9	20.73	79.2	20.34	76.7	20.14	71.2	19.78	
15.0	13.7	86.2	22.04	85.2	21.44	81.9	21.02	79.2	20.62	76.7	20.42	71.2	20.06	
110	-19.8	-20	38.4	16.91	38.4	17.73	38.1	18.51	38.1	19.73	38.1	20.59	38.1	20.99
	-18.8	-19	40.2	17.32	40.2	18.14	40.0	18.91	40.0	20.14	40.0	20.99	40.0	20.88
	-16.7	-17	44.2	18.18	44.2	19.00	43.9	19.77	43.9	20.99	43.9	20.79	43.9	20.63
	-13.7	-15	49.8	19.40	49.8	20.22	49.5	20.99	49.5	20.70	49.5	20.49	49.5	20.29
	-11.8	-13	52.5	20.18	52.5	20.99	52.2	20.80	52.2	20.52	52.2	20.30	52.2	20.06
	-9.8	-11	55.5	20.99	55.5	20.80	55.1	20.60	55.1	20.32	55.1	20.11	55.1	19.83
	-9.5	-10	56.8	20.97	56.8	20.77	56.4	20.57	56.4	20.29	56.4	20.08	56.4	19.80
	-8.5	-9.1	61.2	20.87	61.2	20.67	60.8	20.47	60.8	20.20	59.2	19.98	59.2	19.68
	-7.0	-7.6	67.9	20.73	67.9	20.52	67.5	20.32	67.5	20.05	62.0	19.83	62.0	19.51
	-5.0	-5.6	73.9	20.55	73.9	20.32	73.5	20.12	71.1	19.86	64.9	19.63	64.1	19.27
	-3.0	-3.7	78.3	20.36	78.3	20.12	73.5	19.92	71.1	19.66	68.7	19.44	64.1	19.04
	0.0	-0.7	82.8	20.08	78.3	19.83	73.5	19.62	71.1	19.37	68.7	19.14	64.1	18.69
	3.0	2.2	82.8	19.80	78.3	19.53	73.5	19.32	71.1	19.08	68.7	18.84	64.1	18.35
	5.0	4.1	82.8	19.61	78.3	19.33	73.5	19.12	71.1	18.88	68.7	18.65	64.1	18.11
	7.0	6	82.8	19.43	78.3	19.14	73.5	18.92	71.1	18.69	68.7	18.45	64.1	17.88
	9.0	7.9	82.8	19.41	78.3	19.12	73.5	18.91	71.1	18.68	68.7	18.44	64.1	17.87
	11.0	9.8	82.8	19.59	78.3	19.29	73.5	19.08	71.1	18.84	68.7	18.60	64.1	18.03
13.0	11.8	82.8	19.75	78.3	19.45	73.5	19.24	71.1	19.00	68.7	18.76	64.1	18.18	
15.0	13.7	82.8	19.91	78.3	19.61	73.5	19.39	71.1	19.15	68.7	18.91	64.1	18.32	

Note

1. TC: Total Capacity(kW), PI : Power Input(kW, Comp. + Outdoor fan motor)
2. Capacity tables show the average value of conditions which may occur.
3. In the range beyond the operation limit of the outdoor unit, continuous operation and performance can not be guaranteed. When selecting the outdoor units, avoid the air temperature range that is not guaranteed continuous operation.

7. Capacity Tables

Combination (%)		Heating Capacity (24HP)												
		Outdoor air temp.		Indoor air temp. °C DB										
		°C DB	°C WB	16		18		20		21		22		24
		TC	PI	TC	PI	TC	PI	TC	PI	TC	PI	TC	PI	
100	-19.8	-20	38.2	17.61	38.2	18.29	38.0	18.86	38.0	19.95	38.0	20.70	38.0	20.99
	-18.8	-19	40.1	17.95	39.8	18.63	39.8	19.27	39.8	20.28	39.8	20.99	39.8	20.80
	-16.7	-17	43.7	18.66	43.7	19.34	43.7	20.13	43.5	20.99	43.5	20.62	43.5	20.39
	-13.7	-15	49.5	19.68	49.5	20.35	49.3	20.99	49.3	20.50	49.3	20.08	49.3	19.80
	-11.8	-13	52.3	20.32	52.0	20.99	52.0	20.71	52.0	20.19	52.0	19.74	52.0	19.43
	-9.8	-11	55.2	20.99	55.2	20.70	54.9	20.41	54.9	19.87	54.9	19.39	54.9	19.04
	-9.5	-10	56.5	20.96	56.5	20.65	56.2	20.37	56.2	19.82	56.2	19.33	56.2	18.98
	-8.5	-9.1	60.9	20.82	60.9	20.51	60.6	20.22	65.0	19.66	62.9	19.15	58.6	18.79
	-7.0	-7.6	68.7	20.63	68.4	20.29	67.2	19.99	65.0	19.41	62.9	18.89	58.6	18.49
	-5.0	-5.6	71.7	20.37	70.9	19.99	67.2	19.69	65.0	19.08	62.9	18.53	58.6	18.10
	-3.0	-3.7	73.7	20.11	71.5	19.69	67.2	19.39	65.0	18.76	62.9	18.17	58.6	17.71
	0.0	-0.7	75.8	19.72	71.5	19.25	67.2	18.95	65.0	18.27	62.9	17.64	58.6	17.13
	3.0	2.2	75.8	19.33	71.5	18.81	67.2	18.50	65.0	17.78	62.9	17.10	58.6	16.54
	5.0	4.1	75.8	19.07	71.5	18.51	67.2	18.20	65.0	17.45	62.9	16.74	58.6	16.15
	7.0	6	75.8	18.81	71.5	18.22	67.2	17.90	65.0	17.12	62.9	16.38	58.6	15.76
	9.0	7.9	75.8	18.55	71.5	17.96	67.2	17.65	65.0	16.89	62.9	16.16	58.6	15.54
	11.0	9.8	75.8	18.46	71.5	17.88	67.2	17.57	65.0	16.81	62.9	16.08	58.6	15.46
13.0	11.8	75.8	18.35	71.5	17.77	67.2	17.46	65.0	16.71	62.9	15.99	58.6	15.37	
15.0	13.7	75.8	18.22	71.5	17.65	67.2	17.35	65.0	16.59	62.9	15.88	58.6	15.27	
90	-19.8	-20	38.1	16.59	38.1	17.82	37.8	18.67	37.8	19.08	37.8	18.81	37.8	18.33
	-18.8	-19	40.1	17.00	39.8	18.22	39.7	19.08	39.7	18.95	39.7	18.68	39.7	18.18
	-16.7	-17	43.7	17.86	43.7	19.08	43.5	18.85	43.5	18.69	43.5	18.39	43.5	17.87
	-13.7	-15	49.5	19.08	49.5	18.77	49.1	18.51	49.1	18.30	49.1	17.99	49.1	17.42
	-11.8	-13	52.3	18.91	52.0	18.58	51.8	18.30	51.8	18.06	51.8	17.73	51.8	17.14
	-9.8	-11	55.2	18.72	55.2	18.38	54.7	18.08	54.7	17.80	54.7	17.46	50.2	16.84
	-9.5	-10	56.5	18.70	56.5	18.35	56.0	18.05	56.0	17.77	56.0	17.42	51.4	16.79
	-8.5	-9.1	60.9	18.61	60.5	18.24	60.4	17.94	59.6	17.64	57.7	17.29	53.6	16.64
	-7.0	-7.6	68.7	18.47	65.3	18.09	61.5	17.77	59.6	17.45	57.7	17.08	53.6	16.42
	-5.0	-5.6	69.4	18.29	65.3	17.89	61.5	17.55	59.6	17.19	57.7	16.81	53.6	16.12
	-3.0	-3.7	69.4	18.10	65.3	17.68	61.5	17.32	59.6	16.94	57.7	16.54	53.6	15.82
	0.0	-0.7	69.4	17.83	65.3	17.37	61.5	16.99	59.6	16.55	57.7	16.14	53.6	15.37
	3.0	2.2	69.4	17.55	65.3	17.07	61.5	16.66	59.6	16.17	57.7	15.73	53.6	14.92
	5.0	4.1	69.4	17.37	65.3	16.86	61.5	16.43	59.6	15.91	57.7	15.46	53.6	14.63
	7.0	6	69.4	17.19	65.3	16.66	61.5	16.21	59.6	15.66	57.7	15.19	53.6	14.33
	9.0	7.9	69.4	16.95	65.3	16.43	61.5	15.99	59.6	15.44	57.7	14.98	53.6	14.13
	11.0	9.8	69.4	16.72	65.3	16.20	61.5	15.77	59.6	15.23	57.7	14.78	53.6	13.93
13.0	11.8	69.4	16.48	65.3	15.97	61.5	15.54	59.6	15.01	57.7	14.57	53.6	13.74	
15.0	13.7	69.4	16.24	65.3	15.74	61.5	15.32	59.6	14.80	57.7	14.36	53.6	13.54	
80	-19.8	-20	37.7	14.43	37.7	15.65	37.7	16.92	37.7	16.66	37.7	16.27	37.7	15.85
	-18.8	-19	39.5	14.84	39.5	16.92	39.5	16.80	39.5	16.53	39.5	16.14	39.5	15.71
	-16.7	-17	43.5	16.92	43.5	16.70	43.5	16.56	43.5	16.26	43.5	15.87	43.5	15.43
	-13.7	-15	51.3	16.63	50.3	16.38	49.1	16.21	49.1	15.88	49.1	15.48	47.9	15.02
	-11.8	-13	55.5	16.45	53.9	16.19	51.8	15.99	51.8	15.64	51.4	15.23	47.9	14.76
	-9.8	-11	57.1	16.26	55.5	15.98	54.7	15.75	53.4	15.38	51.4	14.97	47.9	14.49
	-9.5	-10	57.6	16.23	55.9	15.94	55.0	15.72	53.4	15.34	51.4	14.93	47.9	14.45
	-8.5	-9.1	59.8	16.13	58.6	15.84	55.0	15.60	53.4	15.21	51.4	14.80	47.9	14.31
	-7.0	-7.6	62.2	15.99	58.6	15.68	55.0	15.43	53.4	15.02	51.4	14.61	47.9	14.11
	-5.0	-5.6	62.2	15.79	58.6	15.47	55.0	15.19	53.4	14.76	51.4	14.35	47.9	13.84
	-3.0	-3.7	62.2	15.60	58.6	15.26	55.0	14.96	53.4	14.50	51.4	14.09	47.9	13.57
	0.0	-0.7	62.2	15.31	58.6	14.95	55.0	14.61	53.4	14.12	51.4	13.70	47.9	13.16
	3.0	2.2	62.2	15.02	58.6	14.63	55.0	14.26	53.4	13.73	51.4	13.31	47.9	12.75
	5.0	4.1	62.2	14.83	58.6	14.42	55.0	14.03	53.4	13.48	51.4	13.05	47.9	12.48
	7.0	6	62.2	14.64	58.6	14.21	55.0	13.79	53.4	13.22	51.4	12.79	47.9	12.21
	9.0	7.9	62.2	13.75	58.6	13.35	55.0	12.95	53.4	12.41	51.4	12.01	47.9	11.46
	11.0	9.8	62.2	12.76	58.6	12.39	55.0	12.02	53.4	11.52	51.4	11.14	47.9	10.64
13.0	11.8	62.2	11.91	58.6	11.56	55.0	11.22	53.4	10.75	51.4	10.40	47.9	9.93	
15.0	13.7	62.2	11.21	58.6	10.88	55.0	10.56	53.4	10.12	51.4	9.79	47.9	9.35	

Note

1. TC: Total Capacity(kW), PI: Power Input(kW, Comp. + Outdoor fan motor)
2. Capacity tables show the average value of conditions which may occur.
3. In the range beyond the operation limit of the outdoor unit, continuous operation and performance can not be guaranteed. When selecting the outdoor units, avoid the air temperature range that is not guaranteed continuous operation.

7. Capacity Tables

Combination (%)		Heating Capacity (24HP)												
		Outdoor air temp.		Indoor air temp. °C DB										
		°C DB	°C WB	16		18		20		21		22		24
		TC	PI	TC	PI	TC	PI	TC	PI	TC	PI	TC	PI	
70	-19.8	-20	37.7	15.29	37.7	15.70	37.7	15.43	37.7	15.00	37.7	14.60	37.7	14.15
	-18.8	-19	39.5	15.70	39.5	15.57	39.5	15.29	39.5	14.86	39.5	14.46	39.5	14.01
	-16.7	-17	43.5	15.46	43.5	15.30	43.5	15.01	43.5	14.57	43.5	14.18	40.9	13.71
	-13.7	-15	52.7	15.11	49.8	14.91	46.8	14.61	45.2	14.16	43.9	13.77	40.9	13.27
	-11.8	-13	52.7	14.90	49.8	14.66	46.8	14.35	45.2	13.89	43.9	13.51	40.9	13.00
	-9.8	-11	52.7	14.67	49.8	14.40	46.8	14.08	45.2	13.62	43.9	13.24	40.9	12.71
	-9.5	-10	52.7	14.63	49.8	14.37	46.8	14.04	45.2	13.58	43.9	13.20	40.9	12.67
	-8.5	-9.1	52.7	14.52	49.8	14.24	46.8	13.91	45.2	13.44	43.9	13.06	40.9	12.53
	-7.0	-7.6	52.7	14.35	49.8	14.04	46.8	13.71	45.2	13.23	43.9	12.86	40.9	12.31
	-5.0	-5.6	52.7	14.12	49.8	13.78	46.8	13.44	45.2	12.95	43.9	12.58	40.9	12.02
	-3.0	-3.7	52.7	13.89	49.8	13.53	46.8	13.17	45.2	12.68	43.9	12.31	40.9	11.73
	0.0	-0.7	52.7	13.55	49.8	13.14	46.8	12.77	45.2	12.26	43.9	11.90	40.9	11.30
	3.0	2.2	52.7	13.20	49.8	12.75	46.8	12.36	45.2	11.84	43.9	11.49	40.9	10.87
	5.0	4.1	52.7	12.98	49.8	12.49	46.8	12.09	45.2	11.57	43.9	11.22	40.9	10.58
	7.0	6	52.7	12.75	49.8	12.24	46.8	11.83	45.2	11.29	43.9	10.95	40.9	10.29
	9.0	7.9	52.7	11.51	49.8	11.05	46.8	10.68	45.2	10.20	43.9	9.89	40.9	9.30
11.0	9.8	52.7	10.72	49.8	10.29	46.8	9.94	45.2	9.49	43.9	9.21	40.9	8.66	
13.0	11.8	52.7	10.03	49.8	9.62	46.8	9.30	45.2	8.88	43.9	8.61	40.9	8.10	
15.0	13.7	52.7	9.45	49.8	9.07	46.8	8.77	45.2	8.37	43.9	8.12	40.9	7.63	
60	-19.8	-20	45.2	14.47	42.8	14.20	37.7	13.78	37.7	13.37	37.5	12.97	35.0	12.52
	-18.8	-19	45.2	14.35	42.8	14.07	39.5	13.65	38.8	13.24	37.5	12.83	35.0	12.37
	-16.7	-17	45.2	14.11	42.8	13.78	40.1	13.36	38.8	12.95	37.5	12.54	35.0	12.07
	-13.7	-15	45.2	13.75	42.8	13.38	40.1	12.95	38.8	12.54	37.5	12.13	35.0	11.64
	-11.8	-13	45.2	13.53	42.8	13.12	40.1	12.68	38.8	12.28	37.5	11.87	35.0	11.37
	-9.8	-11	45.2	13.29	42.8	12.86	40.1	12.41	38.8	12.01	37.5	11.60	35.0	11.08
	-9.5	-10	45.2	13.26	42.8	12.81	40.1	12.37	38.8	11.96	37.5	11.56	35.0	11.03
	-8.5	-9.1	45.2	13.14	42.8	12.68	40.1	12.23	38.8	11.83	37.5	11.42	35.0	10.89
	-7.0	-7.6	45.2	12.96	42.8	12.48	40.1	12.02	38.8	11.62	37.5	11.22	35.0	10.67
	-5.0	-5.6	45.2	12.72	42.8	12.21	40.1	11.75	38.8	11.35	37.5	10.95	35.0	10.39
	-3.0	-3.7	45.2	12.49	42.8	11.94	40.1	11.47	38.8	11.07	37.5	10.67	35.0	10.10
	0.0	-0.7	45.2	12.13	42.8	11.53	40.1	11.06	38.8	10.66	37.5	10.26	35.0	9.67
	3.0	2.2	45.2	11.78	42.8	11.13	40.1	10.65	38.8	10.25	37.5	9.86	35.0	9.23
	5.0	4.1	45.2	11.54	42.8	10.86	40.1	10.37	38.8	9.98	37.5	9.58	35.0	8.94
	7.0	6	45.2	11.31	42.8	10.59	40.1	10.10	38.8	9.70	37.5	9.31	35.0	8.66
	9.0	7.9	45.2	10.09	42.8	9.45	40.1	9.01	38.8	8.66	37.5	8.31	35.0	7.72
11.0	9.8	45.2	9.42	42.8	8.82	40.1	8.41	38.8	8.09	37.5	7.76	35.0	7.21	
13.0	11.8	45.2	8.83	42.8	8.27	40.1	7.88	38.8	7.57	37.5	7.27	35.0	6.76	
15.0	13.7	45.2	8.34	42.8	7.81	40.1	7.45	38.8	7.16	37.5	6.87	35.0	6.39	
50	-19.8	-20	37.7	12.96	35.6	12.51	33.4	12.08	32.4	11.66	31.3	11.25	29.2	10.83
	-18.8	-19	37.7	12.82	35.6	12.36	33.4	11.94	32.4	11.51	31.3	11.12	29.2	10.69
	-16.7	-17	37.7	12.52	35.6	12.05	33.4	11.64	32.4	11.21	31.3	10.83	29.2	10.39
	-13.7	-15	37.7	12.09	35.6	11.60	33.4	11.21	32.4	10.78	31.3	10.42	29.2	9.97
	-11.8	-13	37.7	11.81	35.6	11.32	33.4	10.93	32.4	10.51	31.3	10.16	29.2	9.70
	-9.8	-11	37.7	11.53	35.6	11.03	33.4	10.64	32.4	10.22	31.3	9.88	29.2	9.42
	-9.5	-10	37.7	11.49	35.6	10.98	33.4	10.60	32.4	10.18	31.3	9.84	29.2	9.38
	-8.5	-9.1	37.7	11.34	35.6	10.84	33.4	10.46	32.4	10.04	31.3	9.70	29.2	9.24
	-7.0	-7.6	37.7	11.13	35.6	10.61	33.4	10.24	32.4	9.82	31.3	9.50	29.2	9.03
	-5.0	-5.6	37.7	10.84	35.6	10.32	33.4	9.95	32.4	9.53	31.3	9.22	29.2	8.75
	-3.0	-3.7	37.7	10.55	35.6	10.02	33.4	9.67	32.4	9.25	31.3	8.95	29.2	8.47
	0.0	-0.7	37.7	10.12	35.6	9.58	33.4	9.23	32.4	8.82	31.3	8.53	29.2	8.05
	3.0	2.2	37.7	9.69	35.6	9.13	33.4	8.80	32.4	8.39	31.3	8.12	29.2	7.63
	5.0	4.1	37.7	9.41	35.6	8.84	33.4	8.51	32.4	8.10	31.3	7.85	29.2	7.35
	7.0	6	37.7	9.12	35.6	8.54	33.4	8.23	32.4	7.81	31.3	7.57	29.2	7.06
	9.0	7.9	37.7	8.24	35.6	7.71	33.4	7.43	32.4	7.06	31.3	6.84	29.2	6.38
11.0	9.8	37.7	7.71	35.6	7.22	33.4	6.95	32.4	6.60	31.3	6.40	29.2	5.97	
13.0	11.8	37.7	7.24	35.6	6.78	33.4	6.53	32.4	6.20	31.3	6.01	29.2	5.61	
15.0	13.7	37.7	6.85	35.6	6.41	33.4	6.18	32.4	5.87	31.3	5.68	29.2	5.30	

Note

1. TC: Total Capacity(kW), PI: Power Input(kW, Comp. + Outdoor fan motor)
2. Capacity tables show the average value of conditions which may occur.
3. In the range beyond the operation limit of the outdoor unit, continuous operation and performance can not be guaranteed. When selecting the outdoor units, avoid the air temperature range that is not guaranteed continuous operation.

7. Capacity Tables

◆ A(C)RUN260LLS5

Combination (%)	Outdoor air temp.		Indoor air temp. °C DB											
	°C DB	°C WB	16		18		20		21		22		24	
			TC	PI	TC	PI	TC	PI	TC	PI	TC	PI	TC	PI
130	-19.8	-20	42.2	18.08	42.2	18.77	41.9	19.38	41.9	20.31	41.9	21.20	41.9	22.60
	-18.8	-19	44.2	18.54	44.2	19.24	43.9	19.85	43.9	20.78	43.9	21.66	43.9	23.06
	-16.7	-17	48.5	19.52	48.5	20.22	48.2	20.82	48.2	21.76	48.2	22.64	48.2	24.04
	-13.7	-15	54.6	20.92	54.6	21.62	54.3	22.22	54.3	23.15	54.3	24.04	54.3	23.77
	-11.8	-13	57.7	21.80	57.7	22.50	57.3	23.11	57.3	24.04	57.3	23.91	57.3	23.60
	-9.8	-11	60.9	22.74	60.9	23.43	60.5	24.04	60.5	23.96	60.5	23.77	60.5	23.42
	-9.5	-10	62.4	22.88	62.4	23.57	62.0	24.04	62.0	23.95	61.0	23.75	61.0	23.40
	-8.5	-9.1	67.2	23.34	67.2	24.04	66.8	24.04	66.8	23.91	62.6	23.68	62.6	23.31
	-7.0	-7.6	74.5	24.04	74.5	24.10	74.0	24.03	74.0	23.85	74.0	23.57	67.8	23.17
	-5.0	-5.6	84.2	24.25	84.2	24.19	83.6	24.02	83.6	23.77	83.6	23.43	71.9	22.99
	-3.0	-3.7	93.9	24.46	93.9	24.28	93.3	24.02	91.5	23.69	88.3	23.29	76.0	22.81
	0.0	-0.7	94.1	24.78	94.1	24.40	93.8	24.01	91.5	23.57	88.3	23.08	82.0	22.54
	3.0	2.2	94.1	25.10	94.1	24.53	93.8	24.00	91.5	23.45	88.3	22.87	82.2	22.28
	5.0	4.1	94.1	25.31	94.1	24.62	93.8	23.99	91.5	23.37	88.3	22.73	82.2	22.10
	7.0	6	94.1	25.53	94.1	24.70	93.8	23.99	91.5	23.29	88.3	22.59	82.2	21.92
	9.0	7.9	94.1	25.77	94.1	24.94	93.8	24.22	91.5	23.51	88.3	22.81	82.2	22.13
	11.0	9.8	94.1	26.28	94.1	25.43	93.8	24.69	91.5	23.97	88.3	23.26	82.2	22.56
13.0	11.8	94.1	26.78	94.1	25.92	93.8	25.16	91.5	24.43	88.3	23.70	82.2	22.99	
15.0	13.7	94.1	27.28	94.1	26.40	93.8	25.64	91.5	24.89	88.3	24.15	82.2	23.43	
120	-19.8	-20	41.9	18.77	41.9	19.38	41.6	20.31	41.6	21.20	41.6	22.60	41.6	23.57
	-18.8	-19	43.9	19.24	43.9	19.85	43.6	20.78	43.6	21.66	43.6	23.06	43.6	24.04
	-16.7	-17	48.1	20.22	48.1	20.82	47.8	21.76	47.8	22.64	47.8	24.04	47.8	23.87
	-13.7	-15	54.2	21.62	54.2	22.22	53.9	23.15	53.9	24.04	53.9	23.82	53.9	23.62
	-11.8	-13	57.3	22.50	57.3	23.11	56.9	24.04	56.9	23.90	56.9	23.68	56.9	23.46
	-9.8	-11	60.5	23.43	60.5	24.04	60.1	23.93	60.1	23.75	60.1	23.54	60.1	23.30
	-9.5	-10	61.9	23.57	61.9	24.03	61.6	23.91	61.6	23.73	61.6	23.51	61.6	23.27
	-8.5	-9.1	66.7	24.04	66.7	23.99	66.3	23.85	66.3	23.66	64.3	23.44	64.3	23.19
	-7.0	-7.6	74.0	24.04	74.0	23.94	73.5	23.76	73.5	23.55	67.4	23.33	67.4	23.07
	-5.0	-5.6	83.6	24.05	83.6	23.86	83.1	23.65	83.1	23.40	83.1	23.19	71.4	22.90
	-3.0	-3.7	92.4	24.05	92.4	23.79	88.7	23.53	85.8	23.25	83.1	23.04	75.4	22.74
	0.0	-0.7	93.3	24.06	92.4	23.68	88.7	23.36	85.8	23.03	83.1	22.82	77.2	22.49
	3.0	2.2	93.3	24.06	92.4	23.57	88.7	23.19	85.8	22.81	83.1	22.60	77.2	22.24
	5.0	4.1	93.3	24.07	92.4	23.49	88.7	23.07	85.8	22.67	83.1	22.45	77.2	22.07
	7.0	6	93.3	24.07	92.4	23.42	88.7	22.96	85.8	22.52	83.1	22.31	77.2	21.91
	9.0	7.9	93.3	24.19	92.4	23.54	88.7	23.07	85.8	22.63	83.1	22.42	77.2	22.02
	11.0	9.8	93.3	24.55	92.4	23.88	88.7	23.41	85.8	22.96	83.1	22.75	77.2	22.34
13.0	11.8	93.3	24.90	92.4	24.22	88.7	23.75	85.8	23.29	83.1	23.07	77.2	22.66	
15.0	13.7	93.3	25.24	92.4	24.56	88.7	24.08	85.8	23.61	83.1	23.39	77.2	22.97	
110	-19.8	-20	41.6	19.38	41.6	20.31	41.4	21.20	41.4	22.60	41.4	23.57	41.4	24.04
	-18.8	-19	43.6	19.85	43.6	20.78	43.4	21.66	43.4	23.06	43.4	24.04	43.4	23.91
	-16.7	-17	47.9	20.82	47.9	21.76	47.6	22.64	47.6	24.04	47.6	23.80	47.6	23.63
	-13.7	-15	53.9	22.22	53.9	23.15	53.6	24.04	53.6	23.71	53.6	23.47	53.6	23.23
	-11.8	-13	57.0	23.11	57.0	24.04	56.6	23.82	56.6	23.50	56.6	23.25	56.6	22.98
	-9.8	-11	60.2	24.04	60.2	23.81	59.8	23.59	59.8	23.27	59.8	23.03	59.8	22.71
	-9.5	-10	61.6	24.01	61.6	23.78	61.2	23.56	61.2	23.24	61.2	22.99	61.2	22.67
	-8.5	-9.1	66.4	23.90	66.4	23.67	66.0	23.44	66.0	23.13	64.3	22.88	64.3	22.54
	-7.0	-7.6	73.6	23.74	73.6	23.50	73.1	23.27	73.1	22.96	67.4	22.71	67.4	22.34
	-5.0	-5.6	80.1	23.53	80.1	23.27	79.6	23.04	77.0	22.74	70.6	22.48	69.5	22.07
	-3.0	-3.7	84.8	23.32	84.8	23.05	79.6	22.81	77.0	22.52	74.4	22.26	69.5	21.81
	0.0	-0.7	89.7	23.00	84.8	22.71	79.6	22.47	77.0	22.18	74.4	21.92	69.5	21.41
	3.0	2.2	89.7	22.68	84.8	22.37	79.6	22.13	77.0	21.85	74.4	21.58	69.5	21.01
	5.0	4.1	89.7	22.46	84.8	22.14	79.6	21.90	77.0	21.63	74.4	21.36	69.5	20.74
	7.0	6	89.7	22.25	84.8	21.91	79.6	21.67	77.0	21.41	74.4	21.13	69.5	20.48
	9.0	7.9	89.7	22.23	84.8	21.90	79.6	21.65	77.0	21.39	74.4	21.12	69.5	20.46
	11.0	9.8	89.7	22.43	84.8	22.09	79.6	21.85	77.0	21.58	74.4	21.30	69.5	20.65
13.0	11.8	89.7	22.62	84.8	22.28	79.6	22.03	77.0	21.76	74.4	21.48	69.5	20.82	
15.0	13.7	89.7	22.80	84.8	22.46	79.6	22.20	77.0	21.93	74.4	21.65	69.5	20.98	

Note

1. TC: Total Capacity(kW), PI: Power Input(kW, Comp. + Outdoor fan motor)
2. Capacity tables show the average value of conditions which may occur.
3. In the range beyond the operation limit of the outdoor unit, continuous operation and performance can not be guaranteed. When selecting the outdoor units, avoid the air temperature range that is not guaranteed continuous operation.

7. Capacity Tables

Combination (%)		Heating Capacity (26HP)												
		Outdoor air temp.		Indoor air temp. °C DB										
		°C DB	°C WB	16		18		20		21		22		24
		TC	PI	TC	PI	TC	PI	TC	PI	TC	PI	TC	PI	
100	-19.8	-20	41.5	20.18	41.5	20.95	41.2	21.60	41.2	22.84	41.2	23.71	41.2	24.04
	-18.8	-19	43.5	20.56	43.2	21.33	43.2	22.07	43.2	23.23	43.2	24.04	43.2	23.82
	-16.7	-17	47.4	21.37	47.4	22.15	47.4	23.05	47.1	24.04	47.1	23.61	47.1	23.35
	-13.7	-15	53.7	22.53	53.7	23.31	53.4	24.04	53.4	23.48	53.4	23.00	53.4	22.68
	-11.8	-13	56.7	23.27	56.4	24.04	56.4	23.72	56.4	23.12	56.4	22.61	56.4	22.25
	-9.8	-11	59.8	24.04	59.8	23.70	59.5	23.37	59.5	22.75	59.5	22.20	59.5	21.80
	-9.5	-10	61.3	24.00	61.3	23.65	61.0	23.32	61.0	22.69	61.0	22.14	61.0	21.74
	-8.5	-9.1	66.0	23.85	66.0	23.48	65.7	23.15	70.5	22.51	68.1	21.93	63.5	21.51
	-7.0	-7.6	74.4	23.62	74.1	23.23	72.8	22.89	70.5	22.23	68.1	21.63	63.5	21.18
	-5.0	-5.6	77.6	23.33	76.9	22.89	72.8	22.55	70.5	21.85	68.1	21.22	63.5	20.73
	-3.0	-3.7	79.9	23.03	77.5	22.55	72.8	22.21	70.5	21.48	68.1	20.81	63.5	20.28
	0.0	-0.7	82.1	22.58	77.5	22.05	72.8	21.70	70.5	20.92	68.1	20.20	63.5	19.61
	3.0	2.2	82.1	22.13	77.5	21.54	72.8	21.18	70.5	20.36	68.1	19.58	63.5	18.94
	5.0	4.1	82.1	21.84	77.5	21.20	72.8	20.84	70.5	19.99	68.1	19.17	63.5	18.49
	7.0	6	82.1	21.54	77.5	20.86	72.8	20.50	70.5	19.61	68.1	18.76	63.5	18.05
	9.0	7.9	82.1	21.24	77.5	20.57	72.8	20.22	70.5	19.34	68.1	18.51	63.5	17.80
	11.0	9.8	82.1	21.14	77.5	20.47	72.8	20.12	70.5	19.25	68.1	18.42	63.5	17.71
13.0	11.8	82.1	21.02	77.5	20.36	72.8	20.00	70.5	19.14	68.1	18.31	63.5	17.61	
15.0	13.7	82.1	20.87	77.5	20.22	72.8	19.87	70.5	19.01	68.1	18.18	63.5	17.49	
90	-19.8	-20	41.3	19.01	41.3	20.41	41.0	21.38	41.0	21.85	41.0	21.54	41.0	21.00
	-18.8	-19	43.5	19.47	43.2	20.87	43.0	21.85	43.0	21.70	43.0	21.39	43.0	20.82
	-16.7	-17	47.4	20.45	47.4	21.85	47.2	21.58	47.2	21.40	47.2	21.06	47.2	20.46
	-13.7	-15	53.7	21.85	53.7	21.50	53.1	21.20	53.1	20.96	53.1	20.60	53.1	19.95
	-11.8	-13	56.7	21.65	56.4	21.28	56.1	20.96	56.1	20.68	56.1	20.31	56.1	19.63
	-9.8	-11	59.8	21.44	59.8	21.04	59.3	20.70	59.3	20.39	59.3	20.00	54.4	19.28
	-9.5	-10	61.3	21.41	61.3	21.01	60.7	20.67	60.7	20.34	60.7	19.95	55.7	19.23
	-8.5	-9.1	66.0	21.31	65.6	20.89	65.4	20.54	64.5	20.20	62.5	19.80	58.0	19.06
	-7.0	-7.6	74.4	21.15	70.8	20.72	66.6	20.35	64.5	19.98	62.5	19.56	58.0	18.80
	-5.0	-5.6	75.2	20.94	70.8	20.48	66.6	20.09	64.5	19.69	62.5	19.25	58.0	18.46
	-3.0	-3.7	75.2	20.73	70.8	20.25	66.6	19.84	64.5	19.39	62.5	18.95	58.0	18.12
	0.0	-0.7	75.2	20.42	70.8	19.90	66.6	19.46	64.5	18.96	62.5	18.48	58.0	17.61
	3.0	2.2	75.2	20.10	70.8	19.55	66.6	19.07	64.5	18.52	62.5	18.02	58.0	17.09
	5.0	4.1	75.2	19.89	70.8	19.31	66.6	18.82	64.5	18.22	62.5	17.71	58.0	16.75
	7.0	6	75.2	19.68	70.8	19.08	66.6	18.57	64.5	17.93	62.5	17.40	58.0	16.41
	9.0	7.9	75.2	19.41	70.8	18.82	66.6	18.31	64.5	17.69	62.5	17.16	58.0	16.18
	11.0	9.8	75.2	19.14	70.8	18.55	66.6	18.06	64.5	17.44	62.5	16.92	58.0	15.96
13.0	11.8	75.2	18.87	70.8	18.29	66.6	17.80	64.5	17.19	62.5	16.68	58.0	15.73	
15.0	13.7	75.2	18.60	70.8	18.03	66.6	17.55	64.5	16.95	62.5	16.44	58.0	15.51	
80	-19.8	-20	40.9	16.53	40.9	17.93	40.9	19.38	40.9	19.08	40.9	18.63	40.9	18.15
	-18.8	-19	42.8	17.00	42.8	19.38	42.8	19.24	42.8	18.93	42.8	18.48	42.8	18.00
	-16.7	-17	47.2	19.38	47.2	19.12	47.2	18.96	47.2	18.63	47.2	18.17	47.2	17.67
	-13.7	-15	55.6	19.05	54.5	18.76	53.1	18.56	53.1	18.18	53.1	17.72	51.8	17.20
	-11.8	-13	60.1	18.84	58.4	18.54	56.1	18.31	56.1	17.91	55.7	17.44	51.8	16.91
	-9.8	-11	62.0	18.62	60.2	18.30	59.3	18.04	57.8	17.61	55.7	17.14	51.8	16.60
	-9.5	-10	62.4	18.58	60.6	18.26	59.6	18.00	57.8	17.57	55.7	17.10	51.8	16.55
	-8.5	-9.1	64.7	18.47	63.5	18.14	59.6	17.87	57.8	17.42	55.7	16.95	51.8	16.39
	-7.0	-7.6	67.3	18.31	63.5	17.96	59.6	17.67	57.8	17.20	55.7	16.73	51.8	16.16
	-5.0	-5.6	67.3	18.09	63.5	17.72	59.6	17.40	57.8	16.91	55.7	16.43	51.8	15.85
	-3.0	-3.7	67.3	17.87	63.5	17.48	59.6	17.13	57.8	16.61	55.7	16.13	51.8	15.54
	0.0	-0.7	67.3	17.54	63.5	17.12	59.6	16.73	57.8	16.17	55.7	15.68	51.8	15.07
	3.0	2.2	67.3	17.21	63.5	16.76	59.6	16.33	57.8	15.73	55.7	15.24	51.8	14.60
	5.0	4.1	67.3	16.99	63.5	16.52	59.6	16.07	57.8	15.43	55.7	14.94	51.8	14.29
	7.0	6	67.3	16.77	63.5	16.28	59.6	15.80	57.8	15.14	55.7	14.64	51.8	13.98
	9.0	7.9	67.3	15.74	63.5	15.28	59.6	14.83	57.8	14.22	55.7	13.75	51.8	13.13
	11.0	9.8	67.3	14.61	63.5	14.19	59.6	13.77	57.8	13.19	55.7	12.76	51.8	12.18
13.0	11.8	67.3	13.64	63.5	13.24	59.6	12.85	57.8	12.32	55.7	11.91	51.8	11.37	
15.0	13.7	67.3	12.84	63.5	12.47	59.6	12.10	57.8	11.59	55.7	11.21	51.8	10.71	

Note

1. TC: Total Capacity(kW), PI: Power Input(kW, Comp. + Outdoor fan motor)
2. Capacity tables show the average value of conditions which may occur.
3. In the range beyond the operation limit of the outdoor unit, continuous operation and performance can not be guaranteed. When selecting the outdoor units, avoid the air temperature range that is not guaranteed continuous operation.

7. Capacity Tables

Combination (%)		Heating Capacity (26HP)												
		Outdoor air temp.		Indoor air temp. °C DB										
		°C DB	°C WB	16		18		20		21		22		24
		TC	PI	TC	PI	TC	PI	TC	PI	TC	PI	TC	PI	
70	-19.8	-20	40.9	17.51	40.9	17.98	40.9	17.67	40.9	17.18	40.9	16.72	40.9	16.21
	-18.8	-19	42.8	17.98	42.8	17.83	42.8	17.52	42.8	17.03	42.8	16.57	42.8	16.04
	-16.7	-17	47.2	17.70	47.2	17.52	47.2	17.19	47.2	16.69	47.2	16.24	44.3	15.70
	-13.7	-15	57.1	17.31	53.9	17.08	50.7	16.73	49.0	16.22	47.5	15.77	44.3	15.20
	-11.8	-13	57.1	17.06	53.9	16.79	50.7	16.44	49.0	15.91	47.5	15.47	44.3	14.89
	-9.8	-11	57.1	16.80	53.9	16.50	50.7	16.13	49.0	15.60	47.5	15.16	44.3	14.56
	-9.5	-10	57.1	16.76	53.9	16.45	50.7	16.08	49.0	15.55	47.5	15.11	44.3	14.51
	-8.5	-9.1	57.1	16.63	53.9	16.31	50.7	15.93	49.0	15.39	47.5	14.96	44.3	14.35
	-7.0	-7.6	57.1	16.43	53.9	16.08	50.7	15.70	49.0	15.15	47.5	14.72	44.3	14.10
	-5.0	-5.6	57.1	16.17	53.9	15.79	50.7	15.39	49.0	14.83	47.5	14.41	44.3	13.77
	-3.0	-3.7	57.1	15.91	53.9	15.49	50.7	15.08	49.0	14.52	47.5	14.10	44.3	13.44
	0.0	-0.7	57.1	15.52	53.9	15.05	50.7	14.62	49.0	14.04	47.5	13.63	44.3	12.94
	3.0	2.2	57.1	15.12	53.9	14.60	50.7	14.16	49.0	13.57	47.5	13.16	44.3	12.45
	5.0	4.1	57.1	14.86	53.9	14.31	50.7	13.85	49.0	13.25	47.5	12.85	44.3	12.12
	7.0	6	57.1	14.60	53.9	14.01	50.7	13.54	49.0	12.93	47.5	12.54	44.3	11.79
	9.0	7.9	57.1	13.18	53.9	12.65	50.7	12.23	49.0	11.68	47.5	11.32	44.3	10.65
	11.0	9.8	57.1	12.27	53.9	11.78	50.7	11.39	49.0	10.87	47.5	10.54	44.3	9.91
	13.0	11.8	57.1	11.48	53.9	11.02	50.7	10.65	49.0	10.17	47.5	9.86	44.3	9.27
15.0	13.7	57.1	10.83	53.9	10.39	50.7	10.04	49.0	9.59	47.5	9.30	44.3	8.74	
60	-19.8	-20	49.0	16.58	46.4	16.27	40.9	15.79	40.9	15.32	40.6	14.85	38.0	14.34
	-18.8	-19	49.0	16.44	46.4	16.12	42.8	15.63	42.0	15.16	40.6	14.70	38.0	14.18
	-16.7	-17	49.0	16.16	46.4	15.79	43.5	15.30	42.0	14.83	40.6	14.37	38.0	13.83
	-13.7	-15	49.0	15.75	46.4	15.33	43.5	14.83	42.0	14.36	40.6	13.90	38.0	13.33
	-11.8	-13	49.0	15.50	46.4	15.03	43.5	14.53	42.0	14.07	40.6	13.60	38.0	13.02
	-9.8	-11	49.0	15.23	46.4	14.73	43.5	14.21	42.0	13.75	40.6	13.29	38.0	12.69
	-9.5	-10	49.0	15.18	46.4	14.68	43.5	14.17	42.0	13.70	40.6	13.24	38.0	12.64
	-8.5	-9.1	49.0	15.05	46.4	14.52	43.5	14.01	42.0	13.55	40.6	13.09	38.0	12.47
	-7.0	-7.6	49.0	14.85	46.4	14.29	43.5	13.77	42.0	13.31	40.6	12.85	38.0	12.23
	-5.0	-5.6	49.0	14.58	46.4	13.98	43.5	13.46	42.0	13.00	40.6	12.54	38.0	11.90
	-3.0	-3.7	49.0	14.30	46.4	13.68	43.5	13.14	42.0	12.68	40.6	12.23	38.0	11.57
	0.0	-0.7	49.0	13.90	46.4	13.21	43.5	12.67	42.0	12.21	40.6	11.76	38.0	11.07
	3.0	2.2	49.0	13.49	46.4	12.75	43.5	12.20	42.0	11.74	40.6	11.29	38.0	10.57
	5.0	4.1	49.0	13.22	46.4	12.44	43.5	11.88	42.0	11.43	40.6	10.97	38.0	10.24
	7.0	6	49.0	12.95	46.4	12.13	43.5	11.56	42.0	11.11	40.6	10.66	38.0	9.91
	9.0	7.9	49.0	11.56	46.4	10.82	43.5	10.32	42.0	9.92	40.6	9.51	38.0	8.85
	11.0	9.8	49.0	10.79	46.4	10.11	43.5	9.63	42.0	9.26	40.6	8.88	38.0	8.26
	13.0	11.8	49.0	10.11	46.4	9.47	43.5	9.03	42.0	8.67	40.6	8.32	38.0	7.74
15.0	13.7	49.0	9.55	46.4	8.95	43.5	8.53	42.0	8.20	40.6	7.86	38.0	7.31	
50	-19.8	-20	40.9	14.85	38.6	14.33	36.2	13.85	35.1	13.35	33.9	12.90	31.6	12.41
	-18.8	-19	40.9	14.69	38.6	14.16	36.2	13.68	35.1	13.19	33.9	12.74	31.6	12.24
	-16.7	-17	40.9	14.34	38.6	13.81	36.2	13.33	35.1	12.85	33.9	12.41	31.6	11.91
	-13.7	-15	40.9	13.85	38.6	13.30	36.2	12.84	35.1	12.35	33.9	11.93	31.6	11.42
	-11.8	-13	40.9	13.54	38.6	12.97	36.2	12.53	35.1	12.04	33.9	11.64	31.6	11.12
	-9.8	-11	40.9	13.21	38.6	12.63	36.2	12.20	35.1	11.71	33.9	11.32	31.6	10.80
	-9.5	-10	40.9	13.16	38.6	12.58	36.2	12.15	35.1	11.66	33.9	11.27	31.6	10.75
	-8.5	-9.1	40.9	12.99	38.6	12.41	36.2	11.98	35.1	11.50	33.9	11.12	31.6	10.59
	-7.0	-7.6	40.9	12.75	38.6	12.16	36.2	11.73	35.1	11.25	33.9	10.88	31.6	10.35
	-5.0	-5.6	40.9	12.42	38.6	11.82	36.2	11.40	35.1	10.92	33.9	10.56	31.6	10.02
	-3.0	-3.7	40.9	12.09	38.6	11.48	36.2	11.07	35.1	10.59	33.9	10.25	31.6	9.70
	0.0	-0.7	40.9	11.60	38.6	10.97	36.2	10.58	35.1	10.10	33.9	9.78	31.6	9.22
	3.0	2.2	40.9	11.10	38.6	10.46	36.2	10.08	35.1	9.61	33.9	9.30	31.6	8.74
	5.0	4.1	40.9	10.78	38.6	10.12	36.2	9.75	35.1	9.28	33.9	8.99	31.6	8.41
	7.0	6	40.9	10.45	38.6	9.78	36.2	9.42	35.1	8.95	33.9	8.67	31.6	8.09
	9.0	7.9	40.9	9.43	38.6	8.83	36.2	8.51	35.1	8.08	33.9	7.83	31.6	7.31
	11.0	9.8	40.9	8.83	38.6	8.26	36.2	7.96	35.1	7.56	33.9	7.33	31.6	6.84
	13.0	11.8	40.9	8.29	38.6	7.76	36.2	7.47	35.1	7.10	33.9	6.88	31.6	6.42
15.0	13.7	40.9	7.84	38.6	7.34	36.2	7.07	35.1	6.72	33.9	6.51	31.6	6.07	

Note

1. TC: Total Capacity(kW), PI: Power Input(kW, Comp. + Outdoor fan motor)
2. Capacity tables show the average value of conditions which may occur.
3. In the range beyond the operation limit of the outdoor unit, continuous operation and performance can not be guaranteed. When selecting the outdoor units, avoid the air temperature range that is not guaranteed continuous operation.

7. Capacity Tables

7.2.2 Two Unit

◆ A(C)RUN280LLS5

Combination (%)		Heating Capacity (28HP)												
		Outdoor air temp.		Indoor air temp. °C DB										
		°C DB	°C WB	16		18		20		21		22		24
		TC	PI	TC	PI	TC	PI	TC	PI	TC	PI	TC	PI	
130	-19.8	-20	45.3	18.68	45.3	19.41	45.1	20.04	45.1	21.00	45.1	21.91	45.1	23.36
	-18.8	-19	47.6	19.17	47.6	19.89	47.2	20.51	47.2	21.49	47.2	22.40	47.2	23.85
	-16.7	-17	52.2	20.18	52.2	20.90	51.9	21.53	51.9	22.49	51.9	23.41	51.9	24.86
	-13.7	-15	58.8	21.63	58.8	22.35	58.4	22.98	58.4	23.94	58.4	24.86	58.4	24.58
	-11.8	-13	62.1	22.54	62.1	23.27	61.7	23.90	61.7	24.86	61.7	24.72	61.7	24.40
	-9.8	-11	65.6	23.50	65.6	24.23	65.2	24.86	65.2	24.77	65.2	24.58	65.2	24.21
	-9.5	-10	67.2	23.65	67.2	24.37	66.8	24.86	66.8	24.76	65.7	24.55	65.7	24.19
	-8.5	-9.1	72.4	24.13	72.4	24.86	71.9	24.85	71.9	24.72	67.5	24.48	67.5	24.09
	-7.0	-7.6	80.2	24.86	80.2	24.93	79.8	24.84	79.8	24.65	79.8	24.37	73.2	23.96
	-5.0	-5.6	90.7	25.07	90.7	25.02	90.1	24.84	90.1	24.58	90.1	24.23	77.5	23.77
	-3.0	-3.7	101.1	25.30	101.1	25.10	100.4	24.83	98.5	24.49	95.0	24.09	81.9	23.59
	0.0	-0.7	101.3	25.63	101.3	25.23	101.0	24.83	98.5	24.37	95.0	23.87	88.5	23.32
	3.0	2.2	101.3	25.96	101.3	25.37	101.0	24.81	98.5	24.25	95.0	23.65	88.5	23.04
	5.0	4.1	101.3	26.18	101.3	25.46	101.0	24.81	98.5	24.16	95.0	23.51	88.5	22.85
	7.0	6	101.3	26.40	101.3	25.55	101.0	24.81	98.5	24.08	95.0	23.37	88.5	22.67
	9.0	7.9	101.3	26.65	101.3	25.79	101.0	25.04	98.5	24.32	95.0	23.60	88.5	22.88
	11.0	9.8	101.3	27.18	101.3	26.30	101.0	25.53	98.5	24.79	95.0	24.06	88.5	23.34
13.0	11.8	101.3	27.70	101.3	26.81	101.0	26.02	98.5	25.27	95.0	24.51	88.5	23.78	
15.0	13.7	101.3	28.21	101.3	27.31	101.0	26.51	98.5	25.74	95.0	24.98	88.5	24.23	
120	-19.8	-20	45.1	19.41	45.1	20.04	44.8	21.00	44.8	21.91	44.8	23.36	44.8	24.37
	-18.8	-19	47.2	19.89	47.2	20.51	46.9	21.49	46.9	22.40	46.9	23.85	46.9	24.86
	-16.7	-17	51.8	20.90	51.8	21.53	51.5	22.49	51.5	23.41	51.5	24.86	51.5	24.67
	-13.7	-15	58.4	22.35	58.4	22.98	58.1	23.94	58.1	24.86	58.1	24.63	58.1	24.42
	-11.8	-13	61.7	23.27	61.7	23.90	61.4	24.86	61.4	24.71	61.4	24.49	61.4	24.26
	-9.8	-11	65.2	24.23	65.2	24.86	64.7	24.74	64.7	24.56	64.7	24.34	64.7	24.09
	-9.5	-10	66.6	24.37	66.6	24.84	66.3	24.72	66.3	24.54	66.3	24.32	66.3	24.06
	-8.5	-9.1	71.9	24.86	71.9	24.81	71.4	24.66	71.4	24.46	69.4	24.23	69.4	23.98
	-7.0	-7.6	79.6	24.86	79.6	24.75	79.1	24.57	79.1	24.35	72.6	24.12	72.6	23.85
	-5.0	-5.6	90.0	24.86	90.0	24.67	89.5	24.46	89.5	24.20	89.5	23.97	77.0	23.68
	-3.0	-3.7	99.4	24.86	99.4	24.60	95.5	24.34	92.4	24.04	89.5	23.83	81.4	23.51
	0.0	-0.7	100.5	24.88	99.4	24.49	95.5	24.16	92.4	23.82	89.5	23.60	83.1	23.25
	3.0	2.2	100.5	24.88	99.4	24.37	95.5	23.98	92.4	23.60	89.5	23.37	83.1	23.00
	5.0	4.1	100.5	24.89	99.4	24.30	95.5	23.86	92.4	23.44	89.5	23.22	83.1	22.83
	7.0	6	100.5	24.90	99.4	24.22	95.5	23.74	92.4	23.29	89.5	23.07	83.1	22.66
	9.0	7.9	100.5	25.02	99.4	24.34	95.5	23.86	92.4	23.41	89.5	23.18	83.1	22.77
	11.0	9.8	100.5	25.39	99.4	24.70	95.5	24.21	92.4	23.75	89.5	23.53	83.1	23.11
13.0	11.8	100.5	25.75	99.4	25.05	95.5	24.56	92.4	24.09	89.5	23.86	83.1	23.44	
15.0	13.7	100.5	26.11	99.4	25.40	95.5	24.90	92.4	24.42	89.5	24.19	83.1	23.76	
110	-19.8	-20	44.8	20.04	44.8	21.00	44.6	21.91	44.6	23.36	44.6	24.37	44.6	24.86
	-18.8	-19	47.0	20.51	47.0	21.49	46.7	22.40	46.7	23.85	46.7	24.86	46.7	24.72
	-16.7	-17	51.6	21.53	51.6	22.49	51.2	23.41	51.2	24.86	51.2	24.61	51.2	24.43
	-13.7	-15	58.1	22.98	58.1	23.94	57.7	24.86	57.7	24.51	57.7	24.26	57.7	24.02
	-11.8	-13	61.4	23.90	61.4	24.86	61.0	24.63	61.0	24.30	61.0	24.04	61.0	23.76
	-9.8	-11	64.8	24.86	64.8	24.62	64.4	24.39	64.4	24.06	64.4	23.81	64.4	23.48
	-9.5	-10	66.3	24.82	66.3	24.58	65.9	24.36	65.9	24.03	65.9	23.77	65.9	23.44
	-8.5	-9.1	71.5	24.72	71.5	24.47	71.0	24.24	71.0	23.91	69.2	23.65	69.2	23.30
	-7.0	-7.6	79.3	24.55	79.3	24.30	78.7	24.06	78.7	23.74	72.5	23.48	72.5	23.09
	-5.0	-5.6	86.3	24.33	86.3	24.06	85.7	23.83	82.9	23.51	76.0	23.25	74.9	22.83
	-3.0	-3.7	91.3	24.11	91.3	23.83	85.7	23.59	82.9	23.28	80.1	23.02	74.9	22.55
	0.0	-0.7	96.6	23.78	91.3	23.48	85.7	23.23	82.9	22.94	80.1	22.67	74.9	22.14
	3.0	2.2	96.6	23.44	91.3	23.13	85.7	22.88	82.9	22.60	80.1	22.32	74.9	21.73
	5.0	4.1	96.6	23.23	91.3	22.90	85.7	22.64	82.9	22.37	80.1	22.09	74.9	21.45
	7.0	6	96.6	23.01	91.3	22.66	85.7	22.41	82.9	22.13	80.1	21.85	74.9	21.18
	9.0	7.9	96.6	22.99	91.3	22.65	85.7	22.39	82.9	22.13	80.1	21.83	74.9	21.16
	11.0	9.8	96.6	23.20	91.3	22.85	85.7	22.60	82.9	22.32	80.1	22.04	74.9	21.36
13.0	11.8	96.6	23.39	91.3	23.04	85.7	22.78	82.9	22.51	80.1	22.22	74.9	21.53	
15.0	13.7	96.6	23.58	91.3	23.23	85.7	22.97	82.9	22.69	80.1	22.39	74.9	21.71	

Note

1. TC: Total Capacity(kW), PI: Power Input(kW, Comp. + Outdoor fan motor)
2. Capacity tables show the average value of conditions which may occur.
3. In the range beyond the operation limit of the outdoor unit, continuous operation and performance can not be guaranteed. When selecting the outdoor units, avoid the air temperature range that is not guaranteed continuous operation.

7. Capacity Tables

Combination (%)		Heating Capacity (28HP)												
		Outdoor air temp.		Indoor air temp. °C DB										
		°C DB	°C WB	16		18		20		21		22		24
		TC	PI	TC	PI	TC	PI	TC	PI	TC	PI	TC	PI	
100	-19.8	-20	44.6	20.86	44.6	21.66	44.3	22.34	44.3	23.62	44.3	24.51	44.3	24.86
	-18.8	-19	46.7	21.26	46.5	22.06	46.5	22.82	46.5	24.02	46.5	24.86	46.5	24.63
	-16.7	-17	51.1	22.10	51.1	22.90	51.1	23.83	50.7	24.86	50.7	24.41	50.7	24.14
	-13.7	-15	57.8	23.30	57.8	24.09	57.5	24.86	57.5	24.28	57.5	23.78	57.5	23.44
	-11.8	-13	61.0	24.06	60.7	24.86	60.7	24.52	60.7	23.91	60.7	23.37	60.7	23.01
	-9.8	-11	64.5	24.86	64.5	24.51	64.1	24.16	64.1	23.53	64.1	22.95	64.1	22.55
	-9.5	-10	65.9	24.81	65.9	24.46	65.7	24.11	65.7	23.46	65.7	22.90	65.7	22.48
	-8.5	-9.1	71.0	24.65	71.0	24.28	70.8	23.93	75.9	23.27	73.3	22.67	68.4	22.25
	-7.0	-7.6	80.1	24.42	79.8	24.02	78.4	23.67	75.9	22.99	73.3	22.36	68.4	21.90
	-5.0	-5.6	83.6	24.12	82.8	23.67	78.4	23.32	75.9	22.60	73.3	21.94	68.4	21.43
	-3.0	-3.7	86.1	23.81	83.5	23.32	78.4	22.97	75.9	22.21	73.3	21.52	68.4	20.97
	0.0	-0.7	88.4	23.35	83.5	22.80	78.4	22.44	75.9	21.64	73.3	20.88	68.4	20.29
	3.0	2.2	88.4	22.88	83.5	22.27	78.4	21.90	75.9	21.06	73.3	20.25	68.4	19.59
	5.0	4.1	88.4	22.58	83.5	21.92	78.4	21.55	75.9	20.67	73.3	19.83	68.4	19.13
	7.0	6	88.4	22.27	83.5	21.57	78.4	21.20	75.9	20.29	73.3	19.41	68.4	18.66
	9.0	7.9	88.4	21.97	83.5	21.27	78.4	20.90	75.9	20.01	73.3	19.13	68.4	18.41
11.0	9.8	88.4	21.86	83.5	21.18	78.4	20.81	75.9	19.91	73.3	19.05	68.4	18.32	
13.0	11.8	88.4	21.74	83.5	21.06	78.4	20.69	75.9	19.80	73.3	18.94	68.4	18.22	
15.0	13.7	88.4	21.59	83.5	20.92	78.4	20.55	75.9	19.66	73.3	18.81	68.4	18.10	
90	-19.8	-20	44.4	19.65	44.4	21.10	44.1	22.11	44.1	22.59	44.1	22.27	44.1	21.71
	-18.8	-19	46.7	20.14	46.5	21.58	46.3	22.59	46.3	22.44	46.3	22.11	46.3	21.53
	-16.7	-17	51.1	21.15	51.1	22.59	50.9	22.32	50.9	22.13	50.9	21.78	50.9	21.16
	-13.7	-15	57.8	22.59	57.8	22.23	57.2	21.92	57.2	21.67	57.2	21.30	57.2	20.63
	-11.8	-13	61.0	22.39	60.7	22.00	60.5	21.67	60.5	21.38	60.5	20.99	60.5	20.29
	-9.8	-11	64.5	22.17	64.5	21.76	63.8	21.41	63.8	21.08	63.8	20.68	58.6	19.94
	-9.5	-10	65.9	22.14	65.9	21.72	65.4	21.37	65.4	21.04	65.4	20.63	60.0	19.89
	-8.5	-9.1	71.0	22.03	70.6	21.60	70.5	21.24	69.5	20.89	67.2	20.47	62.5	19.71
	-7.0	-7.6	80.1	21.87	76.2	21.43	71.7	21.04	69.5	20.66	67.2	20.23	62.5	19.45
	-5.0	-5.6	81.0	21.65	76.2	21.18	71.7	20.78	69.5	20.36	67.2	19.91	62.5	19.09
	-3.0	-3.7	81.0	21.43	76.2	20.94	71.7	20.52	69.5	20.06	67.2	19.59	62.5	18.73
	0.0	-0.7	81.0	21.11	76.2	20.57	71.7	20.12	69.5	19.60	67.2	19.11	62.5	18.20
	3.0	2.2	81.0	20.78	76.2	20.22	71.7	19.73	69.5	19.15	67.2	18.63	62.5	17.68
	5.0	4.1	81.0	20.57	76.2	19.97	71.7	19.46	69.5	18.85	67.2	18.31	62.5	17.33
	7.0	6	81.0	20.36	76.2	19.73	71.7	19.20	69.5	18.54	67.2	17.99	62.5	16.96
	9.0	7.9	81.0	20.08	76.2	19.46	71.7	18.94	69.5	18.29	67.2	17.75	62.5	16.73
11.0	9.8	81.0	19.80	76.2	19.19	71.7	18.68	69.5	18.03	67.2	17.50	62.5	16.50	
13.0	11.8	81.0	19.52	76.2	18.92	71.7	18.41	69.5	17.78	67.2	17.26	62.5	16.27	
15.0	13.7	81.0	19.24	76.2	18.64	71.7	18.15	69.5	17.52	67.2	17.01	62.5	16.03	
80	-19.8	-20	43.9	17.09	43.9	18.54	43.9	20.03	43.9	19.73	43.9	19.27	43.9	18.77
	-18.8	-19	46.1	17.58	46.1	20.03	46.1	19.90	46.1	19.57	46.1	19.11	46.1	18.61
	-16.7	-17	50.9	20.03	50.9	19.78	50.9	19.61	50.9	19.26	50.9	18.79	50.9	18.27
	-13.7	-15	59.9	19.69	58.7	19.40	57.2	19.19	57.2	18.80	57.2	18.33	55.8	17.79
	-11.8	-13	64.7	19.48	62.9	19.17	60.5	18.93	60.5	18.52	60.0	18.03	55.8	17.48
	-9.8	-11	66.8	19.25	64.8	18.92	63.8	18.66	62.3	18.21	60.0	17.73	55.8	17.16
	-9.5	-10	67.2	19.22	65.3	18.88	64.2	18.61	62.3	18.17	60.0	17.68	55.8	17.12
	-8.5	-9.1	69.7	19.10	68.4	18.76	64.2	18.47	62.3	18.01	60.0	17.52	55.8	16.95
	-7.0	-7.6	72.5	18.93	68.4	18.57	64.2	18.27	62.3	17.78	60.0	17.29	55.8	16.71
	-5.0	-5.6	72.5	18.70	68.4	18.33	64.2	17.99	62.3	17.48	60.0	16.99	55.8	16.38
	-3.0	-3.7	72.5	18.47	68.4	18.08	64.2	17.71	62.3	17.17	60.0	16.68	55.8	16.07
	0.0	-0.7	72.5	18.13	68.4	17.70	64.2	17.31	62.3	16.72	60.0	16.22	55.8	15.58
	3.0	2.2	72.5	17.80	68.4	17.33	64.2	16.89	62.3	16.26	60.0	15.75	55.8	15.10
	5.0	4.1	72.5	17.57	68.4	17.08	64.2	16.61	62.3	15.96	60.0	15.45	55.8	14.78
	7.0	6	72.5	17.34	68.4	16.84	64.2	16.33	62.3	15.66	60.0	15.14	55.8	14.46
	9.0	7.9	72.5	16.28	68.4	15.80	64.2	15.34	62.3	14.70	60.0	14.22	55.8	13.58
11.0	9.8	72.5	15.11	68.4	14.67	64.2	14.24	62.3	13.65	60.0	13.19	55.8	12.60	
13.0	11.8	72.5	14.10	68.4	13.70	64.2	13.29	62.3	12.74	60.0	12.32	55.8	11.76	
15.0	13.7	72.5	13.28	68.4	12.89	64.2	12.51	62.3	11.99	60.0	11.60	55.8	11.07	

Note

1. TC: Total Capacity(kW), PI: Power Input(kW, Comp. + Outdoor fan motor)
2. Capacity tables show the average value of conditions which may occur.
3. In the range beyond the operation limit of the outdoor unit, continuous operation and performance can not be guaranteed. When selecting the outdoor units, avoid the air temperature range that is not guaranteed continuous operation.

7. Capacity Tables

Combination (%)		Heating Capacity (28HP)												
		Outdoor air temp.		Indoor air temp. °C DB										
		°C DB	°C WB	16		18		20		21		22		24
		TC	PI	TC	PI	TC	PI	TC	PI	TC	PI	TC	PI	
70	-19.8	-20	43.9	18.11	43.9	18.59	43.9	18.27	43.9	17.77	43.9	17.29	43.9	16.76
	-18.8	-19	46.1	18.59	46.1	18.44	46.1	18.11	46.1	17.60	46.1	17.12	46.1	16.59
	-16.7	-17	50.9	18.30	50.9	18.12	50.9	17.77	50.9	17.26	50.9	16.79	47.8	16.23
	-13.7	-15	61.5	17.90	58.1	17.65	54.6	17.30	52.7	16.77	51.2	16.30	47.8	15.72
	-11.8	-13	61.5	17.64	58.1	17.37	54.6	17.00	52.7	16.46	51.2	16.00	47.8	15.40
	-9.8	-11	61.5	17.37	58.1	17.05	54.6	16.68	52.7	16.12	51.2	15.68	47.8	15.05
	-9.5	-10	61.5	17.33	58.1	17.01	54.6	16.63	52.7	16.07	51.2	15.63	47.8	15.00
	-8.5	-9.1	61.5	17.19	58.1	16.86	54.6	16.47	52.7	15.91	51.2	15.47	47.8	14.84
	-7.0	-7.6	61.5	17.00	58.1	16.63	54.6	16.23	52.7	15.67	51.2	15.23	47.8	14.58
	-5.0	-5.6	61.5	16.72	58.1	16.33	54.6	15.91	52.7	15.34	51.2	14.90	47.8	14.24
	-3.0	-3.7	61.5	16.45	58.1	16.02	54.6	15.60	52.7	15.01	51.2	14.58	47.8	13.90
	0.0	-0.7	61.5	16.05	58.1	15.56	54.6	15.12	52.7	14.52	51.2	14.10	47.8	13.39
	3.0	2.2	61.5	15.64	58.1	15.10	54.6	14.65	52.7	14.03	51.2	13.61	47.8	12.88
	5.0	4.1	61.5	15.37	58.1	14.79	54.6	14.33	52.7	13.70	51.2	13.30	47.8	12.53
	7.0	6	61.5	15.10	58.1	14.49	54.6	14.00	52.7	13.37	51.2	12.97	47.8	12.19
	9.0	7.9	61.5	13.63	58.1	13.09	54.6	12.65	52.7	12.07	51.2	11.71	47.8	11.01
	11.0	9.8	61.5	12.70	58.1	12.18	54.6	11.77	52.7	11.25	51.2	10.90	47.8	10.25
	13.0	11.8	61.5	11.88	58.1	11.40	54.6	11.02	52.7	10.52	51.2	10.20	47.8	9.59
15.0	13.7	61.5	11.20	58.1	10.74	54.6	10.39	52.7	9.92	51.2	9.62	47.8	9.04	
60	-19.8	-20	52.7	17.14	49.9	16.83	43.9	16.32	43.9	15.84	43.7	15.36	40.9	14.83
	-18.8	-19	52.7	17.00	49.9	16.67	46.1	16.16	45.3	15.67	43.7	15.20	40.9	14.66
	-16.7	-17	52.7	16.71	49.9	16.32	46.9	15.83	45.3	15.34	43.7	14.86	40.9	14.30
	-13.7	-15	52.7	16.29	49.9	15.85	46.9	15.34	45.3	14.85	43.7	14.37	40.9	13.79
	-11.8	-13	52.7	16.02	49.9	15.55	46.9	15.02	45.3	14.55	43.7	14.06	40.9	13.46
	-9.8	-11	52.7	15.74	49.9	15.23	46.9	14.70	45.3	14.22	43.7	13.74	40.9	13.12
	-9.5	-10	52.7	15.70	49.9	15.18	46.9	14.65	45.3	14.18	43.7	13.69	40.9	13.07
	-8.5	-9.1	52.7	15.56	49.9	15.02	46.9	14.48	45.3	14.01	43.7	13.53	40.9	12.90
	-7.0	-7.6	52.7	15.35	49.9	14.78	46.9	14.25	45.3	13.76	43.7	13.29	40.9	12.64
	-5.0	-5.6	52.7	15.07	49.9	14.46	46.9	13.92	45.3	13.44	43.7	12.97	40.9	12.30
	-3.0	-3.7	52.7	14.79	49.9	14.14	46.9	13.58	45.3	13.11	43.7	12.64	40.9	11.96
	0.0	-0.7	52.7	14.37	49.9	13.67	46.9	13.10	45.3	12.63	43.7	12.16	40.9	11.44
	3.0	2.2	52.7	13.95	49.9	13.18	46.9	12.61	45.3	12.14	43.7	11.67	40.9	10.93
	5.0	4.1	52.7	13.67	49.9	12.86	46.9	12.28	45.3	11.82	43.7	11.35	40.9	10.60
	7.0	6	52.7	13.39	49.9	12.54	46.9	11.96	45.3	11.49	43.7	11.02	40.9	10.25
	9.0	7.9	52.7	11.95	49.9	11.19	46.9	10.67	45.3	10.25	43.7	9.84	40.9	9.15
	11.0	9.8	52.7	11.16	49.9	10.46	46.9	9.97	45.3	9.58	43.7	9.18	40.9	8.55
	13.0	11.8	52.7	10.46	49.9	9.79	46.9	9.34	45.3	8.97	43.7	8.60	40.9	8.00
15.0	13.7	52.7	9.88	49.9	9.25	46.9	8.82	45.3	8.48	43.7	8.13	40.9	7.57	
50	-19.8	-20	44.1	15.36	41.5	14.82	39.0	14.31	37.8	13.81	36.6	13.33	34.0	12.83
	-18.8	-19	44.1	15.19	41.5	14.64	39.0	14.15	37.8	13.64	36.6	13.17	34.0	12.66
	-16.7	-17	44.1	14.83	41.5	14.27	39.0	13.78	37.8	13.29	36.6	12.83	34.0	12.31
	-13.7	-15	44.1	14.32	41.5	13.75	39.0	13.27	37.8	12.77	36.6	12.34	34.0	11.81
	-11.8	-13	44.1	13.99	41.5	13.41	39.0	12.95	37.8	12.45	36.6	12.03	34.0	11.50
	-9.8	-11	44.1	13.66	41.5	13.06	39.0	12.61	37.8	12.11	36.6	11.71	34.0	11.16
	-9.5	-10	44.1	13.61	41.5	13.01	39.0	12.55	37.8	12.06	36.6	11.66	34.0	11.11
	-8.5	-9.1	44.1	13.43	41.5	12.83	39.0	12.39	37.8	11.89	36.6	11.50	34.0	10.95
	-7.0	-7.6	44.1	13.18	41.5	12.57	39.0	12.13	37.8	11.64	36.6	11.25	34.0	10.69
	-5.0	-5.6	44.1	12.85	41.5	12.22	39.0	11.79	37.8	11.29	36.6	10.92	34.0	10.36
	-3.0	-3.7	44.1	12.50	41.5	11.87	39.0	11.45	37.8	10.95	36.6	10.60	34.0	10.03
	0.0	-0.7	44.1	11.99	41.5	11.34	39.0	10.94	37.8	10.44	36.6	10.11	34.0	9.53
	3.0	2.2	44.1	11.48	41.5	10.81	39.0	10.43	37.8	9.94	36.6	9.62	34.0	9.03
	5.0	4.1	44.1	11.14	41.5	10.46	39.0	10.09	37.8	9.60	36.6	9.29	34.0	8.70
	7.0	6	44.1	10.81	41.5	10.11	39.0	9.74	37.8	9.25	36.6	8.97	34.0	8.37
	9.0	7.9	44.1	9.76	41.5	9.13	39.0	8.80	37.8	8.36	36.6	8.10	34.0	7.55
	11.0	9.8	44.1	9.13	41.5	8.55	39.0	8.23	37.8	7.82	36.6	7.58	34.0	7.07
	13.0	11.8	44.1	8.57	41.5	8.02	39.0	7.73	37.8	7.34	36.6	7.11	34.0	6.64
15.0	13.7	44.1	8.11	41.5	7.59	39.0	7.31	37.8	6.95	36.6	6.73	34.0	6.29	

Note

1. TC: Total Capacity(kW), PI: Power Input(kW, Comp. + Outdoor fan motor)
2. Capacity tables show the average value of conditions which may occur.
3. In the range beyond the operation limit of the outdoor unit, continuous operation and performance can not be guaranteed. When selecting the outdoor units, avoid the air temperature range that is not guaranteed continuous operation.

7. Capacity Tables

◆ A(C)RUN300LLS5

Combination (%)	Outdoor air temp.		Indoor air temp. °C DB											
	°C DB	°C WB	16		18		20		21		22		24	
			TC	PI	TC	PI	TC	PI	TC	PI	TC	PI	TC	PI
130	-19.8	-20	48.6	18.68	48.6	19.41	48.4	20.04	48.4	21.00	48.4	21.91	48.4	23.36
	-18.8	-19	51.0	19.17	51.0	19.89	50.6	20.51	50.6	21.49	50.6	22.40	50.6	23.85
	-16.7	-17	56.0	20.18	56.0	20.90	55.6	21.53	55.6	22.49	55.6	23.41	55.6	24.86
	-13.7	-15	63.0	21.63	63.0	22.35	62.6	22.98	62.6	23.94	62.6	24.86	62.6	24.58
	-11.8	-13	66.5	22.54	66.5	23.27	66.1	23.90	66.1	24.86	66.1	24.72	66.1	24.40
	-9.8	-11	70.3	23.50	70.3	24.23	69.8	24.86	69.8	24.77	69.8	24.58	69.8	24.21
	-9.5	-10	72.0	23.65	72.0	24.37	71.5	24.86	71.5	24.76	70.4	24.55	70.4	24.19
	-8.5	-9.1	77.6	24.13	77.6	24.86	77.1	24.85	77.1	24.72	72.3	24.48	72.3	24.09
	-7.0	-7.6	86.0	24.86	86.0	24.93	85.4	24.84	85.4	24.65	85.4	24.37	78.3	23.96
	-5.0	-5.6	97.2	25.07	97.2	25.02	96.5	24.84	96.5	24.58	96.5	24.23	82.9	23.77
	-3.0	-3.7	108.3	25.30	108.3	25.10	107.6	24.83	105.5	24.49	101.8	24.09	87.6	23.59
	0.0	-0.7	108.5	25.63	108.5	25.23	108.2	24.83	105.5	24.37	101.8	23.87	94.6	23.32
	3.0	2.2	108.5	25.96	108.5	25.37	108.2	24.81	105.5	24.25	101.8	23.65	94.8	23.04
	5.0	4.1	108.5	26.18	108.5	25.46	108.2	24.81	105.5	24.16	101.8	23.51	94.8	22.85
	7.0	6	108.5	26.40	108.5	25.55	108.2	24.81	105.5	24.08	101.8	23.37	94.8	22.67
	9.0	7.9	108.5	26.65	108.5	25.79	108.2	25.04	105.5	24.32	101.8	23.60	94.8	22.88
	11.0	9.8	108.5	27.18	108.5	26.30	108.2	25.53	105.5	24.79	101.8	24.06	94.8	23.34
13.0	11.8	108.5	27.70	108.5	26.81	108.2	26.02	105.5	25.27	101.8	24.51	94.8	23.78	
15.0	13.7	108.5	28.21	108.5	27.31	108.2	26.51	105.5	25.74	101.8	24.98	94.8	24.23	
120	-19.8	-20	48.3	19.41	48.3	20.04	48.0	21.00	48.0	21.91	48.0	23.36	48.0	24.37
	-18.8	-19	50.6	19.89	50.6	20.51	50.3	21.49	50.3	22.40	50.3	23.85	50.3	24.86
	-16.7	-17	55.5	20.90	55.5	21.53	55.2	22.49	55.2	23.41	55.2	24.86	55.2	24.67
	-13.7	-15	62.5	22.35	62.5	22.98	62.2	23.94	62.2	24.86	62.2	24.63	62.2	24.42
	-11.8	-13	66.1	23.27	66.1	23.90	65.7	24.86	65.7	24.71	65.7	24.49	65.7	24.26
	-9.8	-11	69.8	24.23	69.8	24.86	69.3	24.74	69.3	24.56	69.3	24.34	69.3	24.09
	-9.5	-10	71.4	24.37	71.4	24.84	71.0	24.72	71.0	24.54	71.0	24.32	71.0	24.06
	-8.5	-9.1	77.0	24.86	77.0	24.81	76.5	24.66	76.5	24.46	74.2	24.23	74.2	23.98
	-7.0	-7.6	85.3	24.86	85.3	24.75	84.8	24.57	84.8	24.35	77.7	24.12	77.7	23.85
	-5.0	-5.6	96.4	24.86	96.4	24.67	95.9	24.46	95.9	24.20	95.9	23.97	82.3	23.68
	-3.0	-3.7	106.5	24.86	106.5	24.60	102.3	24.34	99.0	24.04	95.9	23.83	87.0	23.51
	0.0	-0.7	107.7	24.88	106.5	24.49	102.3	24.16	99.0	23.82	95.9	23.60	89.0	23.25
	3.0	2.2	107.7	24.88	106.5	24.37	102.3	23.98	99.0	23.60	95.9	23.37	89.0	23.00
	5.0	4.1	107.7	24.89	106.5	24.30	102.3	23.86	99.0	23.44	95.9	23.22	89.0	22.83
	7.0	6	107.7	24.90	106.5	24.22	102.3	23.74	99.0	23.29	95.9	23.07	89.0	22.66
	9.0	7.9	107.7	25.02	106.5	24.34	102.3	23.86	99.0	23.41	95.9	23.18	89.0	22.77
	11.0	9.8	107.7	25.39	106.5	24.70	102.3	24.21	99.0	23.75	95.9	23.53	89.0	23.11
13.0	11.8	107.7	25.75	106.5	25.05	102.3	24.56	99.0	24.09	95.9	23.86	89.0	23.44	
15.0	13.7	107.7	26.11	106.5	25.40	102.3	24.90	99.0	24.42	95.9	24.19	89.0	23.76	
110	-19.8	-20	48.1	20.04	48.1	21.00	47.8	21.91	47.8	23.36	47.8	24.37	47.8	24.86
	-18.8	-19	50.4	20.51	50.4	21.49	50.1	22.40	50.1	23.85	50.1	24.86	50.1	24.72
	-16.7	-17	55.3	21.53	55.3	22.49	54.9	23.41	54.9	24.86	54.9	24.61	54.9	24.43
	-13.7	-15	62.2	22.98	62.2	23.94	61.8	24.86	61.8	24.51	61.8	24.26	61.8	24.02
	-11.8	-13	65.7	23.90	65.7	24.86	65.3	24.63	65.3	24.30	65.3	24.04	65.3	23.76
	-9.8	-11	69.4	24.86	69.4	24.62	69.0	24.39	69.0	24.06	69.0	23.81	69.0	23.48
	-9.5	-10	71.1	24.82	71.1	24.58	70.6	24.36	70.6	24.03	70.6	23.77	70.6	23.44
	-8.5	-9.1	76.6	24.72	76.6	24.47	76.1	24.24	76.1	23.91	74.1	23.65	74.1	23.30
	-7.0	-7.6	84.9	24.55	84.9	24.30	84.3	24.06	84.3	23.74	77.8	23.48	77.8	23.09
	-5.0	-5.6	92.5	24.33	92.5	24.06	91.8	23.83	88.8	23.51	81.5	23.25	80.2	22.83
	-3.0	-3.7	97.8	24.11	97.8	23.83	91.8	23.59	88.8	23.28	85.8	23.02	80.2	22.55
	0.0	-0.7	103.5	23.78	97.8	23.48	91.8	23.23	88.8	22.94	85.8	22.67	80.2	22.14
	3.0	2.2	103.5	23.44	97.8	23.13	91.8	22.88	88.8	22.60	85.8	22.32	80.2	21.73
	5.0	4.1	103.5	23.23	97.8	22.90	91.8	22.64	88.8	22.37	85.8	22.09	80.2	21.45
	7.0	6	103.5	23.01	97.8	22.66	91.8	22.41	88.8	22.13	85.8	21.85	80.2	21.18
	9.0	7.9	103.5	22.99	97.8	22.65	91.8	22.39	88.8	22.13	85.8	21.83	80.2	21.16
	11.0	9.8	103.5	23.20	97.8	22.85	91.8	22.60	88.8	22.32	85.8	22.04	80.2	21.36
13.0	11.8	103.5	23.39	97.8	23.04	91.8	22.78	88.8	22.51	85.8	22.22	80.2	21.53	
15.0	13.7	103.5	23.58	97.8	23.23	91.8	22.97	88.8	22.69	85.8	22.39	80.2	21.71	

Note

1. TC: Total Capacity(kW), PI : Power Input(kW, Comp. + Outdoor fan motor)
2. Capacity tables show the average value of conditions which may occur.
3. In the range beyond the operation limit of the outdoor unit, continuous operation and performance can not be guaranteed. When selecting the outdoor units, avoid the air temperature range that is not guaranteed continuous operation.

7. Capacity Tables

Combination (%)		Heating Capacity (30HP)												
		Outdoor air temp.		Indoor air temp. °C DB										
		°C DB	°C WB	16		18		20		21		22		24
		TC	PI	TC	PI	TC	PI	TC	PI	TC	PI	TC	PI	
100	-19.8	-20	47.9	20.86	47.9	21.66	47.6	22.34	47.6	23.62	47.6	24.51	47.6	24.86
	-18.8	-19	50.1	21.26	49.8	22.06	49.8	22.82	49.8	24.02	49.8	24.86	49.8	24.63
	-16.7	-17	54.7	22.10	54.7	22.90	54.7	23.83	54.3	24.86	54.3	24.41	54.3	24.14
	-13.7	-15	61.9	23.30	61.9	24.09	61.5	24.86	61.5	24.28	61.5	23.78	61.5	23.44
	-11.8	-13	65.3	24.06	65.0	24.86	65.0	24.52	65.0	23.91	65.0	23.37	65.0	23.01
	-9.8	-11	69.1	24.86	69.1	24.51	68.7	24.16	68.7	23.53	68.7	22.95	68.7	22.55
	-9.5	-10	70.6	24.81	70.6	24.46	70.3	24.11	70.3	23.46	70.3	22.90	70.3	22.48
	-8.5	-9.1	76.1	24.65	76.1	24.28	75.8	23.93	81.3	23.27	78.6	22.67	73.2	22.25
	-7.0	-7.6	85.8	24.42	85.5	24.02	84.0	23.67	81.3	22.99	78.6	22.36	73.2	21.90
	-5.0	-5.6	89.6	24.12	88.7	23.67	84.0	23.32	81.3	22.60	78.6	21.94	73.2	21.43
	-3.0	-3.7	92.2	23.81	89.4	23.32	84.0	22.97	81.3	22.21	78.6	21.52	73.2	20.97
	0.0	-0.7	94.8	23.35	89.4	22.80	84.0	22.44	81.3	21.64	78.6	20.88	73.2	20.29
	3.0	2.2	94.8	22.88	89.4	22.27	84.0	21.90	81.3	21.06	78.6	20.25	73.2	19.59
	5.0	4.1	94.8	22.58	89.4	21.92	84.0	21.55	81.3	20.67	78.6	19.83	73.2	19.13
	7.0	6	94.8	22.27	89.4	21.57	84.0	21.20	81.3	20.29	78.6	19.41	73.2	18.66
	9.0	7.9	94.8	21.97	89.4	21.27	84.0	20.90	81.3	20.01	78.6	19.13	73.2	18.41
	11.0	9.8	94.8	21.86	89.4	21.18	84.0	20.81	81.3	19.91	78.6	19.05	73.2	18.32
13.0	11.8	94.8	21.74	89.4	21.06	84.0	20.69	81.3	19.80	78.6	18.94	73.2	18.22	
15.0	13.7	94.8	21.59	89.4	20.92	84.0	20.55	81.3	19.66	78.6	18.81	73.2	18.10	
90	-19.8	-20	47.6	19.65	47.6	21.10	47.4	22.11	47.4	22.59	47.4	22.27	47.4	21.71
	-18.8	-19	50.1	20.14	49.8	21.58	49.6	22.59	49.6	22.44	49.6	22.11	49.6	21.53
	-16.7	-17	54.7	21.15	54.7	22.59	54.5	22.32	54.5	22.13	54.5	21.78	54.5	21.16
	-13.7	-15	61.9	22.59	61.9	22.23	61.3	21.92	61.3	21.67	61.3	21.30	61.3	20.63
	-11.8	-13	65.3	22.39	65.0	22.00	64.8	21.67	64.8	21.38	64.8	20.99	64.8	20.29
	-9.8	-11	69.1	22.17	69.1	21.76	68.4	21.41	68.4	21.08	68.4	20.68	62.8	19.94
	-9.5	-10	70.6	22.14	70.6	21.72	70.1	21.37	70.1	21.04	70.1	20.63	64.3	19.89
	-8.5	-9.1	76.1	22.03	75.6	21.60	75.5	21.24	74.5	20.89	72.0	20.47	67.0	19.71
	-7.0	-7.6	85.8	21.87	81.7	21.43	76.8	21.04	74.5	20.66	72.0	20.23	67.0	19.45
	-5.0	-5.6	86.8	21.65	81.7	21.18	76.8	20.78	74.5	20.36	72.0	19.91	67.0	19.09
	-3.0	-3.7	86.8	21.43	81.7	20.94	76.8	20.52	74.5	20.06	72.0	19.59	67.0	18.73
	0.0	-0.7	86.8	21.11	81.7	20.57	76.8	20.12	74.5	19.60	72.0	19.11	67.0	18.20
	3.0	2.2	86.8	20.78	81.7	20.22	76.8	19.73	74.5	19.15	72.0	18.63	67.0	17.68
	5.0	4.1	86.8	20.57	81.7	19.97	76.8	19.46	74.5	18.85	72.0	18.31	67.0	17.33
	7.0	6	86.8	20.36	81.7	19.73	76.8	19.20	74.5	18.54	72.0	17.99	67.0	16.96
	9.0	7.9	86.8	20.08	81.7	19.46	76.8	18.94	74.5	18.29	72.0	17.75	67.0	16.73
	11.0	9.8	86.8	19.80	81.7	19.19	76.8	18.68	74.5	18.03	72.0	17.50	67.0	16.50
13.0	11.8	86.8	19.52	81.7	18.92	76.8	18.41	74.5	17.78	72.0	17.26	67.0	16.27	
15.0	13.7	86.8	19.24	81.7	18.64	76.8	18.15	74.5	17.52	72.0	17.01	67.0	16.03	
80	-19.8	-20	47.1	17.09	47.1	18.54	47.1	20.03	47.1	19.73	47.1	19.27	47.1	18.77
	-18.8	-19	49.4	17.58	49.4	20.03	49.4	19.90	49.4	19.57	49.4	19.11	49.4	18.61
	-16.7	-17	54.5	20.03	54.5	19.78	54.5	19.61	54.5	19.26	54.5	18.79	54.5	18.27
	-13.7	-15	64.2	19.69	62.8	19.40	61.3	19.19	61.3	18.80	61.3	18.33	59.8	17.79
	-11.8	-13	69.3	19.48	67.3	19.17	64.8	18.93	64.8	18.52	64.3	18.03	59.8	17.48
	-9.8	-11	71.6	19.25	69.4	18.92	68.4	18.66	66.7	18.21	64.3	17.73	59.8	17.16
	-9.5	-10	72.0	19.22	69.9	18.88	68.8	18.61	66.7	18.17	64.3	17.68	59.8	17.12
	-8.5	-9.1	74.7	19.10	73.2	18.76	68.8	18.47	66.7	18.01	64.3	17.52	59.8	16.95
	-7.0	-7.6	77.7	18.93	73.2	18.57	68.8	18.27	66.7	17.78	64.3	17.29	59.8	16.71
	-5.0	-5.6	77.7	18.70	73.2	18.33	68.8	17.99	66.7	17.48	64.3	16.99	59.8	16.38
	-3.0	-3.7	77.7	18.47	73.2	18.08	68.8	17.71	66.7	17.17	64.3	16.68	59.8	16.07
	0.0	-0.7	77.7	18.13	73.2	17.70	68.8	17.31	66.7	16.72	64.3	16.22	59.8	15.58
	3.0	2.2	77.7	17.80	73.2	17.33	68.8	16.89	66.7	16.26	64.3	15.75	59.8	15.10
	5.0	4.1	77.7	17.57	73.2	17.08	68.8	16.61	66.7	15.96	64.3	15.45	59.8	14.78
	7.0	6	77.7	17.34	73.2	16.84	68.8	16.33	66.7	15.66	64.3	15.14	59.8	14.46
	9.0	7.9	77.7	16.28	73.2	15.80	68.8	15.34	66.7	14.70	64.3	14.22	59.8	13.58
	11.0	9.8	77.7	15.11	73.2	14.67	68.8	14.24	66.7	13.65	64.3	13.19	59.8	12.60
13.0	11.8	77.7	14.10	73.2	13.70	68.8	13.29	66.7	12.74	64.3	12.32	59.8	11.76	
15.0	13.7	77.7	13.28	73.2	12.89	68.8	12.51	66.7	11.99	64.3	11.60	59.8	11.07	

Note

1. TC: Total Capacity(kW), PI: Power Input(kW, Comp. + Outdoor fan motor)
2. Capacity tables show the average value of conditions which may occur.
3. In the range beyond the operation limit of the outdoor unit, continuous operation and performance can not be guaranteed. When selecting the outdoor units, avoid the air temperature range that is not guaranteed continuous operation.

7. Capacity Tables

Combination (%)		Heating Capacity (30HP)												
		Outdoor air temp.		Indoor air temp. °C DB										
		°C DB	°C WB	16		18		20		21		22		24
		TC	PI	TC	PI	TC	PI	TC	PI	TC	PI	TC	PI	
70	-19.8	-20	47.1	18.11	47.1	18.59	47.1	18.27	47.1	17.77	47.1	17.29	47.1	16.76
	-18.8	-19	49.4	18.59	49.4	18.44	49.4	18.11	49.4	17.60	49.4	17.12	49.4	16.59
	-16.7	-17	54.5	18.30	54.5	18.12	54.5	17.77	54.5	17.26	54.5	16.79	51.2	16.23
	-13.7	-15	65.9	17.90	62.2	17.65	58.5	17.30	56.5	16.77	54.8	16.30	51.2	15.72
	-11.8	-13	65.9	17.64	62.2	17.37	58.5	17.00	56.5	16.46	54.8	16.00	51.2	15.40
	-9.8	-11	65.9	17.37	62.2	17.05	58.5	16.68	56.5	16.12	54.8	15.68	51.2	15.05
	-9.5	-10	65.9	17.33	62.2	17.01	58.5	16.63	56.5	16.07	54.8	15.63	51.2	15.00
	-8.5	-9.1	65.9	17.19	62.2	16.86	58.5	16.47	56.5	15.91	54.8	15.47	51.2	14.84
	-7.0	-7.6	65.9	17.00	62.2	16.63	58.5	16.23	56.5	15.67	54.8	15.23	51.2	14.58
	-5.0	-5.6	65.9	16.72	62.2	16.33	58.5	15.91	56.5	15.34	54.8	14.90	51.2	14.24
	-3.0	-3.7	65.9	16.45	62.2	16.02	58.5	15.60	56.5	15.01	54.8	14.58	51.2	13.90
	0.0	-0.7	65.9	16.05	62.2	15.56	58.5	15.12	56.5	14.52	54.8	14.10	51.2	13.39
	3.0	2.2	65.9	15.64	62.2	15.10	58.5	14.65	56.5	14.03	54.8	13.61	51.2	12.88
	5.0	4.1	65.9	15.37	62.2	14.79	58.5	14.33	56.5	13.70	54.8	13.30	51.2	12.53
	7.0	6	65.9	15.10	62.2	14.49	58.5	14.00	56.5	13.37	54.8	12.97	51.2	12.19
	9.0	7.9	65.9	13.63	62.2	13.09	58.5	12.65	56.5	12.07	54.8	11.71	51.2	11.01
	11.0	9.8	65.9	12.70	62.2	12.18	58.5	11.77	56.5	11.25	54.8	10.90	51.2	10.25
13.0	11.8	65.9	11.88	62.2	11.40	58.5	11.02	56.5	10.52	54.8	10.20	51.2	9.59	
15.0	13.7	65.9	11.20	62.2	10.74	58.5	10.39	56.5	9.92	54.8	9.62	51.2	9.04	
60	-19.8	-20	56.5	17.14	53.5	16.83	47.1	16.32	47.1	15.84	46.8	15.36	43.8	14.83
	-18.8	-19	56.5	17.00	53.5	16.67	49.4	16.16	48.5	15.67	46.8	15.20	43.8	14.66
	-16.7	-17	56.5	16.71	53.5	16.32	50.2	15.83	48.5	15.34	46.8	14.86	43.8	14.30
	-13.7	-15	56.5	16.29	53.5	15.85	50.2	15.34	48.5	14.85	46.8	14.37	43.8	13.79
	-11.8	-13	56.5	16.02	53.5	15.55	50.2	15.02	48.5	14.55	46.8	14.06	43.8	13.46
	-9.8	-11	56.5	15.74	53.5	15.23	50.2	14.70	48.5	14.22	46.8	13.74	43.8	13.12
	-9.5	-10	56.5	15.70	53.5	15.18	50.2	14.65	48.5	14.18	46.8	13.69	43.8	13.07
	-8.5	-9.1	56.5	15.56	53.5	15.02	50.2	14.48	48.5	14.01	46.8	13.53	43.8	12.90
	-7.0	-7.6	56.5	15.35	53.5	14.78	50.2	14.25	48.5	13.76	46.8	13.29	43.8	12.64
	-5.0	-5.6	56.5	15.07	53.5	14.46	50.2	13.92	48.5	13.44	46.8	12.97	43.8	12.30
	-3.0	-3.7	56.5	14.79	53.5	14.14	50.2	13.58	48.5	13.11	46.8	12.64	43.8	11.96
	0.0	-0.7	56.5	14.37	53.5	13.67	50.2	13.10	48.5	12.63	46.8	12.16	43.8	11.44
	3.0	2.2	56.5	13.95	53.5	13.18	50.2	12.61	48.5	12.14	46.8	11.67	43.8	10.93
	5.0	4.1	56.5	13.67	53.5	12.86	50.2	12.28	48.5	11.82	46.8	11.35	43.8	10.60
	7.0	6	56.5	13.39	53.5	12.54	50.2	11.96	48.5	11.49	46.8	11.02	43.8	10.25
	9.0	7.9	56.5	11.95	53.5	11.19	50.2	10.67	48.5	10.25	46.8	9.84	43.8	9.15
	11.0	9.8	56.5	11.16	53.5	10.46	50.2	9.97	48.5	9.58	46.8	9.18	43.8	8.55
13.0	11.8	56.5	10.46	53.5	9.79	50.2	9.34	48.5	8.97	46.8	8.60	43.8	8.00	
15.0	13.7	56.5	9.88	53.5	9.25	50.2	8.82	48.5	8.48	46.8	8.13	43.8	7.57	
50	-19.8	-20	47.2	15.36	44.5	14.82	41.8	14.31	40.5	13.81	39.2	13.33	36.5	12.83
	-18.8	-19	47.2	15.19	44.5	14.64	41.8	14.15	40.5	13.64	39.2	13.17	36.5	12.66
	-16.7	-17	47.2	14.83	44.5	14.27	41.8	13.78	40.5	13.29	39.2	12.83	36.5	12.31
	-13.7	-15	47.2	14.32	44.5	13.75	41.8	13.27	40.5	12.77	39.2	12.34	36.5	11.81
	-11.8	-13	47.2	13.99	44.5	13.41	41.8	12.95	40.5	12.45	39.2	12.03	36.5	11.50
	-9.8	-11	47.2	13.66	44.5	13.06	41.8	12.61	40.5	12.11	39.2	11.71	36.5	11.16
	-9.5	-10	47.2	13.61	44.5	13.01	41.8	12.55	40.5	12.06	39.2	11.66	36.5	11.11
	-8.5	-9.1	47.2	13.43	44.5	12.83	41.8	12.39	40.5	11.89	39.2	11.50	36.5	10.95
	-7.0	-7.6	47.2	13.18	44.5	12.57	41.8	12.13	40.5	11.64	39.2	11.25	36.5	10.69
	-5.0	-5.6	47.2	12.85	44.5	12.22	41.8	11.79	40.5	11.29	39.2	10.92	36.5	10.36
	-3.0	-3.7	47.2	12.50	44.5	11.87	41.8	11.45	40.5	10.95	39.2	10.60	36.5	10.03
	0.0	-0.7	47.2	11.99	44.5	11.34	41.8	10.94	40.5	10.44	39.2	10.11	36.5	9.53
	3.0	2.2	47.2	11.48	44.5	10.81	41.8	10.43	40.5	9.94	39.2	9.62	36.5	9.03
	5.0	4.1	47.2	11.14	44.5	10.46	41.8	10.09	40.5	9.60	39.2	9.29	36.5	8.70
	7.0	6	47.2	10.81	44.5	10.11	41.8	9.74	40.5	9.25	39.2	8.97	36.5	8.37
	9.0	7.9	47.2	9.76	44.5	9.13	41.8	8.80	40.5	8.36	39.2	8.10	36.5	7.55
	11.0	9.8	47.2	9.13	44.5	8.55	41.8	8.23	40.5	7.82	39.2	7.58	36.5	7.07
13.0	11.8	47.2	8.57	44.5	8.02	41.8	7.73	40.5	7.34	39.2	7.11	36.5	6.64	
15.0	13.7	47.2	8.11	44.5	7.59	41.8	7.31	40.5	6.95	39.2	6.73	36.5	6.29	

Note

1. TC: Total Capacity(kW), PI: Power Input(kW, Comp. + Outdoor fan motor)
2. Capacity tables show the average value of conditions which may occur.
3. In the range beyond the operation limit of the outdoor unit, continuous operation and performance can not be guaranteed. When selecting the outdoor units, avoid the air temperature range that is not guaranteed continuous operation.

7. Capacity Tables

◆ A(C)RUN320LLS5

Combination (%)	Outdoor air temp.		Indoor air temp. °C DB											
			16		18		20		21		22		24	
	°C DB	°C WB	TC	PI	TC	PI	TC	PI	TC	PI	TC	PI	TC	PI
130	-19.8	-20	51.8	20.81	51.8	21.61	51.5	22.31	51.5	23.38	51.5	24.40	51.5	26.01
	-18.8	-19	54.4	21.35	54.4	22.15	54.0	22.84	54.0	23.92	54.0	24.94	54.0	26.55
	-16.7	-17	59.7	22.47	59.7	23.28	59.3	23.98	59.3	25.05	59.3	26.06	59.3	27.67
	-13.7	-15	67.2	24.08	67.2	24.89	66.8	25.59	66.8	26.66	66.8	27.67	66.8	27.36
	-11.8	-13	71.0	25.10	71.0	25.90	70.5	26.60	70.5	27.67	70.5	27.52	70.5	27.16
	-9.8	-11	75.0	26.17	75.0	26.97	74.5	27.67	74.5	27.58	74.5	27.36	74.5	26.96
	-9.5	-10	76.8	26.33	76.8	27.13	76.3	27.67	76.3	27.57	75.1	27.34	75.1	26.93
	-8.5	-9.1	82.7	26.87	82.7	27.67	82.2	27.67	82.2	27.52	77.1	27.26	77.1	26.82
	-7.0	-7.6	91.7	27.67	91.7	27.75	91.1	27.66	91.1	27.45	91.1	27.13	83.6	26.67
	-5.0	-5.6	103.6	27.91	103.6	27.85	102.9	27.65	102.9	27.36	102.9	26.97	88.6	26.46
	-3.0	-3.7	115.6	28.16	115.6	27.94	114.8	27.65	112.6	27.26	108.6	26.81	93.6	26.27
	0.0	-0.7	115.8	28.53	115.8	28.09	115.5	27.64	112.6	27.13	108.6	26.58	101.1	25.96
	3.0	2.2	115.8	28.89	115.8	28.24	115.5	27.62	112.6	26.99	108.6	26.33	101.1	25.65
	5.0	4.1	115.8	29.14	115.8	28.34	115.5	27.62	112.6	26.90	108.6	26.17	101.1	25.44
	7.0	6	115.8	29.38	115.8	28.44	115.5	27.62	112.6	26.81	108.6	26.01	101.1	25.23
	9.0	7.9	115.8	29.67	115.8	28.71	115.5	27.88	112.6	27.07	108.6	26.27	101.1	25.47
	11.0	9.8	115.8	30.26	115.8	29.28	115.5	28.42	112.6	27.60	108.6	26.78	101.1	25.98
13.0	11.8	115.8	30.83	115.8	29.84	115.5	28.97	112.6	28.13	108.6	27.29	101.1	26.47	
15.0	13.7	115.8	31.41	115.8	30.40	115.5	29.51	112.6	28.66	108.6	27.80	101.1	26.97	
120	-19.8	-20	51.5	21.61	51.5	22.31	51.2	23.38	51.2	24.40	51.2	26.01	51.2	27.13
	-18.8	-19	54.0	22.15	54.0	22.84	53.7	23.92	53.7	24.94	53.7	26.55	53.7	27.67
	-16.7	-17	59.3	23.28	59.3	23.98	58.9	25.05	58.9	26.06	58.9	27.67	58.9	27.47
	-13.7	-15	66.7	24.89	66.7	25.59	66.4	26.66	66.4	27.67	66.4	27.42	66.4	27.19
	-11.8	-13	70.5	25.90	70.5	26.60	70.1	27.67	70.1	27.51	70.1	27.26	70.1	27.00
	-9.8	-11	74.5	26.97	74.5	27.67	74.0	27.54	74.0	27.34	74.0	27.10	74.0	26.82
	-9.5	-10	76.2	27.13	76.2	27.66	75.8	27.52	75.8	27.32	75.8	27.07	75.8	26.79
	-8.5	-9.1	82.2	27.67	82.2	27.62	81.6	27.45	81.6	27.23	79.2	26.98	79.2	26.69
	-7.0	-7.6	91.0	27.68	91.0	27.55	90.4	27.36	90.4	27.11	83.0	26.85	83.0	26.55
	-5.0	-5.6	102.9	27.68	102.9	27.47	102.3	27.23	102.3	26.94	102.3	26.69	88.0	26.36
	-3.0	-3.7	113.6	27.68	113.6	27.39	109.1	27.10	105.6	26.77	102.3	26.53	93.0	26.17
	0.0	-0.7	114.9	27.70	113.6	27.26	109.1	26.89	105.6	26.51	102.3	26.27	95.0	25.89
	3.0	2.2	114.9	27.70	113.6	27.13	109.1	26.69	105.6	26.27	102.3	26.02	95.0	25.60
	5.0	4.1	114.9	27.70	113.6	27.05	109.1	26.56	105.6	26.09	102.3	25.85	95.0	25.41
	7.0	6	114.9	27.72	113.6	26.97	109.1	26.43	105.6	25.93	102.3	25.68	95.0	25.23
	9.0	7.9	114.9	27.85	113.6	27.10	109.1	26.56	105.6	26.06	102.3	25.81	95.0	25.34
	11.0	9.8	114.9	28.26	113.6	27.49	109.1	26.95	105.6	26.43	102.3	26.19	95.0	25.72
13.0	11.8	114.9	28.66	113.6	27.88	109.1	27.34	105.6	26.82	102.3	26.56	95.0	26.09	
15.0	13.7	114.9	29.07	113.6	28.27	109.1	27.72	105.6	27.18	102.3	26.93	95.0	26.45	
110	-19.8	-20	51.2	22.31	51.2	23.38	50.9	24.40	50.9	26.01	50.9	27.13	50.9	27.67
	-18.8	-19	53.7	22.84	53.7	23.92	53.4	24.94	53.4	26.55	53.4	27.67	53.4	27.52
	-16.7	-17	59.0	23.98	59.0	25.05	58.5	26.06	58.5	27.67	58.5	27.40	58.5	27.20
	-13.7	-15	66.4	25.59	66.4	26.66	66.0	27.67	66.0	27.29	66.0	27.01	66.0	26.74
	-11.8	-13	70.1	26.60	70.1	27.67	69.7	27.42	69.7	27.05	69.7	26.76	69.7	26.45
	-9.8	-11	74.0	27.67	74.0	27.41	73.6	27.16	73.6	26.79	73.6	26.51	73.6	26.14
	-9.5	-10	75.8	27.63	75.8	27.37	75.3	27.12	75.3	26.75	75.3	26.46	75.3	26.09
	-8.5	-9.1	81.7	27.52	81.7	27.24	81.2	26.98	81.2	26.62	79.0	26.33	79.0	25.94
	-7.0	-7.6	90.6	27.33	90.6	27.05	89.9	26.79	89.9	26.43	82.9	26.14	82.9	25.71
	-5.0	-5.6	98.6	27.08	98.6	26.79	97.9	26.53	94.7	26.17	86.8	25.88	85.5	25.41
	-3.0	-3.7	104.3	26.84	104.3	26.53	97.9	26.27	94.7	25.92	91.5	25.62	85.5	25.10
	0.0	-0.7	110.4	26.47	104.3	26.14	97.9	25.86	94.7	25.54	91.5	25.23	85.5	24.64
	3.0	2.2	110.4	26.10	104.3	25.75	97.9	25.47	94.7	25.15	91.5	24.84	85.5	24.19
	5.0	4.1	110.4	25.86	104.3	25.49	97.9	25.21	94.7	24.90	91.5	24.59	85.5	23.88
	7.0	6	110.4	25.62	104.3	25.23	97.9	24.95	94.7	24.64	91.5	24.33	85.5	23.57
	9.0	7.9	110.4	25.60	104.3	25.21	97.9	24.93	94.7	24.63	91.5	24.31	85.5	23.55
	11.0	9.8	110.4	25.83	104.3	25.44	97.9	25.15	94.7	24.84	91.5	24.53	85.5	23.77
13.0	11.8	110.4	26.04	104.3	25.65	97.9	25.36	94.7	25.05	91.5	24.74	85.5	23.97	
15.0	13.7	110.4	26.25	104.3	25.85	97.9	25.57	94.7	25.26	91.5	24.93	85.5	24.16	

Note

1. TC: Total Capacity(kW), PI: Power Input(kW, Comp. + Outdoor fan motor)
2. Capacity tables show the average value of conditions which may occur.
3. In the range beyond the operation limit of the outdoor unit, continuous operation and performance can not be guaranteed. When selecting the outdoor units, avoid the air temperature range that is not guaranteed continuous operation.

7. Capacity Tables

Combination (%)		Heating Capacity (32HP)												
		Outdoor air temp.		Indoor air temp. °C DB										
		°C DB	°C WB	16		18		20		21		22		24
		TC	PI	TC	PI	TC	PI	TC	PI	TC	PI	TC	PI	
100	-19.8	-20	51.0	23.22	51.0	24.11	50.7	24.87	50.7	26.29	50.7	27.29	50.7	27.67
	-18.8	-19	53.4	23.67	53.1	24.56	53.1	25.41	53.1	26.74	53.1	27.67	53.1	27.41
	-16.7	-17	58.4	24.60	58.4	25.49	58.4	26.53	58.0	27.67	58.0	27.18	58.0	26.87
	-13.7	-15	66.1	25.93	66.1	26.82	65.7	27.67	65.7	27.03	65.7	26.48	65.7	26.10
	-11.8	-13	69.7	26.79	69.4	27.67	69.4	27.29	69.4	26.62	69.4	26.02	69.4	25.62
	-9.8	-11	73.7	27.67	73.7	27.28	73.2	26.90	73.2	26.19	73.2	25.55	73.2	25.10
	-9.5	-10	75.3	27.62	75.3	27.23	75.0	26.85	75.0	26.12	75.0	25.49	75.0	25.02
	-8.5	-9.1	81.2	27.45	81.2	27.03	80.9	26.64	86.7	25.91	83.8	25.24	78.1	24.77
	-7.0	-7.6	91.5	27.19	91.2	26.74	89.6	26.35	86.7	25.59	83.8	24.90	78.1	24.38
	-5.0	-5.6	95.5	26.85	94.6	26.35	89.6	25.96	86.7	25.16	83.8	24.43	78.1	23.86
	-3.0	-3.7	98.3	26.51	95.4	25.96	89.6	25.57	86.7	24.72	83.8	23.96	78.1	23.35
	0.0	-0.7	101.1	25.99	95.4	25.38	89.6	24.98	86.7	24.09	83.8	23.24	78.1	22.58
	3.0	2.2	101.1	25.48	95.4	24.79	89.6	24.38	86.7	23.44	83.8	22.54	78.1	21.81
	5.0	4.1	101.1	25.14	95.4	24.41	89.6	23.99	86.7	23.01	83.8	22.07	78.1	21.29
	7.0	6	101.1	24.79	95.4	24.02	89.6	23.60	86.7	22.58	83.8	21.60	78.1	20.78
	9.0	7.9	101.1	24.45	95.4	23.68	89.6	23.27	86.7	22.27	83.8	21.30	78.1	20.49
	11.0	9.8	101.1	24.33	95.4	23.57	89.6	23.16	86.7	22.16	83.8	21.21	78.1	20.39
	13.0	11.8	101.1	24.19	95.4	23.44	89.6	23.03	86.7	22.03	83.8	21.08	78.1	20.27
15.0	13.7	101.1	24.03	95.4	23.28	89.6	22.87	86.7	21.88	83.8	20.93	78.1	20.14	
90	-19.8	-20	50.8	21.88	50.8	23.49	50.5	24.61	50.5	25.15	50.5	24.79	50.5	24.17
	-18.8	-19	53.4	22.42	53.1	24.03	52.9	25.15	52.9	24.98	52.9	24.61	52.9	23.97
	-16.7	-17	58.4	23.54	58.4	25.15	58.1	24.84	58.1	24.63	58.1	24.25	58.1	23.55
	-13.7	-15	66.1	25.15	66.1	24.74	65.4	24.40	65.4	24.12	65.4	23.71	65.4	22.97
	-11.8	-13	69.7	24.92	69.4	24.49	69.1	24.12	69.1	23.81	69.1	23.37	69.1	22.59
	-9.8	-11	73.7	24.68	73.7	24.22	72.9	23.83	72.9	23.47	72.9	23.02	67.0	22.20
	-9.5	-10	75.3	24.64	75.3	24.18	74.7	23.79	74.7	23.42	74.7	22.97	68.6	22.14
	-8.5	-9.1	81.2	24.53	80.7	24.05	80.5	23.65	79.4	23.26	76.9	22.79	71.4	21.94
	-7.0	-7.6	91.5	24.35	87.1	23.85	81.9	23.42	79.4	23.00	76.9	22.52	71.4	21.65
	-5.0	-5.6	92.5	24.10	87.1	23.58	81.9	23.13	79.4	22.66	76.9	22.17	71.4	21.25
	-3.0	-3.7	92.5	23.86	87.1	23.31	81.9	22.84	79.4	22.33	76.9	21.81	71.4	20.86
	0.0	-0.7	92.5	23.50	87.1	22.90	81.9	22.40	79.4	21.82	76.9	21.27	71.4	20.26
	3.0	2.2	92.5	23.14	87.1	22.50	81.9	21.96	79.4	21.32	76.9	20.74	71.4	19.68
	5.0	4.1	92.5	22.90	87.1	22.23	81.9	21.66	79.4	20.98	76.9	20.39	71.4	19.29
	7.0	6	92.5	22.66	87.1	21.96	81.9	21.37	79.4	20.64	76.9	20.03	71.4	18.89
	9.0	7.9	92.5	22.35	87.1	21.66	81.9	21.08	79.4	20.36	76.9	19.76	71.4	18.63
	11.0	9.8	92.5	22.04	87.1	21.36	81.9	20.79	79.4	20.08	76.9	19.48	71.4	18.37
	13.0	11.8	92.5	21.73	87.1	21.06	81.9	20.49	79.4	19.79	76.9	19.21	71.4	18.11
15.0	13.7	92.5	21.42	87.1	20.75	81.9	20.20	79.4	19.51	76.9	18.93	71.4	17.85	
80	-19.8	-20	50.2	19.03	50.2	20.64	50.2	22.30	50.2	21.96	50.2	21.45	50.2	20.90
	-18.8	-19	52.7	19.57	52.7	22.30	52.7	22.15	52.7	21.79	52.7	21.27	52.7	20.72
	-16.7	-17	58.1	22.30	58.1	22.01	58.1	21.83	58.1	21.44	58.1	20.92	58.1	20.34
	-13.7	-15	68.5	21.92	67.0	21.60	65.4	21.37	65.4	20.93	65.4	20.40	63.8	19.81
	-11.8	-13	74.0	21.68	71.8	21.34	69.1	21.08	69.1	20.61	68.6	20.07	63.8	19.46
	-9.8	-11	76.3	21.43	74.0	21.06	72.9	20.77	71.2	20.28	68.6	19.73	63.8	19.11
	-9.5	-10	76.8	21.39	74.6	21.01	73.3	20.72	71.2	20.22	68.6	19.68	63.8	19.05
	-8.5	-9.1	79.7	21.26	78.1	20.88	73.3	20.57	71.2	20.05	68.6	19.51	63.8	18.87
	-7.0	-7.6	82.9	21.08	78.1	20.67	73.3	20.33	71.2	19.79	68.6	19.25	63.8	18.60
	-5.0	-5.6	82.9	20.82	78.1	20.40	73.3	20.03	71.2	19.46	68.6	18.91	63.8	18.24
	-3.0	-3.7	82.9	20.57	78.1	20.12	73.3	19.72	71.2	19.12	68.6	18.57	63.8	17.89
	0.0	-0.7	82.9	20.18	78.1	19.71	73.3	19.26	71.2	18.62	68.6	18.05	63.8	17.35
	3.0	2.2	82.9	19.81	78.1	19.29	73.3	18.80	71.2	18.11	68.6	17.54	63.8	16.81
	5.0	4.1	82.9	19.55	78.1	19.01	73.3	18.49	71.2	17.77	68.6	17.20	63.8	16.45
	7.0	6	82.9	19.30	78.1	18.74	73.3	18.18	71.2	17.43	68.6	16.86	63.8	16.10
	9.0	7.9	82.9	18.12	78.1	17.59	73.3	17.07	71.2	16.37	68.6	15.83	63.8	15.12
	11.0	9.8	82.9	16.82	78.1	16.33	73.3	15.85	71.2	15.19	68.6	14.69	63.8	14.03
	13.0	11.8	82.9	15.70	78.1	15.25	73.3	14.79	71.2	14.18	68.6	13.72	63.8	13.10
15.0	13.7	82.9	14.78	78.1	14.35	73.3	13.93	71.2	13.35	68.6	12.91	63.8	12.32	

Note

1. TC: Total Capacity(kW), PI: Power Input(kW, Comp. + Outdoor fan motor)
2. Capacity tables show the average value of conditions which may occur.
3. In the range beyond the operation limit of the outdoor unit, continuous operation and performance can not be guaranteed. When selecting the outdoor units, avoid the air temperature range that is not guaranteed continuous operation.

7. Capacity Tables

Combination (%)		Heating Capacity (32HP)												
		Outdoor air temp.		Indoor air temp. °C DB										
		°C DB	°C WB	16		18		20		21		22		24
		TC	PI	TC	PI	TC	PI	TC	PI	TC	PI	TC	PI	
70	-19.8	-20	50.2	20.16	50.2	20.69	50.2	20.34	50.2	19.78	50.2	19.24	50.2	18.66
	-18.8	-19	52.7	20.69	52.7	20.53	52.7	20.17	52.7	19.60	52.7	19.06	52.7	18.47
	-16.7	-17	58.1	20.38	58.1	20.17	58.1	19.79	58.1	19.21	58.1	18.69	58.1	18.07
	-13.7	-15	70.3	19.93	66.4	19.65	62.4	19.26	60.3	18.67	58.5	18.15	54.6	17.50
	-11.8	-13	70.3	19.63	66.4	19.34	62.4	18.92	60.3	18.32	58.5	17.81	54.6	17.14
	-9.8	-11	70.3	19.34	66.4	18.99	62.4	18.57	60.3	17.95	58.5	17.45	54.6	16.76
	-9.5	-10	70.3	19.29	66.4	18.94	62.4	18.51	60.3	17.90	58.5	17.40	54.6	16.70
	-8.5	-9.1	70.3	19.14	66.4	18.77	62.4	18.34	60.3	17.71	58.5	17.22	54.6	16.52
	-7.0	-7.6	70.3	18.92	66.4	18.51	62.4	18.07	60.3	17.45	58.5	16.95	54.6	16.23
	-5.0	-5.6	70.3	18.62	66.4	18.18	62.4	17.71	60.3	17.08	58.5	16.59	54.6	15.85
	-3.0	-3.7	70.3	18.31	66.4	17.84	62.4	17.37	60.3	16.71	58.5	16.23	54.6	15.47
	0.0	-0.7	70.3	17.86	66.4	17.32	62.4	16.83	60.3	16.16	58.5	15.69	54.6	14.90
	3.0	2.2	70.3	17.41	66.4	16.81	62.4	16.30	60.3	15.61	58.5	15.15	54.6	14.34
	5.0	4.1	70.3	17.11	66.4	16.47	62.4	15.95	60.3	15.25	58.5	14.80	54.6	13.95
	7.0	6	70.3	16.81	66.4	16.13	62.4	15.59	60.3	14.89	58.5	14.44	54.6	13.57
	9.0	7.9	70.3	15.17	66.4	14.57	62.4	14.08	60.3	13.44	58.5	13.04	54.6	12.26
	11.0	9.8	70.3	14.13	66.4	13.56	62.4	13.10	60.3	12.52	58.5	12.14	54.6	11.41
	13.0	11.8	70.3	13.22	66.4	12.69	62.4	12.27	60.3	11.71	58.5	11.36	54.6	10.88
15.0	13.7	70.3	12.47	66.4	11.96	62.4	11.56	60.3	11.04	58.5	10.71	54.6	10.06	
60	-19.8	-20	60.3	19.08	57.1	18.73	50.2	18.18	50.2	17.63	49.9	17.10	46.7	16.51
	-18.8	-19	60.3	18.93	57.1	18.55	52.7	17.99	51.7	17.45	49.9	16.92	46.7	16.32
	-16.7	-17	60.3	18.61	57.1	18.18	53.5	17.62	51.7	17.08	49.9	16.54	46.7	15.92
	-13.7	-15	60.3	18.14	57.1	17.65	53.5	17.08	51.7	16.54	49.9	16.00	46.7	15.35
	-11.8	-13	60.3	17.84	57.1	17.31	53.5	16.72	51.7	16.20	49.9	15.66	46.7	14.99
	-9.8	-11	60.3	17.53	57.1	16.95	53.5	16.36	51.7	15.83	49.9	15.30	46.7	14.60
	-9.5	-10	60.3	17.48	57.1	16.90	53.5	16.31	51.7	15.78	49.9	15.24	46.7	14.55
	-8.5	-9.1	60.3	17.32	57.1	16.72	53.5	16.13	51.7	15.60	49.9	15.06	46.7	14.36
	-7.0	-7.6	60.3	17.09	57.1	16.46	53.5	15.86	51.7	15.32	49.9	14.80	46.7	14.08
	-5.0	-5.6	60.3	16.78	57.1	16.10	53.5	15.50	51.7	14.96	49.9	14.44	46.7	13.69
	-3.0	-3.7	60.3	16.47	57.1	15.74	53.5	15.12	51.7	14.60	49.9	14.08	46.7	13.32
	0.0	-0.7	60.3	16.00	57.1	15.21	53.5	14.58	51.7	14.06	49.9	13.53	46.7	12.74
	3.0	2.2	60.3	15.53	57.1	14.68	53.5	14.04	51.7	13.52	49.9	12.99	46.7	12.17
	5.0	4.1	60.3	15.22	57.1	14.32	53.5	13.67	51.7	13.15	49.9	12.63	46.7	11.80
	7.0	6	60.3	14.91	57.1	13.96	53.5	13.31	51.7	12.79	49.9	12.27	46.7	11.41
	9.0	7.9	60.3	13.30	57.1	12.46	53.5	11.88	51.7	11.41	49.9	10.95	46.7	10.19
	11.0	9.8	60.3	12.42	57.1	11.64	53.5	11.09	51.7	10.66	49.9	10.22	46.7	9.51
	13.0	11.8	60.3	11.64	57.1	10.90	53.5	10.39	51.7	9.99	49.9	9.58	46.7	8.90
15.0	13.7	60.3	11.00	57.1	10.30	53.5	9.82	51.7	9.44	49.9	9.05	46.7	8.42	
50	-19.8	-20	50.3	17.10	47.5	16.50	44.6	15.94	43.2	15.37	41.8	14.85	38.9	14.28
	-18.8	-19	50.3	16.91	47.5	16.30	44.6	15.75	43.2	15.19	41.8	14.67	38.9	14.10
	-16.7	-17	50.3	16.51	47.5	15.89	44.6	15.35	43.2	14.79	41.8	14.28	38.9	13.71
	-13.7	-15	50.3	15.94	47.5	15.31	44.6	14.78	43.2	14.22	41.8	13.74	38.9	13.15
	-11.8	-13	50.3	15.58	47.5	14.93	44.6	14.42	43.2	13.86	41.8	13.40	38.9	12.80
	-9.8	-11	50.3	15.21	47.5	14.54	44.6	14.04	43.2	13.48	41.8	13.03	38.9	12.42
	-9.5	-10	50.3	15.15	47.5	14.49	44.6	13.98	43.2	13.43	41.8	12.98	38.9	12.37
	-8.5	-9.1	50.3	14.96	47.5	14.29	44.6	13.79	43.2	13.24	41.8	12.80	38.9	12.19
	-7.0	-7.6	50.3	14.67	47.5	14.00	44.6	13.51	43.2	12.96	41.8	12.52	38.9	11.91
	-5.0	-5.6	50.3	14.30	47.5	13.61	44.6	13.12	43.2	12.57	41.8	12.16	38.9	11.54
	-3.0	-3.7	50.3	13.92	47.5	13.22	44.6	12.75	43.2	12.19	41.8	11.80	38.9	11.17
	0.0	-0.7	50.3	13.35	47.5	12.63	44.6	12.18	43.2	11.62	41.8	11.25	38.9	10.61
	3.0	2.2	50.3	12.78	47.5	12.04	44.6	11.61	43.2	11.06	41.8	10.71	38.9	10.06
	5.0	4.1	50.3	12.40	47.5	11.65	44.6	11.23	43.2	10.68	41.8	10.35	38.9	9.68
	7.0	6	50.3	12.03	47.5	11.26	44.6	10.84	43.2	10.30	41.8	9.98	38.9	9.31
	9.0	7.9	50.3	10.86	47.5	10.17	44.6	9.80	43.2	9.31	41.8	9.02	38.9	8.41
	11.0	9.8	50.3	10.16	47.5	9.52	44.6	9.16	43.2	8.71	41.8	8.43	38.9	7.87
	13.0	11.8	50.3	9.54	47.5	8.93	44.6	8.61	43.2	8.17	41.8	7.92	38.9	7.39
15.0	13.7	50.3	9.03	47.5	8.45	44.6	8.14	43.2	7.73	41.8	7.50	38.9	7.00	

Note

1. TC: Total Capacity(kW), PI: Power Input(kW, Comp. + Outdoor fan motor)
2. Capacity tables show the average value of conditions which may occur.
3. In the range beyond the operation limit of the outdoor unit, continuous operation and performance can not be guaranteed. When selecting the outdoor units, avoid the air temperature range that is not guaranteed continuous operation.

7. Capacity Tables

◆ A(C)RUN340LLS5

Combination (%)	Outdoor air temp.		Indoor air temp. °C DB											
	°C DB	°C WB	16		18		20		21		22		24	
			TC	PI	TC	PI	TC	PI	TC	PI	TC	PI	TC	PI
130	-19.8	-20	55.0	23.71	55.0	24.63	54.7	25.42	54.7	26.65	54.7	27.81	54.7	29.65
	-18.8	-19	57.8	24.32	57.8	25.24	57.3	26.03	57.3	27.26	57.3	28.42	57.3	30.26
	-16.7	-17	63.4	25.61	63.4	26.53	63.0	27.32	63.0	28.54	63.0	29.71	63.0	31.54
	-13.7	-15	71.4	27.44	71.4	28.36	70.9	29.16	70.9	30.38	70.9	31.54	70.9	31.19
	-11.8	-13	75.4	28.61	75.4	29.52	74.9	30.32	74.9	31.54	74.9	31.37	74.9	30.96
	-9.8	-11	79.7	29.83	79.7	30.75	79.1	31.54	79.1	31.43	79.1	31.19	79.1	30.73
	-9.5	-10	81.6	30.01	81.6	30.93	81.1	31.54	81.1	31.42	79.8	31.16	79.8	30.69
	-8.5	-9.1	87.9	30.63	87.9	31.54	87.3	31.54	87.3	31.37	81.9	31.07	81.9	30.58
	-7.0	-7.6	97.4	31.54	97.4	31.63	96.8	31.53	96.8	31.29	96.8	30.93	88.8	30.40
	-5.0	-5.6	110.1	31.82	110.1	31.74	109.4	31.52	109.4	31.19	109.4	30.75	94.1	30.16
	-3.0	-3.7	122.8	32.10	122.8	31.85	122.0	31.51	119.6	31.08	115.4	30.57	99.4	29.94
	0.0	-0.7	123.0	32.52	123.0	32.02	122.7	31.51	119.6	30.92	115.4	30.29	107.4	29.58
	3.0	2.2	123.0	32.94	123.0	32.19	122.7	31.49	119.6	30.77	115.4	30.01	107.4	29.23
	5.0	4.1	123.0	33.22	123.0	32.30	122.7	31.48	119.6	30.66	115.4	29.83	107.4	29.00
	7.0	6	123.0	33.49	123.0	32.42	122.7	31.48	119.6	30.56	115.4	29.65	107.4	28.76
	9.0	7.9	123.0	33.82	123.0	32.73	122.7	31.78	119.6	30.86	115.4	29.94	107.4	29.04
	11.0	9.8	123.0	34.49	123.0	33.37	122.7	32.40	119.6	31.45	115.4	30.53	107.4	29.61
13.0	11.8	123.0	35.14	123.0	34.01	122.7	33.02	119.6	32.06	115.4	31.10	107.4	30.18	
15.0	13.7	123.0	35.80	123.0	34.65	122.7	33.64	119.6	32.66	115.4	31.69	107.4	30.74	
120	-19.8	-20	54.7	24.63	54.7	25.42	54.4	26.65	54.4	27.81	54.4	29.65	54.4	30.93
	-18.8	-19	57.3	25.24	57.3	26.03	57.0	27.26	57.0	28.42	57.0	30.26	57.0	31.54
	-16.7	-17	62.9	26.53	62.9	27.32	62.6	28.54	62.6	29.71	62.6	31.54	62.6	31.31
	-13.7	-15	70.9	28.36	70.9	29.16	70.5	30.38	70.5	31.54	70.5	31.25	70.5	30.99
	-11.8	-13	74.9	29.52	74.9	30.32	74.5	31.54	74.5	31.36	74.5	31.07	74.5	30.78
	-9.8	-11	79.1	30.75	79.1	31.54	78.6	31.39	78.6	31.17	78.6	30.89	78.6	30.57
	-9.5	-10	80.9	30.93	80.9	31.52	80.5	31.37	80.5	31.14	80.5	30.86	80.5	30.54
	-8.5	-9.1	87.3	31.54	87.3	31.48	86.7	31.29	86.7	31.04	84.2	30.75	84.2	30.43
	-7.0	-7.6	96.7	31.55	96.7	31.40	96.1	31.18	96.1	30.90	88.1	30.61	88.1	30.27
	-5.0	-5.6	109.3	31.55	109.3	31.31	108.7	31.03	108.7	30.71	108.7	30.42	93.4	30.04
	-3.0	-3.7	120.7	31.55	120.7	31.22	116.0	30.89	112.2	30.51	108.7	30.23	98.7	29.83
	0.0	-0.7	122.1	31.57	120.7	31.07	116.0	30.66	112.2	30.22	108.7	29.94	100.9	29.51
	3.0	2.2	122.1	31.58	120.7	30.92	116.0	30.43	112.2	29.94	108.7	29.65	100.9	29.18
	5.0	4.1	122.1	31.58	120.7	30.83	116.0	30.28	112.2	29.74	108.7	29.47	100.9	28.97
	7.0	6	122.1	31.59	120.7	30.74	116.0	30.13	112.2	29.55	108.7	29.27	100.9	28.75
	9.0	7.9	122.1	31.75	120.7	30.89	116.0	30.27	112.2	29.70	108.7	29.42	100.9	28.89
	11.0	9.8	122.1	32.21	120.7	31.34	116.0	30.72	112.2	30.13	108.7	29.85	100.9	29.32
13.0	11.8	122.1	32.67	120.7	31.78	116.0	31.16	112.2	30.56	108.7	30.27	100.9	29.74	
15.0	13.7	122.1	33.13	120.7	32.22	116.0	31.59	112.2	30.98	108.7	30.69	100.9	30.15	
110	-19.8	-20	54.4	25.42	54.4	26.65	54.1	27.81	54.1	29.65	54.1	30.93	54.1	31.54
	-18.8	-19	57.0	26.03	57.0	27.26	56.7	28.42	56.7	30.26	56.7	31.54	56.7	31.37
	-16.7	-17	62.6	27.32	62.6	28.54	62.1	29.71	62.1	31.54	62.1	31.23	62.1	31.01
	-13.7	-15	70.5	29.16	70.5	30.38	70.0	31.54	70.0	31.10	70.0	30.78	70.0	30.48
	-11.8	-13	74.5	30.32	74.5	31.54	74.0	31.26	74.0	30.83	74.0	30.51	74.0	30.15
	-9.8	-11	78.6	31.54	78.6	31.25	78.2	30.96	78.2	30.54	78.2	30.21	78.2	29.80
	-9.5	-10	80.5	31.50	80.5	31.20	80.0	30.92	80.0	30.49	80.0	30.16	80.0	29.75
	-8.5	-9.1	86.8	31.36	86.8	31.05	86.2	30.76	86.2	30.34	84.0	30.02	84.0	29.57
	-7.0	-7.6	96.2	31.15	96.2	30.83	95.6	30.54	95.6	30.13	88.1	29.80	88.1	29.31
	-5.0	-5.6	104.8	30.87	104.8	30.54	104.1	30.24	100.7	29.83	92.3	29.50	90.9	28.97
	-3.0	-3.7	110.9	30.59	110.9	30.24	104.1	29.94	100.7	29.54	97.3	29.21	90.9	28.61
	0.0	-0.7	117.3	30.18	110.9	29.80	104.1	29.48	100.7	29.11	97.3	28.76	90.9	28.09
	3.0	2.2	117.3	29.75	110.9	29.35	104.1	29.03	100.7	28.67	97.3	28.32	90.9	27.57
	5.0	4.1	117.3	29.47	110.9	29.05	104.1	28.73	100.7	28.38	97.3	28.02	90.9	27.22
	7.0	6	117.3	29.20	110.9	28.76	104.1	28.43	100.7	28.09	97.3	27.73	90.9	26.87
	9.0	7.9	117.3	29.18	110.9	28.74	104.1	28.41	100.7	28.07	97.3	27.71	90.9	26.85
	11.0	9.8	117.3	29.44	110.9	28.99	104.1	28.67	100.7	28.32	97.3	27.96	90.9	27.10
13.0	11.8	117.3	29.68	110.9	29.24	104.1	28.91	100.7	28.56	97.3	28.19	90.9	27.32	
15.0	13.7	117.3	29.92	110.9	29.47	104.1	29.14	100.7	28.79	97.3	28.41	90.9	27.54	

Note

1. TC: Total Capacity(kW), PI: Power Input(kW, Comp. + Outdoor fan motor)

2. Capacity tables show the average value of conditions which may occur.

3. In the range beyond the operation limit of the outdoor unit, continuous operation and performance can not be guaranteed. When selecting the outdoor units, avoid the air temperature range that is not guaranteed continuous operation.

7. Capacity Tables

Combination (%)		Heating Capacity (34HP)												
		Outdoor air temp.		Indoor air temp. °C DB										
		°C DB	°C WB	16		18		20		21		22		24
		TC	PI	TC	PI	TC	PI	TC	PI	TC	PI	TC	PI	
100	-19.8	-20	54.2	26.47	54.2	27.48	53.8	28.34	53.8	29.97	53.8	31.11	53.8	31.54
	-18.8	-19	56.8	26.97	56.4	27.99	56.4	28.96	56.4	30.48	56.4	31.54	56.4	31.25
	-16.7	-17	62.0	28.04	62.0	29.05	62.0	30.24	61.5	31.54	61.5	30.98	61.5	30.63
	-13.7	-15	70.2	29.56	70.2	30.57	69.8	31.54	69.8	30.81	69.8	30.18	69.8	29.75
	-11.8	-13	74.1	30.53	73.7	31.54	73.7	31.11	73.7	30.34	73.7	29.66	73.7	29.20
	-9.8	-11	78.2	31.54	78.2	31.10	77.8	30.67	77.8	29.85	77.8	29.13	77.8	28.61
	-9.5	-10	80.0	31.49	80.0	31.04	79.7	30.60	79.7	29.78	79.7	29.05	79.7	28.52
	-8.5	-9.1	86.3	31.29	86.3	30.81	85.9	30.37	92.1	29.53	89.1	28.78	83.0	28.23
	-7.0	-7.6	97.3	30.99	96.9	30.48	95.2	30.04	92.1	29.17	89.1	28.38	83.0	27.79
	-5.0	-5.6	101.5	30.60	100.5	30.04	95.2	29.59	92.1	28.68	89.1	27.84	83.0	27.20
	-3.0	-3.7	104.5	30.22	101.3	29.59	95.2	29.15	92.1	28.18	89.1	27.31	83.0	26.61
	0.0	-0.7	107.4	29.63	101.3	28.93	95.2	28.47	92.1	27.45	89.1	26.50	83.0	25.74
	3.0	2.2	107.4	29.04	101.3	28.26	95.2	27.79	92.1	26.72	89.1	25.69	83.0	24.86
	5.0	4.1	107.4	28.65	101.3	27.82	95.2	27.35	92.1	26.22	89.1	25.16	83.0	24.27
	7.0	6	107.4	28.26	101.3	27.37	95.2	26.90	92.1	25.74	89.1	24.62	83.0	23.68
	9.0	7.9	107.4	27.87	101.3	26.99	95.2	26.52	92.1	25.38	89.1	24.28	83.0	23.35
11.0	9.8	107.4	27.73	101.3	26.87	95.2	26.40	92.1	25.26	89.1	24.17	83.0	23.24	
13.0	11.8	107.4	27.58	101.3	26.71	95.2	26.25	92.1	25.11	89.1	24.03	83.0	23.11	
15.0	13.7	107.4	27.39	101.3	26.53	95.2	26.07	92.1	24.94	89.1	23.86	83.0	22.95	
90	-19.8	-20	53.9	24.93	53.9	26.77	53.6	28.05	53.6	28.67	53.6	28.26	53.6	27.55
	-18.8	-19	56.8	25.55	56.4	27.39	56.2	28.67	56.2	28.47	56.2	28.06	56.2	27.32
	-16.7	-17	62.0	26.83	62.0	28.67	61.7	28.32	61.7	28.08	61.7	27.64	61.7	26.85
	-13.7	-15	70.2	28.67	70.2	28.21	69.5	27.82	69.5	27.50	69.5	27.02	69.5	26.18
	-11.8	-13	74.1	28.41	73.7	27.91	73.4	27.50	73.4	27.14	73.4	26.64	73.4	25.75
	-9.8	-11	78.2	28.14	78.2	27.61	77.5	27.17	77.5	26.75	77.5	26.24	71.2	25.30
	-9.5	-10	80.0	28.09	80.0	27.56	79.4	27.11	79.4	26.69	79.4	26.18	72.9	25.24
	-8.5	-9.1	86.3	27.96	85.7	27.41	85.6	26.95	84.4	26.51	81.7	25.98	75.9	25.01
	-7.0	-7.6	97.3	27.75	92.6	27.19	87.1	26.70	84.4	26.22	81.7	25.67	75.9	24.68
	-5.0	-5.6	98.3	27.47	92.6	26.87	87.1	26.37	84.4	25.83	81.7	25.27	75.9	24.22
	-3.0	-3.7	98.3	27.20	92.6	26.57	87.1	26.04	84.4	25.45	81.7	24.86	75.9	23.77
	0.0	-0.7	98.3	26.79	92.6	26.11	87.1	25.53	84.4	24.87	81.7	24.25	75.9	23.10
	3.0	2.2	98.3	26.37	92.6	25.65	87.1	25.03	84.4	24.30	81.7	23.64	75.9	22.43
	5.0	4.1	98.3	26.10	92.6	25.34	87.1	24.69	84.4	23.91	81.7	23.24	75.9	21.98
	7.0	6	98.3	25.83	92.6	25.04	87.1	24.36	84.4	23.53	81.7	22.83	75.9	21.53
	9.0	7.9	98.3	25.48	92.6	24.69	87.1	24.03	84.4	23.21	81.7	22.52	75.9	21.23
11.0	9.8	98.3	25.12	92.6	24.35	87.1	23.70	84.4	22.88	81.7	22.20	75.9	20.94	
13.0	11.8	98.3	24.77	92.6	24.00	87.1	23.36	84.4	22.56	81.7	21.90	75.9	20.64	
15.0	13.7	98.3	24.41	92.6	23.66	87.1	23.03	84.4	22.24	81.7	21.58	75.9	20.35	
80	-19.8	-20	53.4	21.69	53.4	23.52	53.4	25.42	53.4	25.04	53.4	24.45	53.4	23.82
	-18.8	-19	55.9	22.30	55.9	25.42	55.9	25.25	55.9	24.84	55.9	24.25	55.9	23.61
	-16.7	-17	61.7	25.42	61.7	25.09	61.7	24.88	61.7	24.44	61.7	23.85	61.7	23.18
	-13.7	-15	72.7	24.99	71.2	24.62	69.5	24.36	69.5	23.86	69.5	23.26	67.8	22.58
	-11.8	-13	78.6	24.71	76.3	24.32	73.4	24.02	73.4	23.50	72.8	22.88	67.8	22.18
	-9.8	-11	81.1	24.42	78.6	24.00	77.5	23.67	75.6	23.11	72.8	22.49	67.8	21.78
	-9.5	-10	81.6	24.38	79.2	23.95	77.9	23.62	75.6	23.05	72.8	22.44	67.8	21.72
	-8.5	-9.1	84.7	24.24	83.0	23.80	77.9	23.44	75.6	22.85	72.8	22.24	67.8	21.51
	-7.0	-7.6	88.1	24.02	83.0	23.56	77.9	23.18	75.6	22.56	72.8	21.94	67.8	21.20
	-5.0	-5.6	88.1	23.73	83.0	23.25	77.9	22.83	75.6	22.18	72.8	21.55	67.8	20.79
	-3.0	-3.7	88.1	23.44	83.0	22.94	77.9	22.48	75.6	21.79	72.8	21.17	67.8	20.39
	0.0	-0.7	88.1	23.01	83.0	22.46	77.9	21.96	75.6	21.22	72.8	20.58	67.8	19.78
	3.0	2.2	88.1	22.58	83.0	21.99	77.9	21.43	75.6	20.64	72.8	19.99	67.8	19.16
	5.0	4.1	88.1	22.29	83.0	21.67	77.9	21.08	75.6	20.25	72.8	19.60	67.8	18.75
	7.0	6	88.1	22.00	83.0	21.36	77.9	20.73	75.6	19.87	72.8	19.21	67.8	18.35
	9.0	7.9	88.1	20.66	83.0	20.05	77.9	19.46	75.6	18.65	72.8	18.04	67.8	17.23
11.0	9.8	88.1	19.18	83.0	18.62	77.9	18.06	75.6	17.32	72.8	16.74	67.8	15.99	
13.0	11.8	88.1	17.89	83.0	17.38	77.9	16.86	75.6	16.16	72.8	15.63	67.8	14.93	
15.0	13.7	88.1	16.85	83.0	16.35	77.9	15.87	75.6	15.22	72.8	14.72	67.8	14.05	

Note

1. TC: Total Capacity(kW), PI : Power Input(kW, Comp. + Outdoor fan motor)
2. Capacity tables show the average value of conditions which may occur.
3. In the range beyond the operation limit of the outdoor unit, continuous operation and performance can not be guaranteed. When selecting the outdoor units, avoid the air temperature range that is not guaranteed continuous operation.

7. Capacity Tables

Combination (%)		Heating Capacity (34HP)												
		Outdoor air temp.		Indoor air temp. °C DB										
		°C DB	°C WB	16		18		20		21		22		24
		TC	PI	TC	PI	TC	PI	TC	PI	TC	PI	TC	PI	
70	-19.8	-20	53.4	22.98	53.4	23.58	53.4	23.19	53.4	22.55	53.4	21.93	53.4	21.27
	-18.8	-19	55.9	23.58	55.9	23.40	55.9	22.98	55.9	22.34	55.9	21.73	55.9	21.05
	-16.7	-17	61.7	23.23	61.7	22.99	61.7	22.55	61.7	21.90	61.7	21.30	58.0	20.60
	-13.7	-15	74.7	22.71	70.5	22.40	66.3	21.95	64.0	21.28	62.1	20.69	58.0	19.95
	-11.8	-13	74.7	22.38	70.5	22.04	66.3	21.57	64.0	20.88	62.1	20.30	58.0	19.54
	-9.8	-11	74.7	22.04	70.5	21.64	66.3	21.16	64.0	20.46	62.1	19.89	58.0	19.10
	-9.5	-10	74.7	21.99	70.5	21.58	66.3	21.10	64.0	20.40	62.1	19.83	58.0	19.04
	-8.5	-9.1	74.7	21.81	70.5	21.39	66.3	20.90	64.0	20.19	62.1	19.63	58.0	18.82
	-7.0	-7.6	74.7	21.56	70.5	21.10	66.3	20.60	64.0	19.88	62.1	19.32	58.0	18.50
	-5.0	-5.6	74.7	21.22	70.5	20.72	66.3	20.19	64.0	19.47	62.1	18.91	58.0	18.06
	-3.0	-3.7	74.7	20.87	70.5	20.33	66.3	19.79	64.0	19.04	62.1	18.50	58.0	17.64
	0.0	-0.7	74.7	20.36	70.5	19.74	66.3	19.18	64.0	18.42	62.1	17.89	58.0	16.99
	3.0	2.2	74.7	19.84	70.5	19.16	66.3	18.58	64.0	17.80	62.1	17.27	58.0	16.34
	5.0	4.1	74.7	19.50	70.5	18.77	66.3	18.18	64.0	17.38	62.1	16.87	58.0	15.90
	7.0	6	74.7	19.16	70.5	18.39	66.3	17.77	64.0	16.97	62.1	16.46	58.0	15.47
	9.0	7.9	74.7	17.30	70.5	16.61	66.3	16.05	64.0	15.32	62.1	14.86	58.0	13.97
	11.0	9.8	74.7	16.11	70.5	15.46	66.3	14.94	64.0	14.27	62.1	13.83	58.0	13.01
	13.0	11.8	74.7	15.07	70.5	14.46	66.3	13.98	64.0	13.35	62.1	12.95	58.0	12.17
15.0	13.7	74.7	14.21	70.5	13.63	66.3	13.18	64.0	12.59	62.1	12.21	58.0	11.47	
60	-19.8	-20	64.0	21.75	60.6	21.35	53.4	20.71	53.4	20.10	53.0	19.49	49.6	18.82
	-18.8	-19	64.0	21.57	60.6	21.14	55.9	20.51	55.0	19.89	53.0	19.28	49.6	18.60
	-16.7	-17	64.0	21.20	60.6	20.71	56.9	20.08	55.0	19.46	53.0	18.85	49.6	18.14
	-13.7	-15	64.0	20.67	60.6	20.11	56.9	19.46	55.0	18.85	53.0	18.23	49.6	17.49
	-11.8	-13	64.0	20.33	60.6	19.73	56.9	19.06	55.0	18.46	53.0	17.85	49.6	17.08
	-9.8	-11	64.0	19.97	60.6	19.32	56.9	18.65	55.0	18.05	53.0	17.43	49.6	16.64
	-9.5	-10	64.0	19.92	60.6	19.26	56.9	18.59	55.0	17.98	53.0	17.37	49.6	16.58
	-8.5	-9.1	64.0	19.74	60.6	19.06	56.9	18.38	55.0	17.78	53.0	17.17	49.6	16.37
	-7.0	-7.6	64.0	19.48	60.6	18.76	56.9	18.07	55.0	17.46	53.0	16.87	49.6	16.04
	-5.0	-5.6	64.0	19.12	60.6	18.35	56.9	17.66	55.0	17.05	53.0	16.45	49.6	15.61
	-3.0	-3.7	64.0	18.77	60.6	17.94	56.9	17.24	55.0	16.64	53.0	16.04	49.6	15.18
	0.0	-0.7	64.0	18.24	60.6	17.34	56.9	16.62	55.0	16.02	53.0	15.43	49.6	14.52
	3.0	2.2	64.0	17.70	60.6	16.73	56.9	16.00	55.0	15.40	53.0	14.81	49.6	13.87
	5.0	4.1	64.0	17.35	60.6	16.32	56.9	15.58	55.0	14.99	53.0	14.40	49.6	13.44
	7.0	6	64.0	16.99	60.6	15.91	56.9	15.17	55.0	14.58	53.0	13.99	49.6	13.01
	9.0	7.9	64.0	15.16	60.6	14.20	56.9	13.54	55.0	13.01	53.0	12.48	49.6	11.61
	11.0	9.8	64.0	14.16	60.6	13.27	56.9	12.65	55.0	12.15	53.0	11.65	49.6	10.84
	13.0	11.8	64.0	13.27	60.6	12.42	56.9	11.85	55.0	11.38	53.0	10.92	49.6	10.15
15.0	13.7	64.0	12.53	60.6	11.74	56.9	11.20	55.0	10.76	53.0	10.32	49.6	9.60	
50	-19.8	-20	53.5	19.48	50.4	18.80	47.4	18.16	45.9	17.52	44.4	16.92	41.3	16.27
	-18.8	-19	53.5	19.27	50.4	18.58	47.4	17.95	45.9	17.30	44.4	16.71	41.3	16.06
	-16.7	-17	53.5	18.81	50.4	18.11	47.4	17.49	45.9	16.85	44.4	16.28	41.3	15.62
	-13.7	-15	53.5	18.17	50.4	17.45	47.4	16.84	45.9	16.21	44.4	15.66	41.3	14.98
	-11.8	-13	53.5	17.76	50.4	17.02	47.4	16.43	45.9	15.80	44.4	15.27	41.3	14.59
	-9.8	-11	53.5	17.33	50.4	16.57	47.4	16.00	45.9	15.36	44.4	14.85	41.3	14.16
	-9.5	-10	53.5	17.27	50.4	16.51	47.4	15.93	45.9	15.30	44.4	14.79	41.3	14.10
	-8.5	-9.1	53.5	17.05	50.4	16.28	47.4	15.72	45.9	15.09	44.4	14.59	41.3	13.89
	-7.0	-7.6	53.5	16.72	50.4	15.95	47.4	15.39	45.9	14.76	44.4	14.27	41.3	13.57
	-5.0	-5.6	53.5	16.30	50.4	15.51	47.4	14.96	45.9	14.33	44.4	13.86	41.3	13.15
	-3.0	-3.7	53.5	15.86	50.4	15.06	47.4	14.53	45.9	13.89	44.4	13.45	41.3	12.73
	0.0	-0.7	53.5	15.22	50.4	14.39	47.4	13.88	45.9	13.25	44.4	12.83	41.3	12.09
	3.0	2.2	53.5	14.57	50.4	13.72	47.4	13.23	45.9	12.61	44.4	12.21	41.3	11.46
	5.0	4.1	53.5	14.13	50.4	13.28	47.4	12.80	45.9	12.18	44.4	11.79	41.3	11.03
	7.0	6	53.5	13.71	50.4	12.83	47.4	12.36	45.9	11.74	44.4	11.38	41.3	10.62
	9.0	7.9	53.5	12.38	50.4	11.59	47.4	11.17	45.9	10.61	44.4	10.28	41.3	9.58
	11.0	9.8	53.5	11.58	50.4	10.85	47.4	10.44	45.9	9.93	44.4	9.61	41.3	8.97
	13.0	11.8	53.5	10.88	50.4	10.18	47.4	9.81	45.9	9.32	44.4	9.02	41.3	8.42
15.0	13.7	53.5	10.29	50.4	9.64	47.4	9.28	45.9	8.81	44.4	8.54	41.3	7.97	

Note

1. TC: Total Capacity(kW), PI: Power Input(kW, Comp. + Outdoor fan motor)
2. Capacity tables show the average value of conditions which may occur.
3. In the range beyond the operation limit of the outdoor unit, continuous operation and performance can not be guaranteed. When selecting the outdoor units, avoid the air temperature range that is not guaranteed continuous operation.

7. Capacity Tables

◆ A(C)RUN360LLS5

Combination (%)	Outdoor air temp.		Heating Capacity (36HP)											
			Indoor air temp. °C DB											
	°C DB	°C WB	16		18		20		21		22		24	
		TC	PI	TC	PI	TC	PI	TC	PI	TC	PI	TC	PI	
130	-19.8	-20	58.3	23.80	58.3	24.72	57.9	25.52	57.9	26.75	57.9	27.92	57.9	29.76
	-18.8	-19	61.1	24.42	61.1	25.34	60.7	26.13	60.7	27.37	60.7	28.53	60.7	30.38
	-16.7	-17	67.1	25.71	67.1	26.63	66.6	27.43	66.6	28.66	66.6	29.82	66.6	31.66
	-13.7	-15	75.6	27.55	75.6	28.47	75.1	29.27	75.1	30.50	75.1	31.66	75.1	31.31
	-11.8	-13	79.8	28.72	79.8	29.64	79.3	30.44	79.3	31.66	79.3	31.49	79.3	31.08
	-9.8	-11	84.3	29.94	84.3	30.86	83.7	31.66	83.7	31.55	83.7	31.31	83.7	30.84
	-9.5	-10	86.3	30.12	86.3	31.05	85.7	31.66	85.7	31.54	84.3	31.28	84.3	30.81
	-8.5	-9.1	93.0	30.74	93.0	31.66	92.4	31.66	92.4	31.49	86.6	31.19	86.6	30.69
	-7.0	-7.6	103.2	31.66	103.2	31.75	102.5	31.65	102.5	31.41	102.5	31.04	94.1	30.51
	-5.0	-5.6	116.7	31.94	116.7	31.86	115.9	31.64	115.9	31.31	115.9	30.86	99.7	30.28
	-3.0	-3.7	130.2	32.22	130.2	31.97	129.3	31.63	126.6	31.19	122.2	30.68	105.4	30.05
	0.0	-0.7	130.3	32.64	130.3	32.14	129.9	31.62	126.6	31.04	122.2	30.41	113.8	29.70
	3.0	2.2	130.3	33.06	130.3	32.31	129.9	31.61	126.6	30.88	122.2	30.12	113.8	29.34
	5.0	4.1	130.3	33.34	130.3	32.43	129.9	31.60	126.6	30.77	122.2	29.94	113.8	29.10
	7.0	6	130.3	33.62	130.3	32.54	129.9	31.59	126.6	30.67	122.2	29.76	113.8	28.87
	9.0	7.9	130.3	33.94	130.3	32.85	129.9	31.90	126.6	30.97	122.2	30.05	113.8	29.14
11.0	9.8	130.3	34.61	130.3	33.49	129.9	32.52	126.6	31.57	122.2	30.64	113.8	29.72	
13.0	11.8	130.3	35.27	130.3	34.14	129.9	33.14	126.6	32.18	122.2	31.22	113.8	30.29	
15.0	13.7	130.3	35.93	130.3	34.77	129.9	33.76	126.6	32.78	122.2	31.81	113.8	30.85	
120	-19.8	-20	57.9	24.72	57.9	25.52	57.5	26.75	57.5	27.92	57.5	29.76	57.5	31.05
	-18.8	-19	60.7	25.34	60.7	26.13	60.3	27.37	60.3	28.53	60.3	30.38	60.3	31.66
	-16.7	-17	66.6	26.63	66.6	27.43	66.2	28.66	66.2	29.82	66.2	31.66	66.2	31.43
	-13.7	-15	75.1	28.47	75.1	29.27	74.6	30.50	74.6	31.66	74.6	31.37	74.6	31.11
	-11.8	-13	79.2	29.64	79.2	30.44	78.8	31.66	78.8	31.48	78.8	31.19	78.8	30.90
	-9.8	-11	83.7	30.86	83.7	31.66	83.1	31.51	83.1	31.28	83.1	31.00	83.1	30.68
	-9.5	-10	85.6	31.05	85.6	31.64	85.1	31.49	85.1	31.25	85.1	30.97	85.1	30.65
	-8.5	-9.1	92.4	31.66	92.4	31.60	91.8	31.41	91.8	31.16	89.2	30.87	89.2	30.54
	-7.0	-7.6	102.4	31.67	102.4	31.52	101.7	31.30	101.7	31.01	93.4	30.72	93.4	30.38
	-5.0	-5.6	115.8	31.67	115.8	31.43	115.1	31.15	115.1	30.83	115.1	30.54	99.0	30.16
	-3.0	-3.7	127.8	31.67	127.8	31.33	122.8	31.00	118.8	30.63	115.1	30.35	104.7	29.94
	0.0	-0.7	129.3	31.69	127.8	31.19	122.8	30.77	118.8	30.33	115.1	30.06	106.8	29.62
	3.0	2.2	129.3	31.69	127.8	31.04	122.8	30.54	118.8	30.05	115.1	29.76	106.8	29.29
	5.0	4.1	129.3	31.70	127.8	30.95	122.8	30.39	118.8	29.85	115.1	29.58	106.8	29.08
	7.0	6	129.3	31.71	127.8	30.85	122.8	30.24	118.8	29.66	115.1	29.38	106.8	28.86
	9.0	7.9	129.3	31.86	127.8	31.00	122.8	30.39	118.8	29.81	115.1	29.52	106.8	29.00
11.0	9.8	129.3	32.33	127.8	31.45	122.8	30.83	118.8	30.24	115.1	29.96	106.8	29.43	
13.0	11.8	129.3	32.79	127.8	31.90	122.8	31.27	118.8	30.68	115.1	30.38	106.8	29.84	
15.0	13.7	129.3	33.25	127.8	32.34	122.8	31.71	118.8	31.10	115.1	30.80	106.8	30.26	
110	-19.8	-20	57.6	25.52	57.6	26.75	57.2	27.92	57.2	29.76	57.2	31.05	57.2	31.66
	-18.8	-19	60.3	26.13	60.3	27.37	60.0	28.53	60.0	30.38	60.0	31.66	60.0	31.49
	-16.7	-17	66.3	27.43	66.3	28.66	65.8	29.82	65.8	31.66	65.8	31.35	65.8	31.12
	-13.7	-15	74.7	29.27	74.7	30.50	74.2	31.66	74.2	31.22	74.2	30.90	74.2	30.60
	-11.8	-13	78.8	30.44	78.8	31.66	78.3	31.37	78.3	30.95	78.3	30.62	78.3	30.26
	-9.8	-11	83.2	31.66	83.2	31.37	82.7	31.07	82.7	30.65	82.7	30.33	82.7	29.91
	-9.5	-10	85.2	31.62	85.2	31.32	84.6	31.03	84.6	30.60	84.6	30.28	84.6	29.86
	-8.5	-9.1	91.8	31.48	91.8	31.17	91.2	30.87	91.2	30.46	88.8	30.13	88.8	29.68
	-7.0	-7.6	101.9	31.27	101.9	30.95	101.2	30.65	101.2	30.24	93.0	29.91	93.0	29.42
	-5.0	-5.6	110.9	30.99	110.9	30.65	110.2	30.35	106.6	29.95	97.4	29.61	96.2	29.07
	-3.0	-3.7	117.4	30.71	117.4	30.35	110.2	30.05	106.6	29.65	103.0	29.32	96.2	28.72
	0.0	-0.7	124.2	30.29	117.4	29.91	110.2	29.59	106.6	29.22	103.0	28.87	96.2	28.19
	3.0	2.2	124.2	29.86	117.4	29.46	110.2	29.14	106.6	28.78	103.0	28.42	96.2	27.68
	5.0	4.1	124.2	29.58	117.4	29.16	110.2	28.84	106.6	28.48	103.0	28.13	96.2	27.32
	7.0	6	124.2	29.31	117.4	28.87	110.2	28.54	106.6	28.19	103.0	27.83	96.2	26.97
	9.0	7.9	124.2	29.28	117.4	28.84	110.2	28.52	106.6	28.18	103.0	27.81	96.2	26.95
11.0	9.8	124.2	29.55	117.4	29.10	110.2	28.78	106.6	28.42	103.0	28.06	96.2	27.20	
13.0	11.8	124.2	29.79	117.4	29.34	110.2	29.02	106.6	28.66	103.0	28.30	96.2	27.42	
15.0	13.7	124.2	30.03	117.4	29.58	110.2	29.25	106.6	28.89	103.0	28.52	96.2	27.64	

Note

1. TC: Total Capacity(kW), PI : Power Input(kW, Comp. + Outdoor fan motor)
2. Capacity tables show the average value of conditions which may occur.
3. In the range beyond the operation limit of the outdoor unit, continuous operation and performance can not be guaranteed. When selecting the outdoor units, avoid the air temperature range that is not guaranteed continuous operation.

7. Capacity Tables

Combination (%)		Heating Capacity (36HP)												
		Outdoor air temp.		Indoor air temp. °C DB										
		°C DB	°C WB	16		18		20		21		22		24
		TC	PI	TC	PI	TC	PI	TC	PI	TC	PI	TC	PI	
100	-19.8	-20	57.3	26.57	57.3	27.59	57.0	28.45	57.0	30.09	57.0	31.22	57.0	31.66
	-18.8	-19	60.1	27.08	59.7	28.10	59.7	29.07	59.7	30.59	59.7	31.66	59.7	31.37
	-16.7	-17	65.6	28.15	65.6	29.17	65.6	30.36	65.2	31.66	65.2	31.10	65.2	30.75
	-13.7	-15	74.3	29.68	74.3	30.69	73.9	31.66	73.9	30.92	73.9	30.29	73.9	29.86
	-11.8	-13	78.4	30.65	78.0	31.66	78.0	31.23	78.0	30.45	78.0	29.77	78.0	29.31
	-9.8	-11	82.8	31.66	82.8	31.22	82.3	30.78	82.3	29.97	82.3	29.24	82.3	28.72
	-9.5	-10	84.7	31.61	84.7	31.15	84.3	30.72	84.3	29.89	84.3	29.16	84.3	28.63
	-8.5	-9.1	91.3	31.40	91.3	30.93	90.9	30.49	97.5	29.65	94.3	28.88	87.9	28.34
	-7.0	-7.6	103.0	31.11	102.6	30.60	100.8	30.15	97.5	29.28	94.3	28.49	87.9	27.89
	-5.0	-5.6	107.5	30.72	106.4	30.15	100.8	29.70	97.5	28.78	94.3	27.95	87.9	27.30
	-3.0	-3.7	110.6	30.33	107.3	29.70	100.8	29.25	97.5	28.29	94.3	27.41	87.9	26.71
	0.0	-0.7	113.7	29.74	107.3	29.04	100.8	28.58	97.5	27.56	94.3	26.60	87.9	25.84
	3.0	2.2	113.7	29.15	107.3	28.37	100.8	27.90	97.5	26.82	94.3	25.79	87.9	24.95
	5.0	4.1	113.7	28.76	107.3	27.92	100.8	27.45	97.5	26.32	94.3	25.25	87.9	24.36
	7.0	6	113.7	28.37	107.3	27.48	100.8	27.00	97.5	25.83	94.3	24.71	87.9	23.77
	9.0	7.9	113.7	27.98	107.3	27.09	100.8	26.62	97.5	25.48	94.3	24.37	87.9	23.44
	11.0	9.8	113.7	27.84	107.3	26.97	100.8	26.50	97.5	25.36	94.3	24.26	87.9	23.32
13.0	11.8	113.7	27.68	107.3	26.81	100.8	26.34	97.5	25.21	94.3	24.12	87.9	23.19	
15.0	13.7	113.7	27.49	107.3	26.63	100.8	26.17	97.5	25.03	94.3	23.95	87.9	23.04	
90	-19.8	-20	57.1	25.03	57.1	26.88	56.7	28.16	56.7	28.78	56.7	28.37	56.7	27.65
	-18.8	-19	60.1	25.65	59.7	27.49	59.5	28.78	59.5	28.58	59.5	28.17	59.5	27.42
	-16.7	-17	65.6	26.94	65.6	28.78	65.3	28.43	65.3	28.19	65.3	27.74	65.3	26.95
	-13.7	-15	74.3	28.78	74.3	28.31	73.6	27.92	73.6	27.60	73.6	27.13	73.6	26.28
	-11.8	-13	78.4	28.52	78.0	28.02	77.7	27.60	77.7	27.24	77.7	26.74	77.7	25.85
	-9.8	-11	82.8	28.24	82.8	27.72	82.0	27.27	82.0	26.85	82.0	26.34	75.3	25.40
	-9.5	-10	84.7	28.20	84.7	27.67	84.0	27.22	84.0	26.80	84.0	26.28	77.1	25.33
	-8.5	-9.1	91.3	28.07	90.7	27.51	90.6	27.06	89.4	26.61	86.5	26.08	80.4	25.10
	-7.0	-7.6	103.0	27.86	98.0	27.29	92.2	26.80	89.4	26.32	86.5	25.76	80.4	24.77
	-5.0	-5.6	104.1	27.58	98.0	26.98	92.2	26.47	89.4	25.93	86.5	25.36	80.4	24.31
	-3.0	-3.7	104.1	27.30	98.0	26.67	92.2	26.13	89.4	25.55	86.5	24.95	80.4	23.86
	0.0	-0.7	104.1	26.89	98.0	26.20	92.2	25.63	89.4	24.96	86.5	24.34	80.4	23.18
	3.0	2.2	104.1	26.47	98.0	25.75	92.2	25.13	89.4	24.39	86.5	23.73	80.4	22.51
	5.0	4.1	104.1	26.20	98.0	25.43	92.2	24.78	89.4	24.00	86.5	23.32	80.4	22.07
	7.0	6	104.1	25.93	98.0	25.13	92.2	24.45	89.4	23.62	86.5	22.91	80.4	21.61
	9.0	7.9	104.1	25.57	98.0	24.78	92.2	24.12	89.4	23.29	86.5	22.60	80.4	21.31
	11.0	9.8	104.1	25.22	98.0	24.44	92.2	23.79	89.4	22.97	86.5	22.29	80.4	21.01
13.0	11.8	104.1	24.86	98.0	24.09	92.2	23.44	89.4	22.64	86.5	21.98	80.4	20.72	
15.0	13.7	104.1	24.50	98.0	23.74	92.2	23.11	89.4	22.32	86.5	21.66	80.4	20.42	
80	-19.8	-20	56.5	21.77	56.5	23.61	56.5	25.52	56.5	25.13	56.5	24.54	56.5	23.91
	-18.8	-19	59.2	22.39	59.2	25.52	59.2	25.34	59.2	24.93	59.2	24.34	59.2	23.70
	-16.7	-17	65.3	25.52	65.3	25.19	65.3	24.98	65.3	24.53	65.3	23.94	65.3	23.27
	-13.7	-15	77.0	25.08	75.4	24.71	73.6	24.45	73.6	23.95	73.6	23.35	71.8	22.66
	-11.8	-13	83.2	24.81	80.8	24.42	77.7	24.12	77.7	23.59	77.1	22.97	71.8	22.26
	-9.8	-11	85.7	24.52	83.2	24.10	82.0	23.76	80.1	23.20	77.1	22.58	71.8	21.86
	-9.5	-10	86.4	24.48	83.9	24.04	82.5	23.71	80.1	23.14	77.1	22.52	71.8	21.80
	-8.5	-9.1	89.7	24.33	87.9	23.89	82.5	23.53	80.1	22.94	77.1	22.32	71.8	21.59
	-7.0	-7.6	93.3	24.12	87.9	23.65	82.5	23.27	80.1	22.65	77.1	22.03	71.8	21.28
	-5.0	-5.6	93.3	23.82	87.9	23.34	82.5	22.91	80.1	22.26	77.1	21.64	71.8	20.87
	-3.0	-3.7	93.3	23.53	87.9	23.02	82.5	22.56	80.1	21.87	77.1	21.25	71.8	20.47
	0.0	-0.7	93.3	23.09	87.9	22.55	82.5	22.04	80.1	21.30	77.1	20.66	71.8	19.85
	3.0	2.2	93.3	22.66	87.9	22.07	82.5	21.51	80.1	20.71	77.1	20.07	71.8	19.23
	5.0	4.1	93.3	22.37	87.9	21.75	82.5	21.16	80.1	20.33	77.1	19.68	71.8	18.82
	7.0	6	93.3	22.08	87.9	21.44	82.5	20.80	80.1	19.94	77.1	19.29	71.8	18.42
	9.0	7.9	93.3	20.74	87.9	20.13	82.5	19.53	80.1	18.72	77.1	18.11	71.8	17.29
	11.0	9.8	93.3	19.25	87.9	18.69	82.5	18.13	80.1	17.38	77.1	16.80	71.8	16.05
13.0	11.8	93.3	17.96	87.9	17.44	82.5	16.92	80.1	16.22	77.1	15.69	71.8	14.98	
15.0	13.7	93.3	16.91	87.9	16.41	82.5	15.93	80.1	15.27	77.1	14.77	71.8	14.10	

Note

1. TC: Total Capacity(kW), PI: Power Input(kW, Comp. + Outdoor fan motor)
2. Capacity tables show the average value of conditions which may occur.
3. In the range beyond the operation limit of the outdoor unit, continuous operation and performance can not be guaranteed. When selecting the outdoor units, avoid the air temperature range that is not guaranteed continuous operation.

7. Capacity Tables

Combination (%)		Heating Capacity (36HP)												
		Outdoor air temp.		Indoor air temp. °C DB										
		°C DB	°C WB	16		18		20		21		22		24
		TC	PI	TC	PI	TC	PI	TC	PI	TC	PI	TC	PI	
70	-19.8	-20	56.5	23.07	56.5	23.68	56.5	23.28	56.5	22.63	56.5	22.02	56.5	21.35
	-18.8	-19	59.2	23.68	59.2	23.49	59.2	23.07	59.2	22.42	59.2	21.81	59.2	21.13
	-16.7	-17	65.3	23.32	65.3	23.08	65.3	22.64	65.3	21.98	65.3	21.39	61.4	20.68
	-13.7	-15	79.1	22.80	74.7	22.49	70.2	22.04	67.8	21.36	65.8	20.77	61.4	20.02
	-11.8	-13	79.1	22.47	74.7	22.12	70.2	21.65	67.8	20.96	65.8	20.38	61.4	19.61
	-9.8	-11	79.1	22.13	74.7	21.72	70.2	21.24	67.8	20.54	65.8	19.97	61.4	19.17
	-9.5	-10	79.1	22.07	74.7	21.67	70.2	21.18	67.8	20.48	65.8	19.91	61.4	19.11
	-8.5	-9.1	79.1	21.90	74.7	21.48	70.2	20.98	67.8	20.27	65.8	19.70	61.4	18.90
	-7.0	-7.6	79.1	21.65	74.7	21.18	70.2	20.68	67.8	19.96	65.8	19.40	61.4	18.57
	-5.0	-5.6	79.1	21.30	74.7	20.79	70.2	20.27	67.8	19.54	65.8	18.98	61.4	18.13
	-3.0	-3.7	79.1	20.95	74.7	20.41	70.2	19.87	67.8	19.12	65.8	18.57	61.4	17.70
	0.0	-0.7	79.1	20.44	74.7	19.82	70.2	19.26	67.8	18.49	65.8	17.95	61.4	17.05
	3.0	2.2	79.1	19.91	74.7	19.23	70.2	18.65	67.8	17.86	65.8	17.33	61.4	16.40
	5.0	4.1	79.1	19.58	74.7	18.84	70.2	18.24	67.8	17.45	65.8	16.93	61.4	15.96
	7.0	6	79.1	19.23	74.7	18.46	70.2	17.84	67.8	17.03	65.8	16.52	61.4	15.52
	9.0	7.9	79.1	17.36	74.7	16.67	70.2	16.11	67.8	15.38	65.8	14.92	61.4	14.03
	11.0	9.8	79.1	16.17	74.7	15.52	70.2	14.99	67.8	14.32	65.8	13.89	61.4	13.06
13.0	11.8	79.1	15.13	74.7	14.51	70.2	14.03	67.8	13.40	65.8	12.99	61.4	12.22	
15.0	13.7	79.1	14.26	74.7	13.68	70.2	13.23	67.8	12.63	65.8	12.25	61.4	11.51	
60	-19.8	-20	67.8	21.83	64.2	21.43	56.5	20.79	56.5	20.17	56.2	19.57	52.5	18.89
	-18.8	-19	67.8	21.65	64.2	21.23	59.2	20.59	58.2	19.97	56.2	19.36	52.5	18.67
	-16.7	-17	67.8	21.29	64.2	20.79	60.2	20.16	58.2	19.54	56.2	18.92	52.5	18.21
	-13.7	-15	67.8	20.75	64.2	20.19	60.2	19.54	58.2	18.92	56.2	18.30	52.5	17.56
	-11.8	-13	67.8	20.41	64.2	19.80	60.2	19.13	58.2	18.53	56.2	17.91	52.5	17.15
	-9.8	-11	67.8	20.05	64.2	19.40	60.2	18.72	58.2	18.12	56.2	17.50	52.5	16.71
	-9.5	-10	67.8	20.00	64.2	19.33	60.2	18.66	58.2	18.05	56.2	17.44	52.5	16.64
	-8.5	-9.1	67.8	19.82	64.2	19.13	60.2	18.45	58.2	17.85	56.2	17.23	52.5	16.43
	-7.0	-7.6	67.8	19.55	64.2	18.83	60.2	18.14	58.2	17.53	56.2	16.93	52.5	16.10
	-5.0	-5.6	67.8	19.19	64.2	18.42	60.2	17.73	58.2	17.12	56.2	16.52	52.5	15.67
	-3.0	-3.7	67.8	18.84	64.2	18.01	60.2	17.30	58.2	16.70	56.2	16.10	52.5	15.24
	0.0	-0.7	67.8	18.30	64.2	17.40	60.2	16.68	58.2	16.08	56.2	15.48	52.5	14.58
	3.0	2.2	67.8	17.77	64.2	16.79	60.2	16.06	58.2	15.46	56.2	14.87	52.5	13.92
	5.0	4.1	67.8	17.41	64.2	16.38	60.2	15.64	58.2	15.05	56.2	14.45	52.5	13.49
	7.0	6	67.8	17.06	64.2	15.97	60.2	15.23	58.2	14.63	56.2	14.04	52.5	13.06
	9.0	7.9	67.8	15.22	64.2	14.25	60.2	13.59	58.2	13.06	56.2	12.53	52.5	11.65
	11.0	9.8	67.8	14.21	64.2	13.31	60.2	12.69	58.2	12.20	56.2	11.70	52.5	10.88
13.0	11.8	67.8	13.32	64.2	12.47	60.2	11.89	58.2	11.42	56.2	10.96	52.5	10.19	
15.0	13.7	67.8	12.58	64.2	11.78	60.2	11.24	58.2	10.80	56.2	10.36	52.5	9.64	
50	-19.8	-20	56.6	19.56	53.4	18.88	50.1	18.23	48.6	17.59	47.0	16.98	43.8	16.34
	-18.8	-19	56.6	19.35	53.4	18.65	50.1	18.02	48.6	17.37	47.0	16.78	43.8	16.13
	-16.7	-17	56.6	18.89	53.4	18.18	50.1	17.56	48.6	16.92	47.0	16.34	43.8	15.68
	-13.7	-15	56.6	18.24	53.4	17.51	50.1	16.91	48.6	16.27	47.0	15.72	43.8	15.04
	-11.8	-13	56.6	17.82	53.4	17.08	50.1	16.49	48.6	15.86	47.0	15.33	43.8	14.64
	-9.8	-11	56.6	17.40	53.4	16.64	50.1	16.06	48.6	15.42	47.0	14.91	43.8	14.21
	-9.5	-10	56.6	17.34	53.4	16.57	50.1	15.99	48.6	15.36	47.0	14.85	43.8	14.15
	-8.5	-9.1	56.6	17.11	53.4	16.35	50.1	15.78	48.6	15.15	47.0	14.64	43.8	13.94
	-7.0	-7.6	56.6	16.79	53.4	16.01	50.1	15.45	48.6	14.82	47.0	14.33	43.8	13.62
	-5.0	-5.6	56.6	16.36	53.4	15.57	50.1	15.01	48.6	14.38	47.0	13.91	43.8	13.20
	-3.0	-3.7	56.6	15.92	53.4	15.12	50.1	14.59	48.6	13.95	47.0	13.50	43.8	12.78
	0.0	-0.7	56.6	15.27	53.4	14.45	50.1	13.93	48.6	13.30	47.0	12.87	43.8	12.14
	3.0	2.2	56.6	14.62	53.4	13.77	50.1	13.28	48.6	12.66	47.0	12.25	43.8	11.51
	5.0	4.1	56.6	14.19	53.4	13.33	50.1	12.84	48.6	12.22	47.0	11.84	43.8	11.08
	7.0	6	56.6	13.76	53.4	12.88	50.1	12.41	48.6	11.78	47.0	11.42	43.8	10.65
	9.0	7.9	56.6	12.43	53.4	11.63	50.1	11.21	48.6	10.65	47.0	10.32	43.8	9.62
	11.0	9.8	56.6	11.63	53.4	10.89	50.1	10.48	48.6	9.96	47.0	9.65	43.8	9.00
13.0	11.8	56.6	10.92	53.4	10.22	50.1	9.85	48.6	9.35	47.0	9.06	43.8	8.46	
15.0	13.7	56.6	10.33	53.4	9.67	50.1	9.32	48.6	8.85	47.0	8.57	43.8	8.00	

Note

1. TC: Total Capacity(kW), PI: Power Input(kW, Comp. + Outdoor fan motor)
2. Capacity tables show the average value of conditions which may occur.
3. In the range beyond the operation limit of the outdoor unit, continuous operation and performance can not be guaranteed. When selecting the outdoor units, avoid the air temperature range that is not guaranteed continuous operation.

7. Capacity Tables

◆ A(C)RUN380LLS5

Combination (%)	Outdoor air temp.		Indoor air temp. °C DB											
	°C DB	°C WB	16		18		20		21		22		24	
			TC	PI	TC	PI	TC	PI	TC	PI	TC	PI	TC	PI
130	-19.8	-20	61.6	26.11	61.6	27.11	61.2	27.99	61.2	29.33	61.2	30.61	61.2	32.63
	-18.8	-19	64.6	26.78	64.6	27.79	64.1	28.66	64.1	30.01	64.1	31.28	64.1	33.30
	-16.7	-17	70.9	28.19	70.9	29.20	70.4	30.07	70.4	31.42	70.4	32.69	70.4	34.71
	-13.7	-15	79.8	30.21	79.8	31.22	79.3	32.09	79.3	33.43	79.3	34.71	79.3	34.32
	-11.8	-13	84.3	31.48	84.3	32.49	83.7	33.37	83.7	34.71	83.7	34.52	83.7	34.07
	-9.8	-11	89.0	32.83	89.0	33.83	88.4	34.71	88.4	34.59	88.4	34.32	88.4	33.81
	-9.5	-10	91.2	33.03	91.2	34.03	90.6	34.71	90.6	34.58	89.1	34.29	89.1	33.78
	-8.5	-9.1	98.2	33.70	98.2	34.71	97.6	34.71	97.6	34.52	91.5	34.19	91.5	33.65
	-7.0	-7.6	108.9	34.71	108.9	34.80	108.2	34.69	108.2	34.43	108.2	34.03	99.2	33.45
	-5.0	-5.6	123.1	35.01	123.1	34.93	122.2	34.68	122.2	34.32	122.2	33.83	105.1	33.19
	-3.0	-3.7	137.3	35.32	137.3	35.05	136.4	34.68	133.7	34.20	129.0	33.63	111.1	32.94
	0.0	-0.7	137.5	35.78	137.5	35.23	137.1	34.67	133.7	34.03	129.0	33.33	119.9	32.55
	3.0	2.2	137.5	36.24	137.5	35.42	137.1	34.65	133.7	33.86	129.0	33.02	120.1	32.17
	5.0	4.1	137.5	36.55	137.5	35.55	137.1	34.64	133.7	33.74	129.0	32.82	120.1	31.91
	7.0	6	137.5	36.86	137.5	35.67	137.1	34.64	133.7	33.63	129.0	32.62	120.1	31.65
	9.0	7.9	137.5	37.21	137.5	36.01	137.1	34.97	133.7	33.95	129.0	32.94	120.1	31.95
	11.0	9.8	137.5	37.95	137.5	36.72	137.1	35.65	133.7	34.61	129.0	33.59	120.1	32.58
13.0	11.8	137.5	38.67	137.5	37.43	137.1	36.33	133.7	35.28	129.0	34.22	120.1	33.20	
15.0	13.7	137.5	39.39	137.5	38.12	137.1	37.02	133.7	35.94	129.0	34.87	120.1	33.83	
120	-19.8	-20	61.2	27.11	61.2	27.99	60.8	29.33	60.8	30.61	60.8	32.63	60.8	34.03
	-18.8	-19	64.1	27.79	64.1	28.66	63.7	30.01	63.7	31.28	63.7	33.30	63.7	34.71
	-16.7	-17	70.3	29.20	70.3	30.07	69.9	31.42	69.9	32.69	69.9	34.71	69.9	34.46
	-13.7	-15	79.2	31.22	79.2	32.09	78.8	33.43	78.8	34.71	78.8	34.39	78.8	34.10
	-11.8	-13	83.7	32.49	83.7	33.37	83.2	34.71	83.2	34.51	83.2	34.19	83.2	33.87
	-9.8	-11	88.4	33.83	88.4	34.71	87.8	34.55	87.8	34.29	87.8	33.99	87.8	33.64
	-9.5	-10	90.4	34.03	90.4	34.69	90.0	34.52	90.0	34.26	90.0	33.95	90.0	33.60
	-8.5	-9.1	97.5	34.71	97.5	34.64	96.9	34.43	96.9	34.16	94.0	33.84	94.0	33.48
	-7.0	-7.6	108.1	34.71	108.1	34.56	107.4	34.31	107.4	34.00	98.5	33.68	98.5	33.31
	-5.0	-5.6	122.2	34.72	122.2	34.45	121.5	34.15	121.5	33.79	121.5	33.48	104.4	33.06
	-3.0	-3.7	135.0	34.72	135.0	34.35	129.6	33.98	125.4	33.57	121.5	33.27	110.3	32.83
	0.0	-0.7	136.4	34.74	135.0	34.19	129.6	33.73	125.4	33.25	121.5	32.95	112.8	32.47
	3.0	2.2	136.4	34.74	135.0	34.03	129.6	33.48	125.4	32.94	121.5	32.63	112.8	32.11
	5.0	4.1	136.4	34.75	135.0	33.92	129.6	33.31	125.4	32.73	121.5	32.42	112.8	31.87
	7.0	6	136.4	34.76	135.0	33.82	129.6	33.15	125.4	32.52	121.5	32.21	112.8	31.64
	9.0	7.9	136.4	34.93	135.0	33.99	129.6	33.31	125.4	32.68	121.5	32.37	112.8	31.79
	11.0	9.8	136.4	35.45	135.0	34.48	129.6	33.80	125.4	33.15	121.5	32.85	112.8	32.26
13.0	11.8	136.4	35.95	135.0	34.97	129.6	34.29	125.4	33.63	121.5	33.31	112.8	32.72	
15.0	13.7	136.4	36.45	135.0	35.46	129.6	34.77	125.4	34.09	121.5	33.77	112.8	33.17	
110	-19.8	-20	60.8	27.99	60.8	29.33	60.5	30.61	60.5	32.63	60.5	34.03	60.5	34.71
	-18.8	-19	63.7	28.66	63.7	30.01	63.4	31.28	63.4	33.30	63.4	34.71	63.4	34.52
	-16.7	-17	70.0	30.07	70.0	31.42	69.5	32.69	69.5	34.71	69.5	34.36	69.5	34.12
	-13.7	-15	78.8	32.09	78.8	33.43	78.3	34.71	78.3	34.23	78.3	33.88	78.3	33.54
	-11.8	-13	83.3	33.37	83.3	34.71	82.7	34.39	82.7	33.93	82.7	33.57	82.7	33.18
	-9.8	-11	87.9	34.71	87.9	34.38	87.4	34.06	87.4	33.60	87.4	33.25	87.4	32.79
	-9.5	-10	90.0	34.66	90.0	34.33	89.4	34.02	89.4	33.55	89.4	33.19	89.4	32.73
	-8.5	-9.1	97.0	34.51	97.0	34.17	96.4	33.84	96.4	33.39	93.9	33.03	93.9	32.54
	-7.0	-7.6	107.6	34.28	107.6	33.93	106.8	33.60	106.8	33.15	98.4	32.79	98.4	32.25
	-5.0	-5.6	117.1	33.97	117.1	33.60	116.3	33.27	112.5	32.83	103.1	32.46	101.6	31.87
	-3.0	-3.7	123.9	33.67	123.9	33.28	116.3	32.94	112.5	32.51	108.7	32.14	101.6	31.49
	0.0	-0.7	131.1	33.21	123.9	32.79	116.3	32.44	112.5	32.03	108.7	31.65	101.6	30.91
	3.0	2.2	131.1	32.74	123.9	32.30	116.3	31.95	112.5	31.55	108.7	31.16	101.6	30.34
	5.0	4.1	131.1	32.43	123.9	31.97	116.3	31.62	112.5	31.23	108.7	30.84	101.6	29.95
	7.0	6	131.1	32.13	123.9	31.64	116.3	31.29	112.5	30.91	108.7	30.51	101.6	29.57
	9.0	7.9	131.1	32.10	123.9	31.62	116.3	31.26	112.5	30.89	108.7	30.49	101.6	29.54
	11.0	9.8	131.1	32.39	123.9	31.90	116.3	31.55	112.5	31.16	108.7	30.76	101.6	29.82
13.0	11.8	131.1	32.66	123.9	32.17	116.3	31.81	112.5	31.42	108.7	31.02	101.6	30.06	
15.0	13.7	131.1	32.92	123.9	32.43	116.3	32.06	112.5	31.67	108.7	31.26	101.6	30.30	

Note

1. TC: Total Capacity(kW), PI : Power Input(kW, Comp. + Outdoor fan motor)
2. Capacity tables show the average value of conditions which may occur.
3. In the range beyond the operation limit of the outdoor unit, continuous operation and performance can not be guaranteed. When selecting the outdoor units, avoid the air temperature range that is not guaranteed continuous operation.

7. Capacity Tables

Combination (%)		Heating Capacity (38HP)												
		Outdoor air temp.		Indoor air temp. °C DB										
		°C DB	°C WB	16		18		20		21		22		24
		TC	PI	TC	PI	TC	PI	TC	PI	TC	PI	TC	PI	
100	-19.8	-20	60.6	29.14	60.6	30.25	60.2	31.19	60.2	32.98	60.2	34.23	60.2	34.71
	-18.8	-19	63.5	29.69	63.1	30.80	63.1	31.87	63.1	33.54	63.1	34.71	63.1	34.39
	-16.7	-17	69.3	30.86	69.3	31.98	69.3	33.28	68.8	34.71	68.8	34.09	68.8	33.71
	-13.7	-15	78.5	32.53	78.5	33.65	78.0	34.71	78.0	33.90	78.0	33.21	78.0	32.74
	-11.8	-13	82.8	33.60	82.4	34.71	82.4	34.24	82.4	33.38	82.4	32.64	82.4	32.13
	-9.8	-11	87.4	34.71	87.4	34.22	86.9	33.74	86.9	32.85	86.9	32.05	86.9	31.48
	-9.5	-10	89.5	34.65	89.5	34.15	89.1	33.67	89.1	32.76	89.1	31.97	89.1	31.39
	-8.5	-9.1	96.4	34.43	96.4	33.90	96.0	33.42	103.0	32.50	99.5	31.66	92.8	31.06
	-7.0	-7.6	108.7	34.10	108.3	33.54	106.4	33.05	103.0	32.10	99.5	31.23	92.8	30.58
	-5.0	-5.6	113.4	33.68	112.4	33.05	106.4	32.56	103.0	31.55	99.5	30.64	92.8	29.93
	-3.0	-3.7	116.8	33.25	113.3	32.56	106.4	32.07	103.0	31.01	99.5	30.05	92.8	29.28
	0.0	-0.7	120.0	32.60	113.3	31.84	106.4	31.33	103.0	30.21	99.5	29.16	92.8	28.32
	3.0	2.2	120.0	31.95	113.3	31.10	106.4	30.58	103.0	29.40	99.5	28.27	92.8	27.35
	5.0	4.1	120.0	31.53	113.3	30.61	106.4	30.09	103.0	28.86	99.5	27.68	92.8	26.70
	7.0	6	120.0	31.10	113.3	30.12	106.4	29.60	103.0	28.32	99.5	27.09	92.8	26.06
	9.0	7.9	120.0	30.67	113.3	29.70	106.4	29.19	103.0	27.93	99.5	26.72	92.8	25.70
	11.0	9.8	120.0	30.52	113.3	29.56	106.4	29.05	103.0	27.80	99.5	26.60	92.8	25.57
13.0	11.8	120.0	30.35	113.3	29.40	106.4	28.88	103.0	27.64	99.5	26.44	92.8	25.43	
15.0	13.7	120.0	30.14	113.3	29.20	106.4	28.69	103.0	27.45	99.5	26.25	92.8	25.26	
90	-19.8	-20	60.3	27.45	60.3	29.47	59.9	30.87	59.9	31.55	59.9	31.10	59.9	30.32
	-18.8	-19	63.5	28.12	63.1	30.14	62.8	31.55	62.8	31.33	62.8	30.88	62.8	30.06
	-16.7	-17	69.3	29.53	69.3	31.55	69.0	31.16	69.0	30.90	69.0	30.41	69.0	29.54
	-13.7	-15	78.5	31.55	78.5	31.04	77.6	30.61	77.6	30.26	77.6	29.74	77.6	28.81
	-11.8	-13	82.8	31.26	82.4	30.72	82.0	30.26	82.0	29.86	82.0	29.32	82.0	28.34
	-9.8	-11	87.4	30.96	87.4	30.38	86.6	29.89	86.6	29.44	86.6	28.88	79.5	27.84
	-9.5	-10	89.5	30.91	89.5	30.33	88.7	29.84	88.7	29.37	88.7	28.81	81.4	27.77
	-8.5	-9.1	96.4	30.77	95.8	30.16	95.6	29.66	94.3	29.17	91.3	28.59	84.8	27.52
	-7.0	-7.6	108.7	30.54	103.5	29.92	97.3	29.38	94.3	28.85	91.3	28.24	84.8	27.15
	-5.0	-5.6	109.9	30.23	103.5	29.57	97.3	29.01	94.3	28.43	91.3	27.80	84.8	26.65
	-3.0	-3.7	109.9	29.93	103.5	29.24	97.3	28.65	94.3	28.00	91.3	27.36	84.8	26.16
	0.0	-0.7	109.9	29.48	103.5	28.73	97.3	28.10	94.3	27.37	91.3	26.68	84.8	25.42
	3.0	2.2	109.9	29.02	103.5	28.23	97.3	27.54	94.3	26.74	91.3	26.02	84.8	24.68
	5.0	4.1	109.9	28.72	103.5	27.88	97.3	27.17	94.3	26.31	91.3	25.57	84.8	24.19
	7.0	6	109.9	28.42	103.5	27.55	97.3	26.81	94.3	25.89	91.3	25.12	84.8	23.69
	9.0	7.9	109.9	28.03	103.5	27.17	97.3	26.44	94.3	25.54	91.3	24.78	84.8	23.36
	11.0	9.8	109.9	27.64	103.5	26.79	97.3	26.08	94.3	25.18	91.3	24.43	84.8	23.04
13.0	11.8	109.9	27.25	103.5	26.41	97.3	25.70	94.3	24.82	91.3	24.09	84.8	22.71	
15.0	13.7	109.9	26.86	103.5	26.03	97.3	25.34	94.3	24.47	91.3	23.74	84.8	22.39	
80	-19.8	-20	59.7	23.87	59.7	25.89	59.7	27.98	59.7	27.55	59.7	26.90	59.7	26.21
	-18.8	-19	62.5	24.55	62.5	27.98	62.5	27.78	62.5	27.33	62.5	26.68	62.5	25.99
	-16.7	-17	69.0	27.98	69.0	27.61	69.0	27.38	69.0	26.90	69.0	26.24	69.0	25.51
	-13.7	-15	81.3	27.50	79.6	27.09	77.6	26.80	77.6	26.25	77.6	25.59	75.7	24.84
	-11.8	-13	87.8	27.20	85.3	26.77	82.0	26.44	82.0	25.86	81.4	25.18	75.7	24.41
	-9.8	-11	90.6	26.88	87.9	26.42	86.6	26.05	84.5	25.43	81.4	24.75	75.7	23.97
	-9.5	-10	91.2	26.83	88.6	26.36	87.1	25.99	84.5	25.37	81.4	24.69	75.7	23.90
	-8.5	-9.1	94.6	26.67	92.8	26.19	87.1	25.80	84.5	25.15	81.4	24.47	75.7	23.67
	-7.0	-7.6	98.4	26.44	92.8	25.93	87.1	25.51	84.5	24.83	81.4	24.15	75.7	23.33
	-5.0	-5.6	98.4	26.12	92.8	25.59	87.1	25.12	84.5	24.41	81.4	23.72	75.7	22.88
	-3.0	-3.7	98.4	25.80	92.8	25.24	87.1	24.73	84.5	23.98	81.4	23.29	75.7	22.44
	0.0	-0.7	98.4	25.32	92.8	24.72	87.1	24.16	84.5	23.35	81.4	22.64	75.7	21.76
	3.0	2.2	98.4	24.85	92.8	24.20	87.1	23.58	84.5	22.71	81.4	22.00	75.7	21.08
	5.0	4.1	98.4	24.53	92.8	23.85	87.1	23.20	84.5	22.28	81.4	21.57	75.7	20.63
	7.0	6	98.4	24.21	92.8	23.51	87.1	22.81	84.5	21.86	81.4	21.14	75.7	20.19
	9.0	7.9	98.4	22.73	92.8	22.06	87.1	21.41	84.5	20.53	81.4	19.85	75.7	18.96
	11.0	9.8	98.4	21.10	92.8	20.49	87.1	19.88	84.5	19.05	81.4	18.42	75.7	17.59
13.0	11.8	98.4	19.69	92.8	19.12	87.1	18.55	84.5	17.79	81.4	17.20	75.7	16.42	
15.0	13.7	98.4	18.54	92.8	18.00	87.1	17.47	84.5	16.74	81.4	16.19	75.7	15.46	

Note

1. TC: Total Capacity(kW), PI: Power Input(kW, Comp. + Outdoor fan motor)
2. Capacity tables show the average value of conditions which may occur.
3. In the range beyond the operation limit of the outdoor unit, continuous operation and performance can not be guaranteed. When selecting the outdoor units, avoid the air temperature range that is not guaranteed continuous operation.

7. Capacity Tables

Combination (%)		Heating Capacity (38HP)												
		Outdoor air temp.		Indoor air temp. °C DB										
		°C DB	°C WB	16		18		20		21		22		24
		TC	PI	TC	PI	TC	PI	TC	PI	TC	PI	TC	PI	
70	-19.8	-20	59.7	25.29	59.7	25.96	59.7	25.52	59.7	24.81	59.7	24.14	59.7	23.41
	-18.8	-19	62.5	25.96	62.5	25.75	62.5	25.30	62.5	24.59	62.5	23.92	62.5	23.16
	-16.7	-17	69.0	25.56	69.0	25.30	69.0	24.82	69.0	24.10	69.0	23.45	64.8	22.67
	-13.7	-15	83.5	25.00	78.8	24.66	74.1	24.16	71.6	23.42	69.4	22.77	64.8	21.95
	-11.8	-13	83.5	24.63	78.8	24.25	74.1	23.74	71.6	22.98	69.4	22.34	64.8	21.50
	-9.8	-11	83.5	24.26	78.8	23.82	74.1	23.29	71.6	22.52	69.4	21.89	64.8	21.02
	-9.5	-10	83.5	24.20	78.8	23.75	74.1	23.22	71.6	22.45	69.4	21.82	64.8	20.95
	-8.5	-9.1	83.5	24.01	78.8	23.55	74.1	23.00	71.6	22.22	69.4	21.60	64.8	20.72
	-7.0	-7.6	83.5	23.73	78.8	23.22	74.1	22.67	71.6	21.88	69.4	21.26	64.8	20.36
	-5.0	-5.6	83.5	23.35	78.8	22.80	74.1	22.22	71.6	21.42	69.4	20.81	64.8	19.88
	-3.0	-3.7	83.5	22.97	78.8	22.37	74.1	21.78	71.6	20.96	69.4	20.36	64.8	19.41
	0.0	-0.7	83.5	22.41	78.8	21.73	74.1	21.11	71.6	20.27	69.4	19.68	64.8	18.69
	3.0	2.2	83.5	21.83	78.8	21.08	74.1	20.45	71.6	19.59	69.4	19.00	64.8	17.98
	5.0	4.1	83.5	21.46	78.8	20.66	74.1	20.00	71.6	19.13	69.4	18.56	64.8	17.50
	7.0	6	83.5	21.08	78.8	20.23	74.1	19.55	71.6	18.67	69.4	18.11	64.8	17.02
	9.0	7.9	83.5	19.03	78.8	18.27	74.1	17.66	71.6	16.86	69.4	16.35	64.8	15.38
	11.0	9.8	83.5	17.72	78.8	17.01	74.1	16.44	71.6	15.70	69.4	15.22	64.8	14.31
	13.0	11.8	83.5	16.58	78.8	15.91	74.1	15.38	71.6	14.69	69.4	14.24	64.8	13.39
15.0	13.7	83.5	15.64	78.8	15.00	74.1	14.50	71.6	13.85	69.4	13.43	64.8	12.62	
60	-19.8	-20	71.6	23.94	67.8	23.50	59.7	22.80	59.7	22.12	59.3	21.45	55.5	20.71
	-18.8	-19	71.6	23.74	67.8	23.28	62.5	22.57	61.4	21.89	59.3	21.23	55.5	20.48
	-16.7	-17	71.6	23.34	67.8	22.80	63.6	22.10	61.4	21.42	59.3	20.75	55.5	19.97
	-13.7	-15	71.6	22.75	67.8	22.14	63.6	21.42	61.4	20.74	59.3	20.07	55.5	19.25
	-11.8	-13	71.6	22.38	67.8	21.71	63.6	20.98	61.4	20.32	59.3	19.64	55.5	18.80
	-9.8	-11	71.6	21.99	67.8	21.27	63.6	20.52	61.4	19.86	59.3	19.19	55.5	18.32
	-9.5	-10	71.6	21.92	67.8	21.20	63.6	20.46	61.4	19.79	59.3	19.12	55.5	18.25
	-8.5	-9.1	71.6	21.73	67.8	20.97	63.6	20.23	61.4	19.57	59.3	18.90	55.5	18.01
	-7.0	-7.6	71.6	21.44	67.8	20.64	63.6	19.89	61.4	19.22	59.3	18.56	55.5	17.66
	-5.0	-5.6	71.6	21.05	67.8	20.19	63.6	19.44	61.4	18.77	59.3	18.11	55.5	17.18
	-3.0	-3.7	71.6	20.65	67.8	19.75	63.6	18.97	61.4	18.31	59.3	17.66	55.5	16.71
	0.0	-0.7	71.6	20.07	67.8	19.08	63.6	18.29	61.4	17.63	59.3	16.98	55.5	15.98
	3.0	2.2	71.6	19.48	67.8	18.41	63.6	17.61	61.4	16.95	59.3	16.30	55.5	15.26
	5.0	4.1	71.6	19.09	67.8	17.96	63.6	17.15	61.4	16.50	59.3	15.84	55.5	14.79
	7.0	6	71.6	18.70	67.8	17.51	63.6	16.69	61.4	16.04	59.3	15.39	55.5	14.31
	9.0	7.9	71.6	16.69	67.8	15.62	63.6	14.90	61.4	14.32	59.3	13.73	55.5	12.78
	11.0	9.8	71.6	15.58	67.8	14.60	63.6	13.91	61.4	13.37	59.3	12.82	55.5	11.93
	13.0	11.8	71.6	14.60	67.8	13.67	63.6	13.04	61.4	12.52	59.3	12.01	55.5	11.17
15.0	13.7	71.6	13.79	67.8	12.92	63.6	12.32	61.4	11.84	59.3	11.35	55.5	10.56	
50	-19.8	-20	59.8	21.45	56.4	20.70	52.9	20.00	51.3	19.28	49.6	18.63	46.2	17.92
	-18.8	-19	59.8	21.22	56.4	20.45	52.9	19.76	51.3	19.05	49.6	18.40	46.2	17.68
	-16.7	-17	59.8	20.71	56.4	19.94	52.9	19.25	51.3	18.56	49.6	17.92	46.2	17.20
	-13.7	-15	59.8	20.00	56.4	19.21	52.9	18.54	51.3	17.84	49.6	17.23	46.2	16.49
	-11.8	-13	59.8	19.55	56.4	18.73	52.9	18.09	51.3	17.39	49.6	16.81	46.2	16.06
	-9.8	-11	59.8	19.08	56.4	18.24	52.9	17.62	51.3	16.91	49.6	16.35	46.2	15.59
	-9.5	-10	59.8	19.01	56.4	18.17	52.9	17.54	51.3	16.84	49.6	16.28	46.2	15.52
	-8.5	-9.1	59.8	18.76	56.4	17.92	52.9	17.30	51.3	16.61	49.6	16.06	46.2	15.29
	-7.0	-7.6	59.8	18.41	56.4	17.56	52.9	16.94	51.3	16.25	49.6	15.71	46.2	14.94
	-5.0	-5.6	59.8	17.94	56.4	17.07	52.9	16.46	51.3	15.77	49.6	15.25	46.2	14.47
	-3.0	-3.7	59.8	17.46	56.4	16.58	52.9	15.99	51.3	15.29	49.6	14.80	46.2	14.01
	0.0	-0.7	59.8	16.75	56.4	15.84	52.9	15.28	51.3	14.58	49.6	14.12	46.2	13.31
	3.0	2.2	59.8	16.03	56.4	15.10	52.9	14.56	51.3	13.88	49.6	13.43	46.2	12.62
	5.0	4.1	59.8	15.56	56.4	14.61	52.9	14.08	51.3	13.40	49.6	12.98	46.2	12.14
	7.0	6	59.8	15.09	56.4	14.12	52.9	13.60	51.3	12.92	49.6	12.52	46.2	11.68
	9.0	7.9	59.8	13.62	56.4	12.75	52.9	12.29	51.3	11.67	49.6	11.31	46.2	10.55
	11.0	9.8	59.8	12.75	56.4	11.93	52.9	11.49	51.3	10.92	49.6	10.58	46.2	9.87
	13.0	11.8	59.8	11.97	56.4	11.20	52.9	10.79	51.3	10.25	49.6	9.93	46.2	9.27
15.0	13.7	59.8	11.32	56.4	10.60	52.9	10.21	51.3	9.70	49.6	9.40	46.2	8.77	

Note

1. TC: Total Capacity(kW), PI: Power Input(kW, Comp. + Outdoor fan motor)
2. Capacity tables show the average value of conditions which may occur.
3. In the range beyond the operation limit of the outdoor unit, continuous operation and performance can not be guaranteed. When selecting the outdoor units, avoid the air temperature range that is not guaranteed continuous operation.

7. Capacity Tables

◆ A(C)RUN400LLS5

Combination (%)	Outdoor air temp.		Indoor air temp. °C DB											
	°C DB	°C WB	16		18		20		21		22		24	
			TC	PI	TC	PI	TC	PI	TC	PI	TC	PI	TC	PI
130	-19.8	-20	64.9	28.30	64.9	29.39	64.5	30.34	64.5	31.80	64.5	33.19	64.5	35.38
	-18.8	-19	68.0	29.03	68.0	30.12	67.6	31.08	67.6	32.53	67.6	33.92	67.6	36.11
	-16.7	-17	74.6	30.56	74.6	31.66	74.2	32.60	74.2	34.07	74.2	35.45	74.2	37.64
	-13.7	-15	84.0	32.75	84.0	33.85	83.5	34.79	83.5	36.25	83.5	37.64	83.5	37.22
	-11.8	-13	88.8	34.13	88.8	35.23	88.2	36.18	88.2	37.64	88.2	37.44	88.2	36.95
	-9.8	-11	93.8	35.60	93.8	36.69	93.1	37.64	93.1	37.52	93.1	37.22	93.1	36.67
	-9.5	-10	96.0	35.82	96.0	36.91	95.4	37.64	95.4	37.50	93.9	37.19	93.9	36.64
	-8.5	-9.1	103.4	36.55	103.4	37.64	102.8	37.64	102.8	37.44	96.4	37.08	96.4	36.50
	-7.0	-7.6	114.6	37.64	114.6	37.74	113.9	37.63	113.9	37.34	113.9	36.91	104.3	36.28
	-5.0	-5.6	129.5	37.97	129.5	37.88	128.6	37.61	128.6	37.22	128.6	36.69	110.6	36.00
	-3.0	-3.7	144.4	38.30	144.4	38.02	143.5	37.61	140.8	37.09	135.8	36.47	116.8	35.72
	0.0	-0.7	144.8	38.80	144.8	38.21	144.3	37.59	140.8	36.91	135.8	36.14	126.1	35.30
	3.0	2.2	144.8	39.30	144.8	38.41	144.3	37.58	140.8	36.72	135.8	35.81	126.5	34.88
	5.0	4.1	144.8	39.63	144.8	38.55	144.3	37.57	140.8	36.59	135.8	35.59	126.5	34.60
	7.0	6	144.8	39.97	144.8	38.68	144.3	37.56	140.8	36.47	135.8	35.38	126.5	34.32
	9.0	7.9	144.8	40.35	144.8	39.05	144.3	37.92	140.8	36.82	135.8	35.72	126.5	34.65
	11.0	9.8	144.8	41.15	144.8	39.82	144.3	38.66	140.8	37.54	135.8	36.42	126.5	35.33
13.0	11.8	144.8	41.93	144.8	40.59	144.3	39.40	140.8	38.25	135.8	37.11	126.5	36.00	
15.0	13.7	144.8	42.72	144.8	41.34	144.3	40.15	140.8	38.97	135.8	37.82	126.5	36.69	
120	-19.8	-20	64.5	29.39	64.5	30.34	64.0	31.80	64.0	33.19	64.0	35.38	64.0	36.91
	-18.8	-19	67.6	30.12	67.6	31.08	67.1	32.53	67.1	33.92	67.1	36.11	67.1	37.64
	-16.7	-17	74.0	31.66	74.0	32.60	73.6	34.07	73.6	35.45	73.6	37.64	73.6	37.37
	-13.7	-15	83.4	33.85	83.4	34.79	82.9	36.25	82.9	37.64	82.9	37.30	82.9	36.98
	-11.8	-13	88.2	35.23	88.2	36.18	87.6	37.64	87.6	37.42	87.6	37.08	87.6	36.74
	-9.8	-11	93.1	36.69	93.1	37.64	92.5	37.47	92.5	37.19	92.5	36.86	92.5	36.48
	-9.5	-10	95.3	36.91	95.3	37.63	94.8	37.44	94.8	37.16	94.8	36.81	94.8	36.44
	-8.5	-9.1	102.7	37.64	102.7	37.56	102.0	37.34	102.0	37.05	98.9	36.70	98.9	36.31
	-7.0	-7.6	113.8	37.64	113.8	37.48	113.1	37.21	113.1	36.87	103.6	36.53	103.6	36.12
	-5.0	-5.6	128.6	37.66	128.6	37.36	127.8	37.03	127.8	36.64	127.8	36.31	109.8	35.86
	-3.0	-3.7	142.1	37.66	142.1	37.25	136.5	36.85	132.0	36.41	127.8	36.08	115.9	35.60
	0.0	-0.7	143.6	37.67	142.1	37.08	136.5	36.58	132.0	36.06	127.8	35.73	118.8	35.21
	3.0	2.2	143.6	37.68	142.1	36.91	136.5	36.31	132.0	35.72	127.8	35.39	118.8	34.82
	5.0	4.1	143.6	37.69	142.1	36.78	136.5	36.13	132.0	35.50	127.8	35.16	118.8	34.56
	7.0	6	143.6	37.69	142.1	36.67	136.5	35.95	132.0	35.26	127.8	34.93	118.8	34.31
	9.0	7.9	143.6	37.88	142.1	36.86	136.5	36.13	132.0	35.44	127.8	35.11	118.8	34.48
	11.0	9.8	143.6	38.44	142.1	37.39	136.5	36.66	132.0	35.95	127.8	35.62	118.8	34.98
13.0	11.8	143.6	38.99	142.1	37.93	136.5	37.19	132.0	36.47	127.8	36.13	118.8	35.48	
15.0	13.7	143.6	39.52	142.1	38.46	136.5	37.70	132.0	36.97	127.8	36.63	118.8	35.97	
110	-19.8	-20	64.0	30.34	64.0	31.80	63.7	33.19	63.7	35.38	63.7	36.91	63.7	37.64
	-18.8	-19	67.1	31.08	67.1	32.53	66.8	33.92	66.8	36.11	66.8	37.64	66.8	37.44
	-16.7	-17	73.7	32.60	73.7	34.07	73.2	35.45	73.2	37.64	73.2	37.27	73.2	37.00
	-13.7	-15	82.9	34.79	82.9	36.25	82.4	37.64	82.4	37.12	82.4	36.75	82.4	36.37
	-11.8	-13	87.7	36.18	87.7	37.64	87.1	37.30	87.1	36.79	87.1	36.41	87.1	35.98
	-9.8	-11	92.6	37.64	92.6	37.28	92.0	36.94	92.0	36.44	92.0	36.06	92.0	35.56
	-9.5	-10	94.8	37.59	94.8	37.23	94.2	36.89	94.2	36.39	94.2	36.00	94.2	35.50
	-8.5	-9.1	102.2	37.42	102.2	37.06	101.5	36.71	101.5	36.22	99.0	35.83	99.0	35.29
	-7.0	-7.6	113.2	37.17	113.2	36.80	112.5	36.44	112.5	35.95	103.8	35.56	103.8	34.98
	-5.0	-5.6	123.2	36.84	123.2	36.44	122.5	36.08	118.5	35.61	108.8	35.20	106.9	34.56
	-3.0	-3.7	130.5	36.51	130.5	36.09	122.5	35.72	118.5	35.26	114.5	34.85	106.9	34.15
	0.0	-0.7	138.0	36.01	130.5	35.56	122.5	35.18	118.5	34.73	114.5	34.32	106.9	33.52
	3.0	2.2	138.0	35.51	130.5	35.03	122.5	34.65	118.5	34.21	114.5	33.79	106.9	32.90
	5.0	4.1	138.0	35.17	130.5	34.67	122.5	34.29	118.5	33.87	114.5	33.44	106.9	32.48
	7.0	6	138.0	34.84	130.5	34.31	122.5	33.93	118.5	33.52	114.5	33.09	106.9	32.07
	9.0	7.9	138.0	34.81	130.5	34.29	122.5	33.90	118.5	33.49	114.5	33.07	106.9	32.04
	11.0	9.8	138.0	35.12	130.5	34.59	122.5	34.21	118.5	33.79	114.5	33.36	106.9	32.33
13.0	11.8	138.0	35.42	130.5	34.89	122.5	34.50	118.5	34.07	114.5	33.64	106.9	32.60	
15.0	13.7	138.0	35.70	130.5	35.17	122.5	34.77	118.5	34.34	114.5	33.90	106.9	32.85	

Note

1. TC: Total Capacity(kW), PI : Power Input(kW, Comp. + Outdoor fan motor)

2. Capacity tables show the average value of conditions which may occur.

3. In the range beyond the operation limit of the outdoor unit, continuous operation and performance can not be guaranteed. When selecting the outdoor units, avoid the air temperature range that is not guaranteed continuous operation.

7. Capacity Tables

Combination (%)		Heating Capacity (40HP)												
		Outdoor air temp.		Indoor air temp. °C DB										
		°C DB	°C WB	16		18		20		21		22		24
		TC	PI	TC	PI	TC	PI	TC	PI	TC	PI	TC	PI	
100	-19.8	-20	63.9	31.60	63.9	32.80	63.4	33.82	63.4	35.76	63.4	37.12	63.4	37.64
	-18.8	-19	66.9	32.19	66.5	33.40	66.5	34.56	66.5	36.37	66.5	37.64	66.5	37.30
	-16.7	-17	72.9	33.46	72.9	34.68	72.9	36.09	72.5	37.64	72.5	36.97	72.5	36.56
	-13.7	-15	82.6	35.28	82.6	36.50	82.1	37.64	82.1	36.76	82.1	36.01	82.1	35.51
	-11.8	-13	87.2	36.43	86.8	37.64	86.8	37.14	86.8	36.20	86.8	35.40	86.8	34.84
	-9.8	-11	92.1	37.64	92.1	37.11	91.6	36.59	91.6	35.62	91.6	34.76	91.6	34.14
	-9.5	-10	94.3	37.58	94.3	37.03	93.9	36.52	93.9	35.53	93.9	34.67	93.9	34.04
	-8.5	-9.1	101.6	37.34	101.6	36.77	101.1	36.25	108.4	35.25	104.8	34.34	97.7	33.68
	-7.0	-7.6	114.5	36.99	114.0	36.37	112.0	35.84	108.4	34.81	104.8	33.87	97.7	33.16
	-5.0	-5.6	119.4	36.53	118.3	35.84	112.0	35.31	108.4	34.22	104.8	33.23	97.7	32.46
	-3.0	-3.7	122.9	36.06	119.2	35.31	112.0	34.78	108.4	33.63	104.8	32.58	97.7	31.76
	0.0	-0.7	126.3	35.36	119.2	34.52	112.0	33.98	108.4	32.76	104.8	31.63	97.7	30.71
	3.0	2.2	126.3	34.65	119.2	33.73	112.0	33.17	108.4	31.88	104.8	30.66	97.7	29.66
	5.0	4.1	126.3	34.20	119.2	33.20	112.0	32.63	108.4	31.30	104.8	30.02	97.7	28.95
	7.0	6	126.3	33.73	119.2	32.67	112.0	32.10	108.4	30.71	104.8	29.38	97.7	28.26
	9.0	7.9	126.3	33.26	119.2	32.21	112.0	31.66	108.4	30.28	104.8	28.98	97.7	27.87
	11.0	9.8	126.3	33.10	119.2	32.06	112.0	31.51	108.4	30.14	104.8	28.84	97.7	27.73
13.0	11.8	126.3	32.91	119.2	31.88	112.0	31.32	108.4	29.97	104.8	28.67	97.7	27.58	
15.0	13.7	126.3	32.68	119.2	31.66	112.0	31.11	108.4	29.77	104.8	28.47	97.7	27.39	
90	-19.8	-20	63.6	29.76	63.6	31.96	63.1	33.48	63.1	34.21	63.1	33.73	63.1	32.88
	-18.8	-19	66.9	30.49	66.5	32.68	66.2	34.21	66.2	33.98	66.2	33.49	66.2	32.60
	-16.7	-17	72.9	32.02	72.9	34.21	72.6	33.79	72.6	33.51	72.6	32.98	72.6	32.04
	-13.7	-15	82.6	34.21	82.6	33.67	81.7	33.20	81.7	32.82	81.7	32.26	81.7	31.24
	-11.8	-13	87.2	33.90	86.8	33.32	86.3	32.82	86.3	32.38	86.3	31.80	86.3	30.73
	-9.8	-11	92.1	33.57	92.1	32.95	91.3	32.42	91.3	31.93	91.3	31.31	91.3	30.19
	-9.5	-10	94.3	33.53	94.3	32.90	93.4	32.36	93.4	31.85	93.4	31.24	93.4	30.11
	-8.5	-9.1	101.6	33.37	100.9	32.71	100.7	32.16	99.3	31.63	96.1	31.00	89.2	29.85
	-7.0	-7.6	114.5	33.12	108.9	32.44	102.5	31.86	99.3	31.29	96.1	30.63	89.2	29.44
	-5.0	-5.6	115.7	32.79	108.9	32.07	102.5	31.46	99.3	30.83	96.1	30.14	89.2	28.91
	-3.0	-3.7	115.7	32.46	108.9	31.71	102.5	31.07	99.3	30.36	96.1	29.67	89.2	28.37
	0.0	-0.7	115.7	31.97	108.9	31.16	102.5	30.47	99.3	29.69	96.1	28.94	89.2	27.57
	3.0	2.2	115.7	31.48	108.9	30.61	102.5	29.86	99.3	29.00	96.1	28.22	89.2	26.76
	5.0	4.1	115.7	31.15	108.9	30.24	102.5	29.47	99.3	28.53	96.1	27.73	89.2	26.23
	7.0	6	115.7	30.82	108.9	29.88	102.5	29.08	99.3	28.08	96.1	27.25	89.2	25.69
	9.0	7.9	115.7	30.40	108.9	29.47	102.5	28.67	99.3	27.70	96.1	26.87	89.2	25.34
	11.0	9.8	115.7	29.97	108.9	29.05	102.5	28.28	99.3	27.31	96.1	26.50	89.2	24.99
13.0	11.8	115.7	29.55	108.9	28.64	102.5	27.87	99.3	26.92	96.1	26.12	89.2	24.63	
15.0	13.7	115.7	29.13	108.9	28.23	102.5	27.48	99.3	26.54	96.1	25.75	89.2	24.28	
80	-19.8	-20	62.9	25.88	62.9	28.07	62.9	30.34	62.9	29.88	62.9	29.17	62.9	28.42
	-18.8	-19	65.9	26.62	65.9	30.34	65.9	30.13	65.9	29.64	65.9	28.94	65.9	28.18
	-16.7	-17	72.6	30.34	72.6	29.94	72.6	29.69	72.6	29.17	72.6	28.45	72.6	27.67
	-13.7	-15	85.5	29.83	83.8	29.38	81.7	29.06	81.7	28.47	81.7	27.75	79.7	26.93
	-11.8	-13	92.5	29.50	89.9	29.03	86.3	28.67	86.3	28.04	85.7	27.31	79.7	26.48
	-9.8	-11	95.4	29.15	92.7	28.65	91.3	28.25	88.9	27.58	85.7	26.84	79.7	25.99
	-9.5	-10	96.0	29.09	93.2	28.59	91.7	28.19	88.9	27.51	85.7	26.78	79.7	25.91
	-8.5	-9.1	99.6	28.92	97.7	28.40	91.7	27.98	88.9	27.28	85.7	26.54	79.7	25.67
	-7.0	-7.6	103.6	28.67	97.7	28.12	91.7	27.67	88.9	26.93	85.7	26.19	79.7	25.30
	-5.0	-5.6	103.6	28.32	97.7	27.75	91.7	27.25	88.9	26.48	85.7	25.73	79.7	24.82
	-3.0	-3.7	103.6	27.98	97.7	27.37	91.7	26.82	88.9	26.01	85.7	25.26	79.7	24.33
	0.0	-0.7	103.6	27.46	97.7	26.81	91.7	26.20	88.9	25.32	85.7	24.56	79.7	23.60
	3.0	2.2	103.6	26.95	97.7	26.24	91.7	25.57	88.9	24.63	85.7	23.86	79.7	22.86
	5.0	4.1	103.6	26.60	97.7	25.87	91.7	25.16	88.9	24.16	85.7	23.39	79.7	22.38
	7.0	6	103.6	26.26	97.7	25.49	91.7	24.74	88.9	23.71	85.7	22.93	79.7	21.89
	9.0	7.9	103.6	24.65	97.7	23.93	91.7	23.22	88.9	22.26	85.7	21.53	79.7	20.56
	11.0	9.8	103.6	22.88	97.7	22.22	91.7	21.56	88.9	20.66	85.7	19.98	79.7	19.07
13.0	11.8	103.6	21.36	97.7	20.73	91.7	20.12	88.9	19.29	85.7	18.65	79.7	17.81	
15.0	13.7	103.6	20.10	97.7	19.52	91.7	18.95	88.9	18.15	85.7	17.56	79.7	16.77	

Note
 1. TC: Total Capacity(kW), PI: Power Input(kW, Comp. + Outdoor fan motor)
 2. Capacity tables show the average value of conditions which may occur.
 3. In the range beyond the operation limit of the outdoor unit, continuous operation and performance can not be guaranteed. When selecting the outdoor units, avoid the air temperature range that is not guaranteed continuous operation.

7. Capacity Tables

Combination (%)		Heating Capacity (40HP)												
		Outdoor air temp.		Indoor air temp. °C DB										
		°C DB	°C WB	16		18		20		21		22		24
		TC	PI	TC	PI	TC	PI	TC	PI	TC	PI	TC	PI	
70	-19.8	-20	62.9	27.42	62.9	28.15	62.9	27.67	62.9	26.90	62.9	26.18	62.9	25.38
	-18.8	-19	65.9	28.15	65.9	27.92	65.9	27.43	65.9	26.66	65.9	25.94	65.9	25.12
	-16.7	-17	72.6	27.72	72.6	27.43	72.6	26.92	72.6	26.13	72.6	25.43	68.2	24.58
	-13.7	-15	87.8	27.10	82.9	26.74	78.0	26.20	75.4	25.39	73.1	24.69	68.2	23.80
	-11.8	-13	87.8	26.71	82.9	26.29	78.0	25.74	75.4	24.91	73.1	24.22	68.2	23.31
	-9.8	-11	87.8	26.30	82.9	25.83	78.0	25.26	75.4	24.42	73.1	23.74	68.2	22.80
	-9.5	-10	87.8	26.24	82.9	25.76	78.0	25.18	75.4	24.35	73.1	23.66	68.2	22.72
	-8.5	-9.1	87.8	26.04	82.9	25.54	78.0	24.94	75.4	24.10	73.1	23.42	68.2	22.47
	-7.0	-7.6	87.8	25.73	82.9	25.18	78.0	24.58	75.4	23.72	73.1	23.05	68.2	22.08
	-5.0	-5.6	87.8	25.32	82.9	24.72	78.0	24.10	75.4	23.22	73.1	22.56	68.2	21.56
	-3.0	-3.7	87.8	24.91	82.9	24.26	78.0	23.61	75.4	22.73	73.1	22.08	68.2	21.04
	0.0	-0.7	87.8	24.30	82.9	23.56	78.0	22.89	75.4	21.99	73.1	21.34	68.2	20.26
	3.0	2.2	87.8	23.68	82.9	22.86	78.0	22.17	75.4	21.25	73.1	20.61	68.2	19.49
	5.0	4.1	87.8	23.27	82.9	22.41	78.0	21.69	75.4	20.75	73.1	20.12	68.2	18.98
	7.0	6	87.8	22.86	82.9	21.94	78.0	21.20	75.4	20.25	73.1	19.64	68.2	18.46
	9.0	7.9	87.8	20.64	82.9	19.81	78.0	19.15	75.4	18.29	73.1	17.73	68.2	16.67
	11.0	9.8	87.8	19.22	82.9	18.45	78.0	17.83	75.4	17.02	73.1	16.51	68.2	15.52
13.0	11.8	87.8	17.98	82.9	17.26	78.0	16.68	75.4	15.93	73.1	15.44	68.2	14.52	
15.0	13.7	87.8	16.96	82.9	16.27	78.0	15.72	75.4	15.02	73.1	14.56	68.2	13.69	
60	-19.8	-20	75.4	25.96	71.4	25.47	62.9	24.72	62.9	23.99	62.5	23.25	58.4	22.45
	-18.8	-19	75.4	25.74	71.4	25.24	65.9	24.47	64.6	23.74	62.5	23.01	58.4	22.20
	-16.7	-17	75.4	25.30	71.4	24.72	66.9	23.96	64.6	23.22	62.5	22.50	58.4	21.65
	-13.7	-15	75.4	24.66	71.4	24.00	66.9	23.22	64.6	22.49	62.5	21.76	58.4	20.87
	-11.8	-13	75.4	24.27	71.4	23.54	66.9	22.75	64.6	22.03	62.5	21.30	58.4	20.39
	-9.8	-11	75.4	23.84	71.4	23.06	66.9	22.25	64.6	21.53	62.5	20.81	58.4	19.87
	-9.5	-10	75.4	23.77	71.4	22.99	66.9	22.19	64.6	21.45	62.5	20.73	58.4	19.79
	-8.5	-9.1	75.4	23.56	71.4	22.74	66.9	21.94	64.6	21.22	62.5	20.49	58.4	19.53
	-7.0	-7.6	75.4	23.25	71.4	22.38	66.9	21.56	64.6	20.84	62.5	20.12	58.4	19.15
	-5.0	-5.6	75.4	22.83	71.4	21.89	66.9	21.07	64.6	20.35	62.5	19.63	58.4	18.63
	-3.0	-3.7	75.4	22.39	71.4	21.42	66.9	20.58	64.6	19.86	62.5	19.15	58.4	18.11
	0.0	-0.7	75.4	21.76	71.4	20.69	66.9	19.84	64.6	19.12	62.5	18.41	58.4	17.33
	3.0	2.2	75.4	21.12	71.4	19.96	66.9	19.10	64.6	18.38	62.5	17.68	58.4	16.55
	5.0	4.1	75.4	20.70	71.4	19.48	66.9	18.60	64.6	17.90	62.5	17.18	58.4	16.04
	7.0	6	75.4	20.28	71.4	18.99	66.9	18.10	64.6	17.40	62.5	16.69	58.4	15.52
	9.0	7.9	75.4	18.10	71.4	16.94	66.9	16.16	64.6	15.53	62.5	14.89	58.4	13.86
	11.0	9.8	75.4	16.90	71.4	15.83	66.9	15.08	64.6	14.50	62.5	13.91	58.4	12.93
13.0	11.8	75.4	15.83	71.4	14.83	66.9	14.14	64.6	13.58	62.5	13.03	58.4	12.12	
15.0	13.7	75.4	14.96	71.4	14.01	66.9	13.36	64.6	12.84	62.5	12.31	58.4	11.45	
50	-19.8	-20	62.9	23.25	59.4	22.44	55.7	21.68	54.0	20.90	52.2	20.20	48.6	19.43
	-18.8	-19	62.9	23.00	59.4	22.17	55.7	21.42	54.0	20.65	52.2	19.95	48.6	19.17
	-16.7	-17	62.9	22.45	59.4	21.62	55.7	20.87	54.0	20.12	52.2	19.43	48.6	18.65
	-13.7	-15	62.9	21.68	59.4	20.82	55.7	20.10	54.0	19.34	52.2	18.68	48.6	17.88
	-11.8	-13	62.9	21.20	59.4	20.31	55.7	19.62	54.0	18.85	52.2	18.22	48.6	17.41
	-9.8	-11	62.9	20.68	59.4	19.78	55.7	19.10	54.0	18.34	52.2	17.72	48.6	16.91
	-9.5	-10	62.9	20.60	59.4	19.70	55.7	19.02	54.0	18.26	52.2	17.65	48.6	16.83
	-8.5	-9.1	62.9	20.34	59.4	19.43	55.7	18.76	54.0	18.00	52.2	17.41	48.6	16.58
	-7.0	-7.6	62.9	19.96	59.4	19.04	55.7	18.37	54.0	17.62	52.2	17.03	48.6	16.20
	-5.0	-5.6	62.9	19.45	59.4	18.51	55.7	17.85	54.0	17.10	52.2	16.54	48.6	15.69
	-3.0	-3.7	62.9	18.93	59.4	17.97	55.7	17.33	54.0	16.58	52.2	16.05	48.6	15.19
	0.0	-0.7	62.9	18.16	59.4	17.18	55.7	16.56	54.0	15.81	52.2	15.31	48.6	14.44
	3.0	2.2	62.9	17.38	59.4	16.38	55.7	15.78	54.0	15.05	52.2	14.56	48.6	13.68
	5.0	4.1	62.9	16.88	59.4	15.85	55.7	15.27	54.0	14.53	52.2	14.08	48.6	13.17
	7.0	6	62.9	16.36	59.4	15.31	55.7	14.75	54.0	14.01	52.2	13.58	48.6	12.67
	9.0	7.9	62.9	14.77	59.4	13.83	55.7	13.32	54.0	12.65	52.2	12.26	48.6	11.44
	11.0	9.8	62.9	13.82	59.4	12.94	55.7	12.46	54.0	11.84	52.2	11.48	48.6	10.71
13.0	11.8	62.9	12.98	59.4	12.15	55.7	11.70	54.0	11.12	52.2	10.77	48.6	10.05	
15.0	13.7	62.9	12.28	59.4	11.49	55.7	11.07	54.0	10.52	52.2	10.19	48.6	9.51	

Note

1. TC: Total Capacity(kW), PI: Power Input(kW, Comp. + Outdoor fan motor)
2. Capacity tables show the average value of conditions which may occur.
3. In the range beyond the operation limit of the outdoor unit, continuous operation and performance can not be guaranteed. When selecting the outdoor units, avoid the air temperature range that is not guaranteed continuous operation.

7. Capacity Tables

◆ A(C)RUN420LLS5

Combination (%)	Outdoor air temp.		Indoor air temp. °C DB											
	°C DB	°C WB	16		18		20		21		22		24	
			TC	PI	TC	PI	TC	PI	TC	PI	TC	PI	TC	PI
130	-19.8	-20	68.1	28.73	68.1	29.84	67.7	30.81	67.7	32.29	67.7	33.70	67.7	35.93
	-18.8	-19	71.4	29.47	71.4	30.58	70.9	31.55	70.9	33.04	70.9	34.44	70.9	36.67
	-16.7	-17	78.3	31.03	78.3	32.14	77.9	33.10	77.9	34.59	77.9	36.00	77.9	38.23
	-13.7	-15	88.2	33.26	88.2	34.37	87.7	35.33	87.7	36.81	87.7	38.23	87.7	37.80
	-11.8	-13	93.2	34.66	93.2	35.78	92.6	36.75	92.6	38.23	92.6	38.02	92.6	37.53
	-9.8	-11	98.4	36.15	98.4	37.26	97.8	38.23	97.8	38.10	97.8	37.80	97.8	37.24
	-9.5	-10	100.8	36.38	100.8	37.48	100.2	38.23	100.2	38.08	98.6	37.76	98.6	37.21
	-8.5	-9.1	108.6	37.11	108.6	38.23	107.9	38.22	107.9	38.02	101.2	37.65	101.2	37.06
	-7.0	-7.6	120.3	38.23	120.3	38.33	119.6	38.21	119.6	37.92	119.6	37.48	109.6	36.85
	-5.0	-5.6	136.0	38.56	136.0	38.47	135.1	38.20	135.1	37.80	135.1	37.26	116.2	36.56
	-3.0	-3.7	151.6	38.90	151.6	38.61	150.6	38.19	147.8	37.67	142.6	37.04	122.8	36.27
	0.0	-0.7	152.0	39.41	152.0	38.80	151.5	38.18	147.8	37.48	142.6	36.70	132.6	35.85
	3.0	2.2	152.0	39.92	152.0	39.01	151.5	38.16	147.8	37.29	142.6	36.37	132.8	35.43
	5.0	4.1	152.0	40.25	152.0	39.15	151.5	38.15	147.8	37.16	142.6	36.15	132.8	35.14
	7.0	6	152.0	40.60	152.0	39.28	151.5	38.15	147.8	37.03	142.6	35.93	132.8	34.86
	9.0	7.9	152.0	40.98	152.0	39.66	151.5	38.51	147.8	37.39	142.6	36.28	132.8	35.19
	11.0	9.8	152.0	41.79	152.0	40.44	151.5	39.26	147.8	38.12	142.6	36.99	132.8	35.88
13.0	11.8	152.0	42.59	152.0	41.22	151.5	40.01	147.8	38.85	142.6	37.69	132.8	36.56	
15.0	13.7	152.0	43.38	152.0	41.99	151.5	40.77	147.8	39.58	142.6	38.41	132.8	37.26	
120	-19.8	-20	67.7	29.84	67.7	30.81	67.2	32.29	67.2	33.70	67.2	35.93	67.2	37.48
	-18.8	-19	70.9	30.58	70.9	31.55	70.4	33.04	70.4	34.44	70.4	36.67	70.4	38.23
	-16.7	-17	77.7	32.14	77.7	33.10	77.2	34.59	77.2	36.00	77.2	38.23	77.2	37.95
	-13.7	-15	87.6	34.37	87.6	35.33	87.1	36.81	87.1	38.23	87.1	37.88	87.1	37.56
	-11.8	-13	92.6	35.78	92.6	36.75	92.0	38.23	92.0	38.00	92.0	37.66	92.0	37.31
	-9.8	-11	97.8	37.26	97.8	38.23	97.1	38.05	97.1	37.77	97.1	37.43	97.1	37.05
	-9.5	-10	100.0	37.48	100.0	38.21	99.5	38.02	99.5	37.74	99.5	37.39	99.5	37.00
	-8.5	-9.1	107.8	38.23	107.8	38.15	107.1	37.93	107.1	37.62	104.0	37.27	104.0	36.88
	-7.0	-7.6	119.5	38.23	119.5	38.07	118.7	37.78	118.7	37.45	108.9	37.10	108.9	36.68
	-5.0	-5.6	135.0	38.24	135.0	37.94	134.2	37.61	134.2	37.21	134.2	36.87	115.4	36.42
	-3.0	-3.7	149.2	38.24	149.2	37.83	143.3	37.42	138.6	36.97	134.2	36.64	121.9	36.16
	0.0	-0.7	150.7	38.26	149.2	37.66	143.3	37.15	138.6	36.63	134.2	36.29	124.7	35.76
	3.0	2.2	150.7	38.26	149.2	37.48	143.3	36.88	138.6	36.28	134.2	35.94	124.7	35.37
	5.0	4.1	150.7	38.28	149.2	37.36	143.3	36.69	138.6	36.05	134.2	35.70	124.7	35.10
	7.0	6	150.7	38.28	149.2	37.24	143.3	36.51	138.6	35.81	134.2	35.48	124.7	34.84
	9.0	7.9	150.7	38.47	149.2	37.43	143.3	36.69	138.6	35.99	134.2	35.65	124.7	35.02
	11.0	9.8	150.7	39.04	149.2	37.98	143.3	37.23	138.6	36.52	134.2	36.18	124.7	35.53
13.0	11.8	150.7	39.60	149.2	38.52	143.3	37.77	138.6	37.04	134.2	36.69	124.7	36.04	
15.0	13.7	150.7	40.14	149.2	39.06	143.3	38.29	138.6	37.55	134.2	37.20	124.7	36.53	
110	-19.8	-20	67.2	30.81	67.2	32.29	66.9	33.70	66.9	35.93	66.9	37.48	66.9	38.23
	-18.8	-19	70.5	31.55	70.5	33.04	70.1	34.44	70.1	36.67	70.1	38.23	70.1	38.02
	-16.7	-17	77.4	33.10	77.4	34.59	76.9	36.00	76.9	38.23	76.9	37.85	76.9	37.57
	-13.7	-15	87.1	35.33	87.1	36.81	86.6	38.23	86.6	37.70	86.6	37.32	86.6	36.94
	-11.8	-13	92.1	36.75	92.1	38.23	91.5	37.88	91.5	37.37	91.5	36.97	91.5	36.54
	-9.8	-11	97.3	38.23	97.3	37.86	96.6	37.51	96.6	37.00	96.6	36.62	96.6	36.11
	-9.5	-10	99.5	38.18	99.5	37.81	98.9	37.46	98.9	36.96	98.9	36.56	98.9	36.05
	-8.5	-9.1	107.3	38.01	107.3	37.64	106.6	37.28	106.6	36.78	103.9	36.38	103.9	35.84
	-7.0	-7.6	118.9	37.75	118.9	37.37	118.1	37.00	118.1	36.51	108.9	36.11	108.9	35.52
	-5.0	-5.6	129.4	37.42	129.4	37.00	128.6	36.64	124.4	36.16	114.1	35.75	112.3	35.10
	-3.0	-3.7	137.0	37.08	137.0	36.65	128.6	36.27	124.4	35.81	120.2	35.40	112.3	34.68
	0.0	-0.7	144.9	36.57	137.0	36.11	128.6	35.73	124.4	35.27	120.2	34.86	112.3	34.05
	3.0	2.2	144.9	36.06	137.0	35.57	128.6	35.19	124.4	34.75	120.2	34.32	112.3	33.41
	5.0	4.1	144.9	35.72	137.0	35.21	128.6	34.82	124.4	34.40	120.2	33.97	112.3	32.98
	7.0	6	144.9	35.38	137.0	34.84	128.6	34.46	124.4	34.04	120.2	33.60	112.3	32.57
	9.0	7.9	144.9	35.35	137.0	34.83	128.6	34.43	124.4	34.02	120.2	33.58	112.3	32.54
	11.0	9.8	144.9	35.67	137.0	35.13	128.6	34.75	124.4	34.32	120.2	33.88	112.3	32.84
13.0	11.8	144.9	35.97	137.0	35.43	128.6	35.03	124.4	34.61	120.2	34.16	112.3	33.11	
15.0	13.7	144.9	36.26	137.0	35.72	128.6	35.31	124.4	34.88	120.2	34.43	112.3	33.37	

Note

1. TC: Total Capacity(kW), PI : Power Input(kW, Comp. + Outdoor fan motor)
2. Capacity tables show the average value of conditions which may occur.
3. In the range beyond the operation limit of the outdoor unit, continuous operation and performance can not be guaranteed. When selecting the outdoor units, avoid the air temperature range that is not guaranteed continuous operation.

7. Capacity Tables

Combination (%)		Heating Capacity (42HP)												
		Outdoor air temp.		Indoor air temp. °C DB										
		°C DB	°C WB	16		18		20		21		22		24
		TC	PI	TC	PI	TC	PI	TC	PI	TC	PI	TC	PI	
100	-19.8	-20	67.0	32.08	67.0	33.31	66.5	34.35	66.5	36.32	66.5	37.70	66.5	38.23
	-18.8	-19	70.2	32.69	69.8	33.92	69.8	35.09	69.8	36.94	69.8	38.23	69.8	37.88
	-16.7	-17	76.6	33.98	76.6	35.22	76.6	36.65	76.1	38.23	76.1	37.54	76.1	37.13
	-13.7	-15	86.7	35.83	86.7	37.06	86.3	38.23	86.3	37.34	86.3	36.57	86.3	36.06
	-11.8	-13	91.6	37.00	91.1	38.23	91.1	37.72	91.1	36.77	91.1	35.95	91.1	35.38
	-9.8	-11	96.7	38.23	96.7	37.69	96.2	37.16	96.2	36.18	96.2	35.30	96.2	34.67
	-9.5	-10	99.0	38.16	99.0	37.61	98.6	37.08	98.6	36.08	98.6	35.21	98.6	34.57
	-8.5	-9.1	106.6	37.92	106.6	37.34	106.2	36.81	113.9	35.79	110.0	34.87	102.6	34.21
	-7.0	-7.6	120.2	37.56	119.7	36.94	117.6	36.40	113.9	35.35	110.0	34.39	102.6	33.68
	-5.0	-5.6	125.4	37.10	124.2	36.40	117.6	35.86	113.9	34.75	110.0	33.74	102.6	32.96
	-3.0	-3.7	129.1	36.62	125.2	35.86	117.6	35.32	113.9	34.16	110.0	33.09	102.6	32.25
	0.0	-0.7	132.6	35.91	125.2	35.06	117.6	34.51	113.9	33.27	110.0	32.12	102.6	31.19
	3.0	2.2	132.6	35.19	125.2	34.25	117.6	33.68	113.9	32.38	110.0	31.14	102.6	30.12
	5.0	4.1	132.6	34.73	125.2	33.71	117.6	33.14	113.9	31.79	110.0	30.49	102.6	29.41
	7.0	6	132.6	34.25	125.2	33.17	117.6	32.60	113.9	31.19	110.0	29.84	102.6	28.70
	9.0	7.9	132.6	33.78	125.2	32.71	117.6	32.15	113.9	30.76	110.0	29.43	102.6	28.31
	11.0	9.8	132.6	33.62	125.2	32.56	117.6	32.00	113.9	30.61	110.0	29.29	102.6	28.17
13.0	11.8	132.6	33.43	125.2	32.38	117.6	31.81	113.9	30.44	110.0	29.12	102.6	28.01	
15.0	13.7	132.6	33.19	125.2	32.16	117.6	31.60	113.9	30.23	110.0	28.92	102.6	27.82	
90	-19.8	-20	66.7	30.22	66.7	32.45	66.2	34.00	66.2	34.74	66.2	34.25	66.2	33.39
	-18.8	-19	70.2	30.96	69.8	33.18	69.5	34.74	69.5	34.51	69.5	34.01	69.5	33.11
	-16.7	-17	76.6	32.52	76.6	34.74	76.3	34.32	76.3	34.03	76.3	33.49	76.3	32.54
	-13.7	-15	86.7	34.74	86.7	34.19	85.8	33.71	85.8	33.33	85.8	32.76	85.8	31.72
	-11.8	-13	91.6	34.43	91.1	33.84	90.7	33.33	90.7	32.88	90.7	32.29	90.7	31.21
	-9.8	-11	96.7	34.09	96.7	33.46	95.8	32.92	95.8	32.42	95.8	31.80	87.9	30.66
	-9.5	-10	99.0	34.05	99.0	33.41	98.1	32.87	98.1	32.35	98.1	31.72	90.0	30.58
	-8.5	-9.1	106.6	33.88	106.0	33.22	105.7	32.66	104.2	32.12	100.9	31.48	93.7	30.31
	-7.0	-7.6	120.2	33.63	114.3	32.95	107.6	32.36	104.2	31.77	100.9	31.11	93.7	29.90
	-5.0	-5.6	121.5	33.30	114.3	32.57	107.6	31.95	104.2	31.31	100.9	30.61	93.7	29.36
	-3.0	-3.7	121.5	32.96	114.3	32.20	107.6	31.55	104.2	30.84	100.9	30.13	93.7	28.81
	0.0	-0.7	121.5	32.47	114.3	31.64	107.6	30.94	104.2	30.15	100.9	29.39	93.7	28.00
	3.0	2.2	121.5	31.96	114.3	31.09	107.6	30.33	104.2	29.45	100.9	28.65	93.7	27.18
	5.0	4.1	121.5	31.63	114.3	30.71	107.6	29.93	104.2	28.98	100.9	28.16	93.7	26.64
	7.0	6	121.5	31.30	114.3	30.34	107.6	29.53	104.2	28.51	100.9	27.67	93.7	26.09
	9.0	7.9	121.5	30.87	114.3	29.93	107.6	29.12	104.2	28.13	100.9	27.29	93.7	25.73
	11.0	9.8	121.5	30.44	114.3	29.50	107.6	28.72	104.2	27.73	100.9	26.91	93.7	25.38
13.0	11.8	121.5	30.01	114.3	29.09	107.6	28.31	104.2	27.34	100.9	26.53	93.7	25.02	
15.0	13.7	121.5	29.58	114.3	28.67	107.6	27.91	104.2	26.95	100.9	26.15	93.7	24.66	
80	-19.8	-20	66.0	26.28	66.0	28.51	66.0	30.81	66.0	30.34	66.0	29.63	66.0	28.86
	-18.8	-19	69.2	27.03	69.2	30.81	69.2	30.60	69.2	30.10	69.2	29.39	69.2	28.62
	-16.7	-17	76.3	30.81	76.3	30.41	76.3	30.15	76.3	29.62	76.3	28.89	76.3	28.10
	-13.7	-15	89.8	30.29	88.1	29.83	85.8	29.51	85.8	28.91	85.8	28.18	83.7	27.35
	-11.8	-13	97.1	29.96	94.4	29.48	90.7	29.11	90.7	28.48	90.0	27.73	83.7	26.89
	-9.8	-11	100.2	29.61	97.3	29.10	95.8	28.69	93.4	28.00	90.0	27.26	83.7	26.39
	-9.5	-10	100.8	29.55	97.9	29.04	96.3	28.62	93.4	27.94	90.0	27.19	83.7	26.32
	-8.5	-9.1	104.5	29.37	102.6	28.85	96.3	28.41	93.4	27.70	90.0	26.95	83.7	26.06
	-7.0	-7.6	108.7	29.11	102.6	28.56	96.3	28.10	93.4	27.35	90.0	26.60	83.7	25.70
	-5.0	-5.6	108.7	28.76	102.6	28.18	96.3	27.67	93.4	26.89	90.0	26.13	83.7	25.20
	-3.0	-3.7	108.7	28.41	102.6	27.80	96.3	27.24	93.4	26.41	90.0	25.65	83.7	24.71
	0.0	-0.7	108.7	27.89	102.6	27.22	96.3	26.61	93.4	25.71	90.0	24.94	83.7	23.96
	3.0	2.2	108.7	27.37	102.6	26.65	96.3	25.97	93.4	25.01	90.0	24.23	83.7	23.22
	5.0	4.1	108.7	27.02	102.6	26.27	96.3	25.55	93.4	24.54	90.0	23.76	83.7	22.73
	7.0	6	108.7	26.67	102.6	25.89	96.3	25.12	93.4	24.08	90.0	23.28	83.7	22.23
	9.0	7.9	108.7	25.03	102.6	24.30	96.3	23.59	93.4	22.61	90.0	21.87	83.7	20.88
	11.0	9.8	108.7	23.23	102.6	22.56	96.3	21.90	93.4	20.98	90.0	20.29	83.7	19.37
13.0	11.8	108.7	21.69	102.6	21.06	96.3	20.44	93.4	19.59	90.0	18.94	83.7	18.08	
15.0	13.7	108.7	20.42	102.6	19.83	96.3	19.24	93.4	18.43	90.0	17.83	83.7	17.03	

Note

1. TC: Total Capacity(kW), PI: Power Input(kW, Comp. + Outdoor fan motor)
2. Capacity tables show the average value of conditions which may occur.
3. In the range beyond the operation limit of the outdoor unit, continuous operation and performance can not be guaranteed. When selecting the outdoor units, avoid the air temperature range that is not guaranteed continuous operation.

7. Capacity Tables

Combination (%)		Heating Capacity (42HP)												
		Outdoor air temp.		Indoor air temp. °C DB										
		°C DB	°C WB	16		18		20		21		22		24
		TC	PI	TC	PI	TC	PI	TC	PI	TC	PI	TC	PI	
70	-19.8	-20	66.0	27.84	66.0	28.59	66.0	28.09	66.0	27.32	66.0	26.59	66.0	25.77
	-18.8	-19	69.2	28.59	69.2	28.35	69.2	27.85	69.2	27.07	69.2	26.34	69.2	25.51
	-16.7	-17	76.3	28.14	76.3	27.86	76.3	27.33	76.3	26.54	76.3	25.82	71.6	24.96
	-13.7	-15	92.2	27.52	87.1	27.15	81.9	26.60	79.1	25.79	76.8	25.07	71.6	24.17
	-11.8	-13	92.2	27.13	87.1	26.70	81.9	26.14	79.1	25.30	76.8	24.60	71.6	23.68
	-9.8	-11	92.2	26.71	87.1	26.23	81.9	25.65	79.1	24.80	76.8	24.11	71.6	23.15
	-9.5	-10	92.2	26.65	87.1	26.16	81.9	25.57	79.1	24.72	76.8	24.03	71.6	23.07
	-8.5	-9.1	92.2	26.44	87.1	25.93	81.9	25.33	79.1	24.47	76.8	23.79	71.6	22.82
	-7.0	-7.6	92.2	26.13	87.1	25.57	81.9	24.96	79.1	24.09	76.8	23.41	71.6	22.42
	-5.0	-5.6	92.2	25.71	87.1	25.11	81.9	24.47	79.1	23.58	76.8	22.91	71.6	21.90
	-3.0	-3.7	92.2	25.30	87.1	24.63	81.9	23.98	79.1	23.09	76.8	22.42	71.6	21.37
	0.0	-0.7	92.2	24.68	87.1	23.93	81.9	23.25	79.1	22.33	76.8	21.68	71.6	20.58
	3.0	2.2	92.2	24.05	87.1	23.22	81.9	22.52	79.1	21.58	76.8	20.93	71.6	19.80
	5.0	4.1	92.2	23.63	87.1	22.75	81.9	22.03	79.1	21.07	76.8	20.44	71.6	19.27
	7.0	6	92.2	23.22	87.1	22.28	81.9	21.53	79.1	20.56	76.8	19.94	71.6	18.75
	9.0	7.9	92.2	20.96	87.1	20.12	81.9	19.45	79.1	18.57	76.8	18.00	71.6	16.93
11.0	9.8	92.2	19.52	87.1	18.73	81.9	18.11	79.1	17.29	76.8	16.76	71.6	15.76	
13.0	11.8	92.2	18.26	87.1	17.53	81.9	16.94	79.1	16.17	76.8	15.68	71.6	14.74	
15.0	13.7	92.2	17.22	87.1	16.52	81.9	15.97	79.1	15.25	76.8	14.79	71.6	13.90	
60	-19.8	-20	79.1	26.36	74.9	25.87	66.0	25.10	66.0	24.36	65.6	23.61	61.4	22.80
	-18.8	-19	79.1	26.14	74.9	25.63	69.2	24.85	67.9	24.10	65.6	23.37	61.4	22.54
	-16.7	-17	79.1	25.69	74.9	25.10	70.3	24.33	67.9	23.58	65.6	22.85	61.4	21.99
	-13.7	-15	79.1	25.04	74.9	24.37	70.3	23.58	67.9	22.83	65.6	22.10	61.4	21.20
	-11.8	-13	79.1	24.64	74.9	23.90	70.3	23.10	67.9	22.37	65.6	21.62	61.4	20.70
	-9.8	-11	79.1	24.21	74.9	23.42	70.3	22.60	67.9	21.86	65.6	21.13	61.4	20.18
	-9.5	-10	79.1	24.14	74.9	23.34	70.3	22.53	67.9	21.79	65.6	21.05	61.4	20.10
	-8.5	-9.1	79.1	23.93	74.9	23.09	70.3	22.27	67.9	21.54	65.6	20.81	61.4	19.83
	-7.0	-7.6	79.1	23.61	74.9	22.72	70.3	21.90	67.9	21.16	65.6	20.43	61.4	19.44
	-5.0	-5.6	79.1	23.18	74.9	22.23	70.3	21.40	67.9	20.67	65.6	19.94	61.4	18.92
	-3.0	-3.7	79.1	22.74	74.9	21.75	70.3	20.89	67.9	20.16	65.6	19.44	61.4	18.39
	0.0	-0.7	79.1	22.10	74.9	21.01	70.3	20.15	67.9	19.42	65.6	18.70	61.4	17.60
	3.0	2.2	79.1	21.45	74.9	20.27	70.3	19.40	67.9	18.67	65.6	17.95	61.4	16.81
	5.0	4.1	79.1	21.02	74.9	19.78	70.3	18.89	67.9	18.18	65.6	17.45	61.4	16.29
	7.0	6	79.1	20.59	74.9	19.29	70.3	18.39	67.9	17.67	65.6	16.95	61.4	15.76
	9.0	7.9	79.1	18.38	74.9	17.21	70.3	16.41	67.9	15.77	65.6	15.13	61.4	14.07
11.0	9.8	79.1	17.16	74.9	16.08	70.3	15.32	67.9	14.73	65.6	14.12	61.4	13.14	
13.0	11.8	79.1	16.08	74.9	15.06	70.3	14.36	67.9	13.79	65.6	13.23	61.4	12.31	
15.0	13.7	79.1	15.19	74.9	14.23	70.3	13.56	67.9	13.04	65.6	12.50	61.4	11.63	
50	-19.8	-20	66.1	23.61	62.3	22.78	58.5	22.01	56.7	21.23	54.8	20.50	51.0	19.73
	-18.8	-19	66.1	23.35	62.3	22.51	58.5	21.75	56.7	20.97	54.8	20.25	51.0	19.46
	-16.7	-17	66.1	22.80	62.3	21.95	58.5	21.19	56.7	20.43	54.8	19.73	51.0	18.93
	-13.7	-15	66.1	22.02	62.3	21.14	58.5	20.41	56.7	19.63	54.8	18.97	51.0	18.16
	-11.8	-13	66.1	21.52	62.3	20.62	58.5	19.92	56.7	19.14	54.8	18.50	51.0	17.68
	-9.8	-11	66.1	21.00	62.3	20.08	58.5	19.39	56.7	18.62	54.8	18.00	51.0	17.17
	-9.5	-10	66.1	20.92	62.3	20.00	58.5	19.31	56.7	18.54	54.8	17.92	51.0	17.09
	-8.5	-9.1	66.1	20.65	62.3	19.73	58.5	19.05	56.7	18.28	54.8	17.68	51.0	16.84
	-7.0	-7.6	66.1	20.27	62.3	19.33	58.5	18.65	56.7	17.89	54.8	17.30	51.0	16.45
	-5.0	-5.6	66.1	19.75	62.3	18.79	58.5	18.13	56.7	17.36	54.8	16.79	51.0	15.93
	-3.0	-3.7	66.1	19.22	62.3	18.25	58.5	17.60	56.7	16.84	54.8	16.30	51.0	15.42
	0.0	-0.7	66.1	18.44	62.3	17.44	58.5	16.82	56.7	16.06	54.8	15.55	51.0	14.66
	3.0	2.2	66.1	17.65	62.3	16.63	58.5	16.03	56.7	15.28	54.8	14.79	51.0	13.89
	5.0	4.1	66.1	17.14	62.3	16.09	58.5	15.51	56.7	14.76	54.8	14.29	51.0	13.38
	7.0	6	66.1	16.62	62.3	15.55	58.5	14.98	56.7	14.23	54.8	13.79	51.0	12.87
	9.0	7.9	66.1	15.00	62.3	14.04	58.5	13.53	56.7	12.85	54.8	12.45	51.0	11.62
11.0	9.8	66.1	14.04	62.3	13.14	58.5	12.66	56.7	12.02	54.8	11.66	51.0	10.88	
13.0	11.8	66.1	13.18	62.3	12.34	58.5	11.88	56.7	11.29	54.8	10.94	51.0	10.21	
15.0	13.7	66.1	12.47	62.3	11.67	58.5	11.24	56.7	10.69	54.8	10.35	51.0	9.66	

Note

1. TC: Total Capacity(kW), PI: Power Input(kW, Comp. + Outdoor fan motor)
2. Capacity tables show the average value of conditions which may occur.
3. In the range beyond the operation limit of the outdoor unit, continuous operation and performance can not be guaranteed. When selecting the outdoor units, avoid the air temperature range that is not guaranteed continuous operation.

7. Capacity Tables

◆ A(C)RUN440LLS5

Combination (%)	Outdoor air temp.		Heating Capacity (44HP)											
			Indoor air temp. °C DB											
	°C DB	°C WB	16		18		20		21		22		24	
		TC	PI	TC	PI	TC	PI	TC	PI	TC	PI	TC	PI	
130	-19.8	-20	71.4	28.73	71.4	29.84	71.0	30.81	71.0	32.29	71.0	33.70	71.0	35.93
	-18.8	-19	74.8	29.47	74.8	30.58	74.3	31.55	74.3	33.04	74.3	34.44	74.3	36.67
	-16.7	-17	82.1	31.03	82.1	32.14	81.6	33.10	81.6	34.59	81.6	36.00	81.6	38.23
	-13.7	-15	92.4	33.26	92.4	34.37	91.9	35.33	91.9	36.81	91.9	38.23	91.9	37.80
	-11.8	-13	97.6	34.66	97.6	35.78	97.0	36.75	97.0	38.23	97.0	38.02	97.0	37.53
	-9.8	-11	103.1	36.15	103.1	37.26	102.4	38.23	102.4	38.10	102.4	37.80	102.4	37.24
	-9.5	-10	105.6	36.38	105.6	37.48	104.9	38.23	104.9	38.08	103.3	37.76	103.3	37.21
	-8.5	-9.1	113.8	37.11	113.8	38.23	113.1	38.22	113.1	38.02	106.0	37.65	106.0	37.06
	-7.0	-7.6	126.1	38.23	126.1	38.33	125.2	38.21	125.2	37.92	125.2	37.48	114.7	36.85
	-5.0	-5.6	142.5	38.56	142.5	38.47	141.5	38.20	141.5	37.80	141.5	37.26	121.6	36.56
	-3.0	-3.7	158.8	38.90	158.8	38.61	157.8	38.19	154.8	37.67	149.4	37.04	128.5	36.27
	0.0	-0.7	159.2	39.41	159.2	38.80	158.7	38.18	154.8	37.48	149.4	36.70	138.7	35.85
	3.0	2.2	159.2	39.92	159.2	39.01	158.7	38.16	154.8	37.29	149.4	36.37	139.1	35.43
	5.0	4.1	159.2	40.25	159.2	39.15	158.7	38.15	154.8	37.16	149.4	36.15	139.1	35.14
	7.0	6	159.2	40.60	159.2	39.28	158.7	38.15	154.8	37.03	149.4	35.93	139.1	34.86
	9.0	7.9	159.2	40.98	159.2	39.66	158.7	38.51	154.8	37.39	149.4	36.28	139.1	35.19
	11.0	9.8	159.2	41.79	159.2	40.44	158.7	39.26	154.8	38.12	149.4	36.99	139.1	35.88
13.0	11.8	159.2	42.59	159.2	41.22	158.7	40.01	154.8	38.85	149.4	37.69	139.1	36.56	
15.0	13.7	159.2	43.38	159.2	41.99	158.7	40.77	154.8	39.58	149.4	38.41	139.1	37.26	
120	-19.8	-20	70.9	29.84	70.9	30.81	70.4	32.29	70.4	33.70	70.4	35.93	70.4	37.48
	-18.8	-19	74.3	30.58	74.3	31.55	73.8	33.04	73.8	34.44	73.8	36.67	73.8	38.23
	-16.7	-17	81.4	32.14	81.4	33.10	80.9	34.59	80.9	36.00	80.9	38.23	80.9	37.95
	-13.7	-15	91.7	34.37	91.7	35.33	91.2	36.81	91.2	38.23	91.2	37.88	91.2	37.56
	-11.8	-13	97.0	35.78	97.0	36.75	96.3	38.23	96.3	38.00	96.3	37.66	96.3	37.31
	-9.8	-11	102.4	37.26	102.4	38.23	101.7	38.05	101.7	37.77	101.7	37.43	101.7	37.05
	-9.5	-10	104.8	37.48	104.8	38.21	104.2	38.02	104.2	37.74	104.2	37.39	104.2	37.00
	-8.5	-9.1	112.9	38.23	112.9	38.15	112.2	37.93	112.2	37.62	108.8	37.27	108.8	36.88
	-7.0	-7.6	125.2	38.23	125.2	38.07	124.4	37.78	124.4	37.45	114.0	37.10	114.0	36.68
	-5.0	-5.6	141.4	38.24	141.4	37.94	140.6	37.61	140.6	37.21	140.6	36.87	120.7	36.42
	-3.0	-3.7	156.3	38.24	156.3	37.83	150.1	37.42	145.2	36.97	140.6	36.64	127.5	36.16
	0.0	-0.7	157.9	38.26	156.3	37.66	150.1	37.15	145.2	36.63	140.6	36.29	130.6	35.76
	3.0	2.2	157.9	38.26	156.3	37.48	150.1	36.88	145.2	36.28	140.6	35.94	130.6	35.37
	5.0	4.1	157.9	38.28	156.3	37.36	150.1	36.69	145.2	36.05	140.6	35.70	130.6	35.10
	7.0	6	157.9	38.28	156.3	37.24	150.1	36.51	145.2	35.81	140.6	35.48	130.6	34.84
	9.0	7.9	157.9	38.47	156.3	37.43	150.1	36.69	145.2	35.99	140.6	35.65	130.6	35.02
	11.0	9.8	157.9	39.04	156.3	37.98	150.1	37.23	145.2	36.52	140.6	36.18	130.6	35.53
13.0	11.8	157.9	39.60	156.3	38.52	150.1	37.77	145.2	37.04	140.6	36.69	130.6	36.04	
15.0	13.7	157.9	40.14	156.3	39.06	150.1	38.29	145.2	37.55	140.6	37.20	130.6	36.53	
110	-19.8	-20	70.5	30.81	70.5	32.29	70.1	33.70	70.1	35.93	70.1	37.48	70.1	38.23
	-18.8	-19	73.9	31.55	73.9	33.04	73.5	34.44	73.5	36.67	73.5	38.23	73.5	38.02
	-16.7	-17	81.1	33.10	81.1	34.59	80.6	36.00	80.6	38.23	80.6	37.85	80.6	37.57
	-13.7	-15	91.2	35.33	91.2	36.81	90.7	38.23	90.7	37.70	90.7	37.32	90.7	36.94
	-11.8	-13	96.4	36.75	96.4	38.23	95.8	37.88	95.8	37.37	95.8	36.97	95.8	36.54
	-9.8	-11	101.9	38.23	101.9	37.86	101.2	37.51	101.2	37.00	101.2	36.62	101.2	36.11
	-9.5	-10	104.3	38.18	104.3	37.81	103.6	37.46	103.6	36.96	103.6	36.56	103.6	36.05
	-8.5	-9.1	112.4	38.01	112.4	37.64	111.7	37.28	111.7	36.78	108.8	36.38	108.8	35.84
	-7.0	-7.6	124.5	37.75	124.5	37.37	123.7	37.00	123.7	36.51	114.2	36.11	114.2	35.52
	-5.0	-5.6	135.6	37.42	135.6	37.00	134.7	36.64	130.3	36.16	119.6	35.75	117.6	35.10
	-3.0	-3.7	143.5	37.08	143.5	36.65	134.7	36.27	130.3	35.81	125.9	35.40	117.6	34.68
	0.0	-0.7	151.8	36.57	143.5	36.11	134.7	35.73	130.3	35.27	125.9	34.86	117.6	34.05
	3.0	2.2	151.8	36.06	143.5	35.57	134.7	35.19	130.3	34.75	125.9	34.32	117.6	33.41
	5.0	4.1	151.8	35.72	143.5	35.21	134.7	34.82	130.3	34.40	125.9	33.97	117.6	32.98
	7.0	6	151.8	35.38	143.5	34.84	134.7	34.46	130.3	34.04	125.9	33.60	117.6	32.57
	9.0	7.9	151.8	35.35	143.5	34.83	134.7	34.43	130.3	34.02	125.9	33.58	117.6	32.54
	11.0	9.8	151.8	35.67	143.5	35.13	134.7	34.75	130.3	34.32	125.9	33.88	117.6	32.84
13.0	11.8	151.8	35.97	143.5	35.43	134.7	35.03	130.3	34.61	125.9	34.16	117.6	33.11	
15.0	13.7	151.8	36.26	143.5	35.72	134.7	35.31	130.3	34.88	125.9	34.43	117.6	33.37	

Note

1. TC: Total Capacity(kW), PI : Power Input(kW, Comp. + Outdoor fan motor)
2. Capacity tables show the average value of conditions which may occur.
3. In the range beyond the operation limit of the outdoor unit, continuous operation and performance can not be guaranteed. When selecting the outdoor units, avoid the air temperature range that is not guaranteed continuous operation.

7. Capacity Tables

Combination (%)		Heating Capacity (44HP)												
		Outdoor air temp.		Indoor air temp. °C DB										
		°C DB	°C WB	16		18		20		21		22		24
		TC	PI	TC	PI	TC	PI	TC	PI	TC	PI	TC	PI	
100	-19.8	-20	70.3	32.08	70.3	33.31	69.8	34.35	69.8	36.32	69.8	37.70	69.8	38.23
	-18.8	-19	73.6	32.69	73.1	33.92	73.1	35.09	73.1	36.94	73.1	38.23	73.1	37.88
	-16.7	-17	80.2	33.98	80.2	35.22	80.2	36.65	79.7	38.23	79.7	37.54	79.7	37.13
	-13.7	-15	90.8	35.83	90.8	37.06	90.3	38.23	90.3	37.34	90.3	36.57	90.3	36.06
	-11.8	-13	95.9	37.00	95.4	38.23	95.4	37.72	95.4	36.77	95.4	35.95	95.4	35.38
	-9.8	-11	101.3	38.23	101.3	37.69	100.8	37.16	100.8	36.18	100.8	35.30	100.8	34.67
	-9.5	-10	103.7	38.16	103.7	37.61	103.2	37.08	103.2	36.08	103.2	35.21	103.2	34.57
	-8.5	-9.1	111.7	37.92	111.7	37.34	111.2	36.81	119.3	35.79	115.3	34.87	107.4	34.21
	-7.0	-7.6	125.9	37.56	125.4	36.94	123.2	36.40	119.3	35.35	115.3	34.39	107.4	33.68
	-5.0	-5.6	131.4	37.10	130.1	36.40	123.2	35.86	119.3	34.75	115.3	33.74	107.4	32.96
	-3.0	-3.7	135.2	36.62	131.1	35.86	123.2	35.32	119.3	34.16	115.3	33.09	107.4	32.25
	0.0	-0.7	139.0	35.91	131.1	35.06	123.2	34.51	119.3	33.27	115.3	32.12	107.4	31.19
	3.0	2.2	139.0	35.19	131.1	34.25	123.2	33.68	119.3	32.38	115.3	31.14	107.4	30.12
	5.0	4.1	139.0	34.73	131.1	33.71	123.2	33.14	119.3	31.79	115.3	30.49	107.4	29.41
	7.0	6	139.0	34.25	131.1	33.17	123.2	32.60	119.3	31.19	115.3	29.84	107.4	28.70
	9.0	7.9	139.0	33.78	131.1	32.71	123.2	32.15	119.3	30.76	115.3	29.43	107.4	28.31
	11.0	9.8	139.0	33.62	131.1	32.56	123.2	32.00	119.3	30.61	115.3	29.29	107.4	28.17
13.0	11.8	139.0	33.43	131.1	32.38	123.2	31.81	119.3	30.44	115.3	29.12	107.4	28.01	
15.0	13.7	139.0	33.19	131.1	32.16	123.2	31.60	119.3	30.23	115.3	28.92	107.4	27.82	
90	-19.8	-20	69.9	30.22	69.9	32.45	69.5	34.00	69.5	34.74	69.5	34.25	69.5	33.39
	-18.8	-19	73.6	30.96	73.1	33.18	72.8	34.74	72.8	34.51	72.8	34.01	72.8	33.11
	-16.7	-17	80.2	32.52	80.2	34.74	79.9	34.32	79.9	34.03	79.9	33.49	79.9	32.54
	-13.7	-15	90.8	34.74	90.8	34.19	89.9	33.71	89.9	33.33	89.9	32.76	89.9	31.72
	-11.8	-13	95.9	34.43	95.4	33.84	95.0	33.33	95.0	32.88	95.0	32.29	95.0	31.21
	-9.8	-11	101.3	34.09	101.3	33.46	100.4	32.92	100.4	32.42	100.4	31.80	92.1	30.66
	-9.5	-10	103.7	34.05	103.7	33.41	102.8	32.87	102.8	32.35	102.8	31.72	94.3	30.58
	-8.5	-9.1	111.7	33.88	111.0	33.22	110.7	32.66	109.2	32.12	105.7	31.48	98.2	30.31
	-7.0	-7.6	125.9	33.63	119.8	32.95	112.7	32.36	109.2	31.77	105.7	31.11	98.2	29.90
	-5.0	-5.6	127.3	33.30	119.8	32.57	112.7	31.95	109.2	31.31	105.7	30.61	98.2	29.36
	-3.0	-3.7	127.3	32.96	119.8	32.20	112.7	31.55	109.2	30.84	105.7	30.13	98.2	28.81
	0.0	-0.7	127.3	32.47	119.8	31.64	112.7	30.94	109.2	30.15	105.7	29.39	98.2	28.00
	3.0	2.2	127.3	31.96	119.8	31.09	112.7	30.33	109.2	29.45	105.7	28.65	98.2	27.18
	5.0	4.1	127.3	31.63	119.8	30.71	112.7	29.93	109.2	28.98	105.7	28.16	98.2	26.64
	7.0	6	127.3	31.30	119.8	30.34	112.7	29.53	109.2	28.51	105.7	27.67	98.2	26.09
	9.0	7.9	127.3	30.87	119.8	29.93	112.7	29.12	109.2	28.13	105.7	27.29	98.2	25.73
	11.0	9.8	127.3	30.44	119.8	29.50	112.7	28.72	109.2	27.73	105.7	26.91	98.2	25.38
13.0	11.8	127.3	30.01	119.8	29.09	112.7	28.31	109.2	27.34	105.7	26.53	98.2	25.02	
15.0	13.7	127.3	29.58	119.8	28.67	112.7	27.91	109.2	26.95	105.7	26.15	98.2	24.66	
80	-19.8	-20	69.2	26.28	69.2	28.51	69.2	30.81	69.2	30.34	69.2	29.63	69.2	28.86
	-18.8	-19	72.5	27.03	72.5	30.81	72.5	30.60	72.5	30.10	72.5	29.39	72.5	28.62
	-16.7	-17	79.9	30.81	79.9	30.41	79.9	30.15	79.9	29.62	79.9	28.89	79.9	28.10
	-13.7	-15	94.1	30.29	92.2	29.83	89.9	29.51	89.9	28.91	89.9	28.18	87.7	27.35
	-11.8	-13	101.7	29.96	98.8	29.48	95.0	29.11	95.0	28.48	94.3	27.73	87.7	26.89
	-9.8	-11	105.0	29.61	101.9	29.10	100.4	28.69	97.8	28.00	94.3	27.26	87.7	26.39
	-9.5	-10	105.6	29.55	102.5	29.04	100.9	28.62	97.8	27.94	94.3	27.19	87.7	26.32
	-8.5	-9.1	109.5	29.37	107.4	28.85	100.9	28.41	97.8	27.70	94.3	26.95	87.7	26.06
	-7.0	-7.6	113.9	29.11	107.4	28.56	100.9	28.10	97.8	27.35	94.3	26.60	87.7	25.70
	-5.0	-5.6	113.9	28.76	107.4	28.18	100.9	27.67	97.8	26.89	94.3	26.13	87.7	25.20
	-3.0	-3.7	113.9	28.41	107.4	27.80	100.9	27.24	97.8	26.41	94.3	25.65	87.7	24.71
	0.0	-0.7	113.9	27.89	107.4	27.22	100.9	26.61	97.8	25.71	94.3	24.94	87.7	23.96
	3.0	2.2	113.9	27.37	107.4	26.65	100.9	25.97	97.8	25.01	94.3	24.23	87.7	23.22
	5.0	4.1	113.9	27.02	107.4	26.27	100.9	25.55	97.8	24.54	94.3	23.76	87.7	22.73
	7.0	6	113.9	26.67	107.4	25.89	100.9	25.12	97.8	24.08	94.3	23.28	87.7	22.23
	9.0	7.9	113.9	25.03	107.4	24.30	100.9	23.59	97.8	22.61	94.3	21.87	87.7	20.88
	11.0	9.8	113.9	23.23	107.4	22.56	100.9	21.90	97.8	20.98	94.3	20.29	87.7	19.37
13.0	11.8	113.9	21.69	107.4	21.06	100.9	20.44	97.8	19.59	94.3	18.94	87.7	18.08	
15.0	13.7	113.9	20.42	107.4	19.83	100.9	19.24	97.8	18.43	94.3	17.83	87.7	17.03	

Note

1. TC: Total Capacity(kW), PI: Power Input(kW, Comp. + Outdoor fan motor)
2. Capacity tables show the average value of conditions which may occur.
3. In the range beyond the operation limit of the outdoor unit, continuous operation and performance can not be guaranteed. When selecting the outdoor units, avoid the air temperature range that is not guaranteed continuous operation.

7. Capacity Tables

Combination (%)		Heating Capacity (44HP)												
		Outdoor air temp.		Indoor air temp. °C DB										
		°C DB	°C WB	16		18		20		21		22		24
		TC	PI	TC	PI	TC	PI	TC	PI	TC	PI	TC	PI	
70	-19.8	-20	69.2	27.84	69.2	28.59	69.2	28.09	69.2	27.32	69.2	26.59	69.2	25.77
	-18.8	-19	72.5	28.59	72.5	28.35	72.5	27.85	72.5	27.07	72.5	26.34	72.5	25.51
	-16.7	-17	79.9	28.14	79.9	27.86	79.9	27.33	79.9	26.54	79.9	25.82	75.0	24.96
	-13.7	-15	96.6	27.52	91.2	27.15	85.8	26.60	82.9	25.79	80.4	25.07	75.0	24.17
	-11.8	-13	96.6	27.13	91.2	26.70	85.8	26.14	82.9	25.30	80.4	24.60	75.0	23.68
	-9.8	-11	96.6	26.71	91.2	26.23	85.8	25.65	82.9	24.80	80.4	24.11	75.0	23.15
	-9.5	-10	96.6	26.65	91.2	26.16	85.8	25.57	82.9	24.72	80.4	24.03	75.0	23.07
	-8.5	-9.1	96.6	26.44	91.2	25.93	85.8	25.33	82.9	24.47	80.4	23.79	75.0	22.82
	-7.0	-7.6	96.6	26.13	91.2	25.57	85.8	24.96	82.9	24.09	80.4	23.41	75.0	22.42
	-5.0	-5.6	96.6	25.71	91.2	25.11	85.8	24.47	82.9	23.58	80.4	22.91	75.0	21.90
	-3.0	-3.7	96.6	25.30	91.2	24.63	85.8	23.98	82.9	23.09	80.4	22.42	75.0	21.37
	0.0	-0.7	96.6	24.68	91.2	23.93	85.8	23.25	82.9	22.33	80.4	21.68	75.0	20.58
	3.0	2.2	96.6	24.05	91.2	23.22	85.8	22.52	82.9	21.58	80.4	20.93	75.0	19.80
	5.0	4.1	96.6	23.63	91.2	22.75	85.8	22.03	82.9	21.07	80.4	20.44	75.0	19.27
	7.0	6	96.6	23.22	91.2	22.28	85.8	21.53	82.9	20.56	80.4	19.94	75.0	18.75
	9.0	7.9	96.6	20.96	91.2	20.12	85.8	19.45	82.9	18.57	80.4	18.00	75.0	16.93
	11.0	9.8	96.6	19.52	91.2	18.73	85.8	18.11	82.9	17.29	80.4	16.76	75.0	15.76
	13.0	11.8	96.6	18.26	91.2	17.53	85.8	16.94	82.9	16.17	80.4	15.68	75.0	14.74
15.0	13.7	96.6	17.22	91.2	16.52	85.8	15.97	82.9	15.25	80.4	14.79	75.0	13.90	
60	-19.8	-20	82.9	26.36	78.5	25.87	69.2	25.10	69.2	24.36	68.7	23.61	64.3	22.80
	-18.8	-19	82.9	26.14	78.5	25.63	72.5	24.85	71.1	24.10	68.7	23.37	64.3	22.54
	-16.7	-17	82.9	25.69	78.5	25.10	73.6	24.33	71.1	23.58	68.7	22.85	64.3	21.99
	-13.7	-15	82.9	25.04	78.5	24.37	73.6	23.58	71.1	22.83	68.7	22.10	64.3	21.20
	-11.8	-13	82.9	24.64	78.5	23.90	73.6	23.10	71.1	22.37	68.7	21.62	64.3	20.70
	-9.8	-11	82.9	24.21	78.5	23.42	73.6	22.60	71.1	21.86	68.7	21.13	64.3	20.18
	-9.5	-10	82.9	24.14	78.5	23.34	73.6	22.53	71.1	21.79	68.7	21.05	64.3	20.10
	-8.5	-9.1	82.9	23.93	78.5	23.09	73.6	22.27	71.1	21.54	68.7	20.81	64.3	19.83
	-7.0	-7.6	82.9	23.61	78.5	22.72	73.6	21.90	71.1	21.16	68.7	20.43	64.3	19.44
	-5.0	-5.6	82.9	23.18	78.5	22.23	73.6	21.40	71.1	20.67	68.7	19.94	64.3	18.92
	-3.0	-3.7	82.9	22.74	78.5	21.75	73.6	20.89	71.1	20.16	68.7	19.44	64.3	18.39
	0.0	-0.7	82.9	22.10	78.5	21.01	73.6	20.15	71.1	19.42	68.7	18.70	64.3	17.60
	3.0	2.2	82.9	21.45	78.5	20.27	73.6	19.40	71.1	18.67	68.7	17.95	64.3	16.81
	5.0	4.1	82.9	21.02	78.5	19.78	73.6	18.89	71.1	18.18	68.7	17.45	64.3	16.29
	7.0	6	82.9	20.59	78.5	19.29	73.6	18.39	71.1	17.67	68.7	16.95	64.3	15.76
	9.0	7.9	82.9	18.38	78.5	17.21	73.6	16.41	71.1	15.77	68.7	15.13	64.3	14.07
	11.0	9.8	82.9	17.16	78.5	16.08	73.6	15.32	71.1	14.73	68.7	14.12	64.3	13.14
	13.0	11.8	82.9	16.08	78.5	15.06	73.6	14.36	71.1	13.79	68.7	13.23	64.3	12.31
15.0	13.7	82.9	15.19	78.5	14.23	73.6	13.56	71.1	13.04	68.7	12.50	64.3	11.63	
50	-19.8	-20	69.2	23.61	65.3	22.78	61.3	22.01	59.4	21.23	57.4	20.50	53.5	19.73
	-18.8	-19	69.2	23.35	65.3	22.51	61.3	21.75	59.4	20.97	57.4	20.25	53.5	19.46
	-16.7	-17	69.2	22.80	65.3	21.95	61.3	21.19	59.4	20.43	57.4	19.73	53.5	18.93
	-13.7	-15	69.2	22.02	65.3	21.14	61.3	20.41	59.4	19.63	57.4	18.97	53.5	18.16
	-11.8	-13	69.2	21.52	65.3	20.62	61.3	19.92	59.4	19.14	57.4	18.50	53.5	17.68
	-9.8	-11	69.2	21.00	65.3	20.08	61.3	19.39	59.4	18.62	57.4	18.00	53.5	17.17
	-9.5	-10	69.2	20.92	65.3	20.00	61.3	19.31	59.4	18.54	57.4	17.92	53.5	17.09
	-8.5	-9.1	69.2	20.65	65.3	19.73	61.3	19.05	59.4	18.28	57.4	17.68	53.5	16.84
	-7.0	-7.6	69.2	20.27	65.3	19.33	61.3	18.65	59.4	17.89	57.4	17.30	53.5	16.45
	-5.0	-5.6	69.2	19.75	65.3	18.79	61.3	18.13	59.4	17.36	57.4	16.79	53.5	15.93
	-3.0	-3.7	69.2	19.22	65.3	18.25	61.3	17.60	59.4	16.84	57.4	16.30	53.5	15.42
	0.0	-0.7	69.2	18.44	65.3	17.44	61.3	16.82	59.4	16.06	57.4	15.55	53.5	14.66
	3.0	2.2	69.2	17.65	65.3	16.63	61.3	16.03	59.4	15.28	57.4	14.79	53.5	13.89
	5.0	4.1	69.2	17.14	65.3	16.09	61.3	15.51	59.4	14.76	57.4	14.29	53.5	13.38
	7.0	6	69.2	16.62	65.3	15.55	61.3	14.98	59.4	14.23	57.4	13.79	53.5	12.87
	9.0	7.9	69.2	15.00	65.3	14.04	61.3	13.53	59.4	12.85	57.4	12.45	53.5	11.62
	11.0	9.8	69.2	14.04	65.3	13.14	61.3	12.66	59.4	12.02	57.4	11.66	53.5	10.88
	13.0	11.8	69.2	13.18	65.3	12.34	61.3	11.88	59.4	11.29	57.4	10.94	53.5	10.21
15.0	13.7	69.2	12.47	65.3	11.67	61.3	11.24	59.4	10.69	57.4	10.35	53.5	9.66	

Note

1. TC: Total Capacity(kW), PI: Power Input(kW, Comp. + Outdoor fan motor)
2. Capacity tables show the average value of conditions which may occur.
3. In the range beyond the operation limit of the outdoor unit, continuous operation and performance can not be guaranteed. When selecting the outdoor units, avoid the air temperature range that is not guaranteed continuous operation.

7. Capacity Tables

◆ A(C)RUN460LLS5

Combination (%)	Outdoor air temp.		Heating Capacity (46HP)											
			Indoor air temp. °C DB											
	°C DB	°C WB	16		18		20		21		22		24	
		TC	PI	TC	PI	TC	PI	TC	PI	TC	PI	TC	PI	
130	-19.8	-20	74.6	30.86	74.6	32.04	74.1	33.08	74.1	34.67	74.1	36.19	74.1	38.58
	-18.8	-19	78.2	31.65	78.2	32.84	77.7	33.88	77.7	35.47	77.7	36.98	77.7	39.37
	-16.7	-17	85.8	33.32	85.8	34.52	85.3	35.55	85.3	37.15	85.3	38.65	85.3	41.04
	-13.7	-15	96.6	35.71	96.6	36.91	96.1	37.94	96.1	39.53	96.1	41.04	96.1	40.58
	-11.8	-13	102.1	37.22	102.1	38.41	101.4	39.45	101.4	41.04	101.4	40.82	101.4	40.29
	-9.8	-11	107.8	38.82	107.8	40.00	107.1	41.04	107.1	40.91	107.1	40.58	107.1	39.99
	-9.5	-10	110.4	39.06	110.4	40.24	109.7	41.04	109.7	40.89	108.0	40.55	108.0	39.95
	-8.5	-9.1	118.9	39.85	118.9	41.04	118.2	41.04	118.2	40.82	110.8	40.43	110.8	39.79
	-7.0	-7.6	131.8	41.04	131.8	41.15	130.9	41.03	130.9	40.72	130.9	40.24	120.0	39.56
	-5.0	-5.6	148.9	41.40	148.9	41.30	147.9	41.01	147.9	40.58	147.9	40.00	127.3	39.25
	-3.0	-3.7	166.1	41.76	166.1	41.45	165.0	41.01	161.9	40.44	156.2	39.76	134.5	38.95
	0.0	-0.7	166.5	42.31	166.5	41.66	166.0	40.99	161.9	40.24	156.2	39.41	145.2	38.49
	3.0	2.2	166.5	42.85	166.5	41.88	166.0	40.97	161.9	40.03	156.2	39.05	145.4	38.04
	5.0	4.1	166.5	43.21	166.5	42.03	166.0	40.96	161.9	39.90	156.2	38.81	145.4	37.73
	7.0	6	166.5	43.58	166.5	42.17	166.0	40.96	161.9	39.76	156.2	38.57	145.4	37.42
	9.0	7.9	166.5	44.00	166.5	42.58	166.0	41.35	161.9	40.14	156.2	38.95	145.4	37.78
	11.0	9.8	166.5	44.87	166.5	43.42	166.0	42.15	161.9	40.93	156.2	39.71	145.4	38.52
13.0	11.8	166.5	45.72	166.5	44.25	166.0	42.96	161.9	41.71	156.2	40.47	145.4	39.25	
15.0	13.7	166.5	46.58	166.5	45.08	166.0	43.77	161.9	42.50	156.2	41.23	145.4	40.00	
120	-19.8	-20	74.1	32.04	74.1	33.08	73.6	34.67	73.6	36.19	73.6	38.58	73.6	40.24
	-18.8	-19	77.7	32.84	77.7	33.88	77.2	35.47	77.2	36.98	77.2	39.37	77.2	41.04
	-16.7	-17	85.2	34.52	85.2	35.55	84.6	37.15	84.6	38.65	84.6	41.04	84.6	40.75
	-13.7	-15	95.9	36.91	95.9	37.94	95.4	39.53	95.4	41.04	95.4	40.67	95.4	40.33
	-11.8	-13	101.4	38.41	101.4	39.45	100.7	41.04	100.7	40.80	100.7	40.43	100.7	40.05
	-9.8	-11	107.1	40.00	107.1	41.04	106.4	40.85	106.4	40.55	106.4	40.19	106.4	39.78
	-9.5	-10	109.6	40.24	109.6	41.03	109.0	40.82	109.0	40.52	109.0	40.14	109.0	39.73
	-8.5	-9.1	118.1	41.04	118.1	40.96	117.3	40.72	117.3	40.39	113.8	40.02	113.8	39.59
	-7.0	-7.6	130.9	41.05	130.9	40.87	130.0	40.57	130.0	40.21	119.3	39.83	119.3	39.38
	-5.0	-5.6	147.9	41.06	147.9	40.74	147.0	40.38	147.0	39.95	147.0	39.59	126.4	39.10
	-3.0	-3.7	163.4	41.06	163.4	40.62	156.9	40.18	151.8	39.70	147.0	39.34	133.5	38.82
	0.0	-0.7	165.1	41.08	163.4	40.43	156.9	39.88	151.8	39.32	147.0	38.96	136.6	38.40
	3.0	2.2	165.1	41.08	163.4	40.24	156.9	39.59	151.8	38.95	147.0	38.59	136.6	37.97
	5.0	4.1	165.1	41.09	163.4	40.11	156.9	39.39	151.8	38.70	147.0	38.33	136.6	37.68
	7.0	6	165.1	41.10	163.4	39.99	156.9	39.20	151.8	38.45	147.0	38.09	136.6	37.41
	9.0	7.9	165.1	41.30	163.4	40.19	156.9	39.39	151.8	38.64	147.0	38.28	136.6	37.59
	11.0	9.8	165.1	41.91	163.4	40.77	156.9	39.97	151.8	39.20	147.0	38.84	136.6	38.14
13.0	11.8	165.1	42.51	163.4	41.35	156.9	40.55	151.8	39.77	147.0	39.39	136.6	38.69	
15.0	13.7	165.1	43.10	163.4	41.93	156.9	41.11	151.8	40.31	147.0	39.94	136.6	39.22	
110	-19.8	-20	73.6	33.08	73.6	34.67	73.2	36.19	73.2	38.58	73.2	40.24	73.2	41.04
	-18.8	-19	77.2	33.88	77.2	35.47	76.8	36.98	76.8	39.37	76.8	41.04	76.8	40.82
	-16.7	-17	84.8	35.55	84.8	37.15	84.2	38.65	84.2	41.04	84.2	40.64	84.2	40.34
	-13.7	-15	95.4	37.94	95.4	39.53	94.9	41.04	94.9	40.48	94.9	40.07	94.9	39.66
	-11.8	-13	100.8	39.45	100.8	41.04	100.2	40.67	100.2	40.12	100.2	39.69	100.2	39.23
	-9.8	-11	106.5	41.04	106.5	40.65	105.8	40.28	105.8	39.73	105.8	39.32	105.8	38.77
	-9.5	-10	109.0	40.99	109.0	40.60	108.3	40.22	108.3	39.68	108.3	39.25	108.3	38.70
	-8.5	-9.1	117.5	40.81	117.5	40.41	116.8	40.02	116.8	39.49	113.7	39.06	113.7	38.48
	-7.0	-7.6	130.2	40.53	130.2	40.12	129.3	39.73	129.3	39.20	119.3	38.77	119.3	38.14
	-5.0	-5.6	141.7	40.17	141.7	39.73	140.8	39.34	136.2	38.82	124.9	38.38	122.9	37.68
	-3.0	-3.7	150.0	39.81	150.0	39.35	140.8	38.95	136.2	38.45	131.6	38.00	122.9	37.23
	0.0	-0.7	158.7	39.26	150.0	38.77	140.8	38.36	136.2	37.87	131.6	37.42	122.9	36.55
	3.0	2.2	158.7	38.72	150.0	38.19	140.8	37.78	136.2	37.30	131.6	36.84	122.9	35.87
	5.0	4.1	158.7	38.35	150.0	37.80	140.8	37.39	136.2	36.93	131.6	36.47	122.9	35.41
	7.0	6	158.7	37.99	150.0	37.41	140.8	37.00	136.2	36.55	131.6	36.08	122.9	34.96
	9.0	7.9	158.7	37.96	150.0	37.39	140.8	36.97	136.2	36.52	131.6	36.06	122.9	34.93
	11.0	9.8	158.7	38.30	150.0	37.72	140.8	37.30	136.2	36.84	131.6	36.37	122.9	35.25
13.0	11.8	158.7	38.62	150.0	38.04	140.8	37.61	136.2	37.15	131.6	36.68	122.9	35.55	
15.0	13.7	158.7	38.93	150.0	38.34	140.8	37.91	136.2	37.45	131.6	36.97	122.9	35.82	

Note

1. TC: Total Capacity(kW), PI : Power Input(kW, Comp. + Outdoor fan motor)
2. Capacity tables show the average value of conditions which may occur.
3. In the range beyond the operation limit of the outdoor unit, continuous operation and performance can not be guaranteed. When selecting the outdoor units, avoid the air temperature range that is not guaranteed continuous operation.

7. Capacity Tables

Combination (%)		Heating Capacity (46HP)												
		Outdoor air temp.		Indoor air temp. °C DB										
		°C DB	°C WB	16		18		20		21		22		24
		TC	PI	TC	PI	TC	PI	TC	PI	TC	PI	TC	PI	
100	-19.8	-20	73.4	34.44	73.4	35.76	72.9	36.88	72.9	38.99	72.9	40.48	72.9	41.04
	-18.8	-19	76.9	35.10	76.4	36.42	76.4	37.68	76.4	39.66	76.4	41.04	76.4	40.66
	-16.7	-17	83.9	36.48	83.9	37.81	83.9	39.35	83.4	41.04	83.4	40.31	83.4	39.86
	-13.7	-15	95.0	38.46	95.0	39.79	94.5	41.04	94.5	40.09	94.5	39.27	94.5	38.72
	-11.8	-13	100.3	39.73	99.8	41.04	99.8	40.49	99.8	39.48	99.8	38.60	99.8	37.99
	-9.8	-11	105.9	41.04	105.9	40.46	105.3	39.90	105.3	38.84	105.3	37.90	105.3	37.22
	-9.5	-10	108.4	40.97	108.4	40.38	107.9	39.82	107.9	38.74	107.9	37.80	107.9	37.11
	-8.5	-9.1	116.8	40.72	116.8	40.09	116.3	39.52	124.7	38.43	120.5	37.44	112.3	36.73
	-7.0	-7.6	131.6	40.33	131.1	39.66	128.8	39.08	124.7	37.95	120.5	36.93	112.3	36.16
	-5.0	-5.6	137.3	39.83	136.0	39.08	128.8	38.50	124.7	37.31	120.5	36.23	112.3	35.39
	-3.0	-3.7	141.3	39.32	137.1	38.50	128.8	37.92	124.7	36.67	120.5	35.53	112.3	34.63
	0.0	-0.7	145.3	38.55	137.1	37.64	128.8	37.05	124.7	35.72	120.5	34.48	112.3	33.48
	3.0	2.2	145.3	37.79	137.1	36.77	128.8	36.16	124.7	34.76	120.5	33.43	112.3	32.34
	5.0	4.1	145.3	37.29	137.1	36.20	128.8	35.58	124.7	34.13	120.5	32.73	112.3	31.57
	7.0	6	145.3	36.77	137.1	35.62	128.8	35.00	124.7	33.48	120.5	32.03	112.3	30.82
	9.0	7.9	145.3	36.26	137.1	35.12	128.8	34.52	124.7	33.02	120.5	31.60	112.3	30.39
11.0	9.8	145.3	36.09	137.1	34.95	128.8	34.35	124.7	32.86	120.5	31.45	112.3	30.24	
13.0	11.8	145.3	35.88	137.1	34.76	128.8	34.15	124.7	32.67	120.5	31.26	112.3	30.06	
15.0	13.7	145.3	35.63	137.1	34.52	128.8	33.92	124.7	32.45	120.5	31.04	112.3	29.86	
90	-19.8	-20	73.1	32.45	73.1	34.84	72.6	36.50	72.6	37.30	72.6	36.77	72.6	35.85
	-18.8	-19	76.9	33.24	76.4	35.63	76.1	37.30	76.1	37.05	76.1	36.51	76.1	35.55
	-16.7	-17	83.9	34.91	83.9	37.30	83.5	36.84	83.5	36.53	83.5	35.96	83.5	34.93
	-13.7	-15	95.0	37.30	95.0	36.70	94.0	36.19	94.0	35.78	94.0	35.17	94.0	34.06
	-11.8	-13	100.3	36.96	99.8	36.33	99.3	35.78	99.3	35.31	99.3	34.67	99.3	33.51
	-9.8	-11	105.9	36.60	105.9	35.92	104.9	35.34	104.9	34.81	104.9	34.14	96.3	32.92
	-9.5	-10	108.4	36.55	108.4	35.87	107.4	35.29	107.4	34.73	107.4	34.06	98.6	32.83
	-8.5	-9.1	116.8	36.38	116.1	35.67	115.7	35.07	114.1	34.49	110.6	33.80	102.6	32.54
	-7.0	-7.6	131.6	36.11	125.2	35.37	117.8	34.74	114.1	34.11	110.6	33.40	102.6	32.10
	-5.0	-5.6	133.0	35.75	125.2	34.97	117.8	34.30	114.1	33.61	110.6	32.87	102.6	31.52
	-3.0	-3.7	133.0	35.39	125.2	34.57	117.8	33.87	114.1	33.11	110.6	32.35	102.6	30.94
	0.0	-0.7	133.0	34.86	125.2	33.97	117.8	33.22	114.1	32.37	110.6	31.55	102.6	30.06
	3.0	2.2	133.0	34.32	125.2	33.37	117.8	32.56	114.1	31.62	110.6	30.76	102.6	29.18
	5.0	4.1	133.0	33.96	125.2	32.97	117.8	32.13	114.1	31.11	110.6	30.24	102.6	28.60
	7.0	6	133.0	33.60	125.2	32.57	117.8	31.70	114.1	30.61	110.6	29.71	102.6	28.02
	9.0	7.9	133.0	33.14	125.2	32.13	117.8	31.26	114.1	30.20	110.6	29.30	102.6	27.63
11.0	9.8	133.0	32.68	125.2	31.67	117.8	30.83	114.1	29.78	110.6	28.89	102.6	27.25	
13.0	11.8	133.0	32.22	125.2	31.23	117.8	30.39	114.1	29.35	110.6	28.48	102.6	26.86	
15.0	13.7	133.0	31.76	125.2	30.78	117.8	29.96	114.1	28.94	110.6	28.07	102.6	26.48	
80	-19.8	-20	72.3	28.22	72.3	30.61	72.3	33.08	72.3	32.57	72.3	31.81	72.3	30.99
	-18.8	-19	75.8	29.02	75.8	33.08	75.8	32.85	75.8	32.32	75.8	31.55	75.8	30.73
	-16.7	-17	83.5	33.08	83.5	32.64	83.5	32.37	83.5	31.80	83.5	31.02	83.5	30.17
	-13.7	-15	98.4	32.52	96.4	32.03	94.0	31.69	94.0	31.04	94.0	30.25	91.7	29.37
	-11.8	-13	106.4	32.16	103.3	31.65	99.3	31.26	99.3	30.57	98.6	29.77	91.7	28.87
	-9.8	-11	109.7	31.79	106.5	31.24	104.9	30.80	102.3	30.07	98.6	29.26	91.7	28.34
	-9.5	-10	110.4	31.72	107.2	31.17	105.4	30.73	102.3	29.99	98.6	29.19	91.7	28.25
	-8.5	-9.1	114.5	31.53	112.3	30.97	105.4	30.51	102.3	29.74	98.6	28.94	91.7	27.98
	-7.0	-7.6	119.1	31.26	112.3	30.66	105.4	30.16	102.3	29.36	98.6	28.56	91.7	27.59
	-5.0	-5.6	119.1	30.88	112.3	30.25	105.4	29.71	102.3	28.87	98.6	28.05	91.7	27.06
	-3.0	-3.7	119.1	30.51	112.3	29.84	105.4	29.25	102.3	28.36	98.6	27.54	91.7	26.53
	0.0	-0.7	119.1	29.94	112.3	29.23	105.4	28.56	102.3	27.61	98.6	26.77	91.7	25.73
	3.0	2.2	119.1	29.38	112.3	28.61	105.4	27.88	102.3	26.86	98.6	26.02	91.7	24.93
	5.0	4.1	119.1	29.00	112.3	28.20	105.4	27.43	102.3	26.35	98.6	25.51	91.7	24.40
	7.0	6	119.1	28.63	112.3	27.79	105.4	26.97	102.3	25.85	98.6	25.00	91.7	23.87
	9.0	7.9	119.1	28.27	112.3	26.09	105.4	25.32	102.3	24.28	98.6	23.48	91.7	22.42
11.0	9.8	119.1	24.94	112.3	24.22	105.4	23.51	102.3	22.52	98.6	21.79	91.7	20.80	
13.0	11.8	119.1	23.29	112.3	22.61	105.4	21.94	102.3	21.03	98.6	20.34	91.7	19.42	
15.0	13.7	119.1	21.92	112.3	21.29	105.4	20.66	102.3	19.79	98.6	19.14	91.7	18.28	

Note

1. TC: Total Capacity(kW), PI: Power Input(kW, Comp. + Outdoor fan motor)
2. Capacity tables show the average value of conditions which may occur.
3. In the range beyond the operation limit of the outdoor unit, continuous operation and performance can not be guaranteed. When selecting the outdoor units, avoid the air temperature range that is not guaranteed continuous operation.

7. Capacity Tables

Combination (%)		Heating Capacity (46HP)												
		Outdoor air temp.		Indoor air temp. °C DB										
		°C DB	°C WB	16		18		20		21		22		24
		TC	PI	TC	PI	TC	PI	TC	PI	TC	PI	TC	PI	
70	-19.8	-20	72.3	29.89	72.3	30.69	72.3	30.16	72.3	29.33	72.3	28.54	72.3	27.67
	-18.8	-19	75.8	30.69	75.8	30.44	75.8	29.91	75.8	29.07	75.8	28.28	75.8	27.39
	-16.7	-17	83.5	30.22	83.5	29.91	83.5	29.35	83.5	28.49	83.5	27.72	83.5	26.80
	-13.7	-15	101.0	29.55	95.4	29.15	89.7	28.56	86.7	27.69	84.1	26.92	78.4	25.95
	-11.8	-13	101.0	29.12	95.4	28.67	89.7	28.06	86.7	27.16	84.1	26.41	78.4	25.42
	-9.8	-11	101.0	28.68	95.4	28.17	89.7	27.54	86.7	26.63	84.1	25.88	78.4	24.86
	-9.5	-10	101.0	28.61	95.4	28.09	89.7	27.45	86.7	26.55	84.1	25.80	78.4	24.77
	-8.5	-9.1	101.0	28.39	95.4	27.84	89.7	27.20	86.7	26.27	84.1	25.54	78.4	24.50
	-7.0	-7.6	101.0	28.05	95.4	27.45	89.7	26.80	86.7	25.87	84.1	25.13	78.4	24.07
	-5.0	-5.6	101.0	27.61	95.4	26.96	89.7	26.27	86.7	25.32	84.1	24.60	78.4	23.51
	-3.0	-3.7	101.0	27.16	95.4	26.45	89.7	25.75	86.7	24.79	84.1	24.07	78.4	22.94
	0.0	-0.7	101.0	26.49	95.4	25.69	89.7	24.96	86.7	23.97	84.1	23.27	78.4	22.09
	3.0	2.2	101.0	25.82	95.4	24.93	89.7	24.17	86.7	23.16	84.1	22.47	78.4	21.26
	5.0	4.1	101.0	25.37	95.4	24.43	89.7	23.65	86.7	22.62	84.1	21.94	78.4	20.69
	7.0	6	101.0	24.93	95.4	23.92	89.7	23.12	86.7	22.08	84.1	21.41	78.4	20.13
	9.0	7.9	101.0	22.50	95.4	21.60	89.7	20.88	86.7	19.94	84.1	19.33	78.4	18.18
	11.0	9.8	101.0	20.95	95.4	20.11	89.7	19.44	86.7	18.56	84.1	18.00	78.4	16.92
13.0	11.8	101.0	19.60	95.4	18.82	89.7	18.19	86.7	17.36	84.1	16.84	78.4	15.83	
15.0	13.7	101.0	18.49	95.4	17.74	89.7	17.14	86.7	16.37	84.1	15.88	78.4	14.92	
60	-19.8	-20	86.7	28.30	82.1	27.77	72.3	26.96	72.3	26.15	71.8	25.35	67.2	24.48
	-18.8	-19	86.7	28.07	82.1	27.51	75.8	26.68	74.3	25.88	71.8	25.09	67.2	24.20
	-16.7	-17	86.7	27.59	82.1	26.96	76.9	26.12	74.3	25.32	71.8	24.53	67.2	23.61
	-13.7	-15	86.7	26.89	82.1	26.17	76.9	25.32	74.3	24.52	71.8	23.73	67.2	22.76
	-11.8	-13	86.7	26.46	82.1	25.66	76.9	24.80	74.3	24.02	71.8	23.22	67.2	22.23
	-9.8	-11	86.7	26.00	82.1	25.14	76.9	24.26	74.3	23.47	71.8	22.69	67.2	21.66
	-9.5	-10	86.7	25.92	82.1	25.06	76.9	24.19	74.3	23.39	71.8	22.60	67.2	21.58
	-8.5	-9.1	86.7	25.69	82.1	24.79	76.9	23.92	74.3	23.13	71.8	22.34	67.2	21.29
	-7.0	-7.6	86.7	25.35	82.1	24.40	76.9	23.51	74.3	22.72	71.8	21.94	67.2	20.88
	-5.0	-5.6	86.7	24.89	82.1	23.87	76.9	22.98	74.3	22.19	71.8	21.41	67.2	20.31
	-3.0	-3.7	86.7	24.42	82.1	23.35	76.9	22.43	74.3	21.65	71.8	20.88	67.2	19.75
	0.0	-0.7	86.7	23.73	82.1	22.55	76.9	21.63	74.3	20.85	71.8	20.07	67.2	18.90
	3.0	2.2	86.7	23.03	82.1	21.77	76.9	20.83	74.3	20.05	71.8	19.27	67.2	18.05
	5.0	4.1	86.7	22.57	82.1	21.24	76.9	20.28	74.3	19.51	71.8	18.73	67.2	17.49
	7.0	6	86.7	22.11	82.1	20.71	76.9	19.74	74.3	18.97	71.8	18.20	67.2	16.92
	9.0	7.9	86.7	19.73	82.1	18.48	76.9	17.62	74.3	16.93	71.8	16.24	67.2	15.11
	11.0	9.8	86.7	18.42	82.1	17.26	76.9	16.44	74.3	15.81	71.8	15.16	67.2	14.10
13.0	11.8	86.7	17.26	82.1	16.17	76.9	15.41	74.3	14.81	71.8	14.21	67.2	13.21	
15.0	13.7	86.7	16.31	82.1	15.28	76.9	14.56	74.3	14.00	71.8	13.42	67.2	12.48	
50	-19.8	-20	72.3	25.35	68.3	24.46	64.1	23.64	62.1	22.79	60.0	22.02	55.9	21.18
	-18.8	-19	72.3	25.07	68.3	24.17	64.1	23.35	62.1	22.52	60.0	21.75	55.9	20.90
	-16.7	-17	72.3	24.48	68.3	23.57	64.1	22.76	62.1	21.93	60.0	21.18	55.9	20.33
	-13.7	-15	72.3	23.64	68.3	22.70	64.1	21.92	62.1	21.08	60.0	20.37	55.9	19.50
	-11.8	-13	72.3	23.11	68.3	22.14	64.1	21.39	62.1	20.55	60.0	19.87	55.9	18.98
	-9.8	-11	72.3	22.55	68.3	21.56	64.1	20.82	62.1	19.99	60.0	19.32	55.9	18.43
	-9.5	-10	72.3	22.46	68.3	21.48	64.1	20.74	62.1	19.91	60.0	19.24	55.9	18.35
	-8.5	-9.1	72.3	22.18	68.3	21.19	64.1	20.45	62.1	19.63	60.0	18.98	55.9	18.08
	-7.0	-7.6	72.3	21.76	68.3	20.76	64.1	20.03	62.1	19.21	60.0	18.57	55.9	17.67
	-5.0	-5.6	72.3	21.20	68.3	20.18	64.1	19.46	62.1	18.64	60.0	18.03	55.9	17.11
	-3.0	-3.7	72.3	20.64	68.3	19.60	64.1	18.90	62.1	18.08	60.0	17.50	55.9	16.56
	0.0	-0.7	72.3	19.80	68.3	18.73	64.1	18.06	62.1	17.24	60.0	16.69	55.9	15.74
	3.0	2.2	72.3	18.95	68.3	17.86	64.1	17.21	62.1	16.40	60.0	15.88	55.9	14.92
	5.0	4.1	72.3	18.40	68.3	17.28	64.1	16.65	62.1	15.84	60.0	15.35	55.9	14.36
	7.0	6	72.3	17.84	68.3	16.70	64.1	16.08	62.1	15.28	60.0	14.80	55.9	13.81
	9.0	7.9	72.3	16.10	68.3	15.08	64.1	14.53	62.1	13.80	60.0	13.37	55.9	12.48
	11.0	9.8	72.3	15.07	68.3	14.11	64.1	13.59	62.1	12.91	60.0	12.51	55.9	11.68
13.0	11.8	72.3	14.15	68.3	13.25	64.1	12.76	62.1	12.12	60.0	11.75	55.9	10.96	
15.0	13.7	72.3	13.39	68.3	12.53	64.1	12.07	62.1	11.47	60.0	11.12	55.9	10.37	

Note

1. TC: Total Capacity(kW), PI: Power Input(kW, Comp. + Outdoor fan motor)
2. Capacity tables show the average value of conditions which may occur.
3. In the range beyond the operation limit of the outdoor unit, continuous operation and performance can not be guaranteed. When selecting the outdoor units, avoid the air temperature range that is not guaranteed continuous operation.

7. Capacity Tables

◆ A(C)RUN480LLS5

Combination (%)		Outdoor air temp.		Heating Capacity (48HP)											
				Indoor air temp. °C DB											
		°C DB	°C WB	16		18		20		21		22		24	
		TC	PI	TC	PI	TC	PI	TC	PI	TC	PI	TC	PI		
130	-19.8	-20	77.8	33.76	77.8	35.06	77.3	36.19	77.3	37.94	77.3	39.60	77.3	42.22	
	-18.8	-19	81.6	34.62	81.6	35.93	81.0	37.07	81.0	38.81	81.0	40.46	81.0	43.08	
	-16.7	-17	89.5	36.46	89.5	37.77	89.0	38.89	89.0	40.64	89.0	42.30	89.0	44.91	
	-13.7	-15	100.8	39.07	100.8	40.38	100.2	41.51	100.2	43.25	100.2	44.91	100.2	44.41	
	-11.8	-13	106.5	40.73	106.5	42.03	105.8	43.17	105.8	44.91	105.8	46.67	105.8	44.09	
	-9.8	-11	112.5	42.48	112.5	43.78	111.7	44.91	111.7	44.76	111.7	44.41	111.7	43.76	
	-9.5	-10	115.2	42.74	115.2	44.04	114.5	44.91	114.5	44.74	112.7	44.37	112.7	43.71	
	-8.5	-9.1	124.1	43.61	124.1	44.91	123.3	44.91	123.3	44.67	115.6	44.24	115.6	43.55	
	-7.0	-7.6	137.5	44.91	137.5	45.03	136.6	44.90	136.6	44.56	136.6	44.04	125.2	43.29	
	-5.0	-5.6	155.4	45.31	155.4	45.19	154.4	44.88	154.4	44.41	154.4	43.78	132.8	42.95	
	-3.0	-3.7	173.3	45.70	173.3	45.36	172.2	44.87	168.9	44.26	163.0	43.52	140.3	42.62	
	0.0	-0.7	173.7	46.30	173.7	45.59	173.2	44.86	168.9	44.03	163.0	43.12	151.5	42.11	
	3.0	2.2	173.7	46.90	173.7	45.83	173.2	44.84	168.9	43.81	163.0	42.73	151.7	41.62	
	5.0	4.1	173.7	47.29	173.7	45.99	173.2	44.82	168.9	43.66	163.0	42.47	151.7	41.29	
	7.0	6	173.7	47.69	173.7	46.15	173.2	44.82	168.9	43.51	163.0	42.21	151.7	40.95	
	9.0	7.9	173.7	48.15	173.7	46.60	173.2	45.25	168.9	43.93	163.0	42.62	151.7	41.35	
11.0	9.8	173.7	49.10	173.7	47.51	173.2	46.13	168.9	44.78	163.0	43.46	151.7	42.15		
13.0	11.8	173.7	50.03	173.7	48.42	173.2	47.01	168.9	45.64	163.0	44.28	151.7	42.96		
15.0	13.7	173.7	50.97	173.7	49.33	173.2	47.90	168.9	46.50	163.0	45.12	151.7	43.77		
120	-19.8	-20	77.3	35.06	77.3	36.19	76.8	37.94	76.8	39.60	76.8	42.22	76.8	44.04	
	-18.8	-19	81.0	35.93	81.0	37.07	80.5	38.81	80.5	40.46	80.5	43.08	80.5	44.91	
	-16.7	-17	88.8	37.77	88.8	38.89	88.3	40.64	88.3	42.30	88.3	44.91	88.3	44.59	
	-13.7	-15	100.1	40.38	100.1	41.51	99.5	43.25	99.5	44.91	99.5	44.50	99.5	44.13	
	-11.8	-13	105.8	42.03	105.8	43.17	105.1	44.91	105.1	44.65	105.1	44.24	105.1	43.83	
	-9.8	-11	111.7	43.78	111.7	44.91	111.0	44.70	111.0	44.38	111.0	43.98	111.0	43.53	
	-9.5	-10	114.3	44.04	114.3	44.89	113.7	44.67	113.7	44.34	113.7	43.93	113.7	43.48	
	-8.5	-9.1	123.2	44.91	123.2	44.82	122.4	44.56	122.4	44.20	118.8	43.79	118.8	43.33	
	-7.0	-7.6	136.6	44.92	136.6	44.72	135.7	44.39	135.7	44.00	124.4	43.59	124.4	43.10	
	-5.0	-5.6	154.3	44.93	154.3	44.58	153.4	44.18	153.4	43.72	153.4	43.32	131.8	42.78	
	-3.0	-3.7	170.5	44.93	170.5	44.45	163.8	43.97	158.4	43.44	153.4	43.04	139.2	42.48	
	0.0	-0.7	172.3	44.95	170.5	44.24	163.8	43.65	158.4	43.03	153.4	42.63	142.5	42.02	
	3.0	2.2	172.3	44.96	170.5	44.03	163.8	43.33	158.4	42.62	153.4	42.22	142.5	41.55	
	5.0	4.1	172.3	44.97	170.5	43.89	163.8	43.11	158.4	42.35	153.4	41.95	142.5	41.24	
	7.0	6	172.3	44.97	170.5	43.76	163.8	42.90	158.4	42.07	153.4	41.68	142.5	40.93	
	9.0	7.9	172.3	45.20	170.5	43.98	163.8	43.10	158.4	42.28	153.4	41.89	142.5	41.14	
11.0	9.8	172.3	45.86	170.5	44.62	163.8	43.74	158.4	42.90	153.4	42.50	142.5	41.74		
13.0	11.8	172.3	46.52	170.5	45.25	163.8	44.37	158.4	43.51	153.4	43.10	142.5	42.34		
15.0	13.7	172.3	47.16	170.5	45.88	163.8	44.98	158.4	44.11	153.4	43.70	142.5	42.92		
110	-19.8	-20	76.8	36.19	76.8	37.94	76.4	39.60	76.4	42.22	76.4	44.04	76.4	44.91	
	-18.8	-19	80.5	37.07	80.5	38.81	80.1	40.46	80.1	43.08	80.1	44.91	80.1	44.67	
	-16.7	-17	88.4	38.89	88.4	40.64	87.8	42.30	87.8	44.91	87.8	44.47	87.8	44.15	
	-13.7	-15	99.5	41.51	99.5	43.25	98.9	44.91	98.9	44.29	98.9	43.84	98.9	43.40	
	-11.8	-13	105.2	43.17	105.2	44.91	104.5	44.51	104.5	43.90	104.5	43.44	104.5	42.93	
	-9.8	-11	111.1	44.91	111.1	44.49	110.4	44.08	110.4	43.48	110.4	43.02	110.4	42.43	
	-9.5	-10	113.7	44.86	113.7	44.43	113.0	44.02	113.0	43.42	113.0	42.95	113.0	42.36	
	-8.5	-9.1	122.6	44.65	122.6	44.22	121.8	43.80	121.8	43.21	118.7	42.75	118.7	42.11	
	-7.0	-7.6	135.8	44.35	135.8	43.90	135.0	43.48	135.0	42.90	124.5	42.43	124.5	41.74	
	-5.0	-5.6	147.9	43.96	147.9	43.48	147.0	43.05	142.2	42.48	130.4	42.00	128.3	41.24	
	-3.0	-3.7	156.6	43.56	156.6	43.06	147.0	42.62	142.2	42.07	137.4	41.59	128.3	40.74	
	0.0	-0.7	165.6	42.97	156.6	42.43	147.0	41.98	142.2	41.44	137.4	40.95	128.3	40.00	
	3.0	2.2	165.6	42.37	156.6	41.79	147.0	41.34	142.2	40.82	137.4	40.32	128.3	39.25	
	5.0	4.1	165.6	41.96	156.6	41.36	147.0	40.91	142.2	40.41	137.4	39.90	128.3	38.75	
	7.0	6	165.6	41.57	156.6	40.94	147.0	40.48	142.2	40.00	137.4	39.48	128.3	38.26	
	9.0	7.9	165.6	41.54	156.6	40.92	147.0	40.45	142.2	39.96	137.4	39.46	128.3	38.23	
11.0	9.8	165.6	41.91	156.6	41.27	147.0	40.82	142.2	40.32	137.4	39.80	128.3	38.58		
13.0	11.8	165.6	42.26	156.6	41.63	147.0	41.16	142.2	40.66	137.4	40.13	128.3	38.90		
15.0	13.7	165.6	42.60	156.6	41.96	147.0	41.48	142.2	40.98	137.4	40.45	128.3	39.20		

Note

1. TC: Total Capacity(kW), PI : Power Input(kW, Comp. + Outdoor fan motor)
2. Capacity tables show the average value of conditions which may occur.
3. In the range beyond the operation limit of the outdoor unit, continuous operation and performance can not be guaranteed. When selecting the outdoor units, avoid the air temperature range that is not guaranteed continuous operation.

7. Capacity Tables

Combination (%)		Heating Capacity (48HP)												
		Outdoor air temp.		Indoor air temp. °C DB										
		°C DB	°C WB	16		18		20		21		22		24
		TC	PI	TC	PI	TC	PI	TC	PI	TC	PI	TC	PI	
100	-19.8	-20	76.6	37.69	76.6	39.13	76.0	40.35	76.0	42.67	76.0	44.30	76.0	44.91
	-18.8	-19	80.3	38.40	79.7	39.85	79.7	41.23	79.7	43.40	79.7	44.91	79.7	44.50
	-16.7	-17	87.5	39.92	87.5	41.37	87.5	43.06	86.9	44.91	86.9	44.11	86.9	43.62
	-13.7	-15	99.1	42.09	99.1	43.54	98.6	44.91	98.6	43.87	98.6	42.97	98.6	42.37
	-11.8	-13	104.7	43.47	104.1	44.91	104.1	44.31	104.1	43.20	104.1	42.24	104.1	41.57
	-9.8	-11	110.4	44.91	110.4	44.28	109.9	43.67	109.9	42.50	109.9	41.48	109.9	40.73
	-9.5	-10	113.1	44.84	113.1	44.19	112.6	43.57	112.6	42.40	112.6	41.36	112.6	40.61
	-8.5	-9.1	121.9	44.56	121.9	43.87	121.3	43.25	130.1	42.05	125.8	40.98	117.2	40.19
	-7.0	-7.6	137.4	44.13	136.8	43.40	134.4	42.77	130.1	41.53	125.8	40.41	117.2	39.57
	-5.0	-5.6	143.3	43.58	141.9	42.77	134.4	42.13	130.1	40.83	125.8	39.64	117.2	38.73
	-3.0	-3.7	147.5	43.03	143.0	42.13	134.4	41.50	130.1	40.13	125.8	38.88	117.2	37.89
	0.0	-0.7	151.6	42.19	143.0	41.19	134.4	40.54	130.1	39.08	125.8	37.74	117.2	36.64
	3.0	2.2	151.6	41.35	143.0	40.24	134.4	39.57	130.1	38.04	125.8	36.58	117.2	35.39
	5.0	4.1	151.6	40.80	143.0	39.61	134.4	38.94	130.1	37.34	125.8	35.82	117.2	34.55
	7.0	6	151.6	40.24	143.0	38.97	134.4	38.30	130.1	36.64	125.8	35.05	117.2	33.72
	9.0	7.9	151.6	39.68	143.0	38.43	134.4	37.77	130.1	36.13	125.8	34.58	117.2	33.25
	11.0	9.8	151.6	39.49	143.0	38.25	134.4	37.59	130.1	35.96	125.8	34.41	117.2	33.09
	13.0	11.8	151.6	39.27	143.0	38.03	134.4	37.37	130.1	35.75	125.8	34.21	117.2	32.90
15.0	13.7	151.6	38.99	143.0	37.77	134.4	37.12	130.1	35.51	125.8	33.97	117.2	32.67	
90	-19.8	-20	76.2	35.50	76.2	38.12	75.7	39.94	75.7	40.82	75.7	40.24	75.7	39.23
	-18.8	-19	80.3	36.37	79.7	38.99	79.4	40.82	79.4	40.54	79.4	39.96	79.4	38.90
	-16.7	-17	87.5	38.20	87.5	40.82	87.1	40.32	87.1	39.98	87.1	39.35	87.1	38.23
	-13.7	-15	99.1	40.82	99.1	40.17	98.1	39.61	98.1	39.16	98.1	38.48	98.1	37.27
	-11.8	-13	104.7	40.45	104.1	39.75	103.6	39.16	103.6	38.64	103.6	37.94	103.6	36.67
	-9.8	-11	110.4	40.06	110.4	39.31	109.5	38.68	109.5	38.09	109.5	37.36	100.5	36.02
	-9.5	-10	113.1	40.00	113.1	39.25	112.1	38.61	112.1	38.00	112.1	37.27	102.9	35.93
	-8.5	-9.1	121.9	39.81	121.1	39.03	120.8	38.37	119.1	37.74	115.4	36.99	107.1	35.61
	-7.0	-7.6	137.4	39.51	130.7	38.71	123.0	38.02	119.1	37.33	115.4	36.55	107.1	35.13
	-5.0	-5.6	138.8	39.12	130.7	38.26	123.0	37.54	119.1	36.78	115.4	35.97	107.1	34.49
	-3.0	-3.7	138.8	38.73	130.7	37.83	123.0	37.07	119.1	36.23	115.4	35.40	107.1	33.85
	0.0	-0.7	138.8	38.15	130.7	37.18	123.0	36.35	119.1	35.42	115.4	34.53	107.1	32.90
	3.0	2.2	138.8	37.55	130.7	36.52	123.0	35.63	119.1	34.60	115.4	33.66	107.1	31.93
	5.0	4.1	138.8	37.16	130.7	36.08	123.0	35.16	119.1	34.04	115.4	33.09	107.1	31.29
	7.0	6	138.8	36.77	130.7	35.65	123.0	34.69	119.1	33.50	115.4	32.51	107.1	30.66
	9.0	7.9	138.8	36.27	130.7	35.16	123.0	34.21	119.1	33.05	115.4	32.06	107.1	30.23
	11.0	9.8	138.8	35.76	130.7	34.66	123.0	33.74	119.1	32.58	115.4	31.61	107.1	29.82
	13.0	11.8	138.8	35.26	130.7	34.17	123.0	33.26	119.1	32.12	115.4	31.17	107.1	29.39
15.0	13.7	138.8	34.75	130.7	33.69	123.0	32.79	119.1	31.67	115.4	30.72	107.1	28.98	
80	-19.8	-20	75.5	30.88	75.5	33.49	75.5	36.20	75.5	35.65	75.5	34.81	75.5	33.91
	-18.8	-19	79.0	31.75	79.0	36.20	79.0	35.95	79.0	35.37	79.0	34.53	79.0	33.62
	-16.7	-17	87.1	36.20	87.1	35.72	87.1	35.42	87.1	34.80	87.1	33.95	87.1	33.01
	-13.7	-15	102.6	35.59	100.6	35.05	98.1	34.68	98.1	33.97	98.1	33.11	95.7	32.14
	-11.8	-13	111.0	35.19	107.8	34.63	103.6	34.20	103.6	33.46	102.8	32.58	95.7	31.59
	-9.8	-11	114.5	34.78	111.1	34.18	109.5	33.70	106.7	32.90	102.8	32.02	95.7	31.01
	-9.5	-10	115.2	34.71	111.8	34.11	110.0	33.63	106.7	32.82	102.8	31.95	95.7	30.92
	-8.5	-9.1	119.5	34.51	117.2	33.89	110.0	33.38	106.7	32.54	102.8	31.67	95.7	30.62
	-7.0	-7.6	124.3	34.20	117.2	33.55	110.0	33.01	106.7	32.13	102.8	31.25	95.7	30.19
	-5.0	-5.6	124.3	33.79	117.2	33.10	110.0	32.51	106.7	31.59	102.8	30.69	95.7	29.61
	-3.0	-3.7	124.3	33.38	117.2	32.66	110.0	32.01	106.7	31.03	102.8	30.14	95.7	29.03
	0.0	-0.7	124.3	32.77	117.2	31.98	110.0	31.26	106.7	30.21	102.8	29.30	95.7	28.16
	3.0	2.2	124.3	32.15	117.2	31.31	110.0	30.51	106.7	29.39	102.8	28.47	95.7	27.28
	5.0	4.1	124.3	31.74	117.2	30.86	110.0	30.02	106.7	28.83	102.8	27.91	95.7	26.70
	7.0	6	124.3	31.33	117.2	30.41	110.0	29.52	106.7	28.29	102.8	27.35	95.7	26.12
	9.0	7.9	124.3	29.41	117.2	28.55	110.0	27.71	106.7	26.56	102.8	25.69	95.7	24.53
	11.0	9.8	124.3	27.30	117.2	26.51	110.0	25.72	106.7	24.65	102.8	23.84	95.7	22.76
	13.0	11.8	124.3	25.48	117.2	24.74	110.0	24.01	106.7	23.01	102.8	22.25	95.7	21.25
15.0	13.7	124.3	23.99	117.2	23.29	110.0	22.60	106.7	21.66	102.8	20.95	95.7	20.01	

Note

1. TC: Total Capacity(kW), PI: Power Input(kW, Comp. + Outdoor fan motor)
2. Capacity tables show the average value of conditions which may occur.
3. In the range beyond the operation limit of the outdoor unit, continuous operation and performance can not be guaranteed. When selecting the outdoor units, avoid the air temperature range that is not guaranteed continuous operation.

7. Capacity Tables

Combination (%)		Heating Capacity (48HP)												
		Outdoor air temp.		Indoor air temp. °C DB										
		°C DB	°C WB	16		18		20		21		22		24
		TC	PI	TC	PI	TC	PI	TC	PI	TC	PI	TC	PI	
70	-19.8	-20	75.5	32.71	75.5	33.58	75.5	33.01	75.5	32.10	75.5	31.23	75.5	30.28
	-18.8	-19	79.0	33.58	79.0	33.31	79.0	32.72	79.0	31.81	79.0	30.95	79.0	29.97
	-16.7	-17	87.1	33.07	87.1	32.73	87.1	32.11	87.1	31.18	87.1	30.33	81.8	29.33
	-13.7	-15	105.4	32.33	99.5	31.90	93.6	31.25	90.4	30.30	87.7	29.46	81.8	28.40
	-11.8	-13	105.4	31.87	99.5	31.37	93.6	30.71	90.4	29.72	87.7	28.90	81.8	27.82
	-9.8	-11	105.4	31.38	99.5	30.82	93.6	30.13	90.4	29.14	87.7	28.32	81.8	27.20
	-9.5	-10	105.4	31.31	99.5	30.73	93.6	30.04	90.4	29.05	87.7	28.23	81.8	27.11
	-8.5	-9.1	105.4	31.06	99.5	30.46	93.6	29.76	90.4	28.75	87.7	27.95	81.8	26.80
	-7.0	-7.6	105.4	30.69	99.5	30.04	93.6	29.33	90.4	28.30	87.7	27.50	81.8	26.34
	-5.0	-5.6	105.4	30.21	99.5	29.50	93.6	28.75	90.4	27.71	87.7	26.92	81.8	25.72
	-3.0	-3.7	105.4	29.72	99.5	28.94	93.6	28.17	90.4	27.12	87.7	26.34	81.8	25.11
	0.0	-0.7	105.4	28.99	99.5	28.11	93.6	27.31	90.4	26.23	87.7	25.47	81.8	24.18
	3.0	2.2	105.4	28.25	99.5	27.28	93.6	26.45	90.4	25.35	87.7	24.59	81.8	23.26
	5.0	4.1	105.4	27.76	99.5	26.73	93.6	25.88	90.4	24.75	87.7	24.01	81.8	22.64
	7.0	6	105.4	27.28	99.5	26.18	93.6	25.30	90.4	24.16	87.7	23.43	81.8	22.03
	9.0	7.9	105.4	24.63	99.5	23.64	93.6	22.85	90.4	21.82	87.7	21.15	81.8	19.89
	11.0	9.8	105.4	22.93	99.5	22.01	93.6	21.28	90.4	20.31	87.7	19.69	81.8	18.52
	13.0	11.8	105.4	21.45	99.5	20.59	93.6	19.90	90.4	19.00	87.7	18.43	81.8	17.32
15.0	13.7	105.4	20.23	99.5	19.41	93.6	18.76	90.4	17.92	87.7	17.38	81.8	16.33	
60	-19.8	-20	90.4	30.97	85.6	30.39	75.5	29.49	75.5	28.62	74.9	27.74	70.1	26.79
	-18.8	-19	90.4	30.71	85.6	30.10	79.0	29.20	77.6	28.32	74.9	27.45	70.1	26.48
	-16.7	-17	90.4	30.18	85.6	29.49	80.3	28.58	77.6	27.70	74.9	26.84	70.1	25.83
	-13.7	-15	90.4	29.42	85.6	28.63	80.3	27.70	77.6	26.83	74.9	25.96	70.1	24.90
	-11.8	-13	90.4	28.95	85.6	28.08	80.3	27.14	77.6	26.28	74.9	25.41	70.1	24.32
	-9.8	-11	90.4	28.44	85.6	27.51	80.3	26.55	77.6	25.69	74.9	24.82	70.1	23.70
	-9.5	-10	90.4	28.36	85.6	27.42	80.3	26.47	77.6	25.59	74.9	24.73	70.1	23.61
	-8.5	-9.1	90.4	28.11	85.6	27.13	80.3	26.17	77.6	25.31	74.9	24.45	70.1	23.30
	-7.0	-7.6	90.4	27.74	85.6	26.70	80.3	25.72	77.6	24.86	74.9	24.01	70.1	22.84
	-5.0	-5.6	90.4	27.23	85.6	26.12	80.3	25.14	77.6	24.28	74.9	23.42	70.1	22.23
	-3.0	-3.7	90.4	26.72	85.6	25.55	80.3	24.55	77.6	23.69	74.9	22.84	70.1	21.61
	0.0	-0.7	90.4	25.97	85.6	24.68	80.3	23.67	77.6	22.81	74.9	21.97	70.1	20.68
	3.0	2.2	90.4	25.20	85.6	23.82	80.3	22.79	77.6	21.93	74.9	21.09	70.1	19.75
	5.0	4.1	90.4	24.70	85.6	23.24	80.3	22.19	77.6	21.35	74.9	20.50	70.1	19.13
	7.0	6	90.4	24.19	85.6	22.66	80.3	21.60	77.6	20.76	74.9	19.92	70.1	18.52
	9.0	7.9	90.4	21.59	85.6	20.22	80.3	19.28	77.6	18.53	74.9	17.77	70.1	16.53
	11.0	9.8	90.4	20.16	85.6	18.89	80.3	18.00	77.6	17.30	74.9	16.59	70.1	15.43
	13.0	11.8	90.4	18.89	85.6	17.69	80.3	16.87	77.6	16.20	74.9	15.55	70.1	14.46
15.0	13.7	90.4	17.84	85.6	16.72	80.3	15.94	77.6	15.32	74.9	14.69	70.1	13.66	
50	-19.8	-20	75.5	27.73	71.2	26.76	66.9	25.86	64.8	24.94	62.6	24.09	58.3	23.17
	-18.8	-19	75.5	27.43	71.2	26.45	66.9	25.55	64.8	24.63	62.6	23.79	58.3	22.86
	-16.7	-17	75.5	26.78	71.2	25.79	66.9	24.90	64.8	23.99	62.6	23.18	58.3	22.24
	-13.7	-15	75.5	25.87	71.2	24.84	66.9	23.98	64.8	23.07	62.6	22.29	58.3	21.33
	-11.8	-13	75.5	25.29	71.2	24.23	66.9	23.40	64.8	22.49	62.6	21.74	58.3	20.77
	-9.8	-11	75.5	24.67	71.2	23.59	66.9	22.78	64.8	21.87	62.6	21.14	58.3	20.17
	-9.5	-10	75.5	24.58	71.2	23.50	66.9	22.69	64.8	21.78	62.6	21.05	58.3	20.08
	-8.5	-9.1	75.5	24.27	71.2	23.18	66.9	22.38	64.8	21.48	62.6	20.77	58.3	19.78
	-7.0	-7.6	75.5	23.81	71.2	22.71	66.9	21.91	64.8	21.01	62.6	20.32	58.3	19.33
	-5.0	-5.6	75.5	23.20	71.2	22.08	66.9	21.30	64.8	20.40	62.6	19.73	58.3	18.72
	-3.0	-3.7	75.5	22.58	71.2	21.44	66.9	20.68	64.8	19.78	62.6	19.15	58.3	18.12
	0.0	-0.7	75.5	21.67	71.2	20.49	66.9	19.76	64.8	18.87	62.6	18.27	58.3	17.22
	3.0	2.2	75.5	20.74	71.2	19.54	66.9	18.83	64.8	17.95	62.6	17.38	58.3	16.32
	5.0	4.1	75.5	20.13	71.2	18.91	66.9	18.22	64.8	17.34	62.6	16.79	58.3	15.71
	7.0	6	75.5	19.52	71.2	18.27	66.9	17.60	64.8	16.72	62.6	16.20	58.3	15.12
	9.0	7.9	75.5	17.62	71.2	16.50	66.9	15.90	64.8	15.10	62.6	14.63	58.3	13.65
	11.0	9.8	75.5	16.49	71.2	15.44	66.9	14.87	64.8	14.13	62.6	13.69	58.3	12.78
	13.0	11.8	75.5	15.49	71.2	14.50	66.9	13.96	64.8	13.27	62.6	12.85	58.3	11.99
15.0	13.7	75.5	14.65	71.2	13.72	66.9	13.21	64.8	12.55	62.6	12.16	58.3	11.34	

Note

1. TC: Total Capacity(kW), PI: Power Input(kW, Comp. + Outdoor fan motor)
2. Capacity tables show the average value of conditions which may occur.
3. In the range beyond the operation limit of the outdoor unit, continuous operation and performance can not be guaranteed. When selecting the outdoor units, avoid the air temperature range that is not guaranteed continuous operation.

7. Capacity Tables

◆ A(C)RUN500LLS5

Combination (%)	Outdoor air temp.		Indoor air temp. °C DB											
	°C DB	°C WB	16		18		20		21		22		24	
			TC	PI	TC	PI	TC	PI	TC	PI	TC	PI	TC	PI
130	-19.8	-20	81.1	33.85	81.1	35.15	80.5	36.29	80.5	38.04	80.5	39.71	80.5	42.33
	-18.8	-19	84.9	34.72	84.9	36.03	84.4	37.17	84.4	38.92	84.4	40.57	84.4	43.20
	-16.7	-17	93.2	36.56	93.2	37.87	92.6	39.00	92.6	40.76	92.6	42.41	92.6	45.03
	-13.7	-15	105.0	39.18	105.0	40.49	104.4	41.62	104.4	43.37	104.4	45.03	104.4	44.53
	-11.8	-13	110.9	40.84	110.9	42.15	110.2	43.29	110.2	45.03	110.2	44.79	110.2	44.21
	-9.8	-11	117.1	42.59	117.1	43.89	116.3	45.03	116.3	44.88	116.3	44.53	116.3	43.87
	-9.5	-10	119.9	42.85	119.9	44.16	119.1	45.03	119.1	44.86	117.2	44.49	117.2	43.83
	-8.5	-9.1	129.2	43.72	129.2	45.03	128.4	45.03	128.4	44.79	120.3	44.36	120.3	43.66
	-7.0	-7.6	143.3	45.03	143.3	45.15	142.3	45.02	142.3	44.68	142.3	44.15	130.5	43.40
	-5.0	-5.6	162.0	45.43	162.0	45.31	160.9	45.00	160.9	44.53	160.9	43.89	138.4	43.07
	-3.0	-3.7	180.7	45.82	180.7	45.48	179.5	44.99	175.9	44.37	169.8	43.63	146.3	42.73
	0.0	-0.7	181.0	46.42	181.0	45.71	180.4	44.97	175.9	44.15	169.8	43.24	157.9	42.23
	3.0	2.2	181.0	47.02	181.0	45.95	180.4	44.96	175.9	43.92	169.8	42.84	158.1	41.73
	5.0	4.1	181.0	47.41	181.0	46.12	180.4	44.94	175.9	43.77	169.8	42.58	158.1	41.39
	7.0	6	181.0	47.82	181.0	46.27	180.4	44.93	175.9	43.62	169.8	42.32	158.1	41.06
	9.0	7.9	181.0	48.27	181.0	46.72	180.4	45.37	175.9	44.04	169.8	42.73	158.1	41.45
	11.0	9.8	181.0	49.22	181.0	47.63	180.4	46.25	175.9	44.90	169.8	43.57	158.1	42.26
13.0	11.8	181.0	50.16	181.0	48.55	180.4	47.13	175.9	45.76	169.8	44.40	158.1	43.07	
15.0	13.7	181.0	51.10	181.0	49.45	180.4	48.02	175.9	46.62	169.8	45.24	158.1	43.88	
120	-19.8	-20	80.5	35.15	80.5	36.29	79.9	38.04	79.9	39.71	79.9	42.33	79.9	44.16
	-18.8	-19	84.4	36.03	84.4	37.17	83.8	38.92	83.8	40.57	83.8	43.20	83.8	45.03
	-16.7	-17	92.5	37.87	92.5	39.00	91.9	40.76	91.9	42.41	91.9	45.03	91.9	44.71
	-13.7	-15	104.3	40.49	104.3	41.62	103.6	43.37	103.6	45.03	103.6	44.62	103.6	44.25
	-11.8	-13	110.1	42.15	110.1	43.29	109.4	45.03	109.4	44.77	109.4	44.36	109.4	43.95
	-9.8	-11	116.3	43.89	116.3	45.03	115.5	44.82	115.5	44.49	115.5	44.09	115.5	43.64
	-9.5	-10	119.0	44.16	119.0	45.01	118.3	44.79	118.3	44.45	118.3	44.04	118.3	43.59
	-8.5	-9.1	128.3	45.03	128.3	44.94	127.5	44.68	127.5	44.32	123.8	43.91	123.8	43.44
	-7.0	-7.6	142.3	45.04	142.3	44.84	141.3	44.51	141.3	44.11	129.7	43.70	129.7	43.21
	-5.0	-5.6	160.8	45.05	160.8	44.70	159.8	44.30	159.8	43.84	159.8	43.44	137.4	42.90
	-3.0	-3.7	177.6	45.05	177.6	44.56	170.6	44.08	165.0	43.56	159.8	43.16	145.2	42.59
	0.0	-0.7	179.5	45.07	177.6	44.36	170.6	43.76	165.0	43.14	159.8	42.75	148.4	42.13
	3.0	2.2	179.5	45.07	177.6	44.15	170.6	43.44	165.0	42.73	159.8	42.33	148.4	41.66
	5.0	4.1	179.5	45.09	177.6	44.01	170.6	43.22	165.0	42.46	159.8	42.06	148.4	41.35
	7.0	6	179.5	45.09	177.6	43.87	170.6	43.01	165.0	42.18	159.8	41.79	148.4	41.04
	9.0	7.9	179.5	45.31	177.6	44.09	170.6	43.22	165.0	42.39	159.8	41.99	148.4	41.25
	11.0	9.8	179.5	45.98	177.6	44.73	170.6	43.85	165.0	43.01	159.8	42.61	148.4	41.85
13.0	11.8	179.5	46.64	177.6	45.37	170.6	44.48	165.0	43.63	159.8	43.21	148.4	42.44	
15.0	13.7	179.5	47.28	177.6	46.00	170.6	45.10	165.0	44.23	159.8	43.81	148.4	43.03	
110	-19.8	-20	80.0	36.29	80.0	38.04	79.5	39.71	79.5	42.33	79.5	44.16	79.5	45.03
	-18.8	-19	83.8	37.17	83.8	38.92	83.4	40.57	83.4	43.20	83.4	45.03	83.4	44.79
	-16.7	-17	92.1	39.00	92.1	40.76	91.5	42.41	91.5	45.03	91.5	44.59	91.5	44.26
	-13.7	-15	103.7	41.62	103.7	43.37	103.1	45.03	103.1	44.41	103.1	43.96	103.1	43.52
	-11.8	-13	109.5	43.29	109.5	45.03	108.8	44.62	108.8	44.02	108.8	43.55	108.8	43.04
	-9.8	-11	115.7	45.03	115.7	44.61	114.9	44.19	114.9	43.59	114.9	43.14	114.9	42.54
	-9.5	-10	118.4	44.98	118.4	44.55	117.6	44.13	117.6	43.53	117.6	43.07	117.6	42.47
	-8.5	-9.1	127.6	44.77	127.6	44.34	126.8	43.91	126.8	43.33	123.5	42.86	123.5	42.22
	-7.0	-7.6	141.5	44.47	141.5	44.02	140.6	43.59	140.6	43.01	129.4	42.54	129.4	41.85
	-5.0	-5.6	154.0	44.08	154.0	43.59	153.1	43.16	148.1	42.60	135.5	42.11	133.6	41.34
	-3.0	-3.7	163.1	43.68	163.1	43.17	153.1	42.73	148.1	42.18	143.1	41.70	133.6	40.85
	0.0	-0.7	172.5	43.08	163.1	42.54	153.1	42.09	148.1	41.55	143.1	41.06	133.6	40.10
	3.0	2.2	172.5	42.48	163.1	41.90	153.1	41.45	148.1	40.93	143.1	40.42	133.6	39.36
	5.0	4.1	172.5	42.07	163.1	41.47	153.1	41.02	148.1	40.51	143.1	40.01	133.6	38.85
	7.0	6	172.5	41.68	163.1	41.05	153.1	40.59	148.1	40.10	143.1	39.58	133.6	38.36
	9.0	7.9	172.5	41.64	163.1	41.02	153.1	40.56	148.1	40.07	143.1	39.56	133.6	38.33
	11.0	9.8	172.5	42.02	163.1	41.38	153.1	40.93	148.1	40.42	143.1	39.90	133.6	38.68
13.0	11.8	172.5	42.37	163.1	41.73	153.1	41.27	148.1	40.76	143.1	40.24	133.6	39.00	
15.0	13.7	172.5	42.71	163.1	42.07	153.1	41.59	148.1	41.08	143.1	40.56	133.6	39.30	

Note

1. TC: Total Capacity(kW), PI : Power Input(kW, Comp. + Outdoor fan motor)

2. Capacity tables show the average value of conditions which may occur.

3. In the range beyond the operation limit of the outdoor unit, continuous operation and performance can not be guaranteed. When selecting the outdoor units, avoid the air temperature range that is not guaranteed continuous operation.

7. Capacity Tables

Combination (%)		Heating Capacity (50HP)												
		Outdoor air temp.		Indoor air temp. °C DB										
		°C DB	°C WB	16		18		20		21		22		24
		TC	PI	TC	PI	TC	PI	TC	PI	TC	PI	TC	PI	
100	-19.8	-20	79.7	37.79	79.7	39.24	79.2	40.46	79.2	42.79	79.2	44.41	79.2	45.03
	-18.8	-19	83.6	38.51	83.0	39.96	83.0	41.34	83.0	43.51	83.0	45.03	83.0	44.62
	-16.7	-17	91.1	40.03	91.1	41.49	91.1	43.18	90.6	45.03	90.6	44.23	90.6	43.74
	-13.7	-15	103.2	42.21	103.2	43.66	102.7	45.03	102.7	43.98	102.7	43.08	102.7	42.48
	-11.8	-13	109.0	43.59	108.4	45.03	108.4	44.43	108.4	43.31	108.4	42.35	108.4	41.68
	-9.8	-11	115.0	45.03	115.0	44.40	114.4	43.78	114.4	42.62	114.4	41.59	114.4	40.84
	-9.5	-10	117.8	44.96	117.8	44.30	117.2	43.69	117.2	42.51	117.2	41.47	117.2	40.72
	-8.5	-9.1	126.9	44.67	126.9	43.99	126.3	43.37	135.5	42.17	131.0	41.08	122.1	40.30
	-7.0	-7.6	143.1	44.25	142.5	43.52	140.0	42.88	135.5	41.64	131.0	40.52	122.1	39.67
	-5.0	-5.6	149.3	43.70	147.8	42.88	140.0	42.24	135.5	40.93	131.0	39.75	122.1	38.83
	-3.0	-3.7	153.6	43.14	149.0	42.24	140.0	41.60	135.5	40.24	131.0	38.98	122.1	37.99
	0.0	-0.7	157.9	42.30	149.0	41.30	140.0	40.65	135.5	39.19	131.0	37.84	122.1	36.74
	3.0	2.2	157.9	41.46	149.0	40.35	140.0	39.68	135.5	38.14	131.0	36.68	122.1	35.48
	5.0	4.1	157.9	40.91	149.0	39.71	140.0	39.04	135.5	37.44	131.0	35.91	122.1	34.64
	7.0	6	157.9	40.35	149.0	39.08	140.0	38.40	135.5	36.73	131.0	35.14	122.1	33.81
	9.0	7.9	157.9	39.79	149.0	38.53	140.0	37.87	135.5	36.23	131.0	34.67	122.1	33.34
	11.0	9.8	157.9	39.60	149.0	38.35	140.0	37.69	135.5	36.06	131.0	34.50	122.1	33.17
	13.0	11.8	157.9	39.37	149.0	38.13	140.0	37.46	135.5	35.85	131.0	34.30	122.1	32.98
15.0	13.7	157.9	39.09	149.0	37.87	140.0	37.22	135.5	35.60	131.0	34.06	122.1	32.76	
90	-19.8	-20	79.4	35.60	79.4	38.23	78.8	40.05	78.8	40.93	78.8	40.35	78.8	39.33
	-18.8	-19	83.6	36.47	83.0	39.09	82.7	40.93	82.7	40.65	82.7	40.07	82.7	39.00
	-16.7	-17	91.1	38.31	91.1	40.93	90.7	40.43	90.7	40.09	90.7	39.45	90.7	38.33
	-13.7	-15	103.2	40.93	103.2	40.27	102.2	39.71	102.2	39.26	102.2	38.59	102.2	37.37
	-11.8	-13	109.0	40.56	108.4	39.86	107.9	39.26	107.9	38.74	107.9	38.04	107.9	36.77
	-9.8	-11	115.0	40.16	115.0	39.42	114.0	38.78	114.0	38.19	114.0	37.46	104.6	36.12
	-9.5	-10	117.8	40.11	117.8	39.36	116.7	38.72	116.7	38.11	116.7	37.37	107.1	36.02
	-8.5	-9.1	126.9	39.92	126.1	39.13	125.8	38.48	124.1	37.84	120.2	37.09	111.6	35.70
	-7.0	-7.6	143.1	39.62	136.1	38.81	128.1	38.12	124.1	37.43	120.2	36.64	111.6	35.22
	-5.0	-5.6	144.6	39.23	136.1	38.37	128.1	37.64	124.1	36.88	120.2	36.06	111.6	34.58
	-3.0	-3.7	144.6	38.83	136.1	37.93	128.1	37.16	124.1	36.33	120.2	35.49	111.6	33.94
	0.0	-0.7	144.6	38.25	136.1	37.27	128.1	36.45	124.1	35.51	120.2	34.62	111.6	32.98
	3.0	2.2	144.6	37.65	136.1	36.62	128.1	35.73	124.1	34.69	120.2	33.75	111.6	32.01
	5.0	4.1	144.6	37.26	136.1	36.17	128.1	35.25	124.1	34.13	120.2	33.17	111.6	31.38
	7.0	6	144.6	36.87	136.1	35.74	128.1	34.78	124.1	33.59	120.2	32.59	111.6	30.74
	9.0	7.9	144.6	36.36	136.1	35.25	128.1	34.30	124.1	33.13	120.2	32.14	111.6	30.31
	11.0	9.8	144.6	35.86	136.1	34.75	128.1	33.83	124.1	32.67	120.2	31.70	111.6	29.89
	13.0	11.8	144.6	35.35	136.1	34.26	128.1	33.34	124.1	32.20	120.2	31.25	111.6	29.47
15.0	13.7	144.6	34.84	136.1	33.77	128.1	32.87	124.1	31.75	120.2	30.80	111.6	29.05	
80	-19.8	-20	78.6	30.96	78.6	33.58	78.6	36.30	78.6	35.74	78.6	34.90	78.6	34.00
	-18.8	-19	82.3	31.84	82.3	36.30	82.3	36.04	82.3	35.46	82.3	34.62	82.3	33.71
	-16.7	-17	90.7	36.30	90.7	35.82	90.7	35.52	90.7	34.89	90.7	34.04	90.7	33.10
	-13.7	-15	106.9	35.68	104.8	35.14	102.2	34.77	102.2	34.06	102.2	33.20	99.7	32.22
	-11.8	-13	115.6	35.29	112.3	34.73	107.9	34.30	107.9	33.55	107.1	32.67	99.7	31.67
	-9.8	-11	119.1	34.88	115.7	34.28	114.0	33.79	111.2	32.99	107.1	32.11	99.7	31.09
	-9.5	-10	120.0	34.81	116.5	34.20	114.6	33.72	111.2	32.91	107.1	32.03	99.7	31.00
	-8.5	-9.1	124.5	34.60	122.1	33.98	114.6	33.47	111.2	32.63	107.1	31.75	99.7	30.70
	-7.0	-7.6	129.5	34.30	122.1	33.64	114.6	33.10	111.2	32.22	107.1	31.34	99.7	30.27
	-5.0	-5.6	129.5	33.88	122.1	33.19	114.6	32.59	111.2	31.67	107.1	30.78	99.7	29.69
	-3.0	-3.7	129.5	33.47	122.1	32.74	114.6	32.09	111.2	31.11	107.1	30.22	99.7	29.11
	0.0	-0.7	129.5	32.85	122.1	32.07	114.6	31.34	111.2	30.29	107.1	29.38	99.7	28.23
	3.0	2.2	129.5	32.23	122.1	31.39	114.6	30.59	111.2	29.46	107.1	28.55	99.7	27.35
	5.0	4.1	129.5	31.82	122.1	30.94	114.6	30.10	111.2	28.91	107.1	27.99	99.7	26.77
	7.0	6	129.5	31.41	122.1	30.49	114.6	29.59	111.2	28.36	107.1	27.43	99.7	26.19
	9.0	7.9	129.5	29.49	122.1	28.63	114.6	27.78	111.2	26.63	107.1	25.76	99.7	24.59
	11.0	9.8	129.5	27.37	122.1	26.58	114.6	25.79	111.2	24.71	107.1	23.90	99.7	22.82
	13.0	11.8	129.5	25.55	122.1	24.80	114.6	24.07	111.2	23.07	107.1	22.31	99.7	21.30
15.0	13.7	129.5	24.05	122.1	23.35	114.6	22.66	111.2	21.71	107.1	21.00	99.7	20.06	

Note

1. TC: Total Capacity(kW), PI: Power Input(kW, Comp. + Outdoor fan motor)
2. Capacity tables show the average value of conditions which may occur.
3. In the range beyond the operation limit of the outdoor unit, continuous operation and performance can not be guaranteed. When selecting the outdoor units, avoid the air temperature range that is not guaranteed continuous operation.

7. Capacity Tables

Combination (%)		Heating Capacity (50HP)												
		Outdoor air temp.		Indoor air temp. °C DB										
		°C DB	°C WB	16		18		20		21		22		24
		TC	PI	TC	PI	TC	PI	TC	PI	TC	PI	TC	PI	
70	-19.8	-20	78.6	32.80	78.6	33.68	78.6	33.10	78.6	32.18	78.6	31.32	78.6	30.36
	-18.8	-19	82.3	33.68	82.3	33.40	82.3	32.81	82.3	31.89	82.3	31.03	82.3	30.05
	-16.7	-17	90.7	33.16	90.7	32.82	90.7	32.20	90.7	31.26	90.7	30.42	85.2	29.41
	-13.7	-15	109.8	32.42	103.7	31.99	97.5	31.34	94.2	30.38	91.4	29.54	85.2	28.47
	-11.8	-13	109.8	31.96	103.7	31.45	97.5	30.79	94.2	29.80	91.4	28.98	85.2	27.89
	-9.8	-11	109.8	31.47	103.7	30.90	97.5	30.21	94.2	29.22	91.4	28.40	85.2	27.27
	-9.5	-10	109.8	31.39	103.7	30.82	97.5	30.12	94.2	29.13	91.4	28.31	85.2	27.18
	-8.5	-9.1	109.8	31.15	103.7	30.55	97.5	29.84	94.2	28.83	91.4	28.02	85.2	26.88
	-7.0	-7.6	109.8	30.78	103.7	30.12	97.5	29.41	94.2	28.38	91.4	27.58	85.2	26.41
	-5.0	-5.6	109.8	30.29	103.7	29.57	97.5	28.83	94.2	27.78	91.4	26.99	85.2	25.79
	-3.0	-3.7	109.8	29.80	103.7	29.02	97.5	28.25	94.2	27.20	91.4	26.41	85.2	25.17
	0.0	-0.7	109.8	29.07	103.7	28.19	97.5	27.39	94.2	26.30	91.4	25.53	85.2	24.24
	3.0	2.2	109.8	28.32	103.7	27.35	97.5	26.52	94.2	25.41	91.4	24.65	85.2	23.32
	5.0	4.1	109.8	27.84	103.7	26.80	97.5	25.94	94.2	24.82	91.4	24.07	85.2	22.70
	7.0	6	109.8	27.35	103.7	26.25	97.5	25.37	94.2	24.22	91.4	23.49	85.2	22.08
	9.0	7.9	109.8	24.69	103.7	23.70	97.5	22.91	94.2	21.88	91.4	21.21	85.2	19.95
	11.0	9.8	109.8	22.99	103.7	22.07	97.5	21.33	94.2	20.36	91.4	19.75	85.2	18.57
13.0	11.8	109.8	21.51	103.7	20.64	97.5	19.95	94.2	19.05	91.4	18.47	85.2	17.37	
15.0	13.7	109.8	20.28	103.7	19.46	97.5	18.81	94.2	17.96	91.4	17.42	85.2	16.37	
60	-19.8	-20	94.2	31.05	89.2	30.47	78.6	29.57	78.6	28.69	78.1	27.82	73.0	26.86
	-18.8	-19	94.2	30.79	89.2	30.19	82.3	29.28	80.8	28.40	78.1	27.53	73.0	26.55
	-16.7	-17	94.2	30.27	89.2	29.57	83.6	28.66	80.8	27.78	78.1	26.91	73.0	25.90
	-13.7	-15	94.2	29.50	89.2	28.71	83.6	27.78	80.8	26.90	78.1	26.03	73.0	24.97
	-11.8	-13	94.2	29.03	89.2	28.15	83.6	27.21	80.8	26.35	78.1	25.47	73.0	24.39
	-9.8	-11	94.2	28.52	89.2	27.59	83.6	26.62	80.8	25.76	78.1	24.89	73.0	23.77
	-9.5	-10	94.2	28.44	89.2	27.49	83.6	26.54	80.8	25.66	78.1	24.80	73.0	23.67
	-8.5	-9.1	94.2	28.19	89.2	27.20	83.6	26.24	80.8	25.38	78.1	24.51	73.0	23.36
	-7.0	-7.6	94.2	27.81	89.2	26.77	83.6	25.79	80.8	24.93	78.1	24.07	73.0	22.90
	-5.0	-5.6	94.2	27.30	89.2	26.19	83.6	25.21	80.8	24.35	78.1	23.49	73.0	22.29
	-3.0	-3.7	94.2	26.79	89.2	25.62	83.6	24.61	80.8	23.75	78.1	22.90	73.0	21.67
	0.0	-0.7	94.2	26.03	89.2	24.74	83.6	23.73	80.8	22.87	78.1	22.02	73.0	20.74
	3.0	2.2	94.2	25.27	89.2	23.88	83.6	22.85	80.8	21.99	78.1	21.15	73.0	19.80
	5.0	4.1	94.2	24.76	89.2	23.30	83.6	22.25	80.8	21.41	78.1	20.55	73.0	19.18
	7.0	6	94.2	24.26	89.2	22.72	83.6	21.66	80.8	20.81	78.1	19.97	73.0	18.57
	9.0	7.9	94.2	21.65	89.2	20.27	83.6	19.33	80.8	18.58	78.1	17.82	73.0	16.57
	11.0	9.8	94.2	20.21	89.2	18.93	83.6	18.04	80.8	17.35	78.1	16.64	73.0	15.47
13.0	11.8	94.2	18.94	89.2	17.74	83.6	16.91	80.8	16.24	78.1	15.59	73.0	14.50	
15.0	13.7	94.2	17.89	89.2	16.76	83.6	15.98	80.8	15.36	78.1	14.73	73.0	13.70	
50	-19.8	-20	78.6	27.81	74.2	26.84	69.6	25.93	67.5	25.01	65.2	24.15	60.8	23.24
	-18.8	-19	78.6	27.51	74.2	26.52	69.6	25.62	67.5	24.70	65.2	23.86	60.8	22.93
	-16.7	-17	78.6	26.86	74.2	25.86	69.6	24.97	67.5	24.06	65.2	23.24	60.8	22.30
	-13.7	-15	78.6	25.94	74.2	24.90	69.6	24.05	67.5	23.13	65.2	22.35	60.8	21.39
	-11.8	-13	78.6	25.35	74.2	24.29	69.6	23.46	67.5	22.55	65.2	21.80	60.8	20.82
	-9.8	-11	78.6	24.74	74.2	23.66	69.6	22.84	67.5	21.93	65.2	21.20	60.8	20.22
	-9.5	-10	78.6	24.65	74.2	23.56	69.6	22.75	67.5	21.84	65.2	21.11	60.8	20.13
	-8.5	-9.1	78.6	24.33	74.2	23.25	69.6	22.44	67.5	21.54	65.2	20.82	60.8	19.83
	-7.0	-7.6	78.6	23.88	74.2	22.77	69.6	21.97	67.5	21.07	65.2	20.38	60.8	19.38
	-5.0	-5.6	78.6	23.26	74.2	22.14	69.6	21.35	67.5	20.45	65.2	19.78	60.8	18.77
	-3.0	-3.7	78.6	22.64	74.2	21.50	69.6	20.74	67.5	19.84	65.2	19.20	60.8	18.17
	0.0	-0.7	78.6	21.72	74.2	20.55	69.6	19.81	67.5	18.92	65.2	18.31	60.8	17.27
	3.0	2.2	78.6	20.79	74.2	19.59	69.6	18.88	67.5	18.00	65.2	17.42	60.8	16.37
	5.0	4.1	78.6	20.19	74.2	18.96	69.6	18.26	67.5	17.38	65.2	16.84	60.8	15.76
	7.0	6	78.6	19.57	74.2	18.32	69.6	17.65	67.5	16.76	65.2	16.24	60.8	15.15
	9.0	7.9	78.6	17.67	74.2	16.54	69.6	15.94	67.5	15.14	65.2	14.67	60.8	13.69
	11.0	9.8	78.6	16.54	74.2	15.48	69.6	14.91	67.5	14.16	65.2	13.73	60.8	12.81
13.0	11.8	78.6	15.53	74.2	14.54	69.6	14.00	67.5	13.30	65.2	12.89	60.8	12.03	
15.0	13.7	78.6	14.69	74.2	13.75	69.6	13.25	67.5	12.59	65.2	12.19	60.8	11.37	

Note

1. TC: Total Capacity(kW), PI: Power Input(kW, Comp. + Outdoor fan motor)
2. Capacity tables show the average value of conditions which may occur.
3. In the range beyond the operation limit of the outdoor unit, continuous operation and performance can not be guaranteed. When selecting the outdoor units, avoid the air temperature range that is not guaranteed continuous operation.

7. Capacity Tables

◆ A(C)RUN520LLS5

Combination (%)	Outdoor air temp.		Heating Capacity (52HP)											
			Indoor air temp. °C DB											
	°C DB	°C WB	16		18		20		21		22		24	
		TC	PI	TC	PI	TC	PI	TC	PI	TC	PI	TC	PI	
130	-19.8	-20	84.4	36.16	84.4	37.54	83.8	38.76	83.8	40.62	83.8	42.40	83.8	45.20
	-18.8	-19	88.4	37.08	88.4	38.48	87.8	39.70	87.8	41.56	87.8	43.32	87.8	46.12
	-16.7	-17	97.0	39.04	97.0	40.44	96.4	41.64	96.4	43.52	96.4	45.28	96.4	48.08
	-13.7	-15	109.2	41.84	109.2	43.24	108.6	44.44	108.6	46.30	108.6	48.08	108.6	47.54
	-11.8	-13	115.4	43.60	115.4	45.00	114.6	46.22	114.6	48.08	114.6	47.82	114.6	47.20
	-9.8	-11	121.8	45.48	121.8	46.86	121.0	48.08	121.0	47.92	121.0	47.54	121.0	46.84
	-9.5	-10	124.8	45.76	124.8	47.14	124.0	48.08	124.0	47.90	122.0	47.50	122.0	46.80
	-8.5	-9.1	134.4	46.68	134.4	48.08	133.6	48.08	133.6	47.82	125.2	47.36	125.2	46.62
	-7.0	-7.6	149.0	48.08	149.0	48.20	148.0	48.06	148.0	47.70	148.0	47.14	135.6	46.34
	-5.0	-5.6	168.4	48.50	168.4	48.38	167.2	48.04	167.2	47.54	167.2	46.86	143.8	45.98
	-3.0	-3.7	187.8	48.92	187.8	48.56	186.6	48.04	183.0	47.38	176.6	46.58	152.0	45.62
	0.0	-0.7	188.2	49.56	188.2	48.80	187.6	48.02	183.0	47.14	176.6	46.16	164.0	45.08
	3.0	2.2	188.2	50.20	188.2	49.06	187.6	48.00	183.0	46.90	176.6	45.74	164.4	44.56
	5.0	4.1	188.2	50.62	188.2	49.24	187.6	47.98	183.0	46.74	176.6	45.46	164.4	44.20
	7.0	6	188.2	51.06	188.2	49.40	187.6	47.98	183.0	46.58	176.6	45.18	164.4	43.84
	9.0	7.9	188.2	51.54	188.2	49.88	187.6	48.44	183.0	47.02	176.6	45.62	164.4	44.26
	11.0	9.8	188.2	52.56	188.2	50.86	187.6	49.38	183.0	47.94	176.6	46.52	164.4	45.12
13.0	11.8	188.2	53.56	188.2	51.84	187.6	50.32	183.0	48.86	176.6	47.40	164.4	45.98	
15.0	13.7	188.2	54.56	188.2	52.80	187.6	51.28	183.0	49.78	176.6	48.30	164.4	46.86	
120	-19.8	-20	83.8	37.54	83.8	38.76	83.2	40.62	83.2	42.40	83.2	45.20	83.2	47.14
	-18.8	-19	87.8	38.48	87.8	39.70	87.2	41.56	87.2	43.32	87.2	46.12	87.2	48.08
	-16.7	-17	96.2	40.44	96.2	41.64	95.6	43.52	95.6	45.28	95.6	48.08	95.6	47.74
	-13.7	-15	108.4	43.24	108.4	44.44	107.8	46.30	107.8	48.08	107.8	47.64	107.8	47.24
	-11.8	-13	114.6	45.00	114.6	46.22	113.8	48.08	113.8	47.80	113.8	47.36	113.8	46.92
	-9.8	-11	121.0	46.86	121.0	48.08	120.2	47.86	120.2	47.50	120.2	47.08	120.2	46.60
	-9.5	-10	123.8	47.14	123.8	48.06	123.2	47.82	123.2	47.46	123.2	47.02	123.2	46.54
	-8.5	-9.1	133.4	48.08	133.4	47.98	132.6	47.70	132.6	47.32	128.6	46.88	128.6	46.38
	-7.0	-7.6	148.0	48.08	148.0	47.88	147.0	47.52	147.0	47.10	134.8	46.66	134.8	46.14
	-5.0	-5.6	167.2	48.10	167.2	47.72	166.2	47.30	166.2	46.80	166.2	46.38	142.8	45.80
	-3.0	-3.7	184.8	48.10	184.8	47.58	177.4	47.06	171.6	46.50	166.2	46.08	150.8	45.48
	0.0	-0.7	186.6	48.12	184.8	47.36	177.4	46.72	171.6	46.06	166.2	45.64	154.4	44.98
	3.0	2.2	186.6	48.12	184.8	47.14	177.4	46.38	171.6	45.62	166.2	45.20	154.4	44.48
	5.0	4.1	186.6	48.14	184.8	46.98	177.4	46.14	171.6	45.34	166.2	44.90	154.4	44.14
	7.0	6	186.6	48.14	184.8	46.84	177.4	45.92	171.6	45.04	166.2	44.62	154.4	43.82
	9.0	7.9	186.6	48.38	184.8	47.08	177.4	46.14	171.6	45.26	166.2	44.84	154.4	44.04
	11.0	9.8	186.6	49.10	184.8	47.76	177.4	46.82	171.6	45.92	166.2	45.50	154.4	44.68
13.0	11.8	186.6	49.80	184.8	48.44	177.4	47.50	171.6	46.58	166.2	46.14	154.4	45.32	
15.0	13.7	186.6	50.48	184.8	49.12	177.4	48.16	171.6	47.22	166.2	46.78	154.4	45.94	
110	-19.8	-20	83.2	38.76	83.2	40.62	82.8	42.40	82.8	45.20	82.8	47.14	82.8	48.08
	-18.8	-19	87.2	39.70	87.2	41.56	86.8	43.32	86.8	46.12	86.8	48.08	86.8	47.82
	-16.7	-17	95.8	41.64	95.8	43.52	95.2	45.28	95.2	48.08	95.2	47.60	95.2	47.26
	-13.7	-15	107.8	44.44	107.8	46.30	107.2	48.08	107.2	47.42	107.2	46.94	107.2	46.46
	-11.8	-13	114.0	46.22	114.0	48.08	113.2	47.64	113.2	47.00	113.2	46.50	113.2	45.96
	-9.8	-11	120.4	48.08	120.4	47.62	119.6	47.18	119.6	46.54	119.6	46.06	119.6	45.42
	-9.5	-10	123.2	48.02	123.2	47.56	122.4	47.12	122.4	46.48	122.4	45.98	122.4	45.34
	-8.5	-9.1	132.8	47.80	132.8	47.34	132.0	46.88	132.0	46.26	128.6	45.76	128.6	45.08
	-7.0	-7.6	147.2	47.48	147.2	47.00	146.2	46.54	146.2	45.92	134.8	45.42	134.8	44.68
	-5.0	-5.6	160.2	47.06	160.2	46.54	159.2	46.08	154.0	45.48	141.2	44.96	139.0	44.14
	-3.0	-3.7	169.6	46.64	169.6	46.10	159.2	45.62	154.0	45.04	148.8	44.52	139.0	43.62
	0.0	-0.7	179.4	46.00	169.6	45.42	159.2	44.94	154.0	44.36	148.8	43.84	139.0	42.82
	3.0	2.2	179.4	45.36	169.6	44.74	159.2	44.26	154.0	43.70	148.8	43.16	139.0	42.02
	5.0	4.1	179.4	44.92	169.6	44.28	159.2	43.80	154.0	43.26	148.8	42.72	139.0	41.48
	7.0	6	179.4	44.50	169.6	43.82	159.2	43.34	154.0	42.82	148.8	42.26	139.0	40.96
	9.0	7.9	179.4	44.46	169.6	43.80	159.2	43.30	154.0	42.78	148.8	42.24	139.0	40.92
	11.0	9.8	179.4	44.86	169.6	44.18	159.2	43.70	154.0	43.16	148.8	42.60	139.0	41.30
13.0	11.8	179.4	45.24	169.6	44.56	159.2	44.06	154.0	43.52	148.8	42.96	139.0	41.64	
15.0	13.7	179.4	45.60	169.6	44.92	159.2	44.40	154.0	43.86	148.8	43.30	139.0	41.96	

Note

1. TC: Total Capacity(kW), PI : Power Input(kW, Comp. + Outdoor fan motor)
2. Capacity tables show the average value of conditions which may occur.
3. In the range beyond the operation limit of the outdoor unit, continuous operation and performance can not be guaranteed. When selecting the outdoor units, avoid the air temperature range that is not guaranteed continuous operation.

7. Capacity Tables

Combination (%)		Heating Capacity (52HP)												
		Outdoor air temp.		Indoor air temp. °C DB										
		°C DB	°C WB	16		18		20		21		22		24
		TC	PI	TC	PI	TC	PI	TC	PI	TC	PI	TC	PI	
100	-19.8	-20	83.0	40.36	83.0	41.90	82.4	43.20	82.4	45.68	82.4	47.42	82.4	48.08
	-18.8	-19	87.0	41.12	86.4	42.66	86.4	44.14	86.4	46.46	86.4	48.08	86.4	47.64
	-16.7	-17	94.8	42.74	94.8	44.30	94.8	46.10	94.2	48.08	94.2	47.22	94.2	46.70
	-13.7	-15	107.4	45.06	107.4	46.62	106.8	48.08	106.8	46.96	106.8	46.00	106.8	45.36
	-11.8	-13	113.4	46.54	112.8	48.08	112.8	47.44	112.8	46.24	112.8	45.22	112.8	44.50
	-9.8	-11	119.6	48.08	119.6	47.40	119.0	46.74	119.0	45.50	119.0	44.40	119.0	43.60
	-9.5	-10	122.6	48.00	122.6	47.30	122.0	46.64	122.0	45.38	122.0	44.28	122.0	43.48
	-8.5	-9.1	132.0	47.70	132.0	46.96	131.4	46.30	141.0	45.02	136.2	43.86	127.0	43.02
	-7.0	-7.6	148.8	47.24	148.2	46.46	145.6	45.78	141.0	44.46	136.2	43.26	127.0	42.36
	-5.0	-5.6	155.2	46.66	153.8	45.78	145.6	45.10	141.0	43.70	136.2	42.44	127.0	41.46
	-3.0	-3.7	159.8	46.06	155.0	45.10	145.6	44.42	141.0	42.96	136.2	41.62	127.0	40.56
	0.0	-0.7	164.2	45.16	155.0	44.10	145.6	43.40	141.0	41.84	136.2	40.40	127.0	39.22
	3.0	2.2	164.2	44.26	155.0	43.08	145.6	42.36	141.0	40.72	136.2	39.16	127.0	37.88
	5.0	4.1	164.2	43.68	155.0	42.40	145.6	41.68	141.0	39.98	136.2	38.34	127.0	36.98
	7.0	6	164.2	43.08	155.0	41.72	145.6	41.00	141.0	39.22	136.2	37.52	127.0	36.10
	9.0	7.9	164.2	42.48	155.0	41.14	145.6	40.44	141.0	38.68	136.2	37.02	127.0	35.60
	11.0	9.8	164.2	42.28	155.0	40.94	145.6	40.24	141.0	38.50	136.2	36.84	127.0	35.42
	13.0	11.8	164.2	42.04	155.0	40.72	145.6	40.00	141.0	38.28	136.2	36.62	127.0	35.22
15.0	13.7	164.2	41.74	155.0	40.44	145.6	39.74	141.0	38.02	136.2	36.36	127.0	34.98	
90	-19.8	-20	82.6	38.02	82.6	40.82	82.0	42.76	82.0	43.70	82.0	43.08	82.0	42.00
	-18.8	-19	87.0	38.94	86.4	41.74	86.0	43.70	86.0	43.40	86.0	42.78	86.0	41.64
	-16.7	-17	94.8	40.90	94.8	43.70	94.4	43.16	94.4	42.80	94.4	42.12	94.4	40.92
	-13.7	-15	107.4	43.70	107.4	43.00	106.2	42.40	106.2	41.92	106.2	41.20	106.2	39.90
	-11.8	-13	113.4	43.30	112.8	42.56	112.2	41.92	112.2	41.36	112.2	40.62	112.2	39.26
	-9.8	-11	119.6	42.88	119.6	42.08	118.6	41.40	118.6	40.78	118.6	40.00	108.8	38.56
	-9.5	-10	122.6	42.82	122.6	42.02	121.4	41.34	121.4	40.68	121.4	39.90	111.4	38.46
	-8.5	-9.1	132.0	42.62	131.2	41.78	130.8	41.08	129.0	40.40	125.0	39.60	116.0	38.12
	-7.0	-7.6	148.8	42.30	141.6	41.44	133.2	40.70	129.0	39.96	125.0	39.12	116.0	37.60
	-5.0	-5.6	150.4	41.88	141.6	40.96	133.2	40.18	129.0	39.38	125.0	38.50	116.0	36.92
	-3.0	-3.7	150.4	41.46	141.6	40.50	133.2	39.68	129.0	38.78	125.0	37.90	116.0	36.24
	0.0	-0.7	150.4	40.84	141.6	39.80	133.2	38.92	129.0	37.92	125.0	36.96	116.0	35.22
	3.0	2.2	150.4	40.20	141.6	39.10	133.2	38.14	129.0	37.04	125.0	36.04	116.0	34.18
	5.0	4.1	150.4	39.78	141.6	38.62	133.2	37.64	129.0	36.44	125.0	35.42	116.0	33.50
	7.0	6	150.4	39.36	141.6	38.16	133.2	37.14	129.0	35.86	125.0	34.80	116.0	32.82
	9.0	7.9	150.4	38.82	141.6	37.64	133.2	36.62	129.0	35.38	125.0	34.32	116.0	32.36
	11.0	9.8	150.4	38.28	141.6	37.10	133.2	36.12	129.0	34.88	125.0	33.84	116.0	31.92
	13.0	11.8	150.4	37.74	141.6	36.58	133.2	35.60	129.0	34.38	125.0	33.36	116.0	31.46
15.0	13.7	150.4	37.20	141.6	36.06	133.2	35.10	129.0	33.90	125.0	32.88	116.0	31.02	
80	-19.8	-20	81.8	33.06	81.8	35.86	81.8	38.76	81.8	38.16	81.8	37.26	81.8	36.30
	-18.8	-19	85.6	34.00	85.6	38.76	85.6	38.48	85.6	37.86	85.6	36.96	85.6	36.00
	-16.7	-17	94.4	38.76	94.4	38.24	94.4	37.92	94.4	37.26	94.4	36.34	94.4	35.34
	-13.7	-15	111.2	38.10	109.0	37.52	106.2	37.12	106.2	36.36	106.2	35.44	103.6	34.40
	-11.8	-13	120.2	37.68	116.8	37.08	112.2	36.62	112.2	35.82	111.4	34.88	103.6	33.82
	-9.8	-11	124.0	37.24	120.4	36.60	118.6	36.08	115.6	35.22	111.4	34.28	103.6	33.20
	-9.5	-10	124.8	37.16	121.2	36.52	119.2	36.00	115.6	35.14	111.4	34.20	103.6	33.10
	-8.5	-9.1	129.4	36.94	127.0	36.28	119.2	35.74	115.6	34.84	111.4	33.90	103.6	32.78
	-7.0	-7.6	134.6	36.62	127.0	35.92	119.2	35.34	115.6	34.40	111.4	33.46	103.6	32.32
	-5.0	-5.6	134.6	36.18	127.0	35.44	119.2	34.80	115.6	33.82	111.4	32.86	103.6	31.70
	-3.0	-3.7	134.6	35.74	127.0	34.96	119.2	34.26	115.6	33.22	111.4	32.26	103.6	31.08
	0.0	-0.7	134.6	35.08	127.0	34.24	119.2	33.46	115.6	32.34	111.4	31.36	103.6	30.14
	3.0	2.2	134.6	34.42	127.0	33.52	119.2	32.66	115.6	31.46	111.4	30.48	103.6	29.20
	5.0	4.1	134.6	33.98	127.0	33.04	119.2	32.14	115.6	30.86	111.4	29.88	103.6	28.58
	7.0	6	134.6	33.54	127.0	32.56	119.2	31.60	115.6	30.28	111.4	29.28	103.6	27.96
	9.0	7.9	134.6	31.48	127.0	30.56	119.2	29.66	115.6	28.44	111.4	27.50	103.6	26.26
	11.0	9.8	134.6	29.22	127.0	28.38	119.2	27.54	115.6	26.38	111.4	25.52	103.6	24.36
	13.0	11.8	134.6	27.28	127.0	26.48	119.2	25.70	115.6	24.64	111.4	23.82	103.6	22.74
15.0	13.7	134.6	25.68	127.0	24.94	119.2	24.20	115.6	23.18	111.4	22.42	103.6	21.42	

Note
 1. TC: Total Capacity(kW), PI: Power Input(kW, Comp. + Outdoor fan motor)
 2. Capacity tables show the average value of conditions which may occur.
 3. In the range beyond the operation limit of the outdoor unit, continuous operation and performance can not be guaranteed. When selecting the outdoor units, avoid the air temperature range that is not guaranteed continuous operation.

7. Capacity Tables

Combination (%)		Heating Capacity (52HP)												
		Outdoor air temp.		Indoor air temp. °C DB										
		°C DB	°C WB	16		18		20		21		22		24
		TC	PI	TC	PI	TC	PI	TC	PI	TC	PI	TC	PI	
70	-19.8	-20	81.8	35.02	81.8	35.96	81.8	35.34	81.8	34.36	81.8	33.44	81.8	32.42
	-18.8	-19	85.6	35.96	85.6	35.66	85.6	35.04	85.6	34.06	85.6	33.14	85.6	32.08
	-16.7	-17	94.4	35.40	94.4	35.04	94.4	34.38	94.4	33.38	94.4	32.48	88.6	31.40
	-13.7	-15	114.2	34.62	107.8	34.16	101.4	33.46	98.0	32.44	95.0	31.54	88.6	30.40
	-11.8	-13	114.2	34.12	107.8	33.58	101.4	32.88	98.0	31.82	95.0	30.94	88.6	29.78
	-9.8	-11	114.2	33.60	107.8	33.00	101.4	32.26	98.0	31.20	95.0	30.32	88.6	29.12
	-9.5	-10	114.2	33.52	107.8	32.90	101.4	32.16	98.0	31.10	95.0	30.22	88.6	29.02
	-8.5	-9.1	114.2	33.26	107.8	32.62	101.4	31.86	98.0	30.78	95.0	29.92	88.6	28.70
	-7.0	-7.6	114.2	32.86	107.8	32.16	101.4	31.40	98.0	30.30	95.0	29.44	88.6	28.20
	-5.0	-5.6	114.2	32.34	107.8	31.58	101.4	30.78	98.0	29.66	95.0	28.82	88.6	27.54
	-3.0	-3.7	114.2	31.82	107.8	30.98	101.4	30.16	98.0	29.04	95.0	28.20	88.6	26.88
	0.0	-0.7	114.2	31.04	107.8	30.10	101.4	29.24	98.0	28.08	95.0	27.26	88.6	25.88
	3.0	2.2	114.2	30.24	107.8	29.20	101.4	28.32	98.0	27.14	95.0	26.32	88.6	24.90
	5.0	4.1	114.2	29.72	107.8	28.62	101.4	27.70	98.0	26.50	95.0	25.70	88.6	24.24
	7.0	6	114.2	29.20	107.8	28.02	101.4	27.08	98.0	25.86	95.0	25.08	88.6	23.58
	9.0	7.9	114.2	26.36	107.8	25.30	101.4	24.46	98.0	23.36	95.0	22.64	88.6	21.30
	11.0	9.8	114.2	24.54	107.8	23.56	101.4	22.78	98.0	21.74	95.0	21.08	88.6	19.82
	13.0	11.8	114.2	22.96	107.8	22.04	101.4	21.30	98.0	20.34	95.0	19.72	88.6	18.54
15.0	13.7	114.2	21.66	107.8	20.78	101.4	20.08	98.0	19.18	95.0	18.60	88.6	17.48	
60	-19.8	-20	98.0	33.16	92.8	32.54	81.8	31.58	81.8	30.64	81.2	29.70	76.0	28.68
	-18.8	-19	98.0	32.88	92.8	32.24	85.6	31.26	84.0	30.32	81.2	29.40	76.0	28.36
	-16.7	-17	98.0	32.32	92.8	31.58	87.0	30.60	84.0	29.66	81.2	28.74	76.0	27.66
	-13.7	-15	98.0	31.50	92.8	30.66	87.0	29.66	84.0	28.72	81.2	27.80	76.0	26.66
	-11.8	-13	98.0	31.00	92.8	30.06	87.0	29.06	84.0	28.14	81.2	27.20	76.0	26.04
	-9.8	-11	98.0	30.46	92.8	29.46	87.0	28.42	84.0	27.50	81.2	26.58	76.0	25.38
	-9.5	-10	98.0	30.36	92.8	29.36	87.0	28.34	84.0	27.40	81.2	26.48	76.0	25.28
	-8.5	-9.1	98.0	30.10	92.8	29.04	87.0	28.02	84.0	27.10	81.2	26.18	76.0	24.94
	-7.0	-7.6	98.0	29.70	92.8	28.58	87.0	27.54	84.0	26.62	81.2	25.70	76.0	24.46
	-5.0	-5.6	98.0	29.16	92.8	27.96	87.0	26.92	84.0	26.00	81.2	25.08	76.0	23.80
	-3.0	-3.7	98.0	28.60	92.8	27.36	87.0	26.28	84.0	25.36	81.2	24.46	76.0	23.14
	0.0	-0.7	98.0	27.80	92.8	26.42	87.0	25.34	84.0	24.42	81.2	23.52	76.0	22.14
	3.0	2.2	98.0	26.98	92.8	25.50	87.0	24.40	84.0	23.48	81.2	22.58	76.0	21.14
	5.0	4.1	98.0	26.44	92.8	24.88	87.0	23.76	84.0	22.86	81.2	21.94	76.0	20.48
	7.0	6	98.0	25.90	92.8	24.26	87.0	23.12	84.0	22.22	81.2	21.32	76.0	19.82
	9.0	7.9	98.0	23.12	92.8	21.64	87.0	20.64	84.0	19.84	81.2	19.02	76.0	17.70
	11.0	9.8	98.0	21.58	92.8	20.22	87.0	19.26	84.0	18.52	81.2	17.76	76.0	16.52
	13.0	11.8	98.0	20.22	92.8	18.94	87.0	18.06	84.0	17.34	81.2	16.64	76.0	15.48
15.0	13.7	98.0	19.10	92.8	17.90	87.0	17.06	84.0	16.40	81.2	15.72	76.0	14.62	
50	-19.8	-20	81.8	29.70	77.2	28.66	72.4	27.70	70.2	26.70	67.8	25.80	63.2	24.82
	-18.8	-19	81.8	29.38	77.2	28.32	72.4	27.36	70.2	26.38	67.8	25.48	63.2	24.48
	-16.7	-17	81.8	28.68	77.2	27.62	72.4	26.66	70.2	25.70	67.8	24.82	63.2	23.82
	-13.7	-15	81.8	27.70	77.2	26.60	72.4	25.68	70.2	24.70	67.8	23.86	63.2	22.84
	-11.8	-13	81.8	27.08	77.2	25.94	72.4	25.06	70.2	24.08	67.8	23.28	63.2	22.24
	-9.8	-11	81.8	26.42	77.2	25.26	72.4	24.40	70.2	23.42	67.8	22.64	63.2	21.60
	-9.5	-10	81.8	26.32	77.2	25.16	72.4	24.30	70.2	23.32	67.8	22.54	63.2	21.50
	-8.5	-9.1	81.8	25.98	77.2	24.82	72.4	23.96	70.2	23.00	67.8	22.24	63.2	21.18
	-7.0	-7.6	81.8	25.50	77.2	24.32	72.4	23.46	70.2	22.50	67.8	21.76	63.2	20.70
	-5.0	-5.6	81.8	24.84	77.2	23.64	72.4	22.80	70.2	21.84	67.8	21.12	63.2	20.04
	-3.0	-3.7	81.8	24.18	77.2	22.96	72.4	22.14	70.2	21.18	67.8	20.50	63.2	19.40
	0.0	-0.7	81.8	23.20	77.2	21.94	72.4	21.16	70.2	20.20	67.8	19.56	63.2	18.44
	3.0	2.2	81.8	22.20	77.2	20.92	72.4	20.16	70.2	19.22	67.8	18.60	63.2	17.48
	5.0	4.1	81.8	21.56	77.2	20.24	72.4	19.50	70.2	18.56	67.8	17.98	63.2	16.82
	7.0	6	81.8	20.90	77.2	19.56	72.4	18.84	70.2	17.90	67.8	17.34	63.2	16.18
	9.0	7.9	81.8	18.86	77.2	17.66	72.4	17.02	70.2	16.16	67.8	15.66	63.2	14.62
	11.0	9.8	81.8	17.66	77.2	16.52	72.4	15.92	70.2	15.12	67.8	14.66	63.2	13.68
	13.0	11.8	81.8	16.58	77.2	15.52	72.4	14.94	70.2	14.20	67.8	13.76	63.2	12.84
15.0	13.7	81.8	15.68	77.2	14.68	72.4	14.14	70.2	13.44	67.8	13.02	63.2	12.14	

Note

1. TC: Total Capacity(kW), PI: Power Input(kW, Comp. + Outdoor fan motor)
2. Capacity tables show the average value of conditions which may occur.
3. In the range beyond the operation limit of the outdoor unit, continuous operation and performance can not be guaranteed. When selecting the outdoor units, avoid the air temperature range that is not guaranteed continuous operation.

7. Capacity Tables

7.2.3 Three Unit

◆ A(C)RUN540LLS5

Combination (%)	Outdoor air temp.		Heating Capacity (54HP)											
			Indoor air temp. °C DB											
	°C DB	°C WB	16		18		20		21		22		24	
		TC	PI	TC	PI	TC	PI	TC	PI	TC	PI	TC	PI	
130	-19.8	-20	87.5	36.76	87.5	38.18	87.0	39.42	87.0	41.31	87.0	43.11	87.0	45.96
	-18.8	-19	91.8	37.71	91.8	39.13	91.1	40.36	91.1	42.27	91.1	44.06	91.1	46.91
	-16.7	-17	100.7	39.70	100.7	41.12	100.1	42.35	100.1	44.25	100.1	46.05	100.1	48.90
	-13.7	-15	113.4	42.55	113.4	43.97	112.7	45.20	112.7	47.09	112.7	48.90	112.7	48.35
	-11.8	-13	119.8	44.34	119.8	45.77	119.0	47.01	119.0	48.90	119.0	48.63	119.0	48.00
	-9.8	-11	126.5	46.24	126.5	47.66	125.7	48.90	125.7	48.73	125.7	48.35	125.7	47.63
	-9.5	-10	129.6	46.53	129.6	47.94	128.8	48.90	128.8	48.71	126.7	48.30	126.7	47.59
	-8.5	-9.1	139.6	47.47	139.6	48.90	138.7	48.89	138.7	48.63	130.1	48.16	130.1	47.40
	-7.0	-7.6	154.7	48.90	154.7	49.03	153.8	48.87	153.8	48.50	153.8	47.94	141.0	47.13
	-5.0	-5.6	174.9	49.32	174.9	49.21	173.7	48.86	173.7	48.35	173.7	47.66	149.4	46.76
	-3.0	-3.7	195.0	49.76	195.0	49.38	193.7	48.85	190.0	48.18	183.3	47.38	157.9	46.40
	0.0	-0.7	195.4	50.41	195.4	49.63	194.8	48.84	190.0	47.94	183.3	46.95	170.5	45.86
	3.0	2.2	195.4	51.06	195.4	49.90	194.8	48.81	190.0	47.70	183.3	46.52	170.7	45.32
	5.0	4.1	195.4	51.49	195.4	50.08	194.8	48.80	190.0	47.53	183.3	46.24	170.7	44.95
	7.0	6	195.4	51.93	195.4	50.25	194.8	48.80	190.0	47.37	183.3	45.96	170.7	44.59
	9.0	7.9	195.4	52.42	195.4	50.73	194.8	49.26	190.0	47.83	183.3	46.41	170.7	45.01
	11.0	9.8	195.4	53.46	195.4	51.73	194.8	50.22	190.0	48.76	183.3	47.32	170.7	45.90
13.0	11.8	195.4	54.48	195.4	52.73	194.8	51.18	190.0	49.70	183.3	48.21	170.7	46.77	
15.0	13.7	195.4	55.49	195.4	53.71	194.8	52.15	190.0	50.63	183.3	49.13	170.7	47.66	
120	-19.8	-20	87.0	38.18	87.0	39.42	86.4	41.31	86.4	43.11	86.4	45.96	86.4	47.94
	-18.8	-19	91.1	39.13	91.1	40.36	90.5	42.27	90.5	44.06	90.5	46.91	90.5	48.90
	-16.7	-17	99.9	41.12	99.9	42.35	99.3	44.25	99.3	46.05	99.3	48.90	99.3	48.54
	-13.7	-15	112.6	43.97	112.6	45.20	112.0	47.09	112.0	48.90	112.0	48.45	112.0	48.04
	-11.8	-13	119.0	45.77	119.0	47.01	118.3	48.90	118.3	48.61	118.3	48.17	118.3	47.72
	-9.8	-11	125.7	47.66	125.7	48.90	124.8	48.67	124.8	48.31	124.8	47.88	124.8	47.39
	-9.5	-10	128.5	47.94	128.5	48.87	127.9	48.63	127.9	48.27	127.9	47.83	127.9	47.33
	-8.5	-9.1	138.6	48.90	138.6	48.80	137.7	48.51	137.7	48.12	133.7	47.67	133.7	47.17
	-7.0	-7.6	153.6	48.90	153.6	48.69	152.6	48.33	152.6	47.90	140.0	47.45	140.0	46.92
	-5.0	-5.6	173.6	48.91	173.6	48.53	172.6	48.11	172.6	47.60	172.6	47.16	148.4	46.58
	-3.0	-3.7	191.8	48.91	191.8	48.39	184.2	47.87	178.2	47.29	172.6	46.87	156.8	46.25
	0.0	-0.7	193.8	48.94	191.8	48.17	184.2	47.52	178.2	46.85	172.6	46.42	160.3	45.74
	3.0	2.2	193.8	48.94	191.8	47.94	184.2	47.17	178.2	46.41	172.6	45.97	160.3	45.24
	5.0	4.1	193.8	48.96	191.8	47.79	184.2	46.93	178.2	46.11	172.6	45.67	160.3	44.90
	7.0	6	193.8	48.97	191.8	47.64	184.2	46.70	178.2	45.81	172.6	45.38	160.3	44.57
	9.0	7.9	193.8	49.21	191.8	47.88	184.2	46.93	178.2	46.04	172.6	45.60	160.3	44.79
	11.0	9.8	193.8	49.94	191.8	48.58	184.2	47.62	178.2	46.71	172.6	46.28	160.3	45.45
13.0	11.8	193.8	50.65	191.8	49.27	184.2	48.31	178.2	47.38	172.6	46.93	160.3	46.10	
15.0	13.7	193.8	51.35	191.8	49.96	184.2	48.98	178.2	48.03	172.6	47.58	160.3	46.73	
110	-19.8	-20	86.4	39.42	86.4	41.31	86.0	43.11	86.0	45.96	86.0	47.94	86.0	48.90
	-18.8	-19	90.6	40.36	90.6	42.27	90.1	44.06	90.1	46.91	90.1	48.90	90.1	48.63
	-16.7	-17	99.5	42.35	99.5	44.25	98.8	46.05	98.8	48.90	98.8	48.41	98.8	48.06
	-13.7	-15	112.0	45.20	112.0	47.09	111.3	48.90	111.3	48.22	111.3	47.73	111.3	47.25
	-11.8	-13	118.4	47.01	118.4	48.90	117.6	48.45	117.6	47.80	117.6	47.29	117.6	46.74
	-9.8	-11	125.0	48.90	125.0	48.43	124.2	47.98	124.2	47.33	124.2	46.84	124.2	46.19
	-9.5	-10	127.9	48.83	127.9	48.36	127.1	47.92	127.1	47.27	127.1	46.76	127.1	46.11
	-8.5	-9.1	137.9	48.62	137.9	48.14	137.0	47.68	137.0	47.04	133.5	46.53	133.5	45.84
	-7.0	-7.6	152.9	48.29	152.9	47.80	151.8	47.33	151.8	46.70	139.9	46.19	139.9	45.43
	-5.0	-5.6	166.4	47.86	166.4	47.33	165.3	46.87	159.9	46.25	146.6	45.73	144.4	44.90
	-3.0	-3.7	176.1	47.43	176.1	46.88	165.3	46.40	159.9	45.80	154.5	45.28	144.4	44.36
	0.0	-0.7	186.3	46.78	176.1	46.19	165.3	45.70	159.9	45.12	154.5	44.59	144.4	43.55
	3.0	2.2	186.3	46.12	176.1	45.50	165.3	45.01	159.9	44.45	154.5	43.90	144.4	42.74
	5.0	4.1	186.3	45.69	176.1	45.04	165.3	44.54	159.9	44.00	154.5	43.45	144.4	42.19
	7.0	6	186.3	45.26	176.1	44.57	165.3	44.08	159.9	43.54	154.5	42.98	144.4	41.66
	9.0	7.9	186.3	45.22	176.1	44.55	165.3	44.04	159.9	43.52	154.5	42.95	144.4	41.62
	11.0	9.8	186.3	45.63	176.1	44.94	165.3	44.45	159.9	43.90	154.5	43.34	144.4	42.01
13.0	11.8	186.3	46.01	176.1	45.32	165.3	44.81	159.9	44.27	154.5	43.70	144.4	42.35	
15.0	13.7	186.3	46.38	176.1	45.69	165.3	45.17	159.9	44.62	154.5	44.04	144.4	42.69	

Note

1. TC: Total Capacity(kW), PI: Power Input(kW, Comp. + Outdoor fan motor)
2. Capacity tables show the average value of conditions which may occur.
3. In the range beyond the operation limit of the outdoor unit, continuous operation and performance can not be guaranteed. When selecting the outdoor units, avoid the air temperature range that is not guaranteed continuous operation.

7. Capacity Tables

Combination (%)		Heating Capacity (54HP)												
		Outdoor air temp.		Indoor air temp. °C DB										
		°C DB	°C WB	16		18		20		21		22		24
		TC	PI	TC	PI	TC	PI	TC	PI	TC	PI	TC	PI	
100	-19.8	-20	86.1	41.04	86.1	42.61	85.5	43.94	85.5	46.46	85.5	48.22	85.5	48.90
	-18.8	-19	90.2	41.82	89.7	43.39	89.7	44.89	89.7	47.25	89.7	48.90	89.7	48.45
	-16.7	-17	98.5	43.47	98.5	45.05	98.5	46.88	97.8	48.90	97.8	48.02	97.8	47.49
	-13.7	-15	111.5	45.83	111.5	47.40	110.9	48.90	110.9	47.76	110.9	46.78	110.9	46.12
	-11.8	-13	117.7	47.33	117.1	48.90	117.1	48.24	117.1	47.03	117.1	45.98	117.1	45.26
	-9.8	-11	124.3	48.90	124.3	48.21	123.6	47.53	123.6	46.28	123.6	45.15	123.6	44.35
	-9.5	-10	127.2	48.81	127.2	48.11	126.7	47.43	126.7	46.15	126.7	45.04	126.7	44.22
	-8.5	-9.1	137.0	48.50	137.0	47.76	136.5	47.08	146.4	45.78	141.4	44.60	131.9	43.76
	-7.0	-7.6	154.5	48.04	153.9	47.25	151.2	46.56	146.4	45.22	141.4	43.99	131.9	43.08
	-5.0	-5.6	161.2	47.45	159.7	46.56	151.2	45.87	146.4	44.45	141.4	43.16	131.9	42.16
	-3.0	-3.7	166.0	46.84	161.0	45.87	151.2	45.18	146.4	43.69	141.4	42.33	131.9	41.25
	0.0	-0.7	170.5	45.93	161.0	44.85	151.2	44.14	146.4	42.56	141.4	41.08	131.9	39.90
	3.0	2.2	170.5	45.01	161.0	43.81	151.2	43.08	146.4	41.42	141.4	39.83	131.9	38.53
	5.0	4.1	170.5	44.42	161.0	43.12	151.2	42.39	146.4	40.66	141.4	39.00	131.9	37.62
	7.0	6	170.5	43.81	161.0	42.43	151.2	41.70	146.4	39.90	141.4	38.17	131.9	36.71
	9.0	7.9	170.5	43.21	161.0	41.84	151.2	41.12	146.4	39.35	141.4	37.64	131.9	36.21
11.0	9.8	170.5	43.00	161.0	41.65	151.2	40.93	146.4	39.16	141.4	37.47	131.9	36.03	
13.0	11.8	170.5	42.76	161.0	41.42	151.2	40.69	146.4	38.94	141.4	37.25	131.9	35.83	
15.0	13.7	170.5	42.46	161.0	41.14	151.2	40.42	146.4	38.67	141.4	36.99	131.9	35.59	
90	-19.8	-20	85.7	38.66	85.7	41.51	85.1	43.49	85.1	44.44	85.1	43.81	85.1	42.71
	-18.8	-19	90.2	39.61	89.7	42.45	89.3	44.44	89.3	44.14	89.3	43.50	89.3	42.35
	-16.7	-17	98.5	41.60	98.5	44.44	98.1	43.90	98.1	43.53	98.1	42.84	98.1	41.62
	-13.7	-15	111.5	44.44	111.5	43.73	110.3	43.12	110.3	42.63	110.3	41.90	110.3	40.58
	-11.8	-13	117.7	44.04	117.1	43.28	116.6	42.63	116.6	42.06	116.6	41.30	116.6	39.92
	-9.8	-11	124.3	43.61	124.3	42.80	123.1	42.11	123.1	41.47	123.1	40.68	113.0	39.22
	-9.5	-10	127.2	43.55	127.2	42.73	126.1	42.04	126.1	41.38	126.1	40.58	115.7	39.12
	-8.5	-9.1	137.0	43.34	136.2	42.49	135.9	41.78	134.0	41.09	129.7	40.27	120.5	38.77
	-7.0	-7.6	154.5	43.02	147.0	42.15	138.3	41.39	134.0	40.64	129.7	39.79	120.5	38.25
	-5.0	-5.6	156.2	42.59	147.0	41.66	138.3	40.87	134.0	40.05	129.7	39.16	120.5	37.55
	-3.0	-3.7	156.2	42.16	147.0	41.19	138.3	40.36	134.0	39.45	129.7	38.54	120.5	36.85
	0.0	-0.7	156.2	41.53	147.0	40.47	138.3	39.58	134.0	38.56	129.7	37.59	120.5	35.81
	3.0	2.2	156.2	40.88	147.0	39.77	138.3	38.80	134.0	37.67	129.7	36.65	120.5	34.77
	5.0	4.1	156.2	40.46	147.0	39.28	138.3	38.28	134.0	37.07	129.7	36.02	120.5	34.08
	7.0	6	156.2	40.04	147.0	38.81	138.3	37.77	134.0	36.47	129.7	35.39	120.5	33.37
	9.0	7.9	156.2	39.49	147.0	38.28	138.3	37.25	134.0	35.98	129.7	34.91	120.5	32.91
11.0	9.8	156.2	38.94	147.0	37.74	138.3	36.74	134.0	35.47	129.7	34.42	120.5	32.46	
13.0	11.8	156.2	38.39	147.0	37.21	138.3	36.21	134.0	34.97	129.7	33.94	120.5	32.00	
15.0	13.7	156.2	37.84	147.0	36.67	138.3	35.70	134.0	34.47	129.7	33.45	120.5	31.54	
80	-19.8	-20	84.8	33.62	84.8	36.47	84.8	39.41	84.8	38.81	84.8	37.90	84.8	36.92
	-18.8	-19	88.9	34.58	88.9	39.41	88.9	39.14	88.9	38.50	88.9	37.59	88.9	36.61
	-16.7	-17	98.1	39.41	98.1	38.90	98.1	38.57	98.1	37.89	98.1	36.96	98.1	35.94
	-13.7	-15	115.5	38.74	113.2	38.16	110.3	37.75	110.3	36.98	110.3	36.05	107.6	34.99
	-11.8	-13	124.8	38.32	121.3	37.71	116.6	37.24	116.6	36.43	115.7	35.47	107.6	34.39
	-9.8	-11	128.8	37.87	125.0	37.22	123.1	36.70	120.1	35.82	115.7	34.87	107.6	33.76
	-9.5	-10	129.6	37.80	125.9	37.14	123.8	36.61	120.1	35.74	115.7	34.78	107.6	33.67
	-8.5	-9.1	134.4	37.57	131.9	36.90	123.8	36.34	120.1	35.43	115.7	34.47	107.6	33.34
	-7.0	-7.6	139.8	37.24	131.9	36.53	123.8	35.94	120.1	34.98	115.7	34.02	107.6	32.87
	-5.0	-5.6	139.8	36.79	131.9	36.05	123.8	35.39	120.1	34.39	115.7	33.42	107.6	32.23
	-3.0	-3.7	139.8	36.34	131.9	35.56	123.8	34.84	120.1	33.78	115.7	32.81	107.6	31.61
	0.0	-0.7	139.8	35.67	131.9	34.82	123.8	34.04	120.1	32.89	115.7	31.90	107.6	30.65
	3.0	2.2	139.8	35.01	131.9	34.09	123.8	33.22	120.1	31.99	115.7	30.99	107.6	29.70
	5.0	4.1	139.8	34.56	131.9	33.60	123.8	32.68	120.1	31.39	115.7	30.39	107.6	29.07
	7.0	6	139.8	34.11	131.9	33.12	123.8	32.13	120.1	30.80	115.7	29.78	107.6	28.44
	9.0	7.9	139.8	32.02	131.9	31.08	123.8	30.17	120.1	28.92	115.7	27.97	107.6	26.71
11.0	9.8	139.8	29.72	131.9	28.86	123.8	28.01	120.1	26.84	115.7	25.95	107.6	24.78	
13.0	11.8	139.8	27.74	131.9	26.94	123.8	26.14	120.1	25.06	115.7	24.23	107.6	23.13	
15.0	13.7	139.8	26.12	131.9	25.36	123.8	24.61	120.1	23.58	115.7	22.81	107.6	21.78	

Note

1. TC: Total Capacity(kW), PI: Power Input(kW, Comp. + Outdoor fan motor)
2. Capacity tables show the average value of conditions which may occur.
3. In the range beyond the operation limit of the outdoor unit, continuous operation and performance can not be guaranteed. When selecting the outdoor units, avoid the air temperature range that is not guaranteed continuous operation.

7. Capacity Tables

Combination (%)		Heating Capacity (54HP)												
		Outdoor air temp.		Indoor air temp. °C DB										
		°C DB	°C WB	16		18		20		21		22		24
		TC	PI	TC	PI	TC	PI	TC	PI	TC	PI	TC	PI	
70	-19.8	-20	84.8	35.62	84.8	36.57	84.8	35.94	84.8	34.95	84.8	34.01	84.8	32.97
	-18.8	-19	88.9	36.57	88.9	36.27	88.9	35.63	88.9	34.63	88.9	33.69	88.9	32.63
	-16.7	-17	98.1	36.00	98.1	35.64	98.1	34.96	98.1	33.95	98.1	33.03	92.1	31.93
	-13.7	-15	118.6	35.21	112.0	34.73	105.3	34.03	101.7	32.99	98.7	32.07	92.1	30.92
	-11.8	-13	118.6	34.70	112.0	34.16	105.3	33.44	101.7	32.37	98.7	31.47	92.1	30.29
	-9.8	-11	118.6	34.17	112.0	33.55	105.3	32.81	101.7	31.72	98.7	30.84	92.1	29.61
	-9.5	-10	118.6	34.09	112.0	33.46	105.3	32.71	101.7	31.62	98.7	30.74	92.1	29.51
	-8.5	-9.1	118.6	33.82	112.0	33.17	105.3	32.40	101.7	31.30	98.7	30.43	92.1	29.19
	-7.0	-7.6	118.6	33.43	112.0	32.71	105.3	31.93	101.7	30.82	98.7	29.95	92.1	28.68
	-5.0	-5.6	118.6	32.89	112.0	32.12	105.3	31.30	101.7	30.17	98.7	29.31	92.1	28.01
	-3.0	-3.7	118.6	32.36	112.0	31.51	105.3	30.68	101.7	29.53	98.7	28.68	92.1	27.34
	0.0	-0.7	118.6	31.57	112.0	30.61	105.3	29.74	101.7	28.56	98.7	27.73	92.1	26.33
	3.0	2.2	118.6	30.76	112.0	29.70	105.3	28.81	101.7	27.60	98.7	26.77	92.1	25.33
	5.0	4.1	118.6	30.23	112.0	29.10	105.3	28.18	101.7	26.95	98.7	26.15	92.1	24.65
	7.0	6	118.6	29.70	112.0	28.50	105.3	27.54	101.7	26.30	98.7	25.51	92.1	23.98
9.0	7.9	118.6	26.81	112.0	25.74	105.3	24.88	101.7	23.75	98.7	23.03	92.1	21.66	
11.0	9.8	118.6	24.97	112.0	23.96	105.3	23.16	101.7	22.12	98.7	21.44	92.1	20.16	
13.0	11.8	118.6	23.36	112.0	22.42	105.3	21.67	101.7	20.69	98.7	20.06	92.1	18.86	
15.0	13.7	118.6	22.03	112.0	21.13	105.3	20.43	101.7	19.51	98.7	18.92	92.1	17.78	
60	-19.8	-20	101.7	33.72	96.3	33.10	84.8	32.11	84.8	31.16	84.3	30.21	78.9	29.17
	-18.8	-19	101.7	33.44	96.3	32.79	88.9	31.79	87.3	30.83	84.3	29.90	78.9	28.84
	-16.7	-17	101.7	32.87	96.3	32.11	90.4	31.13	87.3	30.17	84.3	29.23	78.9	28.13
	-13.7	-15	101.7	32.04	96.3	31.18	90.4	30.17	87.3	29.21	84.3	28.27	78.9	27.12
	-11.8	-13	101.7	31.52	96.3	30.58	90.4	29.55	87.3	28.62	84.3	27.66	78.9	26.48
	-9.8	-11	101.7	30.97	96.3	29.96	90.4	28.91	87.3	27.97	84.3	27.03	78.9	25.81
	-9.5	-10	101.7	30.88	96.3	29.86	90.4	28.82	87.3	27.88	84.3	26.93	78.9	25.71
	-8.5	-9.1	101.7	30.61	96.3	29.54	90.4	28.49	87.3	27.56	84.3	26.62	78.9	25.37
	-7.0	-7.6	101.7	30.20	96.3	29.07	90.4	28.02	87.3	27.07	84.3	26.14	78.9	24.87
	-5.0	-5.6	101.7	29.65	96.3	28.44	90.4	27.38	87.3	26.44	84.3	25.51	78.9	24.20
	-3.0	-3.7	101.7	29.09	96.3	27.82	90.4	26.72	87.3	25.79	84.3	24.87	78.9	23.53
	0.0	-0.7	101.7	28.27	96.3	26.88	90.4	25.77	87.3	24.84	84.3	23.92	78.9	22.51
	3.0	2.2	101.7	27.44	96.3	25.93	90.4	24.81	87.3	23.88	84.3	22.96	78.9	21.50
	5.0	4.1	101.7	26.89	96.3	25.30	90.4	24.16	87.3	23.25	84.3	22.32	78.9	20.84
	7.0	6	101.7	26.34	96.3	24.67	90.4	23.52	87.3	22.60	84.3	21.68	78.9	20.16
9.0	7.9	101.7	23.51	96.3	22.01	90.4	20.99	87.3	20.17	84.3	19.35	78.9	18.00	
11.0	9.8	101.7	21.95	96.3	20.57	90.4	19.60	87.3	18.84	84.3	18.06	78.9	16.81	
13.0	11.8	101.7	20.57	96.3	19.26	90.4	18.37	87.3	17.64	84.3	16.92	78.9	15.74	
15.0	13.7	101.7	19.43	96.3	18.20	90.4	17.35	87.3	16.68	84.3	15.99	78.9	14.88	
50	-19.8	-20	85.0	30.21	80.1	29.15	75.2	28.16	72.9	27.16	70.5	26.23	65.6	25.24
	-18.8	-19	85.0	29.88	80.1	28.80	75.2	27.83	72.9	26.83	70.5	25.91	65.6	24.90
	-16.7	-17	85.0	29.17	80.1	28.08	75.2	27.11	72.9	26.14	70.5	25.24	65.6	24.22
	-13.7	-15	85.0	28.17	80.1	27.05	75.2	26.11	72.9	25.12	70.5	24.27	65.6	23.23
	-11.8	-13	85.0	27.53	80.1	26.38	75.2	25.48	72.9	24.49	70.5	23.67	65.6	22.62
	-9.8	-11	85.0	26.87	80.1	25.69	75.2	24.81	72.9	23.82	70.5	23.03	65.6	21.96
	-9.5	-10	85.0	26.77	80.1	25.59	75.2	24.70	72.9	23.72	70.5	22.93	65.6	21.86
	-8.5	-9.1	85.0	26.42	80.1	25.24	75.2	24.37	72.9	23.39	70.5	22.62	65.6	21.54
	-7.0	-7.6	85.0	25.93	80.1	24.73	75.2	23.86	72.9	22.89	70.5	22.13	65.6	21.04
	-5.0	-5.6	85.0	25.27	80.1	24.04	75.2	23.19	72.9	22.21	70.5	21.48	65.6	20.38
	-3.0	-3.7	85.0	24.59	80.1	23.35	75.2	22.52	72.9	21.54	70.5	20.85	65.6	19.73
	0.0	-0.7	85.0	23.59	80.1	22.31	75.2	21.52	72.9	20.54	70.5	19.89	65.6	18.75
	3.0	2.2	85.0	22.58	80.1	21.27	75.2	20.51	72.9	19.55	70.5	18.92	65.6	17.77
	5.0	4.1	85.0	21.92	80.1	20.58	75.2	19.84	72.9	18.88	70.5	18.28	65.6	17.11
	7.0	6	85.0	21.26	80.1	19.89	75.2	19.16	72.9	18.20	70.5	17.64	65.6	16.46
9.0	7.9	85.0	19.19	80.1	17.96	75.2	17.31	72.9	16.44	70.5	15.93	65.6	14.86	
11.0	9.8	85.0	17.96	80.1	16.81	75.2	16.19	72.9	15.38	70.5	14.91	65.6	13.91	
13.0	11.8	85.0	16.86	80.1	15.78	75.2	15.20	72.9	14.44	70.5	13.99	65.6	13.06	
15.0	13.7	85.0	15.95	80.1	14.93	75.2	14.38	72.9	13.67	70.5	13.24	65.6	12.36	

Note

1. TC: Total Capacity(kW), PI: Power Input(kW, Comp. + Outdoor fan motor)
2. Capacity tables show the average value of conditions which may occur.
3. In the range beyond the operation limit of the outdoor unit, continuous operation and performance can not be guaranteed. When selecting the outdoor units, avoid the air temperature range that is not guaranteed continuous operation.

7. Capacity Tables

◆ A(C)RUN560LLS5

Combination (%)	Outdoor air temp.		Heating Capacity (56HP)											
			Indoor air temp. °C DB											
	°C DB	°C WB	16		18		20		21		22		24	
		TC	PI	TC	PI	TC	PI	TC	PI	TC	PI	TC	PI	
130	-19.8	-20	90.8	36.76	90.8	38.18	90.3	39.42	90.3	41.31	90.3	43.11	90.3	45.96
	-18.8	-19	95.2	37.71	95.2	39.13	94.5	40.36	94.5	42.27	94.5	44.06	94.5	46.91
	-16.7	-17	104.5	39.70	104.5	41.12	103.8	42.35	103.8	44.25	103.8	46.05	103.8	48.90
	-13.7	-15	117.6	42.55	117.6	43.97	116.9	45.20	116.9	47.09	116.9	48.90	116.9	48.35
	-11.8	-13	124.2	44.34	124.2	45.77	123.4	47.01	123.4	48.90	123.4	48.63	123.4	48.00
	-9.8	-11	131.2	46.24	131.2	47.66	130.3	48.90	130.3	48.73	130.3	48.35	130.3	47.63
	-9.5	-10	134.4	46.53	134.4	47.94	133.5	48.90	133.5	48.71	131.4	48.30	131.4	47.59
	-8.5	-9.1	144.8	47.47	144.8	48.90	143.9	48.89	143.9	48.63	134.9	48.16	134.9	47.40
	-7.0	-7.6	160.5	48.90	160.5	49.03	159.4	48.87	159.4	48.50	159.4	47.94	146.1	47.13
	-5.0	-5.6	181.4	49.32	181.4	49.21	180.1	48.86	180.1	48.35	180.1	47.66	154.8	46.76
	-3.0	-3.7	202.2	49.76	202.2	49.38	200.9	48.85	197.0	48.18	190.1	47.38	163.6	46.40
	0.0	-0.7	202.6	50.41	202.6	49.63	202.0	48.84	197.0	47.94	190.1	46.95	176.6	45.86
	3.0	2.2	202.6	51.06	202.6	49.90	202.0	48.81	197.0	47.70	190.1	46.52	177.0	45.32
	5.0	4.1	202.6	51.49	202.6	50.08	202.0	48.80	197.0	47.53	190.1	46.24	177.0	44.95
	7.0	6	202.6	51.93	202.6	50.25	202.0	48.80	197.0	47.37	190.1	45.96	177.0	44.59
	9.0	7.9	202.6	52.42	202.6	50.73	202.0	49.26	197.0	47.83	190.1	46.41	177.0	45.01
	11.0	9.8	202.6	53.46	202.6	51.73	202.0	50.22	197.0	48.76	190.1	47.32	177.0	45.90
13.0	11.8	202.6	54.48	202.6	52.73	202.0	51.18	197.0	49.70	190.1	48.21	177.0	46.77	
15.0	13.7	202.6	55.49	202.6	53.71	202.0	52.15	197.0	50.63	190.1	49.13	177.0	47.66	
120	-19.8	-20	90.2	38.18	90.2	39.42	89.6	41.31	89.6	43.11	89.6	45.96	89.6	47.94
	-18.8	-19	94.5	39.13	94.5	40.36	93.9	42.27	93.9	44.06	93.9	46.91	93.9	48.90
	-16.7	-17	103.6	41.12	103.6	42.35	103.0	44.25	103.0	46.05	103.0	48.90	103.0	48.54
	-13.7	-15	116.7	43.97	116.7	45.20	116.1	47.09	116.1	48.90	116.1	48.45	116.1	48.04
	-11.8	-13	123.4	45.77	123.4	47.01	122.6	48.90	122.6	48.61	122.6	48.17	122.6	47.72
	-9.8	-11	130.3	47.66	130.3	48.90	129.4	48.67	129.4	48.31	129.4	47.88	129.4	47.39
	-9.5	-10	133.3	47.94	133.3	48.87	132.6	48.63	132.6	48.27	132.6	47.83	132.6	47.33
	-8.5	-9.1	143.7	48.90	143.7	48.80	142.8	48.51	142.8	48.12	138.5	47.67	138.5	47.17
	-7.0	-7.6	159.3	48.90	159.3	48.69	158.3	48.33	158.3	47.90	145.1	47.45	145.1	46.92
	-5.0	-5.6	180.0	48.91	180.0	48.53	179.0	48.11	179.0	47.60	179.0	47.16	153.7	46.58
	-3.0	-3.7	198.9	48.91	198.9	48.39	191.0	47.87	184.8	47.29	179.0	46.87	162.4	46.25
	0.0	-0.7	201.0	48.94	198.9	48.17	191.0	47.52	184.8	46.85	179.0	46.42	166.2	45.74
	3.0	2.2	201.0	48.94	198.9	47.94	191.0	47.17	184.8	46.41	179.0	45.97	166.2	45.24
	5.0	4.1	201.0	48.96	198.9	47.79	191.0	46.93	184.8	46.11	179.0	45.67	166.2	44.90
	7.0	6	201.0	48.97	198.9	47.64	191.0	46.70	184.8	45.81	179.0	45.38	166.2	44.57
	9.0	7.9	201.0	49.21	198.9	47.88	191.0	46.93	184.8	46.04	179.0	45.60	166.2	44.79
	11.0	9.8	201.0	49.94	198.9	48.58	191.0	47.62	184.8	46.71	179.0	46.28	166.2	45.45
13.0	11.8	201.0	50.65	198.9	49.27	191.0	48.31	184.8	47.38	179.0	46.93	166.2	46.10	
15.0	13.7	201.0	51.35	198.9	49.96	191.0	48.98	184.8	48.03	179.0	47.58	166.2	46.73	
110	-19.8	-20	89.7	39.42	89.7	41.31	89.2	43.11	89.2	45.96	89.2	47.94	89.2	48.90
	-18.8	-19	94.0	40.36	94.0	42.27	93.5	44.06	93.5	46.91	93.5	48.90	93.5	48.63
	-16.7	-17	103.2	42.35	103.2	44.25	102.5	46.05	102.5	48.90	102.5	48.41	102.5	48.06
	-13.7	-15	116.1	45.20	116.1	47.09	115.4	48.90	115.4	48.22	115.4	47.73	115.4	47.25
	-11.8	-13	122.7	47.01	122.7	48.90	121.9	48.45	121.9	47.80	121.9	47.29	121.9	46.74
	-9.8	-11	129.6	48.90	129.6	48.43	128.8	47.98	128.8	47.33	128.8	46.84	128.8	46.19
	-9.5	-10	132.7	48.83	132.7	48.36	131.8	47.92	131.8	47.27	131.8	46.76	131.8	46.11
	-8.5	-9.1	143.0	48.62	143.0	48.14	142.1	47.68	142.1	47.04	138.4	46.53	138.4	45.84
	-7.0	-7.6	158.5	48.29	158.5	47.80	157.4	47.33	157.4	46.70	145.2	46.19	145.2	45.43
	-5.0	-5.6	172.6	47.86	172.6	47.33	171.4	46.87	165.8	46.25	152.1	45.73	149.7	44.90
	-3.0	-3.7	182.6	47.43	182.6	46.88	171.4	46.40	165.8	45.80	160.2	45.28	149.7	44.36
	0.0	-0.7	193.2	46.78	182.6	46.19	171.4	45.70	165.8	45.12	160.2	44.59	149.7	43.55
	3.0	2.2	193.2	46.12	182.6	45.50	171.4	45.01	165.8	44.45	160.2	43.90	149.7	42.74
	5.0	4.1	193.2	45.69	182.6	45.04	171.4	44.54	165.8	44.00	160.2	43.45	149.7	42.19
	7.0	6	193.2	45.26	182.6	44.57	171.4	44.08	165.8	43.54	160.2	42.98	149.7	41.66
	9.0	7.9	193.2	45.22	182.6	44.55	171.4	44.04	165.8	43.52	160.2	42.95	149.7	41.62
	11.0	9.8	193.2	45.63	182.6	44.94	171.4	44.45	165.8	43.90	160.2	43.34	149.7	42.01
13.0	11.8	193.2	46.01	182.6	45.32	171.4	44.81	165.8	44.27	160.2	43.70	149.7	42.35	
15.0	13.7	193.2	46.38	182.6	45.69	171.4	45.17	165.8	44.62	160.2	44.04	149.7	42.69	

Note

1. TC: Total Capacity(kW), PI : Power Input(kW, Comp. + Outdoor fan motor)
2. Capacity tables show the average value of conditions which may occur.
3. In the range beyond the operation limit of the outdoor unit, continuous operation and performance can not be guaranteed. When selecting the outdoor units, avoid the air temperature range that is not guaranteed continuous operation.

7. Capacity Tables

Combination (%)		Heating Capacity (56HP)												
		Outdoor air temp.		Indoor air temp. °C DB										
		°C DB	°C WB	16		18		20		21		22		24
		TC	PI	TC	PI	TC	PI	TC	PI	TC	PI	TC	PI	
100	-19.8	-20	89.4	41.04	89.4	42.61	88.8	43.94	88.8	46.46	88.8	48.22	88.8	48.90
	-18.8	-19	93.6	41.82	93.0	43.39	93.0	44.89	93.0	47.25	93.0	48.90	93.0	48.45
	-16.7	-17	102.1	43.47	102.1	45.05	102.1	46.88	101.4	48.90	101.4	48.02	101.4	47.49
	-13.7	-15	115.6	45.83	115.6	47.40	114.9	48.90	114.9	47.76	114.9	46.78	114.9	46.12
	-11.8	-13	122.0	47.33	121.4	48.90	121.4	48.24	121.4	47.03	121.4	45.98	121.4	45.26
	-9.8	-11	128.9	48.90	128.9	48.21	128.2	47.53	128.2	46.28	128.2	45.15	128.2	44.35
	-9.5	-10	131.9	48.81	131.9	48.11	131.3	47.43	131.3	46.15	131.3	45.04	131.3	44.22
	-8.5	-9.1	142.1	48.50	142.1	47.76	141.5	47.08	151.8	45.78	146.7	44.60	136.7	43.76
	-7.0	-7.6	160.2	48.04	159.6	47.25	156.8	46.56	151.8	45.22	146.7	43.99	136.7	43.08
	-5.0	-5.6	167.2	47.45	165.6	46.56	156.8	45.87	151.8	44.45	146.7	43.16	136.7	42.16
	-3.0	-3.7	172.1	46.84	166.9	45.87	156.8	45.18	151.8	43.69	146.7	42.33	136.7	41.25
	0.0	-0.7	176.9	45.93	166.9	44.85	156.8	44.14	151.8	42.56	146.7	41.08	136.7	39.90
	3.0	2.2	176.9	45.01	166.9	43.81	156.8	43.08	151.8	41.42	146.7	39.83	136.7	38.53
	5.0	4.1	176.9	44.42	166.9	43.12	156.8	42.39	151.8	40.66	146.7	39.00	136.7	37.62
	7.0	6	176.9	43.81	166.9	42.43	156.8	41.70	151.8	39.90	146.7	38.17	136.7	36.71
9.0	7.9	176.9	43.21	166.9	41.84	156.8	41.12	151.8	39.35	146.7	37.64	136.7	36.21	
11.0	9.8	176.9	43.00	166.9	41.65	156.8	40.93	151.8	39.16	146.7	37.47	136.7	36.03	
13.0	11.8	176.9	42.76	166.9	41.42	156.8	40.69	151.8	38.94	146.7	37.25	136.7	35.83	
15.0	13.7	176.9	42.46	166.9	41.14	156.8	40.42	151.8	38.67	146.7	36.99	136.7	35.59	
90	-19.8	-20	88.9	38.66	88.9	41.51	88.4	43.49	88.4	44.44	88.4	43.81	88.4	42.71
	-18.8	-19	93.6	39.61	93.0	42.45	92.6	44.44	92.6	44.14	92.6	43.50	92.6	42.35
	-16.7	-17	102.1	41.60	102.1	44.44	101.7	43.90	101.7	43.53	101.7	42.84	101.7	41.62
	-13.7	-15	115.6	44.44	115.6	43.73	114.4	43.12	114.4	42.63	114.4	41.90	114.4	40.58
	-11.8	-13	122.0	44.04	121.4	43.28	120.9	42.63	120.9	42.06	120.9	41.30	120.9	39.92
	-9.8	-11	128.9	43.61	128.9	42.80	127.7	42.11	127.7	41.47	127.7	40.68	117.2	39.22
	-9.5	-10	131.9	43.55	131.9	42.73	130.8	42.04	130.8	41.38	130.8	40.58	120.0	39.12
	-8.5	-9.1	142.1	43.34	141.2	42.49	140.9	41.78	139.0	41.09	134.5	40.27	125.0	38.77
	-7.0	-7.6	160.2	43.02	152.5	42.15	143.4	41.39	139.0	40.64	134.5	39.79	125.0	38.25
	-5.0	-5.6	162.0	42.59	152.5	41.66	143.4	40.87	139.0	40.05	134.5	39.16	125.0	37.55
	-3.0	-3.7	162.0	42.16	152.5	41.19	143.4	40.36	139.0	39.45	134.5	38.54	125.0	36.85
	0.0	-0.7	162.0	41.53	152.5	40.47	143.4	39.58	139.0	38.56	134.5	37.59	125.0	35.81
	3.0	2.2	162.0	40.88	152.5	39.77	143.4	38.80	139.0	37.67	134.5	36.65	125.0	34.77
	5.0	4.1	162.0	40.46	152.5	39.28	143.4	38.28	139.0	37.07	134.5	36.02	125.0	34.08
	7.0	6	162.0	40.04	152.5	38.81	143.4	37.77	139.0	36.47	134.5	35.39	125.0	33.37
9.0	7.9	162.0	39.49	152.5	38.28	143.4	37.25	139.0	35.98	134.5	34.91	125.0	32.91	
11.0	9.8	162.0	38.94	152.5	37.74	143.4	36.74	139.0	35.47	134.5	34.42	125.0	32.46	
13.0	11.8	162.0	38.39	152.5	37.21	143.4	36.21	139.0	34.97	134.5	33.94	125.0	32.00	
15.0	13.7	162.0	37.84	152.5	36.67	143.4	35.70	139.0	34.47	134.5	33.45	125.0	31.54	
80	-19.8	-20	88.0	33.62	88.0	36.47	88.0	39.41	88.0	38.81	88.0	37.90	88.0	36.92
	-18.8	-19	92.2	34.58	92.2	39.41	92.2	39.14	92.2	38.50	92.2	37.59	92.2	36.61
	-16.7	-17	101.7	39.41	101.7	38.90	101.7	38.57	101.7	37.89	101.7	36.96	101.7	35.94
	-13.7	-15	119.8	38.74	117.3	38.16	114.4	37.75	114.4	36.98	114.4	36.05	111.6	34.99
	-11.8	-13	129.4	38.32	125.7	37.71	120.9	37.24	120.9	36.43	120.0	35.47	111.6	34.39
	-9.8	-11	133.6	37.87	129.6	37.22	127.7	36.70	124.5	35.82	120.0	34.87	111.6	33.76
	-9.5	-10	134.4	37.80	130.5	37.14	128.4	36.61	124.5	35.74	120.0	34.78	111.6	33.67
	-8.5	-9.1	139.4	37.57	136.7	36.90	128.4	36.34	124.5	35.43	120.0	34.47	111.6	33.34
	-7.0	-7.6	145.0	37.24	136.7	36.53	128.4	35.94	124.5	34.98	120.0	34.02	111.6	32.87
	-5.0	-5.6	145.0	36.79	136.7	36.05	128.4	35.39	124.5	34.39	120.0	33.42	111.6	32.23
	-3.0	-3.7	145.0	36.34	136.7	35.56	128.4	34.84	124.5	33.78	120.0	32.81	111.6	31.61
	0.0	-0.7	145.0	35.67	136.7	34.82	128.4	34.04	124.5	32.89	120.0	31.90	111.6	30.65
	3.0	2.2	145.0	35.01	136.7	34.09	128.4	33.22	124.5	31.99	120.0	30.99	111.6	29.70
	5.0	4.1	145.0	34.56	136.7	33.60	128.4	32.68	124.5	31.39	120.0	30.39	111.6	29.07
	7.0	6	145.0	34.11	136.7	33.12	128.4	32.13	124.5	30.80	120.0	29.78	111.6	28.44
9.0	7.9	145.0	32.02	136.7	31.08	128.4	30.17	124.5	28.92	120.0	27.97	111.6	26.71	
11.0	9.8	145.0	29.72	136.7	28.86	128.4	28.01	124.5	26.84	120.0	25.95	111.6	24.78	
13.0	11.8	145.0	27.74	136.7	26.94	128.4	26.14	124.5	25.06	120.0	24.23	111.6	23.13	
15.0	13.7	145.0	26.12	136.7	25.36	128.4	24.61	124.5	23.58	120.0	22.81	111.6	21.78	

Note

1. TC: Total Capacity(kW), PI: Power Input(kW, Comp. + Outdoor fan motor)
2. Capacity tables show the average value of conditions which may occur.
3. In the range beyond the operation limit of the outdoor unit, continuous operation and performance can not be guaranteed. When selecting the outdoor units, avoid the air temperature range that is not guaranteed continuous operation.

7. Capacity Tables

Combination (%)		Heating Capacity (56HP)												
		Outdoor air temp.		Indoor air temp. °C DB										
		°C DB	°C WB	16		18		20		21		22		24
		TC	PI	TC	PI	TC	PI	TC	PI	TC	PI	TC	PI	
70	-19.8	-20	88.0	35.62	88.0	36.57	88.0	35.94	88.0	34.95	88.0	34.01	88.0	32.97
	-18.8	-19	92.2	36.57	92.2	36.27	92.2	35.63	92.2	34.63	92.2	33.69	92.2	32.63
	-16.7	-17	101.7	36.00	101.7	35.64	101.7	34.96	101.7	33.95	101.7	33.03	95.5	31.93
	-13.7	-15	123.0	35.21	116.1	34.73	109.2	34.03	105.5	32.99	102.3	32.07	95.5	30.92
	-11.8	-13	123.0	34.70	116.1	34.16	109.2	33.44	105.5	32.37	102.3	31.47	95.5	30.29
	-9.8	-11	123.0	34.17	116.1	33.55	109.2	32.81	105.5	31.72	102.3	30.84	95.5	29.61
	-9.5	-10	123.0	34.09	116.1	33.46	109.2	32.71	105.5	31.62	102.3	30.74	95.5	29.51
	-8.5	-9.1	123.0	33.82	116.1	33.17	109.2	32.40	105.5	31.30	102.3	30.43	95.5	29.19
	-7.0	-7.6	123.0	33.43	116.1	32.71	109.2	31.93	105.5	30.82	102.3	29.95	95.5	28.68
	-5.0	-5.6	123.0	32.89	116.1	32.12	109.2	31.30	105.5	30.17	102.3	29.31	95.5	28.01
	-3.0	-3.7	123.0	32.36	116.1	31.51	109.2	30.68	105.5	29.53	102.3	28.68	95.5	27.34
	0.0	-0.7	123.0	31.57	116.1	30.61	109.2	29.74	105.5	28.56	102.3	27.73	95.5	26.33
	3.0	2.2	123.0	30.76	116.1	29.70	109.2	28.81	105.5	27.60	102.3	26.77	95.5	25.33
	5.0	4.1	123.0	30.23	116.1	29.10	109.2	28.18	105.5	26.95	102.3	26.15	95.5	24.65
	7.0	6	123.0	29.70	116.1	28.50	109.2	27.54	105.5	26.30	102.3	25.51	95.5	23.98
	9.0	7.9	123.0	26.81	116.1	25.74	109.2	24.88	105.5	23.75	102.3	23.03	95.5	21.66
11.0	9.8	123.0	24.97	116.1	23.96	109.2	23.16	105.5	22.12	102.3	21.44	95.5	20.16	
13.0	11.8	123.0	23.36	116.1	22.42	109.2	21.67	105.5	20.69	102.3	20.06	95.5	18.86	
15.0	13.7	123.0	22.03	116.1	21.13	109.2	20.43	105.5	19.51	102.3	18.92	95.5	17.78	
60	-19.8	-20	105.5	33.72	99.9	33.10	88.0	32.11	88.0	31.16	87.4	30.21	81.8	29.17
	-18.8	-19	105.5	33.44	99.9	32.79	92.2	31.79	90.5	30.83	87.4	29.90	81.8	28.84
	-16.7	-17	105.5	32.87	99.9	32.11	93.7	31.13	90.5	30.17	87.4	29.23	81.8	28.13
	-13.7	-15	105.5	32.04	99.9	31.18	93.7	30.17	90.5	29.21	87.4	28.27	81.8	27.12
	-11.8	-13	105.5	31.52	99.9	30.58	93.7	29.55	90.5	28.62	87.4	27.66	81.8	26.48
	-9.8	-11	105.5	30.97	99.9	29.96	93.7	28.91	90.5	27.97	87.4	27.03	81.8	25.81
	-9.5	-10	105.5	30.88	99.9	29.86	93.7	28.82	90.5	27.88	87.4	26.93	81.8	25.71
	-8.5	-9.1	105.5	30.61	99.9	29.54	93.7	28.49	90.5	27.56	87.4	26.62	81.8	25.37
	-7.0	-7.6	105.5	30.20	99.9	29.07	93.7	28.02	90.5	27.07	87.4	26.14	81.8	24.87
	-5.0	-5.6	105.5	29.65	99.9	28.44	93.7	27.38	90.5	26.44	87.4	25.51	81.8	24.20
	-3.0	-3.7	105.5	29.09	99.9	27.82	93.7	26.72	90.5	25.79	87.4	24.87	81.8	23.53
	0.0	-0.7	105.5	28.27	99.9	26.88	93.7	25.77	90.5	24.84	87.4	23.92	81.8	22.51
	3.0	2.2	105.5	27.44	99.9	25.93	93.7	24.81	90.5	23.88	87.4	22.96	81.8	21.50
	5.0	4.1	105.5	26.89	99.9	25.30	93.7	24.16	90.5	23.25	87.4	22.32	81.8	20.84
	7.0	6	105.5	26.34	99.9	24.67	93.7	23.52	90.5	22.60	87.4	21.68	81.8	20.16
	9.0	7.9	105.5	23.51	99.9	22.01	93.7	20.99	90.5	20.17	87.4	19.35	81.8	18.00
11.0	9.8	105.5	21.95	99.9	20.57	93.7	19.60	90.5	18.84	87.4	18.06	81.8	16.81	
13.0	11.8	105.5	20.57	99.9	19.26	93.7	18.37	90.5	17.64	87.4	16.92	81.8	15.74	
15.0	13.7	105.5	19.43	99.9	18.20	93.7	17.35	90.5	16.68	87.4	15.99	81.8	14.88	
50	-19.8	-20	88.1	30.21	83.1	29.15	78.0	28.16	75.6	27.16	73.1	26.23	68.1	25.24
	-18.8	-19	88.1	29.88	83.1	28.80	78.0	27.83	75.6	26.83	73.1	25.91	68.1	24.90
	-16.7	-17	88.1	29.17	83.1	28.08	78.0	27.11	75.6	26.14	73.1	25.24	68.1	24.22
	-13.7	-15	88.1	28.17	83.1	27.05	78.0	26.11	75.6	25.12	73.1	24.27	68.1	23.23
	-11.8	-13	88.1	27.53	83.1	26.38	78.0	25.48	75.6	24.49	73.1	23.67	68.1	22.62
	-9.8	-11	88.1	26.87	83.1	25.69	78.0	24.81	75.6	23.82	73.1	23.03	68.1	21.96
	-9.5	-10	88.1	26.77	83.1	25.59	78.0	24.70	75.6	23.72	73.1	22.93	68.1	21.86
	-8.5	-9.1	88.1	26.42	83.1	25.24	78.0	24.37	75.6	23.39	73.1	22.62	68.1	21.54
	-7.0	-7.6	88.1	25.93	83.1	24.73	78.0	23.86	75.6	22.89	73.1	22.13	68.1	21.04
	-5.0	-5.6	88.1	25.27	83.1	24.04	78.0	23.19	75.6	22.21	73.1	21.48	68.1	20.38
	-3.0	-3.7	88.1	24.59	83.1	23.35	78.0	22.52	75.6	21.54	73.1	20.85	68.1	19.73
	0.0	-0.7	88.1	23.59	83.1	22.31	78.0	21.52	75.6	20.54	73.1	19.89	68.1	18.75
	3.0	2.2	88.1	22.58	83.1	21.27	78.0	20.51	75.6	19.55	73.1	18.92	68.1	17.77
	5.0	4.1	88.1	21.92	83.1	20.58	78.0	19.84	75.6	18.88	73.1	18.28	68.1	17.11
	7.0	6	88.1	21.26	83.1	19.89	78.0	19.16	75.6	18.20	73.1	17.64	68.1	16.46
	9.0	7.9	88.1	19.19	83.1	17.96	78.0	17.31	75.6	16.44	73.1	15.93	68.1	14.86
11.0	9.8	88.1	17.96	83.1	16.81	78.0	16.19	75.6	15.38	73.1	14.91	68.1	13.91	
13.0	11.8	88.1	16.86	83.1	15.78	78.0	15.20	75.6	14.44	73.1	13.99	68.1	13.06	
15.0	13.7	88.1	15.95	83.1	14.93	78.0	14.38	75.6	13.67	73.1	13.24	68.1	12.36	

Note

1. TC: Total Capacity(kW), PI: Power Input(kW, Comp. + Outdoor fan motor)
2. Capacity tables show the average value of conditions which may occur.
3. In the range beyond the operation limit of the outdoor unit, continuous operation and performance can not be guaranteed. When selecting the outdoor units, avoid the air temperature range that is not guaranteed continuous operation.

7. Capacity Tables

◆ A(C)RUN580LLS5

Combination (%)	Outdoor air temp.		Heating Capacity (58HP)											
			Indoor air temp. °C DB											
	°C DB	°C WB	16		18		20		21		22		24	
		TC	PI	TC	PI	TC	PI	TC	PI	TC	PI	TC	PI	
130	-19.8	-20	94.0	38.89	94.0	40.38	93.4	41.69	93.4	43.69	93.4	45.60	93.4	48.61
	-18.8	-19	98.6	39.89	98.6	41.39	97.9	42.69	97.9	44.70	97.9	46.60	97.9	49.61
	-16.7	-17	108.2	41.99	108.2	43.50	107.5	44.80	107.5	46.81	107.5	48.70	107.5	51.71
	-13.7	-15	121.8	45.00	121.8	46.51	121.1	47.81	121.1	49.81	121.1	51.71	121.1	51.13
	-11.8	-13	128.7	46.90	128.7	48.40	127.8	49.71	127.8	51.71	127.8	51.43	127.8	50.76
	-9.8	-11	135.9	48.91	135.9	50.40	135.0	51.71	135.0	51.54	135.0	51.13	135.0	50.38
	-9.5	-10	139.2	49.21	139.2	50.70	138.3	51.71	138.3	51.52	136.1	51.09	136.1	50.33
	-8.5	-9.1	149.9	50.21	149.9	51.71	149.0	51.71	149.0	51.43	139.7	50.94	139.7	50.13
	-7.0	-7.6	166.2	51.71	166.2	51.85	165.1	51.69	165.1	51.30	165.1	50.70	151.4	49.84
	-5.0	-5.6	187.8	52.16	187.8	52.04	186.5	51.67	186.5	51.13	186.5	50.40	160.5	49.45
	-3.0	-3.7	209.5	52.62	209.5	52.22	208.1	51.67	204.1	50.95	196.9	50.10	169.6	49.08
	0.0	-0.7	209.9	53.31	209.9	52.49	209.3	51.65	204.1	50.70	196.9	49.66	183.1	48.50
	3.0	2.2	209.9	53.99	209.9	52.77	209.3	51.62	204.1	50.44	196.9	49.20	183.3	47.93
	5.0	4.1	209.9	54.45	209.9	52.96	209.3	51.61	204.1	50.27	196.9	48.90	183.3	47.54
	7.0	6	209.9	54.91	209.9	53.14	209.3	51.61	204.1	50.10	196.9	48.60	183.3	47.15
	9.0	7.9	209.9	55.44	209.9	53.65	209.3	52.10	204.1	50.58	196.9	49.08	183.3	47.60
	11.0	9.8	209.9	56.54	209.9	54.71	209.3	53.11	204.1	51.57	196.9	50.04	183.3	48.54
13.0	11.8	209.9	57.61	209.9	55.76	209.3	54.13	204.1	52.56	196.9	50.99	183.3	49.46	
15.0	13.7	209.9	58.69	209.9	56.80	209.3	55.15	204.1	53.55	196.9	51.95	183.3	50.40	
120	-19.8	-20	93.4	40.38	93.4	41.69	92.8	43.69	92.8	45.60	92.8	48.61	92.8	50.70
	-18.8	-19	97.9	41.39	97.9	42.69	97.3	44.70	97.3	46.60	97.3	49.61	97.3	51.71
	-16.7	-17	107.4	43.50	107.4	44.80	106.7	46.81	106.7	48.70	106.7	51.71	106.7	51.34
	-13.7	-15	120.9	46.51	120.9	47.81	120.3	49.81	120.3	51.71	120.3	51.24	120.3	50.81
	-11.8	-13	127.8	48.40	127.8	49.71	127.0	51.71	127.0	51.41	127.0	50.94	127.0	50.46
	-9.8	-11	135.0	50.40	135.0	51.71	134.1	51.47	134.1	51.09	134.1	50.64	134.1	50.12
	-9.5	-10	138.1	50.70	138.1	51.69	137.4	51.43	137.4	51.05	137.4	50.58	137.4	50.06
	-8.5	-9.1	148.9	51.71	148.9	51.61	147.9	51.30	147.9	50.89	143.5	50.42	143.5	49.88
	-7.0	-7.6	165.0	51.72	165.0	51.49	163.9	51.12	163.9	50.66	150.4	50.18	150.4	49.62
	-5.0	-5.6	186.5	51.73	186.5	51.33	185.4	50.88	185.4	50.34	185.4	49.88	159.4	49.26
	-3.0	-3.7	206.0	51.73	206.0	51.18	197.8	50.63	191.4	50.02	185.4	49.57	168.4	48.91
	0.0	-0.7	208.2	51.76	206.0	50.94	197.8	50.25	191.4	49.54	185.4	49.09	172.2	48.38
	3.0	2.2	208.2	51.76	206.0	50.70	197.8	49.88	191.4	49.08	185.4	48.62	172.2	47.84
	5.0	4.1	208.2	51.77	206.0	50.54	197.8	49.63	191.4	48.76	185.4	48.30	172.2	47.48
	7.0	6	208.2	51.79	206.0	50.39	197.8	49.39	191.4	48.45	185.4	47.99	172.2	47.14
	9.0	7.9	208.2	52.04	206.0	50.64	197.8	49.63	191.4	48.69	185.4	48.23	172.2	47.36
	11.0	9.8	208.2	52.81	206.0	51.37	197.8	50.36	191.4	49.39	185.4	48.94	172.2	48.06
13.0	11.8	208.2	53.56	206.0	52.10	197.8	51.09	191.4	50.11	185.4	49.63	172.2	48.75	
15.0	13.7	208.2	54.31	206.0	52.83	197.8	51.80	191.4	50.79	185.4	50.32	172.2	49.42	
110	-19.8	-20	92.8	41.69	92.8	43.69	92.3	45.60	92.3	48.61	92.3	50.70	92.3	51.71
	-18.8	-19	97.3	42.69	97.3	44.70	96.8	46.60	96.8	49.61	96.8	51.71	96.8	51.43
	-16.7	-17	106.9	44.80	106.9	46.81	106.1	48.70	106.1	51.71	106.1	51.20	106.1	50.83
	-13.7	-15	120.3	47.81	120.3	49.81	119.6	51.71	119.6	51.00	119.6	50.48	119.6	49.97
	-11.8	-13	127.1	49.71	127.1	51.71	126.3	51.24	126.3	50.55	126.3	50.01	126.3	49.43
	-9.8	-11	134.2	51.71	134.2	51.22	133.4	50.75	133.4	50.06	133.4	49.54	133.4	48.85
	-9.5	-10	137.4	51.64	137.4	51.15	136.5	50.68	136.5	49.99	136.5	49.45	136.5	48.76
	-8.5	-9.1	148.1	51.42	148.1	50.91	147.2	50.42	147.2	49.75	143.3	49.21	143.3	48.48
	-7.0	-7.6	164.2	51.07	164.2	50.55	163.0	50.06	163.0	49.39	150.3	48.85	150.3	48.05
	-5.0	-5.6	178.7	50.61	178.7	50.06	177.5	49.57	171.7	48.91	157.4	48.36	155.0	47.48
	-3.0	-3.7	189.1	50.16	189.1	49.58	177.5	49.08	171.7	48.44	165.9	47.88	155.0	46.91
	0.0	-0.7	200.1	49.47	189.1	48.85	177.5	48.33	171.7	47.72	165.9	47.15	155.0	46.05
	3.0	2.2	200.1	48.78	189.1	48.12	177.5	47.60	171.7	47.00	165.9	46.42	155.0	45.20
	5.0	4.1	200.1	48.32	189.1	47.63	177.5	47.11	171.7	46.53	165.9	45.95	155.0	44.62
	7.0	6	200.1	47.87	189.1	47.14	177.5	46.62	171.7	46.05	165.9	45.46	155.0	44.05
	9.0	7.9	200.1	47.83	189.1	47.11	177.5	46.58	171.7	46.02	165.9	45.43	155.0	44.01
	11.0	9.8	200.1	48.26	189.1	47.53	177.5	47.00	171.7	46.42	165.9	45.83	155.0	44.42
13.0	11.8	200.1	48.66	189.1	47.93	177.5	47.39	171.7	46.81	165.9	46.22	155.0	44.79	
15.0	13.7	200.1	49.05	189.1	48.31	177.5	47.77	171.7	47.19	165.9	46.58	155.0	45.14	

Note

1. TC: Total Capacity(kW), PI: Power Input(kW, Comp. + Outdoor fan motor)
2. Capacity tables show the average value of conditions which may occur.
3. In the range beyond the operation limit of the outdoor unit, continuous operation and performance can not be guaranteed. When selecting the outdoor units, avoid the air temperature range that is not guaranteed continuous operation.

7. Capacity Tables

Combination (%)		Heating Capacity (58HP)												
		Outdoor air temp.		Indoor air temp. °C DB										
		°C DB	°C WB	16		18		20		21		22		24
		TC	PI	TC	PI	TC	PI	TC	PI	TC	PI	TC	PI	
100	-19.8	-20	92.5	43.40	92.5	45.06	91.9	46.47	91.9	49.13	91.9	51.00	91.9	51.71
	-18.8	-19	96.9	44.23	96.3	45.89	96.3	47.48	96.3	49.97	96.3	51.71	96.3	51.23
	-16.7	-17	105.8	45.97	105.8	47.64	105.8	49.58	105.1	51.71	105.1	50.79	105.1	50.22
	-13.7	-15	119.8	48.46	119.8	50.13	119.1	51.71	119.1	50.51	119.1	49.48	119.1	48.78
	-11.8	-13	126.4	50.06	125.8	51.71	125.8	51.01	125.8	49.74	125.8	48.63	125.8	47.87
	-9.8	-11	133.5	51.71	133.5	50.98	132.7	50.27	132.7	48.94	132.7	47.75	132.7	46.90
	-9.5	-10	136.6	51.62	136.6	50.88	136.0	50.17	136.0	48.81	136.0	47.63	136.0	46.76
	-8.5	-9.1	147.2	51.30	147.2	50.51	146.6	49.79	157.2	48.42	151.9	47.17	141.6	46.28
	-7.0	-7.6	165.9	50.81	165.3	49.97	162.4	49.24	157.2	47.82	151.9	46.53	141.6	45.56
	-5.0	-5.6	173.1	50.18	171.5	49.24	162.4	48.51	157.2	47.01	151.9	45.65	141.6	44.59
	-3.0	-3.7	178.2	49.54	172.9	48.51	162.4	47.78	157.2	46.20	151.9	44.77	141.6	43.63
	0.0	-0.7	183.2	48.57	172.9	47.43	162.4	46.68	157.2	45.01	151.9	43.44	141.6	42.19
	3.0	2.2	183.2	47.61	172.9	46.33	162.4	45.56	157.2	43.80	151.9	42.12	141.6	40.75
	5.0	4.1	183.2	46.98	172.9	45.61	162.4	44.83	157.2	43.00	151.9	41.24	141.6	39.78
	7.0	6	183.2	46.33	172.9	44.88	162.4	44.10	157.2	42.19	151.9	40.36	141.6	38.83
	9.0	7.9	183.2	45.69	172.9	44.25	162.4	43.49	157.2	41.61	151.9	39.81	141.6	38.29
11.0	9.8	183.2	45.47	172.9	44.04	162.4	43.28	157.2	41.41	151.9	39.63	141.6	38.10	
13.0	11.8	183.2	45.21	172.9	43.80	162.4	43.03	157.2	41.17	151.9	39.39	141.6	37.88	
15.0	13.7	183.2	44.90	172.9	43.50	162.4	42.74	157.2	40.89	151.9	39.11	141.6	37.63	
90	-19.8	-20	92.1	40.89	92.1	43.90	91.5	45.99	91.5	47.00	91.5	46.33	91.5	45.17
	-18.8	-19	96.9	41.89	96.3	44.90	95.9	47.00	95.9	46.68	95.9	46.00	95.9	44.79
	-16.7	-17	105.8	43.99	105.8	47.00	105.3	46.42	105.3	46.03	105.3	45.31	105.3	44.01
	-13.7	-15	119.8	47.00	119.8	46.24	118.5	45.60	118.5	45.08	118.5	44.31	118.5	42.92
	-11.8	-13	126.4	46.57	125.8	45.77	125.2	45.08	125.2	44.49	125.2	43.68	125.2	42.22
	-9.8	-11	133.5	46.12	133.5	45.26	132.2	44.53	132.2	43.86	132.2	43.02	121.4	41.48
	-9.5	-10	136.6	46.05	136.6	45.19	135.4	44.46	135.4	43.76	135.4	42.92	124.3	41.37
	-8.5	-9.1	147.2	45.84	146.3	44.94	145.9	44.19	143.9	43.46	139.4	42.59	129.4	41.00
	-7.0	-7.6	165.9	45.50	157.9	44.57	148.5	43.77	143.9	42.98	139.4	42.08	129.4	40.45
	-5.0	-5.6	167.7	45.04	157.9	44.06	148.5	43.22	143.9	42.35	139.4	41.42	129.4	39.71
	-3.0	-3.7	167.7	44.59	157.9	43.56	148.5	42.68	143.9	41.72	139.4	40.76	129.4	38.98
	0.0	-0.7	167.7	43.92	157.9	42.80	148.5	41.86	143.9	40.78	139.4	39.75	129.4	37.87
	3.0	2.2	167.7	43.24	157.9	42.05	148.5	41.03	143.9	39.84	139.4	38.76	129.4	36.77
	5.0	4.1	167.7	42.79	157.9	41.54	148.5	40.48	143.9	39.20	139.4	38.10	129.4	36.04
	7.0	6	167.7	42.34	157.9	41.04	148.5	39.94	143.9	38.57	139.4	37.43	129.4	35.30
	9.0	7.9	167.7	41.76	157.9	40.48	148.5	39.39	143.9	38.05	139.4	36.92	129.4	34.81
11.0	9.8	167.7	41.18	157.9	39.91	148.5	38.85	143.9	37.52	139.4	36.40	129.4	34.33	
13.0	11.8	167.7	40.60	157.9	39.35	148.5	38.29	143.9	36.98	139.4	35.89	129.4	33.84	
15.0	13.7	167.7	40.02	157.9	38.78	148.5	37.75	143.9	36.46	139.4	35.37	129.4	33.36	
80	-19.8	-20	91.1	35.56	91.1	38.57	91.1	41.68	91.1	41.04	91.1	40.08	91.1	39.05
	-18.8	-19	95.5	36.57	95.5	41.68	95.5	41.39	95.5	40.72	95.5	39.75	95.5	38.72
	-16.7	-17	105.3	41.68	105.3	41.13	105.3	40.79	105.3	40.07	105.3	39.09	105.3	38.01
	-13.7	-15	124.1	40.97	121.5	40.36	118.5	39.93	118.5	39.11	118.5	38.12	115.6	37.01
	-11.8	-13	134.1	40.52	130.2	39.88	125.2	39.39	125.2	38.52	124.3	37.51	115.6	36.37
	-9.8	-11	138.3	40.05	134.2	39.36	132.2	38.81	129.0	37.89	124.3	36.87	115.6	35.71
	-9.5	-10	139.2	39.97	135.2	39.27	132.9	38.72	129.0	37.79	124.3	36.78	115.6	35.60
	-8.5	-9.1	144.4	39.73	141.6	39.02	132.9	38.44	129.0	37.47	124.3	36.46	115.6	35.26
	-7.0	-7.6	150.2	39.39	141.6	38.63	132.9	38.00	129.0	36.99	124.3	35.98	115.6	34.76
	-5.0	-5.6	150.2	38.91	141.6	38.12	132.9	37.43	129.0	36.37	124.3	35.34	115.6	34.09
	-3.0	-3.7	150.2	38.44	141.6	37.60	132.9	36.85	129.0	35.73	124.3	34.70	115.6	33.43
	0.0	-0.7	150.2	37.72	141.6	36.83	132.9	35.99	129.0	34.79	124.3	33.73	115.6	32.42
	3.0	2.2	150.2	37.02	141.6	36.05	132.9	35.13	129.0	33.84	124.3	32.78	115.6	31.41
	5.0	4.1	150.2	36.54	141.6	35.53	132.9	34.56	129.0	33.20	124.3	32.14	115.6	30.74
	7.0	6	150.2	36.07	141.6	35.02	132.9	33.98	129.0	32.57	124.3	31.50	115.6	30.08
	9.0	7.9	150.2	33.86	141.6	32.87	132.9	31.90	129.0	30.59	124.3	29.58	115.6	28.25
11.0	9.8	150.2	31.43	141.6	30.52	132.9	29.62	129.0	28.38	124.3	27.45	115.6	26.21	
13.0	11.8	150.2	29.34	141.6	28.49	132.9	27.64	129.0	26.50	124.3	25.63	115.6	24.47	
15.0	13.7	150.2	27.62	141.6	26.82	132.9	26.03	129.0	24.94	124.3	24.12	115.6	23.03	

Note

1. TC: Total Capacity(kW), PI: Power Input(kW, Comp. + Outdoor fan motor)
2. Capacity tables show the average value of conditions which may occur.
3. In the range beyond the operation limit of the outdoor unit, continuous operation and performance can not be guaranteed. When selecting the outdoor units, avoid the air temperature range that is not guaranteed continuous operation.

7. Capacity Tables

Combination (%)		Heating Capacity (58HP)													
		Outdoor air temp.		Indoor air temp. °C DB											
		°C DB	°C WB	16		18		20		21		22		24	
		TC	PI	TC	PI	TC	PI	TC	PI	TC	PI	TC	PI		
70	-19.8	-20	91.1	37.67	91.1	38.67	91.1	38.01	91.1	36.96	91.1	35.96	91.1	34.87	
	-18.8	-19	95.5	38.67	95.5	38.36	95.5	37.69	95.5	36.63	95.5	35.63	95.5	34.51	
	-16.7	-17	105.3	38.08	105.3	37.69	105.3	36.98	105.3	35.90	105.3	34.93	98.9	33.77	
	-13.7	-15	127.4	37.24	120.3	36.73	113.1	35.99	109.3	34.89	106.0	33.92	98.9	32.70	
	-11.8	-13	127.4	36.69	120.3	36.13	113.1	35.36	109.3	34.23	106.0	33.28	98.9	32.03	
	-9.8	-11	127.4	36.14	120.3	35.49	113.1	34.70	109.3	33.55	106.0	32.61	98.9	31.32	
	-9.5	-10	127.4	36.05	120.3	35.39	113.1	34.59	109.3	33.45	106.0	32.51	98.9	31.21	
	-8.5	-9.1	127.4	35.77	120.3	35.08	113.1	34.27	109.3	33.10	106.0	32.18	98.9	30.87	
	-7.0	-7.6	127.4	35.35	120.3	34.59	113.1	33.77	109.3	32.60	106.0	31.67	98.9	30.33	
	-5.0	-5.6	127.4	34.79	120.3	33.97	113.1	33.10	109.3	31.91	106.0	31.00	98.9	29.62	
	-3.0	-3.7	127.4	34.22	120.3	33.33	113.1	32.45	109.3	31.23	106.0	30.33	98.9	28.91	
	0.0	-0.7	127.4	33.38	120.3	32.37	113.1	31.45	109.3	30.20	106.0	29.32	98.9	27.84	
	3.0	2.2	127.4	32.53	120.3	31.41	113.1	30.46	109.3	29.18	106.0	28.31	98.9	26.79	
	5.0	4.1	127.4	31.97	120.3	30.78	113.1	29.80	109.3	28.50	106.0	27.65	98.9	26.07	
	7.0	6	127.4	31.41	120.3	30.14	113.1	29.13	109.3	27.82	106.0	26.98	98.9	25.36	
	9.0	7.9	127.4	28.35	120.3	27.22	113.1	26.31	109.3	25.12	106.0	24.36	98.9	22.91	
11.0	9.8	127.4	26.40	120.3	25.34	113.1	24.49	109.3	23.39	106.0	22.68	98.9	21.32		
13.0	11.8	127.4	24.70	120.3	23.71	113.1	22.92	109.3	21.88	106.0	21.22	98.9	19.95		
15.0	13.7	127.4	23.30	120.3	22.35	113.1	21.60	109.3	20.63	106.0	20.01	98.9	18.80		
60	-19.8	-20	109.3	35.66	103.5	35.00	91.1	33.97	91.1	32.95	90.5	31.95	84.7	30.85	
	-18.8	-19	109.3	35.37	103.5	34.67	95.5	33.62	93.7	32.61	90.5	31.62	84.7	30.50	
	-16.7	-17	109.3	34.77	103.5	33.97	97.0	32.92	93.7	31.91	90.5	30.91	84.7	29.75	
	-13.7	-15	109.3	33.89	103.5	32.98	97.0	31.91	93.7	30.90	90.5	29.90	84.7	28.68	
	-11.8	-13	109.3	33.34	103.5	32.34	97.0	31.25	93.7	30.27	90.5	29.26	84.7	28.01	
	-9.8	-11	109.3	32.76	103.5	31.68	97.0	30.57	93.7	29.58	90.5	28.59	84.7	27.29	
	-9.5	-10	109.3	32.66	103.5	31.58	97.0	30.48	93.7	29.48	90.5	28.48	84.7	27.19	
	-8.5	-9.1	109.3	32.37	103.5	31.24	97.0	30.14	93.7	29.15	90.5	28.15	84.7	26.83	
	-7.0	-7.6	109.3	31.94	103.5	30.75	97.0	29.63	93.7	28.63	90.5	27.65	84.7	26.31	
	-5.0	-5.6	109.3	31.36	103.5	30.08	97.0	28.96	93.7	27.96	90.5	26.98	84.7	25.59	
	-3.0	-3.7	109.3	30.77	103.5	29.42	97.0	28.26	93.7	27.28	90.5	26.31	84.7	24.89	
	0.0	-0.7	109.3	29.90	103.5	28.42	97.0	27.25	93.7	26.27	90.5	25.29	84.7	23.81	
	3.0	2.2	109.3	29.02	103.5	27.43	97.0	26.24	93.7	25.26	90.5	24.28	84.7	22.74	
	5.0	4.1	109.3	28.44	103.5	26.76	97.0	25.55	93.7	24.58	90.5	23.60	84.7	22.04	
	7.0	6	109.3	27.86	103.5	26.09	97.0	24.87	93.7	23.90	90.5	22.93	84.7	21.32	
	9.0	7.9	109.3	24.86	103.5	23.28	97.0	22.20	93.7	21.33	90.5	20.46	84.7	19.04	
11.0	9.8	109.3	23.21	103.5	21.75	97.0	20.72	93.7	19.92	90.5	19.10	84.7	17.77		
13.0	11.8	109.3	21.75	103.5	20.37	97.0	19.42	93.7	18.66	90.5	17.90	84.7	16.64		
15.0	13.7	109.3	20.55	103.5	19.25	97.0	18.35	93.7	17.64	90.5	16.91	84.7	15.73		
50	-19.8	-20	91.2	31.95	86.1	30.83	80.8	29.79	78.3	28.72	75.7	27.75	70.5	26.69	
	-18.8	-19	91.2	31.60	86.1	30.46	80.8	29.43	78.3	28.38	75.7	27.41	70.5	26.34	
	-16.7	-17	91.2	30.85	86.1	29.70	80.8	28.68	78.3	27.64	75.7	26.69	70.5	25.62	
	-13.7	-15	91.2	29.79	86.1	28.61	80.8	27.62	78.3	26.57	75.7	25.67	70.5	24.57	
	-11.8	-13	91.2	29.12	86.1	27.90	80.8	26.95	78.3	25.90	75.7	25.04	70.5	23.92	
	-9.8	-11	91.2	28.42	86.1	27.17	80.8	26.24	78.3	25.19	75.7	24.35	70.5	23.22	
	-9.5	-10	91.2	28.31	86.1	27.07	80.8	26.13	78.3	25.09	75.7	24.25	70.5	23.12	
	-8.5	-9.1	91.2	27.95	86.1	26.70	80.8	25.77	78.3	24.74	75.7	23.92	70.5	22.78	
	-7.0	-7.6	91.2	27.42	86.1	26.16	80.8	25.24	78.3	24.21	75.7	23.40	70.5	22.26	
	-5.0	-5.6	91.2	26.72	86.1	25.43	80.8	24.52	78.3	23.49	75.7	22.72	70.5	21.56	
	-3.0	-3.7	91.2	26.01	86.1	24.70	80.8	23.82	78.3	22.78	75.7	22.05	70.5	20.87	
	0.0	-0.7	91.2	24.95	86.1	23.60	80.8	22.76	78.3	21.72	75.7	21.03	70.5	19.83	
	3.0	2.2	91.2	23.88	86.1	22.50	80.8	21.69	78.3	20.67	75.7	20.01	70.5	18.80	
	5.0	4.1	91.2	23.18	86.1	21.77	80.8	20.98	78.3	19.96	75.7	19.34	70.5	18.09	
	7.0	6	91.2	22.48	86.1	21.04	80.8	20.26	78.3	19.25	75.7	18.65	70.5	17.40	
	9.0	7.9	91.2	20.29	86.1	19.00	80.8	18.31	78.3	17.39	75.7	16.85	70.5	15.72	
11.0	9.8	91.2	18.99	86.1	17.78	80.8	17.12	78.3	16.27	75.7	15.76	70.5	14.71		
13.0	11.8	91.2	17.83	86.1	16.69	80.8	16.08	78.3	15.27	75.7	14.80	70.5	13.81		
15.0	13.7	91.2	16.87	86.1	15.79	80.8	15.21	78.3	14.45	75.7	14.01	70.5	13.07		

Note

1. TC: Total Capacity(kW), PI: Power Input(kW, Comp. + Outdoor fan motor)
2. Capacity tables show the average value of conditions which may occur.
3. In the range beyond the operation limit of the outdoor unit, continuous operation and performance can not be guaranteed. When selecting the outdoor units, avoid the air temperature range that is not guaranteed continuous operation.

7. Capacity Tables

◆ A(C)RUN600LLS5

Combination (%)	Outdoor air temp.		Heating Capacity (60HP)											
			Indoor air temp. °C DB											
	°C DB	°C WB	16		18		20		21		22		24	
		TC	PI	TC	PI	TC	PI	TC	PI	TC	PI	TC	PI	
130	-19.8	-20	97.2	41.79	97.2	43.40	96.6	44.80	96.6	46.96	96.6	49.01	96.6	52.25
	-18.8	-19	102.0	42.86	102.0	44.48	101.2	45.88	101.2	48.04	101.2	50.08	101.2	53.32
	-16.7	-17	111.9	45.13	111.9	46.75	111.2	48.14	111.2	50.30	111.2	52.35	111.2	55.58
	-13.7	-15	126.0	48.36	126.0	49.98	125.2	51.38	125.2	53.53	125.2	55.58	125.2	54.96
	-11.8	-13	133.1	50.41	133.1	52.02	132.2	53.43	132.2	55.58	132.2	55.28	132.2	54.56
	-9.8	-11	140.6	52.57	140.6	54.18	139.6	55.58	139.6	55.39	139.6	54.96	139.6	54.15
	-9.5	-10	144.0	52.89	144.0	54.50	143.1	55.58	143.1	55.37	140.8	54.91	140.8	54.09
	-8.5	-9.1	155.1	53.97	155.1	55.58	154.1	55.58	154.1	55.28	144.5	54.75	144.5	53.89
	-7.0	-7.6	171.9	55.58	171.9	55.73	170.8	55.56	170.8	55.14	170.8	54.50	156.6	53.57
	-5.0	-5.6	194.3	56.07	194.3	55.93	193.0	55.54	193.0	54.96	193.0	54.18	166.0	53.15
	-3.0	-3.7	216.7	56.56	216.7	56.13	215.3	55.53	211.1	54.77	203.7	53.86	175.4	52.75
	0.0	-0.7	217.1	57.30	217.1	56.42	216.5	55.52	211.1	54.49	203.7	53.37	189.4	52.12
	3.0	2.2	217.1	58.04	217.1	56.72	216.5	55.49	211.1	54.22	203.7	52.88	189.6	51.51
	5.0	4.1	217.1	58.53	217.1	56.92	216.5	55.47	211.1	54.03	203.7	52.56	189.6	51.10
	7.0	6	217.1	59.02	217.1	57.12	216.5	55.47	211.1	53.85	203.7	52.24	189.6	50.68
	9.0	7.9	217.1	59.59	217.1	57.67	216.5	56.00	211.1	54.37	203.7	52.75	189.6	51.17
	11.0	9.8	217.1	60.77	217.1	58.80	216.5	57.09	211.1	55.42	203.7	53.79	189.6	52.17
13.0	11.8	217.1	61.92	217.1	59.93	216.5	58.18	211.1	56.49	203.7	54.80	189.6	53.17	
15.0	13.7	217.1	63.08	217.1	61.05	216.5	59.28	211.1	57.55	203.7	55.84	189.6	54.17	
120	-19.8	-20	96.6	43.40	96.6	44.80	96.0	46.96	96.0	49.01	96.0	52.25	96.0	54.50
	-18.8	-19	101.2	44.48	101.2	45.88	100.6	48.04	100.6	50.08	100.6	53.32	100.6	55.58
	-16.7	-17	111.0	46.75	111.0	48.14	110.4	50.30	110.4	52.35	110.4	55.58	110.4	55.18
	-13.7	-15	125.1	49.98	125.1	51.38	124.4	53.53	124.4	55.58	124.4	55.07	124.4	54.61
	-11.8	-13	132.2	52.02	132.2	53.43	131.4	55.58	131.4	55.26	131.4	54.75	131.4	54.24
	-9.8	-11	139.6	54.18	139.6	55.58	138.7	55.32	138.7	54.92	138.7	54.43	138.7	53.87
	-9.5	-10	142.8	54.50	142.8	55.55	142.1	55.28	142.1	54.87	142.1	54.37	142.1	53.81
	-8.5	-9.1	154.0	55.58	154.0	55.47	153.0	55.14	153.0	54.70	148.5	54.19	148.5	53.62
	-7.0	-7.6	170.7	55.59	170.7	55.34	169.6	54.94	169.6	54.45	155.5	53.94	155.5	53.34
	-5.0	-5.6	192.9	55.60	192.9	55.17	191.8	54.68	191.8	54.11	191.8	53.61	164.8	52.94
	-3.0	-3.7	213.1	55.60	213.1	55.01	204.7	54.42	198.0	53.76	191.8	53.27	174.1	52.57
	0.0	-0.7	215.4	55.63	213.1	54.75	204.7	54.02	198.0	53.25	191.8	52.76	178.1	52.00
	3.0	2.2	215.4	55.64	213.1	54.49	204.7	53.62	198.0	52.75	191.8	52.25	178.1	51.42
	5.0	4.1	215.4	55.65	213.1	54.32	204.7	53.35	198.0	52.41	191.8	51.92	178.1	51.04
	7.0	6	215.4	55.66	213.1	54.16	204.7	53.09	198.0	52.07	191.8	51.58	178.1	50.66
	9.0	7.9	215.4	55.94	213.1	54.43	204.7	53.34	198.0	52.33	191.8	51.84	178.1	50.91
	11.0	9.8	215.4	56.76	213.1	55.22	204.7	54.13	198.0	53.09	191.8	52.60	178.1	51.66
13.0	11.8	215.4	57.57	213.1	56.00	204.7	54.91	198.0	53.85	191.8	53.34	178.1	52.40	
15.0	13.7	215.4	58.37	213.1	56.78	204.7	55.67	198.0	54.59	191.8	54.08	178.1	53.12	
110	-19.8	-20	96.0	44.80	96.0	46.96	95.5	49.01	95.5	52.25	95.5	54.50	95.5	55.58
	-18.8	-19	100.6	45.88	100.6	48.04	100.1	50.08	100.1	53.32	100.1	55.58	100.1	55.28
	-16.7	-17	110.5	48.14	110.5	50.30	109.7	52.35	109.7	55.58	109.7	55.03	109.7	54.64
	-13.7	-15	124.4	51.38	124.4	53.53	123.6	55.58	123.6	54.81	123.6	54.25	123.6	53.71
	-11.8	-13	131.5	53.43	131.5	55.58	130.6	55.08	130.6	54.33	130.6	53.76	130.6	53.13
	-9.8	-11	138.8	55.58	138.8	55.06	138.0	54.55	138.0	53.81	138.0	53.24	138.0	52.51
	-9.5	-10	142.1	55.51	142.1	54.98	141.2	54.48	141.2	53.73	141.2	53.15	141.2	52.42
	-8.5	-9.1	153.2	55.26	153.2	54.72	152.2	54.20	152.2	53.47	148.3	52.90	148.3	52.11
	-7.0	-7.6	169.8	54.89	169.8	54.33	168.7	53.81	168.7	53.09	155.5	52.51	155.5	51.65
	-5.0	-5.6	184.9	54.40	184.9	53.81	183.7	53.28	177.7	52.57	162.9	51.98	160.4	51.04
	-3.0	-3.7	195.7	53.91	195.7	53.29	183.7	52.75	177.7	52.06	171.7	51.47	160.4	50.42
	0.0	-0.7	207.0	53.18	195.7	52.51	183.7	51.95	177.7	51.29	171.7	50.68	160.4	49.50
	3.0	2.2	207.0	52.43	195.7	51.72	183.7	51.16	177.7	50.52	171.7	49.90	160.4	48.58
	5.0	4.1	207.0	51.93	195.7	51.19	183.7	50.63	177.7	50.01	171.7	49.38	160.4	47.96
	7.0	6	207.0	51.45	195.7	50.67	183.7	50.10	177.7	49.50	171.7	48.86	160.4	47.35
	9.0	7.9	207.0	51.41	195.7	50.64	183.7	50.06	177.7	49.46	171.7	48.83	160.4	47.31
	11.0	9.8	207.0	51.87	195.7	51.08	183.7	50.52	177.7	49.90	171.7	49.26	160.4	47.75
13.0	11.8	207.0	52.30	195.7	51.52	183.7	50.94	177.7	50.32	171.7	49.67	160.4	48.14	
15.0	13.7	207.0	52.72	195.7	51.93	183.7	51.34	177.7	50.72	171.7	50.06	160.4	48.52	

Note

1. TC: Total Capacity(kW), PI : Power Input(kW, Comp. + Outdoor fan motor)
2. Capacity tables show the average value of conditions which may occur.
3. In the range beyond the operation limit of the outdoor unit, continuous operation and performance can not be guaranteed. When selecting the outdoor units, avoid the air temperature range that is not guaranteed continuous operation.

7. Capacity Tables

Combination (%)		Heating Capacity (60HP)												
		Outdoor air temp.		Indoor air temp. °C DB										
		°C DB	°C WB	16		18		20		21		22		24
		TC	PI	TC	PI	TC	PI	TC	PI	TC	PI	TC	PI	
100	-19.8	-20	95.7	46.65	95.7	48.43	95.0	49.94	95.0	52.81	95.0	54.82	95.0	55.58
	-18.8	-19	100.3	47.53	99.6	49.32	99.6	51.03	99.6	53.71	99.6	55.58	99.6	55.07
	-16.7	-17	109.4	49.41	109.4	51.20	109.4	53.29	108.6	55.58	108.6	54.59	108.6	53.98
	-13.7	-15	123.9	52.09	123.9	53.88	123.2	55.58	123.2	54.29	123.2	53.18	123.2	52.43
	-11.8	-13	130.8	53.80	130.1	55.58	130.1	54.83	130.1	53.46	130.1	52.27	130.1	51.45
	-9.8	-11	138.0	55.58	138.0	54.80	137.3	54.04	137.3	52.60	137.3	51.33	137.3	50.41
	-9.5	-10	141.3	55.49	141.3	54.69	140.7	53.92	140.7	52.47	140.7	51.19	140.7	50.26
	-8.5	-9.1	152.3	55.14	152.3	54.29	151.6	53.52	162.6	52.04	157.2	50.71	146.5	49.74
	-7.0	-7.6	171.7	54.61	171.0	53.71	168.0	52.93	162.6	51.40	157.2	50.01	146.5	48.97
	-5.0	-5.6	179.1	53.93	177.4	52.93	168.0	52.14	162.6	50.53	157.2	49.06	146.5	47.93
	-3.0	-3.7	184.4	53.25	178.8	52.14	168.0	51.36	162.6	49.66	157.2	48.12	146.5	46.89
	0.0	-0.7	189.5	52.21	178.8	50.98	168.0	50.17	162.6	48.37	157.2	46.70	146.5	45.35
	3.0	2.2	189.5	51.17	178.8	49.80	168.0	48.97	162.6	47.08	157.2	45.27	146.5	43.80
	5.0	4.1	189.5	50.49	178.8	49.02	168.0	48.19	162.6	46.21	157.2	44.33	146.5	42.76
	7.0	6	189.5	49.80	178.8	48.23	168.0	47.40	162.6	45.35	157.2	43.38	146.5	41.73
	9.0	7.9	189.5	49.11	178.8	47.56	168.0	46.74	162.6	44.72	157.2	42.79	146.5	41.15
11.0	9.8	189.5	48.87	178.8	47.34	168.0	46.52	162.6	44.51	157.2	42.59	146.5	40.95	
13.0	11.8	189.5	48.60	178.8	47.07	168.0	46.25	162.6	44.25	157.2	42.34	146.5	40.72	
15.0	13.7	189.5	48.26	178.8	46.75	168.0	45.94	162.6	43.95	157.2	42.04	146.5	40.44	
90	-19.8	-20	95.2	43.94	95.2	47.18	94.6	49.43	94.6	50.52	94.6	49.80	94.6	48.55
	-18.8	-19	100.3	45.02	99.6	48.26	99.2	50.52	99.2	50.17	99.2	49.45	99.2	48.14
	-16.7	-17	109.4	47.28	109.4	50.52	108.9	49.90	108.9	49.48	108.9	48.70	108.9	47.31
	-13.7	-15	123.9	50.52	123.9	49.71	122.6	49.02	122.6	48.46	122.6	47.62	122.6	46.13
	-11.8	-13	130.8	50.06	130.1	49.19	129.5	48.46	129.5	47.82	129.5	46.95	129.5	45.38
	-9.8	-11	138.0	49.58	138.0	48.65	136.8	47.87	136.8	47.14	136.8	46.24	125.6	44.58
	-9.5	-10	141.3	49.50	141.3	48.57	140.1	47.78	140.1	47.03	140.1	46.13	128.6	44.47
	-8.5	-9.1	152.3	49.27	151.3	48.30	151.0	47.49	148.9	46.71	144.2	45.78	133.9	44.07
	-7.0	-7.6	171.7	48.90	163.4	47.91	153.7	47.05	148.9	46.20	144.2	45.23	133.9	43.48
	-5.0	-5.6	173.5	48.41	163.4	47.35	153.7	46.46	148.9	45.52	144.2	44.52	133.9	42.68
	-3.0	-3.7	173.5	47.93	163.4	46.82	153.7	45.88	148.9	44.84	144.2	43.81	133.9	41.89
	0.0	-0.7	173.5	47.21	163.4	46.01	153.7	44.99	148.9	43.83	144.2	42.73	133.9	40.71
	3.0	2.2	173.5	46.47	163.4	45.20	153.7	44.10	148.9	42.82	144.2	41.66	133.9	39.52
	5.0	4.1	173.5	45.99	163.4	44.65	153.7	43.51	148.9	42.13	144.2	40.95	133.9	38.73
	7.0	6	173.5	45.51	163.4	44.12	153.7	42.93	148.9	41.46	144.2	40.23	133.9	37.94
	9.0	7.9	173.5	44.89	163.4	43.51	153.7	42.34	148.9	40.90	144.2	39.68	133.9	37.41
11.0	9.8	173.5	44.26	163.4	42.90	153.7	41.76	148.9	40.32	144.2	39.12	133.9	36.90	
13.0	11.8	173.5	43.64	163.4	42.29	153.7	41.16	148.9	39.75	144.2	38.58	133.9	36.37	
15.0	13.7	173.5	43.01	163.4	41.69	153.7	40.58	148.9	39.19	144.2	38.02	133.9	35.86	
80	-19.8	-20	94.3	38.22	94.3	41.45	94.3	44.80	94.3	44.12	94.3	43.08	94.3	41.97
	-18.8	-19	98.7	39.30	98.7	44.80	98.7	44.49	98.7	43.77	98.7	42.73	98.7	41.61
	-16.7	-17	108.9	44.80	108.9	44.21	108.9	43.84	108.9	43.07	108.9	42.02	108.9	40.85
	-13.7	-15	128.3	44.04	125.7	43.38	122.6	42.92	122.6	42.04	122.6	40.98	119.6	39.78
	-11.8	-13	138.7	43.55	134.7	42.86	129.5	42.33	129.5	41.41	128.5	40.32	119.6	39.09
	-9.8	-11	143.1	43.04	138.8	42.30	136.8	41.71	133.4	40.72	128.5	39.63	119.6	38.38
	-9.5	-10	144.0	42.96	139.8	42.21	137.5	41.62	133.4	40.62	128.5	39.54	119.6	38.27
	-8.5	-9.1	149.4	42.71	146.5	41.94	137.5	41.31	133.4	40.27	128.5	39.19	119.6	37.90
	-7.0	-7.6	155.4	42.33	146.5	41.52	137.5	40.85	133.4	39.76	128.5	38.67	119.6	37.36
	-5.0	-5.6	155.4	41.82	146.5	40.97	137.5	40.23	133.4	39.09	128.5	37.98	119.6	36.64
	-3.0	-3.7	155.4	41.31	146.5	40.42	137.5	39.61	133.4	38.40	128.5	37.30	119.6	35.93
	0.0	-0.7	155.4	40.55	146.5	39.58	137.5	38.69	133.4	37.39	128.5	36.26	119.6	34.85
	3.0	2.2	155.4	39.79	146.5	38.75	137.5	37.76	133.4	36.37	128.5	35.23	119.6	33.76
	5.0	4.1	155.4	39.28	146.5	38.19	137.5	37.15	133.4	35.68	128.5	34.54	119.6	33.04
	7.0	6	155.4	38.77	146.5	37.64	137.5	36.53	133.4	35.01	128.5	33.85	119.6	32.33
	9.0	7.9	155.4	38.40	146.5	37.33	137.5	36.29	133.4	34.87	128.5	33.79	119.6	31.86
11.0	9.8	155.4	38.17	146.5	37.11	137.5	36.15	133.4	34.71	128.5	33.71	119.6	31.47	
13.0	11.8	155.4	38.01	146.5	36.95	137.5	36.04	133.4	34.64	128.5	33.64	119.6	31.11	
15.0	13.7	155.4	37.91	146.5	36.84	137.5	35.97	133.4	34.61	128.5	33.61	119.6	30.77	

Note

1. TC: Total Capacity(kW), PI: Power Input(kW, Comp. + Outdoor fan motor)
2. Capacity tables show the average value of conditions which may occur.
3. In the range beyond the operation limit of the outdoor unit, continuous operation and performance can not be guaranteed. When selecting the outdoor units, avoid the air temperature range that is not guaranteed continuous operation.

7. Capacity Tables

Combination (%)	Outdoor air temp.		Heating Capacity (60HP)											
			Indoor air temp. °C DB											
	°C DB	°C WB	16		18		20		21		22		24	
		TC	PI	TC	PI	TC	PI	TC	PI	TC	PI	TC	PI	
70	-19.8	-20	94.3	40.49	94.3	41.56	94.3	40.86	94.3	39.73	94.3	38.65	94.3	37.48
	-18.8	-19	98.7	41.56	98.7	41.23	98.7	40.50	98.7	39.37	98.7	38.30	98.7	37.09
	-16.7	-17	108.9	40.93	108.9	40.51	108.9	39.74	108.9	38.59	108.9	37.54	102.3	36.30
	-13.7	-15	131.8	40.02	124.4	39.48	117.0	38.68	113.0	37.50	109.6	36.46	102.3	35.15
	-11.8	-13	131.8	39.44	124.4	38.83	117.0	38.01	113.0	36.79	109.6	35.77	102.3	34.43
	-9.8	-11	131.8	38.84	124.4	38.14	117.0	37.29	113.0	36.06	109.6	35.05	102.3	33.66
	-9.5	-10	131.8	38.75	124.4	38.03	117.0	37.18	113.0	35.95	109.6	34.94	102.3	33.55
	-8.5	-9.1	131.8	38.44	124.4	37.70	117.0	36.83	113.0	35.58	109.6	34.59	102.3	33.17
	-7.0	-7.6	131.8	37.99	124.4	37.18	117.0	36.30	113.0	35.03	109.6	34.04	102.3	32.60
	-5.0	-5.6	131.8	37.39	124.4	36.51	117.0	35.58	113.0	34.30	109.6	33.32	102.3	31.83
	-3.0	-3.7	131.8	36.78	124.4	35.82	117.0	34.87	113.0	33.56	109.6	32.60	102.3	31.08
	0.0	-0.7	131.8	35.88	124.4	34.79	117.0	33.80	113.0	32.46	109.6	31.52	102.3	29.93
	3.0	2.2	131.8	34.96	124.4	33.76	117.0	32.74	113.0	31.37	109.6	30.43	102.3	28.79
	5.0	4.1	131.8	34.36	124.4	33.08	117.0	32.03	113.0	30.63	109.6	29.72	102.3	28.02
	7.0	6	131.8	33.76	124.4	32.40	117.0	31.31	113.0	29.90	109.6	29.00	102.3	27.26
	9.0	7.9	131.8	30.48	124.4	29.26	117.0	28.28	113.0	27.00	109.6	26.18	102.3	24.62
11.0	9.8	131.8	28.38	124.4	27.24	117.0	26.33	113.0	25.14	109.6	24.37	102.3	22.92	
13.0	11.8	131.8	26.55	124.4	25.48	117.0	24.63	113.0	23.52	109.6	22.81	102.3	21.44	
15.0	13.7	131.8	25.04	124.4	24.02	117.0	23.22	113.0	22.18	109.6	21.51	102.3	20.21	
60	-19.8	-20	113.0	38.33	107.0	37.62	94.3	36.50	94.3	35.42	93.6	34.34	87.6	33.16
	-18.8	-19	113.0	38.01	107.0	37.26	98.7	36.14	97.0	35.05	93.6	33.98	87.6	32.78
	-16.7	-17	113.0	37.36	107.0	36.50	100.4	35.38	97.0	34.29	93.6	33.22	87.6	31.97
	-13.7	-15	113.0	36.42	107.0	35.44	100.4	34.29	97.0	33.21	93.6	32.13	87.6	30.82
	-11.8	-13	113.0	35.83	107.0	34.76	100.4	33.59	97.0	32.53	93.6	31.45	87.6	30.10
	-9.8	-11	113.0	35.20	107.0	34.05	100.4	32.86	97.0	31.80	93.6	30.72	87.6	29.33
	-9.5	-10	113.0	35.10	107.0	33.94	100.4	32.76	97.0	31.68	93.6	30.61	87.6	29.22
	-8.5	-9.1	113.0	34.79	107.0	33.58	100.4	32.39	97.0	31.33	93.6	30.26	87.6	28.84
	-7.0	-7.6	113.0	34.33	107.0	33.05	100.4	31.84	97.0	30.77	93.6	29.72	87.6	28.27
	-5.0	-5.6	113.0	33.70	107.0	32.33	100.4	31.12	97.0	30.05	93.6	28.99	87.6	27.51
	-3.0	-3.7	113.0	33.07	107.0	31.62	100.4	30.38	97.0	29.32	93.6	28.27	87.6	26.75
	0.0	-0.7	113.0	32.14	107.0	30.55	100.4	29.29	97.0	28.23	93.6	27.19	87.6	25.59
	3.0	2.2	113.0	31.19	107.0	29.48	100.4	28.20	97.0	27.14	93.6	26.10	87.6	24.44
	5.0	4.1	113.0	30.57	107.0	28.76	100.4	27.46	97.0	26.42	93.6	25.37	87.6	23.68
	7.0	6	113.0	29.94	107.0	28.04	100.4	26.73	97.0	25.69	93.6	24.65	87.6	22.92
	9.0	7.9	113.0	26.72	107.0	25.02	100.4	23.86	97.0	22.93	93.6	21.99	87.6	20.46
11.0	9.8	113.0	24.95	107.0	23.38	100.4	22.28	97.0	21.41	93.6	20.53	87.6	19.10	
13.0	11.8	113.0	23.38	107.0	21.89	100.4	20.88	97.0	20.05	93.6	19.24	87.6	17.89	
15.0	13.7	113.0	22.08	107.0	20.69	100.4	19.73	97.0	18.96	93.6	18.18	87.6	16.91	
50	-19.8	-20	94.4	34.33	89.0	33.13	83.6	32.01	81.0	30.87	78.3	29.82	72.9	28.68
	-18.8	-19	94.4	33.96	89.0	32.74	83.6	31.63	81.0	30.49	78.3	29.45	72.9	28.30
	-16.7	-17	94.4	33.15	89.0	31.92	83.6	30.82	81.0	29.70	78.3	28.69	72.9	27.53
	-13.7	-15	94.4	32.02	89.0	30.75	83.6	29.68	81.0	28.56	78.3	27.59	72.9	26.40
	-11.8	-13	94.4	31.30	89.0	29.99	83.6	28.96	81.0	27.84	78.3	26.91	72.9	25.71
	-9.8	-11	94.4	30.54	89.0	29.20	83.6	28.20	81.0	27.07	78.3	26.17	72.9	24.96
	-9.5	-10	94.4	30.43	89.0	29.09	83.6	28.08	81.0	26.96	78.3	26.06	72.9	24.85
	-8.5	-9.1	94.4	30.04	89.0	28.69	83.6	27.70	81.0	26.59	78.3	25.71	72.9	24.48
	-7.0	-7.6	94.4	29.47	89.0	28.11	83.6	27.12	81.0	26.01	78.3	25.15	72.9	23.92
	-5.0	-5.6	94.4	28.72	89.0	27.33	83.6	26.36	81.0	25.25	78.3	24.42	72.9	23.17
	-3.0	-3.7	94.4	27.95	89.0	26.54	83.6	25.60	81.0	24.48	78.3	23.70	72.9	22.43
	0.0	-0.7	94.4	26.82	89.0	25.36	83.6	24.46	81.0	23.35	78.3	22.61	72.9	21.31
	3.0	2.2	94.4	25.67	89.0	24.18	83.6	23.31	81.0	22.22	78.3	21.51	72.9	20.20
	5.0	4.1	94.4	24.91	89.0	23.40	83.6	22.55	81.0	21.46	78.3	20.78	72.9	19.44
	7.0	6	94.4	24.16	89.0	22.61	83.6	21.78	81.0	20.69	78.3	20.05	72.9	18.71
	9.0	7.9	94.4	21.81	89.0	20.42	83.6	19.68	81.0	18.69	78.3	18.11	72.9	16.89
11.0	9.8	94.4	20.41	89.0	19.11	83.6	18.40	81.0	17.49	78.3	16.94	72.9	15.81	
13.0	11.8	94.4	19.17	89.0	17.94	83.6	17.28	81.0	16.42	78.3	15.90	72.9	14.84	
15.0	13.7	94.4	18.13	89.0	16.98	83.6	16.35	81.0	15.53	78.3	15.05	72.9	14.04	

Note

1. TC: Total Capacity(kW), PI: Power Input(kW, Comp. + Outdoor fan motor)
2. Capacity tables show the average value of conditions which may occur.
3. In the range beyond the operation limit of the outdoor unit, continuous operation and performance can not be guaranteed. When selecting the outdoor units, avoid the air temperature range that is not guaranteed continuous operation.

7. Capacity Tables

◆ A(C)RUN620LLS5

Combination (%)	Outdoor air temp.		Heating Capacity (62HP)											
			Indoor air temp. °C DB											
	°C DB	°C WB	16		18		20		21		22		24	
		TC	PI	TC	PI	TC	PI	TC	PI	TC	PI	TC	PI	
130	-19.8	-20	100.5	41.88	100.5	43.49	99.8	44.90	99.8	47.06	99.8	49.12	99.8	52.36
	-18.8	-19	105.3	42.96	105.3	44.58	104.6	45.98	104.6	48.15	104.6	50.19	104.6	53.44
	-16.7	-17	115.6	45.23	115.6	46.85	114.8	48.25	114.8	50.42	114.8	52.46	114.8	55.70
	-13.7	-15	130.2	48.47	130.2	50.09	129.4	51.49	129.4	53.65	129.4	55.70	129.4	58.08
	-11.8	-13	137.5	50.52	137.5	52.14	136.6	53.55	136.6	55.70	136.6	58.08	136.6	61.46
	-9.8	-11	145.2	52.68	145.2	54.29	144.2	55.70	144.2	58.08	144.2	61.46	144.2	64.84
	-9.5	-10	148.7	53.00	148.7	54.62	147.7	55.70	147.7	59.45	145.3	61.46	145.3	64.84
	-8.5	-9.1	160.2	54.08	160.2	55.70	159.2	57.06	159.2	61.46	149.2	64.84	149.2	68.22
	-7.0	-7.6	177.7	55.70	177.7	58.08	176.5	60.45	176.5	64.84	176.5	71.46	176.5	74.84
	-5.0	-5.6	200.9	56.19	200.9	58.08	199.5	60.45	199.5	64.84	199.5	71.46	199.5	74.84
	-3.0	-3.7	224.1	56.68	224.1	58.08	222.6	60.45	222.6	64.84	210.5	71.46	210.5	74.84
	0.0	-0.7	224.4	57.42	224.4	58.08	223.7	60.45	223.7	64.84	210.5	71.46	210.5	74.84
	3.0	2.2	224.4	58.16	224.4	58.08	223.7	60.45	223.7	64.84	210.5	71.46	210.5	74.84
	5.0	4.1	224.4	58.65	224.4	58.08	223.7	60.45	223.7	64.84	210.5	71.46	210.5	74.84
	7.0	6	224.4	59.15	224.4	58.08	223.7	60.45	223.7	64.84	210.5	71.46	210.5	74.84
	9.0	7.9	224.4	59.71	224.4	58.08	223.7	60.45	223.7	64.84	210.5	71.46	210.5	74.84
	11.0	9.8	224.4	60.89	224.4	58.08	223.7	60.45	223.7	64.84	210.5	71.46	210.5	74.84
13.0	11.8	224.4	62.05	224.4	60.06	223.7	60.45	223.7	64.84	210.5	71.46	210.5	74.84	
15.0	13.7	224.4	63.21	224.4	61.17	223.7	60.45	223.7	64.84	210.5	71.46	210.5	74.84	
120	-19.8	-20	99.8	43.49	99.8	44.90	99.1	47.06	99.1	49.12	99.1	52.36	99.1	55.70
	-18.8	-19	104.6	44.58	104.6	45.98	103.9	48.15	103.9	50.19	103.9	53.44	103.9	56.78
	-16.7	-17	114.7	46.85	114.7	48.25	114.0	50.42	114.0	52.46	114.0	55.70	114.0	59.16
	-13.7	-15	129.3	50.09	129.3	51.49	128.5	53.65	128.5	55.70	128.5	59.16	128.5	62.54
	-11.8	-13	136.5	52.14	136.5	53.55	135.7	55.70	135.7	59.16	135.7	62.54	135.7	65.92
	-9.8	-11	144.2	54.29	144.2	55.70	143.2	58.08	143.2	62.54	143.2	65.92	143.2	69.30
	-9.5	-10	147.5	54.62	147.5	55.67	146.7	58.08	146.7	62.54	146.7	65.92	146.7	69.30
	-8.5	-9.1	159.1	55.70	159.1	56.68	158.1	59.45	158.1	64.84	153.5	65.92	153.5	69.30
	-7.0	-7.6	176.4	55.71	176.4	56.68	175.2	59.45	175.2	64.84	160.8	65.92	160.8	69.30
	-5.0	-5.6	199.4	55.72	199.4	55.29	198.2	58.08	198.2	64.84	198.2	65.92	198.2	69.30
	-3.0	-3.7	220.2	55.72	220.2	55.12	211.5	58.08	211.5	64.84	198.2	65.92	198.2	69.30
	0.0	-0.7	222.6	55.75	220.2	54.87	211.5	58.08	211.5	64.84	198.2	65.92	198.2	69.30
	3.0	2.2	222.6	55.75	220.2	54.61	211.5	58.08	211.5	64.84	198.2	65.92	198.2	69.30
	5.0	4.1	222.6	55.77	220.2	54.44	211.5	58.08	211.5	64.84	198.2	65.92	198.2	69.30
	7.0	6	222.6	55.78	220.2	54.27	211.5	58.08	211.5	64.84	198.2	65.92	198.2	69.30
	9.0	7.9	222.6	56.05	220.2	54.54	211.5	58.08	211.5	64.84	198.2	65.92	198.2	69.30
	11.0	9.8	222.6	56.88	220.2	55.33	211.5	58.08	211.5	64.84	198.2	65.92	198.2	69.30
13.0	11.8	222.6	57.69	220.2	56.12	211.5	58.08	211.5	64.84	198.2	65.92	198.2	69.30	
15.0	13.7	222.6	58.49	220.2	56.90	211.5	58.08	211.5	64.84	198.2	65.92	198.2	69.30	
110	-19.8	-20	99.2	44.90	99.2	47.06	98.6	49.12	98.6	52.36	98.6	55.70	98.6	59.16
	-18.8	-19	103.9	45.98	103.9	48.15	103.4	50.19	103.4	53.44	103.4	56.78	103.4	60.54
	-16.7	-17	114.2	48.25	114.2	50.42	113.4	52.46	113.4	55.70	113.4	59.16	113.4	62.92
	-13.7	-15	128.6	51.49	128.6	53.65	127.8	55.70	127.8	59.16	127.8	62.92	127.8	66.30
	-11.8	-13	135.8	53.55	135.8	55.70	134.9	58.08	134.9	62.92	134.9	66.30	134.9	69.68
	-9.8	-11	143.4	55.70	143.4	56.68	142.5	59.45	142.5	64.84	142.5	66.30	142.5	69.68
	-9.5	-10	146.8	55.63	146.8	56.61	145.8	59.45	145.8	64.84	145.8	66.30	145.8	69.68
	-8.5	-9.1	158.2	55.38	158.2	56.36	157.2	59.45	157.2	64.84	153.1	66.30	153.1	69.68
	-7.0	-7.6	175.5	55.01	175.5	56.00	174.3	59.45	174.3	64.84	160.4	66.30	160.4	69.68
	-5.0	-5.6	191.0	54.52	191.0	53.92	189.8	58.08	189.8	64.84	168.0	66.30	168.0	69.68
	-3.0	-3.7	202.2	54.03	202.2	53.40	189.8	58.08	189.8	64.84	177.4	66.30	177.4	69.68
	0.0	-0.7	213.9	53.29	202.2	52.62	189.8	58.08	189.8	64.84	177.4	66.30	177.4	69.68
	3.0	2.2	213.9	52.54	202.2	51.83	189.8	58.08	189.8	64.84	177.4	66.30	177.4	69.68
	5.0	4.1	213.9	52.04	202.2	51.30	189.8	58.08	189.8	64.84	177.4	66.30	177.4	69.68
	7.0	6	213.9	51.56	202.2	50.78	189.8	58.08	189.8	64.84	177.4	66.30	177.4	69.68
	9.0	7.9	213.9	51.11	202.2	50.24	189.8	58.08	189.8	64.84	177.4	66.30	177.4	69.68
	11.0	9.8	213.9	50.63	202.2	49.69	189.8	58.08	189.8	64.84	177.4	66.30	177.4	69.68
13.0	11.8	213.9	50.11	202.2	49.14	189.8	58.08	189.8	64.84	177.4	66.30	177.4	69.68	
15.0	13.7	213.9	49.54	202.2	48.58	189.8	58.08	189.8	64.84	177.4	66.30	177.4	69.68	

Note

1. TC: Total Capacity(kW), PI: Power Input(kW, Comp. + Outdoor fan motor)
2. Capacity tables show the average value of conditions which may occur.
3. In the range beyond the operation limit of the outdoor unit, continuous operation and performance can not be guaranteed. When selecting the outdoor units, avoid the air temperature range that is not guaranteed continuous operation.

7. Capacity Tables

Combination (%)		Heating Capacity (62HP)												
		Outdoor air temp.		Indoor air temp. °C DB										
		°C DB	°C WB	16		18		20		21		22		24
		TC	PI	TC	PI	TC	PI	TC	PI	TC	PI	TC	PI	
100	-19.8	-20	98.8	46.75	98.8	48.54	98.2	50.05	98.2	52.93	98.2	54.93	98.2	55.70
	-18.8	-19	103.6	47.64	102.9	49.43	102.9	51.14	102.9	53.82	102.9	55.70	102.9	55.19
	-16.7	-17	113.0	49.52	113.0	51.32	113.0	53.41	112.3	55.70	112.3	54.71	112.3	54.10
	-13.7	-15	128.0	52.21	128.0	54.00	127.3	55.70	127.3	54.40	127.3	53.29	127.3	52.54
	-11.8	-13	135.1	53.92	134.4	55.70	134.4	54.95	134.4	53.57	134.4	52.38	134.4	51.56
	-9.8	-11	142.6	55.70	142.6	54.92	141.8	54.15	141.8	52.72	141.8	51.44	141.8	50.52
	-9.5	-10	146.0	55.61	146.0	54.80	145.3	54.04	145.3	52.58	145.3	51.30	145.3	50.37
	-8.5	-9.1	157.3	55.25	157.3	54.41	156.6	53.64	168.0	52.16	162.4	50.81	151.4	49.85
	-7.0	-7.6	177.4	54.73	176.7	53.83	173.6	53.04	168.0	51.51	162.4	50.12	151.4	49.07
	-5.0	-5.6	185.1	54.05	183.3	53.04	173.6	52.25	168.0	50.63	162.4	49.17	151.4	48.03
	-3.0	-3.7	190.5	53.36	184.8	52.25	173.6	51.46	168.0	49.77	162.4	48.22	151.4	46.99
	0.0	-0.7	195.8	52.32	184.8	51.09	173.6	50.28	168.0	48.48	162.4	46.80	151.4	45.45
	3.0	2.2	195.8	51.28	184.8	49.91	173.6	49.08	168.0	47.18	162.4	45.37	151.4	43.89
	5.0	4.1	195.8	50.60	184.8	49.12	173.6	48.29	168.0	46.31	162.4	44.42	151.4	42.85
	7.0	6	195.8	49.91	184.8	48.34	173.6	47.50	168.0	45.44	162.4	43.47	151.4	41.82
	9.0	7.9	195.8	49.22	184.8	47.66	173.6	46.84	168.0	44.82	162.4	42.88	151.4	41.24
11.0	9.8	195.8	48.98	184.8	47.44	173.6	46.62	168.0	44.61	162.4	42.68	151.4	41.03	
13.0	11.8	195.8	48.70	184.8	47.17	173.6	46.34	168.0	44.35	162.4	42.43	151.4	40.80	
15.0	13.7	195.8	48.36	184.8	46.85	173.6	46.04	168.0	44.04	162.4	42.13	151.4	40.53	
90	-19.8	-20	98.4	44.04	98.4	47.29	97.7	49.54	97.7	50.63	97.7	49.91	97.7	48.65
	-18.8	-19	103.6	45.12	102.9	48.36	102.5	50.63	102.5	50.28	102.5	49.56	102.5	48.24
	-16.7	-17	113.0	47.39	113.0	50.63	112.5	50.01	112.5	49.59	112.5	48.80	112.5	47.41
	-13.7	-15	128.0	50.63	128.0	49.81	126.7	49.12	126.7	48.56	126.7	47.73	126.7	46.23
	-11.8	-13	135.1	50.17	134.4	49.30	133.8	48.56	133.8	47.92	133.8	47.05	133.8	45.48
	-9.8	-11	142.6	49.68	142.6	48.76	141.3	47.97	141.3	47.24	141.3	46.34	129.7	44.68
	-9.5	-10	146.0	49.61	146.0	48.68	144.7	47.89	144.7	47.14	144.7	46.23	132.8	44.56
	-8.5	-9.1	157.3	49.38	156.3	48.40	156.0	47.60	153.9	46.81	149.0	45.88	138.4	44.16
	-7.0	-7.6	177.4	49.01	168.8	48.01	158.8	47.15	153.9	46.30	149.0	45.32	138.4	43.57
	-5.0	-5.6	179.3	48.52	168.8	47.46	158.8	46.56	153.9	45.62	149.0	44.61	138.4	42.77
	-3.0	-3.7	179.3	48.03	168.8	46.92	158.8	45.97	153.9	44.94	149.0	43.90	138.4	41.98
	0.0	-0.7	179.3	47.31	168.8	46.10	158.8	45.09	153.9	43.92	149.0	42.82	138.4	40.79
	3.0	2.2	179.3	46.57	168.8	45.30	158.8	44.20	153.9	42.91	149.0	41.75	138.4	39.60
	5.0	4.1	179.3	46.09	168.8	44.74	158.8	43.60	153.9	42.22	149.0	41.03	138.4	38.82
	7.0	6	179.3	45.61	168.8	44.21	158.8	43.02	153.9	41.55	149.0	40.31	138.4	38.02
	9.0	7.9	179.3	44.98	168.8	43.60	158.8	42.43	153.9	40.98	149.0	39.76	138.4	37.49
11.0	9.8	179.3	44.36	168.8	42.99	158.8	41.85	153.9	40.41	149.0	39.21	138.4	36.97	
13.0	11.8	179.3	43.73	168.8	42.38	158.8	41.24	153.9	39.83	149.0	38.66	138.4	36.45	
15.0	13.7	179.3	43.10	168.8	41.77	158.8	40.66	153.9	39.27	149.0	38.10	138.4	35.93	
80	-19.8	-20	97.4	38.30	97.4	41.54	97.4	44.90	97.4	44.21	97.4	43.17	97.4	42.06
	-18.8	-19	102.0	39.39	102.0	44.90	102.0	44.58	102.0	43.86	102.0	42.82	102.0	41.70
	-16.7	-17	112.5	44.90	112.5	44.31	112.5	43.94	112.5	43.16	112.5	42.11	112.5	40.94
	-13.7	-15	132.6	44.13	129.9	43.47	126.7	43.01	126.7	42.13	126.7	41.07	123.6	39.86
	-11.8	-13	143.3	43.65	139.2	42.96	133.8	42.43	133.8	41.50	132.8	40.41	123.6	39.17
	-9.8	-11	147.7	43.14	143.4	42.40	141.3	41.80	137.9	40.81	132.8	39.72	123.6	38.46
	-9.5	-10	148.8	43.06	144.5	42.30	142.1	41.71	137.9	40.71	132.8	39.62	123.6	38.35
	-8.5	-9.1	154.4	42.80	151.4	42.03	142.1	41.40	137.9	40.36	132.8	39.27	123.6	37.98
	-7.0	-7.6	160.6	42.43	151.4	41.61	142.1	40.94	137.9	39.85	132.8	38.76	123.6	37.44
	-5.0	-5.6	160.6	41.91	151.4	41.06	142.1	40.31	137.9	39.17	132.8	38.07	123.6	36.72
	-3.0	-3.7	160.6	41.40	151.4	40.50	142.1	39.69	137.9	38.48	132.8	37.38	123.6	36.01
	0.0	-0.7	160.6	40.63	151.4	39.67	142.1	38.77	137.9	37.47	132.8	36.34	123.6	34.92
	3.0	2.2	160.6	39.87	151.4	38.83	142.1	37.84	137.9	36.44	132.8	35.31	123.6	33.83
	5.0	4.1	160.6	39.36	151.4	38.27	142.1	37.23	137.9	35.76	132.8	34.62	123.6	33.11
	7.0	6	160.6	38.85	151.4	37.72	142.1	36.60	137.9	35.08	132.8	33.93	123.6	32.40
	9.0	7.9	160.6	36.48	151.4	35.41	142.1	34.36	137.9	32.94	132.8	31.86	123.6	30.42
11.0	9.8	160.6	33.86	151.4	32.88	142.1	31.90	137.9	30.57	132.8	29.56	123.6	28.23	
13.0	11.8	160.6	31.60	151.4	30.68	142.1	29.77	137.9	28.54	132.8	27.60	123.6	26.35	
15.0	13.7	160.6	29.75	151.4	28.88	142.1	28.03	137.9	26.86	132.8	25.98	123.6	24.81	

Note

1. TC: Total Capacity(kW), PI: Power Input(kW, Comp. + Outdoor fan motor)
2. Capacity tables show the average value of conditions which may occur.
3. In the range beyond the operation limit of the outdoor unit, continuous operation and performance can not be guaranteed. When selecting the outdoor units, avoid the air temperature range that is not guaranteed continuous operation.

7. Capacity Tables

Combination (%)	Outdoor air temp.		Heating Capacity (62HP)											
			Indoor air temp. °C DB											
	°C DB	°C WB	16		18		20		21		22		24	
		TC	PI	TC	PI	TC	PI	TC	PI	TC	PI	TC	PI	
70	-19.8	-20	97.4	40.58	97.4	41.66	97.4	40.95	97.4	39.81	97.4	38.74	97.4	37.56
	-18.8	-19	102.0	41.66	102.0	41.32	102.0	40.59	102.0	39.45	102.0	38.38	102.0	37.17
	-16.7	-17	112.5	41.02	112.5	40.60	112.5	39.83	112.5	38.67	112.5	37.63	105.7	36.38
	-13.7	-15	136.2	40.11	128.6	39.57	120.9	38.77	116.8	37.58	113.3	36.54	105.7	35.22
	-11.8	-13	136.2	39.53	128.6	38.91	120.9	38.09	116.8	36.87	113.3	35.85	105.7	34.50
	-9.8	-11	136.2	38.93	128.6	38.22	120.9	37.37	116.8	36.14	113.3	35.13	105.7	33.73
	-9.5	-10	136.2	38.83	128.6	38.12	120.9	37.26	116.8	36.03	113.3	35.02	105.7	33.62
	-8.5	-9.1	136.2	38.53	128.6	37.79	120.9	36.91	116.8	35.66	113.3	34.66	105.7	33.25
	-7.0	-7.6	136.2	38.08	128.6	37.26	120.9	36.38	116.8	35.11	113.3	34.12	105.7	32.67
	-5.0	-5.6	136.2	37.47	128.6	36.58	120.9	35.66	116.8	34.37	113.3	33.39	105.7	31.90
	-3.0	-3.7	136.2	36.86	128.6	35.90	120.9	34.95	116.8	33.64	113.3	32.67	105.7	31.14
	0.0	-0.7	136.2	35.96	128.6	34.87	120.9	33.88	116.8	32.53	113.3	31.58	105.7	29.99
	3.0	2.2	136.2	35.03	128.6	33.83	120.9	32.81	116.8	31.43	113.3	30.49	105.7	28.85
	5.0	4.1	136.2	34.44	128.6	33.15	120.9	32.09	116.8	30.70	113.3	29.78	105.7	28.08
	7.0	6	136.2	33.83	128.6	32.47	120.9	31.38	116.8	29.96	113.3	29.06	105.7	27.31
	9.0	7.9	136.2	30.54	128.6	29.32	120.9	28.34	116.8	27.06	113.3	26.24	105.7	24.68
	11.0	9.8	136.2	28.44	128.6	27.30	120.9	26.38	116.8	25.19	113.3	24.43	105.7	22.97
13.0	11.8	136.2	26.61	128.6	25.53	120.9	24.68	116.8	23.57	113.3	22.85	105.7	21.49	
15.0	13.7	136.2	25.09	128.6	24.07	120.9	23.27	116.8	22.22	113.3	21.55	105.7	20.25	
60	-19.8	-20	116.8	38.41	110.6	37.70	97.4	36.58	97.4	35.49	96.8	34.42	90.5	33.23
	-18.8	-19	116.8	38.09	110.6	37.35	102.0	36.22	100.2	35.13	96.8	34.06	90.5	32.85
	-16.7	-17	116.8	37.45	110.6	36.58	103.7	35.46	100.2	34.37	96.8	33.29	90.5	32.04
	-13.7	-15	116.8	36.50	110.6	35.52	103.7	34.37	100.2	33.28	96.8	32.20	90.5	30.89
	-11.8	-13	116.8	35.91	110.6	34.83	103.7	33.66	100.2	32.60	96.8	31.51	90.5	30.17
	-9.8	-11	116.8	35.28	110.6	34.13	103.7	32.93	100.2	31.87	96.8	30.79	90.5	29.40
	-9.5	-10	116.8	35.18	110.6	34.01	103.7	32.83	100.2	31.75	96.8	30.68	90.5	29.28
	-8.5	-9.1	116.8	34.87	110.6	33.65	103.7	32.46	100.2	31.40	96.8	30.32	90.5	28.90
	-7.0	-7.6	116.8	34.40	110.6	33.12	103.7	31.91	100.2	30.84	96.8	29.78	90.5	28.33
	-5.0	-5.6	116.8	33.77	110.6	32.40	103.7	31.19	100.2	30.12	96.8	29.06	90.5	27.57
	-3.0	-3.7	116.8	33.14	110.6	31.69	103.7	30.44	100.2	29.38	96.8	28.33	90.5	26.81
	0.0	-0.7	116.8	32.20	110.6	30.61	103.7	29.35	100.2	28.29	96.8	27.24	90.5	25.65
	3.0	2.2	116.8	31.26	110.6	29.54	103.7	28.26	100.2	27.20	96.8	26.16	90.5	24.49
	5.0	4.1	116.8	30.63	110.6	28.82	103.7	27.52	100.2	26.48	96.8	25.42	90.5	23.73
	7.0	6	116.8	30.01	110.6	28.10	103.7	26.79	100.2	25.74	96.8	24.70	90.5	22.97
	9.0	7.9	116.8	26.78	110.6	25.07	103.7	23.91	100.2	22.98	96.8	22.04	90.5	20.50
	11.0	9.8	116.8	25.00	110.6	23.42	103.7	22.32	100.2	21.46	96.8	20.58	90.5	19.14
13.0	11.8	116.8	23.43	110.6	21.94	103.7	20.92	100.2	20.09	96.8	19.28	90.5	17.93	
15.0	13.7	116.8	22.13	110.6	20.73	103.7	19.77	100.2	19.00	96.8	18.22	90.5	16.95	
50	-19.8	-20	97.5	34.41	92.0	33.21	86.3	32.08	83.7	30.94	80.9	29.88	75.4	28.75
	-18.8	-19	97.5	34.04	92.0	32.81	86.3	31.70	83.7	30.56	80.9	29.52	75.4	28.37
	-16.7	-17	97.5	33.23	92.0	31.99	86.3	30.89	83.7	29.77	80.9	28.75	75.4	27.59
	-13.7	-15	97.5	32.09	92.0	30.81	86.3	29.75	83.7	28.62	80.9	27.65	75.4	26.46
	-11.8	-13	97.5	31.36	92.0	30.05	86.3	29.02	83.7	27.90	80.9	26.97	75.4	25.76
	-9.8	-11	97.5	30.61	92.0	29.27	86.3	28.26	83.7	27.13	80.9	26.23	75.4	25.01
	-9.5	-10	97.5	30.50	92.0	29.15	86.3	28.14	83.7	27.02	80.9	26.12	75.4	24.90
	-8.5	-9.1	97.5	30.10	92.0	28.76	86.3	27.76	83.7	26.65	80.9	25.76	75.4	24.53
	-7.0	-7.6	97.5	29.54	92.0	28.17	86.3	27.18	83.7	26.07	80.9	25.21	75.4	23.97
	-5.0	-5.6	97.5	28.78	92.0	27.39	86.3	26.41	83.7	25.30	80.9	24.47	75.4	23.22
	-3.0	-3.7	97.5	28.01	92.0	26.60	86.3	25.66	83.7	24.54	80.9	23.75	75.4	22.48
	0.0	-0.7	97.5	26.87	92.0	25.42	86.3	24.51	83.7	23.40	80.9	22.65	75.4	21.36
	3.0	2.2	97.5	25.72	92.0	24.23	86.3	23.36	83.7	22.27	80.9	21.55	75.4	20.25
	5.0	4.1	97.5	24.97	92.0	23.45	86.3	22.59	83.7	21.50	80.9	20.83	75.4	19.49
	7.0	6	97.5	24.21	92.0	22.66	86.3	21.83	83.7	20.73	80.9	20.09	75.4	18.74
	9.0	7.9	97.5	21.86	92.0	20.46	86.3	19.72	83.7	18.73	80.9	18.15	75.4	16.93
	11.0	9.8	97.5	20.46	92.0	19.15	86.3	18.44	83.7	17.52	80.9	16.98	75.4	15.84
13.0	11.8	97.5	19.21	92.0	17.98	86.3	17.32	83.7	16.45	80.9	15.94	75.4	14.88	
15.0	13.7	97.5	18.17	92.0	17.01	86.3	16.39	83.7	15.57	80.9	15.08	75.4	14.07	

Note

1. TC: Total Capacity(kW), PI: Power Input(kW, Comp. + Outdoor fan motor)
2. Capacity tables show the average value of conditions which may occur.
3. In the range beyond the operation limit of the outdoor unit, continuous operation and performance can not be guaranteed. When selecting the outdoor units, avoid the air temperature range that is not guaranteed continuous operation.

7. Capacity Tables

◆ A(C)RUN640LLS5

Combination (%)	Outdoor air temp.		Heating Capacity (64HP)											
			Indoor air temp. °C DB											
	°C DB	°C WB	16		18		20		21		22		24	
		TC	PI	TC	PI	TC	PI	TC	PI	TC	PI	TC	PI	
130	-19.8	-20	103.8	44.19	103.8	45.88	103.1	47.37	103.1	49.64	103.1	51.81	103.1	55.23
	-18.8	-19	108.8	45.32	108.8	47.03	108.0	48.51	108.0	50.79	108.0	52.94	108.0	56.36
	-16.7	-17	119.4	47.71	119.4	49.42	118.6	50.89	118.6	53.18	118.6	55.33	118.6	58.75
	-13.7	-15	134.4	51.13	134.4	52.84	133.6	54.31	133.6	56.58	133.6	58.75	133.6	58.09
	-11.8	-13	142.0	53.28	142.0	54.99	141.0	56.48	141.0	58.75	141.0	58.43	141.0	57.67
	-9.8	-11	149.9	55.57	149.9	57.26	148.9	58.75	148.9	58.55	148.9	58.09	148.9	57.23
	-9.5	-10	153.6	55.91	153.6	57.60	152.6	58.75	152.6	58.53	150.1	58.04	150.1	57.18
	-8.5	-9.1	165.4	57.04	165.4	58.75	164.4	58.75	164.4	58.43	154.1	57.87	154.1	56.96
	-7.0	-7.6	183.4	58.75	183.4	58.90	182.2	58.72	182.2	58.28	182.2	57.60	167.0	56.62
	-5.0	-5.6	207.3	59.26	207.3	59.12	205.8	58.70	205.8	58.09	205.8	57.26	177.0	56.18
	-3.0	-3.7	231.2	59.78	231.2	59.33	229.7	58.70	225.2	57.89	217.3	56.92	187.1	55.75
	0.0	-0.7	231.6	60.56	231.6	59.63	230.9	58.68	225.2	57.60	217.3	56.41	201.9	55.09
	3.0	2.2	231.6	61.34	231.6	59.95	230.9	58.65	225.2	57.31	217.3	55.89	202.3	54.45
	5.0	4.1	231.6	61.86	231.6	60.17	230.9	58.63	225.2	57.11	217.3	55.55	202.3	54.01
	7.0	6	231.6	62.39	231.6	60.37	230.9	58.63	225.2	56.92	217.3	55.21	202.3	53.57
	9.0	7.9	231.6	62.98	231.6	60.95	230.9	59.19	225.2	57.46	217.3	55.75	202.3	54.08
	11.0	9.8	231.6	64.23	231.6	62.15	230.9	60.34	225.2	58.58	217.3	56.85	202.3	55.14
	13.0	11.8	231.6	65.45	231.6	63.35	230.9	61.49	225.2	59.71	217.3	57.92	202.3	56.19
15.0	13.7	231.6	66.67	231.6	64.52	230.9	62.66	225.2	60.83	217.3	59.02	202.3	57.26	
120	-19.8	-20	103.1	45.88	103.1	47.37	102.4	49.64	102.4	51.81	102.4	55.23	102.4	57.60
	-18.8	-19	108.0	47.03	108.0	48.51	107.3	50.79	107.3	52.94	107.3	56.36	107.3	58.75
	-16.7	-17	118.4	49.42	118.4	50.89	117.7	53.18	117.7	55.33	117.7	58.75	117.7	58.33
	-13.7	-15	133.4	52.84	133.4	54.31	132.7	56.58	132.7	58.75	132.7	58.21	132.7	57.72
	-11.8	-13	141.0	54.99	141.0	56.48	140.1	58.75	140.1	58.41	140.1	57.87	140.1	57.33
	-9.8	-11	148.9	57.26	148.9	58.75	147.9	58.48	147.9	58.04	147.9	57.53	147.9	56.94
	-9.5	-10	152.3	57.60	152.3	58.72	151.6	58.43	151.6	57.99	151.6	57.46	151.6	56.87
	-8.5	-9.1	164.2	58.75	164.2	58.63	163.2	58.28	163.2	57.82	158.3	57.28	158.3	56.67
	-7.0	-7.6	182.1	58.75	182.1	58.50	180.9	58.07	180.9	57.55	165.9	57.01	165.9	56.38
	-5.0	-5.6	205.8	58.77	205.8	58.31	204.6	57.80	204.6	57.19	204.6	56.67	175.8	55.96
	-3.0	-3.7	227.4	58.77	227.4	58.14	218.3	57.51	211.2	56.82	204.6	56.31	185.7	55.57
	0.0	-0.7	229.7	58.80	227.4	57.87	218.3	57.09	211.2	56.28	204.6	55.77	190.0	54.96
	3.0	2.2	229.7	58.80	227.4	57.60	218.3	56.67	211.2	55.75	204.6	55.23	190.0	54.35
	5.0	4.1	229.7	58.82	227.4	57.41	218.3	56.38	211.2	55.40	204.6	54.87	190.0	53.94
	7.0	6	229.7	58.83	227.4	57.24	218.3	56.11	211.2	55.04	204.6	54.52	190.0	53.55
	9.0	7.9	229.7	59.12	227.4	57.53	218.3	56.38	211.2	55.31	204.6	54.79	190.0	53.81
	11.0	9.8	229.7	60.00	227.4	58.36	218.3	57.21	211.2	56.11	204.6	55.60	190.0	54.60
	13.0	11.8	229.7	60.85	227.4	59.19	218.3	58.04	211.2	56.92	204.6	56.38	190.0	55.38
15.0	13.7	229.7	61.69	227.4	60.02	218.3	58.85	211.2	57.70	204.6	57.16	190.0	56.14	
110	-19.8	-20	102.4	47.37	102.4	49.64	101.9	51.81	101.9	55.23	101.9	57.60	101.9	58.75
	-18.8	-19	107.3	48.51	107.3	50.79	106.8	52.94	106.8	56.36	106.8	58.75	106.8	58.43
	-16.7	-17	117.9	50.89	117.9	53.18	117.1	55.33	117.1	58.75	117.1	58.16	117.1	57.75
	-13.7	-15	132.7	54.31	132.7	56.58	131.9	58.75	131.9	57.94	131.9	57.35	131.9	56.77
	-11.8	-13	140.3	56.48	140.3	58.75	139.3	58.21	139.3	57.43	139.3	56.82	139.3	56.16
	-9.8	-11	148.1	58.75	148.1	58.19	147.2	57.65	147.2	56.87	147.2	56.28	147.2	55.50
	-9.5	-10	151.6	58.67	151.6	58.11	150.6	57.58	150.6	56.79	150.6	56.18	150.6	55.40
	-8.5	-9.1	163.4	58.41	163.4	57.84	162.4	57.28	162.4	56.52	158.2	55.91	158.2	55.08
	-7.0	-7.6	181.2	58.02	181.2	57.43	179.9	56.87	179.9	56.11	165.8	55.50	165.8	54.59
	-5.0	-5.6	197.2	57.50	197.2	56.87	195.9	56.31	189.5	55.57	173.7	54.94	171.1	53.94
	-3.0	-3.7	208.7	56.99	208.7	56.33	195.9	55.75	189.5	55.03	183.1	54.40	171.1	53.30
	0.0	-0.7	220.8	56.21	208.7	55.50	195.9	54.91	189.5	54.21	183.1	53.57	171.1	52.32
	3.0	2.2	220.8	55.42	208.7	54.67	195.9	54.08	189.5	53.40	183.1	52.74	171.1	51.35
	5.0	4.1	220.8	54.89	208.7	54.11	195.9	53.52	189.5	52.86	183.1	52.20	171.1	50.69
	7.0	6	220.8	54.38	208.7	53.55	195.9	52.96	189.5	52.32	183.1	51.64	171.1	50.05
	9.0	7.9	220.8	54.33	208.7	53.52	195.9	52.91	189.5	52.28	183.1	51.61	171.1	50.00
	11.0	9.8	220.8	54.82	208.7	53.99	195.9	53.40	189.5	52.74	183.1	52.06	171.1	50.47
	13.0	11.8	220.8	55.28	208.7	54.45	195.9	53.84	189.5	53.18	183.1	52.50	171.1	50.88
15.0	13.7	220.8	55.72	208.7	54.89	195.9	54.26	189.5	53.60	183.1	52.91	171.1	51.28	

Note

1. TC: Total Capacity(kW), PI : Power Input(kW, Comp. + Outdoor fan motor)
2. Capacity tables show the average value of conditions which may occur.
3. In the range beyond the operation limit of the outdoor unit, continuous operation and performance can not be guaranteed. When selecting the outdoor units, avoid the air temperature range that is not guaranteed continuous operation.

7. Capacity Tables

Combination (%)		Heating Capacity (64HP)												
		Outdoor air temp.		Indoor air temp. °C DB										
		°C DB	°C WB	16		18		20		21		22		24
		TC	PI	TC	PI	TC	PI	TC	PI	TC	PI	TC	PI	
100	-19.8	-20	102.1	49.32	102.1	51.20	101.4	52.79	101.4	55.82	101.4	57.94	101.4	58.75
	-18.8	-19	107.0	50.25	106.3	52.13	106.3	53.94	106.3	56.77	106.3	58.75	106.3	58.21
	-16.7	-17	116.7	52.23	116.7	54.13	116.7	56.33	115.9	58.75	115.9	57.70	115.9	57.06
	-13.7	-15	132.2	55.06	132.2	56.96	131.4	58.75	131.4	57.38	131.4	56.21	131.4	55.42
	-11.8	-13	139.5	56.87	138.8	58.75	138.8	57.96	138.8	56.50	138.8	55.25	138.8	54.38
	-9.8	-11	147.2	58.75	147.2	57.92	146.4	57.11	146.4	55.60	146.4	54.25	146.4	53.28
	-9.5	-10	150.8	58.65	150.8	57.80	150.1	56.99	150.1	55.45	150.1	54.11	150.1	53.13
	-8.5	-9.1	162.4	58.28	162.4	57.38	161.7	56.57	173.5	55.01	167.6	53.59	156.3	52.57
	-7.0	-7.6	183.1	57.72	182.4	56.77	179.2	55.94	173.5	54.33	167.6	52.86	156.3	51.76
	-5.0	-5.6	191.0	57.01	189.3	55.94	179.2	55.11	173.5	53.40	167.6	51.86	156.3	50.66
	-3.0	-3.7	196.7	56.28	190.8	55.11	179.2	54.28	173.5	52.49	167.6	50.86	156.3	49.56
	0.0	-0.7	202.1	55.18	190.8	53.89	179.2	53.03	173.5	51.13	167.6	49.36	156.3	47.93
	3.0	2.2	202.1	54.08	190.8	52.64	179.2	51.76	173.5	49.76	167.6	47.85	156.3	46.29
	5.0	4.1	202.1	53.37	190.8	51.81	179.2	50.93	173.5	48.85	167.6	46.85	156.3	45.19
	7.0	6	202.1	52.64	190.8	50.98	179.2	50.10	173.5	47.93	167.6	45.85	156.3	44.11
	9.0	7.9	202.1	51.91	190.8	50.27	179.2	49.41	173.5	47.27	167.6	45.23	156.3	43.50
	11.0	9.8	202.1	51.66	190.8	50.03	179.2	49.17	173.5	47.05	167.6	45.02	156.3	43.28
13.0	11.8	202.1	51.37	190.8	49.76	179.2	48.88	173.5	46.78	167.6	44.75	156.3	43.04	
15.0	13.7	202.1	51.01	190.8	49.42	179.2	48.56	173.5	46.46	167.6	44.43	156.3	42.75	
90	-19.8	-20	101.6	46.46	101.6	49.88	100.9	52.25	100.9	53.40	100.9	52.64	100.9	51.32
	-18.8	-19	107.0	47.59	106.3	51.01	105.8	53.40	105.8	53.03	105.8	52.27	105.8	50.88
	-16.7	-17	116.7	49.98	116.7	53.40	116.2	52.74	116.2	52.30	116.2	51.47	116.2	50.00
	-13.7	-15	132.2	53.40	132.2	52.54	130.7	51.81	130.7	51.22	130.7	50.34	130.7	48.76
	-11.8	-13	139.5	52.91	138.8	52.00	138.1	51.22	138.1	50.54	138.1	49.63	138.1	47.97
	-9.8	-11	147.2	52.40	147.2	51.42	145.9	50.59	145.9	49.83	145.9	48.88	139.9	47.12
	-9.5	-10	150.8	52.32	150.8	51.34	149.4	50.51	149.4	49.71	149.4	48.76	137.1	47.00
	-8.5	-9.1	162.4	52.08	161.4	51.05	161.0	50.20	158.8	49.37	153.8	48.39	142.8	46.58
	-7.0	-7.6	183.1	51.69	174.3	50.64	163.9	49.73	158.8	48.83	153.8	47.80	142.8	45.95
	-5.0	-5.6	185.1	51.17	174.3	50.05	163.9	49.10	158.8	48.12	153.8	47.05	142.8	45.11
	-3.0	-3.7	185.1	50.66	174.3	49.49	163.9	48.49	158.8	47.39	153.8	46.31	142.8	44.28
	0.0	-0.7	185.1	49.90	174.3	48.63	163.9	47.56	158.8	46.33	153.8	45.16	142.8	43.03
	3.0	2.2	185.1	49.12	174.3	47.78	163.9	46.61	158.8	45.26	153.8	44.04	142.8	41.77
	5.0	4.1	185.1	48.61	174.3	47.19	163.9	45.99	158.8	44.53	153.8	43.28	142.8	40.94
	7.0	6	185.1	48.10	174.3	46.63	163.9	45.38	158.8	43.82	153.8	42.52	142.8	40.10
	9.0	7.9	185.1	47.44	174.3	45.99	163.9	44.75	158.8	43.23	153.8	41.94	142.8	39.54
	11.0	9.8	185.1	46.78	174.3	45.34	163.9	44.14	158.8	42.62	153.8	41.35	142.8	39.00
13.0	11.8	185.1	46.12	174.3	44.70	163.9	43.50	158.8	42.01	153.8	40.77	142.8	38.44	
15.0	13.7	185.1	45.46	174.3	44.06	163.9	42.89	158.8	41.42	153.8	40.18	142.8	37.90	
80	-19.8	-20	100.6	40.40	100.6	43.82	100.6	47.36	100.6	46.63	100.6	45.53	100.6	44.36
	-18.8	-19	105.3	41.55	105.3	47.36	105.3	47.02	105.3	46.26	105.3	45.16	105.3	43.99
	-16.7	-17	116.2	47.36	116.2	46.73	116.2	46.34	116.2	45.53	116.2	44.41	116.2	43.18
	-13.7	-15	136.9	46.55	134.1	45.85	130.7	45.36	130.7	44.43	130.7	43.31	127.5	42.04
	-11.8	-13	147.9	46.04	143.7	45.31	138.1	44.75	138.1	43.77	137.1	42.62	127.5	41.32
	-9.8	-11	152.6	45.50	148.1	44.72	145.9	44.09	142.3	43.04	137.1	41.89	127.5	40.57
	-9.5	-10	153.6	45.41	149.2	44.62	146.7	43.99	142.3	42.94	137.1	41.79	127.5	40.45
	-8.5	-9.1	159.3	45.14	156.3	44.33	146.7	43.67	142.3	42.57	137.1	41.42	127.5	40.06
	-7.0	-7.6	165.7	44.75	156.3	43.89	146.7	43.18	142.3	42.03	137.1	40.88	127.5	39.49
	-5.0	-5.6	165.7	44.21	156.3	43.31	146.7	42.52	142.3	41.32	137.1	40.15	127.5	38.73
	-3.0	-3.7	165.7	43.67	156.3	42.72	146.7	41.86	142.3	40.59	137.1	39.42	127.5	37.98
	0.0	-0.7	165.7	42.86	156.3	41.84	146.7	40.89	142.3	39.52	137.1	38.32	127.5	36.83
	3.0	2.2	165.7	42.06	156.3	40.96	146.7	39.91	142.3	38.44	137.1	37.24	127.5	35.68
	5.0	4.1	165.7	41.52	156.3	40.37	146.7	39.27	142.3	37.71	137.1	36.51	127.5	34.92
	7.0	6	165.7	40.98	156.3	39.79	146.7	38.61	142.3	37.00	137.1	35.78	127.5	34.17
	9.0	7.9	165.7	38.47	156.3	37.34	146.7	36.24	142.3	34.75	137.1	33.60	127.5	32.09
	11.0	9.8	165.7	35.71	156.3	34.68	146.7	33.65	142.3	32.24	137.1	31.18	127.5	29.77
13.0	11.8	165.7	33.33	156.3	32.36	146.7	31.40	142.3	30.11	137.1	29.11	127.5	27.79	
15.0	13.7	165.7	31.38	156.3	30.47	146.7	29.57	142.3	28.33	137.1	27.40	127.5	26.17	

Note

1. TC: Total Capacity(kW), PI: Power Input(kW, Comp. + Outdoor fan motor)
2. Capacity tables show the average value of conditions which may occur.
3. In the range beyond the operation limit of the outdoor unit, continuous operation and performance can not be guaranteed. When selecting the outdoor units, avoid the air temperature range that is not guaranteed continuous operation.

7. Capacity Tables

Combination (%)	Outdoor air temp. °C		Heating Capacity (64HP)											
			Indoor air temp. °C DB											
	DB	WB	16		18		20		21		22		24	
		TC	PI	TC	PI	TC	PI	TC	PI	TC	PI	TC	PI	
70	-19.8	-20	100.6	42.80	100.6	43.94	100.6	43.19	100.6	41.99	100.6	40.86	100.6	39.62
	-18.8	-19	105.3	43.94	105.3	43.58	105.3	42.82	105.3	41.62	105.3	40.49	105.3	39.20
	-16.7	-17	116.2	43.26	116.2	42.82	116.2	42.01	116.2	40.79	116.2	39.69	109.1	38.37
	-13.7	-15	140.6	42.31	132.7	41.74	124.8	40.89	120.6	39.64	116.9	38.54	109.1	37.15
	-11.8	-13	140.6	41.69	132.7	41.04	124.8	40.18	120.6	38.89	116.9	37.81	109.1	36.39
	-9.8	-11	140.6	41.06	132.7	40.32	124.8	39.42	120.6	38.12	116.9	37.05	109.1	35.58
	-9.5	-10	140.6	40.96	132.7	40.20	124.8	39.30	120.6	38.00	116.9	36.93	109.1	35.46
	-8.5	-9.1	140.6	40.64	132.7	39.86	124.8	38.93	120.6	37.61	116.9	36.56	109.1	35.07
	-7.0	-7.6	140.6	40.16	132.7	39.30	124.8	38.37	120.6	37.03	116.9	35.98	109.1	34.46
	-5.0	-5.6	140.6	39.52	132.7	38.59	124.8	37.61	120.6	36.25	116.9	35.22	109.1	33.65
	-3.0	-3.7	140.6	38.88	132.7	37.86	124.8	36.86	120.6	35.48	116.9	34.46	109.1	32.85
	0.0	-0.7	140.6	37.93	132.7	36.78	124.8	35.73	120.6	34.31	116.9	33.31	109.1	31.63
	3.0	2.2	140.6	36.95	132.7	35.68	124.8	34.61	120.6	33.16	116.9	32.16	109.1	30.43
	5.0	4.1	140.6	36.32	132.7	34.97	124.8	33.85	120.6	32.38	116.9	31.41	109.1	29.62
	7.0	6	140.6	35.68	132.7	34.24	124.8	33.09	120.6	31.60	116.9	30.65	109.1	28.81
	9.0	7.9	140.6	32.21	132.7	30.92	124.8	29.89	120.6	28.54	116.9	27.67	109.1	26.03
11.0	9.8	140.6	29.99	132.7	28.79	124.8	27.83	120.6	26.57	116.9	25.76	109.1	24.22	
13.0	11.8	140.6	28.06	132.7	26.93	124.8	26.03	120.6	24.86	116.9	24.10	109.1	22.66	
15.0	13.7	140.6	26.47	132.7	25.39	124.8	24.54	120.6	23.44	116.9	22.73	109.1	21.36	
60	-19.8	-20	120.6	40.52	114.2	39.77	100.6	38.59	100.6	37.44	99.9	36.30	93.5	35.05
	-18.8	-19	120.6	40.18	114.2	39.40	105.3	38.20	103.4	37.05	99.9	35.93	93.5	34.66
	-16.7	-17	120.6	39.50	114.2	38.59	107.1	37.40	103.4	36.25	99.9	35.12	93.5	33.80
	-13.7	-15	120.6	38.50	114.2	37.47	107.1	36.25	103.4	35.10	99.9	33.97	93.5	32.58
	-11.8	-13	120.6	37.88	114.2	36.74	107.1	35.51	103.4	34.39	99.9	33.24	93.5	31.82
	-9.8	-11	120.6	37.22	114.2	36.00	107.1	34.73	103.4	33.61	99.9	32.48	93.5	31.01
	-9.5	-10	120.6	37.10	114.2	35.88	107.1	34.63	103.4	33.49	99.9	32.36	93.5	30.89
	-8.5	-9.1	120.6	36.78	114.2	35.49	107.1	34.24	103.4	33.12	99.9	31.99	93.5	30.48
	-7.0	-7.6	120.6	36.29	114.2	34.93	107.1	33.66	103.4	32.53	99.9	31.41	93.5	29.89
	-5.0	-5.6	120.6	35.63	114.2	34.17	107.1	32.90	103.4	31.77	99.9	30.65	93.5	29.08
	-3.0	-3.7	120.6	34.95	114.2	33.43	107.1	32.11	103.4	30.99	99.9	29.89	93.5	28.28
	0.0	-0.7	120.6	33.97	114.2	32.29	107.1	30.96	103.4	29.84	99.9	28.74	93.5	27.05
	3.0	2.2	120.6	32.97	114.2	31.16	107.1	29.81	103.4	28.69	99.9	27.59	93.5	25.83
	5.0	4.1	120.6	32.31	114.2	30.40	107.1	29.03	103.4	27.93	99.9	26.81	93.5	25.03
	7.0	6	120.6	31.65	114.2	29.64	107.1	28.25	103.4	27.15	99.9	26.05	93.5	24.22
	9.0	7.9	120.6	28.25	114.2	26.44	107.1	25.22	103.4	24.24	99.9	23.24	93.5	21.63
11.0	9.8	120.6	26.37	114.2	24.71	107.1	23.54	103.4	22.63	99.9	21.70	93.5	20.19	
13.0	11.8	120.6	24.71	114.2	23.14	107.1	22.07	103.4	21.19	99.9	20.33	93.5	18.91	
15.0	13.7	120.6	23.34	114.2	21.87	107.1	20.85	103.4	20.04	99.9	19.21	93.5	17.87	
50	-19.8	-20	100.7	36.30	95.0	35.03	89.1	33.85	86.4	32.63	83.5	31.53	77.8	30.33
	-18.8	-19	100.7	35.91	95.0	34.61	89.1	33.44	86.4	32.24	83.5	31.14	77.8	29.92
	-16.7	-17	100.7	35.05	95.0	33.75	89.1	32.58	86.4	31.41	83.5	30.33	77.8	29.11
	-13.7	-15	100.7	33.85	95.0	32.51	89.1	31.38	86.4	30.19	83.5	29.16	77.8	27.91
	-11.8	-13	100.7	33.09	95.0	31.70	89.1	30.62	86.4	29.43	83.5	28.45	77.8	27.18
	-9.8	-11	100.7	32.29	95.0	30.87	89.1	29.82	86.4	28.62	83.5	27.67	77.8	26.39
	-9.5	-10	100.7	32.17	95.0	30.75	89.1	29.69	86.4	28.50	83.5	27.55	77.8	26.27
	-8.5	-9.1	100.7	31.75	95.0	30.33	89.1	29.28	86.4	28.11	83.5	27.18	77.8	25.88
	-7.0	-7.6	100.7	31.16	95.0	29.72	89.1	28.67	86.4	27.50	83.5	26.59	77.8	25.29
	-5.0	-5.6	100.7	30.36	95.0	28.89	89.1	27.86	86.4	26.69	83.5	25.81	77.8	24.49
	-3.0	-3.7	100.7	29.55	95.0	28.06	89.1	27.06	86.4	25.88	83.5	25.05	77.8	23.71
	0.0	-0.7	100.7	28.35	95.0	26.81	89.1	25.86	86.4	24.68	83.5	23.90	77.8	22.53
	3.0	2.2	100.7	27.13	95.0	25.56	89.1	24.64	86.4	23.49	83.5	22.73	77.8	21.36
	5.0	4.1	100.7	26.34	95.0	24.73	89.1	23.83	86.4	22.68	83.5	21.97	77.8	20.55
	7.0	6	100.7	25.54	95.0	23.90	89.1	23.02	86.4	21.87	83.5	21.19	77.8	19.77
	9.0	7.9	100.7	23.05	95.0	21.58	89.1	20.80	86.4	19.75	83.5	19.14	77.8	17.86
11.0	9.8	100.7	21.58	95.0	20.19	89.1	19.45	86.4	18.48	83.5	17.91	77.8	16.71	
13.0	11.8	100.7	20.26	95.0	18.96	89.1	18.26	86.4	17.35	83.5	16.81	77.8	15.69	
15.0	13.7	100.7	19.16	95.0	17.94	89.1	17.28	86.4	16.42	83.5	15.91	77.8	14.84	

Note

1. TC: Total Capacity(kW), PI: Power Input(kW, Comp. + Outdoor fan motor)
2. Capacity tables show the average value of conditions which may occur.
3. In the range beyond the operation limit of the outdoor unit, continuous operation and performance can not be guaranteed. When selecting the outdoor units, avoid the air temperature range that is not guaranteed continuous operation.

7. Capacity Tables

◆ A(C)RUN660LLS5

Combination (%)	Outdoor air temp.		Heating Capacity (66HP)											
			Indoor air temp. °C DB											
	°C DB	°C WB	16		18		20		21		22		24	
		TC	PI	TC	PI	TC	PI	TC	PI	TC	PI	TC	PI	
130	-19.8	-20	107.1	46.38	107.1	48.16	106.4	49.72	106.4	52.11	106.4	54.39	106.4	57.98
	-18.8	-19	112.2	47.57	112.2	49.36	111.5	50.93	111.5	53.31	111.5	55.58	111.5	59.17
	-16.7	-17	123.1	50.08	123.1	51.88	122.4	53.42	122.4	55.83	122.4	58.09	122.4	61.68
	-13.7	-15	138.6	53.67	138.6	55.47	137.8	57.01	137.8	59.40	137.8	61.68	137.8	60.99
	-11.8	-13	146.5	55.93	146.5	57.73	145.5	59.29	145.5	61.68	145.5	61.35	145.5	60.55
	-9.8	-11	154.7	58.34	154.7	60.12	153.6	61.68	153.6	61.48	153.6	60.99	153.6	60.09
	-9.5	-10	158.4	58.70	158.4	60.48	157.4	61.68	157.4	61.45	154.9	60.94	154.9	60.04
	-8.5	-9.1	170.6	59.89	170.6	61.68	169.6	61.68	169.6	61.35	159.0	60.76	159.0	59.81
	-7.0	-7.6	189.1	61.68	189.1	61.84	187.9	61.66	187.9	61.19	187.9	60.48	172.1	59.45
	-5.0	-5.6	213.7	62.22	213.7	62.07	212.2	61.63	212.2	60.99	212.2	60.12	182.5	58.99
	-3.0	-3.7	238.3	62.76	238.3	62.30	236.8	61.63	232.3	60.78	224.1	59.76	192.8	58.53
	0.0	-0.7	238.9	63.58	238.9	62.61	238.1	61.60	232.3	60.48	224.1	59.22	208.1	57.84
	3.0	2.2	238.9	64.40	238.9	62.94	238.1	61.58	232.3	60.17	224.1	58.68	208.7	57.16
	5.0	4.1	238.9	64.94	238.9	63.17	238.1	61.56	232.3	59.96	224.1	58.32	208.7	56.70
	7.0	6	238.9	65.50	238.9	63.38	238.1	61.55	232.3	59.76	224.1	57.97	208.7	56.24
	9.0	7.9	238.9	66.12	238.9	63.99	238.1	62.14	232.3	60.33	224.1	58.53	208.7	56.78
	11.0	9.8	238.9	67.43	238.9	65.25	238.1	63.35	232.3	61.51	224.1	59.68	208.7	57.89
13.0	11.8	238.9	68.71	238.9	66.51	238.1	64.56	232.3	62.68	224.1	60.81	208.7	58.99	
15.0	13.7	238.9	70.00	238.9	67.74	238.1	65.79	232.3	63.86	224.1	61.97	208.7	60.12	
120	-19.8	-20	106.4	48.16	106.4	49.72	105.6	52.11	105.6	54.39	105.6	57.98	105.6	60.48
	-18.8	-19	111.5	49.36	111.5	50.93	110.7	53.31	110.7	55.58	110.7	59.17	110.7	61.68
	-16.7	-17	122.1	51.88	122.1	53.42	121.4	55.83	121.4	58.09	121.4	61.68	121.4	61.24
	-13.7	-15	137.6	55.47	137.6	57.01	136.8	59.40	136.8	61.68	136.8	61.12	136.8	60.60
	-11.8	-13	145.5	57.73	145.5	59.29	144.5	61.68	144.5	61.32	144.5	60.76	144.5	60.20
	-9.8	-11	153.6	60.12	153.6	61.68	152.6	61.40	152.6	60.94	152.6	60.40	152.6	59.78
	-9.5	-10	157.2	60.48	157.2	61.66	156.4	61.35	156.4	60.89	156.4	60.32	156.4	59.71
	-8.5	-9.1	169.4	61.68	169.4	61.55	168.3	61.19	168.3	60.71	163.2	60.14	163.2	59.50
	-7.0	-7.6	187.8	61.68	187.8	61.42	186.6	60.97	186.6	60.42	171.0	59.86	171.0	59.19
	-5.0	-5.6	212.2	61.71	212.2	61.22	210.9	60.68	210.9	60.04	210.9	59.50	181.2	58.76
	-3.0	-3.7	234.5	61.71	234.5	61.04	225.2	60.38	217.8	59.66	210.9	59.12	191.3	58.34
	0.0	-0.7	236.9	61.73	234.5	60.76	225.2	59.94	217.8	59.09	210.9	58.55	196.0	57.70
	3.0	2.2	236.9	61.74	234.5	60.48	225.2	59.50	217.8	58.53	210.9	57.99	196.0	57.06
	5.0	4.1	236.9	61.76	234.5	60.27	225.2	59.20	217.8	58.17	210.9	57.61	196.0	56.63
	7.0	6	236.9	61.76	234.5	60.09	225.2	58.91	217.8	57.78	210.9	57.24	196.0	56.22
	9.0	7.9	236.9	62.07	234.5	60.40	225.2	59.20	217.8	58.07	210.9	57.53	196.0	56.50
	11.0	9.8	236.9	62.99	234.5	61.27	225.2	60.07	217.8	58.91	210.9	58.37	196.0	57.32
13.0	11.8	236.9	63.89	234.5	62.15	225.2	60.94	217.8	59.76	210.9	59.20	196.0	58.14	
15.0	13.7	236.9	64.76	234.5	63.02	225.2	61.78	217.8	60.58	210.9	60.02	196.0	58.94	
110	-19.8	-20	105.6	49.72	105.6	52.11	105.1	54.39	105.1	57.98	105.1	60.48	105.1	61.68
	-18.8	-19	110.7	50.93	110.7	53.31	110.2	55.58	110.2	59.17	110.2	61.68	110.2	61.35
	-16.7	-17	121.6	53.42	121.6	55.83	120.8	58.09	120.8	61.68	120.8	61.07	120.8	60.63
	-13.7	-15	136.8	57.01	136.8	59.40	136.0	61.68	136.0	60.83	136.0	60.22	136.0	59.60
	-11.8	-13	144.7	59.29	144.7	61.68	143.7	61.12	143.7	60.29	143.7	59.66	143.7	58.96
	-9.8	-11	152.8	61.68	152.8	61.09	151.8	60.53	151.8	59.71	151.8	59.09	151.8	58.27
	-9.5	-10	156.4	61.60	156.4	61.01	155.4	60.45	155.4	59.63	155.4	58.99	155.4	58.17
	-8.5	-9.1	168.6	61.32	168.6	60.73	167.5	60.15	167.5	59.35	163.3	58.71	163.3	57.83
	-7.0	-7.6	186.8	60.91	186.8	60.30	185.6	59.71	185.6	58.91	171.2	58.27	171.2	57.32
	-5.0	-5.6	203.3	60.37	203.3	59.71	202.1	59.12	195.5	58.35	179.4	57.68	176.4	56.63
	-3.0	-3.7	215.3	59.83	215.3	59.14	202.1	58.53	195.5	57.78	188.9	57.11	176.4	55.96
	0.0	-0.7	227.7	59.01	215.3	58.27	202.1	57.65	195.5	56.91	188.9	56.24	176.4	54.93
	3.0	2.2	227.7	58.19	215.3	57.40	202.1	56.78	195.5	56.06	188.9	55.37	176.4	53.91
	5.0	4.1	227.7	57.63	215.3	56.81	202.1	56.19	195.5	55.50	188.9	54.80	176.4	53.22
	7.0	6	227.7	57.09	215.3	56.22	202.1	55.60	195.5	54.93	188.9	54.22	176.4	52.55
	9.0	7.9	227.7	57.04	215.3	56.19	202.1	55.55	195.5	54.88	188.9	54.19	176.4	52.50
	11.0	9.8	227.7	57.55	215.3	56.68	202.1	56.06	195.5	55.37	188.9	54.66	176.4	52.98
13.0	11.8	227.7	58.04	215.3	57.17	202.1	56.53	195.5	55.83	188.9	55.12	176.4	53.42	
15.0	13.7	227.7	58.50	215.3	57.63	202.1	56.97	195.5	56.27	188.9	55.55	176.4	53.83	

Note

1. TC: Total Capacity(kW), PI: Power Input(kW, Comp. + Outdoor fan motor)
2. Capacity tables show the average value of conditions which may occur.
3. In the range beyond the operation limit of the outdoor unit, continuous operation and performance can not be guaranteed. When selecting the outdoor units, avoid the air temperature range that is not guaranteed continuous operation.

7. Capacity Tables

Combination (%)		Heating Capacity (66HP)												
		Outdoor air temp.		Indoor air temp. °C DB										
		°C DB	°C WB	16		18		20		21		22		24
		TC	PI	TC	PI	TC	PI	TC	PI	TC	PI	TC	PI	
100	-19.8	-20	105.4	51.78	105.4	53.75	104.6	55.42	104.6	58.60	104.6	60.83	104.6	61.68
	-18.8	-19	110.4	52.75	109.7	54.73	109.7	56.63	109.7	59.60	109.7	61.68	109.7	61.12
	-16.7	-17	120.3	54.83	120.3	56.83	120.3	59.14	119.6	61.68	119.6	60.58	119.6	59.91
	-13.7	-15	136.3	57.81	136.3	59.81	135.5	61.68	135.5	60.24	135.5	59.01	135.5	58.19
	-11.8	-13	143.9	59.70	143.2	61.68	143.2	60.86	143.2	59.32	143.2	58.01	143.2	57.09
	-9.8	-11	151.9	61.68	151.9	60.81	151.1	59.96	151.1	58.37	151.1	56.96	151.1	55.94
	-9.5	-10	155.6	61.58	155.6	60.68	154.9	59.84	154.9	58.22	154.9	56.81	154.9	55.78
	-8.5	-9.1	167.6	61.19	167.6	60.25	166.8	59.40	178.9	57.76	172.9	56.27	161.2	55.19
	-7.0	-7.6	188.9	60.61	188.1	59.60	184.8	58.73	178.9	57.04	172.9	55.50	161.2	54.34
	-5.0	-5.6	197.0	59.86	195.2	58.73	184.8	57.86	178.9	56.07	172.9	54.45	161.2	53.19
	-3.0	-3.7	202.8	59.09	196.7	57.86	184.8	56.99	178.9	55.11	172.9	53.39	161.2	52.04
	0.0	-0.7	208.4	57.94	196.7	56.57	184.8	55.68	178.9	53.68	172.9	51.83	161.2	50.32
	3.0	2.2	208.4	56.78	196.7	55.27	184.8	54.35	178.9	52.24	172.9	50.24	161.2	48.60
	5.0	4.1	208.4	56.04	196.7	54.40	184.8	53.47	178.9	51.29	172.9	49.19	161.2	47.44
	7.0	6	208.4	55.27	196.7	53.53	184.8	52.60	178.9	50.32	172.9	48.14	161.2	46.31
	9.0	7.9	208.4	54.50	196.7	52.78	184.8	51.88	178.9	49.62	172.9	47.49	161.2	45.67
11.0	9.8	208.4	54.24	196.7	52.53	184.8	51.63	178.9	49.39	172.9	47.26	161.2	45.44	
13.0	11.8	208.4	53.93	196.7	52.24	184.8	51.32	178.9	49.11	172.9	46.98	161.2	45.19	
15.0	13.7	208.4	53.55	196.7	51.88	184.8	50.98	178.9	48.78	172.9	46.65	161.2	44.88	
90	-19.8	-20	104.9	48.77	104.9	52.37	104.1	54.86	104.1	56.06	104.1	55.27	104.1	53.88
	-18.8	-19	110.4	49.96	109.7	53.55	109.2	56.06	109.2	55.68	109.2	54.88	109.2	53.42
	-16.7	-17	120.3	52.47	120.3	56.06	119.8	55.37	119.8	54.91	119.8	54.04	119.8	52.50
	-13.7	-15	136.3	56.06	136.3	55.17	134.8	54.40	134.8	53.78	134.8	52.86	134.8	51.19
	-11.8	-13	143.9	55.55	143.2	54.60	142.4	53.78	142.4	53.06	142.4	52.11	142.4	50.36
	-9.8	-11	151.9	55.01	151.9	53.99	150.6	53.12	150.6	52.32	150.6	51.31	138.1	49.47
	-9.5	-10	155.6	54.94	155.6	53.91	154.1	53.03	154.1	52.19	154.1	51.19	141.4	49.34
	-8.5	-9.1	167.6	54.68	166.5	53.60	166.1	52.70	163.8	51.83	158.6	50.80	147.2	48.91
	-7.0	-7.6	188.9	54.27	179.7	53.16	169.1	52.21	163.8	51.27	158.6	50.19	147.2	48.24
	-5.0	-5.6	190.9	53.73	179.7	52.55	169.1	51.55	163.8	50.52	158.6	49.39	147.2	47.37
	-3.0	-3.7	190.9	53.19	179.7	51.96	169.1	50.91	163.8	49.75	158.6	48.62	147.2	46.49
	0.0	-0.7	190.9	52.39	179.7	51.06	169.1	49.93	163.8	48.65	158.6	47.42	147.2	45.18
	3.0	2.2	190.9	51.58	179.7	50.16	169.1	48.93	163.8	47.52	158.6	46.24	147.2	43.85
	5.0	4.1	190.9	51.04	179.7	49.55	169.1	48.29	163.8	46.75	158.6	45.44	147.2	42.98
	7.0	6	190.9	50.50	179.7	48.96	169.1	47.65	163.8	46.01	158.6	44.65	147.2	42.10
	9.0	7.9	190.9	49.81	179.7	48.29	169.1	46.98	163.8	45.39	158.6	44.03	147.2	41.52
11.0	9.8	190.9	49.11	179.7	47.60	169.1	46.34	163.8	44.75	158.6	43.42	147.2	40.95	
13.0	11.8	190.9	48.42	179.7	46.93	169.1	45.67	163.8	44.11	158.6	42.80	147.2	40.36	
15.0	13.7	190.9	47.73	179.7	46.26	169.1	45.03	163.8	43.49	158.6	42.19	147.2	39.79	
80	-19.8	-20	103.8	42.41	103.8	46.00	103.8	49.72	103.8	48.96	103.8	47.80	103.8	46.57
	-18.8	-19	108.7	43.62	108.7	49.72	108.7	49.37	108.7	48.57	108.7	47.42	108.7	46.18
	-16.7	-17	119.8	49.72	119.8	49.06	119.8	48.65	119.8	47.80	119.8	46.62	119.8	45.34
	-13.7	-15	141.1	48.88	138.3	48.14	134.8	47.62	134.8	46.65	134.8	45.47	131.5	44.13
	-11.8	-13	152.6	48.34	148.3	47.57	142.4	46.98	142.4	45.95	141.4	44.75	131.5	43.39
	-9.8	-11	157.4	47.77	152.9	46.95	150.6	46.29	146.7	45.19	141.4	43.98	131.5	42.59
	-9.5	-10	158.4	47.67	153.8	46.85	151.3	46.19	146.7	45.08	141.4	43.88	131.5	42.46
	-8.5	-9.1	164.3	47.39	161.2	46.54	151.3	45.85	146.7	44.70	141.4	43.49	131.5	42.06
	-7.0	-7.6	170.9	46.98	161.2	46.08	151.3	45.34	146.7	44.13	141.4	42.92	131.5	41.46
	-5.0	-5.6	170.9	46.41	161.2	45.47	151.3	44.65	146.7	43.39	141.4	42.16	131.5	40.67
	-3.0	-3.7	170.9	45.85	161.2	44.85	151.3	43.95	146.7	42.62	141.4	41.39	131.5	39.87
	0.0	-0.7	170.9	45.00	161.2	43.93	151.3	42.93	146.7	41.49	141.4	40.24	131.5	38.67
	3.0	2.2	170.9	44.16	161.2	43.00	151.3	41.90	146.7	40.36	141.4	39.10	131.5	37.46
	5.0	4.1	170.9	43.59	161.2	42.39	151.3	41.23	146.7	39.59	141.4	38.33	131.5	36.67
	7.0	6	170.9	43.03	161.2	41.77	151.3	40.54	146.7	38.85	141.4	37.57	131.5	35.87
	9.0	7.9	170.9	40.39	161.2	39.21	151.3	38.05	146.7	36.48	141.4	35.28	131.5	33.69
11.0	9.8	170.9	37.49	161.2	36.41	151.3	35.33	146.7	33.85	141.4	32.74	131.5	31.25	
13.0	11.8	170.9	35.00	161.2	33.97	151.3	32.97	146.7	31.61	141.4	30.56	131.5	29.18	
15.0	13.7	170.9	32.94	161.2	31.99	151.3	31.05	146.7	29.74	141.4	28.77	131.5	27.48	

Note

1. TC: Total Capacity(kW), PI: Power Input(kW, Comp. + Outdoor fan motor)
2. Capacity tables show the average value of conditions which may occur.
3. In the range beyond the operation limit of the outdoor unit, continuous operation and performance can not be guaranteed. When selecting the outdoor units, avoid the air temperature range that is not guaranteed continuous operation.

7. Capacity Tables

Combination (%)		Heating Capacity (66HP)												
		Outdoor air temp.		Indoor air temp. °C DB										
		°C DB	°C WB	16		18		20		21		22		24
		TC	PI	TC	PI	TC	PI	TC	PI	TC	PI	TC	PI	
70	-19.8	-20	103.8	44.93	103.8	46.13	103.8	45.34	103.8	44.08	103.8	42.90	103.8	41.59
	-18.8	-19	108.7	46.13	108.7	45.75	108.7	44.95	108.7	43.69	108.7	42.51	108.7	41.16
	-16.7	-17	119.8	45.42	119.8	44.95	119.8	44.11	119.8	42.82	119.8	41.67	112.5	40.28
	-13.7	-15	144.9	44.41	136.8	43.82	128.7	42.93	124.4	41.61	120.6	40.46	112.5	39.00
	-11.8	-13	144.9	43.77	136.8	43.08	128.7	42.18	124.4	40.82	120.6	39.69	112.5	38.20
	-9.8	-11	144.9	43.10	136.8	42.33	128.7	41.39	124.4	40.02	120.6	38.90	112.5	37.36
	-9.5	-10	144.9	43.00	136.8	42.21	128.7	41.26	124.4	39.90	120.6	38.77	112.5	37.23
	-8.5	-9.1	144.9	42.67	136.8	41.85	128.7	40.87	124.4	39.49	120.6	38.38	112.5	36.82
	-7.0	-7.6	144.9	42.16	136.8	41.26	128.7	40.28	124.4	38.87	120.6	37.77	112.5	36.18
	-5.0	-5.6	144.9	41.49	136.8	40.51	128.7	39.49	124.4	38.05	120.6	36.97	112.5	35.33
	-3.0	-3.7	144.9	40.82	136.8	39.75	128.7	38.69	124.4	37.25	120.6	36.18	112.5	34.48
	0.0	-0.7	144.9	39.82	136.8	38.61	128.7	37.51	124.4	36.03	120.6	34.97	112.5	33.20
	3.0	2.2	144.9	38.80	136.8	37.46	128.7	36.33	124.4	34.82	120.6	33.77	112.5	31.94
	5.0	4.1	144.9	38.13	136.8	36.72	128.7	35.54	124.4	34.00	120.6	32.97	112.5	31.10
	7.0	6	144.9	37.46	136.8	35.95	128.7	34.74	124.4	33.18	120.6	32.18	112.5	30.25
	9.0	7.9	144.9	33.82	136.8	32.46	128.7	31.38	124.4	29.97	120.6	29.05	112.5	27.32
11.0	9.8	144.9	31.49	136.8	30.23	128.7	29.22	124.4	27.89	120.6	27.05	112.5	25.43	
13.0	11.8	144.9	29.46	136.8	28.28	128.7	27.33	124.4	26.10	120.6	25.30	112.5	23.79	
15.0	13.7	144.9	27.79	136.8	26.66	128.7	25.76	124.4	24.61	120.6	23.86	112.5	22.43	
60	-19.8	-20	124.4	42.54	117.8	41.74	103.8	40.51	103.8	39.31	103.1	38.10	96.4	36.79
	-18.8	-19	124.4	42.18	117.8	41.36	108.7	40.10	106.6	38.90	103.1	37.71	96.4	36.38
	-16.7	-17	124.4	41.46	117.8	40.51	110.4	39.26	106.6	38.05	103.1	36.87	96.4	35.48
	-13.7	-15	124.4	40.41	117.8	39.33	110.4	38.05	106.6	36.85	103.1	35.66	96.4	34.20
	-11.8	-13	124.4	39.77	117.8	38.57	110.4	37.28	106.6	36.10	103.1	34.90	96.4	33.41
	-9.8	-11	124.4	39.07	117.8	37.79	110.4	36.46	106.6	35.28	103.1	34.10	96.4	32.56
	-9.5	-10	124.4	38.95	117.8	37.67	110.4	36.36	106.6	35.15	103.1	33.97	96.4	32.43
	-8.5	-9.1	124.4	38.61	117.8	37.26	110.4	35.95	106.6	34.77	103.1	33.58	96.4	32.00
	-7.0	-7.6	124.4	38.10	117.8	36.67	110.4	35.33	106.6	34.15	103.1	32.97	96.4	31.38
	-5.0	-5.6	124.4	37.41	117.8	35.87	110.4	34.53	106.6	33.35	103.1	32.17	96.4	30.53
	-3.0	-3.7	124.4	36.69	117.8	35.10	110.4	33.72	106.6	32.54	103.1	31.38	96.4	29.68
	0.0	-0.7	124.4	35.66	117.8	33.90	110.4	32.51	106.6	31.33	103.1	30.17	96.4	28.40
	3.0	2.2	124.4	34.61	117.8	32.71	110.4	31.30	106.6	30.12	103.1	28.97	96.4	27.12
	5.0	4.1	124.4	33.92	117.8	31.92	110.4	30.48	106.6	29.33	103.1	28.15	96.4	26.28
	7.0	6	124.4	33.23	117.8	31.12	110.4	29.66	106.6	28.51	103.1	27.35	96.4	25.43
	9.0	7.9	124.4	29.66	117.8	27.76	110.4	26.48	106.6	25.45	103.1	24.40	96.4	22.71
11.0	9.8	124.4	27.69	117.8	25.94	110.4	24.71	106.6	23.76	103.1	22.79	96.4	21.19	
13.0	11.8	124.4	25.94	117.8	24.30	110.4	23.17	106.6	22.25	103.1	21.35	96.4	19.86	
15.0	13.7	124.4	24.51	117.8	22.96	110.4	21.89	106.6	21.04	103.1	20.17	96.4	18.76	
50	-19.8	-20	103.8	38.10	98.0	36.77	91.9	35.53	89.1	34.25	86.1	33.10	80.2	31.84
	-18.8	-19	103.8	37.69	98.0	36.33	91.9	35.10	89.1	33.84	86.1	32.69	80.2	31.41
	-16.7	-17	103.8	36.79	98.0	35.43	91.9	34.20	89.1	32.97	86.1	31.84	80.2	30.56
	-13.7	-15	103.8	35.53	98.0	34.12	91.9	32.94	89.1	31.69	86.1	30.61	80.2	29.30
	-11.8	-13	103.8	34.74	98.0	33.28	91.9	32.15	89.1	30.89	86.1	29.86	80.2	28.53
	-9.8	-11	103.8	33.89	98.0	32.41	91.9	31.30	89.1	30.05	86.1	29.04	80.2	27.71
	-9.5	-10	103.8	33.76	98.0	32.28	91.9	31.17	89.1	29.92	86.1	28.92	80.2	27.58
	-8.5	-9.1	103.8	33.33	98.0	31.84	91.9	30.74	89.1	29.50	86.1	28.53	80.2	27.17
	-7.0	-7.6	103.8	32.71	98.0	31.20	91.9	30.10	89.1	28.87	86.1	27.91	80.2	26.55
	-5.0	-5.6	103.8	31.87	98.0	30.33	91.9	29.25	89.1	28.02	86.1	27.10	80.2	25.71
	-3.0	-3.7	103.8	31.02	98.0	29.45	91.9	28.40	89.1	27.17	86.1	26.30	80.2	24.89
	0.0	-0.7	103.8	29.76	98.0	28.15	91.9	27.14	89.1	25.91	86.1	25.09	80.2	23.66
	3.0	2.2	103.8	28.48	98.0	26.84	91.9	25.86	89.1	24.66	86.1	23.86	80.2	22.42
	5.0	4.1	103.8	27.66	98.0	25.97	91.9	25.02	89.1	23.81	86.1	23.07	80.2	21.58
	7.0	6	103.8	26.81	98.0	25.09	91.9	24.17	89.1	22.96	86.1	22.25	80.2	20.76
	9.0	7.9	103.8	24.20	98.0	22.66	91.9	21.83	89.1	20.73	86.1	20.09	80.2	18.75
11.0	9.8	103.8	22.65	98.0	21.20	91.9	20.42	89.1	19.40	86.1	18.81	80.2	17.55	
13.0	11.8	103.8	21.27	98.0	19.91	91.9	19.17	89.1	18.22	86.1	17.65	80.2	16.47	
15.0	13.7	103.8	20.12	98.0	18.83	91.9	18.14	89.1	17.24	86.1	16.70	80.2	15.58	

Note

1. TC: Total Capacity(kW), PI: Power Input(kW, Comp. + Outdoor fan motor)
2. Capacity tables show the average value of conditions which may occur.
3. In the range beyond the operation limit of the outdoor unit, continuous operation and performance can not be guaranteed. When selecting the outdoor units, avoid the air temperature range that is not guaranteed continuous operation.

7. Capacity Tables

◆ A(C)RUN680LLS5

Combination (%)	Outdoor air temp.		Heating Capacity (68HP)											
			Indoor air temp. °C DB											
	°C DB	°C WB	16		18		20		21		22		24	
		TC	PI	TC	PI	TC	PI	TC	PI	TC	PI	TC	PI	
130	-19.8	-20	110.3	46.81	110.3	48.61	109.6	50.19	109.6	52.60	109.6	54.90	109.6	58.53
	-18.8	-19	115.6	48.01	115.6	49.82	114.8	51.40	114.8	53.82	114.8	56.10	114.8	59.73
	-16.7	-17	126.8	50.55	126.8	52.36	126.1	53.92	126.1	56.35	126.1	58.64	126.1	62.27
	-13.7	-15	142.8	54.18	142.8	55.99	142.0	57.55	142.0	59.96	142.0	62.27	142.0	61.57
	-11.8	-13	150.9	56.46	150.9	58.28	149.9	59.86	149.9	62.27	149.9	61.93	149.9	61.13
	-9.8	-11	159.3	58.89	159.3	60.69	158.3	62.27	158.3	62.06	158.3	61.57	158.3	60.66
	-9.5	-10	163.2	59.26	163.2	61.05	162.2	62.27	162.2	62.03	159.6	61.51	159.6	60.61
	-8.5	-9.1	175.8	60.45	175.8	62.27	174.7	62.26	174.7	61.93	163.8	61.33	163.8	60.37
	-7.0	-7.6	194.8	62.27	194.8	62.43	193.6	62.24	193.6	61.77	193.6	61.05	177.4	60.02
	-5.0	-5.6	220.2	62.81	220.2	62.66	218.7	62.22	218.7	61.57	218.7	60.69	188.1	59.55
	-3.0	-3.7	245.5	63.36	245.5	62.89	243.9	62.21	239.3	61.36	230.9	60.33	198.8	59.08
	0.0	-0.7	246.1	64.19	246.1	63.20	245.3	62.19	239.3	61.05	230.9	59.78	214.6	58.39
	3.0	2.2	246.1	65.02	246.1	63.54	245.3	62.16	239.3	60.74	230.9	59.24	215.0	57.71
	5.0	4.1	246.1	65.56	246.1	63.77	245.3	62.14	239.3	60.53	230.9	58.88	215.0	57.24
	7.0	6	246.1	66.13	246.1	63.98	245.3	62.14	239.3	60.32	230.9	58.52	215.0	56.78
	9.0	7.9	246.1	66.75	246.1	64.60	245.3	62.73	239.3	60.90	230.9	59.09	215.0	57.32
	11.0	9.8	246.1	68.07	246.1	65.87	245.3	63.95	239.3	62.09	230.9	60.25	215.0	58.44
13.0	11.8	246.1	69.37	246.1	67.14	245.3	65.17	239.3	63.28	230.9	61.39	215.0	59.55	
15.0	13.7	246.1	70.66	246.1	68.39	245.3	66.41	239.3	64.47	230.9	62.56	215.0	60.69	
120	-19.8	-20	109.6	48.61	109.6	50.19	108.8	52.60	108.8	54.90	108.8	58.53	108.8	61.05
	-18.8	-19	114.8	49.82	114.8	51.40	114.0	53.82	114.0	56.10	114.0	59.73	114.0	62.27
	-16.7	-17	125.8	52.36	125.8	53.92	125.0	56.35	125.0	58.64	125.0	62.27	125.0	61.82
	-13.7	-15	141.8	55.99	141.8	57.55	141.0	59.96	141.0	62.27	141.0	61.70	141.0	61.18
	-11.8	-13	149.9	58.28	149.9	59.86	148.9	62.27	148.9	61.90	148.9	61.34	148.9	60.77
	-9.8	-11	158.3	60.69	158.3	62.27	157.2	61.98	157.2	61.52	157.2	60.97	157.2	60.35
	-9.5	-10	161.9	61.05	161.9	62.24	161.1	61.93	161.1	61.47	161.1	60.90	161.1	60.27
	-8.5	-9.1	174.5	62.27	174.5	62.14	173.4	61.78	173.4	61.28	168.3	60.71	168.3	60.07
	-7.0	-7.6	193.5	62.27	193.5	62.01	192.2	61.54	192.2	61.00	176.3	60.43	176.3	59.75
	-5.0	-5.6	218.6	62.29	218.6	61.80	217.3	61.26	217.3	60.61	217.3	60.06	186.8	59.32
	-3.0	-3.7	241.6	62.29	241.6	61.62	232.0	60.95	224.4	60.22	217.3	59.68	197.3	58.90
	0.0	-0.7	244.0	62.32	241.6	61.34	232.0	60.51	224.4	59.66	217.3	59.11	201.9	58.25
	3.0	2.2	244.0	62.32	241.6	61.05	232.0	60.07	224.4	59.09	217.3	58.54	201.9	57.61
	5.0	4.1	244.0	62.35	241.6	60.85	232.0	59.76	224.4	58.72	217.3	58.15	201.9	57.17
	7.0	6	244.0	62.35	241.6	60.66	232.0	59.47	224.4	58.33	217.3	57.79	201.9	56.75
	9.0	7.9	244.0	62.66	241.6	60.97	232.0	59.76	224.4	58.62	217.3	58.07	201.9	57.04
	11.0	9.8	244.0	63.59	241.6	61.86	232.0	60.64	224.4	59.48	217.3	58.93	201.9	57.87
13.0	11.8	244.0	64.50	241.6	62.74	232.0	61.52	224.4	60.33	217.3	59.76	201.9	58.70	
15.0	13.7	244.0	65.38	241.6	63.62	232.0	62.37	224.4	61.16	217.3	60.59	201.9	59.50	
110	-19.8	-20	108.8	50.19	108.8	52.60	108.3	54.90	108.3	58.53	108.3	61.05	108.3	62.27
	-18.8	-19	114.1	51.40	114.1	53.82	113.5	56.10	113.5	59.73	113.5	62.27	113.5	61.93
	-16.7	-17	125.3	53.92	125.3	56.35	124.5	58.64	124.5	62.27	124.5	61.65	124.5	61.20
	-13.7	-15	141.0	57.55	141.0	59.96	140.2	62.27	140.2	61.41	140.2	60.79	140.2	60.17
	-11.8	-13	149.1	59.86	149.1	62.27	148.1	61.70	148.1	60.87	148.1	60.22	148.1	59.52
	-9.8	-11	157.5	62.27	157.5	61.67	156.4	61.10	156.4	60.27	156.4	59.65	156.4	58.82
	-9.5	-10	161.1	62.19	161.1	61.59	160.1	61.02	160.1	60.20	160.1	59.55	160.1	58.72
	-8.5	-9.1	173.7	61.91	173.7	61.31	172.6	60.72	172.6	59.91	168.2	59.26	168.2	58.38
	-7.0	-7.6	192.5	61.49	192.5	60.87	191.2	60.27	191.2	59.47	176.3	58.82	176.3	57.86
	-5.0	-5.6	209.5	60.95	209.5	60.27	208.2	59.68	201.4	58.90	184.7	58.23	181.8	57.17
	-3.0	-3.7	221.8	60.40	221.8	59.70	208.2	59.08	201.4	58.33	194.6	57.66	181.8	56.49
	0.0	-0.7	234.6	59.57	221.8	58.82	208.2	58.20	201.4	57.45	194.6	56.78	181.8	55.46
	3.0	2.2	234.6	58.74	221.8	57.94	208.2	57.32	201.4	56.60	194.6	55.90	181.8	54.42
	5.0	4.1	234.6	58.18	221.8	57.35	208.2	56.72	201.4	56.03	194.6	55.33	181.8	53.72
	7.0	6	234.6	57.63	221.8	56.75	208.2	56.13	201.4	55.45	194.6	54.73	181.8	53.05
	9.0	7.9	234.6	57.58	221.8	56.73	208.2	56.08	201.4	55.41	194.6	54.70	181.8	53.00
	11.0	9.8	234.6	58.10	221.8	57.22	208.2	56.60	201.4	55.90	194.6	55.18	181.8	53.49
13.0	11.8	234.6	58.59	221.8	57.71	208.2	57.06	201.4	56.37	194.6	55.64	181.8	53.93	
15.0	13.7	234.6	59.06	221.8	58.18	208.2	57.51	201.4	56.81	194.6	56.08	181.8	54.35	

Note

1. TC: Total Capacity(kW), PI: Power Input(kW, Comp. + Outdoor fan motor)
2. Capacity tables show the average value of conditions which may occur.
3. In the range beyond the operation limit of the outdoor unit, continuous operation and performance can not be guaranteed. When selecting the outdoor units, avoid the air temperature range that is not guaranteed continuous operation.

7. Capacity Tables

Combination (%)		Heating Capacity (68HP)												
		Outdoor air temp.		Indoor air temp. °C DB										
		°C DB	°C WB	16		18		20		21		22		24
		TC	PI	TC	PI	TC	PI	TC	PI	TC	PI	TC	PI	
100	-19.8	-20	108.5	52.26	108.5	54.26	107.7	55.95	107.7	59.16	107.7	61.41	107.7	62.27
	-18.8	-19	113.7	53.25	113.0	55.25	113.0	57.16	113.0	60.17	113.0	62.27	113.0	61.70
	-16.7	-17	124.0	55.35	124.0	57.37	124.0	59.70	123.2	62.27	123.2	61.15	123.2	60.48
	-13.7	-15	140.4	58.36	140.4	60.37	139.7	62.27	139.7	60.82	139.7	59.57	139.7	58.74
	-11.8	-13	148.3	60.27	147.5	62.27	147.5	61.44	147.5	59.89	147.5	58.56	147.5	57.63
	-9.8	-11	156.5	62.27	156.5	61.39	155.7	60.53	155.7	58.93	155.7	57.50	155.7	56.47
	-9.5	-10	160.3	62.16	160.3	61.26	159.6	60.40	159.6	58.77	159.6	57.35	159.6	56.31
	-8.5	-9.1	172.6	61.77	172.6	60.82	171.9	59.96	184.4	58.30	178.1	56.80	166.1	55.72
	-7.0	-7.6	194.6	61.18	193.8	60.17	190.4	59.29	184.4	57.58	178.1	56.02	166.1	54.86
	-5.0	-5.6	203.0	60.43	201.1	59.29	190.4	58.41	184.4	56.60	178.1	54.96	166.1	53.69
	-3.0	-3.7	209.0	59.65	202.7	58.41	190.4	57.53	184.4	55.64	178.1	53.90	166.1	52.53
	0.0	-0.7	214.7	58.49	202.7	57.11	190.4	56.21	184.4	54.19	178.1	52.32	166.1	50.80
	3.0	2.2	214.7	57.32	202.7	55.79	190.4	54.86	184.4	52.74	178.1	50.72	166.1	49.06
	5.0	4.1	214.7	56.57	202.7	54.91	190.4	53.98	184.4	51.78	178.1	49.66	166.1	47.90
	7.0	6	214.7	55.79	202.7	54.03	190.4	53.10	184.4	50.80	178.1	48.60	166.1	46.75
	9.0	7.9	214.7	55.02	202.7	53.28	190.4	52.37	184.4	50.10	178.1	47.94	166.1	46.11
	11.0	9.8	214.7	54.76	202.7	53.03	190.4	52.12	184.4	49.86	178.1	47.71	166.1	45.88
13.0	11.8	214.7	54.45	202.7	52.74	190.4	51.81	184.4	49.58	178.1	47.43	166.1	45.62	
15.0	13.7	214.7	54.06	202.7	52.38	190.4	51.47	184.4	49.24	178.1	47.10	166.1	45.31	
90	-19.8	-20	108.0	49.23	108.0	52.86	107.2	55.38	107.2	56.59	107.2	55.79	107.2	54.39
	-18.8	-19	113.7	50.43	113.0	54.05	112.5	56.59	112.5	56.21	112.5	55.40	112.5	53.93
	-16.7	-17	124.0	52.97	124.0	56.59	123.5	55.90	123.5	55.43	123.5	54.55	123.5	53.00
	-13.7	-15	140.4	56.59	140.4	55.69	138.9	54.91	138.9	54.29	138.9	53.36	138.9	51.67
	-11.8	-13	148.3	56.08	147.5	55.12	146.8	54.29	146.8	53.56	146.8	52.60	146.8	50.84
	-9.8	-11	156.5	55.53	156.5	54.50	155.1	53.62	155.1	52.81	155.1	51.80	142.3	49.94
	-9.5	-10	160.3	55.46	160.3	54.42	158.8	53.54	158.8	52.69	158.8	51.67	145.7	49.81
	-8.5	-9.1	172.6	55.19	171.6	54.11	171.1	53.20	168.7	52.32	163.4	51.28	151.7	49.37
	-7.0	-7.6	194.6	54.78	185.1	53.67	174.2	52.71	168.7	51.75	163.4	50.67	151.7	48.70
	-5.0	-5.6	196.7	54.24	185.1	53.05	174.2	52.04	168.7	51.00	163.4	49.86	151.7	47.82
	-3.0	-3.7	196.7	53.69	185.1	52.45	174.2	51.39	168.7	50.23	163.4	49.08	151.7	46.93
	0.0	-0.7	196.7	52.89	185.1	51.54	174.2	50.40	168.7	49.11	163.4	47.87	151.7	45.61
	3.0	2.2	196.7	52.06	185.1	50.64	174.2	49.40	168.7	47.97	163.4	46.67	151.7	44.27
	5.0	4.1	196.7	51.52	185.1	50.02	174.2	48.75	168.7	47.20	163.4	45.87	151.7	43.39
	7.0	6	196.7	50.98	185.1	49.42	174.2	48.10	168.7	46.44	163.4	45.07	151.7	42.50
	9.0	7.9	196.7	50.28	185.1	48.75	174.2	47.43	168.7	45.82	163.4	44.45	151.7	41.91
	11.0	9.8	196.7	49.58	185.1	48.05	174.2	46.78	168.7	45.17	163.4	43.83	151.7	41.34
13.0	11.8	196.7	48.88	185.1	47.38	174.2	46.11	168.7	44.53	163.4	43.21	151.7	40.75	
15.0	13.7	196.7	48.18	185.1	46.70	174.2	45.46	168.7	43.90	163.4	42.59	151.7	40.17	
80	-19.8	-20	106.9	42.81	106.9	46.44	106.9	50.19	106.9	49.42	106.9	48.26	106.9	47.01
	-18.8	-19	112.0	44.03	112.0	50.19	112.0	49.84	112.0	49.03	112.0	47.87	112.0	46.62
	-16.7	-17	123.5	50.19	123.5	49.53	123.5	49.11	123.5	48.25	123.5	47.06	123.5	45.77
	-13.7	-15	145.4	49.34	142.6	48.59	138.9	48.07	138.9	47.09	138.9	45.90	135.5	44.55
	-11.8	-13	157.2	48.80	152.8	48.02	146.8	47.42	146.8	46.39	145.7	45.17	135.5	43.80
	-9.8	-11	162.2	48.23	157.5	47.40	155.1	46.73	151.2	45.61	145.7	44.40	135.5	42.99
	-9.5	-10	163.2	48.13	158.5	47.30	155.9	46.62	151.2	45.51	145.7	44.29	135.5	42.87
	-8.5	-9.1	169.2	47.84	166.1	46.99	155.9	46.28	151.2	45.12	145.7	43.90	135.5	42.45
	-7.0	-7.6	176.0	47.42	166.1	46.52	155.9	45.77	151.2	44.55	145.7	43.33	135.5	41.86
	-5.0	-5.6	176.0	46.85	166.1	45.90	155.9	45.07	151.2	43.80	145.7	42.56	135.5	41.05
	-3.0	-3.7	176.0	46.28	166.1	45.28	155.9	44.37	151.2	43.02	145.7	41.78	135.5	40.25
	0.0	-0.7	176.0	45.43	166.1	44.34	155.9	43.34	151.2	41.88	145.7	40.62	135.5	39.03
	3.0	2.2	176.0	44.58	166.1	43.41	155.9	42.30	151.2	40.74	145.7	39.47	135.5	37.82
	5.0	4.1	176.0	44.01	166.1	42.79	155.9	41.62	151.2	39.97	145.7	38.70	135.5	37.02
	7.0	6	176.0	43.44	166.1	42.17	155.9	40.92	151.2	39.22	145.7	37.92	135.5	36.21
	9.0	7.9	176.0	40.77	166.1	39.58	155.9	38.42	151.2	36.83	145.7	35.62	135.5	34.01
	11.0	9.8	176.0	37.84	166.1	36.75	155.9	35.67	151.2	34.17	145.7	33.05	135.5	31.55
13.0	11.8	176.0	35.33	166.1	34.30	155.9	33.29	151.2	31.91	145.7	30.85	135.5	29.45	
15.0	13.7	176.0	33.26	166.1	32.30	155.9	31.34	151.2	30.02	145.7	29.04	135.5	27.74	

Note

1. TC: Total Capacity(kW), PI: Power Input(kW, Comp. + Outdoor fan motor)
2. Capacity tables show the average value of conditions which may occur.
3. In the range beyond the operation limit of the outdoor unit, continuous operation and performance can not be guaranteed. When selecting the outdoor units, avoid the air temperature range that is not guaranteed continuous operation.

7. Capacity Tables

Combination (%)	Outdoor air temp. °C		Heating Capacity (68HP)											
			Indoor air temp. °C DB											
	DB	WB	16		18		20		21		22		24	
		TC	PI	TC	PI	TC	PI	TC	PI	TC	PI	TC	PI	
70	-19.8	-20	106.9	45.35	106.9	46.57	106.9	45.76	106.9	44.50	106.9	43.31	106.9	41.98
	-18.8	-19	112.0	46.57	112.0	46.18	112.0	45.37	112.0	44.10	112.0	42.91	112.0	41.55
	-16.7	-17	123.5	45.84	123.5	45.38	123.5	44.52	123.5	43.23	123.5	42.06	115.9	40.66
	-13.7	-15	149.3	44.83	141.0	44.23	132.6	43.33	128.1	42.01	124.3	40.84	115.9	39.37
	-11.8	-13	149.3	44.19	141.0	43.49	132.6	42.58	128.1	41.21	124.3	40.07	115.9	38.57
	-9.8	-11	149.3	43.51	141.0	42.73	132.6	41.78	128.1	40.40	124.3	39.27	115.9	37.71
	-9.5	-10	149.3	43.41	141.0	42.61	132.6	41.65	128.1	40.27	124.3	39.14	115.9	37.58
	-8.5	-9.1	149.3	43.07	141.0	42.24	132.6	41.26	128.1	39.86	124.3	38.75	115.9	37.17
	-7.0	-7.6	149.3	42.56	141.0	41.65	132.6	40.66	128.1	39.24	124.3	38.13	115.9	36.52
	-5.0	-5.6	149.3	41.88	141.0	40.90	132.6	39.86	128.1	38.41	124.3	37.32	115.9	35.67
	-3.0	-3.7	149.3	41.21	141.0	40.12	132.6	39.06	128.1	37.61	124.3	36.52	115.9	34.81
	0.0	-0.7	149.3	40.20	141.0	38.98	132.6	37.87	128.1	36.37	124.3	35.31	115.9	33.52
	3.0	2.2	149.3	39.17	141.0	37.82	132.6	36.68	128.1	35.15	124.3	34.09	115.9	32.25
	5.0	4.1	149.3	38.49	141.0	37.06	132.6	35.88	128.1	34.32	124.3	33.29	115.9	31.39
	7.0	6	149.3	37.82	141.0	36.29	132.6	35.07	128.1	33.49	124.3	32.48	115.9	30.54
	9.0	7.9	149.3	34.14	141.0	32.77	132.6	31.68	128.1	30.25	124.3	29.32	115.9	27.58
11.0	9.8	149.3	31.79	141.0	30.51	132.6	29.50	128.1	28.16	124.3	27.30	115.9	25.67	
13.0	11.8	149.3	29.74	141.0	28.55	132.6	27.59	128.1	26.34	124.3	25.54	115.9	24.01	
15.0	13.7	149.3	28.05	141.0	26.91	132.6	26.01	128.1	24.84	124.3	24.09	115.9	22.64	
60	-19.8	-20	128.1	42.94	121.3	42.14	106.9	40.89	106.9	39.68	106.2	38.46	99.4	37.14
	-18.8	-19	128.1	42.58	121.3	41.75	112.0	40.48	109.9	39.26	106.2	38.07	99.4	36.72
	-16.7	-17	128.1	41.85	121.3	40.89	113.8	39.63	109.9	38.41	106.2	37.22	99.4	35.82
	-13.7	-15	128.1	40.79	121.3	39.70	113.8	38.41	109.9	37.19	106.2	36.00	99.4	34.53
	-11.8	-13	128.1	40.14	121.3	38.93	113.8	37.63	109.9	36.44	106.2	35.22	99.4	33.72
	-9.8	-11	128.1	39.44	121.3	38.15	113.8	36.81	109.9	35.61	106.2	34.42	99.4	32.87
	-9.5	-10	128.1	39.32	121.3	38.02	113.8	36.70	109.9	35.49	106.2	34.29	99.4	32.74
	-8.5	-9.1	128.1	38.98	121.3	37.61	113.8	36.28	109.9	35.09	106.2	33.90	99.4	32.30
	-7.0	-7.6	128.1	38.46	121.3	37.01	113.8	35.67	109.9	34.47	106.2	33.28	99.4	31.67
	-5.0	-5.6	128.1	37.76	121.3	36.21	113.8	34.86	109.9	33.67	106.2	32.48	99.4	30.82
	-3.0	-3.7	128.1	37.04	121.3	35.43	113.8	34.03	109.9	32.84	106.2	31.67	99.4	29.96
	0.0	-0.7	128.1	36.00	121.3	34.22	113.8	32.82	109.9	31.63	106.2	30.46	99.4	28.67
	3.0	2.2	128.1	34.94	121.3	33.02	113.8	31.60	109.9	30.41	106.2	29.24	99.4	27.38
	5.0	4.1	128.1	34.24	121.3	32.22	113.8	30.77	109.9	29.61	106.2	28.42	99.4	26.53
	7.0	6	128.1	33.54	121.3	31.42	113.8	29.95	109.9	28.78	106.2	27.61	99.4	25.67
	9.0	7.9	128.1	29.94	121.3	28.03	113.8	26.73	109.9	25.69	106.2	24.64	99.4	22.92
11.0	9.8	128.1	27.95	121.3	26.19	113.8	24.95	109.9	23.99	106.2	23.00	99.4	21.40	
13.0	11.8	128.1	26.19	121.3	24.53	113.8	23.39	109.9	22.46	106.2	21.55	99.4	20.05	
15.0	13.7	128.1	24.74	121.3	23.18	113.8	22.09	109.9	21.24	106.2	20.36	99.4	18.94	
50	-19.8	-20	107.0	38.46	100.9	37.11	94.7	35.86	91.8	34.58	88.7	33.40	82.6	32.14
	-18.8	-19	107.0	38.04	100.9	36.67	94.7	35.43	91.8	34.16	88.7	32.99	82.6	31.70
	-16.7	-17	107.0	37.14	100.9	35.76	94.7	34.52	91.8	33.28	88.7	32.14	82.6	30.84
	-13.7	-15	107.0	35.87	100.9	34.44	94.7	33.25	91.8	31.98	88.7	30.90	82.6	29.58
	-11.8	-13	107.0	35.06	100.9	33.59	94.7	32.45	91.8	31.18	88.7	30.14	82.6	28.80
	-9.8	-11	107.0	34.21	100.9	32.71	94.7	31.59	91.8	30.33	88.7	29.32	82.6	27.97
	-9.5	-10	107.0	34.08	100.9	32.58	94.7	31.46	91.8	30.20	88.7	29.19	82.6	27.84
	-8.5	-9.1	107.0	33.64	100.9	32.14	94.7	31.03	91.8	29.78	88.7	28.80	82.6	27.43
	-7.0	-7.6	107.0	33.02	100.9	31.49	94.7	30.38	91.8	29.14	88.7	28.18	82.6	26.80
	-5.0	-5.6	107.0	32.17	100.9	30.61	94.7	29.53	91.8	28.28	88.7	27.35	82.6	25.95
	-3.0	-3.7	107.0	31.31	100.9	29.73	94.7	28.67	91.8	27.43	88.7	26.55	82.6	25.12
	0.0	-0.7	107.0	30.04	100.9	28.41	94.7	27.40	91.8	26.16	88.7	25.33	82.6	23.88
	3.0	2.2	107.0	28.75	100.9	27.09	94.7	26.11	91.8	24.89	88.7	24.09	82.6	22.63
	5.0	4.1	107.0	27.92	100.9	26.21	94.7	25.26	91.8	24.04	88.7	23.28	82.6	21.79
	7.0	6	107.0	27.07	100.9	25.33	94.7	24.40	91.8	23.18	88.7	22.46	82.6	20.96
	9.0	7.9	107.0	24.43	100.9	22.87	94.7	22.04	91.8	20.93	88.7	20.28	82.6	18.93
11.0	9.8	107.0	22.87	100.9	21.40	94.7	20.62	91.8	19.58	88.7	18.99	82.6	17.72	
13.0	11.8	107.0	21.47	100.9	20.10	94.7	19.35	91.8	18.39	88.7	17.82	82.6	16.63	
15.0	13.7	107.0	20.31	100.9	19.01	94.7	18.31	91.8	17.41	88.7	16.86	82.6	15.73	

Note

1. TC: Total Capacity(kW), PI: Power Input(kW, Comp. + Outdoor fan motor)
2. Capacity tables show the average value of conditions which may occur.
3. In the range beyond the operation limit of the outdoor unit, continuous operation and performance can not be guaranteed. When selecting the outdoor units, avoid the air temperature range that is not guaranteed continuous operation.

7. Capacity Tables

◆ A(C)RUN700LLS5

Combination (%)	Outdoor air temp.		Heating Capacity (70HP)											
			Indoor air temp. °C DB											
	°C DB	°C WB	16		18		20		21		22		24	
		TC	PI	TC	PI	TC	PI	TC	PI	TC	PI	TC	PI	
130	-19.8	-20	113.6	46.81	113.6	48.61	112.9	50.19	112.9	52.60	112.9	54.90	112.9	58.53
	-18.8	-19	119.0	48.01	119.0	49.82	118.2	51.40	118.2	53.82	118.2	56.10	118.2	59.73
	-16.7	-17	130.6	50.55	130.6	52.36	129.8	53.92	129.8	56.35	129.8	58.64	129.8	62.27
	-13.7	-15	147.0	54.18	147.0	55.99	146.2	57.55	146.2	59.96	146.2	62.27	146.2	61.57
	-11.8	-13	155.3	56.46	155.3	58.28	154.3	59.86	154.3	62.27	154.3	61.93	154.3	61.13
	-9.8	-11	164.0	58.89	164.0	60.69	162.9	62.27	162.9	62.06	162.9	61.57	162.9	60.66
	-9.5	-10	168.0	59.26	168.0	61.05	166.9	62.27	166.9	62.03	164.3	61.51	164.3	60.61
	-8.5	-9.1	181.0	60.45	181.0	62.27	179.9	62.26	179.9	61.93	168.6	61.33	168.6	60.37
	-7.0	-7.6	200.6	62.27	200.6	62.43	199.2	62.24	199.2	61.77	199.2	61.05	182.5	60.02
	-5.0	-5.6	226.7	62.81	226.7	62.66	225.1	62.22	225.1	61.57	225.1	60.69	193.5	59.55
	-3.0	-3.7	252.7	63.36	252.7	62.89	251.1	62.21	246.3	61.36	237.7	60.33	204.5	59.08
	0.0	-0.7	253.3	64.19	253.3	63.20	252.5	62.19	246.3	61.05	237.7	59.78	220.7	58.39
	3.0	2.2	253.3	65.02	253.3	63.54	252.5	62.16	246.3	60.74	237.7	59.24	221.3	57.71
	5.0	4.1	253.3	65.56	253.3	63.77	252.5	62.14	246.3	60.53	237.7	58.88	221.3	57.24
	7.0	6	253.3	66.13	253.3	63.98	252.5	62.14	246.3	60.32	237.7	58.52	221.3	56.78
	9.0	7.9	253.3	66.75	253.3	64.60	252.5	62.73	246.3	60.90	237.7	59.09	221.3	57.32
	11.0	9.8	253.3	68.07	253.3	65.87	252.5	63.95	246.3	62.09	237.7	60.25	221.3	58.44
	13.0	11.8	253.3	69.37	253.3	67.14	252.5	65.17	246.3	63.28	237.7	61.39	221.3	59.55
15.0	13.7	253.3	70.66	253.3	68.39	252.5	66.41	246.3	64.47	237.7	62.56	221.3	60.69	
120	-19.8	-20	112.8	48.61	112.8	50.19	112.0	52.60	112.0	54.90	112.0	58.53	112.0	61.05
	-18.8	-19	118.2	49.82	118.2	51.40	117.4	53.82	117.4	56.10	117.4	59.73	117.4	62.27
	-16.7	-17	129.5	52.36	129.5	53.92	128.7	56.35	128.7	58.64	128.7	62.27	128.7	61.82
	-13.7	-15	145.9	55.99	145.9	57.55	145.1	59.96	145.1	62.27	145.1	61.70	145.1	61.18
	-11.8	-13	154.3	58.28	154.3	59.86	153.2	62.27	153.2	61.90	153.2	61.34	153.2	60.77
	-9.8	-11	162.9	60.69	162.9	62.27	161.8	61.98	161.8	61.52	161.8	60.97	161.8	60.35
	-9.5	-10	166.7	61.05	166.7	62.24	165.8	61.93	165.8	61.47	165.8	60.90	165.8	60.27
	-8.5	-9.1	179.6	62.27	179.6	62.14	178.5	61.78	178.5	61.28	173.1	60.71	173.1	60.07
	-7.0	-7.6	199.2	62.27	199.2	62.01	197.9	61.54	197.9	61.00	181.4	60.43	181.4	59.75
	-5.0	-5.6	225.0	62.29	225.0	61.80	223.7	61.26	223.7	60.61	223.7	60.06	192.1	59.32
	-3.0	-3.7	248.7	62.29	248.7	61.62	238.8	60.95	231.0	60.22	223.7	59.68	202.9	58.90
	0.0	-0.7	251.2	62.32	248.7	61.34	238.8	60.51	231.0	59.66	223.7	59.11	207.8	58.25
	3.0	2.2	251.2	62.32	248.7	61.05	238.8	60.07	231.0	59.09	223.7	58.54	207.8	57.61
	5.0	4.1	251.2	62.35	248.7	60.85	238.8	59.76	231.0	58.72	223.7	58.15	207.8	57.17
	7.0	6	251.2	62.35	248.7	60.66	238.8	59.47	231.0	58.33	223.7	57.79	207.8	56.75
	9.0	7.9	251.2	62.66	248.7	60.97	238.8	59.76	231.0	58.62	223.7	58.07	207.8	57.04
	11.0	9.8	251.2	63.59	248.7	61.86	238.8	60.64	231.0	59.48	223.7	58.93	207.8	57.87
	13.0	11.8	251.2	64.50	248.7	62.74	238.8	61.52	231.0	60.33	223.7	59.76	207.8	58.70
15.0	13.7	251.2	65.38	248.7	63.62	238.8	62.37	231.0	61.16	223.7	60.59	207.8	59.50	
110	-19.8	-20	112.1	50.19	112.1	52.60	111.5	54.90	111.5	58.53	111.5	61.05	111.5	62.27
	-18.8	-19	117.5	51.40	117.5	53.82	116.9	56.10	116.9	59.73	116.9	62.27	116.9	61.93
	-16.7	-17	129.0	53.92	129.0	56.35	128.2	58.64	128.2	62.27	128.2	61.65	128.2	61.20
	-13.7	-15	145.1	57.55	145.1	59.96	144.3	62.27	144.3	61.41	144.3	60.79	144.3	60.17
	-11.8	-13	153.4	59.86	153.4	62.27	152.4	61.70	152.4	60.87	152.4	60.22	152.4	59.52
	-9.8	-11	162.1	62.27	162.1	61.67	161.0	61.10	161.0	60.27	161.0	59.65	161.0	58.82
	-9.5	-10	165.9	62.19	165.9	61.59	164.8	61.02	164.8	60.20	164.8	59.55	164.8	58.72
	-8.5	-9.1	178.8	61.91	178.8	61.31	177.7	60.72	177.7	59.91	173.1	59.26	173.1	58.38
	-7.0	-7.6	198.1	61.49	198.1	60.87	196.8	60.27	196.8	59.47	181.6	58.82	181.6	57.86
	-5.0	-5.6	215.7	60.95	215.7	60.27	214.3	59.68	207.3	58.90	190.2	58.23	187.1	57.17
	-3.0	-3.7	228.3	60.40	228.3	59.70	214.3	59.08	207.3	58.33	200.3	57.66	187.1	56.49
	0.0	-0.7	241.5	59.57	228.3	58.82	214.3	58.20	207.3	57.45	200.3	56.78	187.1	55.46
	3.0	2.2	241.5	58.74	228.3	57.94	214.3	57.32	207.3	56.60	200.3	55.90	187.1	54.42
	5.0	4.1	241.5	58.18	228.3	57.35	214.3	56.72	207.3	56.03	200.3	55.33	187.1	53.72
	7.0	6	241.5	57.63	228.3	56.75	214.3	56.13	207.3	55.45	200.3	54.73	187.1	53.05
	9.0	7.9	241.5	57.58	228.3	56.73	214.3	56.08	207.3	55.41	200.3	54.70	187.1	53.00
	11.0	9.8	241.5	58.10	228.3	57.22	214.3	56.60	207.3	55.90	200.3	55.18	187.1	53.49
	13.0	11.8	241.5	58.59	228.3	57.71	214.3	57.06	207.3	56.37	200.3	55.64	187.1	53.93
15.0	13.7	241.5	59.06	228.3	58.18	214.3	57.51	207.3	56.81	200.3	56.08	187.1	54.35	

Note

1. TC: Total Capacity(kW), PI : Power Input(kW, Comp. + Outdoor fan motor)
2. Capacity tables show the average value of conditions which may occur.
3. In the range beyond the operation limit of the outdoor unit, continuous operation and performance can not be guaranteed. When selecting the outdoor units, avoid the air temperature range that is not guaranteed continuous operation.

7. Capacity Tables

Combination (%)		Heating Capacity (70HP)												
		Outdoor air temp.		Indoor air temp. °C DB										
		°C DB	°C WB	16		18		20		21		22		24
		TC	PI	TC	PI	TC	PI	TC	PI	TC	PI	TC	PI	
100	-19.8	-20	111.8	52.26	111.8	54.26	111.0	55.95	111.0	59.16	111.0	61.41	111.0	62.27
	-18.8	-19	117.1	53.25	116.3	55.25	116.3	57.16	116.3	60.17	116.3	62.27	116.3	61.70
	-16.7	-17	127.6	55.35	127.6	57.37	127.6	59.70	126.8	62.27	126.8	61.15	126.8	60.48
	-13.7	-15	144.5	58.36	144.5	60.37	143.7	62.27	143.7	60.82	143.7	59.57	143.7	58.74
	-11.8	-13	152.6	60.27	151.8	62.27	151.8	61.44	151.8	59.89	151.8	58.56	151.8	57.63
	-9.8	-11	161.1	62.27	161.1	61.39	160.3	60.53	160.3	58.93	160.3	57.50	160.3	56.47
	-9.5	-10	165.0	62.16	165.0	61.26	164.2	60.40	164.2	58.77	164.2	57.35	164.2	56.31
	-8.5	-9.1	177.7	61.77	177.7	60.82	176.9	59.96	189.8	58.30	183.4	56.80	170.9	55.72
	-7.0	-7.6	200.3	61.18	199.5	60.17	196.0	59.29	189.8	57.58	183.4	56.02	170.9	54.86
	-5.0	-5.6	209.0	60.43	207.0	59.29	196.0	58.41	189.8	56.60	183.4	54.96	170.9	53.69
	-3.0	-3.7	215.1	59.65	208.6	58.41	196.0	57.53	189.8	55.64	183.4	53.90	170.9	52.53
	0.0	-0.7	221.1	58.49	208.6	57.11	196.0	56.21	189.8	54.19	183.4	52.32	170.9	50.80
	3.0	2.2	221.1	57.32	208.6	55.79	196.0	54.86	189.8	52.74	183.4	50.72	170.9	49.06
	5.0	4.1	221.1	56.57	208.6	54.91	196.0	53.98	189.8	51.78	183.4	49.66	170.9	47.90
	7.0	6	221.1	55.79	208.6	54.03	196.0	53.10	189.8	50.80	183.4	48.60	170.9	46.75
	9.0	7.9	221.1	55.02	208.6	53.28	196.0	52.37	189.8	50.10	183.4	47.94	170.9	46.11
	11.0	9.8	221.1	54.76	208.6	53.03	196.0	52.12	189.8	49.86	183.4	47.71	170.9	45.88
13.0	11.8	221.1	54.45	208.6	52.74	196.0	51.81	189.8	49.58	183.4	47.43	170.9	45.62	
15.0	13.7	221.1	54.06	208.6	52.38	196.0	51.47	189.8	49.24	183.4	47.10	170.9	45.31	
90	-19.8	-20	111.2	49.23	111.2	52.86	110.5	55.38	110.5	56.59	110.5	55.79	110.5	54.39
	-18.8	-19	117.1	50.43	116.3	54.05	115.8	56.59	115.8	56.21	115.8	55.40	115.8	53.93
	-16.7	-17	127.6	52.97	127.6	56.59	127.1	55.90	127.1	55.43	127.1	54.55	127.1	53.00
	-13.7	-15	144.5	56.59	144.5	55.69	143.0	54.91	143.0	54.29	143.0	53.36	143.0	51.67
	-11.8	-13	152.6	56.08	151.8	55.12	151.1	54.29	151.1	53.56	151.1	52.60	151.1	50.84
	-9.8	-11	161.1	55.53	161.1	54.50	159.7	53.62	159.7	52.81	159.7	51.80	146.5	49.94
	-9.5	-10	165.0	55.46	165.0	54.42	163.5	53.54	163.5	52.69	163.5	51.67	150.0	49.81
	-8.5	-9.1	177.7	55.19	176.6	54.11	176.1	53.20	173.7	52.32	168.2	51.28	156.2	49.37
	-7.0	-7.6	200.3	54.78	190.6	53.67	179.3	52.71	173.7	51.75	168.2	50.67	156.2	48.70
	-5.0	-5.6	202.5	54.24	190.6	53.05	179.3	52.04	173.7	51.00	168.2	49.86	156.2	47.82
	-3.0	-3.7	202.5	53.69	190.6	52.45	179.3	51.39	173.7	50.23	168.2	49.08	156.2	46.93
	0.0	-0.7	202.5	52.89	190.6	51.54	179.3	50.40	173.7	49.11	168.2	47.87	156.2	45.61
	3.0	2.2	202.5	52.06	190.6	50.64	179.3	49.40	173.7	47.97	168.2	46.67	156.2	44.27
	5.0	4.1	202.5	51.52	190.6	50.02	179.3	48.75	173.7	47.20	168.2	45.87	156.2	43.39
	7.0	6	202.5	50.98	190.6	49.42	179.3	48.10	173.7	46.44	168.2	45.07	156.2	42.50
	9.0	7.9	202.5	50.28	190.6	48.75	179.3	47.43	173.7	45.82	168.2	44.45	156.2	41.91
	11.0	9.8	202.5	49.58	190.6	48.05	179.3	46.78	173.7	45.17	168.2	43.83	156.2	41.34
13.0	11.8	202.5	48.88	190.6	47.38	179.3	46.11	173.7	44.53	168.2	43.21	156.2	40.75	
15.0	13.7	202.5	48.18	190.6	46.70	179.3	45.46	173.7	43.90	168.2	42.59	156.2	40.17	
80	-19.8	-20	110.1	42.81	110.1	46.44	110.1	50.19	110.1	49.42	110.1	48.26	110.1	47.01
	-18.8	-19	115.3	44.03	115.3	50.19	115.3	49.84	115.3	49.03	115.3	47.87	115.3	46.62
	-16.7	-17	127.1	50.19	127.1	49.53	127.1	49.11	127.1	48.25	127.1	47.06	127.1	45.77
	-13.7	-15	149.7	49.34	146.7	48.59	143.0	48.07	143.0	47.09	143.0	45.90	139.5	44.55
	-11.8	-13	161.8	48.80	157.2	48.02	151.1	47.42	151.1	46.39	150.0	45.17	139.5	43.80
	-9.8	-11	167.0	48.23	162.1	47.40	159.7	46.73	155.6	45.61	150.0	44.40	139.5	42.99
	-9.5	-10	168.0	48.13	163.1	47.30	160.5	46.62	155.6	45.51	150.0	44.29	139.5	42.87
	-8.5	-9.1	174.2	47.84	170.9	46.99	160.5	46.28	155.6	45.12	150.0	43.90	139.5	42.45
	-7.0	-7.6	181.2	47.42	170.9	46.52	160.5	45.77	155.6	44.55	150.0	43.33	139.5	41.86
	-5.0	-5.6	181.2	46.85	170.9	45.90	160.5	45.07	155.6	43.80	150.0	42.56	139.5	41.05
	-3.0	-3.7	181.2	46.28	170.9	45.28	160.5	44.37	155.6	43.02	150.0	41.78	139.5	40.25
	0.0	-0.7	181.2	45.43	170.9	44.34	160.5	43.34	155.6	41.88	150.0	40.62	139.5	39.03
	3.0	2.2	181.2	44.58	170.9	43.41	160.5	42.30	155.6	40.74	150.0	39.47	139.5	37.82
	5.0	4.1	181.2	44.01	170.9	42.79	160.5	41.62	155.6	39.97	150.0	38.70	139.5	37.02
	7.0	6	181.2	43.44	170.9	42.17	160.5	40.92	155.6	39.22	150.0	37.92	139.5	36.21
	9.0	7.9	181.2	40.77	170.9	39.58	160.5	38.42	155.6	36.83	150.0	35.62	139.5	34.01
	11.0	9.8	181.2	37.84	170.9	36.75	160.5	35.67	155.6	34.17	150.0	33.05	139.5	31.55
13.0	11.8	181.2	35.33	170.9	34.30	160.5	33.29	155.6	31.91	150.0	30.85	139.5	29.45	
15.0	13.7	181.2	33.26	170.9	32.30	160.5	31.34	155.6	30.02	150.0	29.04	139.5	27.74	

Note

1. TC: Total Capacity(kW), PI: Power Input(kW, Comp. + Outdoor fan motor)
2. Capacity tables show the average value of conditions which may occur.
3. In the range beyond the operation limit of the outdoor unit, continuous operation and performance can not be guaranteed. When selecting the outdoor units, avoid the air temperature range that is not guaranteed continuous operation.

7. Capacity Tables

Combination (%)		Heating Capacity (70HP)												
		Outdoor air temp.		Indoor air temp. °C DB										
		°C DB	°C WB	16		18		20		21		22		24
		TC	PI	TC	PI	TC	PI	TC	PI	TC	PI	TC	PI	
70	-19.8	-20	110.1	45.35	110.1	46.57	110.1	45.76	110.1	44.50	110.1	43.31	110.1	41.98
	-18.8	-19	115.3	46.57	115.3	46.18	115.3	45.37	115.3	44.10	115.3	42.91	115.3	41.55
	-16.7	-17	127.1	45.84	127.1	45.38	127.1	44.52	127.1	43.23	127.1	42.06	119.3	40.66
	-13.7	-15	153.7	44.83	145.1	44.23	136.5	43.33	131.9	42.01	127.9	40.84	119.3	39.37
	-11.8	-13	153.7	44.19	145.1	43.49	136.5	42.58	131.9	41.21	127.9	40.07	119.3	38.57
	-9.8	-11	153.7	43.51	145.1	42.73	136.5	41.78	131.9	40.40	127.9	39.27	119.3	37.71
	-9.5	-10	153.7	43.41	145.1	42.61	136.5	41.65	131.9	40.27	127.9	39.14	119.3	37.58
	-8.5	-9.1	153.7	43.07	145.1	42.24	136.5	41.26	131.9	39.86	127.9	38.75	119.3	37.17
	-7.0	-7.6	153.7	42.56	145.1	41.65	136.5	40.66	131.9	39.24	127.9	38.13	119.3	36.52
	-5.0	-5.6	153.7	41.88	145.1	40.90	136.5	39.86	131.9	38.41	127.9	37.32	119.3	35.67
	-3.0	-3.7	153.7	41.21	145.1	40.12	136.5	39.06	131.9	37.61	127.9	36.52	119.3	34.81
	0.0	-0.7	153.7	40.20	145.1	38.98	136.5	37.87	131.9	36.37	127.9	35.31	119.3	33.52
	3.0	2.2	153.7	39.17	145.1	37.82	136.5	36.68	131.9	35.15	127.9	34.09	119.3	32.25
	5.0	4.1	153.7	38.49	145.1	37.06	136.5	35.88	131.9	34.32	127.9	33.29	119.3	31.39
	7.0	6	153.7	37.82	145.1	36.29	136.5	35.07	131.9	33.49	127.9	32.48	119.3	30.54
9.0	7.9	153.7	34.14	145.1	32.77	136.5	31.68	131.9	30.25	127.9	29.32	119.3	27.58	
11.0	9.8	153.7	31.79	145.1	30.51	136.5	29.50	131.9	28.16	127.9	27.30	119.3	25.67	
13.0	11.8	153.7	29.74	145.1	28.55	136.5	27.59	131.9	26.34	127.9	25.54	119.3	24.01	
15.0	13.7	153.7	28.05	145.1	26.91	136.5	26.01	131.9	24.84	127.9	24.09	119.3	22.64	
60	-19.8	-20	131.9	42.94	124.9	42.14	110.1	40.89	110.1	39.68	109.3	38.46	102.3	37.14
	-18.8	-19	131.9	42.58	124.9	41.75	115.3	40.48	113.1	39.26	109.3	38.07	102.3	36.72
	-16.7	-17	131.9	41.85	124.9	40.89	117.1	39.63	113.1	38.41	109.3	37.22	102.3	35.82
	-13.7	-15	131.9	40.79	124.9	39.70	117.1	38.41	113.1	37.19	109.3	36.00	102.3	34.53
	-11.8	-13	131.9	40.14	124.9	38.93	117.1	37.63	113.1	36.44	109.3	35.22	102.3	33.72
	-9.8	-11	131.9	39.44	124.9	38.15	117.1	36.81	113.1	35.61	109.3	34.42	102.3	32.87
	-9.5	-10	131.9	39.32	124.9	38.02	117.1	36.70	113.1	35.49	109.3	34.29	102.3	32.74
	-8.5	-9.1	131.9	38.98	124.9	37.61	117.1	36.28	113.1	35.09	109.3	33.90	102.3	32.30
	-7.0	-7.6	131.9	38.46	124.9	37.01	117.1	35.67	113.1	34.47	109.3	33.28	102.3	31.67
	-5.0	-5.6	131.9	37.76	124.9	36.21	117.1	34.86	113.1	33.67	109.3	32.48	102.3	30.82
	-3.0	-3.7	131.9	37.04	124.9	35.43	117.1	34.03	113.1	32.84	109.3	31.67	102.3	29.96
	0.0	-0.7	131.9	36.00	124.9	34.22	117.1	32.82	113.1	31.63	109.3	30.46	102.3	28.67
	3.0	2.2	131.9	34.94	124.9	33.02	117.1	31.60	113.1	30.41	109.3	29.24	102.3	27.38
	5.0	4.1	131.9	34.24	124.9	32.22	117.1	30.77	113.1	29.61	109.3	28.42	102.3	26.53
	7.0	6	131.9	33.54	124.9	31.42	117.1	29.95	113.1	28.78	109.3	27.61	102.3	25.67
9.0	7.9	131.9	29.94	124.9	28.03	117.1	26.73	113.1	25.69	109.3	24.64	102.3	22.92	
11.0	9.8	131.9	27.95	124.9	26.19	117.1	24.95	113.1	23.99	109.3	23.00	102.3	21.40	
13.0	11.8	131.9	26.19	124.9	24.53	117.1	23.39	113.1	22.46	109.3	21.55	102.3	20.05	
15.0	13.7	131.9	24.74	124.9	23.18	117.1	22.09	113.1	21.24	109.3	20.36	102.3	18.94	
50	-19.8	-20	110.1	38.46	103.9	37.11	97.5	35.86	94.5	34.58	91.3	33.40	85.1	32.14
	-18.8	-19	110.1	38.04	103.9	36.67	97.5	35.43	94.5	34.16	91.3	32.99	85.1	31.70
	-16.7	-17	110.1	37.14	103.9	35.76	97.5	34.52	94.5	33.28	91.3	32.14	85.1	30.84
	-13.7	-15	110.1	35.87	103.9	34.44	97.5	33.25	94.5	31.98	91.3	30.90	85.1	29.58
	-11.8	-13	110.1	35.06	103.9	33.59	97.5	32.45	94.5	31.18	91.3	30.14	85.1	28.80
	-9.8	-11	110.1	34.21	103.9	32.71	97.5	31.59	94.5	30.33	91.3	29.32	85.1	27.97
	-9.5	-10	110.1	34.08	103.9	32.58	97.5	31.46	94.5	30.20	91.3	29.19	85.1	27.84
	-8.5	-9.1	110.1	33.64	103.9	32.14	97.5	31.03	94.5	29.78	91.3	28.80	85.1	27.43
	-7.0	-7.6	110.1	33.02	103.9	31.49	97.5	30.38	94.5	29.14	91.3	28.18	85.1	26.80
	-5.0	-5.6	110.1	32.17	103.9	30.61	97.5	29.53	94.5	28.28	91.3	27.35	85.1	25.95
	-3.0	-3.7	110.1	31.31	103.9	29.73	97.5	28.67	94.5	27.43	91.3	26.55	85.1	25.12
	0.0	-0.7	110.1	30.04	103.9	28.41	97.5	27.40	94.5	26.16	91.3	25.33	85.1	23.88
	3.0	2.2	110.1	28.75	103.9	27.09	97.5	26.11	94.5	24.89	91.3	24.09	85.1	22.63
	5.0	4.1	110.1	27.92	103.9	26.21	97.5	25.26	94.5	24.04	91.3	23.28	85.1	21.79
	7.0	6	110.1	27.07	103.9	25.33	97.5	24.40	94.5	23.18	91.3	22.46	85.1	20.96
9.0	7.9	110.1	24.43	103.9	22.87	97.5	22.04	94.5	20.93	91.3	20.28	85.1	18.93	
11.0	9.8	110.1	22.87	103.9	21.40	97.5	20.62	94.5	19.58	91.3	18.99	85.1	17.72	
13.0	11.8	110.1	21.47	103.9	20.10	97.5	19.35	94.5	18.39	91.3	17.82	85.1	16.63	
15.0	13.7	110.1	20.31	103.9	19.01	97.5	18.31	94.5	17.41	91.3	16.86	85.1	15.73	

Note

1. TC: Total Capacity(kW), PI: Power Input(kW, Comp. + Outdoor fan motor)
2. Capacity tables show the average value of conditions which may occur.
3. In the range beyond the operation limit of the outdoor unit, continuous operation and performance can not be guaranteed. When selecting the outdoor units, avoid the air temperature range that is not guaranteed continuous operation.

7. Capacity Tables

◆ A(C)RUN720LLS5

Combination (%)	Outdoor air temp.		Heating Capacity (72HP)											
			Indoor air temp. °C DB											
	°C DB	°C WB	16		18		20		21		22		24	
		TC	PI	TC	PI	TC	PI	TC	PI	TC	PI	TC	PI	
130	-19.8	-20	116.8	48.94	116.8	50.81	116.0	52.46	116.0	54.98	116.0	57.39	116.0	61.18
	-18.8	-19	122.4	50.19	122.4	52.08	121.6	53.73	121.6	56.25	121.6	58.64	121.6	62.43
	-16.7	-17	134.3	52.84	134.3	54.74	133.5	56.37	133.5	58.91	133.5	61.29	133.5	65.08
	-13.7	-15	151.2	56.63	151.2	58.53	150.4	60.16	150.4	62.68	150.4	65.08	150.4	64.35
	-11.8	-13	159.8	59.02	159.8	60.91	158.7	62.56	158.7	65.08	158.7	64.73	158.7	63.89
	-9.8	-11	168.7	61.56	168.7	63.43	167.6	65.08	167.6	64.87	167.6	64.35	167.6	63.41
	-9.5	-10	172.8	61.94	172.8	63.81	171.7	65.08	171.7	64.84	169.0	64.30	169.0	63.35
	-8.5	-9.1	186.1	63.19	186.1	65.08	185.0	65.08	185.0	64.73	173.4	64.11	173.4	63.10
	-7.0	-7.6	206.3	65.08	206.3	65.25	204.9	65.06	204.9	64.57	204.9	63.81	187.8	62.73
	-5.0	-5.6	233.1	65.65	233.1	65.49	231.5	65.03	231.5	64.35	231.5	63.43	199.2	62.24
	-3.0	-3.7	260.0	66.22	260.0	65.73	258.3	65.03	253.4	64.13	244.5	63.05	210.5	61.76
	0.0	-0.7	260.6	67.09	260.6	66.06	259.8	65.00	253.4	63.81	244.5	62.49	227.2	61.03
	3.0	2.2	260.6	67.95	260.6	66.41	259.8	64.97	253.4	63.48	244.5	61.92	227.6	60.32
	5.0	4.1	260.6	68.52	260.6	66.65	259.8	64.95	253.4	63.27	244.5	61.54	227.6	59.83
	7.0	6	260.6	69.11	260.6	66.87	259.8	64.95	253.4	63.05	244.5	61.16	227.6	59.34
	9.0	7.9	260.6	69.77	260.6	67.52	259.8	65.57	253.4	63.65	244.5	61.76	227.6	59.91
	11.0	9.8	260.6	71.15	260.6	68.85	259.8	66.84	253.4	64.90	244.5	62.97	227.6	61.08
13.0	11.8	260.6	72.50	260.6	70.17	259.8	68.12	253.4	66.14	244.5	64.17	227.6	62.24	
15.0	13.7	260.6	73.86	260.6	71.48	259.8	69.41	253.4	67.39	244.5	65.38	227.6	63.43	
120	-19.8	-20	116.0	50.81	116.0	52.46	115.2	54.98	115.2	57.39	115.2	61.18	115.2	63.81
	-18.8	-19	121.6	52.08	121.6	53.73	120.8	56.25	120.8	58.64	120.8	62.43	120.8	65.08
	-16.7	-17	133.3	54.74	133.3	56.37	132.4	58.91	132.4	61.29	132.4	65.08	132.4	64.62
	-13.7	-15	150.1	58.53	150.1	60.16	149.3	62.68	149.3	65.08	149.3	64.49	149.3	63.95
	-11.8	-13	158.7	60.91	158.7	62.56	157.6	65.08	157.6	64.70	157.6	64.11	157.6	63.51
	-9.8	-11	167.6	63.43	167.6	65.08	166.5	64.78	166.5	64.30	166.5	63.73	166.5	63.08
	-9.5	-10	171.5	63.81	171.5	65.06	170.6	64.73	170.6	64.25	170.6	63.65	170.6	63.00
	-8.5	-9.1	184.8	65.08	184.8	64.95	183.6	64.57	183.6	64.05	178.1	63.46	178.1	62.78
	-7.0	-7.6	204.9	65.09	204.9	64.81	203.5	64.33	203.5	63.76	186.7	63.16	186.7	62.45
	-5.0	-5.6	231.5	65.11	231.5	64.60	230.1	64.03	230.1	63.35	230.1	62.78	197.8	62.00
	-3.0	-3.7	255.8	65.11	255.8	64.41	245.6	63.71	237.6	62.95	230.1	62.38	208.9	61.56
	0.0	-0.7	258.4	65.14	255.8	64.11	245.6	63.24	237.6	62.35	230.1	61.78	213.8	60.89
	3.0	2.2	258.4	65.14	255.8	63.81	245.6	62.78	237.6	61.76	230.1	61.19	213.8	60.21
	5.0	4.1	258.4	65.16	255.8	63.60	245.6	62.46	237.6	61.37	230.1	60.78	213.8	59.75
	7.0	6	258.4	65.17	255.8	63.41	245.6	62.16	237.6	60.97	230.1	60.40	213.8	59.32
	9.0	7.9	258.4	65.49	255.8	63.73	245.6	62.46	237.6	61.27	230.1	60.70	213.8	59.61
	11.0	9.8	258.4	66.46	255.8	64.65	245.6	63.38	237.6	62.16	230.1	61.59	213.8	60.48
13.0	11.8	258.4	67.41	255.8	65.57	245.6	64.30	237.6	63.06	230.1	62.46	213.8	61.35	
15.0	13.7	258.4	68.34	255.8	66.49	245.6	65.19	237.6	63.92	230.1	63.33	213.8	62.19	
110	-19.8	-20	115.2	52.46	115.2	54.98	114.6	57.39	114.6	61.18	114.6	63.81	114.6	65.08
	-18.8	-19	120.8	53.73	120.8	56.25	120.2	58.64	120.2	62.43	120.2	65.08	120.2	64.73
	-16.7	-17	132.7	56.37	132.7	58.91	131.8	61.29	131.8	65.08	131.8	64.44	131.8	63.97
	-13.7	-15	149.3	60.16	149.3	62.68	148.5	65.08	148.5	64.19	148.5	63.54	148.5	62.89
	-11.8	-13	157.8	62.56	157.8	65.08	156.8	64.49	156.8	63.62	156.8	62.94	156.8	62.21
	-9.8	-11	166.7	65.08	166.7	64.46	165.6	63.87	165.6	63.00	165.6	62.35	165.6	61.48
	-9.5	-10	170.6	65.00	170.6	64.38	169.5	63.78	169.5	62.92	169.5	62.24	169.5	61.37
	-8.5	-9.1	183.9	64.71	183.9	64.08	182.8	63.46	182.8	62.62	178.0	61.94	178.0	61.02
	-7.0	-7.6	203.8	64.27	203.8	63.62	202.4	63.00	202.4	62.16	186.7	61.48	186.7	60.48
	-5.0	-5.6	221.8	63.70	221.8	63.00	220.4	62.38	213.2	61.56	195.5	60.86	192.4	59.75
	-3.0	-3.7	234.8	63.13	234.8	62.40	220.4	61.76	213.2	60.97	206.0	60.26	192.4	59.04
	0.0	-0.7	248.4	62.26	234.8	61.48	220.4	60.83	213.2	60.05	206.0	59.34	192.4	57.96
	3.0	2.2	248.4	61.40	234.8	60.56	220.4	59.91	213.2	59.15	206.0	58.42	192.4	56.88
	5.0	4.1	248.4	60.81	234.8	59.94	220.4	59.29	213.2	58.56	206.0	57.83	192.4	56.15
	7.0	6	248.4	60.24	234.8	59.32	220.4	58.67	213.2	57.96	206.0	57.21	192.4	55.44
	9.0	7.9	248.4	60.19	234.8	59.29	220.4	58.62	213.2	57.91	206.0	57.18	192.4	55.39
	11.0	9.8	248.4	60.73	234.8	59.81	220.4	59.15	213.2	58.42	206.0	57.67	192.4	55.90
13.0	11.8	248.4	61.24	234.8	60.32	220.4	59.64	213.2	58.91	206.0	58.16	192.4	56.37	
15.0	13.7	248.4	61.73	234.8	60.80	220.4	60.11	213.2	59.38	206.0	58.62	192.4	56.80	

Note

1. TC: Total Capacity(kW), PI: Power Input(kW, Comp. + Outdoor fan motor)
2. Capacity tables show the average value of conditions which may occur.
3. In the range beyond the operation limit of the outdoor unit, continuous operation and performance can not be guaranteed. When selecting the outdoor units, avoid the air temperature range that is not guaranteed continuous operation.

7. Capacity Tables

Combination (%)		Heating Capacity (72HP)												
		Outdoor air temp.		Indoor air temp. °C DB										
		°C DB	°C WB	16		18		20		21		22		24
		TC	PI	TC	PI	TC	PI	TC	PI	TC	PI	TC	PI	
100	-19.8	-20	114.9	54.62	114.9	56.71	114.1	58.48	114.1	61.83	114.1	64.19	114.1	65.08
	-18.8	-19	120.4	55.66	119.6	57.75	119.6	59.75	119.6	62.89	119.6	65.08	119.6	64.48
	-16.7	-17	131.3	57.85	131.3	59.96	131.3	62.40	130.5	65.08	130.5	63.92	130.5	63.21
	-13.7	-15	148.7	60.99	148.7	63.10	147.9	65.08	147.9	63.57	147.9	62.27	147.9	61.40
	-11.8	-13	157.0	63.00	156.2	65.08	156.2	64.21	156.2	62.60	156.2	61.21	156.2	60.24
	-9.8	-11	165.7	65.08	165.7	64.16	164.8	63.27	164.8	61.59	164.8	60.10	164.8	59.02
	-9.5	-10	169.7	64.97	169.7	64.03	168.9	63.14	168.9	61.43	168.9	59.94	168.9	58.85
	-8.5	-9.1	182.8	64.57	182.8	63.57	182.0	62.67	195.2	60.94	188.6	59.37	175.8	58.24
	-7.0	-7.6	206.0	63.95	205.2	62.89	201.6	61.97	195.2	60.18	188.6	58.56	175.8	57.34
	-5.0	-5.6	214.9	63.16	212.9	61.97	201.6	61.05	195.2	59.16	188.6	57.45	175.8	56.12
	-3.0	-3.7	221.2	62.35	214.6	61.05	201.6	60.13	195.2	58.15	188.6	56.34	175.8	54.91
	0.0	-0.7	227.4	61.13	214.6	59.69	201.6	58.75	195.2	56.64	188.6	54.68	175.8	53.09
	3.0	2.2	227.4	59.92	214.6	58.31	201.6	57.34	195.2	55.12	188.6	53.01	175.8	51.28
	5.0	4.1	227.4	59.13	214.6	57.40	201.6	56.42	195.2	54.12	188.6	51.90	175.8	50.06
	7.0	6	227.4	58.31	214.6	56.48	201.6	55.50	195.2	53.09	188.6	50.79	175.8	48.87
	9.0	7.9	227.4	57.50	214.6	55.69	201.6	54.74	195.2	52.36	188.6	50.11	175.8	48.19
	11.0	9.8	227.4	57.23	214.6	55.42	201.6	54.47	195.2	52.11	188.6	49.87	175.8	47.95
13.0	11.8	227.4	56.90	214.6	55.12	201.6	54.15	195.2	51.81	188.6	49.57	175.8	47.67	
15.0	13.7	227.4	56.50	214.6	54.74	201.6	53.79	195.2	51.46	188.6	49.22	175.8	47.35	
90	-19.8	-20	114.4	51.46	114.4	55.25	113.6	57.88	113.6	59.15	113.6	58.31	113.6	56.85
	-18.8	-19	120.4	52.71	119.6	56.50	119.1	59.15	119.1	58.75	119.1	57.90	119.1	56.37
	-16.7	-17	131.3	55.36	131.3	59.15	130.7	58.42	130.7	57.93	130.7	57.02	130.7	55.39
	-13.7	-15	148.7	59.15	148.7	58.20	147.1	57.39	147.1	56.74	147.1	55.77	147.1	54.01
	-11.8	-13	157.0	58.61	156.2	57.61	155.4	56.74	155.4	55.99	155.4	54.98	155.4	53.14
	-9.8	-11	165.7	58.04	165.7	56.96	164.2	56.04	164.2	55.20	164.2	54.14	164.2	52.20
	-9.5	-10	169.7	57.96	169.7	56.88	168.1	55.96	168.1	55.07	168.1	54.01	168.1	52.06
	-8.5	-9.1	182.8	57.69	181.7	56.56	181.1	55.61	178.6	54.69	173.1	53.60	160.6	51.60
	-7.0	-7.6	206.0	57.26	196.0	56.09	184.4	55.09	178.6	54.09	173.1	52.96	160.6	50.90
	-5.0	-5.6	208.2	56.69	196.0	55.45	184.4	54.39	178.6	53.30	173.1	52.12	160.6	49.98
	-3.0	-3.7	208.2	56.12	196.0	54.82	184.4	53.71	178.6	52.50	173.1	51.30	160.6	49.06
	0.0	-0.7	208.2	55.28	196.0	53.87	184.4	52.68	178.6	51.33	173.1	50.03	160.6	47.67
	3.0	2.2	208.2	54.42	196.0	52.92	184.4	51.63	178.6	50.14	173.1	48.78	160.6	46.27
	5.0	4.1	208.2	53.85	196.0	52.28	184.4	50.95	178.6	49.33	173.1	47.95	160.6	45.35
	7.0	6	208.2	53.28	196.0	51.65	184.4	50.27	178.6	48.54	173.1	47.11	160.6	44.43
	9.0	7.9	208.2	52.55	196.0	50.95	184.4	49.57	178.6	47.89	173.1	46.46	160.6	43.81
	11.0	9.8	208.2	51.82	196.0	50.22	184.4	48.89	178.6	47.22	173.1	45.81	160.6	43.21
13.0	11.8	208.2	51.09	196.0	49.52	184.4	48.19	178.6	46.54	173.1	45.16	160.6	42.59	
15.0	13.7	208.2	50.36	196.0	48.81	184.4	47.51	178.6	45.89	173.1	44.51	160.6	41.99	
80	-19.8	-20	113.2	44.75	113.2	48.54	113.2	52.46	113.2	51.65	113.2	50.44	113.2	49.14
	-18.8	-19	118.6	46.02	118.6	52.46	118.6	52.09	118.6	51.25	118.6	50.03	118.6	48.73
	-16.7	-17	130.7	52.46	130.7	51.76	130.7	51.33	130.7	50.43	130.7	49.19	130.7	47.84
	-13.7	-15	154.0	51.57	150.9	50.79	147.1	50.25	147.1	49.22	147.1	47.97	143.5	46.57
	-11.8	-13	166.5	51.00	161.7	50.19	155.4	49.57	155.4	48.48	154.3	47.21	143.5	45.78
	-9.8	-11	171.7	50.41	166.7	49.54	164.2	48.84	160.1	47.68	154.3	46.40	143.5	44.94
	-9.5	-10	172.8	50.30	167.8	49.43	165.0	48.73	160.1	47.56	154.3	46.29	143.5	44.80
	-8.5	-9.1	179.2	50.00	175.8	49.11	165.0	48.38	160.1	47.16	154.3	45.89	143.5	44.37
	-7.0	-7.6	186.4	49.57	175.8	48.62	165.0	47.83	160.1	46.56	154.3	45.29	143.5	43.75
	-5.0	-5.6	186.4	48.97	175.8	47.97	165.0	47.11	160.1	45.78	154.3	44.48	143.5	42.91
	-3.0	-3.7	186.4	48.38	175.8	47.32	165.0	46.38	160.1	44.97	154.3	43.67	143.5	42.07
	0.0	-0.7	186.4	47.48	175.8	46.35	165.0	45.29	160.1	43.78	154.3	42.45	143.5	40.80
	3.0	2.2	186.4	46.59	175.8	45.37	165.0	44.21	160.1	42.59	154.3	41.26	143.5	39.53
	5.0	4.1	186.4	45.99	175.8	44.72	165.0	43.50	160.1	41.78	154.3	40.45	143.5	38.69
	7.0	6	186.4	45.40	175.8	44.07	165.0	42.77	160.1	40.99	154.3	39.64	143.5	37.85
	9.0	7.9	186.4	42.61	175.8	41.37	165.0	40.15	160.1	38.50	154.3	37.23	143.5	35.55
	11.0	9.8	186.4	39.55	175.8	38.41	165.0	37.28	160.1	35.71	154.3	34.55	143.5	32.98
13.0	11.8	186.4	36.93	175.8	35.85	165.0	34.79	160.1	33.35	154.3	32.25	143.5	30.79	
15.0	13.7	186.4	34.76	175.8	33.76	165.0	32.76	160.1	31.38	154.3	30.35	143.5	28.99	

Note

1. TC: Total Capacity(kW), PI: Power Input(kW, Comp. + Outdoor fan motor)
2. Capacity tables show the average value of conditions which may occur.
3. In the range beyond the operation limit of the outdoor unit, continuous operation and performance can not be guaranteed. When selecting the outdoor units, avoid the air temperature range that is not guaranteed continuous operation.

7. Capacity Tables

Combination (%)	Outdoor air temp.		Heating Capacity (72HP)											
			Indoor air temp. °C DB											
	°C DB	°C WB	16		18		20		21		22		24	
		TC	PI	TC	PI	TC	PI	TC	PI	TC	PI	TC	PI	
70	-19.8	-20	113.2	47.40	113.2	48.67	113.2	47.83	113.2	46.51	113.2	45.26	113.2	43.88
	-18.8	-19	118.6	48.67	118.6	48.27	118.6	47.43	118.6	46.10	118.6	44.85	118.6	43.43
	-16.7	-17	130.7	47.92	130.7	47.43	130.7	46.54	130.7	45.18	130.7	43.96	122.7	42.50
	-13.7	-15	158.1	46.86	149.3	46.23	140.4	45.29	135.7	43.91	131.6	42.69	122.7	41.15
	-11.8	-13	158.1	46.18	149.3	45.46	140.4	44.50	135.7	43.07	131.6	41.88	122.7	40.31
	-9.8	-11	158.1	45.48	149.3	44.67	140.4	43.67	135.7	42.23	131.6	41.04	122.7	39.42
	-9.5	-10	158.1	45.37	149.3	44.54	140.4	43.53	135.7	42.10	131.6	40.91	122.7	39.28
	-8.5	-9.1	158.1	45.02	149.3	44.15	140.4	43.13	135.7	41.66	131.6	40.50	122.7	38.85
	-7.0	-7.6	158.1	44.48	149.3	43.53	140.4	42.50	135.7	41.02	131.6	39.85	122.7	38.17
	-5.0	-5.6	158.1	43.78	149.3	42.75	140.4	41.66	135.7	40.15	131.6	39.01	122.7	37.28
	-3.0	-3.7	158.1	43.07	149.3	41.94	140.4	40.83	135.7	39.31	131.6	38.17	122.7	36.38
	0.0	-0.7	158.1	42.01	149.3	40.74	140.4	39.58	135.7	38.01	131.6	36.90	122.7	35.03
	3.0	2.2	158.1	40.94	149.3	39.53	140.4	38.33	135.7	36.73	131.6	35.63	122.7	33.71
	5.0	4.1	158.1	40.23	149.3	38.74	140.4	37.50	135.7	35.87	131.6	34.79	122.7	32.81
	7.0	6	158.1	39.53	149.3	37.93	140.4	36.66	135.7	35.01	131.6	33.95	122.7	31.92
	9.0	7.9	158.1	35.68	149.3	34.25	140.4	33.11	135.7	31.62	131.6	30.65	122.7	28.83
11.0	9.8	158.1	33.22	149.3	31.89	140.4	30.83	135.7	29.43	131.6	28.54	122.7	26.83	
13.0	11.8	158.1	31.08	149.3	29.84	140.4	28.84	135.7	27.53	131.6	26.70	122.7	25.10	
15.0	13.7	158.1	29.32	149.3	28.13	140.4	27.18	135.7	25.96	131.6	25.18	122.7	23.66	
60	-19.8	-20	135.7	44.88	128.5	44.04	113.2	42.75	113.2	41.47	112.4	40.20	105.2	38.82
	-18.8	-19	135.7	44.51	128.5	43.63	118.6	42.31	116.3	41.04	112.4	39.79	105.2	38.38
	-16.7	-17	135.7	43.75	128.5	42.75	120.4	41.42	116.3	40.15	112.4	38.90	105.2	37.44
	-13.7	-15	135.7	42.64	128.5	41.50	120.4	40.15	116.3	38.88	112.4	37.63	105.2	36.09
	-11.8	-13	135.7	41.96	128.5	40.69	120.4	39.33	116.3	38.09	112.4	36.82	105.2	35.25
	-9.8	-11	135.7	41.23	128.5	39.87	120.4	38.47	116.3	37.22	112.4	35.98	105.2	34.35
	-9.5	-10	135.7	41.10	128.5	39.74	120.4	38.36	116.3	37.09	112.4	35.84	105.2	34.22
	-8.5	-9.1	135.7	40.74	128.5	39.31	120.4	37.93	116.3	36.68	112.4	35.43	105.2	33.76
	-7.0	-7.6	135.7	40.20	128.5	38.69	120.4	37.28	116.3	36.03	112.4	34.79	105.2	33.11
	-5.0	-5.6	135.7	39.47	128.5	37.85	120.4	36.44	116.3	35.19	112.4	33.95	105.2	32.21
	-3.0	-3.7	135.7	38.72	128.5	37.03	120.4	35.57	116.3	34.33	112.4	33.11	105.2	31.32
	0.0	-0.7	135.7	37.63	128.5	35.76	120.4	34.30	116.3	33.06	112.4	31.83	105.2	29.97
	3.0	2.2	135.7	36.52	128.5	34.52	120.4	33.03	116.3	31.79	112.4	30.56	105.2	28.62
	5.0	4.1	135.7	35.79	128.5	33.68	120.4	32.16	116.3	30.94	112.4	29.70	105.2	27.73
	7.0	6	135.7	35.06	128.5	32.84	120.4	31.30	116.3	30.08	112.4	28.86	105.2	26.83
	9.0	7.9	135.7	31.29	128.5	29.30	120.4	27.94	116.3	26.85	112.4	25.75	105.2	23.96
11.0	9.8	135.7	29.21	128.5	27.37	120.4	26.07	116.3	25.07	112.4	24.04	105.2	22.36	
13.0	11.8	135.7	27.37	128.5	25.64	120.4	24.44	116.3	23.48	112.4	22.53	105.2	20.95	
15.0	13.7	135.7	25.86	128.5	24.23	120.4	23.09	116.3	22.20	112.4	21.28	105.2	19.79	
50	-19.8	-20	113.2	40.20	106.9	38.79	100.3	37.49	97.2	36.14	93.9	34.92	87.5	33.59
	-18.8	-19	113.2	39.76	106.9	38.33	100.3	37.03	97.2	35.71	93.9	34.49	87.5	33.14
	-16.7	-17	113.2	38.82	106.9	37.38	100.3	36.09	97.2	34.78	93.9	33.59	87.5	32.24
	-13.7	-15	113.2	37.49	106.9	36.00	100.3	34.76	97.2	33.43	93.9	32.30	87.5	30.92
	-11.8	-13	113.2	36.65	106.9	35.11	100.3	33.92	97.2	32.59	93.9	31.51	87.5	30.10
	-9.8	-11	113.2	35.76	106.9	34.19	100.3	33.02	97.2	31.70	93.9	30.64	87.5	29.23
	-9.5	-10	113.2	35.62	106.9	34.06	100.3	32.89	97.2	31.57	93.9	30.51	87.5	29.10
	-8.5	-9.1	113.2	35.17	106.9	33.60	100.3	32.43	97.2	31.13	93.9	30.10	87.5	28.67
	-7.0	-7.6	113.2	34.51	106.9	32.92	100.3	31.76	97.2	30.46	93.9	29.45	87.5	28.02
	-5.0	-5.6	113.2	33.62	106.9	32.00	100.3	30.86	97.2	29.56	93.9	28.59	87.5	27.13
	-3.0	-3.7	113.2	32.73	106.9	31.08	100.3	29.97	97.2	28.67	93.9	27.75	87.5	26.26
	0.0	-0.7	113.2	31.40	106.9	29.70	100.3	28.64	97.2	27.34	93.9	26.47	87.5	24.96
	3.0	2.2	113.2	30.05	106.9	28.32	100.3	27.29	97.2	26.01	93.9	25.18	87.5	23.66
	5.0	4.1	113.2	29.18	106.9	27.40	100.3	26.40	97.2	25.12	93.9	24.34	87.5	22.77
	7.0	6	113.2	28.29	106.9	26.48	100.3	25.50	97.2	24.23	93.9	23.47	87.5	21.90
	9.0	7.9	113.2	25.53	106.9	23.91	100.3	23.04	97.2	21.88	93.9	21.20	87.5	19.79
11.0	9.8	113.2	23.90	106.9	22.37	100.3	21.55	97.2	20.47	93.9	19.84	87.5	18.52	
13.0	11.8	113.2	22.44	106.9	21.01	100.3	20.23	97.2	19.22	93.9	18.63	87.5	17.38	
15.0	13.7	113.2	21.23	106.9	19.87	100.3	19.14	97.2	18.19	93.9	17.63	87.5	16.44	

Note

1. TC: Total Capacity(kW), PI: Power Input(kW, Comp. + Outdoor fan motor)
2. Capacity tables show the average value of conditions which may occur.
3. In the range beyond the operation limit of the outdoor unit, continuous operation and performance can not be guaranteed. When selecting the outdoor units, avoid the air temperature range that is not guaranteed continuous operation.

7. Capacity Tables

◆ A(C)RUN740LLS5

Combination (%)	Outdoor air temp.		Heating Capacity (74HP)											
			Indoor air temp. °C DB											
	°C DB	°C WB	16		18		20		21		22		24	
		TC	PI	TC	PI	TC	PI	TC	PI	TC	PI	TC	PI	
130	-19.8	-20	120.0	51.84	120.0	53.83	119.2	55.57	119.2	58.25	119.2	60.80	119.2	64.82
	-18.8	-19	125.8	53.16	125.8	55.17	124.9	56.92	124.9	59.59	124.9	62.12	124.9	66.14
	-16.7	-17	138.0	55.98	138.0	57.99	137.2	59.71	137.2	62.40	137.2	64.94	137.2	68.95
	-13.7	-15	155.4	59.99	155.4	62.00	154.5	63.73	154.5	66.40	154.5	68.95	154.5	68.18
	-11.8	-13	164.2	62.53	164.2	64.53	163.1	66.28	163.1	68.95	163.1	68.58	163.1	67.69
	-9.8	-11	173.4	65.22	173.4	67.21	172.2	68.95	172.2	68.72	172.2	68.18	172.2	67.18
	-9.5	-10	177.6	65.62	177.6	67.61	176.5	68.95	176.5	68.69	173.7	68.12	173.7	67.11
	-8.5	-9.1	191.3	66.95	191.3	68.95	190.1	68.95	190.1	68.58	178.2	67.92	178.2	66.86
	-7.0	-7.6	212.0	68.95	212.0	69.13	210.6	68.93	210.6	68.41	210.6	67.61	193.0	66.46
	-5.0	-5.6	239.6	69.56	239.6	69.38	238.0	68.90	238.0	68.18	238.0	67.21	204.7	65.94
	-3.0	-3.7	267.2	70.16	267.2	69.64	265.5	68.89	260.4	67.95	251.3	66.81	216.3	65.43
	0.0	-0.7	267.8	71.08	267.8	69.99	267.0	68.87	260.4	67.60	251.3	66.20	233.5	64.65
	3.0	2.2	267.8	72.00	267.8	70.36	267.0	68.84	260.4	67.26	251.3	65.60	233.9	63.90
	5.0	4.1	267.8	72.60	267.8	70.61	267.0	68.81	260.4	67.03	251.3	65.20	233.9	63.39
	7.0	6	267.8	73.22	267.8	70.85	267.0	68.81	260.4	66.80	251.3	64.80	233.9	62.87
	9.0	7.9	267.8	73.92	267.8	71.54	267.0	69.47	260.4	67.44	251.3	65.43	233.9	63.48
	11.0	9.8	267.8	75.38	267.8	72.94	267.0	70.82	260.4	68.75	251.3	66.72	233.9	64.71
13.0	11.8	267.8	76.81	267.8	74.34	267.0	72.17	260.4	70.07	251.3	67.98	233.9	65.95	
15.0	13.7	267.8	78.25	267.8	75.73	267.0	73.54	260.4	71.39	251.3	69.27	233.9	67.20	
120	-19.8	-20	119.2	53.83	119.2	55.57	118.4	58.25	118.4	60.80	118.4	64.82	118.4	67.61
	-18.8	-19	124.9	55.17	124.9	56.92	124.1	59.59	124.1	62.12	124.1	66.14	124.1	68.95
	-16.7	-17	136.9	57.99	136.9	59.71	136.1	62.40	136.1	64.94	136.1	68.95	136.1	68.46
	-13.7	-15	154.3	62.00	154.3	63.73	153.4	66.40	153.4	68.95	153.4	68.32	153.4	67.75
	-11.8	-13	163.1	64.53	163.1	66.28	162.0	68.95	162.0	68.55	162.0	67.92	162.0	67.29
	-9.8	-11	172.2	67.21	172.2	68.95	171.1	68.63	171.1	68.13	171.1	67.52	171.1	66.83
	-9.5	-10	176.2	67.61	176.2	68.92	175.3	68.58	175.3	68.07	175.3	67.44	175.3	66.75
	-8.5	-9.1	189.9	68.95	189.9	68.81	188.7	68.41	188.7	67.86	183.1	67.23	183.1	66.52
	-7.0	-7.6	210.6	68.96	210.6	68.66	209.2	68.15	209.2	67.55	191.8	66.92	191.8	66.17
	-5.0	-5.6	237.9	68.98	237.9	68.44	236.5	67.83	236.5	67.12	236.5	66.51	203.2	65.68
	-3.0	-3.7	262.9	68.98	262.9	68.24	252.5	67.50	244.2	66.69	236.5	66.08	214.6	65.22
	0.0	-0.7	265.6	69.01	262.9	67.92	252.5	67.01	244.2	66.06	236.5	65.45	219.7	64.51
	3.0	2.2	265.6	69.02	262.9	67.60	252.5	66.52	244.2	65.43	236.5	64.82	219.7	63.79
	5.0	4.1	265.6	69.04	262.9	67.38	252.5	66.18	244.2	65.02	236.5	64.40	219.7	63.31
	7.0	6	265.6	69.04	262.9	67.18	252.5	65.86	244.2	64.59	236.5	63.99	219.7	62.84
	9.0	7.9	265.6	69.39	262.9	67.52	252.5	66.17	244.2	64.91	236.5	64.31	219.7	63.16
	11.0	9.8	265.6	70.41	262.9	68.50	252.5	67.15	244.2	65.86	236.5	65.25	219.7	64.08
13.0	11.8	265.6	71.42	262.9	69.47	252.5	68.12	244.2	66.80	236.5	66.17	219.7	65.00	
15.0	13.7	265.6	72.40	262.9	70.44	252.5	69.06	244.2	67.72	236.5	67.09	219.7	65.89	
110	-19.8	-20	118.4	55.57	118.4	58.25	117.8	60.80	117.8	64.82	117.8	67.61	117.8	68.95
	-18.8	-19	124.1	56.92	124.1	59.59	123.5	62.12	123.5	66.14	123.5	68.95	123.5	68.58
	-16.7	-17	136.3	59.71	136.3	62.40	135.4	64.94	135.4	68.95	135.4	68.27	135.4	67.78
	-13.7	-15	153.4	63.73	153.4	66.40	152.5	68.95	152.5	68.00	152.5	67.31	152.5	66.63
	-11.8	-13	162.2	66.28	162.2	68.95	161.1	68.33	161.1	67.40	161.1	66.69	161.1	65.91
	-9.8	-11	171.3	68.95	171.3	68.30	170.2	67.67	170.2	66.75	170.2	66.05	170.2	65.14
	-9.5	-10	175.3	68.87	175.3	68.21	174.2	67.58	174.2	66.66	174.2	65.94	174.2	65.03
	-8.5	-9.1	189.0	68.55	189.0	67.89	187.8	67.24	187.8	66.34	183.0	65.63	183.0	64.65
	-7.0	-7.6	209.4	68.09	209.4	67.40	208.1	66.75	208.1	65.86	191.9	65.14	191.9	64.08
	-5.0	-5.6	228.0	67.49	228.0	66.75	226.6	66.09	219.2	65.22	201.0	64.48	197.8	63.31
	-3.0	-3.7	241.4	66.88	241.4	66.11	226.6	65.43	219.2	64.59	211.8	63.85	197.8	62.55
	0.0	-0.7	255.3	65.97	241.4	65.14	226.6	64.45	219.2	63.62	211.8	62.87	197.8	61.41
	3.0	2.2	255.3	65.05	241.4	64.16	226.6	63.47	219.2	62.67	211.8	61.90	197.8	60.26
	5.0	4.1	255.3	64.42	241.4	63.50	226.6	62.81	219.2	62.04	211.8	61.26	197.8	59.49
	7.0	6	255.3	63.82	241.4	62.85	226.6	62.15	219.2	61.41	211.8	60.61	197.8	58.74
	9.0	7.9	255.3	63.77	241.4	62.82	226.6	62.10	219.2	61.35	211.8	60.58	197.8	58.69
	11.0	9.8	255.3	64.34	241.4	63.36	226.6	62.67	219.2	61.90	211.8	61.10	197.8	59.23
13.0	11.8	255.3	64.88	241.4	63.91	226.6	63.19	219.2	62.42	211.8	61.61	197.8	59.72	
15.0	13.7	255.3	65.40	241.4	64.42	226.6	63.68	219.2	62.91	211.8	62.10	197.8	60.18	

Note

1. TC: Total Capacity(kW), PI: Power Input(kW, Comp. + Outdoor fan motor)
2. Capacity tables show the average value of conditions which may occur.
3. In the range beyond the operation limit of the outdoor unit, continuous operation and performance can not be guaranteed. When selecting the outdoor units, avoid the air temperature range that is not guaranteed continuous operation.

7. Capacity Tables

Combination (%)		Heating Capacity (74HP)												
		Outdoor air temp.		Indoor air temp. °C DB										
		°C DB	°C WB	16		18		20		21		22		24
		TC	PI	TC	PI	TC	PI	TC	PI	TC	PI	TC	PI	
100	-19.8	-20	118.1	57.87	118.1	60.08	117.2	61.95	117.2	65.51	117.2	68.01	117.2	68.95
	-18.8	-19	123.8	58.96	122.9	61.18	122.9	63.30	122.9	66.63	122.9	68.95	122.9	68.32
	-16.7	-17	134.9	61.29	134.9	63.52	134.9	66.11	134.0	68.95	134.0	67.72	134.0	66.97
	-13.7	-15	152.8	64.62	152.8	66.85	152.0	68.95	152.0	67.35	152.0	65.97	152.0	65.05
	-11.8	-13	161.4	66.74	160.5	68.95	160.5	68.03	160.5	66.32	160.5	64.85	160.5	63.82
	-9.8	-11	170.2	68.95	170.2	67.98	169.4	67.04	169.4	65.25	169.4	63.68	169.4	62.53
	-9.5	-10	174.4	68.84	174.4	67.84	173.6	66.89	173.6	65.09	173.6	63.50	173.6	62.35
	-8.5	-9.1	187.9	68.41	187.9	67.35	187.0	66.40	200.6	64.56	193.9	62.91	180.7	61.70
	-7.0	-7.6	211.8	67.75	210.9	66.63	207.2	65.66	200.6	63.76	193.9	62.04	180.7	60.75
	-5.0	-5.6	220.9	66.91	218.8	65.66	207.2	64.68	200.6	62.68	193.9	60.86	180.7	59.46
	-3.0	-3.7	227.4	66.06	220.5	64.68	207.2	63.71	200.6	61.61	193.9	59.69	180.7	58.17
	0.0	-0.7	233.7	64.77	220.5	63.24	207.2	62.24	200.6	60.00	193.9	57.94	180.7	56.25
	3.0	2.2	233.7	63.48	220.5	61.78	207.2	60.75	200.6	58.40	193.9	56.16	180.7	54.33
	5.0	4.1	233.7	62.64	220.5	60.81	207.2	59.78	200.6	57.33	193.9	54.99	180.7	53.04
	7.0	6	233.7	61.78	220.5	59.83	207.2	58.80	200.6	56.25	193.9	53.81	180.7	51.77
	9.0	7.9	233.7	60.92	220.5	59.00	207.2	57.99	200.6	55.47	193.9	53.09	180.7	51.05
11.0	9.8	233.7	60.63	220.5	58.72	207.2	57.71	200.6	55.21	193.9	52.83	180.7	50.80	
13.0	11.8	233.7	60.29	220.5	58.39	207.2	57.37	200.6	54.89	193.9	52.52	180.7	50.51	
15.0	13.7	233.7	59.86	220.5	57.99	207.2	56.99	200.6	54.52	193.9	52.15	180.7	50.16	
90	-19.8	-20	117.5	54.51	117.5	58.53	116.7	61.32	116.7	62.67	116.7	61.78	116.7	60.23
	-18.8	-19	123.8	55.84	122.9	59.86	122.4	62.67	122.4	62.24	122.4	61.35	122.4	59.72
	-16.7	-17	134.9	58.65	134.9	62.67	134.3	61.90	134.3	61.38	134.3	60.41	134.3	58.69
	-13.7	-15	152.8	62.67	152.8	61.67	151.2	60.81	151.2	60.12	151.2	59.08	151.2	57.22
	-11.8	-13	161.4	62.10	160.5	61.03	159.7	60.12	159.7	59.32	159.7	58.25	159.7	56.30
	-9.8	-11	170.2	61.50	170.2	60.35	168.8	59.38	168.8	58.48	168.8	57.36	154.9	55.30
	-9.5	-10	174.4	61.41	174.4	60.26	172.8	59.28	172.8	58.34	172.8	57.22	158.6	55.16
	-8.5	-9.1	187.9	61.12	186.7	59.92	186.2	58.91	183.6	57.94	177.9	56.79	165.1	54.67
	-7.0	-7.6	211.8	60.66	201.5	59.43	189.6	58.37	183.6	57.31	177.9	56.11	165.1	53.93
	-5.0	-5.6	214.0	60.06	201.5	58.74	189.6	57.63	183.6	56.47	177.9	55.22	165.1	52.95
	-3.0	-3.7	214.0	59.46	201.5	58.08	189.6	56.91	183.6	55.62	177.9	54.35	165.1	51.97
	0.0	-0.7	214.0	58.57	201.5	57.08	189.6	55.81	183.6	54.38	177.9	53.01	165.1	50.51
	3.0	2.2	214.0	57.65	201.5	56.07	189.6	54.70	183.6	53.12	177.9	51.68	165.1	49.02
	5.0	4.1	214.0	57.05	201.5	55.39	189.6	53.98	183.6	52.26	177.9	50.80	165.1	48.04
	7.0	6	214.0	56.45	201.5	54.73	189.6	53.26	183.6	51.43	177.9	49.91	165.1	47.07
	9.0	7.9	214.0	55.68	201.5	53.98	189.6	52.52	183.6	50.74	177.9	49.22	165.1	46.41
11.0	9.8	214.0	54.90	201.5	53.21	189.6	51.80	183.6	50.02	177.9	48.53	165.1	45.78	
13.0	11.8	214.0	54.13	201.5	52.46	189.6	51.06	183.6	49.31	177.9	47.85	165.1	45.12	
15.0	13.7	214.0	53.35	201.5	51.72	189.6	50.34	183.6	48.62	177.9	47.16	165.1	44.49	
80	-19.8	-20	116.4	47.41	116.4	51.42	116.4	55.58	116.4	54.73	116.4	53.44	116.4	52.06
	-18.8	-19	121.8	48.75	121.8	55.58	121.8	55.19	121.8	54.30	121.8	53.01	121.8	51.62
	-16.7	-17	134.3	55.58	134.3	54.84	134.3	54.38	134.3	53.43	134.3	52.12	134.3	50.68
	-13.7	-15	158.2	54.64	155.1	53.81	151.2	53.24	151.2	52.15	151.2	50.83	147.5	49.34
	-11.8	-13	171.1	54.03	166.2	53.17	159.7	52.51	159.7	51.37	158.5	50.02	147.5	48.50
	-9.8	-11	176.5	53.40	171.3	52.48	168.8	51.74	164.5	50.51	158.5	49.16	147.5	47.61
	-9.5	-10	177.6	53.29	172.4	52.37	169.6	51.63	164.5	50.39	158.5	49.05	147.5	47.47
	-8.5	-9.1	184.2	52.98	180.7	52.03	169.6	51.25	164.5	49.96	158.5	48.62	147.5	47.01
	-7.0	-7.6	191.6	52.51	180.7	51.51	169.6	50.68	164.5	49.33	158.5	47.98	147.5	46.35
	-5.0	-5.6	191.6	51.88	180.7	50.82	169.6	49.91	164.5	48.50	158.5	47.12	147.5	45.46
	-3.0	-3.7	191.6	51.25	180.7	50.14	169.6	49.14	164.5	47.64	158.5	46.27	147.5	44.57
	0.0	-0.7	191.6	50.31	180.7	49.10	169.6	47.99	164.5	46.38	158.5	44.98	147.5	43.23
	3.0	2.2	191.6	49.36	180.7	48.07	169.6	46.84	164.5	45.12	158.5	43.71	147.5	41.88
	5.0	4.1	191.6	48.73	180.7	47.38	169.6	46.09	164.5	44.26	158.5	42.85	147.5	40.99
	7.0	6	191.6	48.10	180.7	46.69	169.6	45.32	164.5	43.43	158.5	41.99	147.5	40.10
	9.0	7.9	191.6	45.15	180.7	43.83	169.6	42.54	164.5	40.78	158.5	39.44	147.5	37.66
11.0	9.8	191.6	41.91	180.7	40.70	169.6	39.49	164.5	37.84	158.5	36.60	147.5	34.94	
13.0	11.8	191.6	39.12	180.7	37.98	169.6	36.86	164.5	35.33	158.5	34.16	147.5	32.62	
15.0	13.7	191.6	36.83	180.7	35.76	169.6	34.70	164.5	33.25	158.5	32.16	147.5	30.72	

Note

1. TC: Total Capacity(kW), PI: Power Input(kW, Comp. + Outdoor fan motor)
2. Capacity tables show the average value of conditions which may occur.
3. In the range beyond the operation limit of the outdoor unit, continuous operation and performance can not be guaranteed. When selecting the outdoor units, avoid the air temperature range that is not guaranteed continuous operation.

7. Capacity Tables

Combination (%)		Heating Capacity (74HP)												
		Outdoor air temp.		Indoor air temp. °C DB										
		°C DB	°C WB	16		18		20		21		22		24
		TC	PI	TC	PI	TC	PI	TC	PI	TC	PI	TC	PI	
70	-19.8	-20	116.4	50.22	116.4	51.56	116.4	50.68	116.4	49.28	116.4	47.95	116.4	46.49
	-18.8	-19	121.8	51.56	121.8	51.14	121.8	50.24	121.8	48.84	121.8	47.52	121.8	46.01
	-16.7	-17	134.3	50.77	134.3	50.25	134.3	49.30	134.3	47.87	134.3	46.57	126.1	45.03
	-13.7	-15	162.5	49.64	153.4	48.98	144.3	47.98	139.4	46.52	135.2	45.23	126.1	43.60
	-11.8	-13	162.5	48.93	153.4	48.16	144.3	47.15	139.4	45.63	135.2	44.37	126.1	42.71
	-9.8	-11	162.5	48.18	153.4	47.32	144.3	46.26	139.4	44.74	135.2	43.48	126.1	41.76
	-9.5	-10	162.5	48.07	153.4	47.18	144.3	46.12	139.4	44.60	135.2	43.34	126.1	41.62
	-8.5	-9.1	162.5	47.69	153.4	46.77	144.3	45.69	139.4	44.14	135.2	42.91	126.1	41.15
	-7.0	-7.6	162.5	47.12	153.4	46.12	144.3	45.03	139.4	43.45	135.2	42.22	126.1	40.44
	-5.0	-5.6	162.5	46.38	153.4	45.29	144.3	44.14	139.4	42.54	135.2	41.33	126.1	39.49
	-3.0	-3.7	162.5	45.63	153.4	44.43	144.3	43.25	139.4	41.64	135.2	40.44	126.1	38.55
	0.0	-0.7	162.5	44.51	153.4	43.16	144.3	41.93	139.4	40.27	135.2	39.10	126.1	37.12
	3.0	2.2	162.5	43.37	153.4	41.88	144.3	40.61	139.4	38.92	135.2	37.75	126.1	35.71
	5.0	4.1	162.5	42.62	153.4	41.04	144.3	39.73	139.4	38.00	135.2	36.86	126.1	34.76
	7.0	6	162.5	41.88	153.4	40.19	144.3	38.84	139.4	37.09	135.2	35.97	126.1	33.82
	9.0	7.9	162.5	37.81	153.4	36.29	144.3	35.08	139.4	33.50	135.2	32.47	126.1	30.54
11.0	9.8	162.5	35.20	153.4	33.79	144.3	32.67	139.4	31.18	135.2	30.23	126.1	28.43	
13.0	11.8	162.5	32.93	153.4	31.61	144.3	30.55	139.4	29.17	135.2	28.29	126.1	26.59	
15.0	13.7	162.5	31.06	153.4	29.80	144.3	28.80	139.4	27.51	135.2	26.68	126.1	25.07	
60	-19.8	-20	139.4	47.55	132.0	46.66	116.4	45.28	116.4	43.94	115.5	42.59	108.1	41.13
	-18.8	-19	139.4	47.15	132.0	46.22	121.8	44.83	119.6	43.48	115.5	42.15	108.1	40.66
	-16.7	-17	139.4	46.34	132.0	45.28	123.8	43.88	119.6	42.53	115.5	41.21	108.1	39.66
	-13.7	-15	139.4	45.17	132.0	43.96	123.8	42.53	119.6	41.19	115.5	39.86	108.1	38.23
	-11.8	-13	139.4	44.45	132.0	43.11	123.8	41.67	119.6	40.35	115.5	39.01	108.1	37.34
	-9.8	-11	139.4	43.67	132.0	42.24	123.8	40.76	119.6	39.44	115.5	38.11	108.1	36.39
	-9.5	-10	139.4	43.54	132.0	42.10	123.8	40.64	119.6	39.29	115.5	37.97	108.1	36.25
	-8.5	-9.1	139.4	43.16	132.0	41.65	123.8	40.18	119.6	38.86	115.5	37.54	108.1	35.77
	-7.0	-7.6	139.4	42.59	132.0	40.99	123.8	39.49	119.6	38.17	115.5	36.86	108.1	35.07
	-5.0	-5.6	139.4	41.81	132.0	40.10	123.8	38.60	119.6	37.28	115.5	35.96	108.1	34.13
	-3.0	-3.7	139.4	41.02	132.0	39.23	123.8	37.69	119.6	36.37	115.5	35.07	108.1	33.18
	0.0	-0.7	139.4	39.87	132.0	37.89	123.8	36.34	119.6	35.02	115.5	33.73	108.1	31.75
	3.0	2.2	139.4	38.69	132.0	36.57	123.8	34.99	119.6	33.67	115.5	32.38	108.1	30.32
	5.0	4.1	139.4	37.92	132.0	35.68	123.8	34.07	119.6	32.78	115.5	31.47	108.1	29.37
	7.0	6	139.4	37.14	132.0	34.79	123.8	33.16	119.6	31.87	115.5	30.58	108.1	28.43
	9.0	7.9	139.4	33.15	132.0	31.04	123.8	29.60	119.6	28.45	115.5	27.28	108.1	25.38
11.0	9.8	139.4	30.95	132.0	29.00	123.8	27.63	119.6	26.56	115.5	25.47	108.1	23.69	
13.0	11.8	139.4	29.00	132.0	27.16	123.8	25.90	119.6	24.87	115.5	23.87	108.1	22.20	
15.0	13.7	139.4	27.39	132.0	25.67	123.8	24.47	119.6	23.52	115.5	22.55	108.1	20.97	
50	-19.8	-20	116.4	42.58	109.8	41.09	103.1	39.71	99.9	38.29	96.5	36.99	89.9	35.58
	-18.8	-19	116.4	42.12	109.8	40.61	103.1	39.23	99.9	37.82	96.5	36.53	89.9	35.10
	-16.7	-17	116.4	41.12	109.8	39.60	103.1	38.23	99.9	36.84	96.5	35.59	89.9	34.15
	-13.7	-15	116.4	39.72	109.8	38.14	103.1	36.82	99.9	35.42	96.5	34.22	89.9	32.75
	-11.8	-13	116.4	38.83	109.8	37.20	103.1	35.93	99.9	34.53	96.5	33.38	89.9	31.89
	-9.8	-11	116.4	37.88	109.8	36.22	103.1	34.98	99.9	33.58	96.5	32.46	89.9	30.97
	-9.5	-10	116.4	37.74	109.8	36.08	103.1	34.84	99.9	33.44	96.5	32.32	89.9	30.83
	-8.5	-9.1	116.4	37.26	109.8	35.59	103.1	34.36	99.9	32.98	96.5	31.89	89.9	30.37
	-7.0	-7.6	116.4	36.56	109.8	34.87	103.1	33.64	99.9	32.26	96.5	31.20	89.9	29.68
	-5.0	-5.6	116.4	35.62	109.8	33.90	103.1	32.70	99.9	31.32	96.5	30.29	89.9	28.74
	-3.0	-3.7	116.4	34.67	109.8	32.92	103.1	31.75	99.9	30.37	96.5	29.40	89.9	27.82
	0.0	-0.7	116.4	33.27	109.8	31.46	103.1	30.34	99.9	28.97	96.5	28.05	89.9	26.44
	3.0	2.2	116.4	31.84	109.8	30.00	103.1	28.91	99.9	27.56	96.5	26.68	89.9	25.06
	5.0	4.1	116.4	30.91	109.8	29.03	103.1	27.97	99.9	26.62	96.5	25.78	89.9	24.12
	7.0	6	116.4	29.97	109.8	28.05	103.1	27.02	99.9	25.67	96.5	24.87	89.9	23.21
	9.0	7.9	116.4	27.05	109.8	25.33	103.1	24.41	99.9	23.18	96.5	22.46	89.9	20.96
11.0	9.8	116.4	25.32	109.8	23.70	103.1	22.83	99.9	21.69	96.5	21.02	89.9	19.62	
13.0	11.8	116.4	23.78	109.8	22.26	103.1	21.43	99.9	20.37	96.5	19.73	89.9	18.41	
15.0	13.7	116.4	22.49	109.8	21.06	103.1	20.28	99.9	19.27	96.5	18.67	89.9	17.41	

Note
 1. TC: Total Capacity(kW), PI: Power Input(kW, Comp. + Outdoor fan motor)
 2. Capacity tables show the average value of conditions which may occur.
 3. In the range beyond the operation limit of the outdoor unit, continuous operation and performance can not be guaranteed. When selecting the outdoor units, avoid the air temperature range that is not guaranteed continuous operation.

7. Capacity Tables

◆ A(C)RUN760LLS5

Combination (%)	Outdoor air temp.		Heating Capacity (76HP)											
			Indoor air temp. °C DB											
	°C DB	°C WB	16		18		20		21		22		24	
		TC	PI	TC	PI	TC	PI	TC	PI	TC	PI	TC	PI	
130	-19.8	-20	123.3	51.93	123.3	53.92	122.4	55.67	122.4	58.35	122.4	60.91	122.4	64.93
	-18.8	-19	129.1	53.26	129.1	55.27	128.3	57.02	128.3	59.70	128.3	62.23	128.3	66.26
	-16.7	-17	141.7	56.08	141.7	58.09	140.8	59.82	140.8	62.52	140.8	65.05	140.8	69.07
	-13.7	-15	159.6	60.10	159.6	62.11	158.7	63.84	158.7	66.52	158.7	69.07	158.7	68.30
	-11.8	-13	168.6	62.64	168.6	64.65	167.5	66.40	167.5	69.07	167.5	68.70	167.5	67.81
	-9.8	-11	178.0	65.33	178.0	67.32	176.8	69.07	176.8	68.84	176.8	68.30	176.8	67.29
	-9.5	-10	182.3	65.73	182.3	67.73	181.1	69.07	181.1	68.81	178.2	68.24	178.2	67.23
	-8.5	-9.1	196.4	67.06	196.4	69.07	195.2	69.07	195.2	68.70	182.9	68.04	182.9	66.97
	-7.0	-7.6	217.8	69.07	217.8	69.25	216.3	69.05	216.3	68.53	216.3	67.72	198.3	66.57
	-5.0	-5.6	246.2	69.68	246.2	69.50	244.5	69.02	244.5	68.30	244.5	67.32	210.3	66.06
	-3.0	-3.7	274.6	70.28	274.6	69.76	272.8	69.01	267.4	68.06	258.1	66.92	222.3	65.54
	0.0	-0.7	275.1	71.20	275.1	70.11	274.2	68.98	267.4	67.72	258.1	66.32	239.9	64.77
	3.0	2.2	275.1	72.12	275.1	70.48	274.2	68.96	267.4	67.37	258.1	65.71	240.3	64.01
	5.0	4.1	275.1	72.72	275.1	70.74	274.2	68.93	267.4	67.14	258.1	65.31	240.3	63.49
	7.0	6	275.1	73.35	275.1	70.97	274.2	68.92	267.4	66.91	258.1	64.91	240.3	62.98
	9.0	7.9	275.1	74.04	275.1	71.66	274.2	69.59	267.4	67.55	258.1	65.54	240.3	63.58
	11.0	9.8	275.1	75.50	275.1	73.06	274.2	70.94	267.4	68.87	258.1	66.83	240.3	64.82
13.0	11.8	275.1	76.94	275.1	74.47	274.2	72.29	267.4	70.19	258.1	68.10	240.3	66.06	
15.0	13.7	275.1	78.38	275.1	75.85	274.2	73.66	267.4	71.51	258.1	69.39	240.3	67.31	
120	-19.8	-20	122.4	53.92	122.4	55.67	121.5	58.35	121.5	60.91	121.5	64.93	121.5	67.73
	-18.8	-19	128.3	55.27	128.3	57.02	127.4	59.70	127.4	62.23	127.4	66.26	127.4	69.07
	-16.7	-17	140.6	58.09	140.6	59.82	139.7	62.52	139.7	65.05	139.7	69.07	139.7	68.58
	-13.7	-15	158.5	62.11	158.5	63.84	157.5	66.52	157.5	69.07	157.5	68.44	157.5	67.87
	-11.8	-13	167.4	64.65	167.4	66.40	166.3	69.07	166.3	68.67	166.3	68.04	166.3	67.41
	-9.8	-11	176.8	67.32	176.8	69.07	175.6	68.75	175.6	68.24	175.6	67.63	175.6	66.94
	-9.5	-10	180.9	67.73	180.9	69.04	179.9	68.70	179.9	68.18	179.9	67.55	179.9	66.86
	-8.5	-9.1	195.0	69.07	195.0	68.93	193.8	68.53	193.8	67.98	188.1	67.35	188.1	66.63
	-7.0	-7.6	216.3	69.08	216.3	68.78	214.8	68.27	214.8	67.66	197.1	67.03	197.1	66.28
	-5.0	-5.6	244.4	69.10	244.4	68.56	242.9	67.95	242.9	67.24	242.9	66.63	208.8	65.80
	-3.0	-3.7	270.0	69.10	270.0	68.35	259.3	67.61	250.8	66.81	242.9	66.20	220.6	65.33
	0.0	-0.7	272.8	69.13	270.0	68.04	259.3	67.12	250.8	66.17	242.9	65.57	225.6	64.62
	3.0	2.2	272.8	69.13	270.0	67.72	259.3	66.63	250.8	65.54	242.9	64.93	225.6	63.90
	5.0	4.1	272.8	69.16	270.0	67.50	259.3	66.29	250.8	65.13	242.9	64.51	225.6	63.42
	7.0	6	272.8	69.16	270.0	67.29	259.3	65.97	250.8	64.70	242.9	64.10	225.6	62.95
	9.0	7.9	272.8	69.50	270.0	67.63	259.3	66.29	250.8	65.02	242.9	64.41	225.6	63.27
	11.0	9.8	272.8	70.53	270.0	68.61	259.3	67.26	250.8	65.97	242.9	65.36	225.6	64.19
13.0	11.8	272.8	71.54	270.0	69.59	259.3	68.23	250.8	66.92	242.9	66.28	225.6	65.10	
15.0	13.7	272.8	72.52	270.0	70.56	259.3	69.18	250.8	67.84	242.9	67.20	225.6	66.00	
110	-19.8	-20	121.6	55.67	121.6	58.35	120.9	60.91	120.9	64.93	120.9	67.73	120.9	69.07
	-18.8	-19	127.4	57.02	127.4	59.70	126.8	62.23	126.8	66.26	126.8	69.07	126.8	68.70
	-16.7	-17	140.0	59.82	140.0	62.52	139.1	65.05	139.1	69.07	139.1	68.39	139.1	67.89
	-13.7	-15	157.6	63.84	157.6	66.52	156.7	69.07	156.7	68.12	156.7	67.43	156.7	66.75
	-11.8	-13	166.5	66.40	166.5	69.07	165.4	68.44	165.4	67.52	165.4	66.80	165.4	66.02
	-9.8	-11	175.9	69.07	175.9	68.42	174.7	67.78	174.7	66.86	174.7	66.17	174.7	65.25
	-9.5	-10	180.0	68.99	180.0	68.33	178.8	67.69	178.8	66.77	178.8	66.06	178.8	65.14
	-8.5	-9.1	194.0	68.67	194.0	68.01	192.8	67.35	192.8	66.46	187.8	65.74	187.8	64.76
	-7.0	-7.6	215.1	68.21	215.1	67.52	213.7	66.86	213.7	65.97	196.8	65.25	196.8	64.19
	-5.0	-5.6	234.1	67.61	234.1	66.86	232.7	66.20	225.1	65.34	206.1	64.59	203.1	63.41
	-3.0	-3.7	247.9	67.00	247.9	66.22	232.7	65.54	225.1	64.70	217.5	63.96	203.1	62.66
	0.0	-0.7	262.2	66.08	247.9	65.25	232.7	64.56	225.1	63.73	217.5	62.98	203.1	61.51
	3.0	2.2	262.2	65.16	247.9	64.27	232.7	63.58	225.1	62.78	217.5	62.00	203.1	60.37
	5.0	4.1	262.2	64.53	247.9	63.61	232.7	62.92	225.1	62.14	217.5	61.37	203.1	59.59
	7.0	6	262.2	63.93	247.9	62.96	232.7	62.26	225.1	61.51	217.5	60.71	203.1	58.84
	9.0	7.9	262.2	63.87	247.9	62.92	232.7	62.21	225.1	61.46	217.5	60.68	203.1	58.79
	11.0	9.8	262.2	64.45	247.9	63.47	232.7	62.78	225.1	62.00	217.5	61.20	203.1	59.33
13.0	11.8	262.2	64.99	247.9	64.01	232.7	63.30	225.1	62.52	217.5	61.72	203.1	59.82	
15.0	13.7	262.2	65.51	247.9	64.53	232.7	63.79	225.1	63.01	217.5	62.21	203.1	60.28	

Note

1. TC: Total Capacity(kW), PI: Power Input(kW, Comp. + Outdoor fan motor)

2. Capacity tables show the average value of conditions which may occur.

3. In the range beyond the operation limit of the outdoor unit, continuous operation and performance can not be guaranteed. When selecting the outdoor units, avoid the air temperature range that is not guaranteed continuous operation.

7. Capacity Tables

Combination (%)		Heating Capacity (76HP)												
		Outdoor air temp.		Indoor air temp. °C DB										
		°C DB	°C WB	16		18		20		21		22		24
		TC	PI	TC	PI	TC	PI	TC	PI	TC	PI	TC	PI	
100	-19.8	-20	121.2	57.97	121.2	60.19	120.4	62.06	120.4	65.63	120.4	68.12	120.4	69.07
	-18.8	-19	127.1	59.07	126.2	61.29	126.2	63.41	126.2	66.74	126.2	69.07	126.2	68.44
	-16.7	-17	138.5	61.40	138.5	63.64	138.5	66.23	137.7	69.07	137.7	67.84	137.7	67.09
	-13.7	-15	156.9	64.74	156.9	66.97	156.1	69.07	156.1	67.46	156.1	66.08	156.1	65.16
	-11.8	-13	165.7	66.86	164.8	69.07	164.8	68.15	164.8	66.43	164.8	64.96	164.8	63.93
	-9.8	-11	174.8	69.07	174.8	68.10	173.9	67.15	173.9	65.37	173.9	63.79	173.9	62.64
	-9.5	-10	179.1	68.96	179.1	67.95	178.2	67.01	178.2	65.20	178.2	63.61	178.2	62.46
	-8.5	-9.1	192.9	68.52	192.9	67.47	192.0	66.52	206.0	64.68	199.1	63.01	185.6	61.81
	-7.0	-7.6	217.5	67.87	216.6	66.75	212.8	65.77	206.0	63.87	199.1	62.15	185.6	60.85
	-5.0	-5.6	226.9	67.03	224.7	65.77	212.8	64.79	206.0	62.78	199.1	60.97	185.6	59.56
	-3.0	-3.7	233.5	66.17	226.5	64.79	212.8	63.81	206.0	61.72	199.1	59.79	185.6	58.27
	0.0	-0.7	240.0	64.88	226.5	63.35	212.8	62.35	206.0	60.11	199.1	58.04	185.6	56.35
	3.0	2.2	240.0	63.59	226.5	61.89	212.8	60.86	206.0	58.50	199.1	56.26	185.6	54.42
	5.0	4.1	240.0	62.75	226.5	60.91	212.8	59.88	206.0	57.43	199.1	55.08	185.6	53.13
	7.0	6	240.0	61.89	226.5	59.94	212.8	58.90	206.0	56.34	199.1	53.90	185.6	51.86
	9.0	7.9	240.0	61.03	226.5	59.10	212.8	58.09	206.0	55.57	199.1	53.18	185.6	51.14
	11.0	9.8	240.0	60.74	226.5	58.82	212.8	57.81	206.0	55.31	199.1	52.92	185.6	50.88
13.0	11.8	240.0	60.39	226.5	58.49	212.8	57.46	206.0	54.99	199.1	52.61	185.6	50.59	
15.0	13.7	240.0	59.96	226.5	58.09	212.8	57.09	206.0	54.61	199.1	52.24	185.6	50.25	
90	-19.8	-20	120.7	54.61	120.7	58.64	119.8	61.43	119.8	62.78	119.8	61.89	119.8	60.33
	-18.8	-19	127.1	55.94	126.2	59.96	125.7	62.78	125.7	62.35	125.7	61.46	125.7	59.82
	-16.7	-17	138.5	58.76	138.5	62.78	137.9	62.01	137.9	61.49	137.9	60.51	137.9	58.79
	-13.7	-15	156.9	62.78	156.9	61.77	155.3	60.91	155.3	60.22	155.3	59.19	155.3	57.32
	-11.8	-13	165.7	62.21	164.8	61.14	164.0	60.22	164.0	59.42	164.0	58.35	164.0	56.40
	-9.8	-11	174.8	61.60	174.8	60.46	173.3	59.48	173.3	58.58	173.3	57.46	159.0	55.40
	-9.5	-10	179.1	61.52	179.1	60.37	177.4	59.39	177.4	58.45	177.4	57.32	162.8	55.25
	-8.5	-9.1	192.9	61.23	191.7	60.02	191.2	59.02	188.6	58.04	182.7	56.89	169.6	54.76
	-7.0	-7.6	217.5	60.77	206.9	59.53	194.7	58.47	188.6	57.41	182.7	56.20	169.6	54.02
	-5.0	-5.6	219.8	60.17	206.9	58.85	194.7	57.73	188.6	56.57	182.7	55.31	169.6	53.04
	-3.0	-3.7	219.8	59.56	206.9	58.18	194.7	57.00	188.6	55.72	182.7	54.44	169.6	52.06
	0.0	-0.7	219.8	58.67	206.9	57.17	194.7	55.91	188.6	54.47	182.7	53.10	169.6	50.59
	3.0	2.2	219.8	57.75	206.9	56.17	194.7	54.80	188.6	53.21	182.7	51.77	169.6	49.10
	5.0	4.1	219.8	57.15	206.9	55.48	194.7	54.07	188.6	52.35	182.7	50.88	169.6	48.13
	7.0	6	219.8	56.55	206.9	54.82	194.7	53.35	188.6	51.52	182.7	49.99	169.6	47.15
	9.0	7.9	219.8	55.77	206.9	54.07	194.7	52.61	188.6	50.82	182.7	49.30	169.6	46.49
	11.0	9.8	219.8	55.00	206.9	53.30	194.7	51.89	188.6	50.11	182.7	48.62	169.6	45.85
13.0	11.8	219.8	54.22	206.9	52.55	194.7	51.14	188.6	49.39	182.7	47.93	169.6	45.20	
15.0	13.7	219.8	53.44	206.9	51.80	194.7	50.42	188.6	48.70	182.7	47.24	169.6	44.56	
80	-19.8	-20	119.5	47.49	119.5	51.51	119.5	55.68	119.5	54.82	119.5	53.53	119.5	52.15
	-18.8	-19	125.1	48.84	125.1	55.68	125.1	55.28	125.1	54.39	125.1	53.10	125.1	51.71
	-16.7	-17	137.9	55.68	137.9	54.94	137.9	54.48	137.9	53.52	137.9	52.21	137.9	50.77
	-13.7	-15	162.5	54.73	159.3	53.90	155.3	53.33	155.3	52.24	155.3	50.92	151.5	49.42
	-11.8	-13	175.7	54.13	170.7	53.27	164.0	52.61	164.0	51.46	162.8	50.11	151.5	48.58
	-9.8	-11	181.1	53.50	175.9	52.58	173.3	51.83	169.0	50.60	162.8	49.25	151.5	47.69
	-9.5	-10	182.4	53.39	177.1	52.46	174.2	51.72	169.0	50.48	162.8	49.13	151.5	47.55
	-8.5	-9.1	189.2	53.07	185.6	52.12	174.2	51.34	169.0	50.05	162.8	48.70	151.5	47.09
	-7.0	-7.6	196.8	52.61	185.6	51.60	174.2	50.77	169.0	49.42	162.8	48.07	151.5	46.43
	-5.0	-5.6	196.8	51.97	185.6	50.91	174.2	49.99	169.0	48.58	162.8	47.21	151.5	45.54
	-3.0	-3.7	196.8	51.34	185.6	50.22	174.2	49.22	169.0	47.72	162.8	46.35	151.5	44.65
	0.0	-0.7	196.8	50.39	185.6	49.19	174.2	48.07	169.0	46.46	162.8	45.06	151.5	43.30
	3.0	2.2	196.8	49.44	185.6	48.15	174.2	46.92	169.0	45.19	162.8	43.79	151.5	41.95
	5.0	4.1	196.8	48.81	185.6	47.46	174.2	46.17	169.0	44.34	162.8	42.93	151.5	41.06
	7.0	6	196.8	48.18	185.6	46.77	174.2	45.39	169.0	43.50	162.8	42.07	151.5	40.17
	9.0	7.9	196.8	45.23	185.6	43.91	174.2	42.61	169.0	40.85	162.8	39.51	151.5	37.72
	11.0	9.8	196.8	41.98	185.6	40.77	174.2	39.56	169.0	37.90	162.8	36.66	151.5	35.00
13.0	11.8	196.8	39.19	185.6	38.04	174.2	36.92	169.0	35.39	162.8	34.22	151.5	32.67	
15.0	13.7	196.8	36.89	185.6	35.82	174.2	34.76	169.0	33.30	162.8	32.21	151.5	30.77	

Note

1. TC: Total Capacity(kW), PI: Power Input(kW, Comp. + Outdoor fan motor)
2. Capacity tables show the average value of conditions which may occur.
3. In the range beyond the operation limit of the outdoor unit, continuous operation and performance can not be guaranteed. When selecting the outdoor units, avoid the air temperature range that is not guaranteed continuous operation.

7. Capacity Tables

Combination (%)		Heating Capacity (76HP)												
		Outdoor air temp.		Indoor air temp. °C DB										
		°C DB	°C WB	16		18		20		21		22		24
		TC	PI	TC	PI	TC	PI	TC	PI	TC	PI	TC	PI	
70	-19.8	-20	119.5	50.31	119.5	51.66	119.5	50.77	119.5	49.36	119.5	48.04	119.5	46.57
	-18.8	-19	125.1	51.66	125.1	51.23	125.1	50.33	125.1	48.92	125.1	47.60	125.1	46.09
	-16.7	-17	137.9	50.86	137.9	50.34	137.9	49.39	137.9	47.95	137.9	46.66	129.5	45.11
	-13.7	-15	166.9	49.73	157.6	49.07	148.2	48.07	143.2	46.60	138.9	45.31	129.5	43.67
	-11.8	-13	166.9	49.02	157.6	48.24	148.2	47.23	143.2	45.71	138.9	44.45	129.5	42.78
	-9.8	-11	166.9	48.27	157.6	47.40	148.2	46.34	143.2	44.82	138.9	43.56	129.5	41.83
	-9.5	-10	166.9	48.15	157.6	47.27	148.2	46.20	143.2	44.68	138.9	43.42	129.5	41.69
	-8.5	-9.1	166.9	47.78	157.6	46.86	148.2	45.77	143.2	44.22	138.9	42.98	129.5	41.23
	-7.0	-7.6	166.9	47.21	157.6	46.20	148.2	45.11	143.2	43.53	138.9	42.30	129.5	40.51
	-5.0	-5.6	166.9	46.46	157.6	45.36	148.2	44.22	143.2	42.61	138.9	41.40	129.5	39.56
	-3.0	-3.7	166.9	45.71	157.6	44.51	148.2	43.33	143.2	41.72	138.9	40.51	129.5	38.61
	0.0	-0.7	166.9	44.59	157.6	43.24	148.2	42.01	143.2	40.34	138.9	39.16	129.5	37.18
	3.0	2.2	166.9	43.44	157.6	41.95	148.2	40.68	143.2	38.98	138.9	37.81	129.5	35.77
	5.0	4.1	166.9	42.70	157.6	41.11	148.2	39.79	143.2	38.07	138.9	36.92	129.5	34.82
	7.0	6	166.9	41.95	157.6	40.26	148.2	38.91	143.2	37.15	138.9	36.03	129.5	33.87
	9.0	7.9	166.9	37.87	157.6	36.35	148.2	35.14	143.2	33.56	138.9	32.53	129.5	30.60
	11.0	9.8	166.9	35.26	157.6	33.85	148.2	32.72	143.2	31.23	138.9	30.29	129.5	28.48
13.0	11.8	166.9	32.99	157.6	31.66	148.2	30.60	143.2	29.22	138.9	28.33	129.5	26.64	
15.0	13.7	166.9	31.11	157.6	29.85	148.2	28.85	143.2	27.55	138.9	26.72	129.5	25.11	
60	-19.8	-20	143.2	47.63	135.6	46.74	119.5	45.36	119.5	44.01	118.7	42.67	111.0	41.20
	-18.8	-19	143.2	47.23	135.6	46.31	125.1	44.91	122.8	43.56	118.7	42.23	111.0	40.73
	-16.7	-17	143.2	46.43	135.6	45.36	127.1	43.96	122.8	42.61	118.7	41.28	111.0	39.73
	-13.7	-15	143.2	45.25	135.6	44.04	127.1	42.61	122.8	41.26	118.7	39.93	111.0	38.30
	-11.8	-13	143.2	44.53	135.6	43.18	127.1	41.74	122.8	40.42	118.7	39.07	111.0	37.41
	-9.8	-11	143.2	43.75	135.6	42.32	127.1	40.83	122.8	39.51	118.7	38.18	111.0	36.46
	-9.5	-10	143.2	43.62	135.6	42.17	127.1	40.71	122.8	39.36	118.7	38.04	111.0	36.31
	-8.5	-9.1	143.2	43.24	135.6	41.72	127.1	40.25	122.8	38.93	118.7	37.60	111.0	35.83
	-7.0	-7.6	143.2	42.66	135.6	41.06	127.1	39.56	122.8	38.24	118.7	36.92	111.0	35.13
	-5.0	-5.6	143.2	41.88	135.6	40.17	127.1	38.67	122.8	37.35	118.7	36.03	111.0	34.19
	-3.0	-3.7	143.2	41.09	135.6	39.30	127.1	37.75	122.8	36.43	118.7	35.13	111.0	33.24
	0.0	-0.7	143.2	39.93	135.6	37.95	127.1	36.40	122.8	35.08	118.7	33.78	111.0	31.81
	3.0	2.2	143.2	38.76	135.6	36.63	127.1	35.05	122.8	33.73	118.7	32.44	111.0	30.37
	5.0	4.1	143.2	37.98	135.6	35.74	127.1	34.13	122.8	32.84	118.7	31.52	111.0	29.42
	7.0	6	143.2	37.21	135.6	34.85	127.1	33.22	122.8	31.92	118.7	30.63	111.0	28.48
	9.0	7.9	143.2	33.21	135.6	31.09	127.1	29.65	122.8	28.50	118.7	27.33	111.0	25.42
	11.0	9.8	143.2	31.00	135.6	29.04	127.1	27.67	122.8	26.61	118.7	25.52	111.0	23.73
13.0	11.8	143.2	29.05	135.6	27.21	127.1	25.94	122.8	24.91	118.7	23.91	111.0	22.24	
15.0	13.7	143.2	27.44	135.6	25.71	127.1	24.51	122.8	23.56	118.7	22.59	111.0	21.01	
50	-19.8	-20	119.5	42.66	112.8	41.17	105.8	39.78	102.6	38.36	99.1	37.05	92.4	35.65
	-18.8	-19	119.5	42.20	112.8	40.68	105.8	39.30	102.6	37.89	99.1	36.60	92.4	35.17
	-16.7	-17	119.5	41.20	112.8	39.67	105.8	38.30	102.6	36.91	99.1	35.65	92.4	34.21
	-13.7	-15	119.5	39.79	112.8	38.20	105.8	36.89	102.6	35.48	99.1	34.28	92.4	32.81
	-11.8	-13	119.5	38.89	112.8	37.26	105.8	35.99	102.6	34.59	99.1	33.44	92.4	31.94
	-9.8	-11	119.5	37.95	112.8	36.29	105.8	35.04	102.6	33.64	99.1	32.52	92.4	31.02
	-9.5	-10	119.5	37.81	112.8	36.14	105.8	34.90	102.6	33.50	99.1	32.38	92.4	30.88
	-8.5	-9.1	119.5	37.32	112.8	35.66	105.8	34.42	102.6	33.04	99.1	31.94	92.4	30.42
	-7.0	-7.6	119.5	36.63	112.8	34.93	105.8	33.70	102.6	32.32	99.1	31.26	92.4	29.73
	-5.0	-5.6	119.5	35.68	112.8	33.96	105.8	32.75	102.6	31.37	99.1	30.34	92.4	28.79
	-3.0	-3.7	119.5	34.73	112.8	32.98	105.8	31.81	102.6	30.43	99.1	29.45	92.4	27.87
	0.0	-0.7	119.5	33.32	112.8	31.52	105.8	30.39	102.6	29.02	99.1	28.09	92.4	26.49
	3.0	2.2	119.5	31.89	112.8	30.05	105.8	28.96	102.6	27.61	99.1	26.72	92.4	25.11
	5.0	4.1	119.5	30.97	112.8	29.08	105.8	28.01	102.6	26.66	99.1	25.83	92.4	24.17
	7.0	6	119.5	30.02	112.8	28.10	105.8	27.07	102.6	25.71	99.1	24.91	92.4	23.24
	9.0	7.9	119.5	27.10	112.8	25.37	105.8	24.45	102.6	23.22	99.1	22.50	92.4	21.00
	11.0	9.8	119.5	25.37	112.8	23.74	105.8	22.87	102.6	21.72	99.1	21.06	92.4	19.65
13.0	11.8	119.5	23.82	112.8	22.30	105.8	21.47	102.6	20.40	99.1	19.77	92.4	18.45	
15.0	13.7	119.5	22.53	112.8	21.09	105.8	20.32	102.6	19.31	99.1	18.70	92.4	17.44	

Note

1. TC: Total Capacity(kW), PI: Power Input(kW, Comp. + Outdoor fan motor)
2. Capacity tables show the average value of conditions which may occur.
3. In the range beyond the operation limit of the outdoor unit, continuous operation and performance can not be guaranteed. When selecting the outdoor units, avoid the air temperature range that is not guaranteed continuous operation.

7. Capacity Tables

◆ A(C)RUN780LLS5

Combination (%)	Outdoor air temp.		Heating Capacity (78HP)											
			Indoor air temp. °C DB											
	°C DB	°C WB	16		18		20		21		22		24	
		TC	PI	TC	PI	TC	PI	TC	PI	TC	PI	TC	PI	
130	-19.8	-20	126.6	54.24	126.6	56.31	125.7	58.14	125.7	60.93	125.7	63.60	125.7	67.80
	-18.8	-19	132.6	55.62	132.6	57.72	131.7	59.55	131.7	62.34	131.7	64.98	131.7	69.18
	-16.7	-17	145.5	58.56	145.5	60.66	144.6	62.46	144.6	65.28	144.6	67.92	144.6	72.12
	-13.7	-15	163.8	62.76	163.8	64.86	162.9	66.66	162.9	69.45	162.9	72.12	162.9	71.31
	-11.8	-13	173.1	65.40	173.1	67.50	171.9	69.33	171.9	72.12	171.9	71.73	171.9	70.80
	-9.8	-11	182.7	68.22	182.7	70.29	181.5	72.12	181.5	71.88	181.5	71.31	181.5	70.26
	-9.5	-10	187.2	68.64	187.2	70.71	186.0	72.12	186.0	71.85	183.0	71.25	183.0	70.20
	-8.5	-9.1	201.6	70.02	201.6	72.12	200.4	72.12	200.4	71.73	187.8	71.04	187.8	69.93
	-7.0	-7.6	223.5	72.12	223.5	72.30	222.0	72.09	222.0	71.55	222.0	70.71	203.4	69.51
	-5.0	-5.6	252.6	72.75	252.6	72.57	250.8	72.06	250.8	71.31	250.8	70.29	215.7	68.97
	-3.0	-3.7	281.7	73.38	281.7	72.84	279.9	72.06	274.5	71.07	264.9	69.87	228.0	68.43
	0.0	-0.7	282.3	74.34	282.3	73.20	281.4	72.03	274.5	70.71	264.9	69.24	246.0	67.62
	3.0	2.2	282.3	75.30	282.3	73.59	281.4	72.00	274.5	70.35	264.9	68.61	246.6	66.84
	5.0	4.1	282.3	75.93	282.3	73.86	281.4	71.97	274.5	70.11	264.9	68.19	246.6	66.30
	7.0	6	282.3	76.59	282.3	74.10	281.4	71.97	274.5	69.87	264.9	67.77	246.6	65.76
	9.0	7.9	282.3	77.31	282.3	74.82	281.4	72.66	274.5	70.53	264.9	68.43	246.6	66.39
	11.0	9.8	282.3	78.84	282.3	76.29	281.4	74.07	274.5	71.91	264.9	69.78	246.6	67.68
	13.0	11.8	282.3	80.34	282.3	77.76	281.4	75.48	274.5	73.29	264.9	71.10	246.6	68.97
15.0	13.7	282.3	81.84	282.3	79.20	281.4	76.92	274.5	74.67	264.9	72.45	246.6	70.29	
120	-19.8	-20	125.7	56.31	125.7	58.14	124.8	60.93	124.8	63.60	124.8	67.80	124.8	70.71
	-18.8	-19	131.7	57.72	131.7	59.55	130.8	62.34	130.8	64.98	130.8	69.18	130.8	72.12
	-16.7	-17	144.3	60.66	144.3	62.46	143.4	65.28	143.4	67.92	143.4	72.12	143.4	71.61
	-13.7	-15	162.6	64.86	162.6	66.66	161.7	69.45	161.7	72.12	161.7	71.46	161.7	70.86
	-11.8	-13	171.9	67.50	171.9	69.33	170.7	72.12	170.7	71.70	170.7	71.04	170.7	70.38
	-9.8	-11	181.5	70.29	181.5	72.12	180.3	71.79	180.3	71.25	180.3	70.62	180.3	69.90
	-9.5	-10	185.7	70.71	185.7	72.09	184.8	71.73	184.8	71.19	184.8	70.53	184.8	69.81
	-8.5	-9.1	200.1	72.12	200.1	71.97	198.9	71.55	198.9	70.98	192.9	70.32	192.9	69.57
	-7.0	-7.6	222.0	72.12	222.0	71.82	220.5	71.28	220.5	70.65	202.2	69.99	202.2	69.21
	-5.0	-5.6	250.8	72.15	250.8	71.58	249.3	70.95	249.3	70.20	249.3	69.57	214.2	68.70
	-3.0	-3.7	277.2	72.15	277.2	71.37	266.1	70.59	257.4	69.75	249.3	69.12	226.2	68.22
	0.0	-0.7	279.9	72.18	277.2	71.04	266.1	70.08	257.4	69.09	249.3	68.46	231.6	67.47
	3.0	2.2	279.9	72.18	277.2	70.71	266.1	69.57	257.4	68.43	249.3	67.80	231.6	66.72
	5.0	4.1	279.9	72.21	277.2	70.47	266.1	69.21	257.4	68.01	249.3	67.35	231.6	66.21
	7.0	6	279.9	72.21	277.2	70.26	266.1	68.88	257.4	67.56	249.3	66.93	231.6	65.73
	9.0	7.9	279.9	72.57	277.2	70.62	266.1	69.21	257.4	67.89	249.3	67.26	231.6	66.06
	11.0	9.8	279.9	73.65	277.2	71.64	266.1	70.23	257.4	68.88	249.3	68.25	231.6	67.02
	13.0	11.8	279.9	74.70	277.2	72.66	266.1	71.25	257.4	69.87	249.3	69.21	231.6	67.98
15.0	13.7	279.9	75.72	277.2	73.68	266.1	72.24	257.4	70.83	249.3	70.17	231.6	68.91	
110	-19.8	-20	124.8	58.14	124.8	60.93	124.2	63.60	124.2	67.80	124.2	70.71	124.2	72.12
	-18.8	-19	130.8	59.55	130.8	62.34	130.2	64.98	130.2	69.18	130.2	72.12	130.2	71.73
	-16.7	-17	143.7	62.46	143.7	65.28	142.8	67.92	142.8	72.12	142.8	71.40	142.8	70.89
	-13.7	-15	161.7	66.66	161.7	69.45	160.8	72.12	160.8	71.13	160.8	70.41	160.8	69.69
	-11.8	-13	171.0	69.33	171.0	72.12	169.8	71.46	169.8	70.50	169.8	69.75	169.8	68.94
	-9.8	-11	180.6	72.12	180.6	71.43	179.4	70.77	179.4	69.81	179.4	69.09	179.4	68.13
	-9.5	-10	184.8	72.03	184.8	71.34	183.6	70.68	183.6	69.72	183.6	68.97	183.6	68.01
	-8.5	-9.1	199.2	71.70	199.2	71.01	198.0	70.32	198.0	69.39	192.9	68.64	192.9	67.62
	-7.0	-7.6	220.8	71.22	220.8	70.50	219.3	69.81	219.3	68.88	202.2	68.13	202.2	67.02
	-5.0	-5.6	240.3	70.59	240.3	69.81	238.8	69.12	231.0	68.22	211.8	67.44	208.5	66.21
	-3.0	-3.7	254.4	69.96	254.4	69.15	238.8	68.43	231.0	67.56	223.2	66.78	208.5	65.43
	0.0	-0.7	269.1	69.00	254.4	68.13	238.8	67.41	231.0	66.54	223.2	65.76	208.5	64.23
	3.0	2.2	269.1	68.04	254.4	67.11	238.8	66.39	231.0	65.55	223.2	64.74	208.5	63.03
	5.0	4.1	269.1	67.38	254.4	66.42	238.8	65.70	231.0	64.89	223.2	64.08	208.5	62.22
	7.0	6	269.1	66.75	254.4	65.73	238.8	65.01	231.0	64.23	223.2	63.39	208.5	61.44
	9.0	7.9	269.1	66.69	254.4	65.70	238.8	64.95	231.0	64.17	223.2	63.36	208.5	61.38
	11.0	9.8	269.1	67.29	254.4	66.27	238.8	65.55	231.0	64.74	223.2	63.90	208.5	61.95
	13.0	11.8	269.1	67.86	254.4	66.84	238.8	66.09	231.0	65.28	223.2	64.44	208.5	62.46
15.0	13.7	269.1	68.40	254.4	67.38	238.8	66.60	231.0	65.79	223.2	64.95	208.5	62.94	

Note

1. TC: Total Capacity(kW), PI : Power Input(kW, Comp. + Outdoor fan motor)
2. Capacity tables show the average value of conditions which may occur.
3. In the range beyond the operation limit of the outdoor unit, continuous operation and performance can not be guaranteed. When selecting the outdoor units, avoid the air temperature range that is not guaranteed continuous operation.

7. Capacity Tables

Combination (%)		Heating Capacity (78HP)												
		Outdoor air temp.		Indoor air temp. °C DB										
		°C DB	°C WB	16		18		20		21		22		24
		TC	PI	TC	PI	TC	PI	TC	PI	TC	PI	TC	PI	
100	-19.8	-20	124.5	60.54	124.5	62.85	123.6	64.80	123.6	68.52	123.6	71.13	123.6	72.12
	-18.8	-19	130.5	61.68	129.6	63.99	129.6	66.21	129.6	69.69	129.6	72.12	129.6	71.46
	-16.7	-17	142.2	64.11	142.2	66.45	142.2	69.15	141.3	72.12	141.3	70.83	141.3	70.05
	-13.7	-15	161.1	67.59	161.1	69.93	160.2	72.12	160.2	70.44	160.2	69.00	160.2	68.04
	-11.8	-13	170.1	69.81	169.2	72.12	169.2	71.16	169.2	69.36	169.2	67.83	169.2	66.75
	-9.8	-11	179.4	72.12	179.4	71.10	178.5	70.11	178.5	68.25	178.5	66.60	178.5	65.40
	-9.5	-10	183.9	72.00	183.9	70.95	183.0	69.96	183.0	68.07	183.0	66.42	183.0	65.22
	-8.5	-9.1	198.0	71.55	198.0	70.44	197.1	69.45	211.5	67.53	204.3	65.79	190.5	64.53
	-7.0	-7.6	223.2	70.86	222.3	69.69	218.4	68.67	211.5	66.69	204.3	64.89	190.5	63.54
	-5.0	-5.6	232.8	69.99	230.7	68.67	218.4	67.65	211.5	65.55	204.3	63.66	190.5	62.19
	-3.0	-3.7	239.7	69.09	232.5	67.65	218.4	66.63	211.5	64.44	204.3	62.43	190.5	60.84
	0.0	-0.7	246.3	67.74	232.5	66.15	218.4	65.10	211.5	62.76	204.3	60.60	190.5	58.83
	3.0	2.2	246.3	66.39	232.5	64.62	218.4	63.54	211.5	61.08	204.3	58.74	190.5	56.82
	5.0	4.1	246.3	65.52	232.5	63.60	218.4	62.52	211.5	59.97	204.3	57.51	190.5	55.47
	7.0	6	246.3	64.62	232.5	62.58	218.4	61.50	211.5	58.83	204.3	56.28	190.5	54.15
	9.0	7.9	246.3	63.72	232.5	61.71	218.4	60.66	211.5	58.02	204.3	55.53	190.5	53.40
11.0	9.8	246.3	63.42	232.5	61.41	218.4	60.36	211.5	57.75	204.3	55.26	190.5	53.13	
13.0	11.8	246.3	63.06	232.5	61.08	218.4	60.00	211.5	57.42	204.3	54.93	190.5	52.83	
15.0	13.7	246.3	62.61	232.5	60.66	218.4	59.61	211.5	57.03	204.3	54.54	190.5	52.47	
90	-19.8	-20	123.9	57.03	123.9	61.23	123.0	64.14	123.0	65.55	123.0	64.62	123.0	63.00
	-18.8	-19	130.5	58.41	129.6	62.61	129.0	65.55	129.0	65.10	129.0	64.17	129.0	62.46
	-16.7	-17	142.2	61.35	142.2	65.55	141.6	64.74	141.6	64.20	141.6	63.18	141.6	61.38
	-13.7	-15	161.1	65.55	161.1	64.50	159.3	63.60	159.3	62.88	159.3	61.80	159.3	59.85
	-11.8	-13	170.1	64.95	169.2	63.84	168.3	62.88	168.3	62.04	168.3	60.93	168.3	58.89
	-9.8	-11	179.4	64.32	179.4	63.12	177.9	62.10	177.9	61.17	177.9	60.00	163.2	57.84
	-9.5	-10	183.9	64.23	183.9	63.03	182.1	62.01	182.1	61.02	182.1	59.85	167.1	57.69
	-8.5	-9.1	198.0	63.93	196.8	62.67	196.2	61.62	193.5	60.60	187.5	59.40	174.0	57.18
	-7.0	-7.6	223.2	63.45	212.4	62.16	199.8	61.05	193.5	59.94	187.5	58.68	174.0	56.40
	-5.0	-5.6	225.6	62.82	212.4	61.44	199.8	60.27	193.5	59.07	187.5	57.75	174.0	55.38
	-3.0	-3.7	225.6	62.19	212.4	60.75	199.8	59.52	193.5	58.17	187.5	56.85	174.0	54.36
	0.0	-0.7	225.6	61.26	212.4	59.70	199.8	58.38	193.5	56.88	187.5	55.44	174.0	52.83
	3.0	2.2	225.6	60.30	212.4	58.65	199.8	57.21	193.5	55.56	187.5	54.06	174.0	51.27
	5.0	4.1	225.6	59.67	212.4	57.93	199.8	56.46	193.5	54.66	187.5	53.13	174.0	50.25
	7.0	6	225.6	59.04	212.4	57.24	199.8	55.71	193.5	53.79	187.5	52.20	174.0	49.23
	9.0	7.9	225.6	58.23	212.4	56.46	199.8	54.93	193.5	53.07	187.5	51.48	174.0	48.54
11.0	9.8	225.6	57.42	212.4	55.65	199.8	54.18	193.5	52.32	187.5	50.76	174.0	47.88	
13.0	11.8	225.6	56.61	212.4	54.87	199.8	53.40	193.5	51.57	187.5	50.04	174.0	47.19	
15.0	13.7	225.6	55.80	212.4	54.09	199.8	52.65	193.5	50.85	187.5	49.32	174.0	46.53	
80	-19.8	-20	122.7	49.59	122.7	53.79	122.7	58.14	122.7	57.24	122.7	55.89	122.7	54.45
	-18.8	-19	128.4	51.00	128.4	58.14	128.4	57.72	128.4	56.79	128.4	55.44	128.4	54.00
	-16.7	-17	141.6	58.14	141.6	57.36	141.6	56.88	141.6	55.89	141.6	54.51	141.6	53.01
	-13.7	-15	166.8	57.15	163.5	56.28	159.3	55.68	159.3	54.54	159.3	53.16	155.4	51.60
	-11.8	-13	180.3	56.52	175.2	55.62	168.3	54.93	168.3	53.73	167.1	52.32	155.4	50.73
	-9.8	-11	186.0	55.86	180.6	54.90	177.9	54.12	173.4	52.83	167.1	51.42	155.4	49.80
	-9.5	-10	187.2	55.74	181.8	54.78	178.8	54.00	173.4	52.71	167.1	51.30	155.4	49.65
	-8.5	-9.1	194.1	55.41	190.5	54.42	178.8	53.61	173.4	52.26	167.1	50.85	155.4	49.17
	-7.0	-7.6	201.9	54.93	190.5	53.88	178.8	53.01	173.4	51.60	167.1	50.19	155.4	48.48
	-5.0	-5.6	201.9	54.27	190.5	53.16	178.8	52.20	173.4	50.73	167.1	49.29	155.4	47.55
	-3.0	-3.7	201.9	53.61	190.5	52.44	178.8	51.39	173.4	49.83	167.1	48.39	155.4	46.62
	0.0	-0.7	201.9	52.62	190.5	51.36	178.8	50.19	173.4	48.51	167.1	47.04	155.4	45.21
	3.0	2.2	201.9	51.63	190.5	50.28	178.8	48.99	173.4	47.19	167.1	45.72	155.4	43.80
	5.0	4.1	201.9	50.97	190.5	49.56	178.8	48.21	173.4	46.29	167.1	44.82	155.4	42.87
	7.0	6	201.9	50.31	190.5	48.84	178.8	47.40	173.4	45.42	167.1	43.92	155.4	41.94
	9.0	7.9	201.9	47.22	190.5	45.84	178.8	44.49	173.4	42.66	167.1	41.25	155.4	39.39
11.0	9.8	201.9	43.83	190.5	42.57	178.8	41.31	173.4	39.57	167.1	38.28	155.4	36.54	
13.0	11.8	201.9	40.92	190.5	39.72	178.8	38.55	173.4	36.96	167.1	35.73	155.4	34.11	
15.0	13.7	201.9	38.52	190.5	37.41	178.8	36.30	173.4	34.77	167.1	33.63	155.4	32.13	

Note

1. TC: Total Capacity(kW), PI: Power Input(kW, Comp. + Outdoor fan motor)
2. Capacity tables show the average value of conditions which may occur.
3. In the range beyond the operation limit of the outdoor unit, continuous operation and performance can not be guaranteed. When selecting the outdoor units, avoid the air temperature range that is not guaranteed continuous operation.

7. Capacity Tables

Combination (%)		Heating Capacity (78HP)												
		Outdoor air temp.		Indoor air temp. °C DB										
		°C DB	°C WB	16		18		20		21		22		24
		TC	PI	TC	PI	TC	PI	TC	PI	TC	PI	TC	PI	
70	-19.8	-20	122.7	52.53	122.7	53.94	122.7	53.01	122.7	51.54	122.7	50.16	122.7	48.63
	-18.8	-19	128.4	53.94	128.4	53.49	128.4	52.56	128.4	51.09	128.4	49.71	128.4	48.12
	-16.7	-17	141.6	53.10	141.6	52.56	141.6	51.57	141.6	50.07	141.6	48.72	132.9	47.10
	-13.7	-15	171.3	51.93	161.7	51.24	152.1	50.19	147.0	48.66	142.5	47.31	132.9	45.60
	-11.8	-13	171.3	51.18	161.7	50.37	152.1	49.32	147.0	47.73	142.5	46.41	132.9	44.67
	-9.8	-11	171.3	50.40	161.7	49.50	152.1	48.39	147.0	46.80	142.5	45.48	132.9	43.68
	-9.5	-10	171.3	50.28	161.7	49.35	152.1	48.24	147.0	46.65	142.5	45.33	132.9	43.53
	-8.5	-9.1	171.3	49.89	161.7	48.93	152.1	47.79	147.0	46.17	142.5	44.88	132.9	43.05
	-7.0	-7.6	171.3	49.29	161.7	48.24	152.1	47.10	147.0	45.45	142.5	44.16	132.9	42.30
	-5.0	-5.6	171.3	48.51	161.7	47.37	152.1	46.17	147.0	44.49	142.5	43.23	132.9	41.31
	-3.0	-3.7	171.3	47.73	161.7	46.47	152.1	45.24	147.0	43.56	142.5	42.30	132.9	40.32
	0.0	-0.7	171.3	46.56	161.7	45.15	152.1	43.86	147.0	42.12	142.5	40.89	132.9	38.82
	3.0	2.2	171.3	45.36	161.7	43.80	152.1	42.48	147.0	40.71	142.5	39.48	132.9	37.35
	5.0	4.1	171.3	44.58	161.7	42.93	152.1	41.55	147.0	39.75	142.5	38.55	132.9	36.36
	7.0	6	171.3	43.80	161.7	42.03	152.1	40.62	147.0	38.79	142.5	37.62	132.9	35.37
	9.0	7.9	171.3	39.54	161.7	37.95	152.1	36.69	147.0	35.04	142.5	33.96	132.9	31.95
11.0	9.8	171.3	36.81	161.7	35.34	152.1	34.17	147.0	32.61	142.5	31.62	132.9	29.73	
13.0	11.8	171.3	34.44	161.7	33.06	152.1	31.95	147.0	30.51	142.5	29.58	132.9	27.81	
15.0	13.7	171.3	32.49	161.7	31.17	152.1	30.12	147.0	28.77	142.5	27.90	132.9	26.22	
60	-19.8	-20	147.0	49.74	139.2	48.81	122.7	47.37	122.7	45.96	121.8	44.55	114.0	43.02
	-18.8	-19	147.0	49.32	139.2	48.36	128.4	46.89	126.0	45.48	121.8	44.10	114.0	42.54
	-16.7	-17	147.0	48.48	139.2	47.37	130.5	45.90	126.0	44.49	121.8	43.11	114.0	41.49
	-13.7	-15	147.0	47.25	139.2	45.99	130.5	44.49	126.0	43.08	121.8	41.70	114.0	39.99
	-11.8	-13	147.0	46.50	139.2	45.09	130.5	43.59	126.0	42.21	121.8	40.80	114.0	39.06
	-9.8	-11	147.0	45.69	139.2	44.19	130.5	42.63	126.0	41.25	121.8	39.87	114.0	38.07
	-9.5	-10	147.0	45.54	139.2	44.04	130.5	42.51	126.0	41.10	121.8	39.72	114.0	37.92
	-8.5	-9.1	147.0	45.15	139.2	43.56	130.5	42.03	126.0	40.65	121.8	39.27	114.0	37.41
	-7.0	-7.6	147.0	44.55	139.2	42.87	130.5	41.31	126.0	39.93	121.8	38.55	114.0	36.69
	-5.0	-5.6	147.0	43.74	139.2	41.94	130.5	40.38	126.0	39.00	121.8	37.62	114.0	35.70
	-3.0	-3.7	147.0	42.90	139.2	41.04	130.5	39.42	126.0	38.04	121.8	36.69	114.0	34.71
	0.0	-0.7	147.0	41.70	139.2	39.63	130.5	38.01	126.0	36.63	121.8	35.28	114.0	33.21
	3.0	2.2	147.0	40.47	139.2	38.25	130.5	36.60	126.0	35.22	121.8	33.87	114.0	31.71
	5.0	4.1	147.0	39.66	139.2	37.32	130.5	35.64	126.0	34.29	121.8	32.91	114.0	30.72
	7.0	6	147.0	38.85	139.2	36.39	130.5	34.68	126.0	33.33	121.8	31.98	114.0	29.73
	9.0	7.9	147.0	34.68	139.2	32.46	130.5	30.96	126.0	29.76	121.8	28.53	114.0	26.55
11.0	9.8	147.0	32.37	139.2	30.33	130.5	28.89	126.0	27.78	121.8	26.64	114.0	24.78	
13.0	11.8	147.0	30.33	139.2	28.41	130.5	27.09	126.0	26.01	121.8	24.96	114.0	23.22	
15.0	13.7	147.0	28.65	139.2	26.85	130.5	25.59	126.0	24.60	121.8	23.58	114.0	21.93	
50	-19.8	-20	122.7	44.55	115.8	42.99	108.6	41.55	105.3	40.05	101.7	38.70	94.8	37.23
	-18.8	-19	122.7	44.07	115.8	42.48	108.6	41.04	105.3	39.57	101.7	38.22	94.8	36.72
	-16.7	-17	122.7	43.02	115.8	41.43	108.6	39.99	105.3	38.55	101.7	37.23	94.8	35.73
	-13.7	-15	122.7	41.55	115.8	39.90	108.6	38.52	105.3	37.05	101.7	35.79	94.8	34.26
	-11.8	-13	122.7	40.62	115.8	38.91	108.6	37.59	105.3	36.12	101.7	34.92	94.8	33.36
	-9.8	-11	122.7	39.63	115.8	37.89	108.6	36.60	105.3	35.13	101.7	33.96	94.8	32.40
	-9.5	-10	122.7	39.48	115.8	37.74	108.6	36.45	105.3	34.98	101.7	33.81	94.8	32.25
	-8.5	-9.1	122.7	38.97	115.8	37.23	108.6	35.94	105.3	34.50	101.7	33.36	94.8	31.77
	-7.0	-7.6	122.7	38.25	115.8	36.48	108.6	35.19	105.3	33.75	101.7	32.64	94.8	31.05
	-5.0	-5.6	122.7	37.26	115.8	35.46	108.6	34.20	105.3	32.76	101.7	31.68	94.8	30.06
	-3.0	-3.7	122.7	36.27	115.8	34.44	108.6	33.21	105.3	31.77	101.7	30.75	94.8	29.10
	0.0	-0.7	122.7	34.80	115.8	32.91	108.6	31.74	105.3	30.30	101.7	29.34	94.8	27.66
	3.0	2.2	122.7	33.30	115.8	31.38	108.6	30.24	105.3	28.83	101.7	27.90	94.8	26.22
	5.0	4.1	122.7	32.34	115.8	30.36	108.6	29.25	105.3	27.84	101.7	26.97	94.8	25.23
	7.0	6	122.7	31.35	115.8	29.34	108.6	28.26	105.3	26.85	101.7	26.01	94.8	24.27
	9.0	7.9	122.7	28.29	115.8	26.49	108.6	25.53	105.3	24.24	101.7	23.49	94.8	21.93
11.0	9.8	122.7	26.49	115.8	24.78	108.6	23.88	105.3	22.68	101.7	21.99	94.8	20.52	
13.0	11.8	122.7	24.87	115.8	23.28	108.6	22.41	105.3	21.30	101.7	20.64	94.8	19.26	
15.0	13.7	122.7	23.52	115.8	22.02	108.6	21.21	105.3	20.16	101.7	19.53	94.8	18.21	

Note
 1. TC: Total Capacity(kW), PI: Power Input(kW, Comp. + Outdoor fan motor)
 2. Capacity tables show the average value of conditions which may occur.
 3. In the range beyond the operation limit of the outdoor unit, continuous operation and performance can not be guaranteed. When selecting the outdoor units, avoid the air temperature range that is not guaranteed continuous operation.

7. Capacity Tables

7.2.4 Four Unit

◆ A(C)RUN800LLS5

Combination (%)		Heating Capacity (80HP)												
		Outdoor air temp.		Indoor air temp. °C DB										
		°C DB	°C WB	16		18		20		21		22		24
		TC	PI	TC	PI	TC	PI	TC	PI	TC	PI	TC	PI	
130	-19.8	-20	129.7	54.84	129.7	56.95	128.9	58.80	128.9	61.62	128.9	64.31	128.9	68.56
	-18.8	-19	136.0	56.25	136.0	58.37	135.0	60.21	135.0	63.05	135.0	65.72	135.0	69.97
	-16.7	-17	149.2	59.22	149.2	61.34	148.3	63.17	148.3	66.01	148.3	68.69	148.3	72.94
	-13.7	-15	168.0	63.47	168.0	65.59	167.0	67.42	167.0	70.24	167.0	72.94	167.0	72.12
	-11.8	-13	177.5	66.14	177.5	68.27	176.3	70.12	176.3	72.94	176.3	72.54	176.3	71.60
	-9.8	-11	187.4	68.98	187.4	71.09	186.2	72.94	186.2	72.69	186.2	72.12	186.2	71.05
	-9.5	-10	192.0	69.41	192.0	71.51	190.8	72.94	190.8	72.66	187.7	72.05	187.7	70.99
	-8.5	-9.1	206.8	70.81	206.8	72.94	205.5	72.93	205.5	72.54	192.7	71.84	192.7	70.71
	-7.0	-7.6	229.2	72.94	229.2	73.13	227.8	72.90	227.8	72.35	227.8	71.51	208.8	70.30
	-5.0	-5.6	259.1	73.57	259.1	73.40	257.3	72.88	257.3	72.12	257.3	71.09	221.3	69.75
	-3.0	-3.7	288.9	74.22	288.9	73.66	287.0	72.87	281.5	71.87	271.6	70.67	233.9	69.21
	0.0	-0.7	289.5	75.19	289.5	74.03	288.6	72.85	281.5	71.51	271.6	70.03	252.5	68.40
	3.0	2.2	289.5	76.16	289.5	74.43	288.6	72.81	281.5	71.15	271.6	69.39	252.9	67.60
	5.0	4.1	289.5	76.80	289.5	74.70	288.6	72.79	281.5	70.90	271.6	68.97	252.9	67.05
	7.0	6	289.5	77.46	289.5	74.95	288.6	72.79	281.5	70.66	271.6	68.55	252.9	66.51
	9.0	7.9	289.5	78.19	289.5	75.67	288.6	73.48	281.5	71.34	271.6	69.22	252.9	67.14
	11.0	9.8	289.5	79.74	289.5	77.16	288.6	74.91	281.5	72.73	271.6	70.58	252.9	68.46
13.0	11.8	289.5	81.26	289.5	78.65	288.6	76.34	281.5	74.13	271.6	71.91	252.9	69.76	
15.0	13.7	289.5	82.77	289.5	80.11	288.6	77.79	281.5	75.52	271.6	73.28	252.9	71.09	
120	-19.8	-20	128.9	56.95	128.9	58.80	128.0	61.62	128.0	64.31	128.0	68.56	128.0	71.51
	-18.8	-19	135.0	58.37	135.0	60.21	134.1	63.05	134.1	65.72	134.1	69.97	134.1	72.94
	-16.7	-17	148.0	61.34	148.0	63.17	147.1	66.01	147.1	68.69	147.1	72.94	147.1	72.41
	-13.7	-15	166.8	65.59	166.8	67.42	165.9	70.24	165.9	72.94	165.9	72.27	165.9	71.66
	-11.8	-13	176.3	68.27	176.3	70.12	175.2	72.94	175.2	72.51	175.2	71.85	175.2	71.18
	-9.8	-11	186.2	71.09	186.2	72.94	184.9	72.60	184.9	72.06	184.9	71.42	184.9	70.69
	-9.5	-10	190.4	71.51	190.4	72.90	189.5	72.54	189.5	72.00	189.5	71.34	189.5	70.60
	-8.5	-9.1	205.3	72.94	205.3	72.79	204.0	72.36	204.0	71.78	198.0	71.11	198.0	70.36
	-7.0	-7.6	227.6	72.94	227.6	72.63	226.1	72.09	226.1	71.45	207.4	70.78	207.4	69.99
	-5.0	-5.6	257.2	72.96	257.2	72.39	255.7	71.76	255.7	71.00	255.7	70.35	219.8	69.48
	-3.0	-3.7	284.2	72.96	284.2	72.18	272.9	71.40	264.0	70.54	255.7	69.91	232.2	68.99
	0.0	-0.7	287.1	73.00	284.2	71.85	272.9	70.88	264.0	69.88	255.7	69.24	237.5	68.23
	3.0	2.2	287.1	73.00	284.2	71.51	272.9	70.36	264.0	69.22	255.7	68.57	237.5	67.48
	5.0	4.1	287.1	73.03	284.2	71.28	272.9	70.00	264.0	68.78	255.7	68.12	237.5	66.97
	7.0	6	287.1	73.04	284.2	71.06	272.9	69.66	264.0	68.33	255.7	67.69	237.5	66.48
	9.0	7.9	287.1	73.40	284.2	71.42	272.9	70.00	264.0	68.67	255.7	68.02	237.5	66.81
	11.0	9.8	287.1	74.49	284.2	72.46	272.9	71.03	264.0	69.67	255.7	69.03	237.5	67.79
13.0	11.8	287.1	75.55	284.2	73.49	272.9	72.06	264.0	70.67	255.7	70.00	237.5	68.76	
15.0	13.7	287.1	76.59	284.2	74.52	272.9	73.06	264.0	71.64	255.7	70.97	237.5	69.70	
110	-19.8	-20	128.0	58.80	128.0	61.62	127.4	64.31	127.4	68.56	127.4	71.51	127.4	72.94
	-18.8	-19	134.2	60.21	134.2	63.05	133.5	65.72	133.5	69.97	133.5	72.94	133.5	72.54
	-16.7	-17	147.4	63.17	147.4	66.01	146.4	68.69	146.4	72.94	146.4	72.21	146.4	71.69
	-13.7	-15	165.9	67.42	165.9	70.24	164.9	72.94	164.9	71.93	164.9	71.20	164.9	70.48
	-11.8	-13	175.4	70.12	175.4	72.94	174.2	72.27	174.2	71.30	174.2	70.54	174.2	69.72
	-9.8	-11	185.2	72.94	185.2	72.24	184.0	71.57	184.0	70.60	184.0	69.87	184.0	68.90
	-9.5	-10	189.5	72.84	189.5	72.14	188.3	71.48	188.3	70.51	188.3	69.75	188.3	68.78
	-8.5	-9.1	204.3	72.52	204.3	71.81	203.0	71.12	203.0	70.17	197.8	69.41	197.8	68.38
	-7.0	-7.6	226.5	72.03	226.5	71.30	224.9	70.60	224.9	69.66	207.3	68.90	207.3	67.77
	-5.0	-5.6	246.5	71.39	246.5	70.60	244.9	69.91	236.9	68.99	217.2	68.21	213.9	66.97
	-3.0	-3.7	260.9	70.75	260.9	69.93	244.9	69.21	236.9	68.32	228.9	67.54	213.9	66.17
	0.0	-0.7	276.0	69.78	260.9	68.90	244.9	68.17	236.9	67.30	228.9	66.51	213.9	64.96
	3.0	2.2	276.0	68.80	260.9	67.87	244.9	67.14	236.9	66.30	228.9	65.48	213.9	63.75
	5.0	4.1	276.0	68.15	260.9	67.18	244.9	66.44	236.9	65.63	228.9	64.81	213.9	62.93
	7.0	6	276.0	67.51	260.9	66.48	244.9	65.75	236.9	64.95	228.9	64.11	213.9	62.14
	9.0	7.9	276.0	67.45	260.9	66.45	244.9	65.69	236.9	64.91	228.9	64.07	213.9	62.08
	11.0	9.8	276.0	68.06	260.9	67.03	244.9	66.30	236.9	65.48	228.9	64.64	213.9	62.66
13.0	11.8	276.0	68.63	260.9	67.60	244.9	66.84	236.9	66.03	228.9	65.18	213.9	63.17	
15.0	13.7	276.0	69.18	260.9	68.15	244.9	67.37	236.9	66.55	228.9	65.69	213.9	63.67	

Note

1. TC: Total Capacity(kW), PI: Power Input(kW, Comp. + Outdoor fan motor)
2. Capacity tables show the average value of conditions which may occur.
3. In the range beyond the operation limit of the outdoor unit, continuous operation and performance can not be guaranteed. When selecting the outdoor units, avoid the air temperature range that is not guaranteed continuous operation.

7. Capacity Tables

Combination (%)		Heating Capacity (80HP)												
		Outdoor air temp.		Indoor air temp. °C DB										
		°C DB	°C WB	16		18		20		21		22		24
		TC	PI	TC	PI	TC	PI	TC	PI	TC	PI	TC	PI	
100	-19.8	-20	127.6	61.22	127.6	63.56	126.7	65.54	126.7	69.30	126.7	71.93	126.7	72.94
	-18.8	-19	133.7	62.38	132.9	64.72	132.9	66.96	132.9	70.48	132.9	72.94	132.9	72.27
	-16.7	-17	145.9	64.84	145.9	67.20	145.9	69.93	144.9	72.94	144.9	71.63	144.9	70.84
	-13.7	-15	165.2	68.36	165.2	70.71	164.3	72.94	164.3	71.24	164.3	69.78	164.3	68.80
	-11.8	-13	174.4	70.60	173.5	72.94	173.5	71.96	173.5	70.15	173.5	68.59	173.5	67.51
	-9.8	-11	184.1	72.94	184.1	71.91	183.1	70.90	183.1	69.03	183.1	67.35	183.1	66.15
	-9.5	-10	188.5	72.81	188.5	71.76	187.7	70.75	187.7	68.84	187.7	67.18	187.7	65.96
	-8.5	-9.1	203.0	72.35	203.0	71.24	202.2	70.23	216.9	68.29	209.5	66.53	195.4	65.27
	-7.0	-7.6	228.9	71.66	228.0	70.48	224.0	69.45	216.9	67.45	209.5	65.62	195.4	64.26
	-5.0	-5.6	238.8	70.78	236.6	69.45	224.0	68.42	216.9	66.30	209.5	64.38	195.4	62.89
	-3.0	-3.7	245.9	69.87	238.5	68.42	224.0	67.39	216.9	65.17	209.5	63.14	195.4	61.53
	0.0	-0.7	252.6	68.51	238.5	66.90	224.0	65.84	216.9	63.48	209.5	61.28	195.4	59.51
	3.0	2.2	252.6	67.14	238.5	65.35	224.0	64.26	216.9	61.78	209.5	59.41	195.4	57.47
	5.0	4.1	252.6	66.26	238.5	64.32	224.0	63.23	216.9	60.65	209.5	58.17	195.4	56.11
	7.0	6	252.6	65.35	238.5	63.29	224.0	62.20	216.9	59.51	209.5	56.93	195.4	54.76
	9.0	7.9	252.6	64.45	238.5	62.41	224.0	61.34	216.9	58.69	209.5	56.15	195.4	54.01
11.0	9.8	252.6	64.14	238.5	62.12	224.0	61.05	216.9	58.41	209.5	55.89	195.4	53.74	
13.0	11.8	252.6	63.78	238.5	61.78	224.0	60.69	216.9	58.08	209.5	55.56	195.4	53.44	
15.0	13.7	252.6	63.33	238.5	61.36	224.0	60.29	216.9	57.68	209.5	55.17	195.4	53.08	
90	-19.8	-20	127.0	57.67	127.0	61.92	126.1	64.87	126.1	66.29	126.1	65.35	126.1	63.71
	-18.8	-19	133.7	59.08	132.9	63.32	132.3	66.29	132.3	65.84	132.3	64.89	132.3	63.17
	-16.7	-17	145.9	62.05	145.9	66.29	145.3	65.48	145.3	64.93	145.3	63.90	145.3	62.08
	-13.7	-15	165.2	66.29	165.2	65.23	163.4	64.32	163.4	63.59	163.4	62.50	163.4	60.53
	-11.8	-13	174.4	65.69	173.5	64.56	172.7	63.59	172.7	62.74	172.7	61.61	172.7	59.55
	-9.8	-11	184.1	65.05	184.1	63.84	182.4	62.81	182.4	61.86	182.4	60.68	182.4	58.50
	-9.5	-10	188.5	64.96	188.5	63.74	186.8	62.71	186.8	61.72	186.8	60.53	186.8	58.35
	-8.5	-9.1	203.0	64.65	201.8	63.38	201.3	62.32	198.5	61.29	192.2	60.07	178.5	57.83
	-7.0	-7.6	228.9	64.17	217.8	62.87	204.9	61.74	198.5	60.62	192.2	59.35	178.5	57.05
	-5.0	-5.6	231.4	63.53	217.8	62.14	204.9	60.96	198.5	59.74	192.2	58.41	178.5	56.01
	-3.0	-3.7	231.4	62.89	217.8	61.44	204.9	60.20	198.5	58.84	192.2	57.49	178.5	54.97
	0.0	-0.7	231.4	61.95	217.8	60.37	204.9	59.04	198.5	57.52	192.2	56.07	178.5	53.42
	3.0	2.2	231.4	60.98	217.8	59.32	204.9	57.87	198.5	56.19	192.2	54.67	178.5	51.86
	5.0	4.1	231.4	60.35	217.8	58.59	204.9	57.10	198.5	55.29	192.2	53.73	178.5	50.83
	7.0	6	231.4	59.72	217.8	57.89	204.9	56.34	198.5	54.40	192.2	52.79	178.5	49.78
	9.0	7.9	231.4	58.90	217.8	57.10	204.9	55.56	198.5	53.67	192.2	52.07	178.5	49.09
11.0	9.8	231.4	58.08	217.8	56.29	204.9	54.80	198.5	52.91	192.2	51.34	178.5	48.42	
13.0	11.8	231.4	57.26	217.8	55.50	204.9	54.01	198.5	52.16	192.2	50.62	178.5	47.73	
15.0	13.7	231.4	56.44	217.8	54.70	204.9	53.25	198.5	51.42	192.2	49.89	178.5	47.05	
80	-19.8	-20	125.7	50.15	125.7	54.40	125.7	58.79	125.7	57.89	125.7	56.53	125.7	55.07
	-18.8	-19	131.7	51.58	131.7	58.79	131.7	58.38	131.7	57.43	131.7	56.07	131.7	54.61
	-16.7	-17	145.3	58.79	145.3	58.02	145.3	57.53	145.3	56.52	145.3	55.13	145.3	53.61
	-13.7	-15	171.1	57.79	167.7	56.92	163.4	56.31	163.4	55.16	163.4	53.77	159.4	52.19
	-11.8	-13	184.9	57.16	179.7	56.25	172.7	55.55	172.7	54.34	171.4	52.91	159.4	51.30
	-9.8	-11	190.8	56.49	185.2	55.52	182.4	54.74	177.9	53.43	171.4	52.01	159.4	50.36
	-9.5	-10	192.0	56.38	186.5	55.40	183.4	54.61	177.9	53.31	171.4	51.88	159.4	50.22
	-8.5	-9.1	199.1	56.04	195.4	55.04	183.4	54.21	177.9	52.85	171.4	51.42	159.4	49.73
	-7.0	-7.6	207.1	55.55	195.4	54.49	183.4	53.61	177.9	52.18	171.4	50.75	159.4	49.03
	-5.0	-5.6	207.1	54.88	195.4	53.77	183.4	52.79	177.9	51.30	171.4	49.85	159.4	48.08
	-3.0	-3.7	207.1	54.21	195.4	53.04	183.4	51.97	177.9	50.39	171.4	48.94	159.4	47.15
	0.0	-0.7	207.1	53.21	195.4	51.94	183.4	50.77	177.9	49.06	171.4	47.58	159.4	45.72
	3.0	2.2	207.1	52.22	195.4	50.85	183.4	49.55	177.9	47.72	171.4	46.23	159.4	44.30
	5.0	4.1	207.1	51.55	195.4	50.12	183.4	48.75	177.9	46.82	171.4	45.33	159.4	43.36
	7.0	6	207.1	50.88	195.4	49.40	183.4	47.93	177.9	45.94	171.4	44.42	159.4	42.42
	9.0	7.9	207.1	47.76	195.4	46.36	183.4	45.00	177.9	43.14	171.4	41.72	159.4	39.84
11.0	9.8	207.1	44.33	195.4	43.05	183.4	41.78	177.9	40.03	171.4	38.71	159.4	36.96	
13.0	11.8	207.1	41.38	195.4	40.18	183.4	38.99	177.9	37.38	171.4	36.14	159.4	34.50	
15.0	13.7	207.1	38.96	195.4	37.83	183.4	36.71	177.9	35.17	171.4	34.02	159.4	32.49	

Note

1. TC: Total Capacity(kW), PI: Power Input(kW, Comp. + Outdoor fan motor)
2. Capacity tables show the average value of conditions which may occur.
3. In the range beyond the operation limit of the outdoor unit, continuous operation and performance can not be guaranteed. When selecting the outdoor units, avoid the air temperature range that is not guaranteed continuous operation.

7. Capacity Tables

Combination (%)		Heating Capacity (80HP)												
		Outdoor air temp.		Indoor air temp. °C DB										
		°C DB	°C WB	16		18		20		21		22		24
		TC	PI	TC	PI	TC	PI	TC	PI	TC	PI	TC	PI	
70	-19.8	-20	125.7	53.13	125.7	54.55	125.7	53.61	125.7	52.13	125.7	50.73	125.7	49.18
	-18.8	-19	131.7	54.55	131.7	54.10	131.7	53.15	131.7	51.66	131.7	50.26	131.7	48.67
	-16.7	-17	145.3	53.70	145.3	53.16	145.3	52.15	145.3	50.64	145.3	49.27	136.4	47.63
	-13.7	-15	175.7	52.52	165.9	51.81	156.0	50.76	150.7	49.21	146.2	47.84	136.4	46.12
	-11.8	-13	175.7	51.76	165.9	50.95	156.0	49.88	150.7	48.28	146.2	46.94	136.4	45.18
	-9.8	-11	175.7	50.97	165.9	50.05	156.0	48.94	150.7	47.32	146.2	46.00	136.4	44.17
	-9.5	-10	175.7	50.85	165.9	49.91	156.0	48.79	150.7	47.17	146.2	45.85	136.4	44.02
	-8.5	-9.1	175.7	50.45	165.9	49.48	156.0	48.33	150.7	46.69	146.2	45.39	136.4	43.54
	-7.0	-7.6	175.7	49.86	165.9	48.79	156.0	47.63	150.7	45.97	146.2	44.67	136.4	42.78
	-5.0	-5.6	175.7	49.06	165.9	47.91	156.0	46.69	150.7	45.00	146.2	43.72	136.4	41.78
	-3.0	-3.7	175.7	48.27	165.9	47.00	156.0	45.76	150.7	44.05	146.2	42.78	136.4	40.78
	0.0	-0.7	175.7	47.09	165.9	45.66	156.0	44.36	150.7	42.60	146.2	41.36	136.4	39.27
	3.0	2.2	175.7	45.88	165.9	44.30	156.0	42.97	150.7	41.17	146.2	39.93	136.4	37.78
	5.0	4.1	175.7	45.09	165.9	43.41	156.0	42.03	150.7	40.20	146.2	39.00	136.4	36.77
	7.0	6	175.7	44.30	165.9	42.51	156.0	41.08	150.7	39.23	146.2	38.05	136.4	35.77
	9.0	7.9	175.7	39.99	165.9	38.39	156.0	37.11	150.7	35.43	146.2	34.35	136.4	32.31
	11.0	9.8	175.7	37.24	165.9	35.74	156.0	34.55	150.7	32.99	146.2	31.98	136.4	30.07
	13.0	11.8	175.7	34.84	165.9	33.44	156.0	32.32	150.7	30.86	146.2	29.92	136.4	28.13
15.0	13.7	175.7	32.86	165.9	31.52	156.0	30.47	150.7	29.10	146.2	28.22	136.4	26.52	
60	-19.8	-20	150.7	50.30	142.7	49.37	125.7	47.90	125.7	46.48	124.9	45.06	116.9	43.51
	-18.8	-19	150.7	49.88	142.7	48.91	131.7	47.42	129.3	45.99	124.9	44.60	116.9	43.02
	-16.7	-17	150.7	49.03	142.7	47.90	133.9	46.43	129.3	45.00	124.9	43.60	116.9	41.96
	-13.7	-15	150.7	47.79	142.7	46.51	133.9	45.00	129.3	43.57	124.9	42.17	116.9	40.45
	-11.8	-13	150.7	47.02	142.7	45.61	133.9	44.08	129.3	42.69	124.9	41.26	116.9	39.50
	-9.8	-11	150.7	46.20	142.7	44.69	133.9	43.12	129.3	41.72	124.9	40.32	116.9	38.50
	-9.5	-10	150.7	46.06	142.7	44.54	133.9	42.99	129.3	41.58	124.9	40.17	116.9	38.35
	-8.5	-9.1	150.7	45.66	142.7	44.06	133.9	42.50	129.3	41.11	124.9	39.71	116.9	37.84
	-7.0	-7.6	150.7	45.05	142.7	43.36	133.9	41.79	129.3	40.38	124.9	38.99	116.9	37.10
	-5.0	-5.6	150.7	44.23	142.7	42.42	133.9	40.84	129.3	39.44	124.9	38.05	116.9	36.10
	-3.0	-3.7	150.7	43.39	142.7	41.50	133.9	39.86	129.3	38.47	124.9	37.10	116.9	35.10
	0.0	-0.7	150.7	42.17	142.7	40.09	133.9	38.44	129.3	37.05	124.9	35.68	116.9	33.58
	3.0	2.2	150.7	40.93	142.7	38.68	133.9	37.01	129.3	35.62	124.9	34.25	116.9	32.07
	5.0	4.1	150.7	40.11	142.7	37.74	133.9	36.04	129.3	34.68	124.9	33.29	116.9	31.08
	7.0	6	150.7	39.29	142.7	36.80	133.9	35.08	129.3	33.71	124.9	32.34	116.9	30.07
	9.0	7.9	150.7	35.07	142.7	32.83	133.9	31.31	129.3	30.09	124.9	28.86	116.9	26.85
	11.0	9.8	150.7	32.74	142.7	30.68	133.9	29.23	129.3	28.10	124.9	26.94	116.9	25.07
	13.0	11.8	150.7	30.68	142.7	28.73	133.9	27.40	129.3	26.31	124.9	25.24	116.9	23.48
15.0	13.7	150.7	28.98	142.7	27.15	133.9	25.88	129.3	24.88	124.9	23.85	116.9	22.19	
50	-19.8	-20	125.9	45.06	118.7	43.48	111.4	42.01	108.0	40.51	104.4	39.13	97.2	37.65
	-18.8	-19	125.9	44.57	118.7	42.96	111.4	41.51	108.0	40.02	104.4	38.65	97.2	37.14
	-16.7	-17	125.9	43.51	118.7	41.89	111.4	40.44	108.0	38.99	104.4	37.65	97.2	36.13
	-13.7	-15	125.9	42.02	118.7	40.35	111.4	38.95	108.0	37.47	104.4	36.20	97.2	34.65
	-11.8	-13	125.9	41.07	118.7	39.35	111.4	38.01	108.0	36.53	104.4	35.31	97.2	33.74
	-9.8	-11	125.9	40.08	118.7	38.32	111.4	37.01	108.0	35.53	104.4	34.35	97.2	32.76
	-9.5	-10	125.9	39.93	118.7	38.17	111.4	36.85	108.0	35.38	104.4	34.20	97.2	32.61
	-8.5	-9.1	125.9	39.41	118.7	37.65	111.4	36.35	108.0	34.89	104.4	33.74	97.2	32.13
	-7.0	-7.6	125.9	38.68	118.7	36.89	111.4	35.59	108.0	34.14	104.4	33.01	97.2	31.39
	-5.0	-5.6	125.9	37.69	118.7	35.86	111.4	34.59	108.0	33.13	104.4	32.04	97.2	30.40
	-3.0	-3.7	125.9	36.68	118.7	34.83	111.4	33.59	108.0	32.13	104.4	31.10	97.2	29.43
	0.0	-0.7	125.9	35.19	118.7	33.28	111.4	32.10	108.0	30.64	104.4	29.67	97.2	27.97
	3.0	2.2	125.9	33.68	118.7	31.73	111.4	30.59	108.0	29.16	104.4	28.22	97.2	26.51
	5.0	4.1	125.9	32.70	118.7	30.70	111.4	29.59	108.0	28.16	104.4	27.27	97.2	25.52
	7.0	6	125.9	31.71	118.7	29.67	111.4	28.58	108.0	27.15	104.4	26.31	97.2	24.55
	9.0	7.9	125.9	28.62	118.7	26.79	111.4	25.82	108.0	24.52	104.4	23.76	97.2	22.17
	11.0	9.8	125.9	26.79	118.7	25.07	111.4	24.15	108.0	22.94	104.4	22.24	97.2	20.75
	13.0	11.8	125.9	25.15	118.7	23.54	111.4	22.67	108.0	21.54	104.4	20.87	97.2	19.48
15.0	13.7	125.9	23.79	118.7	22.27	111.4	21.45	108.0	20.39	104.4	19.75	97.2	18.43	

Note

1. TC: Total Capacity(kW), PI: Power Input(kW, Comp. + Outdoor fan motor)
2. Capacity tables show the average value of conditions which may occur.
3. In the range beyond the operation limit of the outdoor unit, continuous operation and performance can not be guaranteed. When selecting the outdoor units, avoid the air temperature range that is not guaranteed continuous operation.

7. Capacity Tables

◆ A(C)RUN820LLS5

Combination (%)	Outdoor air temp.		Heating Capacity (82HP)											
			Indoor air temp. °C DB											
	°C DB	°C WB	16		18		20		21		22		24	
		TC	PI	TC	PI	TC	PI	TC	PI	TC	PI	TC	PI	
130	-19.8	-20	133.0	54.84	133.0	56.95	132.2	58.80	132.2	61.62	132.2	64.31	132.2	68.56
	-18.8	-19	139.4	56.25	139.4	58.37	138.4	60.21	138.4	63.05	138.4	65.72	138.4	69.97
	-16.7	-17	153.0	59.22	153.0	61.34	152.0	63.17	152.0	66.01	152.0	68.69	152.0	72.94
	-13.7	-15	172.2	63.47	172.2	65.59	171.2	67.42	171.2	70.24	171.2	72.94	171.2	72.12
	-11.8	-13	181.9	66.14	181.9	68.27	180.7	70.12	180.7	72.94	180.7	72.54	180.7	71.60
	-9.8	-11	192.1	68.98	192.1	71.09	190.8	72.94	190.8	72.69	190.8	72.12	190.8	71.05
	-9.5	-10	196.8	69.41	196.8	71.51	195.5	72.94	195.5	72.66	192.4	72.05	192.4	70.99
	-8.5	-9.1	212.0	70.81	212.0	72.94	210.7	72.93	210.7	72.54	197.5	71.84	197.5	70.71
	-7.0	-7.6	235.0	72.94	235.0	73.13	233.4	72.90	233.4	72.35	233.4	71.51	213.9	70.30
	-5.0	-5.6	265.6	73.57	265.6	73.40	263.7	72.88	263.7	72.12	263.7	71.09	226.7	69.75
	-3.0	-3.7	296.1	74.22	296.1	73.66	294.2	72.87	288.5	71.87	278.4	70.67	239.6	69.21
	0.0	-0.7	296.7	75.19	296.7	74.03	295.8	72.85	288.5	71.51	278.4	70.03	258.6	68.40
	3.0	2.2	296.7	76.16	296.7	74.43	295.8	72.81	288.5	71.15	278.4	69.39	259.2	67.60
	5.0	4.1	296.7	76.80	296.7	74.70	295.8	72.79	288.5	70.90	278.4	68.97	259.2	67.05
	7.0	6	296.7	77.46	296.7	74.95	295.8	72.79	288.5	70.66	278.4	68.55	259.2	66.51
	9.0	7.9	296.7	78.19	296.7	75.67	295.8	73.48	288.5	71.34	278.4	69.22	259.2	67.14
	11.0	9.8	296.7	79.74	296.7	77.16	295.8	74.91	288.5	72.73	278.4	70.58	259.2	68.46
13.0	11.8	296.7	81.26	296.7	78.65	295.8	76.34	288.5	74.13	278.4	71.91	259.2	69.76	
15.0	13.7	296.7	82.77	296.7	80.11	295.8	77.79	288.5	75.52	278.4	73.28	259.2	71.09	
120	-19.8	-20	132.1	56.95	132.1	58.80	131.2	61.62	131.2	64.31	131.2	68.56	131.2	71.51
	-18.8	-19	138.4	58.37	138.4	60.21	137.5	63.05	137.5	65.72	137.5	69.97	137.5	72.94
	-16.7	-17	151.7	61.34	151.7	63.17	150.8	66.01	150.8	68.69	150.8	72.94	150.8	72.41
	-13.7	-15	170.9	65.59	170.9	67.42	170.0	70.24	170.0	72.94	170.0	72.27	170.0	71.66
	-11.8	-13	180.7	68.27	180.7	70.12	179.5	72.94	179.5	72.51	179.5	71.85	179.5	71.18
	-9.8	-11	190.8	71.09	190.8	72.94	189.5	72.60	189.5	72.06	189.5	71.42	189.5	70.69
	-9.5	-10	195.2	71.51	195.2	72.90	194.2	72.54	194.2	72.00	194.2	71.34	194.2	70.60
	-8.5	-9.1	210.4	72.94	210.4	72.79	209.1	72.36	209.1	71.78	202.8	71.11	202.8	70.36
	-7.0	-7.6	233.3	72.94	233.3	72.63	231.8	72.09	231.8	71.45	212.5	70.78	212.5	69.99
	-5.0	-5.6	263.6	72.96	263.6	72.39	262.1	71.76	262.1	71.00	262.1	70.35	225.1	69.48
	-3.0	-3.7	291.3	72.96	291.3	72.18	279.7	71.40	270.6	70.54	262.1	69.91	237.8	68.99
	0.0	-0.7	294.3	73.00	291.3	71.85	279.7	70.88	270.6	69.88	262.1	69.24	243.4	68.23
	3.0	2.2	294.3	73.00	291.3	71.51	279.7	70.36	270.6	69.22	262.1	68.57	243.4	67.48
	5.0	4.1	294.3	73.03	291.3	71.28	279.7	70.00	270.6	68.78	262.1	68.12	243.4	66.97
	7.0	6	294.3	73.04	291.3	71.06	279.7	69.66	270.6	68.33	262.1	67.69	243.4	66.48
	9.0	7.9	294.3	73.40	291.3	71.42	279.7	70.00	270.6	68.67	262.1	68.02	243.4	66.81
	11.0	9.8	294.3	74.49	291.3	72.46	279.7	71.03	270.6	69.67	262.1	69.03	243.4	67.79
13.0	11.8	294.3	75.55	291.3	73.49	279.7	72.06	270.6	70.67	262.1	70.00	243.4	68.76	
15.0	13.7	294.3	76.59	291.3	74.52	279.7	73.06	270.6	71.64	262.1	70.97	243.4	69.70	
110	-19.8	-20	131.3	58.80	131.3	61.62	130.6	64.31	130.6	68.56	130.6	71.51	130.6	72.94
	-18.8	-19	137.6	60.21	137.6	63.05	136.9	65.72	136.9	69.97	136.9	72.94	136.9	72.54
	-16.7	-17	151.1	63.17	151.1	66.01	150.1	68.69	150.1	72.94	150.1	72.21	150.1	71.69
	-13.7	-15	170.0	67.42	170.0	70.24	169.0	72.94	169.0	71.93	169.0	71.20	169.0	70.48
	-11.8	-13	179.7	70.12	179.7	72.94	178.5	72.27	178.5	71.30	178.5	70.54	178.5	69.72
	-9.8	-11	189.8	72.94	189.8	72.24	188.6	71.57	188.6	70.60	188.6	69.87	188.6	68.90
	-9.5	-10	194.3	72.84	194.3	72.14	193.0	71.48	193.0	70.51	193.0	69.75	193.0	68.78
	-8.5	-9.1	209.4	72.52	209.4	71.81	208.1	71.12	208.1	70.17	202.7	69.41	202.7	68.38
	-7.0	-7.6	232.1	72.03	232.1	71.30	230.5	70.60	230.5	69.66	212.6	68.90	212.6	67.77
	-5.0	-5.6	252.7	71.39	252.7	70.60	251.0	69.91	242.8	68.99	222.7	68.21	219.2	66.97
	-3.0	-3.7	267.4	70.75	267.4	69.93	251.0	69.21	242.8	68.32	234.6	67.54	219.2	66.17
	0.0	-0.7	282.9	69.78	267.4	68.90	251.0	68.17	242.8	67.30	234.6	66.51	219.2	64.96
	3.0	2.2	282.9	68.80	267.4	67.87	251.0	67.14	242.8	66.30	234.6	65.48	219.2	63.75
	5.0	4.1	282.9	68.15	267.4	67.18	251.0	66.44	242.8	65.63	234.6	64.81	219.2	62.93
	7.0	6	282.9	67.51	267.4	66.48	251.0	65.75	242.8	64.95	234.6	64.11	219.2	62.14
	9.0	7.9	282.9	67.45	267.4	66.45	251.0	65.69	242.8	64.91	234.6	64.07	219.2	62.08
	11.0	9.8	282.9	68.06	267.4	67.03	251.0	66.30	242.8	65.48	234.6	64.64	219.2	62.66
13.0	11.8	282.9	68.63	267.4	67.60	251.0	66.84	242.8	66.03	234.6	65.18	219.2	63.17	
15.0	13.7	282.9	69.18	267.4	68.15	251.0	67.37	242.8	66.55	234.6	65.69	219.2	63.67	

Note

1. TC: Total Capacity(kW), PI : Power Input(kW, Comp. + Outdoor fan motor)
2. Capacity tables show the average value of conditions which may occur.
3. In the range beyond the operation limit of the outdoor unit, continuous operation and performance can not be guaranteed. When selecting the outdoor units, avoid the air temperature range that is not guaranteed continuous operation.

7. Capacity Tables

Combination (%)		Heating Capacity (82HP)												
		Outdoor air temp.		Indoor air temp. °C DB										
		°C DB	°C WB	16		18		20		21		22		24
		TC	PI	TC	PI	TC	PI	TC	PI	TC	PI	TC	PI	
100	-19.8	-20	130.9	61.22	130.9	63.56	130.0	65.54	130.0	69.30	130.0	71.93	130.0	72.94
	-18.8	-19	137.1	62.38	136.2	64.72	136.2	66.96	136.2	70.48	136.2	72.94	136.2	72.27
	-16.7	-17	149.5	64.84	149.5	67.20	149.5	69.93	148.5	72.94	148.5	71.63	148.5	70.84
	-13.7	-15	169.3	68.36	169.3	70.71	168.3	72.94	168.3	71.24	168.3	69.78	168.3	68.80
	-11.8	-13	178.7	70.60	177.8	72.94	177.8	71.96	177.8	70.15	177.8	68.59	177.8	67.51
	-9.8	-11	188.7	72.94	188.7	71.91	187.7	70.90	187.7	69.03	187.7	67.35	187.7	66.15
	-9.5	-10	193.2	72.81	193.2	71.76	192.3	70.75	192.3	68.84	192.3	67.18	192.3	65.96
	-8.5	-9.1	208.1	72.35	208.1	71.24	207.2	70.23	222.3	68.29	214.8	66.53	200.2	65.27
	-7.0	-7.6	234.6	71.66	233.7	70.48	229.6	69.45	222.3	67.45	214.8	65.62	200.2	64.26
	-5.0	-5.6	244.8	70.78	242.5	69.45	229.6	68.42	222.3	66.30	214.8	64.38	200.2	62.89
	-3.0	-3.7	252.0	69.87	244.4	68.42	229.6	67.39	222.3	65.17	214.8	63.14	200.2	61.53
	0.0	-0.7	259.0	68.51	244.4	66.90	229.6	65.84	222.3	63.48	214.8	61.28	200.2	59.51
	3.0	2.2	259.0	67.14	244.4	65.35	229.6	64.26	222.3	61.78	214.8	59.41	200.2	57.47
	5.0	4.1	259.0	66.26	244.4	64.32	229.6	63.23	222.3	60.65	214.8	58.17	200.2	56.11
	7.0	6	259.0	65.35	244.4	63.29	229.6	62.20	222.3	59.51	214.8	56.93	200.2	54.76
	9.0	7.9	259.0	64.45	244.4	62.41	229.6	61.34	222.3	58.69	214.8	56.15	200.2	54.01
	11.0	9.8	259.0	64.14	244.4	62.12	229.6	61.05	222.3	58.41	214.8	55.89	200.2	53.74
	13.0	11.8	259.0	63.78	244.4	61.78	229.6	60.69	222.3	58.08	214.8	55.56	200.2	53.44
15.0	13.7	259.0	63.33	244.4	61.36	229.6	60.29	222.3	57.68	214.8	55.17	200.2	53.08	
90	-19.8	-20	130.2	57.67	130.2	61.92	129.4	64.87	129.4	66.29	129.4	65.35	129.4	63.71
	-18.8	-19	137.1	59.08	136.2	63.32	135.6	66.29	135.6	65.84	135.6	64.89	135.6	63.17
	-16.7	-17	149.5	62.05	149.5	66.29	148.9	65.48	148.9	64.93	148.9	63.90	148.9	62.08
	-13.7	-15	169.3	66.29	169.3	65.23	167.5	64.32	167.5	63.59	167.5	62.50	167.5	60.53
	-11.8	-13	178.7	65.69	177.8	64.56	177.0	63.59	177.0	62.74	177.0	61.61	177.0	59.55
	-9.8	-11	188.7	65.05	188.7	63.84	187.0	62.81	187.0	61.86	187.0	60.68	187.0	58.50
	-9.5	-10	193.2	64.96	193.2	63.74	191.5	62.71	191.5	61.72	191.5	60.53	191.5	58.35
	-8.5	-9.1	208.1	64.65	206.8	63.38	206.3	62.32	203.5	61.29	197.0	60.07	183.0	57.83
	-7.0	-7.6	234.6	64.17	223.3	62.87	210.0	61.74	203.5	60.62	197.0	59.35	183.0	57.05
	-5.0	-5.6	237.2	63.53	223.3	62.14	210.0	60.96	203.5	59.74	197.0	58.41	183.0	56.01
	-3.0	-3.7	237.2	62.89	223.3	61.44	210.0	60.20	203.5	58.84	197.0	57.49	183.0	54.97
	0.0	-0.7	237.2	61.95	223.3	60.37	210.0	59.04	203.5	57.52	197.0	56.07	183.0	53.42
	3.0	2.2	237.2	60.98	223.3	59.32	210.0	57.87	203.5	56.19	197.0	54.67	183.0	51.86
	5.0	4.1	237.2	60.35	223.3	58.59	210.0	57.10	203.5	55.29	197.0	53.73	183.0	50.83
	7.0	6	237.2	59.72	223.3	57.89	210.0	56.34	203.5	54.40	197.0	52.79	183.0	49.78
	9.0	7.9	237.2	58.90	223.3	57.10	210.0	55.56	203.5	53.67	197.0	52.07	183.0	49.09
	11.0	9.8	237.2	58.08	223.3	56.29	210.0	54.80	203.5	52.91	197.0	51.34	183.0	48.42
	13.0	11.8	237.2	57.26	223.3	55.50	210.0	54.01	203.5	52.16	197.0	50.62	183.0	47.73
15.0	13.7	237.2	56.44	223.3	54.70	210.0	53.25	203.5	51.42	197.0	49.89	183.0	47.05	
80	-19.8	-20	128.9	50.15	128.9	54.40	128.9	58.79	128.9	57.89	128.9	56.53	128.9	55.07
	-18.8	-19	135.0	51.58	135.0	58.79	135.0	58.38	135.0	57.43	135.0	56.07	135.0	54.61
	-16.7	-17	148.9	58.79	148.9	58.02	148.9	57.53	148.9	56.52	148.9	55.13	148.9	53.61
	-13.7	-15	175.4	57.79	171.8	56.92	167.5	56.31	167.5	55.16	167.5	53.77	163.4	52.19
	-11.8	-13	189.5	57.16	184.1	56.25	177.0	55.55	177.0	54.34	175.7	52.91	163.4	51.30
	-9.8	-11	195.6	56.49	189.8	55.52	187.0	54.74	182.3	53.43	175.7	52.01	163.4	50.36
	-9.5	-10	196.8	56.38	191.1	55.40	188.0	54.61	182.3	53.31	175.7	51.88	163.4	50.22
	-8.5	-9.1	204.1	56.04	200.2	55.04	188.0	54.21	182.3	52.85	175.7	51.42	163.4	49.73
	-7.0	-7.6	212.3	55.55	200.2	54.49	188.0	53.61	182.3	52.18	175.7	50.75	163.4	49.03
	-5.0	-5.6	212.3	54.88	200.2	53.77	188.0	52.79	182.3	51.30	175.7	49.85	163.4	48.08
	-3.0	-3.7	212.3	54.21	200.2	53.04	188.0	51.97	182.3	50.39	175.7	48.94	163.4	47.15
	0.0	-0.7	212.3	53.21	200.2	51.94	188.0	50.77	182.3	49.06	175.7	47.58	163.4	45.72
	3.0	2.2	212.3	52.22	200.2	50.85	188.0	49.55	182.3	47.72	175.7	46.23	163.4	44.30
	5.0	4.1	212.3	51.55	200.2	50.12	188.0	48.75	182.3	46.82	175.7	45.33	163.4	43.36
	7.0	6	212.3	50.88	200.2	49.40	188.0	47.93	182.3	45.94	175.7	44.42	163.4	42.42
	9.0	7.9	212.3	47.76	200.2	46.36	188.0	45.00	182.3	43.14	175.7	41.72	163.4	39.84
	11.0	9.8	212.3	44.33	200.2	43.05	188.0	41.78	182.3	40.03	175.7	38.71	163.4	36.96
	13.0	11.8	212.3	41.38	200.2	40.18	188.0	38.99	182.3	37.38	175.7	36.14	163.4	34.50
15.0	13.7	212.3	38.96	200.2	37.83	188.0	36.71	182.3	35.17	175.7	34.02	163.4	32.49	

Note

1. TC: Total Capacity(kW), PI: Power Input(kW, Comp. + Outdoor fan motor)
2. Capacity tables show the average value of conditions which may occur.
3. In the range beyond the operation limit of the outdoor unit, continuous operation and performance can not be guaranteed. When selecting the outdoor units, avoid the air temperature range that is not guaranteed continuous operation.

7. Capacity Tables

Combination (%)		Heating Capacity (82HP)												
		Outdoor air temp.		Indoor air temp. °C DB										
		°C DB	°C WB	16		18		20		21		22		24
		TC	PI	TC	PI	TC	PI	TC	PI	TC	PI	TC	PI	
70	-19.8	-20	128.9	53.13	128.9	54.55	128.9	53.61	128.9	52.13	128.9	50.73	128.9	49.18
	-18.8	-19	135.0	54.55	135.0	54.10	135.0	53.15	135.0	51.66	135.0	50.26	135.0	48.67
	-16.7	-17	148.9	53.70	148.9	53.16	148.9	52.15	148.9	50.64	148.9	49.27	139.8	47.63
	-13.7	-15	180.1	52.52	170.0	51.81	159.9	50.76	154.5	49.21	149.8	47.84	139.8	46.12
	-11.8	-13	180.1	51.76	170.0	50.95	159.9	49.88	154.5	48.28	149.8	46.94	139.8	45.18
	-9.8	-11	180.1	50.97	170.0	50.05	159.9	48.94	154.5	47.32	149.8	46.00	139.8	44.17
	-9.5	-10	180.1	50.85	170.0	49.91	159.9	48.79	154.5	47.17	149.8	45.85	139.8	44.02
	-8.5	-9.1	180.1	50.45	170.0	49.48	159.9	48.33	154.5	46.69	149.8	45.39	139.8	43.54
	-7.0	-7.6	180.1	49.86	170.0	48.79	159.9	47.63	154.5	45.97	149.8	44.67	139.8	42.78
	-5.0	-5.6	180.1	49.06	170.0	47.91	159.9	46.69	154.5	45.00	149.8	43.72	139.8	41.78
	-3.0	-3.7	180.1	48.27	170.0	47.00	159.9	45.76	154.5	44.05	149.8	42.78	139.8	40.78
	0.0	-0.7	180.1	47.09	170.0	45.66	159.9	44.36	154.5	42.60	149.8	41.36	139.8	39.27
	3.0	2.2	180.1	45.88	170.0	44.30	159.9	42.97	154.5	41.17	149.8	39.93	139.8	37.78
	5.0	4.1	180.1	45.09	170.0	43.41	159.9	42.03	154.5	40.20	149.8	39.00	139.8	36.77
	7.0	6	180.1	44.30	170.0	42.51	159.9	41.08	154.5	39.23	149.8	38.05	139.8	35.77
	9.0	7.9	180.1	39.99	170.0	38.39	159.9	37.11	154.5	35.43	149.8	34.35	139.8	32.31
	11.0	9.8	180.1	37.24	170.0	35.74	159.9	34.55	154.5	32.99	149.8	31.98	139.8	30.07
	13.0	11.8	180.1	34.84	170.0	33.44	159.9	32.32	154.5	30.86	149.8	29.92	139.8	28.13
15.0	13.7	180.1	32.86	170.0	31.52	159.9	30.47	154.5	29.10	149.8	28.22	139.8	26.52	
60	-19.8	-20	154.5	50.30	146.3	49.37	128.9	47.90	128.9	46.48	128.0	45.06	119.8	43.51
	-18.8	-19	154.5	49.88	146.3	48.91	135.0	47.42	132.5	45.99	128.0	44.60	119.8	43.02
	-16.7	-17	154.5	49.03	146.3	47.90	137.2	46.43	132.5	45.00	128.0	43.60	119.8	41.96
	-13.7	-15	154.5	47.79	146.3	46.51	137.2	45.00	132.5	43.57	128.0	42.17	119.8	40.45
	-11.8	-13	154.5	47.02	146.3	45.61	137.2	44.08	132.5	42.69	128.0	41.26	119.8	39.50
	-9.8	-11	154.5	46.20	146.3	44.69	137.2	43.12	132.5	41.72	128.0	40.32	119.8	38.50
	-9.5	-10	154.5	46.06	146.3	44.54	137.2	42.99	132.5	41.58	128.0	40.17	119.8	38.35
	-8.5	-9.1	154.5	45.66	146.3	44.06	137.2	42.50	132.5	41.11	128.0	39.71	119.8	37.84
	-7.0	-7.6	154.5	45.05	146.3	43.36	137.2	41.79	132.5	40.38	128.0	38.99	119.8	37.10
	-5.0	-5.6	154.5	44.23	146.3	42.42	137.2	40.84	132.5	39.44	128.0	38.05	119.8	36.10
	-3.0	-3.7	154.5	43.39	146.3	41.50	137.2	39.86	132.5	38.47	128.0	37.10	119.8	35.10
	0.0	-0.7	154.5	42.17	146.3	40.09	137.2	38.44	132.5	37.05	128.0	35.68	119.8	33.58
	3.0	2.2	154.5	40.93	146.3	38.68	137.2	37.01	132.5	35.62	128.0	34.25	119.8	32.07
	5.0	4.1	154.5	40.11	146.3	37.74	137.2	36.04	132.5	34.68	128.0	33.29	119.8	31.08
	7.0	6	154.5	39.29	146.3	36.80	137.2	35.08	132.5	33.71	128.0	32.34	119.8	30.07
	9.0	7.9	154.5	35.07	146.3	32.83	137.2	31.31	132.5	30.09	128.0	28.86	119.8	26.85
	11.0	9.8	154.5	32.74	146.3	30.68	137.2	29.23	132.5	28.10	128.0	26.94	119.8	25.07
	13.0	11.8	154.5	30.68	146.3	28.73	137.2	27.40	132.5	26.31	128.0	25.24	119.8	23.48
15.0	13.7	154.5	28.98	146.3	27.15	137.2	25.88	132.5	24.88	128.0	23.85	119.8	22.19	
50	-19.8	-20	129.0	45.06	121.7	43.48	114.2	42.01	110.7	40.51	107.0	39.13	99.7	37.65
	-18.8	-19	129.0	44.57	121.7	42.96	114.2	41.51	110.7	40.02	107.0	38.65	99.7	37.14
	-16.7	-17	129.0	43.51	121.7	41.89	114.2	40.44	110.7	38.99	107.0	37.65	99.7	36.13
	-13.7	-15	129.0	42.02	121.7	40.35	114.2	38.95	110.7	37.47	107.0	36.20	99.7	34.65
	-11.8	-13	129.0	41.07	121.7	39.35	114.2	38.01	110.7	36.53	107.0	35.31	99.7	33.74
	-9.8	-11	129.0	40.08	121.7	38.32	114.2	37.01	110.7	35.53	107.0	34.35	99.7	32.76
	-9.5	-10	129.0	39.93	121.7	38.17	114.2	36.85	110.7	35.38	107.0	34.20	99.7	32.61
	-8.5	-9.1	129.0	39.41	121.7	37.65	114.2	36.35	110.7	34.89	107.0	33.74	99.7	32.13
	-7.0	-7.6	129.0	38.68	121.7	36.89	114.2	35.59	110.7	34.14	107.0	33.01	99.7	31.39
	-5.0	-5.6	129.0	37.69	121.7	35.86	114.2	34.59	110.7	33.13	107.0	32.04	99.7	30.40
	-3.0	-3.7	129.0	36.68	121.7	34.83	114.2	33.59	110.7	32.13	107.0	31.10	99.7	29.43
	0.0	-0.7	129.0	35.19	121.7	33.28	114.2	32.10	110.7	30.64	107.0	29.67	99.7	27.97
	3.0	2.2	129.0	33.68	121.7	31.73	114.2	30.59	110.7	29.16	107.0	28.22	99.7	26.51
	5.0	4.1	129.0	32.70	121.7	30.70	114.2	29.59	110.7	28.16	107.0	27.27	99.7	25.52
	7.0	6	129.0	31.71	121.7	29.67	114.2	28.58	110.7	27.15	107.0	26.31	99.7	24.55
	9.0	7.9	129.0	28.62	121.7	26.79	114.2	25.82	110.7	24.52	107.0	23.76	99.7	22.17
	11.0	9.8	129.0	26.79	121.7	25.07	114.2	24.15	110.7	22.94	107.0	22.24	99.7	20.75
	13.0	11.8	129.0	25.15	121.7	23.54	114.2	22.67	110.7	21.54	107.0	20.87	99.7	19.48
15.0	13.7	129.0	23.79	121.7	22.27	114.2	21.45	110.7	20.39	107.0	19.75	99.7	18.43	

Note

1. TC: Total Capacity(kW), PI: Power Input(kW, Comp. + Outdoor fan motor)
2. Capacity tables show the average value of conditions which may occur.
3. In the range beyond the operation limit of the outdoor unit, continuous operation and performance can not be guaranteed. When selecting the outdoor units, avoid the air temperature range that is not guaranteed continuous operation.

7. Capacity Tables

◆ A(C)RUN840LLS5

Combination (%)	Outdoor air temp.		Indoor air temp. °C DB											
	°C DB	°C WB	16		18		20		21		22		24	
			TC	PI	TC	PI	TC	PI	TC	PI	TC	PI	TC	PI
130	-19.8	-20	136.2	56.97	136.2	59.15	135.3	61.07	135.3	64.00	135.3	66.80	135.3	71.21
	-18.8	-19	142.8	58.43	142.8	60.63	141.8	62.54	141.8	65.48	141.8	68.26	141.8	72.67
	-16.7	-17	156.7	61.51	156.7	63.72	155.7	65.62	155.7	68.57	155.7	71.34	155.7	75.75
	-13.7	-15	176.4	65.92	176.4	68.13	175.4	70.03	175.4	72.96	175.4	75.75	175.4	74.90
	-11.8	-13	186.4	68.70	186.4	70.90	185.1	72.82	185.1	75.75	185.1	75.34	185.1	74.36
	-9.8	-11	196.8	71.65	196.8	73.83	195.5	75.75	195.5	75.50	195.5	74.90	195.5	73.80
	-9.5	-10	201.6	72.09	201.6	74.27	200.3	75.75	200.3	75.47	197.1	74.84	197.1	73.73
	-8.5	-9.1	217.1	73.55	217.1	75.75	215.8	75.75	215.8	75.34	202.3	74.62	202.3	73.44
	-7.0	-7.6	240.7	75.75	240.7	75.95	239.1	75.72	239.1	75.15	239.1	74.27	219.2	73.01
	-5.0	-5.6	272.0	76.41	272.0	76.23	270.1	75.69	270.1	74.90	270.1	73.83	232.4	72.44
	-3.0	-3.7	303.4	77.08	303.4	76.50	301.4	75.69	295.6	74.64	285.2	73.39	245.6	71.89
	0.0	-0.7	304.0	78.09	304.0	76.89	303.1	75.66	295.6	74.27	285.2	72.74	265.1	71.04
	3.0	2.2	304.0	79.09	304.0	77.30	303.1	75.62	295.6	73.89	285.2	72.07	265.5	70.21
	5.0	4.1	304.0	79.76	304.0	77.58	303.1	75.60	295.6	73.64	285.2	71.63	265.5	69.64
	7.0	6	304.0	80.44	304.0	77.84	303.1	75.60	295.6	73.39	285.2	71.19	265.5	69.07
	9.0	7.9	304.0	81.21	304.0	78.59	303.1	76.32	295.6	74.09	285.2	71.89	265.5	69.73
	11.0	9.8	304.0	82.82	304.0	80.14	303.1	77.80	295.6	75.54	285.2	73.30	265.5	71.10
13.0	11.8	304.0	84.39	304.0	81.68	303.1	79.29	295.6	76.99	285.2	74.69	265.5	72.45	
15.0	13.7	304.0	85.97	304.0	83.20	303.1	80.79	295.6	78.44	285.2	76.10	265.5	73.83	
120	-19.8	-20	135.3	59.15	135.3	61.07	134.4	64.00	134.4	66.80	134.4	71.21	134.4	74.27
	-18.8	-19	141.8	60.63	141.8	62.54	140.9	65.48	140.9	68.26	140.9	72.67	140.9	75.75
	-16.7	-17	155.5	63.72	155.5	65.62	154.5	68.57	154.5	71.34	154.5	75.75	154.5	75.21
	-13.7	-15	175.1	68.13	175.1	70.03	174.2	72.96	174.2	75.75	174.2	75.06	174.2	74.43
	-11.8	-13	185.1	70.90	185.1	72.82	183.9	75.75	183.9	75.31	183.9	74.62	183.9	73.92
	-9.8	-11	195.5	73.83	195.5	75.75	194.2	75.40	194.2	74.84	194.2	74.18	194.2	73.42
	-9.5	-10	200.0	74.27	200.0	75.72	199.0	75.34	199.0	74.78	199.0	74.09	199.0	73.33
	-8.5	-9.1	215.6	75.75	215.6	75.60	214.2	75.15	214.2	74.55	207.8	73.86	207.8	73.07
	-7.0	-7.6	239.0	75.76	239.0	75.43	237.4	74.88	237.4	74.21	217.8	73.51	217.8	72.69
	-5.0	-5.6	270.1	75.78	270.1	75.19	268.5	74.53	268.5	73.74	268.5	73.07	230.8	72.16
	-3.0	-3.7	298.4	75.78	298.4	74.97	286.5	74.16	277.2	73.27	268.5	72.61	243.8	71.65
	0.0	-0.7	301.5	75.82	298.4	74.62	286.5	73.61	277.2	72.57	268.5	71.91	249.4	70.87
	3.0	2.2	301.5	75.82	298.4	74.27	286.5	73.07	277.2	71.89	268.5	71.22	249.4	70.08
	5.0	4.1	301.5	75.84	298.4	74.03	286.5	72.70	277.2	71.43	268.5	70.75	249.4	69.55
	7.0	6	301.5	75.86	298.4	73.81	286.5	72.35	277.2	70.97	268.5	70.30	249.4	69.05
	9.0	7.9	301.5	76.23	298.4	74.18	286.5	72.70	277.2	71.32	268.5	70.65	249.4	69.38
	11.0	9.8	301.5	77.36	298.4	75.25	286.5	73.77	277.2	72.35	268.5	71.69	249.4	70.40
13.0	11.8	301.5	78.46	298.4	76.32	286.5	74.84	277.2	73.40	268.5	72.70	249.4	71.41	
15.0	13.7	301.5	79.55	298.4	77.39	286.5	75.88	277.2	74.40	268.5	73.71	249.4	72.39	
110	-19.8	-20	134.4	61.07	134.4	64.00	133.7	66.80	133.7	71.21	133.7	74.27	133.7	75.75
	-18.8	-19	140.9	62.54	140.9	65.48	140.2	68.26	140.2	72.67	140.2	75.75	140.2	75.34
	-16.7	-17	154.8	65.62	154.8	68.57	153.7	71.34	153.7	75.75	153.7	75.00	153.7	74.46
	-13.7	-15	174.2	70.03	174.2	72.96	173.2	75.75	173.2	74.71	173.2	73.95	173.2	73.20
	-11.8	-13	184.1	72.82	184.1	75.75	182.9	75.06	182.9	74.05	182.9	73.26	182.9	72.41
	-9.8	-11	194.4	75.75	194.4	75.03	193.2	74.34	193.2	73.33	193.2	72.57	193.2	71.56
	-9.5	-10	199.0	75.65	199.0	74.93	197.7	74.24	197.7	73.23	197.7	72.44	197.7	71.43
	-8.5	-9.1	214.5	75.32	214.5	74.58	213.2	73.86	213.2	72.88	207.6	72.09	207.6	71.02
	-7.0	-7.6	237.8	74.81	237.8	74.05	236.1	73.33	236.1	72.35	217.7	71.56	217.7	70.39
	-5.0	-5.6	258.8	74.14	258.8	73.33	257.1	72.61	248.7	71.65	228.0	70.84	224.5	69.55
	-3.0	-3.7	273.9	73.48	273.9	72.63	257.1	71.89	248.7	70.96	240.3	70.14	224.5	68.72
	0.0	-0.7	289.8	72.47	273.9	71.56	257.1	70.80	248.7	69.90	240.3	69.07	224.5	67.46
	3.0	2.2	289.8	71.46	273.9	70.49	257.1	69.73	248.7	68.85	240.3	68.00	224.5	66.21
	5.0	4.1	289.8	70.78	273.9	69.77	257.1	69.01	248.7	68.16	240.3	67.31	224.5	65.36
	7.0	6	289.8	70.12	273.9	69.05	257.1	68.29	248.7	67.46	240.3	66.59	224.5	64.53
	9.0	7.9	289.8	70.06	273.9	69.01	257.1	68.23	248.7	67.41	240.3	66.55	224.5	64.47
	11.0	9.8	289.8	70.69	273.9	69.62	257.1	68.85	248.7	68.00	240.3	67.13	224.5	65.07
13.0	11.8	289.8	71.28	273.9	70.21	257.1	69.42	248.7	68.57	240.3	67.70	224.5	65.61	
15.0	13.7	289.8	71.85	273.9	70.77	257.1	69.97	248.7	69.12	240.3	68.23	224.5	66.12	

Note

1. TC: Total Capacity(kW), PI : Power Input(kW, Comp. + Outdoor fan motor)
2. Capacity tables show the average value of conditions which may occur.
3. In the range beyond the operation limit of the outdoor unit, continuous operation and performance can not be guaranteed. When selecting the outdoor units, avoid the air temperature range that is not guaranteed continuous operation.

7. Capacity Tables

Combination (%)		Heating Capacity (84HP)												
		Outdoor air temp.		Indoor air temp. °C DB										
		°C DB	°C WB	16		18		20		21		22		24
		TC	PI	TC	PI	TC	PI	TC	PI	TC	PI	TC	PI	
100	-19.8	-20	134.0	63.58	134.0	66.01	133.1	68.07	133.1	71.97	133.1	74.71	133.1	75.75
	-18.8	-19	140.4	64.79	139.5	67.22	139.5	69.55	139.5	73.20	139.5	75.75	139.5	75.05
	-16.7	-17	153.2	67.34	153.2	69.79	153.2	72.63	152.2	75.75	152.2	74.40	152.2	73.57
	-13.7	-15	173.5	70.99	173.5	73.44	172.5	75.75	172.5	73.99	172.5	72.48	172.5	71.46
	-11.8	-13	183.1	73.33	182.2	75.75	182.2	74.73	182.2	72.86	182.2	71.24	182.2	70.12
	-9.8	-11	193.3	75.75	193.3	74.68	192.2	73.64	192.2	71.69	192.2	69.95	192.2	68.70
	-9.5	-10	197.9	75.62	197.9	74.53	197.0	73.49	197.0	71.50	197.0	69.77	197.0	68.50
	-8.5	-9.1	213.2	75.15	213.2	73.99	212.3	72.94	227.7	70.93	220.0	69.10	205.1	67.79
	-7.0	-7.6	240.3	74.43	239.4	73.20	235.2	72.13	227.7	70.05	220.0	68.16	205.1	66.74
	-5.0	-5.6	250.7	73.51	248.4	72.13	235.2	71.06	227.7	68.86	220.0	66.87	205.1	65.32
	-3.0	-3.7	258.1	72.57	250.4	71.06	235.2	69.99	227.7	67.68	220.0	65.58	205.1	63.91
	0.0	-0.7	265.3	71.15	250.4	69.48	235.2	68.38	227.7	65.93	220.0	63.64	205.1	61.80
	3.0	2.2	265.3	69.74	250.4	67.87	235.2	66.74	227.7	64.16	220.0	61.70	205.1	59.69
	5.0	4.1	265.3	68.82	250.4	66.81	235.2	65.67	227.7	62.99	220.0	60.41	205.1	58.27
	7.0	6	265.3	67.87	250.4	65.74	235.2	64.60	227.7	61.80	220.0	59.12	205.1	56.88
	9.0	7.9	265.3	66.93	250.4	64.82	235.2	63.71	227.7	60.95	220.0	58.32	205.1	56.09
	11.0	9.8	265.3	66.61	250.4	64.51	235.2	63.40	227.7	60.66	220.0	58.05	205.1	55.81
	13.0	11.8	265.3	66.23	250.4	64.16	235.2	63.03	227.7	60.31	220.0	57.70	205.1	55.49
15.0	13.7	265.3	65.77	250.4	63.72	235.2	62.61	227.7	59.90	220.0	57.29	205.1	55.12	
90	-19.8	-20	133.4	59.90	133.4	64.31	132.5	67.37	132.5	68.85	132.5	67.87	132.5	66.17
	-18.8	-19	140.4	61.36	139.5	65.77	138.9	68.85	138.9	68.38	138.9	67.39	138.9	65.61
	-16.7	-17	153.2	64.44	153.2	68.85	152.5	68.00	152.5	67.43	152.5	66.37	152.5	64.47
	-13.7	-15	173.5	68.85	173.5	67.74	171.6	66.80	171.6	66.04	171.6	64.91	171.6	62.87
	-11.8	-13	183.1	68.22	182.2	67.05	181.3	66.04	181.3	65.17	181.3	63.99	181.3	61.85
	-9.8	-11	193.3	67.56	193.3	66.30	191.5	65.23	191.5	64.25	191.5	63.02	175.8	60.76
	-9.5	-10	197.9	67.46	197.9	66.20	196.1	65.13	196.1	64.10	196.1	62.87	180.0	60.60
	-8.5	-9.1	213.2	67.15	211.9	65.83	211.3	64.73	208.4	63.66	201.9	62.39	187.4	60.06
	-7.0	-7.6	240.3	66.65	228.7	65.29	215.1	64.12	208.4	62.96	201.9	61.64	187.4	59.25
	-5.0	-5.6	242.9	65.98	228.7	64.54	215.1	63.31	208.4	62.04	201.9	60.67	187.4	58.17
	-3.0	-3.7	242.9	65.32	228.7	63.81	215.1	62.52	208.4	61.11	201.9	59.71	187.4	57.10
	0.0	-0.7	242.9	64.34	228.7	62.70	215.1	61.32	208.4	59.74	201.9	58.23	187.4	55.48
	3.0	2.2	242.9	63.34	228.7	61.60	215.1	60.10	208.4	58.36	201.9	56.78	187.4	53.86
	5.0	4.1	242.9	62.68	228.7	60.85	215.1	59.30	208.4	57.42	201.9	55.81	187.4	52.79
	7.0	6	242.9	62.02	228.7	60.12	215.1	58.51	208.4	56.50	201.9	54.83	187.4	51.71
	9.0	7.9	242.9	61.17	228.7	59.30	215.1	57.70	208.4	55.74	201.9	54.08	187.4	50.99
	11.0	9.8	242.9	60.32	228.7	58.46	215.1	56.91	208.4	54.96	201.9	53.32	187.4	50.29
	13.0	11.8	242.9	59.47	228.7	57.64	215.1	56.09	208.4	54.17	201.9	52.57	187.4	49.57
15.0	13.7	242.9	58.62	228.7	56.81	215.1	55.30	208.4	53.41	201.9	51.81	187.4	48.87	
80	-19.8	-20	132.0	52.09	132.0	56.50	132.0	61.06	132.0	60.12	132.0	58.71	132.0	57.20
	-18.8	-19	138.3	53.57	138.3	61.06	138.3	60.63	138.3	59.65	138.3	58.23	138.3	56.72
	-16.7	-17	152.5	61.06	152.5	60.25	152.5	59.75	152.5	58.70	152.5	57.26	152.5	55.68
	-13.7	-15	179.7	60.02	176.0	59.12	171.6	58.49	171.6	57.29	171.6	55.84	167.4	54.21
	-11.8	-13	194.2	59.36	188.6	58.42	181.3	57.70	181.3	56.43	180.0	54.95	167.4	53.28
	-9.8	-11	200.3	58.67	194.4	57.66	191.5	56.85	186.8	55.50	180.0	54.01	167.4	52.31
	-9.5	-10	201.6	58.55	195.8	57.53	192.5	56.72	186.8	55.36	180.0	53.88	167.4	52.15
	-8.5	-9.1	209.1	58.20	205.1	57.16	192.5	56.31	186.8	54.89	180.0	53.41	167.4	51.65
	-7.0	-7.6	217.5	57.70	205.1	56.59	192.5	55.67	186.8	54.19	180.0	52.71	167.4	50.92
	-5.0	-5.6	217.5	57.00	205.1	55.84	192.5	54.83	186.8	53.28	180.0	51.77	167.4	49.94
	-3.0	-3.7	217.5	56.31	205.1	55.08	192.5	53.98	186.8	52.34	180.0	50.83	167.4	48.97
	0.0	-0.7	217.5	55.26	205.1	53.95	192.5	52.72	186.8	50.96	180.0	49.41	167.4	47.49
	3.0	2.2	217.5	54.23	205.1	52.81	192.5	51.46	186.8	49.57	180.0	48.02	167.4	46.01
	5.0	4.1	217.5	53.53	205.1	52.05	192.5	50.63	186.8	48.63	180.0	47.08	167.4	45.03
	7.0	6	217.5	52.84	205.1	51.30	192.5	49.78	186.8	47.71	180.0	46.14	167.4	44.06
	9.0	7.9	217.5	49.60	205.1	48.15	192.5	46.73	186.8	44.81	180.0	43.33	167.4	41.38
	11.0	9.8	217.5	46.04	205.1	44.71	192.5	43.39	186.8	41.57	180.0	40.21	167.4	38.39
	13.0	11.8	217.5	42.98	205.1	41.73	192.5	40.49	186.8	38.82	180.0	37.54	167.4	35.84
15.0	13.7	217.5	40.46	205.1	39.29	192.5	38.13	186.8	36.53	180.0	35.33	167.4	33.74	

Note

1. TC: Total Capacity(kW), PI: Power Input(kW, Comp. + Outdoor fan motor)
2. Capacity tables show the average value of conditions which may occur.
3. In the range beyond the operation limit of the outdoor unit, continuous operation and performance can not be guaranteed. When selecting the outdoor units, avoid the air temperature range that is not guaranteed continuous operation.

7. Capacity Tables

Combination (%)		Heating Capacity (84HP)												
		Outdoor air temp.		Indoor air temp. °C DB										
		°C DB	°C WB	16		18		20		21		22		24
		TC	PI	TC	PI	TC	PI	TC	PI	TC	PI	TC	PI	
70	-19.8	-20	132.0	55.18	132.0	56.65	132.0	55.68	132.0	54.14	132.0	52.68	132.0	51.08
	-18.8	-19	138.3	56.65	138.3	56.19	138.3	55.21	138.3	53.66	138.3	52.20	138.3	50.55
	-16.7	-17	152.5	55.78	152.5	55.21	152.5	54.17	152.5	52.59	152.5	51.17	143.2	49.47
	-13.7	-15	184.5	54.55	174.2	53.81	163.8	52.72	158.3	51.11	153.5	49.69	143.2	47.90
	-11.8	-13	184.5	53.75	174.2	52.92	163.8	51.80	158.3	50.14	153.5	48.75	143.2	46.92
	-9.8	-11	184.5	52.94	174.2	51.99	163.8	50.83	158.3	49.15	153.5	47.77	143.2	45.88
	-9.5	-10	184.5	52.81	174.2	51.84	163.8	50.67	158.3	49.00	153.5	47.62	143.2	45.72
	-8.5	-9.1	184.5	52.40	174.2	51.39	163.8	50.20	158.3	48.49	153.5	47.14	143.2	45.22
	-7.0	-7.6	184.5	51.78	174.2	50.67	163.8	49.47	158.3	47.75	153.5	46.39	143.2	44.43
	-5.0	-5.6	184.5	50.96	174.2	49.76	163.8	48.49	158.3	46.74	153.5	45.41	143.2	43.39
	-3.0	-3.7	184.5	50.13	174.2	48.82	163.8	47.53	158.3	45.75	153.5	44.43	143.2	42.35
	0.0	-0.7	184.5	48.90	174.2	47.42	163.8	46.07	158.3	44.24	153.5	42.95	143.2	40.78
	3.0	2.2	184.5	47.65	174.2	46.01	163.8	44.62	158.3	42.75	153.5	41.47	143.2	39.24
	5.0	4.1	184.5	46.83	174.2	45.09	163.8	43.65	158.3	41.75	153.5	40.50	143.2	38.19
	7.0	6	184.5	46.01	174.2	44.15	163.8	42.67	158.3	40.75	153.5	39.52	143.2	37.15
	9.0	7.9	184.5	41.53	174.2	39.87	163.8	38.54	158.3	36.80	153.5	35.68	143.2	33.56
11.0	9.8	184.5	38.67	174.2	37.12	163.8	35.88	158.3	34.26	153.5	33.22	143.2	31.23	
13.0	11.8	184.5	36.18	174.2	34.73	163.8	33.57	158.3	32.05	153.5	31.08	143.2	29.22	
15.0	13.7	184.5	34.13	174.2	32.74	163.8	31.64	158.3	30.22	153.5	29.31	143.2	27.54	
60	-19.8	-20	158.3	52.24	149.9	51.27	132.0	49.76	132.0	48.27	131.1	46.80	122.7	45.19
	-18.8	-19	158.3	51.81	149.9	50.79	138.3	49.25	135.7	47.77	131.1	46.32	122.7	44.68
	-16.7	-17	158.3	50.93	149.9	49.76	140.5	48.22	135.7	46.74	131.1	45.28	122.7	43.58
	-13.7	-15	158.3	49.64	149.9	48.31	140.5	46.74	135.7	45.26	131.1	43.80	122.7	42.01
	-11.8	-13	158.3	48.84	149.9	47.37	140.5	45.78	135.7	44.34	131.1	42.86	122.7	41.03
	-9.8	-11	158.3	47.99	149.9	46.41	140.5	44.78	135.7	43.33	131.1	41.88	122.7	39.98
	-9.5	-10	158.3	47.84	149.9	46.26	140.5	44.65	135.7	43.18	131.1	41.72	122.7	39.83
	-8.5	-9.1	158.3	47.42	149.9	45.76	140.5	44.15	135.7	42.70	131.1	41.24	122.7	39.30
	-7.0	-7.6	158.3	46.79	149.9	45.04	140.5	43.40	135.7	41.94	131.1	40.50	122.7	38.54
	-5.0	-5.6	158.3	45.94	149.9	44.06	140.5	42.42	135.7	40.96	131.1	39.52	122.7	37.49
	-3.0	-3.7	158.3	45.07	149.9	43.10	140.5	41.40	135.7	39.96	131.1	38.54	122.7	36.46
	0.0	-0.7	158.3	43.80	149.9	41.63	140.5	39.92	135.7	38.48	131.1	37.05	122.7	34.88
	3.0	2.2	158.3	42.51	149.9	40.18	140.5	38.44	135.7	37.00	131.1	35.57	122.7	33.31
	5.0	4.1	158.3	41.66	149.9	39.20	140.5	37.43	135.7	36.01	131.1	34.57	122.7	32.28
	7.0	6	158.3	40.81	149.9	38.22	140.5	36.43	135.7	35.01	131.1	33.59	122.7	31.23
	9.0	7.9	158.3	36.42	149.9	34.10	140.5	32.52	135.7	31.25	131.1	29.97	122.7	27.89
11.0	9.8	158.3	34.00	149.9	31.86	140.5	30.35	135.7	29.18	131.1	27.98	122.7	26.03	
13.0	11.8	158.3	31.86	149.9	29.84	140.5	28.45	135.7	27.33	131.1	26.22	122.7	24.38	
15.0	13.7	158.3	30.10	149.9	28.20	140.5	26.88	135.7	25.84	131.1	24.77	122.7	23.04	
50	-19.8	-20	132.1	46.80	124.7	45.16	117.0	43.64	113.4	42.07	109.6	40.65	102.1	39.10
	-18.8	-19	132.1	46.29	124.7	44.62	117.0	43.11	113.4	41.57	109.6	40.15	102.1	38.58
	-16.7	-17	132.1	45.19	124.7	43.51	117.0	42.01	113.4	40.49	109.6	39.10	102.1	37.53
	-13.7	-15	132.1	43.64	124.7	41.91	117.0	40.46	113.4	38.92	109.6	37.60	102.1	35.99
	-11.8	-13	132.1	42.66	124.7	40.87	117.0	39.48	113.4	37.94	109.6	36.68	102.1	35.04
	-9.8	-11	132.1	41.63	124.7	39.80	117.0	38.44	113.4	36.90	109.6	35.67	102.1	34.02
	-9.5	-10	132.1	41.47	124.7	39.65	117.0	38.28	113.4	36.75	109.6	35.52	102.1	33.87
	-8.5	-9.1	132.1	40.94	124.7	39.11	117.0	37.75	113.4	36.24	109.6	35.04	102.1	33.37
	-7.0	-7.6	132.1	40.17	124.7	38.32	117.0	36.97	113.4	35.46	109.6	34.28	102.1	32.61
	-5.0	-5.6	132.1	39.14	124.7	37.25	117.0	35.92	113.4	34.41	109.6	33.28	102.1	31.58
	-3.0	-3.7	132.1	38.10	124.7	36.18	117.0	34.89	113.4	33.37	109.6	32.30	102.1	30.57
	0.0	-0.7	132.1	36.55	124.7	34.57	117.0	33.34	113.4	31.82	109.6	30.81	102.1	29.05
	3.0	2.2	132.1	34.98	124.7	32.96	117.0	31.77	113.4	30.28	109.6	29.31	102.1	27.54
	5.0	4.1	132.1	33.96	124.7	31.89	117.0	30.73	113.4	29.24	109.6	28.33	102.1	26.50
	7.0	6	132.1	32.93	124.7	30.82	117.0	29.68	113.4	28.20	109.6	27.32	102.1	25.49
	9.0	7.9	132.1	29.72	124.7	27.83	117.0	26.82	113.4	25.47	109.6	24.68	102.1	23.03
11.0	9.8	132.1	27.82	124.7	26.04	117.0	25.08	113.4	23.83	109.6	23.09	102.1	21.55	
13.0	11.8	132.1	26.12	124.7	24.45	117.0	23.55	113.4	22.37	109.6	21.68	102.1	20.23	
15.0	13.7	132.1	24.71	124.7	23.13	117.0	22.28	113.4	21.17	109.6	20.52	102.1	19.14	

Note

1. TC: Total Capacity(kW), PI: Power Input(kW, Comp. + Outdoor fan motor)
2. Capacity tables show the average value of conditions which may occur.
3. In the range beyond the operation limit of the outdoor unit, continuous operation and performance can not be guaranteed. When selecting the outdoor units, avoid the air temperature range that is not guaranteed continuous operation.

7. Capacity Tables

◆ A(C)RUN860LLS5

Combination (%)	Outdoor air temp.		Heating Capacity (86HP)											
			Indoor air temp. °C DB											
	°C DB	°C WB	16		18		20		21		22		24	
		TC	PI	TC	PI	TC	PI	TC	PI	TC	PI	TC	PI	
130	-19.8	-20	139.4	59.87	139.4	62.17	138.5	64.18	138.5	67.27	138.5	70.21	138.5	74.85
	-18.8	-19	146.2	61.40	146.2	63.72	145.1	65.73	145.1	68.82	145.1	71.74	145.1	76.38
	-16.7	-17	160.4	64.65	160.4	66.97	159.4	68.96	159.4	72.06	159.4	74.99	159.4	79.62
	-13.7	-15	180.6	69.28	180.6	71.60	179.5	73.60	179.5	76.68	179.5	79.62	179.5	78.73
	-11.8	-13	190.8	72.21	190.8	74.52	189.5	76.54	189.5	79.62	189.5	79.19	189.5	78.16
	-9.8	-11	201.5	75.31	201.5	77.61	200.1	79.62	200.1	79.35	200.1	78.73	200.1	77.57
	-9.5	-10	206.4	75.77	206.4	78.07	205.1	79.62	205.1	79.32	201.8	78.66	201.8	77.49
	-8.5	-9.1	222.3	77.31	222.3	79.62	220.9	79.62	220.9	79.19	207.1	78.43	207.1	77.20
	-7.0	-7.6	246.4	79.62	246.4	79.83	244.8	79.59	244.8	78.99	244.8	78.07	224.4	76.74
	-5.0	-5.6	278.5	80.32	278.5	80.12	276.6	79.56	276.6	78.73	276.6	77.61	237.9	76.14
	-3.0	-3.7	310.6	81.02	310.6	80.41	308.6	79.55	302.6	78.46	292.0	77.15	251.4	75.56
	0.0	-0.7	311.2	82.08	311.2	80.82	310.3	79.53	302.6	78.06	292.0	76.45	271.4	74.66
	3.0	2.2	311.2	83.14	311.2	81.25	310.3	79.49	302.6	77.67	292.0	75.75	271.8	73.79
	5.0	4.1	311.2	83.84	311.2	81.54	310.3	79.46	302.6	77.40	292.0	75.29	271.8	73.20
	7.0	6	311.2	84.55	311.2	81.82	310.3	79.46	302.6	77.14	292.0	74.83	271.8	72.60
	9.0	7.9	311.2	85.36	311.2	82.61	310.3	80.22	302.6	77.88	292.0	75.56	271.8	73.30
	11.0	9.8	311.2	87.05	311.2	84.23	310.3	81.78	302.6	79.39	292.0	77.05	271.8	74.73
13.0	11.8	311.2	88.70	311.2	85.85	310.3	83.34	302.6	80.92	292.0	78.50	271.8	76.16	
15.0	13.7	311.2	90.36	311.2	87.45	310.3	84.92	302.6	82.44	292.0	79.99	271.8	77.60	
120	-19.8	-20	138.5	62.17	138.5	64.18	137.6	67.27	137.6	70.21	137.6	74.85	137.6	78.07
	-18.8	-19	145.1	63.72	145.1	65.73	144.2	68.82	144.2	71.74	144.2	76.38	144.2	79.62
	-16.7	-17	159.1	66.97	159.1	68.96	158.2	72.06	158.2	74.99	158.2	79.62	158.2	79.05
	-13.7	-15	179.3	71.60	179.3	73.60	178.3	76.68	178.3	79.62	178.3	78.89	178.3	78.23
	-11.8	-13	189.5	74.52	189.5	76.54	188.3	79.62	188.3	79.16	188.3	78.43	188.3	77.70
	-9.8	-11	200.1	77.61	200.1	79.62	198.8	79.25	198.8	78.67	198.8	77.97	198.8	77.17
	-9.5	-10	204.7	78.07	204.7	79.58	203.7	79.19	203.7	78.60	203.7	77.88	203.7	77.08
	-8.5	-9.1	220.7	79.62	220.7	79.46	219.3	78.99	219.3	78.36	212.8	77.63	212.8	76.81
	-7.0	-7.6	244.7	79.63	244.7	79.28	243.1	78.70	243.1	78.00	222.9	77.27	222.9	76.41
	-5.0	-5.6	276.5	79.65	276.5	79.03	274.9	78.33	274.9	77.51	274.9	76.80	236.2	75.84
	-3.0	-3.7	305.5	79.65	305.5	78.80	293.4	77.95	283.8	77.01	274.9	76.31	249.5	75.31
	0.0	-0.7	308.7	79.69	305.5	78.43	293.4	77.38	283.8	76.28	274.9	75.58	255.3	74.49
	3.0	2.2	308.7	79.70	305.5	78.06	293.4	76.81	283.8	75.56	274.9	74.85	255.3	73.66
	5.0	4.1	308.7	79.72	305.5	77.81	293.4	76.42	283.8	75.08	274.9	74.37	255.3	73.11
	7.0	6	308.7	79.73	305.5	77.58	293.4	76.05	283.8	74.59	274.9	73.89	255.3	72.57
	9.0	7.9	308.7	80.13	305.5	77.97	293.4	76.41	283.8	74.96	274.9	74.26	255.3	72.93
	11.0	9.8	308.7	81.31	305.5	79.10	293.4	77.54	283.8	76.05	274.9	75.35	255.3	74.00
13.0	11.8	308.7	82.47	305.5	80.22	293.4	78.66	283.8	77.14	274.9	76.41	255.3	75.06	
15.0	13.7	308.7	83.61	305.5	81.34	293.4	79.75	283.8	78.20	274.9	77.47	255.3	76.09	
110	-19.8	-20	137.6	64.18	137.6	67.27	136.9	70.21	136.9	74.85	136.9	78.07	136.9	79.62
	-18.8	-19	144.2	65.73	144.2	68.82	143.5	71.74	143.5	76.38	143.5	79.62	143.5	79.19
	-16.7	-17	158.4	68.96	158.4	72.06	157.3	74.99	157.3	79.62	157.3	78.83	157.3	78.27
	-13.7	-15	178.3	73.60	178.3	76.68	177.2	79.62	177.2	78.52	177.2	77.72	177.2	76.94
	-11.8	-13	188.5	76.54	188.5	79.62	187.2	78.90	187.2	77.83	187.2	77.01	187.2	76.11
	-9.8	-11	199.0	79.62	199.0	78.87	197.8	78.14	197.8	77.08	197.8	76.27	197.8	75.22
	-9.5	-10	203.7	79.52	203.7	78.76	202.4	78.04	202.4	76.97	202.4	76.14	202.4	75.09
	-8.5	-9.1	219.6	79.16	219.6	78.39	218.2	77.64	218.2	76.60	212.6	75.78	212.6	74.65
	-7.0	-7.6	243.4	78.63	243.4	77.83	241.8	77.08	241.8	76.05	222.9	75.22	222.9	73.99
	-5.0	-5.6	265.0	77.93	265.0	77.08	263.3	76.32	254.7	75.31	233.5	74.46	229.9	73.11
	-3.0	-3.7	280.5	77.23	280.5	76.34	263.3	75.56	254.7	74.58	246.1	73.73	229.9	72.23
	0.0	-0.7	296.7	76.18	280.5	75.22	263.3	74.42	254.7	73.47	246.1	72.60	229.9	70.91
	3.0	2.2	296.7	75.11	280.5	74.09	263.3	73.29	254.7	72.37	246.1	71.48	229.9	69.59
	5.0	4.1	296.7	74.39	280.5	73.33	263.3	72.53	254.7	71.64	246.1	70.74	229.9	68.70
	7.0	6	296.7	73.70	280.5	72.58	263.3	71.77	254.7	70.91	246.1	69.99	229.9	67.83
	9.0	7.9	296.7	73.64	280.5	72.54	263.3	71.71	254.7	70.85	246.1	69.95	229.9	67.77
	11.0	9.8	296.7	74.30	280.5	73.17	263.3	72.37	254.7	71.48	246.1	70.56	229.9	68.40
13.0	11.8	296.7	74.92	280.5	73.80	263.3	72.97	254.7	72.08	246.1	71.15	229.9	68.96	
15.0	13.7	296.7	75.52	280.5	74.39	263.3	73.54	254.7	72.65	246.1	71.71	229.9	69.50	

Note

1. TC: Total Capacity(kW), PI : Power Input(kW, Comp. + Outdoor fan motor)
2. Capacity tables show the average value of conditions which may occur.
3. In the range beyond the operation limit of the outdoor unit, continuous operation and performance can not be guaranteed. When selecting the outdoor units, avoid the air temperature range that is not guaranteed continuous operation.

7. Capacity Tables

Combination (%)		Heating Capacity (86HP)												
		Outdoor air temp.		Indoor air temp. °C DB										
		°C DB	°C WB	16		18		20		21		22		24
		TC	PI	TC	PI	TC	PI	TC	PI	TC	PI	TC	PI	
100	-19.8	-20	137.2	66.83	137.2	69.38	136.2	71.54	136.2	75.65	136.2	78.53	136.2	79.62
	-18.8	-19	143.8	68.09	142.8	70.65	142.8	73.10	142.8	76.94	142.8	79.62	142.8	78.89
	-16.7	-17	156.8	70.78	156.8	73.35	156.8	76.34	155.7	79.62	155.7	78.20	155.7	77.33
	-13.7	-15	177.6	74.62	177.6	77.19	176.6	79.62	176.6	77.77	176.6	76.18	176.6	75.11
	-11.8	-13	187.5	77.07	186.5	79.62	186.5	78.55	186.5	76.58	186.5	74.88	186.5	73.70
	-9.8	-11	197.8	79.62	197.8	78.50	196.8	77.41	196.8	75.35	196.8	73.53	196.8	72.21
	-9.5	-10	202.6	79.49	202.6	78.34	201.7	77.24	201.7	75.16	201.7	73.33	201.7	72.00
	-8.5	-9.1	218.3	78.99	218.3	77.77	217.3	76.67	233.1	74.55	225.3	72.64	210.0	71.25
	-7.0	-7.6	246.1	78.23	245.1	76.94	240.8	75.82	233.1	73.63	225.3	71.64	210.0	70.15
	-5.0	-5.6	256.7	77.26	254.3	75.82	240.8	74.69	233.1	72.38	225.3	70.28	210.0	68.66
	-3.0	-3.7	264.3	76.28	256.3	74.69	240.8	73.57	233.1	71.14	225.3	68.93	210.0	67.17
	0.0	-0.7	271.6	74.79	256.3	73.03	240.8	71.87	233.1	69.29	225.3	66.90	210.0	64.96
	3.0	2.2	271.6	73.30	256.3	71.34	240.8	70.15	233.1	67.44	225.3	64.85	210.0	62.74
	5.0	4.1	271.6	72.33	256.3	70.22	240.8	69.03	233.1	66.20	225.3	63.50	210.0	61.25
	7.0	6	271.6	71.34	256.3	69.09	240.8	67.90	233.1	64.96	225.3	62.14	210.0	59.78
	9.0	7.9	271.6	70.35	256.3	68.13	240.8	66.96	233.1	64.06	225.3	61.30	210.0	58.95
	11.0	9.8	271.6	70.01	256.3	67.81	240.8	66.64	233.1	63.76	225.3	61.01	210.0	58.66
	13.0	11.8	271.6	69.62	256.3	67.43	240.8	66.25	233.1	63.39	225.3	60.65	210.0	58.33
15.0	13.7	271.6	69.13	256.3	66.97	240.8	65.81	233.1	62.96	225.3	60.22	210.0	57.93	
90	-19.8	-20	136.5	62.95	136.5	67.59	135.6	70.81	135.6	72.37	135.6	71.34	135.6	69.55
	-18.8	-19	143.8	64.49	142.8	69.13	142.2	72.37	142.2	71.87	142.2	70.84	142.2	68.96
	-16.7	-17	156.8	67.73	156.8	72.37	156.1	71.48	156.1	70.88	156.1	69.76	156.1	67.77
	-13.7	-15	177.6	72.37	177.6	71.21	175.7	70.22	175.7	69.42	175.7	68.22	175.7	66.08
	-11.8	-13	187.5	71.71	186.5	70.47	185.6	69.42	185.6	68.50	185.6	67.26	185.6	65.01
	-9.8	-11	197.8	71.02	197.8	69.69	196.1	68.57	196.1	67.53	196.1	66.24	180.0	63.86
	-9.5	-10	202.6	70.91	202.6	69.58	200.8	68.45	200.8	67.37	200.8	66.08	184.3	63.70
	-8.5	-9.1	218.3	70.58	216.9	69.19	216.4	68.03	213.4	66.91	206.7	65.58	191.9	63.13
	-7.0	-7.6	246.1	70.05	234.2	68.63	220.3	67.40	213.4	66.18	206.7	64.79	191.9	62.28
	-5.0	-5.6	248.7	69.35	234.2	67.83	220.3	66.55	213.4	65.21	206.7	63.77	191.9	61.14
	-3.0	-3.7	248.7	68.66	234.2	67.07	220.3	65.72	213.4	64.23	206.7	62.76	191.9	60.01
	0.0	-0.7	248.7	67.63	234.2	65.91	220.3	64.45	213.4	62.79	206.7	61.21	191.9	58.32
	3.0	2.2	248.7	66.57	234.2	64.75	220.3	63.17	213.4	61.34	206.7	59.68	191.9	56.61
	5.0	4.1	248.7	65.88	234.2	63.96	220.3	62.33	213.4	60.35	206.7	58.66	191.9	55.48
	7.0	6	248.7	65.19	234.2	63.20	220.3	61.50	213.4	59.39	206.7	57.63	191.9	54.35
	9.0	7.9	248.7	64.30	234.2	62.33	220.3	60.65	213.4	58.59	206.7	56.84	191.9	53.59
	11.0	9.8	248.7	63.40	234.2	61.45	220.3	59.82	213.4	57.76	206.7	56.04	191.9	52.86
	13.0	11.8	248.7	62.51	234.2	60.58	220.3	58.96	213.4	56.94	206.7	55.26	191.9	52.10
15.0	13.7	248.7	61.61	234.2	59.72	220.3	58.13	213.4	56.14	206.7	54.46	191.9	51.37	
80	-19.8	-20	135.2	54.75	135.2	59.38	135.2	64.18	135.2	63.20	135.2	61.71	135.2	60.12
	-18.8	-19	141.5	56.30	141.5	64.18	141.5	63.73	141.5	62.70	141.5	61.21	141.5	59.61
	-16.7	-17	156.1	64.18	156.1	63.33	156.1	62.80	156.1	61.70	156.1	60.19	156.1	58.52
	-13.7	-15	183.9	63.09	180.2	62.14	175.7	61.48	175.7	60.22	175.7	58.70	171.4	56.98
	-11.8	-13	198.8	62.39	193.1	61.40	185.6	60.64	185.6	59.32	184.2	57.76	171.4	56.00
	-9.8	-11	205.1	61.66	199.0	60.60	196.1	59.75	191.2	58.33	184.2	56.77	171.4	54.98
	-9.5	-10	206.4	61.54	200.4	60.47	197.1	59.62	191.2	58.19	184.2	56.64	171.4	54.82
	-8.5	-9.1	214.1	61.18	210.0	60.08	197.1	59.18	191.2	57.69	184.2	56.14	171.4	54.29
	-7.0	-7.6	222.7	60.64	210.0	59.48	197.1	58.52	191.2	56.96	184.2	55.40	171.4	53.52
	-5.0	-5.6	222.7	59.91	210.0	58.69	197.1	57.63	191.2	56.00	184.2	54.41	171.4	52.49
	-3.0	-3.7	222.7	59.18	210.0	57.90	197.1	56.74	191.2	55.01	184.2	53.43	171.4	51.47
	0.0	-0.7	222.7	58.09	210.0	56.70	197.1	55.42	191.2	53.56	184.2	51.94	171.4	49.92
	3.0	2.2	222.7	57.00	210.0	55.51	197.1	54.09	191.2	52.10	184.2	50.47	171.4	48.36
	5.0	4.1	222.7	56.27	210.0	54.71	197.1	53.22	191.2	51.11	184.2	49.48	171.4	47.33
	7.0	6	222.7	55.54	210.0	53.92	197.1	52.33	191.2	50.15	184.2	48.49	171.4	46.31
	9.0	7.9	222.7	52.14	210.0	50.61	197.1	49.12	191.2	47.09	184.2	45.54	171.4	43.49
	11.0	9.8	222.7	48.40	210.0	47.00	197.1	45.60	191.2	43.70	184.2	42.26	171.4	40.35
	13.0	11.8	222.7	45.17	210.0	43.86	197.1	42.56	191.2	40.80	184.2	39.45	171.4	37.67
15.0	13.7	222.7	42.53	210.0	41.29	197.1	40.07	191.2	38.40	184.2	37.14	171.4	35.47	

Note

1. TC: Total Capacity(kW), PI: Power Input(kW, Comp. + Outdoor fan motor)
2. Capacity tables show the average value of conditions which may occur.
3. In the range beyond the operation limit of the outdoor unit, continuous operation and performance can not be guaranteed. When selecting the outdoor units, avoid the air temperature range that is not guaranteed continuous operation.

7. Capacity Tables

Combination (%)		Heating Capacity (86HP)												
		Outdoor air temp.		Indoor air temp. °C DB										
		°C DB	°C WB	16		18		20		21		22		24
		TC	PI	TC	PI	TC	PI	TC	PI	TC	PI	TC	PI	
70	-19.8	-20	135.2	58.00	135.2	59.54	135.2	58.53	135.2	56.91	135.2	55.37	135.2	53.69
	-18.8	-19	141.5	59.54	141.5	59.06	141.5	58.02	141.5	56.40	141.5	54.87	141.5	53.13
	-16.7	-17	156.1	58.63	156.1	58.03	156.1	56.93	156.1	55.28	156.1	53.78	146.6	52.00
	-13.7	-15	188.9	57.33	178.3	56.56	167.7	55.41	162.0	53.72	157.1	52.23	146.6	50.35
	-11.8	-13	188.9	56.50	178.3	55.62	167.7	54.45	162.0	52.70	157.1	51.24	146.6	49.32
	-9.8	-11	188.9	55.64	178.3	54.64	167.7	53.42	162.0	51.66	157.1	50.21	146.6	48.22
	-9.5	-10	188.9	55.51	178.3	54.48	167.7	53.26	162.0	51.50	157.1	50.05	146.6	48.06
	-8.5	-9.1	188.9	55.07	178.3	54.01	167.7	52.76	162.0	50.97	157.1	49.55	146.6	47.52
	-7.0	-7.6	188.9	54.42	178.3	53.26	167.7	52.00	162.0	50.18	157.1	48.76	146.6	46.70
	-5.0	-5.6	188.9	53.56	178.3	52.30	167.7	50.97	162.0	49.13	157.1	47.73	146.6	45.60
	-3.0	-3.7	188.9	52.69	178.3	51.31	167.7	49.95	162.0	48.08	157.1	46.70	146.6	44.52
	0.0	-0.7	188.9	51.40	178.3	49.84	167.7	48.42	162.0	46.50	157.1	45.15	146.6	42.87
	3.0	2.2	188.9	50.08	178.3	48.36	167.7	46.90	162.0	44.94	157.1	43.59	146.6	41.24
	5.0	4.1	188.9	49.22	178.3	47.39	167.7	45.88	162.0	43.88	157.1	42.57	146.6	40.14
	7.0	6	188.9	48.36	178.3	46.41	167.7	44.85	162.0	42.83	157.1	41.54	146.6	39.05
	9.0	7.9	188.9	43.66	178.3	41.91	167.7	40.51	162.0	38.68	157.1	37.50	146.6	35.27
	11.0	9.8	188.9	40.65	178.3	39.02	167.7	37.72	162.0	36.01	157.1	34.91	146.6	32.83
13.0	11.8	188.9	38.03	178.3	36.50	167.7	35.28	162.0	33.69	157.1	32.67	146.6	30.71	
15.0	13.7	188.9	35.87	178.3	34.41	167.7	33.26	162.0	31.77	157.1	30.81	146.6	28.95	
60	-19.8	-20	162.0	54.91	153.4	53.89	135.2	52.29	135.2	50.74	134.2	49.19	125.6	47.50
	-18.8	-19	162.0	54.45	153.4	53.38	141.5	51.77	139.0	50.21	134.2	48.68	125.6	46.96
	-16.7	-17	162.0	53.52	153.4	52.29	143.9	50.68	139.0	49.12	134.2	47.59	125.6	45.80
	-13.7	-15	162.0	52.17	153.4	50.77	143.9	49.12	139.0	47.57	134.2	46.03	125.6	44.15
	-11.8	-13	162.0	51.33	153.4	49.79	143.9	48.12	139.0	46.60	134.2	45.05	125.6	43.12
	-9.8	-11	162.0	50.43	153.4	48.78	143.9	47.07	139.0	45.55	134.2	44.01	125.6	42.02
	-9.5	-10	162.0	50.28	153.4	48.62	143.9	46.93	139.0	45.38	134.2	43.85	125.6	41.86
	-8.5	-9.1	162.0	49.84	153.4	48.10	143.9	46.40	139.0	44.88	134.2	43.35	125.6	41.31
	-7.0	-7.6	162.0	49.18	153.4	47.34	143.9	45.61	139.0	44.08	134.2	42.57	125.6	40.50
	-5.0	-5.6	162.0	48.28	153.4	46.31	143.9	44.58	139.0	43.05	134.2	41.53	125.6	39.41
	-3.0	-3.7	162.0	47.37	153.4	45.30	143.9	43.52	139.0	42.00	134.2	40.50	125.6	38.32
	0.0	-0.7	162.0	46.04	153.4	43.76	143.9	41.96	139.0	40.44	134.2	38.95	125.6	36.66
	3.0	2.2	162.0	44.68	153.4	42.23	143.9	40.40	139.0	38.88	134.2	37.39	125.6	35.01
	5.0	4.1	162.0	43.79	153.4	41.20	143.9	39.34	139.0	37.85	134.2	36.34	125.6	33.92
	7.0	6	162.0	42.89	153.4	40.17	143.9	38.29	139.0	36.80	134.2	35.31	125.6	32.83
	9.0	7.9	162.0	38.28	153.4	35.84	143.9	34.18	139.0	32.85	134.2	31.50	125.6	29.31
	11.0	9.8	162.0	35.74	153.4	33.49	143.9	31.91	139.0	30.67	134.2	29.41	125.6	27.36
13.0	11.8	162.0	33.49	153.4	31.36	143.9	29.91	139.0	28.72	134.2	27.56	125.6	25.63	
15.0	13.7	162.0	31.63	153.4	29.64	143.9	28.26	139.0	27.16	134.2	26.04	125.6	24.22	
50	-19.8	-20	135.3	49.18	127.6	47.46	119.8	45.86	116.1	44.22	112.2	42.72	104.5	41.09
	-18.8	-19	135.3	48.65	127.6	46.90	119.8	45.31	116.1	43.68	112.2	42.19	104.5	40.54
	-16.7	-17	135.3	47.49	127.6	45.73	119.8	44.15	116.1	42.55	112.2	41.10	104.5	39.44
	-13.7	-15	135.3	45.87	127.6	44.05	119.8	42.52	116.1	40.91	112.2	39.52	104.5	37.82
	-11.8	-13	135.3	44.84	127.6	42.96	119.8	41.49	116.1	39.88	112.2	38.55	104.5	36.83
	-9.8	-11	135.3	43.75	127.6	41.83	119.8	40.40	116.1	38.78	112.2	37.49	104.5	35.76
	-9.5	-10	135.3	43.59	127.6	41.67	119.8	40.23	116.1	38.62	112.2	37.33	104.5	35.60
	-8.5	-9.1	135.3	43.03	127.6	41.10	119.8	39.68	116.1	38.09	112.2	36.83	104.5	35.07
	-7.0	-7.6	135.3	42.22	127.6	40.27	119.8	38.85	116.1	37.26	112.2	36.03	104.5	34.27
	-5.0	-5.6	135.3	41.14	127.6	39.15	119.8	37.76	116.1	36.17	112.2	34.98	104.5	33.19
	-3.0	-3.7	135.3	40.04	127.6	38.02	119.8	36.67	116.1	35.07	112.2	33.95	104.5	32.13
	0.0	-0.7	135.3	38.42	127.6	36.33	119.8	35.04	116.1	33.45	112.2	32.39	104.5	30.53
	3.0	2.2	135.3	36.77	127.6	34.64	119.8	33.39	116.1	31.83	112.2	30.81	104.5	28.94
	5.0	4.1	135.3	35.69	127.6	33.52	119.8	32.30	116.1	30.74	112.2	29.77	104.5	27.85
	7.0	6	135.3	34.61	127.6	32.39	119.8	31.20	116.1	29.64	112.2	28.72	104.5	26.80
	9.0	7.9	135.3	31.24	127.6	29.25	119.8	28.19	116.1	26.77	112.2	25.94	104.5	24.20
	11.0	9.8	135.3	29.24	127.6	27.37	119.8	26.36	116.1	25.05	112.2	24.27	104.5	22.65
13.0	11.8	135.3	27.46	127.6	25.70	119.8	24.75	116.1	23.52	112.2	22.78	104.5	21.26	
15.0	13.7	135.3	25.97	127.6	24.32	119.8	23.42	116.1	22.25	112.2	21.56	104.5	20.11	

Note

1. TC: Total Capacity(kW), PI: Power Input(kW, Comp. + Outdoor fan motor)
2. Capacity tables show the average value of conditions which may occur.
3. In the range beyond the operation limit of the outdoor unit, continuous operation and performance can not be guaranteed. When selecting the outdoor units, avoid the air temperature range that is not guaranteed continuous operation.

7. Capacity Tables

◆ A(C)RUN880LLS5

Combination (%)	Outdoor air temp.		Heating Capacity (88HP)											
			Indoor air temp. °C DB											
	°C DB	°C WB	16		18		20		21		22		24	
		TC	PI	TC	PI	TC	PI	TC	PI	TC	PI	TC	PI	
130	-19.8	-20	142.7	59.96	142.7	62.26	141.7	64.28	141.7	67.37	141.7	70.32	141.7	74.96
	-18.8	-19	149.5	61.50	149.5	63.82	148.5	65.83	148.5	68.93	148.5	71.85	148.5	76.50
	-16.7	-17	164.1	64.75	164.1	67.07	163.0	69.07	163.0	72.18	163.0	75.10	163.0	79.74
	-13.7	-15	184.8	69.39	184.8	71.71	183.7	73.71	183.7	76.80	183.7	79.74	183.7	78.85
	-11.8	-13	195.2	72.32	195.2	74.64	193.9	76.66	193.9	79.74	193.9	79.31	193.9	78.28
	-9.8	-11	206.1	75.42	206.1	77.72	204.7	79.74	204.7	79.47	204.7	78.85	204.7	77.68
	-9.5	-10	211.1	75.88	211.1	78.19	209.7	79.74	209.7	79.44	206.3	78.78	206.3	77.61
	-8.5	-9.1	227.4	77.42	227.4	79.74	226.0	79.74	226.0	79.31	211.8	78.55	211.8	77.31
	-7.0	-7.6	252.2	79.74	252.2	79.95	250.5	79.71	250.5	79.11	250.5	78.18	229.7	76.85
	-5.0	-5.6	285.1	80.44	285.1	80.24	283.1	79.68	283.1	78.85	283.1	77.72	243.5	76.26
	-3.0	-3.7	318.0	81.14	318.0	80.53	315.9	79.67	309.6	78.57	298.8	77.26	257.4	75.67
	0.0	-0.7	318.5	82.20	318.5	80.94	317.5	79.64	309.6	78.18	298.8	76.57	277.8	74.78
	3.0	2.2	318.5	83.26	318.5	81.37	317.5	79.61	309.6	77.78	298.8	75.86	278.2	73.90
	5.0	4.1	318.5	83.96	318.5	81.67	317.5	79.58	309.6	77.51	298.8	75.40	278.2	73.30
	7.0	6	318.5	84.68	318.5	81.94	317.5	79.57	309.6	77.25	298.8	74.94	278.2	72.71
	9.0	7.9	318.5	85.48	318.5	82.73	317.5	80.34	309.6	77.99	298.8	75.67	278.2	73.40
11.0	9.8	318.5	87.17	318.5	84.35	317.5	81.90	309.6	79.51	298.8	77.16	278.2	74.84	
13.0	11.8	318.5	88.83	318.5	85.98	317.5	83.46	309.6	81.04	298.8	78.62	278.2	76.27	
15.0	13.7	318.5	90.49	318.5	87.57	317.5	85.04	309.6	82.56	298.8	80.11	278.2	77.71	
120	-19.8	-20	141.7	62.26	141.7	64.28	140.7	67.37	140.7	70.32	140.7	74.96	140.7	78.19
	-18.8	-19	148.5	63.82	148.5	65.83	147.5	68.93	147.5	71.85	147.5	76.50	147.5	79.74
	-16.7	-17	162.8	67.07	162.8	69.07	161.8	72.18	161.8	75.10	161.8	79.74	161.8	79.17
	-13.7	-15	183.5	71.71	183.5	73.71	182.4	76.80	182.4	79.74	182.4	79.01	182.4	78.35
	-11.8	-13	193.8	74.64	193.8	76.66	192.6	79.74	192.6	79.28	192.6	78.55	192.6	77.82
	-9.8	-11	204.7	77.72	204.7	79.74	203.3	79.37	203.3	78.78	203.3	78.08	203.3	77.28
	-9.5	-10	209.4	78.19	209.4	79.70	208.3	79.31	208.3	78.71	208.3	77.99	208.3	77.19
	-8.5	-9.1	225.8	79.74	225.8	79.58	224.4	79.11	224.4	78.48	217.8	77.75	217.8	76.92
	-7.0	-7.6	250.4	79.75	250.4	79.40	248.7	78.82	248.7	78.11	228.2	77.38	228.2	76.52
	-5.0	-5.6	283.0	79.77	283.0	79.15	281.3	78.45	281.3	77.63	281.3	76.92	241.8	75.96
	-3.0	-3.7	312.6	79.77	312.6	78.91	300.2	78.06	290.4	77.13	281.3	76.43	255.5	75.42
	0.0	-0.7	315.9	79.81	312.6	78.55	300.2	77.49	290.4	76.39	281.3	75.70	261.2	74.60
	3.0	2.2	315.9	79.81	312.6	78.18	300.2	76.92	290.4	75.67	281.3	74.96	261.2	73.77
	5.0	4.1	315.9	79.84	312.6	77.93	300.2	76.53	290.4	75.19	281.3	74.48	261.2	73.22
	7.0	6	315.9	79.85	312.6	77.69	300.2	76.16	290.4	74.70	281.3	74.00	261.2	72.68
	9.0	7.9	315.9	80.24	312.6	78.08	300.2	76.53	290.4	75.07	281.3	74.36	261.2	73.04
11.0	9.8	315.9	81.43	312.6	79.21	300.2	77.65	290.4	76.16	281.3	75.46	261.2	74.11	
13.0	11.8	315.9	82.59	312.6	80.34	300.2	78.77	290.4	77.26	281.3	76.52	261.2	75.16	
15.0	13.7	315.9	83.73	312.6	81.46	300.2	79.87	290.4	78.32	281.3	77.58	261.2	76.20	
110	-19.8	-20	140.8	64.28	140.8	67.37	140.0	70.32	140.0	74.96	140.0	78.19	140.0	79.74
	-18.8	-19	147.5	65.83	147.5	68.93	146.8	71.85	146.8	76.50	146.8	79.74	146.8	79.31
	-16.7	-17	162.1	69.07	162.1	72.18	161.0	75.10	161.0	79.74	161.0	78.95	161.0	78.38
	-13.7	-15	182.5	73.71	182.5	76.80	181.4	79.74	181.4	78.64	181.4	77.84	181.4	77.06
	-11.8	-13	192.8	76.66	192.8	79.74	191.5	79.01	191.5	77.95	191.5	77.12	191.5	76.22
	-9.8	-11	203.6	79.74	203.6	78.99	202.3	78.25	202.3	77.19	202.3	76.39	202.3	75.33
	-9.5	-10	208.4	79.64	208.4	78.88	207.0	78.15	207.0	77.08	207.0	76.26	207.0	75.20
	-8.5	-9.1	224.6	79.28	224.6	78.51	223.2	77.75	223.2	76.72	217.4	75.89	217.4	74.76
	-7.0	-7.6	249.1	78.75	249.1	77.95	247.4	77.19	247.4	76.16	227.8	75.33	227.8	74.10
	-5.0	-5.6	271.1	78.05	271.1	77.19	269.4	76.43	260.6	75.43	238.6	74.57	235.2	73.21
	-3.0	-3.7	287.0	77.35	287.0	76.45	269.4	75.67	260.6	74.69	251.8	73.84	235.2	72.34
	0.0	-0.7	303.6	76.29	287.0	75.33	269.4	74.53	260.6	73.58	251.8	72.71	235.2	71.01
	3.0	2.2	303.6	75.22	287.0	74.20	269.4	73.40	260.6	72.48	251.8	71.58	235.2	69.70
	5.0	4.1	303.6	74.50	287.0	73.44	269.4	72.64	260.6	71.74	251.8	70.85	235.2	68.80
	7.0	6	303.6	73.81	287.0	72.69	269.4	71.88	260.6	71.01	251.8	70.09	235.2	67.93
	9.0	7.9	303.6	73.74	287.0	72.64	269.4	71.82	260.6	70.96	251.8	70.05	235.2	67.87
11.0	9.8	303.6	74.41	287.0	73.28	269.4	72.48	260.6	71.58	251.8	70.66	235.2	68.50	
13.0	11.8	303.6	75.03	287.0	73.90	269.4	73.08	260.6	72.18	251.8	71.26	235.2	69.06	
15.0	13.7	303.6	75.63	287.0	74.50	269.4	73.65	260.6	72.75	251.8	71.82	235.2	69.60	

Note

1. TC: Total Capacity(kW), PI : Power Input(kW, Comp. + Outdoor fan motor)
2. Capacity tables show the average value of conditions which may occur.
3. In the range beyond the operation limit of the outdoor unit, continuous operation and performance can not be guaranteed. When selecting the outdoor units, avoid the air temperature range that is not guaranteed continuous operation.

7. Capacity Tables

Combination (%)		Heating Capacity (88HP)												
		Outdoor air temp.		Indoor air temp. °C DB										
		°C DB	°C WB	16		18		20		21		22		24
		TC	PI	TC	PI	TC	PI	TC	PI	TC	PI	TC	PI	
100	-19.8	-20	140.3	66.93	140.3	69.49	139.4	71.65	139.4	75.77	139.4	78.64	139.4	79.74
	-18.8	-19	147.1	68.20	146.1	70.76	146.1	73.21	146.1	77.05	146.1	79.74	146.1	79.01
	-16.7	-17	160.4	70.89	160.4	73.47	160.4	76.46	159.4	79.74	159.4	78.32	159.4	77.45
	-13.7	-15	181.7	74.74	181.7	77.31	180.7	79.74	180.7	77.88	180.7	76.29	180.7	75.22
	-11.8	-13	191.8	77.19	190.8	79.74	190.8	78.67	190.8	76.69	190.8	74.99	190.8	73.81
	-9.8	-11	202.4	79.74	202.4	78.62	201.3	77.52	201.3	75.47	201.3	73.64	201.3	72.32
	-9.5	-10	207.3	79.61	207.3	78.45	206.3	77.36	206.3	75.27	206.3	73.44	206.3	72.11
	-8.5	-9.1	223.3	79.10	223.3	77.89	222.3	76.79	238.5	74.67	230.5	72.74	214.9	71.36
	-7.0	-7.6	251.8	78.35	250.8	77.06	246.4	75.93	238.5	73.74	230.5	71.75	214.9	70.25
	-5.0	-5.6	262.7	77.38	260.2	75.93	246.4	74.80	238.5	72.48	230.5	70.39	214.9	68.76
	-3.0	-3.7	270.4	76.39	262.3	74.80	246.4	73.67	238.5	71.25	230.5	69.03	214.9	67.27
	0.0	-0.7	277.9	74.90	262.3	73.14	246.4	71.98	238.5	69.40	230.5	67.00	214.9	65.06
	3.0	2.2	277.9	73.41	262.3	71.45	246.4	70.26	238.5	67.54	230.5	64.95	214.9	62.83
	5.0	4.1	277.9	72.44	262.3	70.32	246.4	69.13	238.5	66.30	230.5	63.59	214.9	61.34
	7.0	6	277.9	71.45	262.3	69.20	246.4	68.00	238.5	65.05	230.5	62.23	214.9	59.87
	9.0	7.9	277.9	70.46	262.3	68.23	246.4	67.06	238.5	64.16	230.5	61.39	214.9	59.04
	11.0	9.8	277.9	70.12	262.3	67.91	246.4	66.74	238.5	63.86	230.5	61.10	214.9	58.74
13.0	11.8	277.9	69.72	262.3	67.53	246.4	66.34	238.5	63.49	230.5	60.74	214.9	58.41	
15.0	13.7	277.9	69.23	262.3	67.07	246.4	65.91	238.5	63.05	230.5	60.31	214.9	58.02	
90	-19.8	-20	139.7	63.05	139.7	67.70	138.7	70.92	138.7	72.48	138.7	71.45	138.7	69.65
	-18.8	-19	147.1	64.59	146.1	69.23	145.5	72.48	145.5	71.98	145.5	70.95	145.5	69.06
	-16.7	-17	160.4	67.84	160.4	72.48	159.7	71.59	159.7	70.99	159.7	69.86	159.7	67.87
	-13.7	-15	181.7	72.48	181.7	71.31	179.8	70.32	179.8	69.52	179.8	68.33	179.8	66.18
	-11.8	-13	191.8	71.82	190.8	70.58	189.9	69.52	189.9	68.60	189.9	67.36	189.9	65.11
	-9.8	-11	202.4	71.12	202.4	69.80	200.6	68.67	200.6	67.63	200.6	66.34	184.1	63.96
	-9.5	-10	207.3	71.02	207.3	69.69	205.4	68.56	205.4	67.48	205.4	66.18	188.5	63.79
	-8.5	-9.1	223.3	70.69	221.9	69.29	221.4	68.14	218.4	67.01	211.5	65.68	196.4	63.22
	-7.0	-7.6	251.8	70.16	239.6	68.73	225.4	67.50	218.4	66.28	211.5	64.88	196.4	62.37
	-5.0	-5.6	254.5	69.46	239.6	67.94	225.4	66.65	218.4	65.31	211.5	63.86	196.4	61.23
	-3.0	-3.7	254.5	68.76	239.6	67.17	225.4	65.81	218.4	64.33	211.5	62.85	196.4	60.10
	0.0	-0.7	254.5	67.73	239.6	66.00	225.4	64.55	218.4	62.88	211.5	61.30	196.4	58.40
	3.0	2.2	254.5	66.67	239.6	64.85	225.4	63.27	218.4	61.43	211.5	59.77	196.4	56.69
	5.0	4.1	254.5	65.98	239.6	64.05	225.4	62.42	218.4	60.44	211.5	58.74	196.4	55.57
	7.0	6	254.5	65.29	239.6	63.29	225.4	61.59	218.4	59.48	211.5	57.71	196.4	54.43
	9.0	7.9	254.5	64.39	239.6	62.42	225.4	60.74	218.4	58.67	211.5	56.92	196.4	53.67
	11.0	9.8	254.5	63.50	239.6	61.54	225.4	59.91	218.4	57.85	211.5	56.13	196.4	52.93
13.0	11.8	254.5	62.60	239.6	60.67	225.4	59.04	218.4	57.02	211.5	55.34	196.4	52.18	
15.0	13.7	254.5	61.70	239.6	59.80	225.4	58.21	218.4	56.22	211.5	54.54	196.4	51.44	
80	-19.8	-20	138.3	54.83	138.3	59.47	138.3	64.28	138.3	63.29	138.3	61.80	138.3	60.21
	-18.8	-19	144.8	56.39	144.8	64.28	144.8	63.82	144.8	62.79	144.8	61.30	144.8	59.70
	-16.7	-17	159.7	64.28	159.7	63.43	159.7	62.90	159.7	61.79	159.7	60.28	159.7	58.61
	-13.7	-15	188.2	63.18	184.4	62.23	179.8	61.57	179.8	60.31	179.8	58.79	175.4	57.06
	-11.8	-13	203.4	62.49	197.6	61.50	189.9	60.74	189.9	59.41	188.5	57.85	175.4	56.08
	-9.8	-11	209.7	61.76	203.6	60.70	200.6	59.84	195.7	58.42	188.5	56.86	175.4	55.06
	-9.5	-10	211.2	61.64	205.1	60.56	201.7	59.71	195.7	58.28	188.5	56.72	175.4	54.90
	-8.5	-9.1	219.1	61.27	214.9	60.17	201.7	59.27	195.7	57.78	188.5	56.22	175.4	54.37
	-7.0	-7.6	227.9	60.74	214.9	59.57	201.7	58.61	195.7	57.05	188.5	55.49	175.4	53.60
	-5.0	-5.6	227.9	60.00	214.9	58.78	201.7	57.71	195.7	56.08	188.5	54.50	175.4	52.57
	-3.0	-3.7	227.9	59.27	214.9	57.98	201.7	56.82	195.7	55.09	188.5	53.51	175.4	51.55
	0.0	-0.7	227.9	58.17	214.9	56.79	201.7	55.50	195.7	53.64	188.5	52.02	175.4	49.99
	3.0	2.2	227.9	57.08	214.9	55.59	201.7	54.17	195.7	52.17	188.5	50.55	175.4	48.43
	5.0	4.1	227.9	56.35	214.9	54.79	201.7	53.30	195.7	51.19	188.5	49.56	175.4	47.40
	7.0	6	227.9	55.62	214.9	54.00	201.7	52.40	195.7	50.22	188.5	48.57	175.4	46.38
	9.0	7.9	227.9	52.22	214.9	50.69	201.7	49.19	195.7	47.16	188.5	45.61	175.4	43.55
	11.0	9.8	227.9	48.47	214.9	47.07	201.7	45.67	195.7	43.76	188.5	42.32	175.4	40.41
13.0	11.8	227.9	45.24	214.9	43.92	201.7	42.62	195.7	40.86	188.5	39.51	175.4	37.72	
15.0	13.7	227.9	42.59	214.9	41.35	201.7	40.13	195.7	38.45	188.5	37.19	175.4	35.52	

Note
 1. TC: Total Capacity(kW), PI: Power Input(kW, Comp. + Outdoor fan motor)
 2. Capacity tables show the average value of conditions which may occur.
 3. In the range beyond the operation limit of the outdoor unit, continuous operation and performance can not be guaranteed. When selecting the outdoor units, avoid the air temperature range that is not guaranteed continuous operation.

7. Capacity Tables

Combination (%)		Heating Capacity (88HP)												
		Outdoor air temp.		Indoor air temp. °C DB										
		°C DB	°C WB	16		18		20		21		22		24
		TC	PI	TC	PI	TC	PI	TC	PI	TC	PI	TC	PI	
70	-19.8	-20	138.3	58.09	138.3	59.64	138.3	58.62	138.3	56.99	138.3	55.46	138.3	53.77
	-18.8	-19	144.8	59.64	144.8	59.15	144.8	58.11	144.8	56.48	144.8	54.95	144.8	53.21
	-16.7	-17	159.7	58.72	159.7	58.12	159.7	57.02	159.7	55.36	159.7	53.87	150.0	52.08
	-13.7	-15	193.3	57.42	182.5	56.65	171.6	55.50	165.8	53.80	160.8	52.31	150.0	50.42
	-11.8	-13	193.3	56.59	182.5	55.70	171.6	54.53	165.8	52.78	160.8	51.32	150.0	49.39
	-9.8	-11	193.3	55.73	182.5	54.72	171.6	53.50	165.8	51.74	160.8	50.29	150.0	48.29
	-9.5	-10	193.3	55.59	182.5	54.57	171.6	53.34	165.8	51.58	160.8	50.13	150.0	48.13
	-8.5	-9.1	193.3	55.16	182.5	54.10	171.6	52.84	165.8	51.05	160.8	49.62	150.0	47.60
	-7.0	-7.6	193.3	54.51	182.5	53.34	171.6	52.08	165.8	50.26	160.8	48.84	150.0	46.77
	-5.0	-5.6	193.3	53.64	182.5	52.37	171.6	51.05	165.8	49.20	160.8	47.80	150.0	45.67
	-3.0	-3.7	193.3	52.77	182.5	51.39	171.6	50.03	165.8	48.16	160.8	46.77	150.0	44.58
	0.0	-0.7	193.3	51.48	182.5	49.92	171.6	48.50	165.8	46.57	160.8	45.21	150.0	42.93
	3.0	2.2	193.3	50.15	182.5	48.43	171.6	46.97	165.8	45.00	160.8	43.65	150.0	41.30
	5.0	4.1	193.3	49.30	182.5	47.46	171.6	45.94	165.8	43.95	160.8	42.63	150.0	40.20
	7.0	6	193.3	48.43	182.5	46.48	171.6	44.92	165.8	42.89	160.8	41.60	150.0	39.10
	9.0	7.9	193.3	43.72	182.5	41.97	171.6	40.57	165.8	38.74	160.8	37.56	150.0	35.33
	11.0	9.8	193.3	40.71	182.5	39.08	171.6	37.77	165.8	36.06	160.8	34.97	150.0	32.88
	13.0	11.8	193.3	38.09	182.5	36.55	171.6	35.33	165.8	33.74	160.8	32.71	150.0	30.76
15.0	13.7	193.3	35.92	182.5	34.46	171.6	33.31	165.8	31.81	160.8	30.85	150.0	28.99	
60	-19.8	-20	165.8	54.99	157.0	53.97	138.3	52.37	138.3	50.81	137.4	49.27	128.5	47.57
	-18.8	-19	165.8	54.53	157.0	53.47	144.8	51.85	142.2	50.29	137.4	48.76	128.5	47.03
	-16.7	-17	165.8	53.61	157.0	52.37	147.2	50.76	142.2	49.20	137.4	47.66	128.5	45.87
	-13.7	-15	165.8	52.25	157.0	50.85	147.2	49.20	142.2	47.64	137.4	46.10	128.5	44.22
	-11.8	-13	165.8	51.41	157.0	49.86	147.2	48.19	142.2	46.67	137.4	45.11	128.5	43.19
	-9.8	-11	165.8	50.51	157.0	48.86	147.2	47.14	142.2	45.62	137.4	44.08	128.5	42.09
	-9.5	-10	165.8	50.36	157.0	48.69	147.2	47.00	142.2	45.45	137.4	43.92	128.5	41.92
	-8.5	-9.1	165.8	49.92	157.0	48.17	147.2	46.47	142.2	44.95	137.4	43.41	128.5	41.37
	-7.0	-7.6	165.8	49.25	157.0	47.41	147.2	45.68	142.2	44.15	137.4	42.63	128.5	40.56
	-5.0	-5.6	165.8	48.35	157.0	46.38	147.2	44.65	142.2	43.12	137.4	41.60	128.5	39.47
	-3.0	-3.7	165.8	47.44	157.0	45.37	147.2	43.58	142.2	42.06	137.4	40.56	128.5	38.38
	0.0	-0.7	165.8	46.10	157.0	43.82	147.2	42.02	142.2	40.50	137.4	39.00	128.5	36.72
	3.0	2.2	165.8	44.75	157.0	42.29	147.2	40.46	142.2	38.94	137.4	37.45	128.5	35.06
	5.0	4.1	165.8	43.85	157.0	41.26	147.2	39.40	142.2	37.91	137.4	36.39	128.5	33.97
	7.0	6	165.8	42.96	157.0	40.23	147.2	38.35	142.2	36.85	137.4	35.36	128.5	32.88
	9.0	7.9	165.8	38.34	157.0	35.89	147.2	34.23	142.2	32.90	137.4	31.55	128.5	29.35
	11.0	9.8	165.8	35.79	157.0	33.53	147.2	31.95	142.2	30.72	137.4	29.46	128.5	27.40
	13.0	11.8	165.8	33.54	157.0	31.41	147.2	29.95	142.2	28.76	137.4	27.60	128.5	25.67
15.0	13.7	165.8	31.68	157.0	29.68	147.2	28.30	142.2	27.20	137.4	26.08	128.5	24.26	
50	-19.8	-20	138.4	49.26	130.6	47.54	122.5	45.93	118.8	44.29	114.8	42.78	107.0	41.16
	-18.8	-19	138.4	48.73	130.6	46.97	122.5	45.38	118.8	43.75	114.8	42.26	107.0	40.61
	-16.7	-17	138.4	47.57	130.6	45.80	122.5	44.22	118.8	42.62	114.8	41.16	107.0	39.50
	-13.7	-15	138.4	45.94	130.6	44.11	122.5	42.59	118.8	40.97	114.8	39.58	107.0	37.88
	-11.8	-13	138.4	44.90	130.6	43.02	122.5	41.55	118.8	39.94	114.8	38.61	107.0	36.88
	-9.8	-11	138.4	43.82	130.6	41.90	122.5	40.46	118.8	38.84	114.8	37.55	107.0	35.81
	-9.5	-10	138.4	43.66	130.6	41.73	122.5	40.29	118.8	38.68	114.8	37.39	107.0	35.65
	-8.5	-9.1	138.4	43.09	130.6	41.17	122.5	39.74	118.8	38.15	114.8	36.88	107.0	35.12
	-7.0	-7.6	138.4	42.29	130.6	40.33	122.5	38.91	118.8	37.32	114.8	36.09	107.0	34.32
	-5.0	-5.6	138.4	41.20	130.6	39.21	122.5	37.81	118.8	36.22	114.8	35.03	107.0	33.24
	-3.0	-3.7	138.4	40.10	130.6	38.08	122.5	36.73	118.8	35.13	114.8	34.00	107.0	32.18
	0.0	-0.7	138.4	38.47	130.6	36.39	122.5	35.09	118.8	33.50	114.8	32.43	107.0	30.58
	3.0	2.2	138.4	36.82	130.6	34.69	122.5	33.44	118.8	31.88	114.8	30.85	107.0	28.99
	5.0	4.1	138.4	35.75	130.6	33.57	122.5	32.34	118.8	30.78	114.8	29.82	107.0	27.90
	7.0	6	138.4	34.66	130.6	32.44	122.5	31.25	118.8	29.68	114.8	28.76	107.0	26.83
	9.0	7.9	138.4	31.29	130.6	29.29	122.5	28.23	118.8	26.81	114.8	25.98	107.0	24.24
	11.0	9.8	138.4	29.29	130.6	27.41	122.5	26.40	118.8	25.08	114.8	24.31	107.0	22.68
	13.0	11.8	138.4	27.50	130.6	25.74	122.5	24.79	118.8	23.55	114.8	22.82	107.0	21.30
15.0	13.7	138.4	26.01	130.6	24.35	122.5	23.46	118.8	22.29	114.8	21.59	107.0	20.14	

Note

1. TC: Total Capacity(kW), PI: Power Input(kW, Comp. + Outdoor fan motor)
2. Capacity tables show the average value of conditions which may occur.
3. In the range beyond the operation limit of the outdoor unit, continuous operation and performance can not be guaranteed. When selecting the outdoor units, avoid the air temperature range that is not guaranteed continuous operation.

7. Capacity Tables

◆ A(C)RUN900LLS5

Combination (%)	Outdoor air temp.		Heating Capacity (90HP)											
			Indoor air temp. °C DB											
	°C DB	°C WB	16		18		20		21		22		24	
		TC	PI	TC	PI	TC	PI	TC	PI	TC	PI	TC	PI	
130	-19.8	-20	146.0	62.27	146.0	64.65	145.0	66.75	145.0	69.95	145.0	73.01	145.0	77.83
	-18.8	-19	153.0	63.86	153.0	66.27	151.9	68.36	151.9	71.57	151.9	74.60	151.9	79.42
	-16.7	-17	167.9	67.23	167.9	69.64	166.8	71.71	166.8	74.94	166.8	77.97	166.8	82.79
	-13.7	-15	189.0	72.05	189.0	74.46	187.9	76.53	187.9	79.73	187.9	82.79	187.9	81.86
	-11.8	-13	199.7	75.08	199.7	77.49	198.3	79.59	198.3	82.79	198.3	82.34	198.3	81.27
	-9.8	-11	210.8	78.31	210.8	80.69	209.4	82.79	209.4	82.51	209.4	81.86	209.4	80.65
	-9.5	-10	216.0	78.79	216.0	81.17	214.6	82.79	214.6	82.48	211.1	81.79	211.1	80.58
	-8.5	-9.1	232.6	80.38	232.6	82.79	231.2	82.79	231.2	82.34	216.7	81.55	216.7	80.27
	-7.0	-7.6	257.9	82.79	257.9	83.00	256.2	82.75	256.2	82.13	256.2	81.17	234.8	79.79
	-5.0	-5.6	291.5	83.51	291.5	83.31	289.4	82.72	289.4	81.86	289.4	80.69	248.9	79.17
	-3.0	-3.7	325.1	84.24	325.1	83.61	323.0	82.72	316.7	81.58	305.6	80.21	263.1	78.56
	0.0	-0.7	325.7	85.34	325.7	84.03	324.7	82.69	316.7	81.17	305.6	79.49	283.9	77.63
	3.0	2.2	325.7	86.44	325.7	84.48	324.7	82.65	316.7	80.76	305.6	78.76	284.5	76.73
	5.0	4.1	325.7	87.17	325.7	84.79	324.7	82.62	316.7	80.48	305.6	78.28	284.5	76.11
	7.0	6	325.7	87.92	325.7	85.07	324.7	82.62	316.7	80.21	305.6	77.80	284.5	75.49
	9.0	7.9	325.7	88.75	325.7	85.89	324.7	83.41	316.7	80.97	305.6	78.56	284.5	76.21
11.0	9.8	325.7	90.51	325.7	87.58	324.7	85.03	316.7	82.55	305.6	80.11	284.5	77.70	
13.0	11.8	325.7	92.23	325.7	89.27	324.7	86.65	316.7	84.14	305.6	81.62	284.5	79.18	
15.0	13.7	325.7	93.95	325.7	90.92	324.7	88.30	316.7	85.72	305.6	83.17	284.5	80.69	
120	-19.8	-20	145.0	64.65	145.0	66.75	144.0	69.95	144.0	73.01	144.0	77.83	144.0	81.17
	-18.8	-19	151.9	66.27	151.9	68.36	150.9	71.57	150.9	74.60	150.9	79.42	150.9	82.79
	-16.7	-17	166.5	69.64	166.5	71.71	165.5	74.94	165.5	77.97	165.5	82.79	165.5	82.20
	-13.7	-15	187.6	74.46	187.6	76.53	186.6	79.73	186.6	82.79	186.6	82.03	186.6	81.34
	-11.8	-13	198.3	77.49	198.3	79.59	197.0	82.79	197.0	82.31	197.0	81.55	197.0	80.79
	-9.8	-11	209.4	80.69	209.4	82.79	208.0	82.41	208.0	81.79	208.0	81.07	208.0	80.24
	-9.5	-10	214.2	81.17	214.2	82.75	213.2	82.34	213.2	81.72	213.2	80.97	213.2	80.14
	-8.5	-9.1	230.9	82.79	230.9	82.62	229.5	82.13	229.5	81.48	222.6	80.72	222.6	79.86
	-7.0	-7.6	256.1	82.79	256.1	82.44	254.4	81.83	254.4	81.10	233.3	80.34	233.3	79.45
	-5.0	-5.6	289.4	82.82	289.4	82.17	287.7	81.45	287.7	80.59	287.7	79.86	247.2	78.86
	-3.0	-3.7	319.8	82.82	319.8	81.93	307.0	81.04	297.0	80.07	287.7	79.35	261.1	78.31
	0.0	-0.7	323.0	82.86	319.8	81.55	307.0	80.45	297.0	79.31	287.7	78.59	267.2	77.45
	3.0	2.2	323.0	82.86	319.8	81.17	307.0	79.86	297.0	78.56	287.7	77.83	267.2	76.59
	5.0	4.1	323.0	82.89	319.8	80.90	307.0	79.45	297.0	78.07	287.7	77.32	267.2	76.01
	7.0	6	323.0	82.90	319.8	80.66	307.0	79.07	297.0	77.56	287.7	76.83	267.2	75.46
	9.0	7.9	323.0	83.31	319.8	81.07	307.0	79.45	297.0	77.94	287.7	77.21	267.2	75.83
11.0	9.8	323.0	84.55	319.8	82.24	307.0	80.62	297.0	79.07	287.7	78.35	267.2	76.94	
13.0	11.8	323.0	85.75	319.8	83.41	307.0	81.79	297.0	80.21	287.7	79.45	267.2	78.04	
15.0	13.7	323.0	86.93	319.8	84.58	307.0	82.93	297.0	81.31	287.7	80.55	267.2	79.11	
110	-19.8	-20	144.0	66.75	144.0	69.95	143.3	73.01	143.3	77.83	143.3	81.17	143.3	82.79
	-18.8	-19	150.9	68.36	150.9	71.57	150.2	74.60	150.2	79.42	150.2	82.79	150.2	82.34
	-16.7	-17	165.8	71.71	165.8	74.94	164.7	77.97	164.7	82.79	164.7	81.96	164.7	81.38
	-13.7	-15	186.6	76.53	186.6	79.73	185.5	82.79	185.5	81.65	185.5	80.82	185.5	80.00
	-11.8	-13	197.3	79.59	197.3	82.79	195.9	82.03	195.9	80.93	195.9	80.07	195.9	79.14
	-9.8	-11	208.3	82.79	208.3	82.00	207.0	81.24	207.0	80.14	207.0	80.31	207.0	78.21
	-9.5	-10	213.2	82.68	213.2	81.89	211.8	81.14	211.8	80.03	211.8	79.17	211.8	78.07
	-8.5	-9.1	229.8	82.31	229.8	81.51	228.4	80.72	228.4	79.65	222.5	78.79	222.5	77.62
	-7.0	-7.6	254.8	81.76	254.8	80.93	253.0	80.14	253.0	79.07	233.2	78.21	233.2	76.93
	-5.0	-5.6	277.3	81.03	277.3	80.14	275.5	79.35	266.5	78.31	244.3	77.42	240.6	76.01
	-3.0	-3.7	293.5	80.31	293.5	79.38	275.5	78.56	266.5	77.55	257.5	76.66	240.6	75.11
	0.0	-0.7	310.5	79.21	293.5	78.21	275.5	77.38	266.5	76.39	257.5	75.49	240.6	73.73
	3.0	2.2	310.5	78.10	293.5	77.04	275.5	76.21	266.5	75.25	257.5	74.32	240.6	72.36
	5.0	4.1	310.5	77.35	293.5	76.25	275.5	75.42	266.5	74.49	257.5	73.56	240.6	71.43
	7.0	6	310.5	76.63	293.5	75.46	275.5	74.63	266.5	73.73	257.5	72.77	240.6	70.53
	9.0	7.9	310.5	76.56	293.5	75.42	275.5	74.56	266.5	73.67	257.5	72.73	240.6	70.46
11.0	9.8	310.5	77.25	293.5	76.08	275.5	75.25	266.5	74.32	257.5	73.36	240.6	71.12	
13.0	11.8	310.5	77.90	293.5	76.73	275.5	75.87	266.5	74.94	257.5	73.98	240.6	71.70	
15.0	13.7	310.5	78.52	293.5	77.35	275.5	76.46	266.5	75.53	257.5	74.56	240.6	72.26	

Note

1. TC: Total Capacity(kW), PI : Power Input(kW, Comp. + Outdoor fan motor)
2. Capacity tables show the average value of conditions which may occur.
3. In the range beyond the operation limit of the outdoor unit, continuous operation and performance can not be guaranteed. When selecting the outdoor units, avoid the air temperature range that is not guaranteed continuous operation.

7. Capacity Tables

Combination (%)		Heating Capacity (90HP)												
		Outdoor air temp.		Indoor air temp. °C DB										
		°C DB	°C WB	16		18		20		21		22		24
		TC	PI	TC	PI	TC	PI	TC	PI	TC	PI	TC	PI	
100	-19.8	-20	143.6	69.50	143.6	72.15	142.6	74.39	142.6	78.66	142.6	81.65	142.6	82.79
	-18.8	-19	150.5	70.81	149.5	73.46	149.5	76.01	149.5	80.00	149.5	82.79	149.5	82.03
	-16.7	-17	164.1	73.60	164.1	76.28	164.1	79.38	163.0	82.79	163.0	81.31	163.0	80.41
	-13.7	-15	185.9	77.59	185.9	80.27	184.8	82.79	184.8	80.86	184.8	79.21	184.8	78.10
	-11.8	-13	196.2	80.14	195.2	82.79	195.2	81.68	195.2	79.62	195.2	77.86	195.2	76.63
	-9.8	-11	207.0	82.79	207.0	81.62	205.9	80.48	205.9	78.35	205.9	76.45	205.9	75.08
	-9.5	-10	212.1	82.65	212.1	81.45	211.1	80.31	211.1	78.14	211.1	76.25	211.1	74.87
	-8.5	-9.1	228.4	82.13	228.4	80.86	227.4	79.72	244.0	77.52	235.7	75.52	219.8	74.08
	-7.0	-7.6	257.5	81.34	256.5	80.00	252.0	78.83	244.0	76.56	235.7	74.49	219.8	72.94
	-5.0	-5.6	268.6	80.34	266.2	78.83	252.0	77.66	244.0	75.25	235.7	73.08	219.8	71.39
	-3.0	-3.7	276.6	79.31	268.3	77.66	252.0	76.49	244.0	73.97	235.7	71.67	219.8	69.84
	0.0	-0.7	284.2	77.76	268.3	75.94	252.0	74.73	244.0	72.05	235.7	69.56	219.8	67.54
	3.0	2.2	284.2	76.21	268.3	74.18	252.0	72.94	244.0	70.12	235.7	67.43	219.8	65.23
	5.0	4.1	284.2	75.21	268.3	73.01	252.0	71.77	244.0	68.84	235.7	66.02	219.8	63.68
	7.0	6	284.2	74.18	268.3	71.84	252.0	70.60	244.0	67.54	235.7	64.61	219.8	62.16
	9.0	7.9	284.2	73.15	268.3	70.84	252.0	69.63	244.0	66.61	235.7	63.74	219.8	61.30
	11.0	9.8	284.2	72.80	268.3	70.50	252.0	69.29	244.0	66.30	235.7	63.44	219.8	60.99
	13.0	11.8	284.2	72.39	268.3	70.12	252.0	68.88	244.0	65.92	235.7	63.06	219.8	60.65
15.0	13.7	284.2	71.88	268.3	69.64	252.0	68.43	244.0	65.47	235.7	62.61	219.8	60.24	
90	-19.8	-20	142.9	65.47	142.9	70.29	141.9	73.63	141.9	75.25	141.9	74.18	141.9	72.32
	-18.8	-19	150.5	67.06	149.5	71.88	148.8	75.25	148.8	74.73	148.8	73.66	148.8	71.70
	-16.7	-17	164.1	70.43	164.1	75.25	163.4	74.32	163.4	73.70	163.4	72.53	163.4	70.46
	-13.7	-15	185.9	75.25	185.9	74.04	183.8	73.01	183.8	72.18	183.8	70.94	183.8	68.71
	-11.8	-13	196.2	74.56	195.2	73.28	194.2	72.18	194.2	71.22	194.2	69.94	194.2	67.60
	-9.8	-11	207.0	73.84	207.0	72.46	205.2	71.29	205.2	70.22	205.2	68.88	188.3	66.40
	-9.5	-10	212.1	73.73	212.1	72.35	210.1	71.18	210.1	70.05	210.1	68.71	192.8	66.23
	-8.5	-9.1	228.4	73.39	227.0	71.94	226.4	70.74	223.3	69.57	216.3	68.19	200.8	65.64
	-7.0	-7.6	257.5	72.84	245.1	71.36	230.5	70.08	223.3	68.81	216.3	67.36	200.8	64.75
	-5.0	-5.6	260.3	72.11	245.1	70.53	230.5	69.19	223.3	67.81	216.3	66.30	200.8	63.57
	-3.0	-3.7	260.3	71.39	245.1	69.74	230.5	68.33	223.3	66.78	216.3	65.26	200.8	62.40
	0.0	-0.7	260.3	70.32	245.1	68.53	230.5	67.02	223.3	65.29	216.3	63.64	200.8	60.64
	3.0	2.2	260.3	69.22	245.1	67.33	230.5	65.68	223.3	63.78	216.3	62.06	200.8	58.86
	5.0	4.1	260.3	68.50	245.1	66.50	230.5	64.81	223.3	62.75	216.3	60.99	200.8	57.69
	7.0	6	260.3	67.78	245.1	65.71	230.5	63.95	223.3	61.75	216.3	59.92	200.8	56.51
	9.0	7.9	260.3	66.85	245.1	64.81	230.5	63.06	223.3	60.92	216.3	59.10	200.8	55.72
	11.0	9.8	260.3	65.92	245.1	63.89	230.5	62.20	223.3	60.06	216.3	58.27	200.8	54.96
	13.0	11.8	260.3	64.99	245.1	62.99	230.5	61.30	223.3	59.20	216.3	57.45	200.8	54.17
15.0	13.7	260.3	64.06	245.1	62.09	230.5	60.44	223.3	58.37	216.3	56.62	200.8	53.41	
80	-19.8	-20	141.5	56.93	141.5	61.75	141.5	66.74	141.5	65.71	141.5	64.16	141.5	62.51
	-18.8	-19	148.1	58.55	148.1	66.74	148.1	66.26	148.1	65.19	148.1	63.64	148.1	61.99
	-16.7	-17	163.4	66.74	163.4	65.85	163.4	65.30	163.4	64.16	163.4	62.58	163.4	60.85
	-13.7	-15	192.5	65.60	188.6	64.61	183.8	63.92	183.8	62.61	183.8	61.03	179.3	59.24
	-11.8	-13	208.0	64.88	202.1	63.85	194.2	63.06	194.2	61.68	192.8	60.06	179.3	58.23
	-9.8	-11	214.6	64.12	208.3	63.02	205.2	62.13	200.1	60.65	192.8	59.03	179.3	57.17
	-9.5	-10	216.0	63.99	209.8	62.88	206.3	61.99	200.1	60.51	192.8	58.89	179.3	57.00
	-8.5	-9.1	224.0	63.61	219.8	62.47	206.3	61.54	200.1	59.99	192.8	58.37	179.3	56.45
	-7.0	-7.6	233.0	63.06	219.8	61.85	206.3	60.85	200.1	59.23	192.8	57.61	179.3	55.65
	-5.0	-5.6	233.0	62.30	219.8	61.03	206.3	59.92	200.1	58.23	192.8	56.58	179.3	54.58
	-3.0	-3.7	233.0	61.54	219.8	60.20	206.3	58.99	200.1	57.20	192.8	55.55	179.3	53.52
	0.0	-0.7	233.0	60.40	219.8	58.96	206.3	57.62	200.1	55.69	192.8	54.00	179.3	51.90
	3.0	2.2	233.0	59.27	219.8	57.72	206.3	56.24	200.1	54.17	192.8	52.48	179.3	50.28
	5.0	4.1	233.0	58.51	219.8	56.89	206.3	55.34	200.1	53.14	192.8	51.45	179.3	49.21
	7.0	6	233.0	57.75	219.8	56.07	206.3	54.41	200.1	52.14	192.8	50.42	179.3	48.15
	9.0	7.9	233.0	54.21	219.8	52.62	206.3	51.07	200.1	48.97	192.8	47.35	179.3	45.22
	11.0	9.8	233.0	50.32	219.8	48.87	206.3	47.42	200.1	45.43	192.8	43.94	179.3	41.95
	13.0	11.8	233.0	46.97	219.8	45.60	206.3	44.25	200.1	42.43	192.8	41.02	179.3	39.16
15.0	13.7	233.0	44.22	219.8	42.94	206.3	41.67	200.1	39.92	192.8	38.61	179.3	36.88	

Note

1. TC: Total Capacity(kW), PI: Power Input(kW, Comp. + Outdoor fan motor)
2. Capacity tables show the average value of conditions which may occur.
3. In the range beyond the operation limit of the outdoor unit, continuous operation and performance can not be guaranteed. When selecting the outdoor units, avoid the air temperature range that is not guaranteed continuous operation.

7. Capacity Tables

Combination (%)		Heating Capacity (90HP)												
		Outdoor air temp.		Indoor air temp. °C DB										
		°C DB	°C WB	16		18		20		21		22		24
		TC	PI	TC	PI	TC	PI	TC	PI	TC	PI	TC	PI	
70	-19.8	-20	141.5	60.31	141.5	61.92	141.5	60.86	141.5	59.17	141.5	57.58	141.5	55.83
	-18.8	-19	148.1	61.92	148.1	61.41	148.1	60.34	148.1	58.65	148.1	57.06	148.1	55.24
	-16.7	-17	163.4	60.96	163.4	60.34	163.4	59.20	163.4	57.48	163.4	55.93	153.4	54.07
	-13.7	-15	197.7	59.62	186.6	58.82	175.5	57.62	169.6	55.86	164.4	54.31	153.4	52.35
	-11.8	-13	197.7	58.75	186.6	57.83	175.5	56.62	169.6	54.80	164.4	53.28	153.4	51.28
	-9.8	-11	197.7	57.86	186.6	56.82	175.5	55.55	169.6	53.72	164.4	52.21	153.4	50.14
	-9.5	-10	197.7	57.72	186.6	56.65	175.5	55.38	169.6	53.55	164.4	52.04	153.4	49.97
	-8.5	-9.1	197.7	57.27	186.6	56.17	175.5	54.86	169.6	53.00	164.4	51.52	153.4	49.42
	-7.0	-7.6	197.7	56.59	186.6	55.38	175.5	54.07	169.6	52.18	164.4	50.70	153.4	48.56
	-5.0	-5.6	197.7	55.69	186.6	54.38	175.5	53.00	169.6	51.08	164.4	49.63	153.4	47.42
	-3.0	-3.7	197.7	54.79	186.6	53.35	175.5	51.94	169.6	50.00	164.4	48.56	153.4	46.29
	0.0	-0.7	197.7	53.45	186.6	51.83	175.5	50.35	169.6	48.35	164.4	46.94	153.4	44.57
	3.0	2.2	197.7	52.07	186.6	50.28	175.5	48.77	169.6	46.73	164.4	45.32	153.4	42.88
	5.0	4.1	197.7	51.18	186.6	49.28	175.5	47.70	169.6	45.63	164.4	44.26	153.4	41.74
	7.0	6	197.7	50.28	186.6	48.25	175.5	46.63	169.6	44.53	164.4	43.19	153.4	40.60
	9.0	7.9	197.7	45.39	186.6	43.57	175.5	42.12	169.6	40.22	164.4	38.99	153.4	36.68
11.0	9.8	197.7	42.26	186.6	40.57	175.5	39.22	169.6	37.44	164.4	36.30	153.4	34.13	
13.0	11.8	197.7	39.54	186.6	37.95	175.5	36.68	169.6	35.03	164.4	33.96	153.4	31.93	
15.0	13.7	197.7	37.30	186.6	35.78	175.5	34.58	169.6	33.03	164.4	32.03	153.4	30.10	
60	-19.8	-20	169.6	57.10	160.6	56.04	141.5	54.38	141.5	52.76	140.5	51.15	131.5	49.39
	-18.8	-19	169.6	56.62	160.6	55.52	148.1	53.83	145.4	52.21	140.5	50.63	131.5	48.84
	-16.7	-17	169.6	55.66	160.6	54.38	150.6	52.70	145.4	51.08	140.5	49.49	131.5	47.63
	-13.7	-15	169.6	54.25	160.6	52.80	150.6	51.08	145.4	49.46	140.5	47.87	131.5	45.91
	-11.8	-13	169.6	53.38	160.6	51.77	150.6	50.04	145.4	48.46	140.5	46.84	131.5	44.84
	-9.8	-11	169.6	52.45	160.6	50.73	150.6	48.94	145.4	47.36	140.5	45.77	131.5	43.70
	-9.5	-10	169.6	52.28	160.6	50.56	150.6	48.80	145.4	47.19	140.5	45.60	131.5	43.53
	-8.5	-9.1	169.6	51.83	160.6	50.01	150.6	48.25	145.4	46.67	140.5	45.08	131.5	42.95
	-7.0	-7.6	169.6	51.14	160.6	49.22	150.6	47.43	145.4	45.84	140.5	44.26	131.5	42.12
	-5.0	-5.6	169.6	50.21	160.6	48.15	150.6	46.36	145.4	44.77	140.5	43.19	131.5	40.98
	-3.0	-3.7	169.6	49.25	160.6	47.11	150.6	45.25	145.4	43.67	140.5	42.12	131.5	39.85
	0.0	-0.7	169.6	47.87	160.6	45.50	150.6	43.63	145.4	42.05	140.5	40.50	131.5	38.12
	3.0	2.2	169.6	46.46	160.6	43.91	150.6	42.01	145.4	40.43	140.5	38.88	131.5	36.40
	5.0	4.1	169.6	45.53	160.6	42.84	150.6	40.91	145.4	39.36	140.5	37.78	131.5	35.27
	7.0	6	169.6	44.60	160.6	41.77	150.6	39.81	145.4	38.26	140.5	36.71	131.5	34.13
	9.0	7.9	169.6	39.81	160.6	37.26	150.6	35.54	145.4	34.16	140.5	32.75	131.5	30.48
11.0	9.8	169.6	37.16	160.6	34.82	150.6	33.17	145.4	31.89	140.5	30.58	131.5	28.45	
13.0	11.8	169.6	34.82	160.6	32.61	150.6	31.10	145.4	29.86	140.5	28.65	131.5	26.65	
15.0	13.7	169.6	32.89	160.6	30.82	150.6	29.38	145.4	28.24	140.5	27.07	131.5	25.18	
50	-19.8	-20	141.6	51.15	133.6	49.36	125.3	47.70	121.5	45.98	117.4	44.43	109.4	42.74
	-18.8	-19	141.6	50.60	133.6	48.77	125.3	47.12	121.5	45.43	117.4	43.88	109.4	42.16
	-16.7	-17	141.6	49.39	133.6	47.56	125.3	45.91	121.5	44.26	117.4	42.74	109.4	41.02
	-13.7	-15	141.6	47.70	133.6	45.81	125.3	44.22	121.5	42.54	117.4	41.09	109.4	39.33
	-11.8	-13	141.6	46.63	133.6	44.67	125.3	43.15	121.5	41.47	117.4	40.09	109.4	38.30
	-9.8	-11	141.6	45.50	133.6	43.50	125.3	42.02	121.5	40.33	117.4	38.99	109.4	37.19
	-9.5	-10	141.6	45.33	133.6	43.33	125.3	41.84	121.5	40.16	117.4	38.82	109.4	37.02
	-8.5	-9.1	141.6	44.74	133.6	42.74	125.3	41.26	121.5	39.61	117.4	38.30	109.4	36.47
	-7.0	-7.6	141.6	43.91	133.6	41.88	125.3	40.40	121.5	38.75	117.4	37.47	109.4	35.64
	-5.0	-5.6	141.6	42.78	133.6	40.71	125.3	39.26	121.5	37.61	117.4	36.37	109.4	34.51
	-3.0	-3.7	141.6	41.64	133.6	39.54	125.3	38.13	121.5	36.47	117.4	35.30	109.4	33.41
	0.0	-0.7	141.6	39.95	133.6	37.78	125.3	36.44	121.5	34.78	117.4	33.68	109.4	31.75
	3.0	2.2	141.6	38.23	133.6	36.02	125.3	34.72	121.5	33.10	117.4	32.03	109.4	30.10
	5.0	4.1	141.6	37.12	133.6	34.85	125.3	33.58	121.5	31.96	117.4	30.96	109.4	28.96
	7.0	6	141.6	35.99	133.6	33.68	125.3	32.44	121.5	30.82	117.4	29.86	109.4	27.86
	9.0	7.9	141.6	32.48	133.6	30.41	125.3	29.31	121.5	27.83	117.4	26.97	109.4	25.17
11.0	9.8	141.6	30.41	133.6	28.45	125.3	27.41	121.5	26.04	117.4	25.24	109.4	23.55	
13.0	11.8	141.6	28.55	133.6	26.72	125.3	25.73	121.5	24.45	117.4	23.69	109.4	22.11	
15.0	13.7	141.6	27.00	133.6	25.28	125.3	24.35	121.5	23.14	117.4	22.42	109.4	20.91	

Note

1. TC: Total Capacity(kW), PI: Power Input(kW, Comp. + Outdoor fan motor)
2. Capacity tables show the average value of conditions which may occur.
3. In the range beyond the operation limit of the outdoor unit, continuous operation and performance can not be guaranteed. When selecting the outdoor units, avoid the air temperature range that is not guaranteed continuous operation.

7. Capacity Tables

◆ A(C)RUN920LLS5

Combination (%)	Outdoor air temp.		Indoor air temp. °C DB											
	°C DB	°C WB	16		18		20		21		22		24	
			TC	PI	TC	PI	TC	PI	TC	PI	TC	PI	TC	PI
130	-19.8	-20	149.3	64.46	149.3	66.93	148.3	69.10	148.3	72.42	148.3	75.59	148.3	80.58
	-18.8	-19	156.4	66.11	156.4	68.60	155.4	70.78	155.4	74.09	155.4	77.24	155.4	82.23
	-16.7	-17	171.6	69.60	171.6	72.10	170.6	74.24	170.6	77.59	170.6	80.73	170.6	85.72
	-13.7	-15	193.2	74.59	193.2	77.09	192.1	79.23	192.1	82.55	192.1	85.72	192.1	84.76
	-11.8	-13	204.2	77.73	204.2	80.23	202.8	82.40	202.8	85.72	202.8	85.26	202.8	84.15
	-9.8	-11	215.6	81.08	215.6	83.55	214.1	85.72	214.1	85.44	214.1	84.76	214.1	83.51
	-9.5	-10	220.8	81.58	220.8	84.05	219.4	85.72	219.4	85.40	215.9	84.69	215.9	83.44
	-8.5	-9.1	237.8	83.23	237.8	85.72	236.4	85.72	236.4	85.26	221.6	84.44	221.6	83.12
	-7.0	-7.6	263.6	85.72	263.6	85.94	261.9	85.69	261.9	85.04	261.9	84.05	239.9	82.62
	-5.0	-5.6	297.9	86.47	297.9	86.26	295.8	85.65	295.8	84.76	295.8	83.55	254.4	81.98
	-3.0	-3.7	332.2	87.22	332.2	86.58	330.1	85.65	323.8	84.47	312.4	83.05	268.8	81.34
	0.0	-0.7	333.0	88.36	333.0	87.01	331.9	85.61	323.8	84.05	312.4	82.30	290.1	80.38
	3.0	2.2	333.0	89.50	333.0	87.47	331.9	85.58	323.8	83.62	312.4	81.55	290.9	79.44
	5.0	4.1	333.0	90.25	333.0	87.79	331.9	85.55	323.8	83.33	312.4	81.05	290.9	78.80
	7.0	6	333.0	91.03	333.0	88.08	331.9	85.54	323.8	83.05	312.4	80.56	290.9	78.16
	9.0	7.9	333.0	91.89	333.0	88.93	331.9	86.36	323.8	83.84	312.4	81.34	290.9	78.91
	11.0	9.8	333.0	93.71	333.0	90.68	331.9	88.04	323.8	85.48	312.4	82.94	290.9	80.45
	13.0	11.8	333.0	95.49	333.0	92.43	331.9	89.72	323.8	87.11	312.4	84.51	290.9	81.98
15.0	13.7	333.0	97.28	333.0	94.14	331.9	91.43	323.8	88.75	312.4	86.12	290.9	83.55	
120	-19.8	-20	148.3	66.93	148.3	69.10	147.2	72.42	147.2	75.59	147.2	80.58	147.2	84.05
	-18.8	-19	155.4	68.60	155.4	70.78	154.3	74.09	154.3	77.24	154.3	82.23	154.3	85.72
	-16.7	-17	170.2	72.10	170.2	74.24	169.2	77.59	169.2	80.73	169.2	85.72	169.2	85.11
	-13.7	-15	191.8	77.09	191.8	79.23	190.7	82.55	190.7	85.72	190.7	84.94	190.7	84.22
	-11.8	-13	202.8	80.23	202.8	82.40	201.4	85.72	201.4	85.22	201.4	84.44	201.4	83.66
	-9.8	-11	214.1	83.55	214.1	85.72	212.7	85.33	212.7	84.69	212.7	83.94	212.7	83.08
	-9.5	-10	219.1	84.05	219.1	85.69	218.0	85.26	218.0	84.62	218.0	83.83	218.0	82.98
	-8.5	-9.1	236.1	85.72	236.1	85.54	234.6	85.04	234.6	84.37	227.5	83.58	227.5	82.69
	-7.0	-7.6	261.8	85.72	261.8	85.36	260.1	84.73	260.1	83.97	238.4	83.19	238.4	82.26
	-5.0	-5.6	295.8	85.76	295.8	85.08	294.0	84.33	294.0	83.44	294.0	82.69	252.6	81.66
	-3.0	-3.7	326.9	85.76	326.9	84.83	313.9	83.91	303.6	82.91	294.0	82.16	266.7	81.08
	0.0	-0.7	330.2	85.79	326.9	84.44	313.9	83.30	303.6	82.12	294.0	81.37	273.2	80.19
	3.0	2.2	330.2	85.80	326.9	84.05	313.9	82.69	303.6	81.34	294.0	80.59	273.2	79.30
	5.0	4.1	330.2	85.83	326.9	83.76	313.9	82.27	303.6	80.84	294.0	80.06	273.2	78.70
	7.0	6	330.2	85.83	326.9	83.51	313.9	81.87	303.6	80.30	294.0	79.55	273.2	78.13
	9.0	7.9	330.2	86.26	326.9	83.94	313.9	82.27	303.6	80.70	294.0	79.95	273.2	78.52
	11.0	9.8	330.2	87.54	326.9	85.15	313.9	83.48	303.6	81.87	294.0	81.12	273.2	79.66
	13.0	11.8	330.2	88.79	326.9	86.37	313.9	84.69	303.6	83.05	294.0	82.27	273.2	80.80
15.0	13.7	330.2	90.00	326.9	87.58	313.9	85.86	303.6	84.19	294.0	83.41	273.2	81.91	
110	-19.8	-20	147.2	69.10	147.2	72.42	146.5	75.59	146.5	80.58	146.5	84.05	146.5	85.72
	-18.8	-19	154.3	70.78	154.3	74.09	153.6	77.24	153.6	82.23	153.6	85.72	153.6	85.26
	-16.7	-17	169.5	74.24	169.5	77.59	168.4	80.73	168.4	85.72	168.4	84.87	168.4	84.26
	-13.7	-15	190.7	79.23	190.7	82.55	189.6	85.72	189.6	84.54	189.6	83.69	189.6	82.83
	-11.8	-13	201.7	82.40	201.7	85.72	200.3	84.94	200.3	83.79	200.3	82.91	200.3	81.94
	-9.8	-11	213.0	85.72	213.0	84.90	211.6	84.12	211.6	82.98	211.6	82.12	211.6	80.98
	-9.5	-10	218.0	85.61	218.0	84.79	216.6	84.01	216.6	82.87	216.6	81.98	216.6	80.84
	-8.5	-9.1	235.0	85.22	235.0	84.40	233.5	83.59	233.5	82.48	227.6	81.59	227.6	80.37
	-7.0	-7.6	260.4	84.65	260.4	83.80	258.7	82.98	258.7	81.87	238.6	80.98	238.6	79.66
	-5.0	-5.6	283.4	83.90	283.4	82.98	281.7	82.16	272.5	81.09	250.0	80.16	245.9	78.70
	-3.0	-3.7	300.1	83.15	300.1	82.19	281.7	81.34	272.5	80.30	263.3	79.37	245.9	77.77
	0.0	-0.7	317.4	82.01	300.1	80.98	281.7	80.12	272.5	79.09	263.3	78.16	245.9	76.34
	3.0	2.2	317.4	80.87	300.1	79.77	281.7	78.91	272.5	77.91	263.3	76.95	245.9	74.92
	5.0	4.1	317.4	80.09	300.1	78.95	281.7	78.09	272.5	77.13	263.3	76.16	245.9	73.96
	7.0	6	317.4	79.34	300.1	78.13	281.7	77.27	272.5	76.34	263.3	75.35	245.9	73.03
	9.0	7.9	317.4	79.27	300.1	78.09	281.7	77.20	272.5	76.27	263.3	75.31	245.9	72.96
	11.0	9.8	317.4	79.98	300.1	78.77	281.7	77.91	272.5	76.95	263.3	75.96	245.9	73.63
	13.0	11.8	317.4	80.66	300.1	79.45	281.7	78.56	272.5	77.59	263.3	76.60	245.9	74.24
15.0	13.7	317.4	81.30	300.1	80.09	281.7	79.17	272.5	78.20	263.3	77.20	245.9	74.81	

Note

1. TC: Total Capacity(kW), PI : Power Input(kW, Comp. + Outdoor fan motor)
2. Capacity tables show the average value of conditions which may occur.
3. In the range beyond the operation limit of the outdoor unit, continuous operation and performance can not be guaranteed. When selecting the outdoor units, avoid the air temperature range that is not guaranteed continuous operation.

7. Capacity Tables

Combination (%)		Heating Capacity (92HP)												
		Outdoor air temp.		Indoor air temp. °C DB										
		°C DB	°C WB	16		18		20		21		22		24
		TC	PI	TC	PI	TC	PI	TC	PI	TC	PI	TC	PI	
100	-19.8	-20	146.9	71.96	146.9	74.70	145.8	77.02	145.8	81.44	145.8	84.54	145.8	85.72
	-18.8	-19	153.9	73.31	152.9	76.06	152.9	78.70	152.9	82.83	152.9	85.72	152.9	84.94
	-16.7	-17	167.7	76.20	167.7	78.98	167.7	82.19	166.7	85.72	166.7	84.19	166.7	83.26
	-13.7	-15	190.0	80.34	190.0	83.12	188.9	85.72	188.9	83.72	188.9	82.01	188.9	80.87
	-11.8	-13	200.6	82.97	199.6	85.72	199.6	84.58	199.6	82.44	199.6	80.62	199.6	79.34
	-9.8	-11	211.7	85.72	211.7	84.51	210.6	83.33	210.6	81.12	210.6	79.16	210.6	77.74
	-9.5	-10	216.9	85.58	216.9	84.33	215.9	83.16	215.9	80.91	215.9	78.95	215.9	77.52
	-8.5	-9.1	233.6	85.04	233.6	83.73	232.5	82.55	249.4	80.27	241.0	78.20	224.7	76.70
	-7.0	-7.6	263.3	84.23	262.2	82.83	257.6	81.62	249.4	79.27	241.0	77.13	224.7	75.52
	-5.0	-5.6	274.6	83.19	272.1	81.62	257.6	80.41	249.4	77.92	241.0	75.67	224.7	73.92
	-3.0	-3.7	282.7	82.12	274.2	80.41	257.6	79.20	249.4	76.59	241.0	74.20	224.7	72.32
	0.0	-0.7	290.5	80.52	274.2	78.62	257.6	77.38	249.4	74.60	241.0	72.03	224.7	69.93
	3.0	2.2	290.5	78.91	274.2	76.81	257.6	75.53	249.4	72.60	241.0	69.82	224.7	67.54
	5.0	4.1	290.5	77.88	274.2	75.60	257.6	74.31	249.4	71.28	241.0	68.36	224.7	65.93
	7.0	6	290.5	76.81	274.2	74.39	257.6	73.10	249.4	69.93	241.0	66.90	224.7	64.36
	9.0	7.9	290.5	75.74	274.2	73.35	257.6	72.10	249.4	68.96	241.0	66.00	224.7	63.47
	11.0	9.8	290.5	75.38	274.2	73.00	257.6	71.75	249.4	68.64	241.0	65.68	224.7	63.15
	13.0	11.8	290.5	74.95	274.2	72.60	257.6	71.32	249.4	68.25	241.0	65.29	224.7	62.80
15.0	13.7	290.5	74.42	274.2	72.10	257.6	70.85	249.4	67.79	241.0	64.83	224.7	62.37	
90	-19.8	-20	146.2	67.78	146.2	72.78	145.1	76.24	145.1	77.91	145.1	76.81	145.1	74.88
	-18.8	-19	153.9	69.43	152.9	74.42	152.2	77.91	152.2	77.38	152.2	76.27	152.2	74.24
	-16.7	-17	167.7	72.92	167.7	77.91	167.0	76.95	167.0	76.31	167.0	75.10	167.0	72.96
	-13.7	-15	190.0	77.91	190.0	76.67	187.9	75.60	187.9	74.74	187.9	73.46	187.9	71.14
	-11.8	-13	200.6	77.20	199.6	75.88	198.5	74.74	198.5	73.74	198.5	72.42	198.5	69.99
	-9.8	-11	211.7	76.45	211.7	75.03	209.9	73.82	209.9	72.71	209.9	71.31	192.5	68.75
	-9.5	-10	216.9	76.35	216.9	74.92	214.8	73.70	214.8	72.53	214.8	71.14	197.1	68.57
	-8.5	-9.1	233.6	75.99	232.1	74.49	231.5	73.24	228.3	72.03	221.1	70.60	205.2	67.97
	-7.0	-7.6	263.3	75.42	250.5	73.88	235.7	72.56	228.3	71.25	221.1	69.75	205.2	67.04
	-5.0	-5.6	266.1	74.67	250.5	73.03	235.7	71.64	228.3	70.21	221.1	68.64	205.2	65.83
	-3.0	-3.7	266.1	73.92	250.5	72.21	235.7	70.75	228.3	69.14	221.1	67.57	205.2	64.61
	0.0	-0.7	266.1	72.81	250.5	70.96	235.7	69.39	228.3	67.61	221.1	65.90	205.2	62.79
	3.0	2.2	266.1	71.68	250.5	69.71	235.7	68.00	228.3	66.04	221.1	64.26	205.2	60.94
	5.0	4.1	266.1	70.93	250.5	68.86	235.7	67.11	228.3	64.97	221.1	63.15	205.2	59.73
	7.0	6	266.1	70.18	250.5	68.04	235.7	66.22	228.3	63.94	221.1	62.05	205.2	58.51
	9.0	7.9	266.1	69.22	250.5	67.11	235.7	65.29	228.3	63.08	221.1	61.19	205.2	57.70
	11.0	9.8	266.1	68.25	250.5	66.15	235.7	64.40	228.3	62.19	221.1	60.34	205.2	56.91
	13.0	11.8	266.1	67.29	250.5	65.22	235.7	63.47	228.3	61.30	221.1	59.48	205.2	56.09
15.0	13.7	266.1	66.33	250.5	64.29	235.7	62.58	228.3	60.44	221.1	58.63	205.2	55.30	
80	-19.8	-20	144.7	58.94	144.7	63.93	144.7	69.10	144.7	68.04	144.7	66.43	144.7	64.72
	-18.8	-19	151.5	60.62	151.5	69.10	151.5	68.61	151.5	67.50	151.5	65.90	151.5	64.18
	-16.7	-17	167.0	69.10	167.0	68.18	167.0	67.61	167.0	66.43	167.0	64.79	167.0	63.01
	-13.7	-15	196.7	67.93	192.8	66.90	187.9	66.18	187.9	64.83	187.9	63.19	183.3	61.33
	-11.8	-13	212.7	67.18	206.7	66.11	198.5	65.29	198.5	63.86	197.1	62.19	183.3	60.30
	-9.8	-11	219.4	66.39	213.1	65.25	209.9	64.33	204.5	62.80	197.1	61.12	183.3	59.19
	-9.5	-10	220.8	66.25	214.4	65.11	210.9	64.19	204.5	62.65	197.1	60.98	183.3	59.01
	-8.5	-9.1	229.0	65.86	224.7	64.68	210.9	63.72	204.5	62.12	197.1	60.44	183.3	58.45
	-7.0	-7.6	238.2	65.29	224.7	64.04	210.9	63.01	204.5	61.33	197.1	59.65	183.3	57.62
	-5.0	-5.6	238.2	64.50	224.7	63.19	210.9	62.05	204.5	60.30	197.1	58.59	183.3	56.52
	-3.0	-3.7	238.2	63.72	224.7	62.33	210.9	61.08	204.5	59.23	197.1	57.52	183.3	55.41
	0.0	-0.7	238.2	62.54	224.7	61.05	210.9	59.66	204.5	57.66	197.1	55.92	183.3	53.74
	3.0	2.2	238.2	61.37	224.7	59.76	210.9	58.23	204.5	56.09	197.1	54.34	183.3	52.06
	5.0	4.1	238.2	60.58	224.7	58.91	210.9	57.30	204.5	55.02	197.1	53.27	183.3	50.96
	7.0	6	238.2	59.80	224.7	58.05	210.9	56.34	204.5	53.99	197.1	52.21	183.3	49.85
	9.0	7.9	238.2	56.13	224.7	54.49	210.9	52.88	204.5	50.70	197.1	49.03	183.3	46.82
	11.0	9.8	238.2	52.10	224.7	50.60	210.9	49.10	204.5	47.04	197.1	45.50	183.3	43.43
	13.0	11.8	238.2	48.64	224.7	47.21	210.9	45.82	204.5	43.93	197.1	42.47	183.3	40.55
15.0	13.7	238.2	45.78	224.7	44.46	210.9	43.15	204.5	41.33	197.1	39.98	183.3	38.19	

Note

1. TC: Total Capacity(kW), PI: Power Input(kW, Comp. + Outdoor fan motor)
2. Capacity tables show the average value of conditions which may occur.
3. In the range beyond the operation limit of the outdoor unit, continuous operation and performance can not be guaranteed. When selecting the outdoor units, avoid the air temperature range that is not guaranteed continuous operation.

7. Capacity Tables

Combination (%)		Heating Capacity (92HP)												
		Outdoor air temp.		Indoor air temp. °C DB										
		°C DB	°C WB	16		18		20		21		22		24
		TC	PI	TC	PI	TC	PI	TC	PI	TC	PI	TC	PI	
70	-19.8	-20	144.7	62.44	144.7	64.11	144.7	63.01	144.7	61.26	144.7	59.62	144.7	57.80
	-18.8	-19	151.5	64.11	151.5	63.58	151.5	62.47	151.5	60.72	151.5	59.08	151.5	57.20
	-16.7	-17	167.0	63.12	167.0	62.47	167.0	61.30	167.0	59.51	167.0	57.91	167.0	55.98
	-13.7	-15	202.0	61.72	190.7	60.90	179.4	59.66	173.4	57.83	168.1	56.23	156.8	54.20
	-11.8	-13	202.0	60.83	190.7	59.87	179.4	58.62	173.4	56.73	168.1	55.16	156.8	53.09
	-9.8	-11	202.0	59.90	190.7	58.83	179.4	57.52	173.4	55.62	168.1	54.06	156.8	51.92
	-9.5	-10	202.0	59.76	190.7	58.66	179.4	57.34	173.4	55.45	168.1	53.88	156.8	51.74
	-8.5	-9.1	202.0	59.30	190.7	58.16	179.4	56.80	173.4	54.88	168.1	53.34	156.8	51.17
	-7.0	-7.6	202.0	58.59	190.7	57.34	179.4	55.98	173.4	54.02	168.1	52.49	156.8	50.28
	-5.0	-5.6	202.0	57.66	190.7	56.30	179.4	54.88	173.4	52.88	168.1	51.38	156.8	49.10
	-3.0	-3.7	202.0	56.73	190.7	55.24	179.4	53.77	173.4	51.77	168.1	50.28	156.8	47.92
	0.0	-0.7	202.0	55.34	190.7	53.66	179.4	52.13	173.4	50.07	168.1	48.60	156.8	46.14
	3.0	2.2	202.0	53.92	190.7	52.06	179.4	50.49	173.4	48.39	168.1	46.93	156.8	44.39
	5.0	4.1	202.0	52.99	190.7	51.03	179.4	49.39	173.4	47.25	168.1	45.82	156.8	43.22
	7.0	6	202.0	52.06	190.7	49.96	179.4	48.28	173.4	46.11	168.1	44.72	156.8	42.04
	9.0	7.9	202.0	47.00	190.7	45.11	179.4	43.61	173.4	41.65	168.1	40.37	156.8	37.97
	11.0	9.8	202.0	43.76	190.7	42.01	179.4	40.61	173.4	38.76	168.1	37.59	156.8	35.34
	13.0	11.8	202.0	40.94	190.7	39.30	179.4	37.98	173.4	36.27	168.1	35.16	156.8	33.06
15.0	13.7	202.0	38.62	190.7	37.05	179.4	35.80	173.4	34.20	168.1	33.16	156.8	31.17	
60	-19.8	-20	173.4	59.12	164.2	58.01	144.7	56.30	144.7	54.63	143.7	52.95	134.4	51.13
	-18.8	-19	173.4	58.62	164.2	57.48	151.5	55.73	148.6	54.06	143.7	52.41	134.4	50.56
	-16.7	-17	173.4	57.62	164.2	56.30	153.9	54.56	148.6	52.88	143.7	51.24	134.4	49.31
	-13.7	-15	173.4	56.16	164.2	54.66	153.9	52.88	148.6	51.21	143.7	49.56	134.4	47.53
	-11.8	-13	173.4	55.27	164.2	53.60	153.9	51.81	148.6	50.17	143.7	48.50	134.4	46.43
	-9.8	-11	173.4	54.30	164.2	52.52	153.9	50.67	148.6	49.03	143.7	47.39	134.4	45.25
	-9.5	-10	173.4	54.13	164.2	52.35	153.9	50.53	148.6	48.85	143.7	47.21	134.4	45.07
	-8.5	-9.1	173.4	53.66	164.2	51.78	153.9	49.96	148.6	48.32	143.7	46.67	134.4	44.47
	-7.0	-7.6	173.4	52.95	164.2	50.96	153.9	49.10	148.6	47.46	143.7	45.82	134.4	43.61
	-5.0	-5.6	173.4	51.99	164.2	49.85	153.9	47.99	148.6	46.35	143.7	44.71	134.4	42.43
	-3.0	-3.7	173.4	50.99	164.2	48.78	153.9	46.86	148.6	45.22	143.7	43.61	134.4	41.25
	0.0	-0.7	173.4	49.56	164.2	47.11	153.9	45.18	148.6	43.54	143.7	41.93	134.4	39.47
	3.0	2.2	173.4	48.10	164.2	45.46	153.9	43.50	148.6	41.86	143.7	40.26	134.4	37.69
	5.0	4.1	173.4	47.14	164.2	44.36	153.9	42.36	148.6	40.76	143.7	39.12	134.4	36.52
	7.0	6	173.4	46.18	164.2	43.25	153.9	41.22	148.6	39.62	143.7	38.01	134.4	35.34
	9.0	7.9	173.4	41.22	164.2	38.58	153.9	36.80	148.6	35.37	143.7	33.91	134.4	31.56
	11.0	9.8	173.4	38.48	164.2	36.05	153.9	34.34	148.6	33.02	143.7	31.67	134.4	29.45
	13.0	11.8	173.4	36.05	164.2	33.77	153.9	32.20	148.6	30.92	143.7	29.67	134.4	27.60
15.0	13.7	173.4	34.06	164.2	31.91	153.9	30.42	148.6	29.24	143.7	28.03	134.4	26.07	
50	-19.8	-20	144.7	52.95	136.6	51.10	128.1	49.38	124.2	47.60	120.0	46.00	111.8	44.25
	-18.8	-19	144.7	52.38	136.6	50.49	128.1	48.78	124.2	47.03	120.0	45.43	111.8	43.65
	-16.7	-17	144.7	51.13	136.6	49.24	128.1	47.53	124.2	45.82	120.0	44.25	111.8	42.47
	-13.7	-15	144.7	49.38	136.6	47.42	128.1	45.78	124.2	44.04	120.0	42.54	111.8	40.72
	-11.8	-13	144.7	48.28	136.6	46.25	128.1	44.68	124.2	42.93	120.0	41.50	111.8	39.65
	-9.8	-11	144.7	47.10	136.6	45.04	128.1	43.50	124.2	41.76	120.0	40.36	111.8	38.51
	-9.5	-10	144.7	46.92	136.6	44.86	128.1	43.32	124.2	41.58	120.0	40.19	111.8	38.33
	-8.5	-9.1	144.7	46.32	136.6	44.25	128.1	42.72	124.2	41.00	120.0	39.65	111.8	37.76
	-7.0	-7.6	144.7	45.46	136.6	43.36	128.1	41.83	124.2	40.12	120.0	38.79	111.8	36.90
	-5.0	-5.6	144.7	44.29	136.6	42.15	128.1	40.65	124.2	38.94	120.0	37.66	111.8	35.73
	-3.0	-3.7	144.7	43.11	136.6	40.93	128.1	39.47	124.2	37.76	120.0	36.55	111.8	34.59
	0.0	-0.7	144.7	41.36	136.6	39.12	128.1	37.72	124.2	36.01	120.0	34.87	111.8	32.88
	3.0	2.2	144.7	39.58	136.6	37.30	128.1	35.94	124.2	34.27	120.0	33.16	111.8	31.16
	5.0	4.1	144.7	38.44	136.6	36.09	128.1	34.77	124.2	33.09	120.0	32.06	111.8	29.99
	7.0	6	144.7	37.26	136.6	34.87	128.1	33.59	124.2	31.91	120.0	30.92	111.8	28.85
	9.0	7.9	144.7	33.63	136.6	31.49	128.1	30.34	124.2	28.81	120.0	27.92	111.8	26.06
	11.0	9.8	144.7	31.48	136.6	29.46	128.1	28.38	124.2	26.96	120.0	26.14	111.8	24.39
	13.0	11.8	144.7	29.56	136.6	27.67	128.1	26.64	124.2	25.32	120.0	24.53	111.8	22.89
15.0	13.7	144.7	27.96	136.6	26.17	128.1	25.21	124.2	23.96	120.0	23.21	111.8	21.65	

Note

1. TC: Total Capacity(kW), PI: Power Input(kW, Comp. + Outdoor fan motor)
2. Capacity tables show the average value of conditions which may occur.
3. In the range beyond the operation limit of the outdoor unit, continuous operation and performance can not be guaranteed. When selecting the outdoor units, avoid the air temperature range that is not guaranteed continuous operation.

7. Capacity Tables

◆ A(C)RUN940LLS5

Combination (%)		Outdoor air temp.		Indoor air temp. °C DB										Heating Capacity (94HP)	
				16		18		20		21		22		24	
		°C DB	°C WB	TC	PI	TC	PI	TC	PI	TC	PI	TC	PI	TC	PI
130	-19.8	-20	152.5	64.89	152.5	67.38	151.5	69.57	151.5	72.91	151.5	76.10	151.5	81.13	
	-18.8	-19	159.8	66.55	159.8	69.06	158.7	71.25	158.7	74.60	158.7	77.76	158.7	82.79	
	-16.7	-17	175.3	70.07	175.3	72.58	174.3	74.74	174.3	78.11	174.3	81.28	174.3	86.31	
	-13.7	-15	197.4	75.10	197.4	77.61	196.3	79.77	196.3	83.11	196.3	86.31	196.3	85.34	
	-11.8	-13	208.6	78.26	208.6	80.78	207.2	82.97	207.2	86.31	207.2	85.84	207.2	84.73	
	-9.8	-11	220.2	81.63	220.2	84.12	218.8	86.31	218.8	86.02	218.8	85.34	218.8	84.08	
	-9.5	-10	225.6	82.14	225.6	84.62	224.2	86.31	224.2	85.98	220.6	85.26	220.6	84.01	
	-8.5	-9.1	243.0	83.79	243.0	86.31	241.5	86.30	241.5	85.84	226.4	85.01	226.4	83.68	
	-7.0	-7.6	269.3	86.31	269.3	86.53	267.6	86.27	267.6	85.62	267.6	84.62	245.2	83.19	
	-5.0	-5.6	304.4	87.06	304.4	86.85	302.3	86.24	302.3	85.34	302.3	84.12	260.0	82.54	
	-3.0	-3.7	339.4	87.82	339.4	87.17	337.2	86.23	330.8	85.05	319.2	83.62	274.8	81.89	
	0.0	-0.7	340.2	88.97	340.2	87.60	339.1	86.20	330.8	84.62	319.2	82.86	296.6	80.93	
	3.0	2.2	340.2	90.12	340.2	88.07	339.1	86.16	330.8	84.19	319.2	82.11	297.2	79.99	
	5.0	4.1	340.2	90.87	340.2	88.39	339.1	86.13	330.8	83.90	319.2	81.61	297.2	79.34	
	7.0	6	340.2	91.66	340.2	88.68	339.1	86.13	330.8	83.61	319.2	81.11	297.2	78.70	
	9.0	7.9	340.2	92.52	340.2	89.54	339.1	86.95	330.8	84.41	319.2	81.90	297.2	79.45	
11.0	9.8	340.2	94.35	340.2	91.30	339.1	88.64	330.8	86.06	319.2	83.51	297.2	81.00		
13.0	11.8	340.2	96.15	340.2	93.06	339.1	90.33	330.8	87.71	319.2	85.09	297.2	82.54		
15.0	13.7	340.2	97.94	340.2	94.79	339.1	92.05	330.8	89.36	319.2	86.71	297.2	84.12		
120	-19.8	-20	151.5	67.38	151.5	69.57	150.4	72.91	150.4	76.10	150.4	81.13	150.4	84.62	
	-18.8	-19	158.7	69.06	158.7	71.25	157.6	74.60	157.6	77.76	157.6	82.79	157.6	86.31	
	-16.7	-17	173.9	72.58	173.9	74.74	172.8	78.11	172.8	81.28	172.8	86.31	172.8	85.69	
	-13.7	-15	196.0	77.61	196.0	79.77	194.9	83.11	194.9	86.31	194.9	85.52	194.9	84.80	
	-11.8	-13	207.2	80.78	207.2	82.97	205.8	86.31	205.8	85.80	205.8	85.02	205.8	84.23	
	-9.8	-11	218.8	84.12	218.8	86.31	217.3	85.91	217.3	85.27	217.3	84.51	217.3	83.65	
	-9.5	-10	223.8	84.62	223.8	86.27	222.7	85.84	222.7	85.20	222.7	84.41	222.7	83.54	
	-8.5	-9.1	241.2	86.31	241.2	86.13	239.7	85.63	239.7	84.94	232.6	84.15	232.6	83.26	
	-7.0	-7.6	267.5	86.31	267.5	85.95	265.7	85.30	265.7	84.55	243.7	83.76	243.7	82.82	
	-5.0	-5.6	302.2	86.34	302.2	85.66	300.4	84.91	300.4	84.01	300.4	83.25	258.2	82.22	
	-3.0	-3.7	334.0	86.34	334.0	85.41	320.7	84.48	310.2	83.47	300.4	82.72	272.7	81.64	
	0.0	-0.7	337.3	86.38	334.0	85.02	320.7	83.87	310.2	82.69	300.4	81.93	279.1	80.74	
	3.0	2.2	337.3	86.38	334.0	84.62	320.7	83.26	310.2	81.90	300.4	81.14	279.1	79.85	
	5.0	4.1	337.3	86.42	334.0	84.34	320.7	82.83	310.2	81.39	300.4	80.60	279.1	79.24	
	7.0	6	337.3	86.42	334.0	84.08	320.7	82.43	310.2	80.85	300.4	80.10	279.1	78.66	
	9.0	7.9	337.3	86.85	334.0	84.51	320.7	82.83	310.2	81.25	300.4	80.49	279.1	79.06	
11.0	9.8	337.3	88.14	334.0	85.74	320.7	84.05	310.2	82.44	300.4	81.68	279.1	80.21		
13.0	11.8	337.3	89.40	334.0	86.96	320.7	85.27	310.2	83.62	300.4	82.83	279.1	81.36		
15.0	13.7	337.3	90.62	334.0	88.18	320.7	86.45	310.2	84.77	300.4	83.98	279.1	82.47		
110	-19.8	-20	150.4	69.57	150.4	72.91	149.7	76.10	149.7	81.13	149.7	84.62	149.7	86.31	
	-18.8	-19	157.7	71.25	157.7	74.60	156.9	77.76	156.9	82.79	156.9	86.31	156.9	85.84	
	-16.7	-17	173.2	74.74	173.2	78.11	172.1	81.28	172.1	86.31	172.1	85.45	172.1	84.83	
	-13.7	-15	194.9	79.77	194.9	83.11	193.8	86.31	193.8	85.12	193.8	84.26	193.8	83.40	
	-11.8	-13	206.1	82.97	206.1	86.31	204.7	85.52	204.7	84.37	204.7	83.47	204.7	82.50	
	-9.8	-11	217.7	86.31	217.7	85.48	216.2	84.69	216.2	83.54	216.2	82.68	216.2	81.53	
	-9.5	-10	222.7	86.20	222.7	85.37	221.3	84.58	221.3	83.44	221.3	82.54	221.3	81.39	
	-8.5	-9.1	240.1	85.81	240.1	84.98	238.6	84.16	238.6	83.04	232.5	82.14	232.5	80.92	
	-7.0	-7.6	266.1	85.23	266.1	84.37	264.3	83.54	264.3	82.43	243.7	81.53	243.7	80.20	
	-5.0	-5.6	289.6	84.48	289.6	83.54	287.8	82.72	278.4	81.64	255.3	80.71	251.3	79.24	
	-3.0	-3.7	306.6	83.72	306.6	82.75	287.8	81.89	278.4	80.85	269.0	79.92	251.3	78.30	
	0.0	-0.7	324.3	82.57	306.6	81.53	287.8	80.67	278.4	79.63	269.0	78.70	251.3	76.87	
	3.0	2.2	324.3	81.42	306.6	80.31	287.8	79.45	278.4	78.45	269.0	77.48	251.3	75.43	
	5.0	4.1	324.3	80.64	306.6	79.49	287.8	78.62	278.4	77.66	269.0	76.69	251.3	74.46	
	7.0	6	324.3	79.88	306.6	78.66	287.8	77.80	278.4	76.86	269.0	75.86	251.3	73.53	
	9.0	7.9	324.3	79.81	306.6	78.63	287.8	77.73	278.4	76.80	269.0	75.82	251.3	73.46	
11.0	9.8	324.3	80.53	306.6	79.31	287.8	78.45	278.4	77.48	269.0	76.48	251.3	74.14		
13.0	11.8	324.3	81.21	306.6	79.99	287.8	79.09	278.4	78.13	269.0	77.12	251.3	74.75		
15.0	13.7	324.3	81.86	306.6	80.64	287.8	79.71	278.4	78.74	269.0	77.73	251.3	75.33		

Note

1. TC: Total Capacity(kW), PI : Power Input(kW, Comp. + Outdoor fan motor)
2. Capacity tables show the average value of conditions which may occur.
3. In the range beyond the operation limit of the outdoor unit, continuous operation and performance can not be guaranteed. When selecting the outdoor units, avoid the air temperature range that is not guaranteed continuous operation.

7. Capacity Tables

Combination (%)		Heating Capacity (94HP)												
		Outdoor air temp.		Indoor air temp. °C DB										
		°C DB	°C WB	16		18		20		21		22		24
		TC	PI	TC	PI	TC	PI	TC	PI	TC	PI	TC	PI	
100	-19.8	-20	150.0	72.44	150.0	75.21	148.9	77.55	148.9	82.00	148.9	85.12	148.9	86.31
	-18.8	-19	157.2	73.81	156.2	76.58	156.2	79.23	156.2	83.40	156.2	86.31	156.2	85.52
	-16.7	-17	171.4	76.72	171.4	79.52	171.4	82.75	170.3	86.31	170.3	84.76	170.3	83.83
	-13.7	-15	194.1	80.89	194.1	83.68	193.1	86.31	193.1	84.30	193.1	82.57	193.1	81.42
	-11.8	-13	205.0	83.54	203.9	86.31	203.9	85.16	203.9	83.01	203.9	81.17	203.9	79.88
	-9.8	-11	216.3	86.31	216.3	85.09	215.2	83.90	215.2	81.68	215.2	79.70	215.2	78.27
	-9.5	-10	221.6	86.16	221.6	84.91	220.6	83.72	220.6	81.46	220.6	79.49	220.6	78.05
	-8.5	-9.1	238.6	85.62	238.6	84.30	237.6	83.11	254.9	80.81	246.2	78.73	229.6	77.23
	-7.0	-7.6	269.0	84.80	267.9	83.40	263.2	82.18	254.9	79.81	246.2	77.65	229.6	76.04
	-5.0	-5.6	280.6	83.76	278.0	82.18	263.2	80.96	254.9	78.45	246.2	76.18	229.6	74.42
	-3.0	-3.7	288.9	82.68	280.2	80.96	263.2	79.74	254.9	77.12	246.2	74.71	229.6	72.81
	0.0	-0.7	296.8	81.07	280.2	79.16	263.2	77.91	254.9	75.11	246.2	72.52	229.6	70.41
	3.0	2.2	296.8	79.45	280.2	77.33	263.2	76.04	254.9	73.10	246.2	70.30	229.6	68.00
	5.0	4.1	296.8	78.41	280.2	76.11	263.2	74.82	254.9	71.77	246.2	68.83	229.6	66.39
	7.0	6	296.8	77.33	280.2	74.89	263.2	73.60	254.9	70.41	246.2	67.36	229.6	64.80
	9.0	7.9	296.8	76.26	280.2	73.85	263.2	72.59	254.9	69.44	246.2	66.45	229.6	63.91
	11.0	9.8	296.8	75.90	280.2	73.50	263.2	72.24	254.9	69.11	246.2	66.13	229.6	63.59
	13.0	11.8	296.8	75.47	280.2	73.10	263.2	71.81	254.9	68.72	246.2	65.74	229.6	63.23
15.0	13.7	296.8	74.93	280.2	72.60	263.2	71.34	254.9	68.25	246.2	65.28	229.6	62.80	
90	-19.8	-20	149.3	68.24	149.3	73.27	148.2	76.76	148.2	78.44	148.2	77.33	148.2	75.39
	-18.8	-19	157.2	69.90	156.2	74.92	155.5	78.44	155.5	77.91	155.5	76.79	155.5	74.75
	-16.7	-17	171.4	73.42	171.4	78.44	170.7	77.48	170.7	76.83	170.7	75.61	170.7	73.46
	-13.7	-15	194.1	78.44	194.1	77.19	192.0	76.11	192.0	75.25	192.0	73.96	192.0	71.62
	-11.8	-13	205.0	77.73	203.9	76.40	202.9	75.25	202.9	74.24	202.9	72.91	202.9	70.47
	-9.8	-11	216.3	76.97	216.3	75.54	214.4	74.32	214.4	73.20	214.4	71.80	196.7	69.22
	-9.5	-10	221.6	76.87	221.6	75.43	219.5	74.21	219.5	73.03	219.5	71.62	201.4	69.04
	-8.5	-9.1	238.6	76.50	237.2	75.00	236.5	73.74	233.2	72.52	225.9	71.08	209.7	68.43
	-7.0	-7.6	269.0	75.93	255.9	74.39	240.8	73.06	233.2	71.73	225.9	70.23	209.7	67.50
	-5.0	-5.6	271.9	75.18	255.9	73.53	240.8	72.13	233.2	70.69	225.9	69.11	209.7	66.28
	-3.0	-3.7	271.9	74.42	255.9	72.70	240.8	71.23	233.2	69.62	225.9	68.03	209.7	65.05
	0.0	-0.7	271.9	73.31	255.9	71.44	240.8	69.86	233.2	68.07	225.9	66.35	209.7	63.22
	3.0	2.2	271.9	72.16	255.9	70.19	240.8	68.47	233.2	66.49	225.9	64.69	209.7	61.36
	5.0	4.1	271.9	71.41	255.9	69.33	240.8	67.57	233.2	65.42	225.9	63.58	209.7	60.14
	7.0	6	271.9	70.66	255.9	68.50	240.8	66.67	233.2	64.37	225.9	62.47	209.7	58.91
	9.0	7.9	271.9	69.69	255.9	67.57	240.8	65.74	233.2	63.51	225.9	61.61	209.7	58.09
	11.0	9.8	271.9	68.72	255.9	66.60	240.8	64.84	233.2	62.61	225.9	60.75	209.7	57.30
	13.0	11.8	271.9	67.75	255.9	65.67	240.8	63.91	233.2	61.72	225.9	59.89	209.7	56.48
15.0	13.7	271.9	66.78	255.9	64.73	240.8	63.01	233.2	60.85	225.9	59.03	209.7	55.68	
80	-19.8	-20	147.8	59.34	147.8	64.37	147.8	69.57	147.8	68.50	147.8	66.89	147.8	65.16
	-18.8	-19	154.8	61.03	154.8	69.57	154.8	69.08	154.8	67.96	154.8	66.35	154.8	64.62
	-16.7	-17	170.7	69.57	170.7	68.65	170.7	68.07	170.7	66.88	170.7	65.23	170.7	63.44
	-13.7	-15	201.0	68.39	197.1	67.35	192.0	66.63	192.0	65.27	192.0	63.62	187.3	61.75
	-11.8	-13	217.3	67.64	211.2	66.56	202.9	65.73	202.9	64.30	201.4	62.61	187.3	60.71
	-9.8	-11	224.2	66.85	217.7	65.70	214.4	64.77	209.0	63.22	201.4	61.54	187.3	59.59
	-9.5	-10	225.6	66.71	219.1	65.56	215.5	64.62	209.0	63.08	201.4	61.39	187.3	59.42
	-8.5	-9.1	233.9	66.31	229.6	65.13	215.5	64.15	209.0	62.54	201.4	60.85	187.3	58.84
	-7.0	-7.6	243.3	65.73	229.6	64.48	215.5	63.44	209.0	61.75	201.4	60.06	187.3	58.02
	-5.0	-5.6	243.3	64.94	229.6	63.62	215.5	62.47	209.0	60.71	201.4	58.99	187.3	56.90
	-3.0	-3.7	243.3	64.15	229.6	62.76	215.5	61.50	209.0	59.63	201.4	57.91	187.3	55.79
	0.0	-0.7	243.3	62.97	229.6	61.46	215.5	60.07	209.0	58.05	201.4	56.30	187.3	54.10
	3.0	2.2	243.3	61.79	229.6	60.17	215.5	58.63	209.0	56.47	201.4	54.71	187.3	52.42
	5.0	4.1	243.3	61.00	229.6	59.31	215.5	57.69	209.0	55.40	201.4	53.64	187.3	51.31
	7.0	6	243.3	60.21	229.6	58.45	215.5	56.72	209.0	54.36	201.4	52.56	187.3	50.19
	9.0	7.9	243.3	56.51	229.6	54.86	215.5	53.25	209.0	51.05	201.4	49.37	187.3	47.14
	11.0	9.8	243.3	52.45	229.6	50.94	215.5	49.44	209.0	47.36	201.4	45.81	187.3	43.73
	13.0	11.8	243.3	48.97	229.6	47.54	215.5	46.14	209.0	44.23	201.4	42.76	187.3	40.82
15.0	13.7	243.3	46.10	229.6	44.77	215.5	43.44	209.0	41.61	201.4	40.25	187.3	38.45	

Note

1. TC: Total Capacity(kW), PI: Power Input(kW, Comp. + Outdoor fan motor)
2. Capacity tables show the average value of conditions which may occur.
3. In the range beyond the operation limit of the outdoor unit, continuous operation and performance can not be guaranteed. When selecting the outdoor units, avoid the air temperature range that is not guaranteed continuous operation.

7. Capacity Tables

Combination (%)		Heating Capacity (94HP)												
		Outdoor air temp.		Indoor air temp. °C DB										
		°C DB	°C WB	16		18		20		21		22		24
		TC	PI	TC	PI	TC	PI	TC	PI	TC	PI	TC	PI	
70	-19.8	-20	147.8	62.86	147.8	64.55	147.8	63.43	147.8	61.68	147.8	60.03	147.8	58.19
	-18.8	-19	154.8	64.55	154.8	64.01	154.8	62.89	154.8	61.13	154.8	59.48	154.8	57.59
	-16.7	-17	170.7	63.54	170.7	62.90	170.7	61.71	170.7	59.92	170.7	58.30	160.2	56.36
	-13.7	-15	206.4	62.14	194.9	61.31	183.3	60.06	177.1	58.23	171.8	56.61	160.2	54.57
	-11.8	-13	206.4	61.25	194.9	60.28	183.3	59.02	177.1	57.12	171.8	55.54	160.2	53.46
	-9.8	-11	206.4	60.31	194.9	59.23	183.3	57.91	177.1	56.00	171.8	54.43	160.2	52.27
	-9.5	-10	206.4	60.17	194.9	59.06	183.3	57.73	177.1	55.82	171.8	54.25	160.2	52.09
	-8.5	-9.1	206.4	59.70	194.9	58.55	183.3	57.19	177.1	55.25	171.8	53.71	160.2	51.52
	-7.0	-7.6	206.4	58.99	194.9	57.73	183.3	56.36	177.1	54.39	171.8	52.85	160.2	50.62
	-5.0	-5.6	206.4	58.05	194.9	56.69	183.3	55.25	177.1	53.24	171.8	51.73	160.2	49.44
	-3.0	-3.7	206.4	57.12	194.9	55.61	183.3	54.14	177.1	52.13	171.8	50.62	160.2	48.25
	0.0	-0.7	206.4	55.72	194.9	54.03	183.3	52.49	177.1	50.41	171.8	48.94	160.2	46.46
	3.0	2.2	206.4	54.29	194.9	52.42	183.3	50.84	177.1	48.72	171.8	47.25	160.2	44.70
	5.0	4.1	206.4	53.35	194.9	51.37	183.3	49.73	177.1	47.57	171.8	46.14	160.2	43.51
	7.0	6	206.4	52.42	194.9	50.30	183.3	48.61	177.1	46.42	171.8	45.02	160.2	42.33
	9.0	7.9	206.4	47.32	194.9	45.42	183.3	43.91	177.1	41.93	171.8	40.64	160.2	38.23
	11.0	9.8	206.4	44.06	194.9	42.29	183.3	40.89	177.1	39.03	171.8	37.84	160.2	35.58
13.0	11.8	206.4	41.22	194.9	39.57	183.3	38.24	177.1	36.51	171.8	35.40	160.2	33.28	
15.0	13.7	206.4	38.88	194.9	37.30	183.3	36.05	177.1	34.43	171.8	33.39	160.2	31.38	
60	-19.8	-20	177.1	59.52	167.7	58.41	147.8	56.68	147.8	55.00	146.8	53.31	137.4	51.48
	-18.8	-19	177.1	59.02	167.7	57.87	154.8	56.11	151.9	54.42	146.8	52.77	137.4	50.90
	-16.7	-17	177.1	58.01	167.7	56.68	157.3	54.93	151.9	53.24	146.8	51.59	137.4	49.65
	-13.7	-15	177.1	56.54	167.7	55.03	157.3	53.24	151.9	51.55	146.8	49.90	137.4	47.86
	-11.8	-13	177.1	55.64	167.7	53.96	157.3	52.16	151.9	50.51	146.8	48.82	137.4	46.74
	-9.8	-11	177.1	54.67	167.7	52.88	157.3	51.02	151.9	49.36	146.8	47.71	137.4	45.56
	-9.5	-10	177.1	54.50	167.7	52.70	157.3	50.87	151.9	49.19	146.8	47.53	137.4	45.38
	-8.5	-9.1	177.1	54.03	167.7	52.13	157.3	50.29	151.9	48.64	146.8	46.99	137.4	44.77
	-7.0	-7.6	177.1	53.31	167.7	51.30	157.3	49.44	151.9	47.78	146.8	46.13	137.4	43.90
	-5.0	-5.6	177.1	52.34	167.7	50.19	157.3	48.32	151.9	46.67	146.8	45.02	137.4	42.72
	-3.0	-3.7	177.1	51.34	167.7	49.11	157.3	47.17	151.9	45.52	146.8	43.90	137.4	41.53
	0.0	-0.7	177.1	49.90	167.7	47.43	157.3	45.49	151.9	43.84	146.8	42.22	137.4	39.74
	3.0	2.2	177.1	48.43	167.7	45.77	157.3	43.80	151.9	42.15	146.8	40.53	137.4	37.95
	5.0	4.1	177.1	47.46	167.7	44.66	157.3	42.65	151.9	41.04	146.8	39.39	137.4	36.77
	7.0	6	177.1	46.49	167.7	43.55	157.3	41.51	151.9	39.89	146.8	38.27	137.4	35.58
	9.0	7.9	177.1	41.50	167.7	38.85	157.3	37.05	151.9	35.61	146.8	34.15	137.4	31.77
	11.0	9.8	177.1	38.74	167.7	36.30	157.3	34.58	151.9	33.25	146.8	31.88	137.4	29.66
13.0	11.8	177.1	36.30	167.7	34.00	157.3	32.42	151.9	31.13	146.8	29.87	137.4	27.79	
15.0	13.7	177.1	34.29	167.7	32.13	157.3	30.62	151.9	29.44	146.8	28.22	137.4	26.25	
50	-19.8	-20	147.9	53.31	139.5	51.44	130.9	49.71	126.9	47.93	122.6	46.30	114.2	44.55
	-18.8	-19	147.9	52.73	139.5	50.83	130.9	49.11	126.9	47.35	122.6	45.73	114.2	43.94
	-16.7	-17	147.9	51.48	139.5	49.57	130.9	47.85	126.9	46.13	122.6	44.55	114.2	42.75
	-13.7	-15	147.9	49.72	139.5	47.74	130.9	46.09	126.9	44.33	122.6	42.83	114.2	41.00
	-11.8	-13	147.9	48.60	139.5	46.56	130.9	44.98	126.9	43.22	122.6	41.78	114.2	39.92
	-9.8	-11	147.9	47.42	139.5	45.34	130.9	43.79	126.9	42.04	122.6	40.64	114.2	38.77
	-9.5	-10	147.9	47.24	139.5	45.16	130.9	43.61	126.9	41.86	122.6	40.46	114.2	38.59
	-8.5	-9.1	147.9	46.63	139.5	44.55	130.9	43.01	126.9	41.28	122.6	39.92	114.2	38.02
	-7.0	-7.6	147.9	45.77	139.5	43.65	130.9	42.11	126.9	40.39	122.6	39.06	114.2	37.15
	-5.0	-5.6	147.9	44.59	139.5	42.43	130.9	40.93	126.9	39.20	122.6	37.91	114.2	35.97
	-3.0	-3.7	147.9	43.40	139.5	41.21	130.9	39.74	126.9	38.02	122.6	36.80	114.2	34.82
	0.0	-0.7	147.9	41.64	139.5	39.38	130.9	37.98	126.9	36.26	122.6	35.11	114.2	33.10
	3.0	2.2	147.9	39.85	139.5	37.55	130.9	36.19	126.9	34.50	122.6	33.39	114.2	31.37
	5.0	4.1	147.9	38.70	139.5	36.33	130.9	35.01	126.9	33.32	122.6	32.27	114.2	30.20
	7.0	6	147.9	37.52	139.5	35.11	130.9	33.82	126.9	32.13	122.6	31.13	114.2	29.05
	9.0	7.9	147.9	33.86	139.5	31.70	130.9	30.55	126.9	29.01	122.6	28.11	114.2	26.24
	11.0	9.8	147.9	31.70	139.5	29.66	130.9	28.58	126.9	27.14	122.6	26.32	114.2	24.56
13.0	11.8	147.9	29.76	139.5	27.86	130.9	26.82	126.9	25.49	122.6	24.70	114.2	23.05	
15.0	13.7	147.9	28.15	139.5	26.35	130.9	25.38	126.9	24.13	122.6	23.37	114.2	21.80	

Note

1. TC: Total Capacity(kW), PI: Power Input(kW, Comp. + Outdoor fan motor)
2. Capacity tables show the average value of conditions which may occur.
3. In the range beyond the operation limit of the outdoor unit, continuous operation and performance can not be guaranteed. When selecting the outdoor units, avoid the air temperature range that is not guaranteed continuous operation.

7. Capacity Tables

◆ A(C)RUN960LLS5

Combination (%)		Outdoor air temp.		Indoor air temp. °C DB										Heating Capacity (96HP)	
				16		18		20		21		22		24	
		°C DB	°C WB	TC	PI	TC	PI	TC	PI	TC	PI	TC	PI	TC	PI
130	-19.8	-20	155.8	64.89	155.8	67.38	154.8	69.57	154.8	72.91	154.8	76.10	154.8	81.13	
	-18.8	-19	163.2	66.55	163.2	69.06	162.1	71.25	162.1	74.60	162.1	77.76	162.1	82.79	
	-16.7	-17	179.1	70.07	179.1	72.58	178.0	74.74	178.0	78.11	178.0	81.28	178.0	86.31	
	-13.7	-15	201.6	75.10	201.6	77.61	200.5	79.77	200.5	83.11	200.5	86.31	200.5	85.34	
	-11.8	-13	213.0	78.26	213.0	80.78	211.6	82.97	211.6	86.31	211.6	85.84	211.6	84.73	
	-9.8	-11	224.9	81.63	224.9	84.12	223.4	86.31	223.4	86.02	223.4	85.34	223.4	84.08	
	-9.5	-10	230.4	82.14	230.4	84.62	228.9	86.31	228.9	85.98	225.3	85.26	225.3	84.01	
	-8.5	-9.1	248.2	83.79	248.2	86.31	246.7	86.30	246.7	85.84	231.2	85.01	231.2	83.68	
	-7.0	-7.6	275.1	86.31	275.1	86.53	273.2	86.27	273.2	85.62	273.2	84.62	250.3	83.19	
	-5.0	-5.6	310.9	87.06	310.9	86.85	308.7	86.24	308.7	85.34	308.7	84.12	265.4	82.54	
	-3.0	-3.7	346.6	87.82	346.6	87.17	344.4	86.23	337.8	85.05	326.0	83.62	280.5	81.89	
	0.0	-0.7	347.4	88.97	347.4	87.60	346.3	86.20	337.8	84.62	326.0	82.86	302.7	80.93	
	3.0	2.2	347.4	90.12	347.4	88.07	346.3	86.16	337.8	84.19	326.0	82.11	303.5	79.99	
	5.0	4.1	347.4	90.87	347.4	88.39	346.3	86.13	337.8	83.90	326.0	81.61	303.5	79.34	
	7.0	6	347.4	91.66	347.4	88.68	346.3	86.13	337.8	83.61	326.0	81.11	303.5	78.70	
	9.0	7.9	347.4	92.52	347.4	89.54	346.3	86.95	337.8	84.41	326.0	81.90	303.5	79.45	
11.0	9.8	347.4	94.35	347.4	91.30	346.3	88.64	337.8	86.06	326.0	83.51	303.5	81.00		
13.0	11.8	347.4	96.15	347.4	93.06	346.3	90.33	337.8	87.71	326.0	85.09	303.5	82.54		
15.0	13.7	347.4	97.94	347.4	94.79	346.3	92.05	337.8	89.36	326.0	86.71	303.5	84.12		
120	-19.8	-20	154.7	67.38	154.7	69.57	153.6	72.91	153.6	76.10	153.6	81.13	153.6	84.62	
	-18.8	-19	162.1	69.06	162.1	71.25	161.0	74.60	161.0	77.76	161.0	82.79	161.0	86.31	
	-16.7	-17	177.6	72.58	177.6	74.74	176.5	78.11	176.5	81.28	176.5	86.31	176.5	85.69	
	-13.7	-15	200.1	77.61	200.1	79.77	199.0	83.11	199.0	86.31	199.0	85.52	199.0	84.80	
	-11.8	-13	211.6	80.78	211.6	82.97	210.1	86.31	210.1	85.80	210.1	85.02	210.1	84.23	
	-9.8	-11	223.4	84.12	223.4	86.31	221.9	85.91	221.9	85.27	221.9	84.51	221.9	83.65	
	-9.5	-10	228.6	84.62	228.6	86.27	227.4	85.84	227.4	85.20	227.4	84.41	227.4	83.54	
	-8.5	-9.1	246.3	86.31	246.3	86.13	244.8	85.63	244.8	84.94	237.4	84.15	237.4	83.26	
	-7.0	-7.6	273.2	86.31	273.2	85.95	271.4	85.30	271.4	84.55	248.8	83.76	248.8	82.82	
	-5.0	-5.6	308.6	86.34	308.6	85.66	306.8	84.91	306.8	84.01	306.8	83.25	263.5	82.22	
	-3.0	-3.7	341.1	86.34	341.1	85.41	327.5	84.48	316.8	83.47	306.8	82.72	278.3	81.64	
	0.0	-0.7	344.5	86.38	341.1	85.02	327.5	83.87	316.8	82.69	306.8	81.93	285.0	80.74	
	3.0	2.2	344.5	86.38	341.1	84.62	327.5	83.26	316.8	81.90	306.8	81.14	285.0	79.85	
	5.0	4.1	344.5	86.42	341.1	84.34	327.5	82.83	316.8	81.39	306.8	80.60	285.0	79.24	
	7.0	6	344.5	86.42	341.1	84.08	327.5	82.43	316.8	80.85	306.8	80.10	285.0	78.66	
	9.0	7.9	344.5	86.85	341.1	84.51	327.5	82.83	316.8	81.25	306.8	80.49	285.0	79.06	
11.0	9.8	344.5	88.14	341.1	85.74	327.5	84.05	316.8	82.44	306.8	81.68	285.0	80.21		
13.0	11.8	344.5	89.40	341.1	86.96	327.5	85.27	316.8	83.62	306.8	82.83	285.0	81.36		
15.0	13.7	344.5	90.62	341.1	88.18	327.5	86.45	316.8	84.77	306.8	83.98	285.0	82.47		
110	-19.8	-20	153.7	69.57	153.7	72.91	152.9	76.10	152.9	81.13	152.9	84.62	152.9	86.31	
	-18.8	-19	161.1	71.25	161.1	74.60	160.3	77.76	160.3	82.79	160.3	86.31	160.3	85.84	
	-16.7	-17	176.9	74.74	176.9	78.11	175.8	81.28	175.8	86.31	175.8	85.45	175.8	84.83	
	-13.7	-15	199.0	79.77	199.0	83.11	197.9	86.31	197.9	85.12	197.9	84.26	197.9	83.40	
	-11.8	-13	210.4	82.97	210.4	86.31	209.0	85.52	209.0	84.37	209.0	83.47	209.0	82.50	
	-9.8	-11	222.3	86.31	222.3	85.48	220.8	84.69	220.8	83.54	220.8	82.68	220.8	81.53	
	-9.5	-10	227.5	86.20	227.5	85.37	226.0	84.58	226.0	83.44	226.0	82.54	226.0	81.39	
	-8.5	-9.1	245.2	85.81	245.2	84.98	243.7	84.16	243.7	83.04	237.4	82.14	237.4	80.92	
	-7.0	-7.6	271.7	85.23	271.7	84.37	269.9	83.54	269.9	82.43	249.0	81.53	249.0	80.20	
	-5.0	-5.6	295.8	84.48	295.8	83.54	293.9	82.72	284.3	81.64	260.8	80.71	256.6	79.24	
	-3.0	-3.7	313.1	83.72	313.1	82.75	293.9	81.89	284.3	80.85	274.7	79.92	256.6	78.30	
	0.0	-0.7	331.2	82.57	313.1	81.53	293.9	80.67	284.3	79.63	274.7	78.70	256.6	76.87	
	3.0	2.2	331.2	81.42	313.1	80.31	293.9	79.45	284.3	78.45	274.7	77.48	256.6	75.43	
	5.0	4.1	331.2	80.64	313.1	79.49	293.9	78.62	284.3	77.66	274.7	76.69	256.6	74.46	
	7.0	6	331.2	79.88	313.1	78.66	293.9	77.80	284.3	76.86	274.7	75.86	256.6	73.53	
	9.0	7.9	331.2	79.81	313.1	78.63	293.9	77.73	284.3	76.80	274.7	75.82	256.6	73.46	
11.0	9.8	331.2	80.53	313.1	79.31	293.9	78.45	284.3	77.48	274.7	76.48	256.6	74.14		
13.0	11.8	331.2	81.21	313.1	79.99	293.9	79.09	284.3	78.13	274.7	77.12	256.6	74.75		
15.0	13.7	331.2	81.86	313.1	80.64	293.9	79.71	284.3	78.74	274.7	77.73	256.6	75.33		

Note

1. TC: Total Capacity(kW), PI : Power Input(kW, Comp. + Outdoor fan motor)
2. Capacity tables show the average value of conditions which may occur.
3. In the range beyond the operation limit of the outdoor unit, continuous operation and performance can not be guaranteed. When selecting the outdoor units, avoid the air temperature range that is not guaranteed continuous operation.

7. Capacity Tables

Combination (%)		Heating Capacity (96HP)												
		Outdoor air temp.		Indoor air temp. °C DB										
		°C DB	°C WB	16		18		20		21		22		24
		TC	PI	TC	PI	TC	PI	TC	PI	TC	PI	TC	PI	
100	-19.8	-20	153.3	72.44	153.3	75.21	152.2	77.55	152.2	82.00	152.2	85.12	152.2	86.31
	-18.8	-19	160.6	73.81	159.5	76.58	159.5	79.23	159.5	83.40	159.5	86.31	159.5	85.52
	-16.7	-17	175.0	76.72	175.0	79.52	175.0	82.75	173.9	86.31	173.9	84.76	173.9	83.83
	-13.7	-15	198.2	80.89	198.2	83.68	197.1	86.31	197.1	84.30	197.1	82.57	197.1	81.42
	-11.8	-13	209.3	83.54	208.2	86.31	208.2	85.16	208.2	83.01	208.2	81.17	208.2	79.88
	-9.8	-11	220.9	86.31	220.9	85.09	219.8	83.90	219.8	81.68	219.8	79.70	219.8	78.27
	-9.5	-10	226.3	86.16	226.3	84.91	225.2	83.72	225.2	81.46	225.2	79.49	225.2	78.05
	-8.5	-9.1	243.7	85.62	243.7	84.30	242.6	83.11	260.3	80.81	251.5	78.73	234.4	77.23
	-7.0	-7.6	274.7	84.80	273.6	83.40	268.8	82.18	260.3	79.81	251.5	77.65	234.4	76.04
	-5.0	-5.6	286.6	83.76	283.9	82.18	268.8	80.96	260.3	78.45	251.5	76.18	234.4	74.42
	-3.0	-3.7	295.0	82.68	286.1	80.96	268.8	79.74	260.3	77.12	251.5	74.71	234.4	72.81
	0.0	-0.7	303.2	81.07	286.1	79.16	268.8	77.91	260.3	75.11	251.5	72.52	234.4	70.41
	3.0	2.2	303.2	79.45	286.1	77.33	268.8	76.04	260.3	73.10	251.5	70.30	234.4	68.00
	5.0	4.1	303.2	78.41	286.1	76.11	268.8	74.82	260.3	71.77	251.5	68.83	234.4	66.39
	7.0	6	303.2	77.33	286.1	74.89	268.8	73.60	260.3	70.41	251.5	67.36	234.4	64.80
	9.0	7.9	303.2	76.26	286.1	73.85	268.8	72.59	260.3	69.44	251.5	66.45	234.4	63.91
	11.0	9.8	303.2	75.90	286.1	73.50	268.8	72.24	260.3	69.11	251.5	66.13	234.4	63.59
13.0	11.8	303.2	75.47	286.1	73.10	268.8	71.81	260.3	68.72	251.5	65.74	234.4	63.23	
15.0	13.7	303.2	74.93	286.1	72.60	268.8	71.34	260.3	68.25	251.5	65.28	234.4	62.80	
90	-19.8	-20	152.5	68.24	152.5	73.27	151.5	76.76	151.5	78.44	151.5	77.33	151.5	75.39
	-18.8	-19	160.6	69.90	159.5	74.92	158.8	78.44	158.8	77.91	158.8	76.79	158.8	74.75
	-16.7	-17	175.0	73.42	175.0	78.44	174.3	77.48	174.3	76.83	174.3	75.61	174.3	73.46
	-13.7	-15	198.2	78.44	198.2	77.19	196.1	76.11	196.1	75.25	196.1	73.96	196.1	71.62
	-11.8	-13	209.3	77.73	208.2	76.40	207.2	75.25	207.2	74.24	207.2	72.91	207.2	70.47
	-9.8	-11	220.9	76.97	220.9	75.54	219.0	74.32	219.0	73.20	219.0	71.80	209.9	69.22
	-9.5	-10	226.3	76.87	226.3	75.43	224.2	74.21	224.2	73.03	224.2	71.62	205.7	69.04
	-8.5	-9.1	243.7	76.50	242.2	75.00	241.5	73.74	238.2	72.52	230.7	71.08	214.2	68.43
	-7.0	-7.6	274.7	75.93	261.4	74.39	245.9	73.06	238.2	71.73	230.7	70.23	214.2	67.50
	-5.0	-5.6	277.7	75.18	261.4	73.53	245.9	72.13	238.2	70.69	230.7	69.11	214.2	66.28
	-3.0	-3.7	277.7	74.42	261.4	72.70	245.9	71.23	238.2	69.62	230.7	68.03	214.2	65.05
	0.0	-0.7	277.7	73.31	261.4	71.44	245.9	69.86	238.2	68.07	230.7	66.35	214.2	63.22
	3.0	2.2	277.7	72.16	261.4	70.19	245.9	68.47	238.2	66.49	230.7	64.69	214.2	61.36
	5.0	4.1	277.7	71.41	261.4	69.33	245.9	67.57	238.2	65.42	230.7	63.58	214.2	60.14
	7.0	6	277.7	70.66	261.4	68.50	245.9	66.67	238.2	64.37	230.7	62.47	214.2	58.91
	9.0	7.9	277.7	69.69	261.4	67.57	245.9	65.74	238.2	63.51	230.7	61.61	214.2	58.09
	11.0	9.8	277.7	68.72	261.4	66.60	245.9	64.84	238.2	62.61	230.7	60.75	214.2	57.30
13.0	11.8	277.7	67.75	261.4	65.67	245.9	63.91	238.2	61.72	230.7	59.89	214.2	56.48	
15.0	13.7	277.7	66.78	261.4	64.73	245.9	63.01	238.2	60.85	230.7	59.03	214.2	55.68	
80	-19.8	-20	151.0	59.34	151.0	64.37	151.0	69.57	151.0	68.50	151.0	66.89	151.0	65.16
	-18.8	-19	158.1	61.03	158.1	69.57	158.1	69.08	158.1	67.96	158.1	66.35	158.1	64.62
	-16.7	-17	174.3	69.57	174.3	68.65	174.3	68.07	174.3	66.88	174.3	65.23	174.3	63.44
	-13.7	-15	205.3	68.39	201.2	67.35	196.1	66.63	196.1	65.27	196.1	63.62	191.3	61.75
	-11.8	-13	221.9	67.64	215.6	66.56	207.2	65.73	207.2	64.30	205.7	62.61	191.3	60.71
	-9.8	-11	229.0	66.85	222.3	65.70	219.0	64.77	213.4	63.22	205.7	61.54	191.3	59.59
	-9.5	-10	230.4	66.71	223.7	65.56	220.1	64.62	213.4	63.08	205.7	61.39	191.3	59.42
	-8.5	-9.1	238.9	66.31	234.4	65.13	220.1	64.15	213.4	62.54	205.7	60.85	191.3	58.84
	-7.0	-7.6	248.5	65.73	234.4	64.48	220.1	63.44	213.4	61.75	205.7	60.06	191.3	58.02
	-5.0	-5.6	248.5	64.94	234.4	63.62	220.1	62.47	213.4	60.71	205.7	58.99	191.3	56.90
	-3.0	-3.7	248.5	64.15	234.4	62.76	220.1	61.50	213.4	59.63	205.7	57.91	191.3	55.79
	0.0	-0.7	248.5	62.97	234.4	61.46	220.1	60.07	213.4	58.05	205.7	56.30	191.3	54.10
	3.0	2.2	248.5	61.79	234.4	60.17	220.1	58.63	213.4	56.47	205.7	54.71	191.3	52.42
	5.0	4.1	248.5	61.00	234.4	59.31	220.1	57.69	213.4	55.40	205.7	53.64	191.3	51.31
	7.0	6	248.5	60.21	234.4	58.45	220.1	56.72	213.4	54.36	205.7	52.56	191.3	50.19
	9.0	7.9	248.5	56.51	234.4	54.86	220.1	53.25	213.4	51.05	205.7	49.37	191.3	47.14
	11.0	9.8	248.5	52.45	234.4	50.94	220.1	49.44	213.4	47.36	205.7	45.81	191.3	43.73
13.0	11.8	248.5	48.97	234.4	47.54	220.1	46.14	213.4	44.23	205.7	42.76	191.3	40.82	
15.0	13.7	248.5	46.10	234.4	44.77	220.1	43.44	213.4	41.61	205.7	40.25	191.3	38.45	

Note
 1. TC: Total Capacity(kW), PI: Power Input(kW, Comp. + Outdoor fan motor)
 2. Capacity tables show the average value of conditions which may occur.
 3. In the range beyond the operation limit of the outdoor unit, continuous operation and performance can not be guaranteed. When selecting the outdoor units, avoid the air temperature range that is not guaranteed continuous operation.

7. Capacity Tables

Combination (%)		Heating Capacity (96HP)												
		Outdoor air temp.		Indoor air temp. °C DB										
		°C DB	°C WB	16		18		20		21		22		24
		TC	PI	TC	PI	TC	PI	TC	PI	TC	PI	TC	PI	
70	-19.8	-20	151.0	62.86	151.0	64.55	151.0	63.43	151.0	61.68	151.0	60.03	151.0	58.19
	-18.8	-19	158.1	64.55	158.1	64.01	158.1	62.89	158.1	61.13	158.1	59.48	158.1	57.59
	-16.7	-17	174.3	63.54	174.3	62.90	174.3	61.71	174.3	59.92	174.3	58.30	163.6	56.36
	-13.7	-15	210.8	62.14	199.0	61.31	187.2	60.06	180.9	58.23	175.4	56.61	163.6	54.57
	-11.8	-13	210.8	61.25	199.0	60.28	187.2	59.02	180.9	57.12	175.4	55.54	163.6	53.46
	-9.8	-11	210.8	60.31	199.0	59.23	187.2	57.91	180.9	56.00	175.4	54.43	163.6	52.27
	-9.5	-10	210.8	60.17	199.0	59.06	187.2	57.73	180.9	55.82	175.4	54.25	163.6	52.09
	-8.5	-9.1	210.8	59.70	199.0	58.55	187.2	57.19	180.9	55.25	175.4	53.71	163.6	51.52
	-7.0	-7.6	210.8	58.99	199.0	57.73	187.2	56.36	180.9	54.39	175.4	52.85	163.6	50.62
	-5.0	-5.6	210.8	58.05	199.0	56.69	187.2	55.25	180.9	53.24	175.4	51.73	163.6	49.44
	-3.0	-3.7	210.8	57.12	199.0	55.61	187.2	54.14	180.9	52.13	175.4	50.62	163.6	48.25
	0.0	-0.7	210.8	55.72	199.0	54.03	187.2	52.49	180.9	50.41	175.4	48.94	163.6	46.46
	3.0	2.2	210.8	54.29	199.0	52.42	187.2	50.84	180.9	48.72	175.4	47.25	163.6	44.70
	5.0	4.1	210.8	53.35	199.0	51.37	187.2	49.73	180.9	47.57	175.4	46.14	163.6	43.51
	7.0	6	210.8	52.42	199.0	50.30	187.2	48.61	180.9	46.42	175.4	45.02	163.6	42.33
	9.0	7.9	210.8	47.32	199.0	45.42	187.2	43.91	180.9	41.93	175.4	40.64	163.6	38.23
	11.0	9.8	210.8	44.06	199.0	42.29	187.2	40.89	180.9	39.03	175.4	37.84	163.6	35.58
	13.0	11.8	210.8	41.22	199.0	39.57	187.2	38.24	180.9	36.51	175.4	35.40	163.6	33.28
15.0	13.7	210.8	38.88	199.0	37.30	187.2	36.05	180.9	34.43	175.4	33.39	163.6	31.38	
60	-19.8	-20	180.9	59.52	171.3	58.41	151.0	56.68	151.0	55.00	149.9	53.31	140.3	51.48
	-18.8	-19	180.9	59.02	171.3	57.87	158.1	56.11	155.1	54.42	149.9	52.77	140.3	50.90
	-16.7	-17	180.9	58.01	171.3	56.68	160.6	54.93	155.1	53.24	149.9	51.59	140.3	49.65
	-13.7	-15	180.9	56.54	171.3	55.03	160.6	53.24	155.1	51.55	149.9	49.90	140.3	47.86
	-11.8	-13	180.9	55.64	171.3	53.96	160.6	52.16	155.1	50.51	149.9	48.82	140.3	46.74
	-9.8	-11	180.9	54.67	171.3	52.88	160.6	51.02	155.1	49.36	149.9	47.71	140.3	45.56
	-9.5	-10	180.9	54.50	171.3	52.70	160.6	50.87	155.1	49.19	149.9	47.53	140.3	45.38
	-8.5	-9.1	180.9	54.03	171.3	52.13	160.6	50.29	155.1	48.64	149.9	46.99	140.3	44.77
	-7.0	-7.6	180.9	53.31	171.3	51.30	160.6	49.44	155.1	47.78	149.9	46.13	140.3	43.90
	-5.0	-5.6	180.9	52.34	171.3	50.19	160.6	48.32	155.1	46.67	149.9	45.02	140.3	42.72
	-3.0	-3.7	180.9	51.34	171.3	49.11	160.6	47.17	155.1	45.52	149.9	43.90	140.3	41.53
	0.0	-0.7	180.9	49.90	171.3	47.43	160.6	45.49	155.1	43.84	149.9	42.22	140.3	39.74
	3.0	2.2	180.9	48.43	171.3	45.77	160.6	43.80	155.1	42.15	149.9	40.53	140.3	37.95
	5.0	4.1	180.9	47.46	171.3	44.66	160.6	42.65	155.1	41.04	149.9	39.39	140.3	36.77
	7.0	6	180.9	46.49	171.3	43.55	160.6	41.51	155.1	39.89	149.9	38.27	140.3	35.58
	9.0	7.9	180.9	41.50	171.3	38.85	160.6	37.05	155.1	35.61	149.9	34.15	140.3	31.77
	11.0	9.8	180.9	38.74	171.3	36.30	160.6	34.58	155.1	33.25	149.9	31.88	140.3	29.66
	13.0	11.8	180.9	36.30	171.3	34.00	160.6	32.42	155.1	31.13	149.9	29.87	140.3	27.79
15.0	13.7	180.9	34.29	171.3	32.13	160.6	30.62	155.1	29.44	149.9	28.22	140.3	26.25	
50	-19.8	-20	151.0	53.31	142.5	51.44	133.7	49.71	129.6	47.93	125.2	46.30	116.7	44.55
	-18.8	-19	151.0	52.73	142.5	50.83	133.7	49.11	129.6	47.35	125.2	45.73	116.7	43.94
	-16.7	-17	151.0	51.48	142.5	49.57	133.7	47.85	129.6	46.13	125.2	44.55	116.7	42.75
	-13.7	-15	151.0	49.72	142.5	47.74	133.7	46.09	129.6	44.33	125.2	42.83	116.7	41.00
	-11.8	-13	151.0	48.60	142.5	46.56	133.7	44.98	129.6	43.22	125.2	41.78	116.7	39.92
	-9.8	-11	151.0	47.42	142.5	45.34	133.7	43.79	129.6	42.04	125.2	40.64	116.7	38.77
	-9.5	-10	151.0	47.24	142.5	45.16	133.7	43.61	129.6	41.86	125.2	40.46	116.7	38.59
	-8.5	-9.1	151.0	46.63	142.5	44.55	133.7	43.01	129.6	41.28	125.2	39.92	116.7	38.02
	-7.0	-7.6	151.0	45.77	142.5	43.65	133.7	42.11	129.6	40.39	125.2	39.06	116.7	37.15
	-5.0	-5.6	151.0	44.59	142.5	42.43	133.7	40.93	129.6	39.20	125.2	37.91	116.7	35.97
	-3.0	-3.7	151.0	43.40	142.5	41.21	133.7	39.74	129.6	38.02	125.2	36.80	116.7	34.82
	0.0	-0.7	151.0	41.64	142.5	39.38	133.7	37.98	129.6	36.26	125.2	35.11	116.7	33.10
	3.0	2.2	151.0	39.85	142.5	37.55	133.7	36.19	129.6	34.50	125.2	33.39	116.7	31.37
	5.0	4.1	151.0	38.70	142.5	36.33	133.7	35.01	129.6	33.32	125.2	32.27	116.7	30.20
	7.0	6	151.0	37.52	142.5	35.11	133.7	33.82	129.6	32.13	125.2	31.13	116.7	29.05
	9.0	7.9	151.0	33.86	142.5	31.70	133.7	30.55	129.6	29.01	125.2	28.11	116.7	26.24
	11.0	9.8	151.0	31.70	142.5	29.66	133.7	28.58	129.6	27.14	125.2	26.32	116.7	24.56
	13.0	11.8	151.0	29.76	142.5	27.86	133.7	26.82	129.6	25.49	125.2	24.70	116.7	23.05
15.0	13.7	151.0	28.15	142.5	26.35	133.7	25.38	129.6	24.13	125.2	23.37	116.7	21.80	

Note

1. TC: Total Capacity(kW), PI: Power Input(kW, Comp. + Outdoor fan motor)
2. Capacity tables show the average value of conditions which may occur.
3. In the range beyond the operation limit of the outdoor unit, continuous operation and performance can not be guaranteed. When selecting the outdoor units, avoid the air temperature range that is not guaranteed continuous operation.

7. Capacity Tables

◆ A(C)RUN980LLS5

Combination (%)	Outdoor air temp.		Indoor air temp. °C DB											
	°C DB	°C WB	16		18		20		21		22		24	
			TC	PI	TC	PI	TC	PI	TC	PI	TC	PI	TC	PI
130	-19.8	-20	159.0	67.02	159.0	69.58	157.9	71.84	157.9	75.29	157.9	78.59	157.9	83.78
	-18.8	-19	166.6	68.73	166.6	71.32	165.5	73.58	165.5	77.03	165.5	80.30	165.5	85.49
	-16.7	-17	182.8	72.36	182.8	74.96	181.7	77.19	181.7	80.67	181.7	83.93	181.7	89.12
	-13.7	-15	205.8	77.55	205.8	80.15	204.7	82.38	204.7	85.83	204.7	89.12	204.7	88.12
	-11.8	-13	217.5	80.82	217.5	83.41	216.0	85.67	216.0	89.12	216.0	88.64	216.0	87.49
	-9.8	-11	229.6	84.30	229.6	86.86	228.1	89.12	228.1	88.83	228.1	88.12	228.1	86.83
	-9.5	-10	235.2	84.82	235.2	87.38	233.7	89.12	233.7	88.79	230.0	88.05	230.0	86.75
	-8.5	-9.1	253.3	86.53	253.3	89.12	251.8	89.12	251.8	88.64	236.0	87.79	236.0	86.41
	-7.0	-7.6	280.8	89.12	280.8	89.35	278.9	89.09	278.9	88.42	278.9	87.38	255.6	85.90
	-5.0	-5.6	317.3	89.90	317.3	89.68	315.1	89.05	315.1	88.12	315.1	86.86	271.1	85.23
	-3.0	-3.7	353.9	90.68	353.9	90.01	351.6	89.05	344.9	87.82	332.8	86.34	286.5	84.57
	0.0	-0.7	354.7	91.87	354.7	90.46	353.6	89.01	344.9	87.38	332.8	85.57	309.2	83.57
	3.0	2.2	354.7	93.05	354.7	90.94	353.6	88.97	344.9	86.93	332.8	84.79	309.8	82.60
	5.0	4.1	354.7	93.83	354.7	91.27	353.6	88.94	344.9	86.64	332.8	84.27	309.8	81.93
	7.0	6	354.7	94.64	354.7	91.57	353.6	88.94	344.9	86.34	332.8	83.75	309.8	81.26
	9.0	7.9	354.7	95.54	354.7	92.46	353.6	89.79	344.9	87.16	332.8	84.57	309.8	82.04
11.0	9.8	354.7	97.43	354.7	94.28	353.6	91.53	344.9	88.87	332.8	86.23	309.8	83.64	
13.0	11.8	354.7	99.28	354.7	96.09	353.6	93.28	344.9	90.57	332.8	87.87	309.8	85.23	
15.0	13.7	354.7	101.14	354.7	97.88	353.6	95.05	344.9	92.28	332.8	89.53	309.8	86.86	
120	-19.8	-20	157.9	69.58	157.9	71.84	156.8	75.29	156.8	78.59	156.8	83.78	156.8	87.38
	-18.8	-19	165.5	71.32	165.5	73.58	164.4	77.03	164.4	80.30	164.4	85.49	164.4	89.12
	-16.7	-17	181.4	74.96	181.4	77.19	180.2	80.67	180.2	83.93	180.2	89.12	180.2	88.49
	-13.7	-15	204.3	80.15	204.3	82.38	203.2	85.83	203.2	89.12	203.2	88.31	203.2	87.57
	-11.8	-13	216.0	83.41	216.0	85.67	214.5	89.12	214.5	88.60	214.5	87.79	214.5	86.97
	-9.8	-11	228.1	86.86	228.1	89.12	226.6	88.71	226.6	88.05	226.6	87.27	226.6	86.38
	-9.5	-10	233.4	87.38	233.4	89.09	232.2	88.64	232.2	87.98	232.2	87.16	232.2	86.27
	-8.5	-9.1	251.5	89.12	251.5	88.94	249.9	88.42	249.9	87.71	242.4	86.90	242.4	85.97
	-7.0	-7.6	278.9	89.13	278.9	88.75	277.0	88.09	277.0	87.31	254.1	86.49	254.1	85.52
	-5.0	-5.6	315.1	89.16	315.1	88.46	313.2	87.68	313.2	86.75	313.2	85.97	269.2	84.90
	-3.0	-3.7	348.2	89.16	348.2	88.20	334.3	87.24	323.4	86.20	313.2	85.42	284.3	84.30
	0.0	-0.7	351.7	89.20	348.2	87.79	334.3	86.60	323.4	85.38	313.2	84.60	291.0	83.38
	3.0	2.2	351.7	89.20	348.2	87.38	334.3	85.97	323.4	84.57	313.2	83.79	291.0	82.45
	5.0	4.1	351.7	89.23	348.2	87.09	334.3	85.53	323.4	84.04	313.2	83.23	291.0	81.82
	7.0	6	351.7	89.24	348.2	86.83	334.3	85.12	323.4	83.49	313.2	82.71	291.0	81.23
	9.0	7.9	351.7	89.68	348.2	87.27	334.3	85.53	323.4	83.90	313.2	83.12	291.0	81.63
11.0	9.8	351.7	91.01	348.2	88.53	334.3	86.79	323.4	85.12	313.2	84.34	291.0	82.82	
13.0	11.8	351.7	92.31	348.2	89.79	334.3	88.05	323.4	86.35	313.2	85.53	291.0	84.01	
15.0	13.7	351.7	93.58	348.2	91.05	334.3	89.27	323.4	87.53	313.2	86.72	291.0	85.16	
110	-19.8	-20	156.8	71.84	156.8	75.29	156.0	78.59	156.0	83.78	156.0	87.38	156.0	89.12
	-18.8	-19	164.4	73.58	164.4	77.03	163.6	80.30	163.6	85.49	163.6	89.12	163.6	88.64
	-16.7	-17	180.6	77.19	180.6	80.67	179.4	83.93	179.4	89.12	179.4	88.24	179.4	87.60
	-13.7	-15	203.2	82.38	203.2	85.83	202.1	89.12	202.1	87.90	202.1	87.01	202.1	86.12
	-11.8	-13	214.8	85.67	214.8	89.12	213.4	88.31	213.4	87.12	213.4	86.19	213.4	85.19
	-9.8	-11	226.9	89.12	226.9	88.27	225.4	87.46	225.4	86.27	225.4	85.38	225.4	84.19
	-9.5	-10	232.2	89.01	232.2	88.16	230.7	87.34	230.7	86.16	230.7	85.23	230.7	84.04
	-8.5	-9.1	250.3	88.61	250.3	87.75	248.8	86.90	248.8	85.75	242.3	84.82	242.3	83.56
	-7.0	-7.6	277.4	88.01	277.4	87.12	275.5	86.27	275.5	85.12	254.1	84.19	254.1	82.82
	-5.0	-5.6	301.9	87.23	301.9	86.27	300.0	85.42	290.2	84.30	266.1	83.34	261.9	81.82
	-3.0	-3.7	319.6	86.45	319.6	85.45	300.0	84.57	290.2	83.49	280.4	82.52	261.9	80.85
	0.0	-0.7	338.1	85.26	319.6	84.19	300.0	83.30	290.2	82.23	280.4	81.26	261.9	79.37
	3.0	2.2	338.1	84.08	319.6	82.93	300.0	82.04	290.2	81.00	280.4	80.00	261.9	77.89
	5.0	4.1	338.1	83.27	319.6	82.08	300.0	81.19	290.2	80.19	280.4	79.19	261.9	76.89
	7.0	6	338.1	82.49	319.6	81.23	300.0	80.34	290.2	79.37	280.4	78.34	261.9	75.92
	9.0	7.9	338.1	82.42	319.6	81.19	300.0	80.27	290.2	79.30	280.4	78.30	261.9	75.85
11.0	9.8	338.1	83.16	319.6	81.90	300.0	81.00	290.2	80.00	280.4	78.97	261.9	76.55	
13.0	11.8	338.1	83.86	319.6	82.60	300.0	81.67	290.2	80.67	280.4	79.64	261.9	77.19	
15.0	13.7	338.1	84.53	319.6	83.26	300.0	82.31	290.2	81.31	280.4	80.27	261.9	77.78	

Note

1. TC: Total Capacity(kW), PI : Power Input(kW, Comp. + Outdoor fan motor)
2. Capacity tables show the average value of conditions which may occur.
3. In the range beyond the operation limit of the outdoor unit, continuous operation and performance can not be guaranteed. When selecting the outdoor units, avoid the air temperature range that is not guaranteed continuous operation.

7. Capacity Tables

Combination (%)		Heating Capacity (98HP)												
		Outdoor air temp.		Indoor air temp. °C DB										
		°C DB	°C WB	16		18		20		21		22		24
		TC	PI	TC	PI	TC	PI	TC	PI	TC	PI	TC	PI	
100	-19.8	-20	156.4	74.80	156.4	77.66	155.3	80.08	155.3	84.67	155.3	87.90	155.3	89.12
	-18.8	-19	163.9	76.22	162.8	79.08	162.8	81.82	162.8	86.12	162.8	89.12	162.8	88.30
	-16.7	-17	178.7	79.22	178.7	82.11	178.7	85.45	177.6	89.12	177.6	87.53	177.6	86.56
	-13.7	-15	202.4	83.52	202.4	86.41	201.3	89.12	201.3	87.05	201.3	85.27	201.3	84.08
	-11.8	-13	213.7	86.27	212.6	89.12	212.6	87.93	212.6	85.72	212.6	83.82	212.6	82.49
	-9.8	-11	225.5	89.12	225.5	87.86	224.3	86.64	224.3	84.34	224.3	82.30	224.3	80.82
	-9.5	-10	231.0	88.97	231.0	87.68	229.9	86.46	229.9	84.12	229.9	82.08	229.9	80.59
	-8.5	-9.1	248.8	88.42	248.8	87.05	247.7	85.82	265.7	83.45	256.7	81.30	239.3	79.75
	-7.0	-7.6	280.4	87.57	279.3	86.12	274.4	84.86	265.7	82.41	256.7	80.19	239.3	78.52
	-5.0	-5.6	292.5	86.49	289.8	84.86	274.4	83.60	265.7	81.01	256.7	78.67	239.3	76.85
	-3.0	-3.7	301.1	85.38	292.1	83.60	274.4	82.34	265.7	79.63	256.7	77.15	239.3	75.19
	0.0	-0.7	309.5	83.71	292.1	81.74	274.4	80.45	265.7	77.56	256.7	74.88	239.3	72.70
	3.0	2.2	309.5	82.05	292.1	79.85	274.4	78.52	265.7	75.48	256.7	72.59	239.3	70.22
	5.0	4.1	309.5	80.97	292.1	78.60	274.4	77.26	265.7	74.11	256.7	71.07	239.3	68.55
	7.0	6	309.5	79.85	292.1	77.34	274.4	76.00	265.7	72.70	256.7	69.55	239.3	66.92
	9.0	7.9	309.5	78.74	292.1	76.26	274.4	74.96	265.7	71.70	256.7	68.62	239.3	65.99
	11.0	9.8	309.5	78.37	292.1	75.89	274.4	74.59	265.7	71.36	256.7	68.29	239.3	65.66
13.0	11.8	309.5	77.92	292.1	75.48	274.4	74.15	265.7	70.95	256.7	67.88	239.3	65.28	
15.0	13.7	309.5	77.37	292.1	74.96	274.4	73.66	265.7	70.47	256.7	67.40	239.3	64.84	
90	-19.8	-20	155.7	70.47	155.7	75.66	154.6	79.26	154.6	81.00	154.6	79.85	154.6	77.85
	-18.8	-19	163.9	72.18	162.8	77.37	162.1	81.00	162.1	80.45	162.1	79.29	162.1	77.19
	-16.7	-17	178.7	75.81	178.7	81.00	177.9	80.00	177.9	79.33	177.9	78.08	177.9	75.85
	-13.7	-15	202.4	81.00	202.4	79.70	200.2	78.59	200.2	77.70	200.2	76.37	200.2	73.96
	-11.8	-13	213.7	80.26	212.6	78.89	211.5	77.70	211.5	76.67	211.5	75.29	211.5	72.77
	-9.8	-11	225.5	79.48	225.5	78.00	223.5	76.74	223.5	75.59	223.5	74.14	205.1	71.48
	-9.5	-10	231.0	79.37	231.0	77.89	228.8	76.63	228.8	75.41	228.8	73.96	210.0	71.29
	-8.5	-9.1	248.8	79.00	247.3	77.45	246.5	76.15	243.1	74.89	235.6	73.40	218.6	70.66
	-7.0	-7.6	280.4	78.41	266.8	76.81	251.0	75.44	243.1	74.07	235.6	72.52	218.6	69.70
	-5.0	-5.6	283.4	77.63	266.8	75.93	251.0	74.48	243.1	72.99	235.6	71.37	218.6	68.44
	-3.0	-3.7	283.4	76.85	266.8	75.07	251.0	73.55	243.1	71.89	235.6	70.25	218.6	67.18
	0.0	-0.7	283.4	75.70	266.8	73.77	251.0	72.14	243.1	70.29	235.6	68.51	218.6	65.28
	3.0	2.2	283.4	74.52	266.8	72.47	251.0	70.70	243.1	68.66	235.6	66.80	218.6	63.36
	5.0	4.1	283.4	73.74	266.8	71.59	251.0	69.77	243.1	67.55	235.6	65.66	218.6	62.10
	7.0	6	283.4	72.96	266.8	70.73	251.0	68.84	243.1	66.47	235.6	64.51	218.6	60.84
	9.0	7.9	283.4	71.96	266.8	69.77	251.0	67.88	243.1	65.58	235.6	63.62	218.6	59.99
	11.0	9.8	283.4	70.96	266.8	68.77	251.0	66.95	243.1	64.66	235.6	62.73	218.6	59.17
13.0	11.8	283.4	69.96	266.8	67.81	251.0	65.99	243.1	63.73	235.6	61.84	218.6	58.32	
15.0	13.7	283.4	68.96	266.8	66.84	251.0	65.06	243.1	62.84	235.6	60.95	218.6	57.50	
80	-19.8	-20	154.1	61.28	154.1	66.47	154.1	71.84	154.1	70.73	154.1	69.07	154.1	67.29
	-18.8	-19	161.4	63.02	161.4	71.84	161.4	71.33	161.4	70.18	161.4	68.51	161.4	66.73
	-16.7	-17	177.9	71.84	177.9	70.88	177.9	70.29	177.9	69.06	177.9	67.36	177.9	65.51
	-13.7	-15	209.6	70.62	205.4	69.55	200.2	68.81	200.2	67.40	200.2	65.69	195.3	63.77
	-11.8	-13	226.6	69.84	220.1	68.73	211.5	67.88	211.5	66.39	210.0	64.65	195.3	62.69
	-9.8	-11	233.7	69.03	226.9	67.84	223.5	66.88	217.9	65.29	210.0	63.54	195.3	61.54
	-9.5	-10	235.2	68.88	228.4	67.69	224.6	66.73	217.9	65.13	210.0	63.39	195.3	61.35
	-8.5	-9.1	243.9	68.47	239.3	67.25	224.6	66.25	217.9	64.58	210.0	62.84	195.3	60.76
	-7.0	-7.6	253.7	67.88	239.3	66.58	224.6	65.50	217.9	63.76	210.0	62.02	195.3	59.91
	-5.0	-5.6	253.7	67.06	239.3	65.69	224.6	64.51	217.9	62.69	210.0	60.91	195.3	58.76
	-3.0	-3.7	253.7	66.25	239.3	64.80	224.6	63.51	217.9	61.58	210.0	59.80	195.3	57.61
	0.0	-0.7	253.7	65.02	239.3	63.47	224.6	62.02	217.9	59.95	210.0	58.13	195.3	55.87
	3.0	2.2	253.7	63.80	239.3	62.13	224.6	60.54	217.9	58.32	210.0	56.50	195.3	54.13
	5.0	4.1	253.7	62.98	239.3	61.24	224.6	59.57	217.9	57.21	210.0	55.39	195.3	52.98
	7.0	6	253.7	62.17	239.3	60.35	224.6	58.57	217.9	56.13	210.0	54.28	195.3	51.83
	9.0	7.9	253.7	58.35	239.3	56.65	224.6	54.98	217.9	52.72	210.0	50.98	195.3	48.68
	11.0	9.8	253.7	54.16	239.3	52.60	224.6	51.05	217.9	48.90	210.0	47.31	195.3	45.16
13.0	11.8	253.7	50.57	239.3	49.09	224.6	47.64	217.9	45.67	210.0	44.16	195.3	42.16	
15.0	13.7	253.7	47.60	239.3	46.23	224.6	44.86	217.9	42.97	210.0	41.56	195.3	39.70	

Note

1. TC: Total Capacity(kW), PI: Power Input(kW, Comp. + Outdoor fan motor)
2. Capacity tables show the average value of conditions which may occur.
3. In the range beyond the operation limit of the outdoor unit, continuous operation and performance can not be guaranteed. When selecting the outdoor units, avoid the air temperature range that is not guaranteed continuous operation.

7. Capacity Tables

Combination (%)		Heating Capacity (98HP)												
		Outdoor air temp.		Indoor air temp. °C DB										
		°C DB	°C WB	16		18		20		21		22		24
		TC	PI	TC	PI	TC	PI	TC	PI	TC	PI	TC	PI	
70	-19.8	-20	154.1	64.91	154.1	66.65	154.1	65.50	154.1	63.69	154.1	61.98	154.1	60.09
	-18.8	-19	161.4	66.65	161.4	66.10	161.4	64.95	161.4	63.13	161.4	61.42	161.4	59.47
	-16.7	-17	177.9	65.62	177.9	64.95	177.9	63.73	177.9	61.87	177.9	60.20	167.0	58.20
	-13.7	-15	215.2	64.17	203.2	63.31	191.1	62.02	184.7	60.13	179.1	58.46	167.0	56.35
	-11.8	-13	215.2	63.24	203.2	62.25	191.1	60.94	184.7	58.98	179.1	57.35	167.0	55.20
	-9.8	-11	215.2	62.28	203.2	61.17	191.1	59.80	184.7	57.83	179.1	56.20	167.0	53.98
	-9.5	-10	215.2	62.13	203.2	60.99	191.1	59.61	184.7	57.65	179.1	56.02	167.0	53.79
	-8.5	-9.1	215.2	61.65	203.2	60.46	191.1	59.06	184.7	57.05	179.1	55.46	167.0	53.20
	-7.0	-7.6	215.2	60.91	203.2	59.61	191.1	58.20	184.7	56.17	179.1	54.57	167.0	52.27
	-5.0	-5.6	215.2	59.95	203.2	58.54	191.1	57.05	184.7	54.98	179.1	53.42	167.0	51.05
	-3.0	-3.7	215.2	58.98	203.2	57.43	191.1	55.91	184.7	53.83	179.1	52.27	167.0	49.82
	0.0	-0.7	215.2	57.53	203.2	55.79	191.1	54.20	184.7	52.05	179.1	50.53	167.0	47.97
	3.0	2.2	215.2	56.06	203.2	54.13	191.1	52.49	184.7	50.30	179.1	48.79	167.0	46.16
	5.0	4.1	215.2	55.09	203.2	53.05	191.1	51.35	184.7	49.12	179.1	47.64	167.0	44.93
	7.0	6	215.2	54.13	203.2	51.94	191.1	50.20	184.7	47.94	179.1	46.49	167.0	43.71
	9.0	7.9	215.2	48.86	203.2	46.90	191.1	45.34	184.7	43.30	179.1	41.97	167.0	39.48
	11.0	9.8	215.2	45.49	203.2	43.67	191.1	42.22	184.7	40.30	179.1	39.08	167.0	36.74
13.0	11.8	215.2	42.56	203.2	40.86	191.1	39.49	184.7	37.70	179.1	36.56	167.0	34.37	
15.0	13.7	215.2	40.15	203.2	38.52	191.1	37.22	184.7	35.55	179.1	34.48	167.0	32.40	
60	-19.8	-20	184.7	61.46	174.9	60.31	154.1	58.54	154.1	56.79	153.0	55.05	143.2	53.16
	-18.8	-19	184.7	60.95	174.9	59.75	161.4	57.94	158.3	56.20	153.0	54.49	143.2	52.56
	-16.7	-17	184.7	59.91	174.9	58.54	163.9	56.72	158.3	54.98	153.0	53.27	143.2	51.27
	-13.7	-15	184.7	58.39	174.9	56.83	163.9	54.98	158.3	53.24	153.0	51.53	143.2	49.42
	-11.8	-13	184.7	57.46	174.9	55.72	163.9	53.86	158.3	52.16	153.0	50.42	143.2	48.27
	-9.8	-11	184.7	56.46	174.9	54.60	163.9	52.68	158.3	50.97	153.0	49.27	143.2	47.04
	-9.5	-10	184.7	56.28	174.9	54.42	163.9	52.53	158.3	50.79	153.0	49.08	143.2	46.86
	-8.5	-9.1	184.7	55.79	174.9	53.83	163.9	51.94	158.3	50.23	153.0	48.52	143.2	46.23
	-7.0	-7.6	184.7	55.05	174.9	52.98	163.9	51.05	158.3	49.34	153.0	47.64	143.2	45.34
	-5.0	-5.6	184.7	54.05	174.9	51.83	163.9	49.90	158.3	48.19	153.0	46.49	143.2	44.11
	-3.0	-3.7	184.7	53.02	174.9	50.71	163.9	48.71	158.3	47.01	153.0	45.34	143.2	42.89
	0.0	-0.7	184.7	51.53	174.9	48.97	163.9	46.97	158.3	45.27	153.0	43.59	143.2	41.04
	3.0	2.2	184.7	50.01	174.9	47.27	163.9	45.23	158.3	43.53	153.0	41.85	143.2	39.19
	5.0	4.1	184.7	49.01	174.9	46.12	163.9	44.04	158.3	42.37	153.0	40.67	143.2	37.97
	7.0	6	184.7	48.01	174.9	44.97	163.9	42.86	158.3	41.19	153.0	39.52	143.2	36.74
	9.0	7.9	184.7	42.85	174.9	40.12	163.9	38.26	158.3	36.77	153.0	35.26	143.2	32.81
	11.0	9.8	184.7	40.00	174.9	37.48	163.9	35.70	158.3	34.33	153.0	32.92	143.2	30.62
13.0	11.8	184.7	37.48	174.9	35.11	163.9	33.47	158.3	32.15	153.0	30.85	143.2	28.69	
15.0	13.7	184.7	35.41	174.9	33.18	163.9	31.62	158.3	30.40	153.0	29.14	143.2	27.10	
50	-19.8	-20	154.1	55.05	145.5	53.12	136.5	51.34	132.3	49.49	127.8	47.82	119.1	46.00
	-18.8	-19	154.1	54.45	145.5	52.49	136.5	50.71	132.3	48.90	127.8	47.23	119.1	45.38
	-16.7	-17	154.1	53.16	145.5	51.19	136.5	49.42	132.3	47.63	127.8	46.00	119.1	44.15
	-13.7	-15	154.1	51.34	145.5	49.30	136.5	47.60	132.3	45.78	127.8	44.23	119.1	42.34
	-11.8	-13	154.1	50.19	145.5	48.08	136.5	46.45	132.3	44.63	127.8	43.15	119.1	41.22
	-9.8	-11	154.1	48.97	145.5	46.82	136.5	45.22	132.3	43.41	127.8	41.96	119.1	40.03
	-9.5	-10	154.1	48.78	145.5	46.64	136.5	45.04	132.3	43.23	127.8	41.78	119.1	39.85
	-8.5	-9.1	154.1	48.16	145.5	46.01	136.5	44.41	132.3	42.63	127.8	41.22	119.1	39.26
	-7.0	-7.6	154.1	47.26	145.5	45.08	136.5	43.49	132.3	41.71	127.8	40.33	119.1	38.37
	-5.0	-5.6	154.1	46.04	145.5	43.82	136.5	42.26	132.3	40.48	127.8	39.15	119.1	37.15
	-3.0	-3.7	154.1	44.82	145.5	42.56	136.5	41.04	132.3	39.26	127.8	38.00	119.1	35.96
	0.0	-0.7	154.1	43.00	145.5	40.67	136.5	39.22	132.3	37.44	127.8	36.25	119.1	34.18
	3.0	2.2	154.1	41.15	145.5	38.78	136.5	37.37	132.3	35.62	127.8	34.48	119.1	32.40
	5.0	4.1	154.1	39.96	145.5	37.52	136.5	36.15	132.3	34.40	127.8	33.33	119.1	31.18
	7.0	6	154.1	38.74	145.5	36.26	136.5	34.92	132.3	33.18	127.8	32.14	119.1	29.99
	9.0	7.9	154.1	34.96	145.5	32.74	136.5	31.55	132.3	29.96	127.8	29.03	119.1	27.10
	11.0	9.8	154.1	32.73	145.5	30.63	136.5	29.51	132.3	28.03	127.8	27.17	119.1	25.36
13.0	11.8	154.1	30.73	145.5	28.77	136.5	27.70	132.3	26.32	127.8	25.51	119.1	23.80	
15.0	13.7	154.1	29.07	145.5	27.21	136.5	26.21	132.3	24.91	127.8	24.14	119.1	22.51	

Note
 1. TC: Total Capacity(kW), PI: Power Input(kW, Comp. + Outdoor fan motor)
 2. Capacity tables show the average value of conditions which may occur.
 3. In the range beyond the operation limit of the outdoor unit, continuous operation and performance can not be guaranteed. When selecting the outdoor units, avoid the air temperature range that is not guaranteed continuous operation.

7. Capacity Tables

◆ A(C)RUN1000LLS5

Combination (%)	Outdoor air temp.		Indoor air temp. °C DB											
	°C DB	°C WB	16		18		20		21		22		24	
			TC	PI	TC	PI	TC	PI	TC	PI	TC	PI	TC	PI
130	-19.8	-20	162.2	69.92	162.2	72.60	161.1	74.95	161.1	78.56	161.1	82.00	161.1	87.42
	-18.8	-19	170.0	71.70	170.0	74.41	168.8	76.77	168.8	80.37	168.8	83.78	168.8	89.20
	-16.7	-17	186.5	75.50	186.5	78.21	185.4	80.53	185.4	84.16	185.4	87.58	185.4	92.99
	-13.7	-15	210.0	80.91	210.0	83.62	208.8	85.95	208.8	89.55	208.8	92.99	208.8	91.95
	-11.8	-13	221.9	84.33	221.9	87.03	220.4	89.39	220.4	92.99	220.4	92.49	220.4	91.29
	-9.8	-11	234.3	87.96	234.3	90.64	232.7	92.99	232.7	92.68	232.7	91.95	232.7	90.60
	-9.5	-10	240.0	88.50	240.0	91.18	238.5	92.99	238.5	92.64	234.7	91.87	234.7	90.51
	-8.5	-9.1	258.5	90.29	258.5	92.99	256.9	92.99	256.9	92.49	240.8	91.60	240.8	90.17
	-7.0	-7.6	286.5	92.99	286.5	93.23	284.6	92.96	284.6	92.26	284.6	91.18	260.8	89.63
	-5.0	-5.6	323.8	93.81	323.8	93.57	321.6	92.92	321.6	91.95	321.6	90.64	276.6	88.93
	-3.0	-3.7	361.1	94.62	361.1	93.92	358.8	92.91	351.9	91.64	339.6	90.10	292.3	88.24
	0.0	-0.7	361.9	95.86	361.9	94.39	360.8	92.88	351.9	91.17	339.6	89.28	315.5	87.19
	3.0	2.2	361.9	97.10	361.9	94.89	360.8	92.84	351.9	90.71	339.6	88.47	316.1	86.18
	5.0	4.1	361.9	97.91	361.9	95.23	360.8	92.80	351.9	90.40	339.6	87.93	316.1	85.49
	7.0	6	361.9	98.75	361.9	95.55	360.8	92.80	351.9	90.09	339.6	87.39	316.1	84.79
	9.0	7.9	361.9	99.69	361.9	96.48	360.8	93.69	351.9	90.95	339.6	88.24	316.1	85.61
	11.0	9.8	361.9	101.66	361.9	98.37	360.8	95.51	351.9	92.72	339.6	89.98	316.1	87.27
13.0	11.8	361.9	103.59	361.9	100.26	360.8	97.33	351.9	94.50	339.6	91.68	316.1	88.94	
15.0	13.7	361.9	105.53	361.9	102.13	360.8	99.18	351.9	96.28	339.6	93.42	316.1	90.63	
120	-19.8	-20	161.1	72.60	161.1	74.95	160.0	78.56	160.0	82.00	160.0	87.42	160.0	91.18
	-18.8	-19	168.8	74.41	168.8	76.77	167.7	80.37	167.7	83.78	167.7	89.20	167.7	92.99
	-16.7	-17	185.0	78.21	185.0	80.53	183.9	84.16	183.9	87.58	183.9	92.99	183.9	92.33
	-13.7	-15	208.5	83.62	208.5	85.95	207.3	89.55	207.3	92.99	207.3	92.14	207.3	91.37
	-11.8	-13	220.4	87.03	220.4	89.39	218.9	92.99	218.9	92.45	218.9	91.60	218.9	90.75
	-9.8	-11	232.7	90.64	232.7	92.99	231.2	92.56	231.2	91.88	231.2	91.06	231.2	90.13
	-9.5	-10	238.1	91.18	238.1	92.95	236.9	92.49	236.9	91.80	236.9	90.95	236.9	90.02
	-8.5	-9.1	256.6	92.99	256.6	92.80	255.0	92.26	255.0	91.52	247.4	90.67	247.4	89.71
	-7.0	-7.6	284.6	93.00	284.6	92.60	282.7	91.91	282.7	91.10	259.2	90.25	259.2	89.24
	-5.0	-5.6	321.5	93.03	321.5	92.30	319.6	91.48	319.6	90.52	319.6	89.70	274.6	88.58
	-3.0	-3.7	355.3	93.03	355.3	92.03	341.2	91.03	330.0	89.94	319.6	89.12	290.0	87.96
	0.0	-0.7	358.9	93.07	355.3	91.60	341.2	90.37	330.0	89.09	319.6	88.27	296.9	87.00
	3.0	2.2	358.9	93.08	355.3	91.17	341.2	89.71	330.0	88.24	319.6	87.42	296.9	86.03
	5.0	4.1	358.9	93.11	355.3	90.87	341.2	89.25	330.0	87.69	319.6	86.85	296.9	85.38
	7.0	6	358.9	93.11	355.3	90.60	341.2	88.82	330.0	87.11	319.6	86.30	296.9	84.75
	9.0	7.9	358.9	93.58	355.3	91.06	341.2	89.24	330.0	87.54	319.6	86.73	296.9	85.18
	11.0	9.8	358.9	94.96	355.3	92.38	341.2	90.56	330.0	88.82	319.6	88.00	296.9	86.42
13.0	11.8	358.9	96.32	355.3	93.69	341.2	91.87	330.0	90.09	319.6	89.24	296.9	87.66	
15.0	13.7	358.9	97.64	355.3	95.00	341.2	93.14	330.0	91.33	319.6	90.48	296.9	88.86	
110	-19.8	-20	160.0	74.95	160.0	78.56	159.2	82.00	159.2	87.42	159.2	91.18	159.2	92.99
	-18.8	-19	167.7	76.77	167.7	80.37	166.9	83.78	166.9	89.20	166.9	92.99	166.9	92.49
	-16.7	-17	184.2	80.53	184.2	84.16	183.0	87.58	183.0	92.99	183.0	92.07	183.0	91.41
	-13.7	-15	207.3	85.95	207.3	89.55	206.1	92.99	206.1	91.71	206.1	90.78	206.1	89.86
	-11.8	-13	219.2	89.39	219.2	92.99	217.7	92.15	217.7	90.90	217.7	89.94	217.7	88.89
	-9.8	-11	231.5	92.99	231.5	92.11	230.0	91.26	230.0	90.02	230.0	89.08	230.0	87.85
	-9.5	-10	236.9	92.88	236.9	91.99	235.4	91.14	235.4	89.90	235.4	88.93	235.4	87.70
	-8.5	-9.1	255.4	92.45	255.4	91.56	253.8	90.68	253.8	89.47	247.3	88.51	247.3	87.19
	-7.0	-7.6	283.0	91.83	283.0	90.90	281.2	90.02	281.2	88.82	259.3	87.85	259.3	86.42
	-5.0	-5.6	308.1	91.02	308.1	90.02	306.2	89.13	296.2	87.96	271.6	86.96	267.3	85.38
	-3.0	-3.7	326.2	90.20	326.2	89.16	306.2	88.24	296.2	87.11	286.2	86.11	267.3	84.36
	0.0	-0.7	345.0	88.97	326.2	87.85	306.2	86.92	296.2	85.80	286.2	84.79	267.3	82.82
	3.0	2.2	345.0	87.73	326.2	86.53	306.2	85.60	296.2	84.52	286.2	83.48	267.3	81.27
	5.0	4.1	345.0	86.88	326.2	85.64	306.2	84.71	296.2	83.67	286.2	82.62	267.3	80.23
	7.0	6	345.0	86.07	326.2	84.76	306.2	83.82	296.2	82.82	286.2	81.74	267.3	79.22
	9.0	7.9	345.0	86.00	326.2	84.72	306.2	83.75	296.2	82.74	286.2	81.70	267.3	79.15
	11.0	9.8	345.0	86.77	326.2	85.45	306.2	84.52	296.2	83.48	286.2	82.40	267.3	79.88
13.0	11.8	345.0	87.50	326.2	86.19	306.2	85.22	296.2	84.18	286.2	83.09	267.3	80.54	
15.0	13.7	345.0	88.20	326.2	86.88	306.2	85.88	296.2	84.84	286.2	83.75	267.3	81.16	

Note

1. TC: Total Capacity(kW), PI : Power Input(kW, Comp. + Outdoor fan motor)
2. Capacity tables show the average value of conditions which may occur.
3. In the range beyond the operation limit of the outdoor unit, continuous operation and performance can not be guaranteed. When selecting the outdoor units, avoid the air temperature range that is not guaranteed continuous operation.

7. Capacity Tables

Combination (%)		Heating Capacity (100HP)												
		Outdoor air temp.		Indoor air temp. °C DB										
		°C DB	°C WB	16		18		20		21		22		24
		TC	PI	TC	PI	TC	PI	TC	PI	TC	PI	TC	PI	
100	-19.8	-20	159.6	78.05	159.6	81.03	158.4	83.55	158.4	88.35	158.4	91.72	158.4	92.99
	-18.8	-19	167.3	79.52	166.1	82.51	166.1	85.37	166.1	89.86	166.1	92.99	166.1	92.14
	-16.7	-17	182.3	82.66	182.3	85.67	182.3	89.16	181.1	92.99	181.1	91.33	181.1	90.32
	-13.7	-15	206.5	87.15	206.5	90.16	205.4	92.99	205.4	90.83	205.4	88.97	205.4	87.73
	-11.8	-13	218.1	90.01	216.9	92.99	216.9	91.75	216.9	89.44	216.9	87.46	216.9	86.07
	-9.8	-11	230.0	92.99	230.0	91.68	228.9	90.41	228.9	88.00	228.9	85.88	228.9	84.33
	-9.5	-10	235.7	92.84	235.7	91.49	234.6	90.21	234.6	87.78	234.6	85.64	234.6	84.09
	-8.5	-9.1	253.9	92.26	253.9	90.83	252.7	89.55	271.1	87.07	262.0	84.84	244.2	83.21
	-7.0	-7.6	286.2	91.37	285.0	89.86	280.0	88.55	271.1	85.99	262.0	83.67	244.2	81.93
	-5.0	-5.6	298.5	90.24	295.7	88.55	280.0	87.23	271.1	84.53	262.0	82.08	244.2	80.19
	-3.0	-3.7	307.3	89.09	298.0	87.23	280.0	85.92	271.1	83.09	262.0	80.50	244.2	78.45
	0.0	-0.7	315.8	87.35	298.0	85.29	280.0	83.94	271.1	80.92	262.0	78.14	244.2	75.86
	3.0	2.2	315.8	85.61	298.0	83.32	280.0	81.93	271.1	78.76	262.0	75.74	244.2	73.27
	5.0	4.1	315.8	84.48	298.0	82.01	280.0	80.62	271.1	77.32	262.0	74.16	244.2	71.53
	7.0	6	315.8	83.32	298.0	80.69	280.0	79.30	271.1	75.86	262.0	72.57	244.2	69.82
	9.0	7.9	315.8	82.16	298.0	79.57	280.0	78.21	271.1	74.81	262.0	71.60	244.2	68.85
	11.0	9.8	315.8	81.77	298.0	79.19	280.0	77.83	271.1	74.46	262.0	71.25	244.2	68.51
13.0	11.8	315.8	81.31	298.0	78.75	280.0	77.37	271.1	74.03	262.0	70.83	244.2	68.12	
15.0	13.7	315.8	80.73	298.0	78.21	280.0	76.86	271.1	73.53	262.0	70.33	244.2	67.65	
90	-19.8	-20	158.8	73.52	158.8	78.94	157.7	82.70	157.7	84.52	157.7	83.32	157.7	81.23
	-18.8	-19	167.3	75.31	166.1	80.73	165.4	84.52	165.4	83.94	165.4	82.74	165.4	80.54
	-16.7	-17	182.3	79.10	182.3	84.52	181.5	83.48	181.5	82.78	181.5	81.47	181.5	79.15
	-13.7	-15	206.5	84.52	206.5	83.17	204.3	82.01	204.3	81.08	204.3	79.68	204.3	77.17
	-11.8	-13	218.1	83.75	216.9	82.31	215.8	81.08	215.8	80.00	215.8	78.56	215.8	75.93
	-9.8	-11	230.0	82.94	230.0	81.39	228.1	80.08	228.1	78.87	228.1	77.36	209.3	74.58
	-9.5	-10	235.7	82.82	235.7	81.27	233.5	79.95	233.5	78.68	233.5	77.17	214.3	74.39
	-8.5	-9.1	253.9	82.43	252.3	80.81	251.6	79.45	248.1	78.14	240.4	76.59	223.1	73.73
	-7.0	-7.6	286.2	81.81	272.3	80.15	256.2	78.72	248.1	77.29	240.4	75.67	223.1	72.73
	-5.0	-5.6	289.2	81.00	272.3	79.22	256.2	77.72	248.1	76.16	240.4	74.47	223.1	71.41
	-3.0	-3.7	289.2	80.19	272.3	78.33	256.2	76.75	248.1	75.01	240.4	73.30	223.1	70.09
	0.0	-0.7	289.2	78.99	272.3	76.98	256.2	75.27	248.1	73.34	240.4	71.49	223.1	68.12
	3.0	2.2	289.2	77.75	272.3	75.62	256.2	73.77	248.1	71.64	240.4	69.70	223.1	66.11
	5.0	4.1	289.2	76.94	272.3	74.70	256.2	72.80	248.1	70.48	240.4	68.51	223.1	64.79
	7.0	6	289.2	76.13	272.3	73.81	256.2	71.83	248.1	69.36	240.4	67.31	223.1	63.48
	9.0	7.9	289.2	75.09	272.3	72.80	256.2	70.83	248.1	68.43	240.4	66.38	223.1	62.59
	11.0	9.8	289.2	74.04	272.3	71.76	256.2	69.86	248.1	67.46	240.4	65.45	223.1	61.74
13.0	11.8	289.2	73.00	272.3	70.75	256.2	68.86	248.1	66.50	240.4	64.53	223.1	60.85	
15.0	13.7	289.2	71.95	272.3	69.75	256.2	67.89	248.1	65.57	240.4	63.60	223.1	60.00	
80	-19.8	-20	157.3	63.94	157.3	69.35	157.3	74.96	157.3	73.81	157.3	72.07	157.3	70.21
	-18.8	-19	164.6	65.75	164.6	74.96	164.6	74.43	164.6	73.23	164.6	71.49	164.6	69.62
	-16.7	-17	181.5	74.96	181.5	73.96	181.5	73.34	181.5	72.06	181.5	70.29	181.5	68.35
	-13.7	-15	213.8	73.69	209.6	72.57	204.3	71.80	204.3	70.33	204.3	68.55	199.3	66.54
	-11.8	-13	231.2	72.87	224.6	71.71	215.8	70.82	215.8	69.28	214.2	67.46	199.3	65.41
	-9.8	-11	238.5	72.02	231.5	70.78	228.1	69.78	222.3	68.12	214.2	66.30	199.3	64.21
	-9.5	-10	240.0	71.87	233.0	70.63	229.2	69.63	222.3	67.96	214.2	66.15	199.3	64.02
	-8.5	-9.1	248.9	71.45	244.2	70.17	229.2	69.12	222.3	67.38	214.2	65.57	199.3	63.40
	-7.0	-7.6	258.9	70.82	244.2	69.47	229.2	68.35	222.3	66.53	214.2	64.71	199.3	62.51
	-5.0	-5.6	258.9	69.97	244.2	68.54	229.2	67.31	222.3	65.41	214.2	63.55	199.3	61.31
	-3.0	-3.7	258.9	69.12	244.2	67.62	229.2	66.27	222.3	64.25	214.2	62.40	199.3	60.11
	0.0	-0.7	258.9	67.85	244.2	66.22	229.2	64.72	222.3	62.55	214.2	60.66	199.3	58.30
	3.0	2.2	258.9	66.57	244.2	64.83	229.2	63.17	222.3	60.85	214.2	58.95	199.3	56.48
	5.0	4.1	258.9	65.72	244.2	63.90	229.2	62.16	222.3	59.69	214.2	57.79	199.3	55.28
	7.0	6	258.9	64.87	244.2	62.97	229.2	61.12	222.3	58.57	214.2	56.63	199.3	54.08
	9.0	7.9	258.9	60.89	244.2	59.11	229.2	57.37	222.3	55.00	214.2	53.19	199.3	50.79
	11.0	9.8	258.9	56.52	244.2	54.89	229.2	53.26	222.3	51.03	214.2	49.36	199.3	47.12
13.0	11.8	258.9	52.76	244.2	51.22	229.2	49.71	222.3	47.65	214.2	46.07	199.3	43.99	
15.0	13.7	258.9	49.67	244.2	48.23	229.2	46.80	222.3	44.84	214.2	43.37	199.3	41.43	

Note

1. TC: Total Capacity(kW), PI: Power Input(kW, Comp. + Outdoor fan motor)
2. Capacity tables show the average value of conditions which may occur.
3. In the range beyond the operation limit of the outdoor unit, continuous operation and performance can not be guaranteed. When selecting the outdoor units, avoid the air temperature range that is not guaranteed continuous operation.

7. Capacity Tables

Combination (%)		Heating Capacity (100HP)												
		Outdoor air temp.		Indoor air temp. °C DB										
		°C DB	°C WB	16		18		20		21		22		24
		TC	PI	TC	PI	TC	PI	TC	PI	TC	PI	TC	PI	
70	-19.8	-20	157.3	67.73	157.3	69.54	157.3	68.35	157.3	66.46	157.3	64.67	157.3	62.70
	-18.8	-19	164.6	69.54	164.6	68.97	164.6	67.76	164.6	65.87	164.6	64.09	164.6	62.05
	-16.7	-17	181.5	68.47	181.5	67.77	181.5	66.49	181.5	64.56	181.5	62.81	170.4	60.73
	-13.7	-15	219.6	66.95	207.3	66.06	195.0	64.71	188.4	62.74	182.7	61.00	170.4	58.80
	-11.8	-13	219.6	65.99	207.3	64.95	195.0	63.59	188.4	61.54	182.7	59.84	170.4	57.60
	-9.8	-11	219.6	64.98	207.3	63.82	195.0	62.39	188.4	60.34	182.7	58.64	170.4	56.32
	-9.5	-10	219.6	64.83	207.3	63.63	195.0	62.20	188.4	60.15	182.7	58.45	170.4	56.13
	-8.5	-9.1	219.6	64.32	207.3	63.08	195.0	61.62	188.4	59.53	182.7	57.87	170.4	55.50
	-7.0	-7.6	219.6	63.55	207.3	62.20	195.0	60.73	188.4	58.60	182.7	56.94	170.4	54.54
	-5.0	-5.6	219.6	62.55	207.3	61.08	195.0	59.53	188.4	57.37	182.7	55.74	170.4	53.26
	-3.0	-3.7	219.6	61.54	207.3	59.92	195.0	58.33	188.4	56.16	182.7	54.54	170.4	51.99
	0.0	-0.7	219.6	60.03	207.3	58.21	195.0	56.55	188.4	54.31	182.7	52.73	170.4	50.06
	3.0	2.2	219.6	58.49	207.3	56.48	195.0	54.77	188.4	52.49	182.7	50.91	170.4	48.16
	5.0	4.1	219.6	57.48	207.3	55.35	195.0	53.58	188.4	51.25	182.7	49.71	170.4	46.88
	7.0	6	219.6	56.48	207.3	54.20	195.0	52.38	188.4	50.02	182.7	48.51	170.4	45.61
	9.0	7.9	219.6	50.99	207.3	48.94	195.0	47.31	188.4	45.18	182.7	43.79	170.4	41.19
	11.0	9.8	219.6	47.47	207.3	45.57	195.0	44.06	188.4	42.05	182.7	40.77	170.4	38.34
	13.0	11.8	219.6	44.41	207.3	42.63	195.0	41.20	188.4	39.34	182.7	38.15	170.4	35.86
15.0	13.7	219.6	41.89	207.3	40.19	195.0	38.84	188.4	37.10	182.7	35.98	170.4	33.81	
60	-19.8	-20	188.4	64.13	178.4	62.93	157.3	61.07	157.3	59.26	156.1	57.44	146.1	55.47
	-18.8	-19	188.4	63.59	178.4	62.34	164.6	60.46	161.6	58.64	156.1	56.85	146.1	54.84
	-16.7	-17	188.4	62.50	178.4	61.07	167.3	59.18	161.6	57.36	156.1	55.58	146.1	53.49
	-13.7	-15	188.4	60.92	178.4	59.29	167.3	57.36	161.6	55.55	156.1	53.76	146.1	51.56
	-11.8	-13	188.4	59.95	178.4	58.14	167.3	56.20	161.6	54.42	156.1	52.61	146.1	50.36
	-9.8	-11	188.4	58.90	178.4	56.97	167.3	54.97	161.6	53.19	156.1	51.40	146.1	49.08
	-9.5	-10	188.4	58.72	178.4	56.78	167.3	54.81	161.6	52.99	156.1	51.21	146.1	48.89
	-8.5	-9.1	188.4	58.21	178.4	56.17	167.3	54.19	161.6	52.41	156.1	50.63	146.1	48.24
	-7.0	-7.6	188.4	57.44	178.4	55.28	167.3	53.26	161.6	51.48	156.1	49.71	146.1	47.30
	-5.0	-5.6	188.4	56.39	178.4	54.08	167.3	52.06	161.6	50.28	156.1	48.50	146.1	46.03
	-3.0	-3.7	188.4	55.32	178.4	52.91	167.3	50.83	161.6	49.05	156.1	47.30	146.1	44.75
	0.0	-0.7	188.4	53.77	178.4	51.10	167.3	49.01	161.6	47.23	156.1	45.49	146.1	42.82
	3.0	2.2	188.4	52.18	178.4	49.32	167.3	47.19	161.6	45.41	156.1	43.67	146.1	40.89
	5.0	4.1	188.4	51.14	178.4	48.12	167.3	45.95	161.6	44.21	156.1	42.44	146.1	39.61
	7.0	6	188.4	50.09	178.4	46.92	167.3	44.72	161.6	42.98	156.1	41.24	146.1	38.34
	9.0	7.9	188.4	44.71	178.4	41.86	167.3	39.92	161.6	38.37	156.1	36.79	146.1	34.23
	11.0	9.8	188.4	41.74	178.4	39.11	167.3	37.26	161.6	35.82	156.1	34.35	146.1	31.95
	13.0	11.8	188.4	39.11	178.4	36.63	167.3	34.93	161.6	33.54	156.1	32.19	146.1	29.94
15.0	13.7	188.4	36.94	178.4	34.62	167.3	33.00	161.6	31.72	156.1	30.41	146.1	28.28	
50	-19.8	-20	157.3	57.43	148.4	55.42	139.3	53.56	135.0	51.64	130.4	49.89	121.5	47.99
	-18.8	-19	157.3	56.81	148.4	54.77	139.3	52.91	135.0	51.01	130.4	49.27	121.5	47.34
	-16.7	-17	157.3	55.46	148.4	53.41	139.3	51.56	135.0	49.69	130.4	48.00	121.5	46.06
	-13.7	-15	157.3	53.57	148.4	51.44	139.3	49.66	135.0	47.77	130.4	46.15	121.5	44.17
	-11.8	-13	157.3	52.37	148.4	50.17	139.3	48.46	135.0	46.57	130.4	45.02	121.5	43.01
	-9.8	-11	157.3	51.09	148.4	48.85	139.3	47.18	135.0	45.29	130.4	43.78	121.5	41.77
	-9.5	-10	157.3	50.90	148.4	48.66	139.3	46.99	135.0	45.10	130.4	43.59	121.5	41.58
	-8.5	-9.1	157.3	50.25	148.4	48.00	139.3	46.34	135.0	44.48	130.4	43.01	121.5	40.96
	-7.0	-7.6	157.3	49.31	148.4	47.03	139.3	45.37	135.0	43.51	130.4	42.08	121.5	40.03
	-5.0	-5.6	157.3	48.04	148.4	45.72	139.3	44.10	135.0	42.24	130.4	40.85	121.5	38.76
	-3.0	-3.7	157.3	46.76	148.4	44.40	139.3	42.82	135.0	40.96	130.4	39.65	121.5	37.52
	0.0	-0.7	157.3	44.87	148.4	42.43	139.3	40.92	135.0	39.07	130.4	37.83	121.5	35.66
	3.0	2.2	157.3	42.94	148.4	40.46	139.3	38.99	135.0	37.17	130.4	35.98	121.5	33.80
	5.0	4.1	157.3	41.69	148.4	39.15	139.3	37.72	135.0	35.90	130.4	34.77	121.5	32.53
	7.0	6	157.3	40.42	148.4	37.83	139.3	36.44	135.0	34.62	130.4	33.54	121.5	31.30
	9.0	7.9	157.3	36.48	148.4	34.16	139.3	32.92	135.0	31.26	130.4	30.29	121.5	28.27
	11.0	9.8	157.3	34.15	148.4	31.96	139.3	30.79	135.0	29.25	130.4	28.35	121.5	26.46
	13.0	11.8	157.3	32.07	148.4	30.02	139.3	28.90	135.0	27.47	130.4	26.61	121.5	24.83
15.0	13.7	157.3	30.33	148.4	28.40	139.3	27.35	135.0	25.99	130.4	25.18	121.5	23.48	

Note

1. TC: Total Capacity(kW), PI: Power Input(kW, Comp. + Outdoor fan motor)
2. Capacity tables show the average value of conditions which may occur.
3. In the range beyond the operation limit of the outdoor unit, continuous operation and performance can not be guaranteed. When selecting the outdoor units, avoid the air temperature range that is not guaranteed continuous operation.

7. Capacity Tables

◆ A(C)RUN1020LLS5

Combination (%)	Outdoor air temp.		Heating Capacity (102HP)											
			Indoor air temp. °C DB											
	°C DB	°C WB	16		18		20		21		22		24	
		TC	PI	TC	PI	TC	PI	TC	PI	TC	PI	TC	PI	
130	-19.8	-20	165.5	70.01	165.5	72.69	164.3	75.05	164.3	78.66	164.3	82.11	164.3	87.53
	-18.8	-19	173.3	71.80	173.3	74.51	172.2	76.87	172.2	80.48	172.2	83.89	172.2	89.32
	-16.7	-17	190.2	75.60	190.2	78.31	189.0	80.64	189.0	84.28	189.0	87.69	189.0	93.11
	-13.7	-15	214.2	81.02	214.2	83.73	213.0	86.06	213.0	89.67	213.0	93.11	213.0	92.07
	-11.8	-13	226.3	84.44	226.3	87.15	224.8	89.51	224.8	93.11	224.8	92.61	224.8	91.41
	-9.8	-11	238.9	88.07	238.9	90.75	237.3	93.11	237.3	92.80	237.3	92.07	237.3	90.71
	-9.5	-10	244.7	88.61	244.7	91.30	243.1	93.11	243.1	92.76	239.2	91.99	239.2	90.63
	-8.5	-9.1	263.6	90.40	263.6	93.11	262.0	93.11	262.0	92.61	245.5	91.72	245.5	90.28
	-7.0	-7.6	292.3	93.11	292.3	93.35	290.3	93.08	290.3	92.38	290.3	91.29	266.1	89.74
	-5.0	-5.6	330.4	93.93	330.4	93.69	328.1	93.04	328.1	92.07	328.1	90.75	282.2	89.05
	-3.0	-3.7	368.5	94.74	368.5	94.04	366.1	93.03	358.9	91.75	346.4	90.21	298.3	88.35
	0.0	-0.7	369.2	95.98	369.2	94.51	368.0	92.99	358.9	91.29	346.4	89.40	321.9	87.31
	3.0	2.2	369.2	97.22	369.2	95.01	368.0	92.96	358.9	90.82	346.4	88.58	322.5	86.29
	5.0	4.1	369.2	98.03	369.2	95.36	368.0	92.92	358.9	90.51	346.4	88.04	322.5	85.59
	7.0	6	369.2	98.88	369.2	95.67	368.0	92.91	358.9	90.20	346.4	87.50	322.5	84.90
	9.0	7.9	369.2	99.81	369.2	96.60	368.0	93.81	358.9	91.06	346.4	88.35	322.5	85.71
	11.0	9.8	369.2	101.78	369.2	98.49	368.0	95.63	358.9	92.84	346.4	90.09	322.5	87.38
13.0	11.8	369.2	103.72	369.2	100.39	368.0	97.45	358.9	94.62	346.4	91.80	322.5	89.05	
15.0	13.7	369.2	105.66	369.2	102.25	368.0	99.30	358.9	96.40	346.4	93.54	322.5	90.74	
120	-19.8	-20	164.3	72.69	164.3	75.05	163.1	78.66	163.1	82.11	163.1	87.53	163.1	91.30
	-18.8	-19	172.2	74.51	172.2	76.87	171.0	80.48	171.0	83.89	171.0	89.32	171.0	93.11
	-16.7	-17	188.7	78.31	188.7	80.64	187.5	84.28	187.5	87.69	187.5	93.11	187.5	92.45
	-13.7	-15	212.7	83.73	212.7	86.06	211.4	89.67	211.4	93.11	211.4	92.26	211.4	91.49
	-11.8	-13	224.7	87.15	224.7	89.51	223.2	93.11	223.2	92.57	223.2	91.72	223.2	90.87
	-9.8	-11	237.3	90.75	237.3	93.11	235.7	92.68	235.7	91.99	235.7	91.17	235.7	90.24
	-9.5	-10	242.8	91.30	242.8	93.07	241.5	92.61	241.5	91.91	241.5	91.06	241.5	90.13
	-8.5	-9.1	261.7	93.11	261.7	92.92	260.1	92.38	260.1	91.64	252.4	90.79	252.4	89.82
	-7.0	-7.6	290.3	93.12	290.3	92.72	288.3	92.03	288.3	91.21	264.5	90.36	264.5	89.35
	-5.0	-5.6	328.0	93.15	328.0	92.42	326.0	91.60	326.0	90.64	326.0	89.82	280.2	88.70
	-3.0	-3.7	362.4	93.15	362.4	92.14	348.0	91.14	336.6	90.06	326.0	89.24	296.0	88.07
	0.0	-0.7	366.1	93.19	362.4	91.72	348.0	90.48	336.6	89.20	326.0	88.39	302.8	87.11
	3.0	2.2	366.1	93.19	362.4	91.29	348.0	89.82	336.6	88.35	326.0	87.53	302.8	86.14
	5.0	4.1	366.1	93.23	362.4	90.99	348.0	89.36	336.6	87.80	326.0	86.96	302.8	85.49
	7.0	6	366.1	93.23	362.4	90.71	348.0	88.93	336.6	87.22	326.0	86.41	302.8	84.86
	9.0	7.9	366.1	93.69	362.4	91.17	348.0	89.36	336.6	87.65	326.0	86.83	302.8	85.29
	11.0	9.8	366.1	95.08	362.4	92.49	348.0	90.67	336.6	88.93	326.0	88.11	302.8	86.53
13.0	11.8	366.1	96.44	362.4	93.81	348.0	91.98	336.6	90.21	326.0	89.35	302.8	87.76	
15.0	13.7	366.1	97.76	362.4	95.12	348.0	93.26	336.6	91.45	326.0	90.59	302.8	88.97	
110	-19.8	-20	163.2	75.05	163.2	78.66	162.3	82.11	162.3	87.53	162.3	91.30	162.3	93.11
	-18.8	-19	171.0	76.87	171.0	80.48	170.2	83.89	170.2	89.32	170.2	93.11	170.2	92.61
	-16.7	-17	187.9	80.64	187.9	84.28	186.7	87.69	186.7	93.11	186.7	92.19	186.7	91.52
	-13.7	-15	211.5	86.06	211.5	89.67	210.3	93.11	210.3	91.83	210.3	90.90	210.3	89.98
	-11.8	-13	223.5	89.51	223.5	93.11	222.0	92.26	222.0	91.02	222.0	90.05	222.0	89.00
	-9.8	-11	236.1	93.11	236.1	92.23	234.5	91.37	234.5	90.13	234.5	89.20	234.5	87.96
	-9.5	-10	241.6	93.00	241.6	92.11	240.0	91.25	240.0	90.01	240.0	89.05	240.0	87.81
	-8.5	-9.1	260.4	92.57	260.4	91.68	258.8	90.79	258.8	89.59	252.1	88.62	252.1	87.30
	-7.0	-7.6	288.7	91.95	288.7	91.02	286.8	90.13	286.8	88.93	264.2	87.96	264.2	86.53
	-5.0	-5.6	314.2	91.14	314.2	90.13	312.3	89.24	302.1	88.08	276.7	87.07	272.6	85.48
	-3.0	-3.7	332.7	90.32	332.7	89.27	312.3	88.35	302.1	87.22	291.9	86.22	272.6	84.47
	0.0	-0.7	351.9	89.08	332.7	87.96	312.3	87.03	302.1	85.91	291.9	84.90	272.6	82.92
	3.0	2.2	351.9	87.84	332.7	86.64	312.3	85.71	302.1	84.63	291.9	83.58	272.6	81.38
	5.0	4.1	351.9	86.99	332.7	85.75	312.3	84.82	302.1	83.77	291.9	82.73	272.6	80.33
	7.0	6	351.9	86.18	332.7	84.87	312.3	83.93	302.1	82.92	291.9	81.84	272.6	79.32
	9.0	7.9	351.9	86.10	332.7	84.82	312.3	83.86	302.1	82.85	291.9	81.80	272.6	79.25
	11.0	9.8	351.9	86.88	332.7	85.56	312.3	84.63	302.1	83.58	291.9	82.50	272.6	79.98
13.0	11.8	351.9	87.61	332.7	86.29	312.3	85.33	302.1	84.28	291.9	83.20	272.6	80.64	
15.0	13.7	351.9	88.31	332.7	86.99	312.3	85.99	302.1	84.94	291.9	83.86	272.6	81.26	

Note

1. TC: Total Capacity(kW), PI : Power Input(kW, Comp. + Outdoor fan motor)
2. Capacity tables show the average value of conditions which may occur.
3. In the range beyond the operation limit of the outdoor unit, continuous operation and performance can not be guaranteed. When selecting the outdoor units, avoid the air temperature range that is not guaranteed continuous operation.

7. Capacity Tables

Combination (%)		Heating Capacity (102HP)												
		Outdoor air temp.		Indoor air temp. °C DB										
		°C DB	°C WB	16		18		20		21		22		24
		TC	PI	TC	PI	TC	PI	TC	PI	TC	PI	TC	PI	
100	-19.8	-20	162.7	78.15	162.7	81.14	161.6	83.66	161.6	88.47	161.6	91.83	161.6	93.11
	-18.8	-19	170.6	79.63	169.4	82.62	169.4	85.48	169.4	89.97	169.4	93.11	169.4	92.26
	-16.7	-17	185.9	82.77	185.9	85.79	185.9	89.28	184.8	93.11	184.8	91.45	184.8	90.44
	-13.7	-15	210.6	87.27	210.6	90.28	209.5	93.11	209.5	90.94	209.5	89.08	209.5	87.84
	-11.8	-13	222.4	90.13	221.2	93.11	221.2	91.87	221.2	89.55	221.2	87.57	221.2	86.18
	-9.8	-11	234.6	93.11	234.6	91.80	233.4	90.52	233.4	88.12	233.4	85.99	233.4	84.44
	-9.5	-10	240.4	92.96	240.4	91.60	239.2	90.33	239.2	87.89	239.2	85.75	239.2	84.20
	-8.5	-9.1	258.9	92.37	258.9	90.95	257.7	89.67	276.5	87.19	267.2	84.94	249.1	83.32
	-7.0	-7.6	291.9	91.49	290.7	89.98	285.6	88.66	276.5	86.10	267.2	83.78	249.1	82.03
	-5.0	-5.6	304.5	90.36	301.6	88.66	285.6	87.34	276.5	84.63	267.2	82.19	249.1	80.29
	-3.0	-3.7	313.4	89.20	304.0	87.34	285.6	86.02	276.5	83.20	267.2	80.60	249.1	78.55
	0.0	-0.7	322.1	87.46	304.0	85.40	285.6	84.05	276.5	81.03	267.2	78.24	249.1	75.96
	3.0	2.2	322.1	85.72	304.0	83.43	285.6	82.04	276.5	78.86	267.2	75.84	249.1	73.36
	5.0	4.1	322.1	84.59	304.0	82.11	285.6	80.72	276.5	77.42	267.2	74.25	249.1	71.62
	7.0	6	322.1	83.43	304.0	80.80	285.6	79.40	276.5	75.95	267.2	72.66	249.1	69.91
	9.0	7.9	322.1	82.27	304.0	79.67	285.6	78.31	276.5	74.91	267.2	71.69	249.1	68.94
	11.0	9.8	322.1	81.88	304.0	79.29	285.6	77.93	276.5	74.56	267.2	71.34	249.1	68.59
	13.0	11.8	322.1	81.41	304.0	78.85	285.6	77.46	276.5	74.13	267.2	70.92	249.1	68.20
15.0	13.7	322.1	80.83	304.0	78.31	285.6	76.96	276.5	73.62	267.2	70.42	249.1	67.74	
90	-19.8	-20	162.0	73.62	162.0	79.05	160.8	82.81	160.8	84.63	160.8	83.43	160.8	81.33
	-18.8	-19	170.6	75.41	169.4	80.83	168.7	84.63	168.7	84.05	168.7	82.85	168.7	80.64
	-16.7	-17	185.9	79.21	185.9	84.63	185.1	83.59	185.1	82.89	185.1	81.57	185.1	79.25
	-13.7	-15	210.6	84.63	210.6	83.27	208.4	82.11	208.4	81.18	208.4	79.79	208.4	77.27
	-11.8	-13	222.4	83.86	221.2	82.42	220.1	81.18	220.1	80.10	220.1	78.66	220.1	76.03
	-9.8	-11	234.6	83.04	234.6	81.50	232.6	80.18	232.6	78.97	232.6	77.46	213.4	74.68
	-9.5	-10	240.4	82.93	240.4	81.38	238.1	80.06	238.1	78.79	238.1	77.27	218.5	74.48
	-8.5	-9.1	258.9	82.54	257.3	80.91	256.6	79.56	253.1	78.24	245.2	76.69	227.6	73.82
	-7.0	-7.6	291.9	81.92	277.7	80.25	261.3	78.82	253.1	77.39	245.2	75.76	227.6	72.82
	-5.0	-5.6	295.0	81.11	277.7	79.33	261.3	77.82	253.1	76.26	245.2	74.56	227.6	71.50
	-3.0	-3.7	295.0	80.29	277.7	78.43	261.3	76.84	253.1	75.11	245.2	73.39	227.6	70.18
	0.0	-0.7	295.0	79.09	277.7	77.07	261.3	75.37	253.1	73.43	245.2	71.58	227.6	68.20
	3.0	2.2	295.0	77.85	277.7	75.72	261.3	73.87	253.1	71.73	245.2	69.79	227.6	66.19
	5.0	4.1	295.0	77.04	277.7	74.79	261.3	72.89	253.1	70.57	245.2	68.59	227.6	64.88
	7.0	6	295.0	76.23	277.7	73.90	261.3	71.92	253.1	69.45	245.2	67.39	227.6	63.56
	9.0	7.9	295.0	75.18	277.7	72.89	261.3	70.92	253.1	68.51	245.2	66.46	227.6	62.67
	11.0	9.8	295.0	74.14	277.7	71.85	261.3	69.95	253.1	67.55	245.2	65.54	227.6	61.81
	13.0	11.8	295.0	73.09	277.7	70.84	261.3	68.94	253.1	66.58	245.2	64.61	227.6	60.93
15.0	13.7	295.0	72.04	277.7	69.83	261.3	67.97	253.1	65.65	245.2	63.68	227.6	60.07	
80	-19.8	-20	160.4	64.02	160.4	69.44	160.4	75.06	160.4	73.90	160.4	72.16	160.4	70.30
	-18.8	-19	167.9	65.84	167.9	75.06	167.9	74.52	167.9	73.32	167.9	71.58	167.9	69.71
	-16.7	-17	185.1	75.06	185.1	74.06	185.1	73.44	185.1	72.15	185.1	70.38	185.1	68.44
	-13.7	-15	218.1	73.78	213.8	72.66	208.4	71.89	208.4	70.42	208.4	68.64	203.3	66.62
	-11.8	-13	235.8	72.97	229.1	71.81	220.1	70.92	220.1	69.37	218.5	67.55	203.3	65.49
	-9.8	-11	243.1	72.12	236.1	70.88	232.6	69.87	226.8	68.21	218.5	66.39	203.3	64.29
	-9.5	-10	244.8	71.97	237.7	70.72	233.8	69.72	226.8	68.05	218.5	66.23	203.3	64.10
	-8.5	-9.1	253.9	71.54	249.1	70.26	233.8	69.21	226.8	67.47	218.5	65.65	203.3	63.48
	-7.0	-7.6	264.1	70.92	249.1	69.56	233.8	68.44	226.8	66.62	218.5	64.80	203.3	62.59
	-5.0	-5.6	264.1	70.06	249.1	68.63	233.8	67.39	226.8	65.49	218.5	63.64	203.3	61.39
	-3.0	-3.7	264.1	69.21	249.1	67.70	233.8	66.35	226.8	64.33	218.5	62.48	203.3	60.19
	0.0	-0.7	264.1	67.93	249.1	66.31	233.8	64.80	226.8	62.63	218.5	60.74	203.3	58.37
	3.0	2.2	264.1	66.65	249.1	64.91	233.8	63.25	226.8	60.92	218.5	59.03	203.3	56.55
	5.0	4.1	264.1	65.80	249.1	63.98	233.8	62.24	226.8	59.77	218.5	57.87	203.3	55.35
	7.0	6	264.1	64.95	249.1	63.05	233.8	61.19	226.8	58.64	218.5	56.71	203.3	54.15
	9.0	7.9	264.1	60.97	249.1	59.19	233.8	57.44	226.8	55.07	218.5	53.26	203.3	50.85
	11.0	9.8	264.1	56.59	249.1	54.96	233.8	53.33	226.8	51.09	218.5	49.42	203.3	47.18
	13.0	11.8	264.1	52.83	249.1	51.28	233.8	49.77	226.8	47.71	218.5	46.13	203.3	44.04
15.0	13.7	264.1	49.73	249.1	48.29	233.8	46.86	226.8	44.89	218.5	43.42	203.3	41.48	

Note

1. TC: Total Capacity(kW), PI: Power Input(kW, Comp. + Outdoor fan motor)
2. Capacity tables show the average value of conditions which may occur.
3. In the range beyond the operation limit of the outdoor unit, continuous operation and performance can not be guaranteed. When selecting the outdoor units, avoid the air temperature range that is not guaranteed continuous operation.

7. Capacity Tables

Combination (%)		Heating Capacity (102HP)												
		Outdoor air temp.		Indoor air temp. °C DB										
		°C DB	°C WB	16		18		20		21		22		24
		TC	PI	TC	PI	TC	PI	TC	PI	TC	PI	TC	PI	
70	-19.8	-20	160.4	67.82	160.4	69.64	160.4	68.44	160.4	66.54	160.4	64.76	160.4	62.78
	-18.8	-19	167.9	69.64	167.9	69.06	167.9	67.85	167.9	65.95	167.9	64.17	167.9	62.13
	-16.7	-17	185.1	68.56	185.1	67.86	185.1	66.58	185.1	64.64	185.1	62.90	173.8	60.81
	-13.7	-15	224.0	67.04	211.5	66.15	198.9	64.80	192.2	62.82	186.4	61.08	173.8	58.87
	-11.8	-13	224.0	66.08	211.5	65.03	198.9	63.67	192.2	61.62	186.4	59.92	173.8	57.67
	-9.8	-11	224.0	65.07	211.5	63.90	198.9	62.47	192.2	60.42	186.4	58.72	173.8	56.39
	-9.5	-10	224.0	64.91	211.5	63.72	198.9	62.28	192.2	60.23	186.4	58.53	173.8	56.20
	-8.5	-9.1	224.0	64.41	211.5	63.17	198.9	61.70	192.2	59.61	186.4	57.94	173.8	55.58
	-7.0	-7.6	224.0	63.64	211.5	62.28	198.9	60.81	192.2	58.68	186.4	57.02	173.8	54.61
	-5.0	-5.6	224.0	62.63	211.5	61.15	198.9	59.61	192.2	57.44	186.4	55.81	173.8	53.33
	-3.0	-3.7	224.0	61.62	211.5	60.00	198.9	58.41	192.2	56.24	186.4	54.61	173.8	52.05
	0.0	-0.7	224.0	60.11	211.5	58.29	198.9	56.63	192.2	54.38	186.4	52.79	173.8	50.12
	3.0	2.2	224.0	58.56	211.5	56.55	198.9	54.84	192.2	52.55	186.4	50.97	173.8	48.22
	5.0	4.1	224.0	57.56	211.5	55.42	198.9	53.64	192.2	51.32	186.4	49.77	173.8	46.94
	7.0	6	224.0	56.55	211.5	54.27	198.9	52.45	192.2	50.08	186.4	48.57	173.8	45.66
	9.0	7.9	224.0	51.05	211.5	49.00	198.9	47.37	192.2	45.24	186.4	43.85	173.8	41.25
	11.0	9.8	224.0	47.53	211.5	45.63	198.9	44.11	192.2	42.10	186.4	40.83	173.8	38.39
	13.0	11.8	224.0	44.47	211.5	42.68	198.9	41.25	192.2	39.39	186.4	38.19	173.8	35.91
15.0	13.7	224.0	41.94	211.5	40.24	198.9	38.89	192.2	37.14	186.4	36.02	173.8	33.85	
60	-19.8	-20	192.2	64.21	182.0	63.01	160.4	61.15	160.4	59.33	159.3	57.52	149.0	55.54
	-18.8	-19	192.2	63.67	182.0	62.43	167.9	60.54	164.8	58.72	159.3	56.93	149.0	54.91
	-16.7	-17	192.2	62.59	182.0	61.15	170.6	59.26	164.8	57.44	159.3	55.65	149.0	53.56
	-13.7	-15	192.2	61.00	182.0	59.37	170.6	57.44	164.8	55.62	159.3	53.83	149.0	51.63
	-11.8	-13	192.2	60.03	182.0	58.21	170.6	56.27	164.8	54.49	159.3	52.67	149.0	50.43
	-9.8	-11	192.2	58.98	182.0	57.05	170.6	55.04	164.8	53.26	159.3	51.47	149.0	49.15
	-9.5	-10	192.2	58.80	182.0	56.85	170.6	54.88	164.8	53.06	159.3	51.28	149.0	48.95
	-8.5	-9.1	192.2	58.29	182.0	56.24	170.6	54.26	164.8	52.48	159.3	50.69	149.0	48.30
	-7.0	-7.6	192.2	57.51	182.0	55.35	170.6	53.33	164.8	51.55	159.3	49.77	149.0	47.36
	-5.0	-5.6	192.2	56.46	182.0	54.15	170.6	52.13	164.8	50.35	159.3	48.57	149.0	46.09
	-3.0	-3.7	192.2	55.39	182.0	52.98	170.6	50.89	164.8	49.11	159.3	47.36	149.0	44.81
	0.0	-0.7	192.2	53.83	182.0	51.16	170.6	49.07	164.8	47.29	159.3	45.54	149.0	42.88
	3.0	2.2	192.2	52.25	182.0	49.38	170.6	47.25	164.8	45.47	159.3	43.73	149.0	40.94
	5.0	4.1	192.2	51.20	182.0	48.18	170.6	46.01	164.8	44.27	159.3	42.49	149.0	39.66
	7.0	6	192.2	50.16	182.0	46.98	170.6	44.78	164.8	43.03	159.3	41.29	149.0	38.39
	9.0	7.9	192.2	44.77	182.0	41.91	170.6	39.97	164.8	38.42	159.3	36.84	149.0	34.27
	11.0	9.8	192.2	41.79	182.0	39.15	170.6	37.30	164.8	35.87	159.3	34.40	149.0	31.99
	13.0	11.8	192.2	39.16	182.0	36.68	170.6	34.97	164.8	33.58	159.3	32.23	149.0	29.98
15.0	13.7	192.2	36.99	182.0	34.66	170.6	33.04	164.8	31.76	159.3	30.45	149.0	28.32	
50	-19.8	-20	160.4	57.51	151.4	55.50	142.0	53.63	137.7	51.71	133.0	49.95	124.0	48.06
	-18.8	-19	160.4	56.89	151.4	54.84	142.0	52.98	137.7	51.08	133.0	49.34	124.0	47.41
	-16.7	-17	160.4	55.54	151.4	53.48	142.0	51.63	137.7	49.76	133.0	48.06	124.0	46.12
	-13.7	-15	160.4	53.64	151.4	51.50	142.0	49.73	137.7	47.83	133.0	46.21	124.0	44.23
	-11.8	-13	160.4	52.43	151.4	50.23	142.0	48.52	137.7	46.63	133.0	45.08	124.0	43.06
	-9.8	-11	160.4	51.16	151.4	48.92	142.0	47.24	137.7	45.35	133.0	43.84	124.0	41.82
	-9.5	-10	160.4	50.97	151.4	48.72	142.0	47.05	137.7	45.16	133.0	43.65	124.0	41.63
	-8.5	-9.1	160.4	50.31	151.4	48.07	142.0	46.40	137.7	44.54	133.0	43.06	124.0	41.01
	-7.0	-7.6	160.4	49.38	151.4	47.09	142.0	45.43	137.7	43.57	133.0	42.14	124.0	40.08
	-5.0	-5.6	160.4	48.10	151.4	45.78	142.0	44.15	137.7	42.29	133.0	40.90	124.0	38.81
	-3.0	-3.7	160.4	46.82	151.4	44.46	142.0	42.88	137.7	41.02	133.0	39.70	124.0	37.57
	0.0	-0.7	160.4	44.92	151.4	42.49	142.0	40.97	137.7	39.12	133.0	37.87	124.0	35.71
	3.0	2.2	160.4	42.99	151.4	40.51	142.0	39.04	137.7	37.22	133.0	36.02	124.0	33.85
	5.0	4.1	160.4	41.75	151.4	39.20	142.0	37.76	137.7	35.94	133.0	34.82	124.0	32.58
	7.0	6	160.4	40.47	151.4	37.88	142.0	36.49	137.7	34.66	133.0	33.58	124.0	31.33
	9.0	7.9	160.4	36.53	151.4	34.20	142.0	32.96	137.7	31.30	133.0	30.33	124.0	28.31
	11.0	9.8	160.4	34.20	151.4	32.00	142.0	30.83	137.7	29.28	133.0	28.39	124.0	26.49
	13.0	11.8	160.4	32.11	151.4	30.06	142.0	28.94	137.7	27.50	133.0	26.65	124.0	24.87
15.0	13.7	160.4	30.37	151.4	28.43	142.0	27.39	137.7	26.03	133.0	25.21	124.0	23.51	

Note

1. TC: Total Capacity(kW), PI: Power Input(kW, Comp. + Outdoor fan motor)
2. Capacity tables show the average value of conditions which may occur.
3. In the range beyond the operation limit of the outdoor unit, continuous operation and performance can not be guaranteed. When selecting the outdoor units, avoid the air temperature range that is not guaranteed continuous operation.

7. Capacity Tables

◆ A(C)RUN1040LLS5

Combination (%)	Outdoor air temp.		Indoor air temp. °C DB											
	°C DB	°C WB	16		18		20		21		22		24	
			TC	PI	TC	PI	TC	PI	TC	PI	TC	PI	TC	PI
130	-19.8	-20	168.8	72.32	168.8	75.08	167.6	77.52	167.6	81.24	167.6	84.80	167.6	90.40
	-18.8	-19	176.8	74.16	176.8	76.96	175.6	79.40	175.6	83.12	175.6	86.64	175.6	92.24
	-16.7	-17	194.0	78.08	194.0	80.88	192.8	83.28	192.8	87.04	192.8	90.56	192.8	96.16
	-13.7	-15	218.4	83.68	218.4	86.48	217.2	88.88	217.2	92.60	217.2	96.16	217.2	95.08
	-11.8	-13	230.8	87.20	230.8	90.00	229.2	92.44	229.2	96.16	229.2	95.64	229.2	94.40
	-9.8	-11	243.6	90.96	243.6	93.72	242.0	96.16	242.0	95.84	242.0	95.08	242.0	93.68
	-9.5	-10	249.6	91.52	249.6	94.28	248.0	96.16	248.0	95.80	244.0	95.00	244.0	93.60
	-8.5	-9.1	268.8	93.36	268.8	96.16	267.2	96.16	267.2	95.64	250.4	94.72	250.4	93.24
	-7.0	-7.6	298.0	96.16	298.0	96.40	296.0	96.12	296.0	95.40	296.0	94.28	271.2	92.68
	-5.0	-5.6	336.8	97.00	336.8	96.76	334.4	96.08	334.4	95.08	334.4	93.72	287.6	91.96
	-3.0	-3.7	375.6	97.84	375.6	97.12	373.2	96.08	366.0	94.76	353.2	93.16	304.0	91.24
	0.0	-0.7	376.4	99.12	376.4	97.60	375.2	96.04	366.0	94.28	353.2	92.32	328.0	90.16
	3.0	2.2	376.4	100.40	376.4	98.12	375.2	96.00	366.0	93.80	353.2	91.48	328.8	89.12
	5.0	4.1	376.4	101.24	376.4	98.48	375.2	95.96	366.0	93.48	353.2	90.92	328.8	88.40
	7.0	6	376.4	102.12	376.4	98.80	375.2	95.96	366.0	93.16	353.2	90.36	328.8	87.68
	9.0	7.9	376.4	103.08	376.4	99.76	375.2	96.88	366.0	94.04	353.2	91.24	328.8	88.52
	11.0	9.8	376.4	105.12	376.4	101.72	375.2	98.76	366.0	95.88	353.2	93.04	328.8	90.24
13.0	11.8	376.4	107.12	376.4	103.68	375.2	100.64	366.0	97.72	353.2	94.80	328.8	91.96	
15.0	13.7	376.4	109.12	376.4	105.60	375.2	102.56	366.0	99.56	353.2	96.60	328.8	93.72	
120	-19.8	-20	167.6	75.08	167.6	77.52	166.4	81.24	166.4	84.80	166.4	90.40	166.4	94.28
	-18.8	-19	175.6	76.96	175.6	79.40	174.4	83.12	174.4	86.64	174.4	92.24	174.4	96.16
	-16.7	-17	192.4	80.88	192.4	83.28	191.2	87.04	191.2	90.56	191.2	96.16	191.2	95.48
	-13.7	-15	216.8	86.48	216.8	88.88	215.6	92.60	215.6	96.16	215.6	95.28	215.6	94.48
	-11.8	-13	229.2	90.00	229.2	92.44	227.6	96.16	227.6	95.60	227.6	94.72	227.6	93.84
	-9.8	-11	242.0	93.72	242.0	96.16	240.4	95.72	240.4	95.00	240.4	94.16	240.4	93.20
	-9.5	-10	247.6	94.28	247.6	96.12	246.4	95.64	246.4	94.92	246.4	94.04	246.4	93.08
	-8.5	-9.1	266.8	96.16	266.8	95.96	265.2	95.40	265.2	94.64	257.2	93.76	257.2	92.76
	-7.0	-7.6	296.0	96.16	296.0	95.76	294.0	95.04	294.0	94.20	269.6	93.32	269.6	92.28
	-5.0	-5.6	334.4	96.20	334.4	95.44	332.4	94.60	332.4	93.60	332.4	92.76	285.6	91.60
	-3.0	-3.7	369.6	96.20	369.6	95.16	354.8	94.12	343.2	93.00	332.4	92.16	301.6	90.96
	0.0	-0.7	373.2	96.24	369.6	94.72	354.8	93.44	343.2	92.12	332.4	91.28	308.8	89.96
	3.0	2.2	373.2	96.24	369.6	94.28	354.8	92.76	343.2	91.24	332.4	90.40	308.8	88.96
	5.0	4.1	373.2	96.28	369.6	93.96	354.8	92.28	343.2	90.68	332.4	89.80	308.8	88.28
	7.0	6	373.2	96.28	369.6	93.68	354.8	91.84	343.2	90.08	332.4	89.24	308.8	87.64
	9.0	7.9	373.2	96.76	369.6	94.16	354.8	92.28	343.2	90.52	332.4	89.68	308.8	88.08
	11.0	9.8	373.2	98.20	369.6	95.52	354.8	93.64	343.2	91.84	332.4	91.00	308.8	89.36
13.0	11.8	373.2	99.60	369.6	96.88	354.8	95.00	343.2	93.16	332.4	92.28	308.8	90.64	
15.0	13.7	373.2	100.96	369.6	98.24	354.8	96.32	343.2	94.44	332.4	93.56	308.8	91.88	
110	-19.8	-20	166.4	77.52	166.4	81.24	165.6	84.80	165.6	90.40	165.6	94.28	165.6	96.16
	-18.8	-19	174.4	79.40	174.4	83.12	173.6	86.64	173.6	92.24	173.6	96.16	173.6	95.64
	-16.7	-17	191.6	83.28	191.6	87.04	190.4	90.56	190.4	96.16	190.4	95.20	190.4	94.52
	-13.7	-15	215.6	88.88	215.6	92.60	214.4	96.16	214.4	94.84	214.4	93.88	214.4	92.92
	-11.8	-13	228.0	92.44	228.0	96.16	226.4	95.28	226.4	94.00	226.4	93.00	226.4	91.92
	-9.8	-11	240.8	96.16	240.8	95.24	239.2	94.36	239.2	93.08	239.2	92.12	239.2	90.84
	-9.5	-10	246.4	96.04	246.4	95.12	244.8	94.24	244.8	92.96	244.8	91.96	244.8	90.68
	-8.5	-9.1	265.6	95.60	265.6	94.68	264.0	93.76	264.0	92.52	257.2	91.52	257.2	90.16
	-7.0	-7.6	294.4	94.96	294.4	94.00	292.4	93.08	292.4	91.84	269.6	90.84	269.6	89.36
	-5.0	-5.6	320.4	94.12	320.4	93.08	318.4	92.16	308.0	90.96	282.4	89.92	278.0	88.28
	-3.0	-3.7	339.2	93.28	339.2	92.20	318.4	91.24	308.0	90.08	297.6	89.04	278.0	87.24
	0.0	-0.7	358.8	92.00	339.2	90.84	318.4	89.88	308.0	88.72	297.6	87.68	278.0	85.64
	3.0	2.2	358.8	90.72	339.2	89.48	318.4	88.52	308.0	87.40	297.6	86.32	278.0	84.04
	5.0	4.1	358.8	89.84	339.2	88.56	318.4	87.60	308.0	86.52	297.6	85.44	278.0	82.96
	7.0	6	358.8	89.00	339.2	87.64	318.4	86.68	308.0	85.64	297.6	84.52	278.0	81.92
	9.0	7.9	358.8	88.92	339.2	87.60	318.4	86.60	308.0	85.56	297.6	84.48	278.0	81.84
	11.0	9.8	358.8	89.72	339.2	88.36	318.4	87.40	308.0	86.32	297.6	85.20	278.0	82.60
13.0	11.8	358.8	90.48	339.2	89.12	318.4	88.12	308.0	87.04	297.6	85.92	278.0	83.28	
15.0	13.7	358.8	91.20	339.2	89.84	318.4	88.80	308.0	87.72	297.6	86.60	278.0	83.92	

Note

1. TC: Total Capacity(kW), PI : Power Input(kW, Comp. + Outdoor fan motor)
2. Capacity tables show the average value of conditions which may occur.
3. In the range beyond the operation limit of the outdoor unit, continuous operation and performance can not be guaranteed. When selecting the outdoor units, avoid the air temperature range that is not guaranteed continuous operation.

7. Capacity Tables

Combination (%)		Heating Capacity (104HP)												
		Outdoor air temp.		Indoor air temp. °C DB										
		°C DB	°C WB	16		18		20		21		22		24
		TC	PI	TC	PI	TC	PI	TC	PI	TC	PI	TC	PI	
100	-19.8	-20	166.0	80.72	166.0	83.80	164.8	86.40	164.8	91.36	164.8	94.84	164.8	96.16
	-18.8	-19	174.0	82.24	172.8	85.32	172.8	88.28	172.8	92.92	172.8	96.16	172.8	95.28
	-16.7	-17	189.6	85.48	189.6	88.60	189.6	92.20	188.4	96.16	188.4	94.44	188.4	93.40
	-13.7	-15	214.8	90.12	214.8	93.24	213.6	96.16	213.6	93.92	213.6	92.00	213.6	90.72
	-11.8	-13	226.8	93.08	225.6	96.16	225.6	94.88	225.6	92.48	225.6	90.44	225.6	89.00
	-9.8	-11	239.2	96.16	239.2	94.80	238.0	93.48	238.0	91.00	238.0	88.80	238.0	87.20
	-9.5	-10	245.2	96.00	245.2	94.60	244.0	93.28	244.0	90.76	244.0	88.56	244.0	86.96
	-8.5	-9.1	264.0	95.40	264.0	93.92	262.8	92.60	282.0	90.04	272.4	87.72	254.0	86.04
	-7.0	-7.6	297.6	94.48	296.4	92.92	291.2	91.56	282.0	88.92	272.4	86.52	254.0	84.72
	-5.0	-5.6	310.4	93.32	307.6	91.56	291.2	90.20	282.0	87.40	272.4	84.88	254.0	82.92
	-3.0	-3.7	319.6	92.12	310.0	90.20	291.2	88.84	282.0	85.92	272.4	83.24	254.0	81.12
	0.0	-0.7	328.4	90.32	310.0	88.20	291.2	86.80	282.0	83.68	272.4	80.80	254.0	78.44
	3.0	2.2	328.4	88.52	310.0	86.16	291.2	84.72	282.0	81.44	272.4	78.32	254.0	75.76
	5.0	4.1	328.4	87.36	310.0	84.80	291.2	83.36	282.0	79.96	272.4	76.68	254.0	73.96
	7.0	6	328.4	86.16	310.0	83.44	291.2	82.00	282.0	78.44	272.4	75.04	254.0	72.20
	9.0	7.9	328.4	84.96	310.0	82.28	291.2	80.88	282.0	77.36	272.4	74.04	254.0	71.20
	11.0	9.8	328.4	84.56	310.0	81.88	291.2	80.48	282.0	77.00	272.4	73.68	254.0	70.84
	13.0	11.8	328.4	84.08	310.0	81.44	291.2	80.00	282.0	76.56	272.4	73.24	254.0	70.44
	15.0	13.7	328.4	83.48	310.0	80.88	291.2	79.48	282.0	76.04	272.4	72.72	254.0	69.96
	90	-19.8	-20	165.2	76.04	165.2	81.64	164.0	85.52	164.0	87.40	164.0	86.16	164.0
-18.8		-19	174.0	77.88	172.8	83.48	172.0	87.40	172.0	86.80	172.0	85.56	172.0	83.28
-16.7		-17	189.6	81.80	189.6	87.40	188.8	86.32	188.8	85.60	188.8	84.24	188.8	81.84
-13.7		-15	214.8	87.40	214.8	86.00	212.4	84.80	212.4	83.84	212.4	82.40	212.4	79.80
-11.8		-13	226.8	86.60	225.6	85.12	224.4	83.84	224.4	82.72	224.4	81.24	224.4	78.52
-9.8		-11	239.2	85.76	239.2	84.16	237.2	82.80	237.2	81.56	237.2	80.00	237.2	77.12
-9.5		-10	245.2	85.64	245.2	84.04	242.8	82.68	242.8	81.36	242.8	79.80	242.8	76.92
-8.5		-9.1	264.0	85.24	262.4	83.56	261.6	82.16	258.0	80.80	250.0	79.20	232.0	76.24
-7.0		-7.6	297.6	84.60	283.2	82.88	266.4	81.40	258.0	79.92	250.0	78.24	232.0	75.20
-5.0		-5.6	300.8	83.76	283.2	81.92	266.4	80.36	258.0	78.76	250.0	77.00	232.0	73.84
-3.0		-3.7	300.8	82.92	283.2	81.00	266.4	79.36	258.0	77.56	250.0	75.80	232.0	72.48
0.0		-0.7	300.8	81.68	283.2	79.60	266.4	77.84	258.0	75.84	250.0	73.92	232.0	70.44
3.0		2.2	300.8	80.40	283.2	78.20	266.4	76.28	258.0	74.08	250.0	72.08	232.0	68.36
5.0		4.1	300.8	79.56	283.2	77.24	266.4	75.28	258.0	72.88	250.0	70.84	232.0	67.00
7.0		6	300.8	78.72	283.2	76.32	266.4	74.28	258.0	71.72	250.0	69.60	232.0	65.64
9.0		7.9	300.8	77.64	283.2	75.28	266.4	73.24	258.0	70.76	250.0	68.64	232.0	64.72
11.0		9.8	300.8	76.56	283.2	74.20	266.4	72.24	258.0	69.76	250.0	67.68	232.0	63.84
13.0		11.8	300.8	75.48	283.2	73.16	266.4	71.20	258.0	68.76	250.0	66.72	232.0	62.92
15.0		13.7	300.8	74.40	283.2	72.12	266.4	70.20	258.0	67.80	250.0	65.76	232.0	62.04
80		-19.8	-20	163.6	66.12	163.6	71.72	163.6	77.52	163.6	76.32	163.6	74.52	163.6
	-18.8	-19	171.2	68.00	171.2	77.52	171.2	76.96	171.2	75.72	171.2	73.92	171.2	72.00
	-16.7	-17	188.8	77.52	188.8	76.48	188.8	75.84	188.8	74.52	188.8	72.68	188.8	70.68
	-13.7	-15	222.4	76.20	218.0	75.04	212.4	74.24	212.4	72.72	212.4	70.88	207.2	68.80
	-11.8	-13	240.4	75.36	233.6	74.16	224.4	73.24	224.4	71.64	222.8	69.76	207.2	67.64
	-9.8	-11	248.0	74.48	240.8	73.20	237.2	72.16	231.2	70.44	222.8	68.56	207.2	66.40
	-9.5	-10	249.6	74.32	242.4	73.04	238.4	72.00	231.2	70.28	222.8	68.40	207.2	66.20
	-8.5	-9.1	258.8	73.88	254.0	72.56	238.4	71.48	231.2	69.68	222.8	67.80	207.2	65.56
	-7.0	-7.6	269.2	73.24	254.0	71.84	238.4	70.68	231.2	68.80	222.8	66.92	207.2	64.64
	-5.0	-5.6	269.2	72.36	254.0	70.88	238.4	69.60	231.2	67.64	222.8	65.72	207.2	63.40
	-3.0	-3.7	269.2	71.48	254.0	69.92	238.4	68.52	231.2	66.44	222.8	64.52	207.2	62.16
	0.0	-0.7	269.2	70.16	254.0	68.48	238.4	66.92	231.2	64.68	222.8	62.72	207.2	60.28
	3.0	2.2	269.2	68.84	254.0	67.04	238.4	65.32	231.2	62.92	222.8	60.96	207.2	58.40
	5.0	4.1	269.2	67.96	254.0	66.08	238.4	64.28	231.2	61.72	222.8	59.76	207.2	57.16
	7.0	6	269.2	67.08	254.0	65.12	238.4	63.20	231.2	60.56	222.8	58.56	207.2	55.92
	9.0	7.9	269.2	62.96	254.0	61.12	238.4	59.32	231.2	56.88	222.8	55.00	207.2	52.52
	11.0	9.8	269.2	58.44	254.0	56.76	238.4	55.08	231.2	52.76	222.8	51.04	207.2	48.72
	13.0	11.8	269.2	54.56	254.0	52.96	238.4	51.40	231.2	49.28	222.8	47.64	207.2	45.48
	15.0	13.7	269.2	51.36	254.0	49.88	238.4	48.40	231.2	46.36	222.8	44.84	207.2	42.84

Note

1. TC: Total Capacity(kW), PI: Power Input(kW, Comp. + Outdoor fan motor)
2. Capacity tables show the average value of conditions which may occur.
3. In the range beyond the operation limit of the outdoor unit, continuous operation and performance can not be guaranteed. When selecting the outdoor units, avoid the air temperature range that is not guaranteed continuous operation.

7. Capacity Tables

Combination (%)		Heating Capacity (104HP)												
		Outdoor air temp.		Indoor air temp. °C DB										
		°C DB	°C WB	16		18		20		21		22		24
		TC	PI	TC	PI	TC	PI	TC	PI	TC	PI	TC	PI	
70	-19.8	-20	163.6	70.04	163.6	71.92	163.6	70.68	163.6	68.72	163.6	66.88	163.6	64.84
	-18.8	-19	171.2	71.92	171.2	71.32	171.2	70.08	171.2	68.12	171.2	66.28	171.2	64.16
	-16.7	-17	188.8	70.80	188.8	70.08	188.8	68.76	188.8	66.76	188.8	64.96	177.2	62.80
	-13.7	-15	228.4	69.24	215.6	68.32	202.8	66.92	196.0	64.88	190.0	63.08	177.2	60.80
	-11.8	-13	228.4	68.24	215.6	67.16	202.8	65.76	196.0	63.64	190.0	61.88	177.2	59.56
	-9.8	-11	228.4	67.20	215.6	66.00	202.8	64.52	196.0	62.40	190.0	60.64	177.2	58.24
	-9.5	-10	228.4	67.04	215.6	65.80	202.8	64.32	196.0	62.20	190.0	60.44	177.2	58.04
	-8.5	-9.1	228.4	66.52	215.6	65.24	202.8	63.72	196.0	61.56	190.0	59.84	177.2	57.40
	-7.0	-7.6	228.4	65.72	215.6	64.32	202.8	62.80	196.0	60.60	190.0	58.88	177.2	56.40
	-5.0	-5.6	228.4	64.68	215.6	63.16	202.8	61.56	196.0	59.32	190.0	57.64	177.2	55.08
	-3.0	-3.7	228.4	63.64	215.6	61.96	202.8	60.32	196.0	58.08	190.0	56.40	177.2	53.76
	0.0	-0.7	228.4	62.08	215.6	60.20	202.8	58.48	196.0	56.16	190.0	54.52	177.2	51.76
	3.0	2.2	228.4	60.48	215.6	58.40	202.8	56.64	196.0	54.28	190.0	52.64	177.2	49.80
	5.0	4.1	228.4	59.44	215.6	57.24	202.8	55.40	196.0	53.00	190.0	51.40	177.2	48.48
	7.0	6	228.4	58.40	215.6	56.04	202.8	54.16	196.0	51.72	190.0	50.16	177.2	47.16
	9.0	7.9	228.4	52.72	215.6	50.60	202.8	48.92	196.0	46.72	190.0	45.28	177.2	42.60
	11.0	9.8	228.4	49.08	215.6	47.12	202.8	45.56	196.0	43.48	190.0	42.16	177.2	39.64
	13.0	11.8	228.4	45.92	215.6	44.08	202.8	42.60	196.0	40.68	190.0	39.44	177.2	37.08
15.0	13.7	228.4	43.32	215.6	41.56	202.8	40.16	196.0	38.36	190.0	37.20	177.2	34.96	
60	-19.8	-20	196.0	66.32	185.6	65.08	163.6	63.16	163.6	61.28	162.4	59.40	152.0	57.36
	-18.8	-19	196.0	65.76	185.6	64.48	171.2	62.52	168.0	60.64	162.4	58.80	152.0	56.72
	-16.7	-17	196.0	64.64	185.6	63.16	174.0	61.20	168.0	59.32	162.4	57.48	152.0	55.32
	-13.7	-15	196.0	63.00	185.6	61.32	174.0	59.32	168.0	57.44	162.4	55.60	152.0	53.32
	-11.8	-13	196.0	62.00	185.6	60.12	174.0	58.12	168.0	56.28	162.4	54.40	152.0	52.08
	-9.8	-11	196.0	60.92	185.6	58.92	174.0	56.84	168.0	55.00	162.4	53.16	152.0	50.76
	-9.5	-10	196.0	60.72	185.6	58.72	174.0	56.68	168.0	54.80	162.4	52.96	152.0	50.56
	-8.5	-9.1	196.0	60.20	185.6	58.08	174.0	56.04	168.0	54.20	162.4	52.36	152.0	49.88
	-7.0	-7.6	196.0	59.40	185.6	57.16	174.0	55.08	168.0	53.24	162.4	51.40	152.0	48.92
	-5.0	-5.6	196.0	58.32	185.6	55.92	174.0	53.84	168.0	52.00	162.4	50.16	152.0	47.60
	-3.0	-3.7	196.0	57.20	185.6	54.72	174.0	52.56	168.0	50.72	162.4	48.92	152.0	46.28
	0.0	-0.7	196.0	55.60	185.6	52.84	174.0	50.68	168.0	48.84	162.4	47.04	152.0	44.28
	3.0	2.2	196.0	53.96	185.6	51.00	174.0	48.80	168.0	46.96	162.4	45.16	152.0	42.28
	5.0	4.1	196.0	52.88	185.6	49.76	174.0	47.52	168.0	45.72	162.4	43.88	152.0	40.96
	7.0	6	196.0	51.80	185.6	48.52	174.0	46.24	168.0	44.44	162.4	42.64	152.0	39.64
	9.0	7.9	196.0	46.24	185.6	43.28	174.0	41.28	168.0	39.68	162.4	38.04	152.0	35.40
	11.0	9.8	196.0	43.16	185.6	40.44	174.0	38.52	168.0	37.04	162.4	35.52	152.0	33.04
	13.0	11.8	196.0	40.44	185.6	37.88	174.0	36.12	168.0	34.68	162.4	33.28	152.0	30.96
15.0	13.7	196.0	38.20	185.6	35.80	174.0	34.12	168.0	32.80	162.4	31.44	152.0	29.24	
50	-19.8	-20	163.6	59.40	154.4	57.32	144.8	55.40	140.4	53.40	135.6	51.60	126.4	49.64
	-18.8	-19	163.6	58.76	154.4	56.64	144.8	54.72	140.4	52.76	135.6	50.96	126.4	48.96
	-16.7	-17	163.6	57.36	154.4	55.24	144.8	53.32	140.4	51.40	135.6	49.64	126.4	47.64
	-13.7	-15	163.6	55.40	154.4	53.20	144.8	51.36	140.4	49.40	135.6	47.72	126.4	45.68
	-11.8	-13	163.6	54.16	154.4	51.88	144.8	50.12	140.4	48.16	135.6	46.56	126.4	44.48
	-9.8	-11	163.6	52.84	154.4	50.52	144.8	48.80	140.4	46.84	135.6	45.28	126.4	43.20
	-9.5	-10	163.6	52.64	154.4	50.32	144.8	48.60	140.4	46.64	135.6	45.08	126.4	43.00
	-8.5	-9.1	163.6	51.96	154.4	49.64	144.8	47.92	140.4	46.00	135.6	44.48	126.4	42.36
	-7.0	-7.6	163.6	51.00	154.4	48.64	144.8	46.92	140.4	45.00	135.6	43.52	126.4	41.40
	-5.0	-5.6	163.6	49.68	154.4	47.28	144.8	45.60	140.4	43.68	135.6	42.24	126.4	40.08
	-3.0	-3.7	163.6	48.36	154.4	45.92	144.8	44.28	140.4	42.36	135.6	41.00	126.4	38.80
	0.0	-0.7	163.6	46.40	154.4	43.88	144.8	42.32	140.4	40.40	135.6	39.12	126.4	36.88
	3.0	2.2	163.6	44.40	154.4	41.84	144.8	40.32	140.4	38.44	135.6	37.20	126.4	34.96
	5.0	4.1	163.6	43.12	154.4	40.48	144.8	39.00	140.4	37.12	135.6	35.96	126.4	33.64
	7.0	6	163.6	41.80	154.4	39.12	144.8	37.68	140.4	35.80	135.6	34.68	126.4	32.36
	9.0	7.9	163.6	37.72	154.4	35.32	144.8	34.04	140.4	32.32	135.6	31.32	126.4	29.24
	11.0	9.8	163.6	35.32	154.4	33.04	144.8	31.84	140.4	30.24	135.6	29.32	126.4	27.36
	13.0	11.8	163.6	33.16	154.4	31.04	144.8	29.88	140.4	28.40	135.6	27.52	126.4	25.68
15.0	13.7	163.6	31.36	154.4	29.36	144.8	28.28	140.4	26.88	135.6	26.04	126.4	24.28	

Note

1. TC: Total Capacity(kW), PI: Power Input(kW, Comp. + Outdoor fan motor)
2. Capacity tables show the average value of conditions which may occur.
3. In the range beyond the operation limit of the outdoor unit, continuous operation and performance can not be guaranteed. When selecting the outdoor units, avoid the air temperature range that is not guaranteed continuous operation.

8. Capacity Correction Factor

8.1 10, 12, 14, 16, 18, 20, 22, 24, 26, 28, 30, 32, 34HP

◆ Rate of change in Cooling capacity

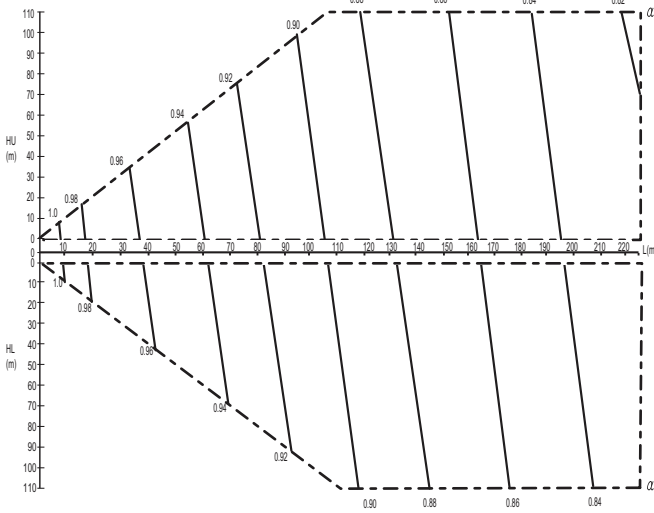

110	-	-	-	-	-	-	-	-	-	0.82	0.88	0.88	0.87	0.86	0.86	0.85	0.84	0.84	0.83	0.83	0.82		
100	-	-	-	-	-	-	-	-	-	0.90	0.89	0.88	0.88	0.87	0.86	0.86	0.85	0.84	0.84	0.83	0.83	0.82	
90	-	-	-	-	-	-	-	-	-	0.91	0.90	0.89	0.88	0.88	0.87	0.86	0.86	0.85	0.84	0.84	0.83	0.82	
80	-	-	-	-	-	-	-	-	-	0.92	0.91	0.90	0.89	0.88	0.88	0.87	0.86	0.86	0.85	0.84	0.84	0.83	0.82
70	-	-	-	-	-	-	-	-	0.92	0.92	0.91	0.90	0.89	0.88	0.87	0.86	0.86	0.85	0.84	0.84	0.83	0.82	
60	-	-	-	-	-	-	-	0.93	0.93	0.93	0.92	0.91	0.90	0.89	0.88	0.87	0.87	0.86	0.85	0.84	0.84	0.83	0.82
50	-	-	-	-	-	-	0.94	0.94	0.93	0.93	0.92	0.91	0.90	0.89	0.88	0.87	0.87	0.86	0.85	0.84	0.84	0.83	0.82
40	-	-	-	-	-	0.95	0.94	0.94	0.93	0.92	0.91	0.90	0.89	0.88	0.87	0.87	0.86	0.85	0.84	0.84	0.83	0.82	
30	-	-	-	0.96	0.95	0.95	0.94	0.93	0.92	0.91	0.90	0.89	0.88	0.87	0.87	0.86	0.85	0.85	0.84	0.84	0.83	0.82	
20	-	-	0.96	0.97	0.96	0.95	0.94	0.93	0.92	0.91	0.90	0.89	0.88	0.87	0.87	0.86	0.85	0.85	0.84	0.84	0.83	0.82	
10	-	0.99	0.98	0.97	0.96	0.95	0.94	0.93	0.92	0.91	0.90	0.89	0.88	0.88	0.87	0.86	0.86	0.85	0.84	0.84	0.83	0.82	
7.5	0.99	0.99	0.98	0.97	0.96	0.95	0.94	0.93	0.92	0.91	0.90	0.89	0.88	0.88	0.87	0.86	0.86	0.85	0.84	0.84	0.83	0.82	
0	1.0	0.99	0.98	0.97	0.96	0.95	0.94	0.93	0.92	0.91	0.91	0.90	0.89	0.88	0.88	0.87	0.86	0.86	0.85	0.84	0.84	0.83	0.82
0	7.5	10	20	30	40	50	60	70	80	90	100	110	120	130	140	150	160	170	180	190	200	210	225
7.5	1.0	0.99	0.98	0.97	0.96	0.95	0.94	0.93	0.92	0.91	0.91	0.90	0.89	0.88	0.88	0.87	0.86	0.86	0.85	0.84	0.84	0.83	0.82
10	-	0.99	0.98	0.97	0.96	0.95	0.94	0.93	0.92	0.91	0.91	0.90	0.89	0.88	0.88	0.87	0.86	0.86	0.85	0.84	0.84	0.83	0.82
20	-	-	0.98	0.97	0.96	0.95	0.94	0.93	0.92	0.91	0.91	0.90	0.89	0.88	0.88	0.87	0.86	0.86	0.85	0.84	0.84	0.83	0.82
30	-	-	-	0.97	0.96	0.95	0.94	0.93	0.92	0.92	0.91	0.90	0.89	0.88	0.88	0.87	0.86	0.86	0.85	0.85	0.84	0.83	0.83
40	-	-	-	-	0.96	0.95	0.94	0.93	0.92	0.92	0.91	0.90	0.89	0.88	0.88	0.87	0.86	0.86	0.85	0.85	0.84	0.83	0.83
50	-	-	-	-	-	0.95	0.94	0.93	0.93	0.92	0.91	0.90	0.89	0.88	0.88	0.87	0.86	0.86	0.85	0.85	0.84	0.83	0.83
60	-	-	-	-	-	-	0.94	0.94	0.93	0.92	0.91	0.90	0.89	0.88	0.88	0.87	0.86	0.86	0.85	0.85	0.84	0.83	0.83
70	-	-	-	-	-	-	-	0.94	0.93	0.92	0.91	0.90	0.89	0.88	0.88	0.87	0.86	0.86	0.85	0.85	0.84	0.83	0.83
80	-	-	-	-	-	-	-	-	0.93	0.92	0.91	0.90	0.89	0.88	0.88	0.87	0.86	0.86	0.85	0.85	0.84	0.83	0.83
90	-	-	-	-	-	-	-	-	-	0.92	0.91	0.90	0.89	0.88	0.88	0.87	0.86	0.86	0.85	0.85	0.84	0.83	0.83
100	-	-	-	-	-	-	-	-	-	-	0.91	0.91	0.90	0.89	0.88	0.88	0.87	0.86	0.86	0.85	0.84	0.83	0.83
110	-	-	-	-	-	-	-	-	-	-	-	0.91	0.90	0.89	0.88	0.88	0.87	0.86	0.86	0.85	0.84	0.83	0.83

◆ Rate of change in Heating capacity

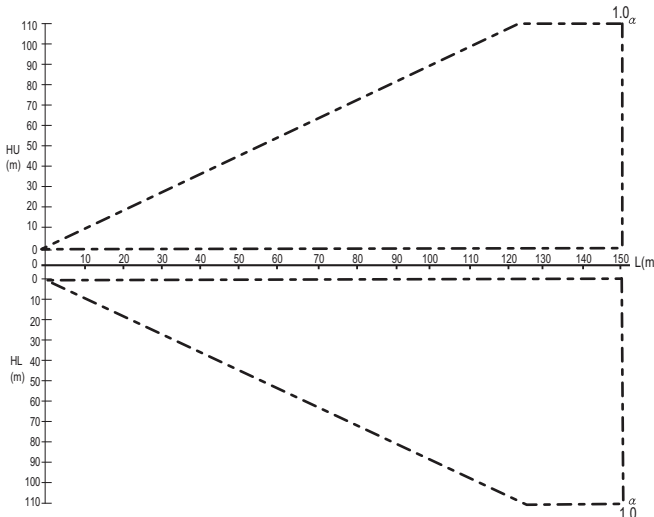

110	-	-	-	-	-	-	-	-	-	-	-	-	-	-	-	1.0	1.0	1.0	1.0	1.0	1.0	1.0	1.0
100	-	-	-	-	-	-	-	-	-	-	-	-	-	-	-	1.0	1.0	1.0	1.0	1.0	1.0	1.0	1.0
90	-	-	-	-	-	-	-	-	-	-	-	-	-	-	1.0	1.0	1.0	1.0	1.0	1.0	1.0	1.0	1.0
80	-	-	-	-	-	-	-	-	-	-	-	-	1.0	1.0	1.0	1.0	1.0	1.0	1.0	1.0	1.0	1.0	1.0
70	-	-	-	-	-	-	-	-	-	-	1.0	1.0	1.0	1.0	1.0	1.0	1.0	1.0	1.0	1.0	1.0	1.0	1.0
60	-	-	-	-	-	-	-	-	-	1.0	1.0	1.0	1.0	1.0	1.0	1.0	1.0	1.0	1.0	1.0	1.0	1.0	1.0
50	-	-	-	-	-	-	-	1.0	1.0	1.0	1.0	1.0	1.0	1.0	1.0	1.0	1.0	1.0	1.0	1.0	1.0	1.0	1.0
40	-	-	-	-	-	1.0	1.0	1.0	1.0	1.0	1.0	1.0	1.0	1.0	1.0	1.0	1.0	1.0	1.0	1.0	1.0	1.0	1.0
30	-	-	-	1.0	1.0	1.0	1.0	1.0	1.0	1.0	1.0	1.0	1.0	1.0	1.0	1.0	1.0	1.0	1.0	1.0	1.0	1.0	1.0
20	-	-	1.0	1.0	1.0	1.0	1.0	1.0	1.0	1.0	1.0	1.0	1.0	1.0	1.0	1.0	1.0	1.0	1.0	1.0	1.0	1.0	1.0
10	-	1.0	1.0	1.0	1.0	1.0	1.0	1.0	1.0	1.0	1.0	1.0	1.0	1.0	1.0	1.0	1.0	1.0	1.0	1.0	1.0	1.0	1.0
7.5	1.0	1.0	1.0	1.0	1.0	1.0	1.0	1.0	1.0	1.0	1.0	1.0	1.0	1.0	1.0	1.0	1.0	1.0	1.0	1.0	1.0	1.0	1.0
0	1.0	1.0	1.0	1.0	1.0	1.0	1.0	1.0	1.0	1.0	1.0	1.0	1.0	1.0	1.0	1.0	1.0	1.0	1.0	1.0	1.0	1.0	1.0
0	7.5	10	20	30	40	50	60	70	80	90	100	110	120	130	140	150							
7.5	1.0	1.0	1.0	1.0	1.0	1.0	1.0	1.0	1.0	1.0	1.0	1.0	1.0	1.0	1.0	1.0	1.0	1.0	1.0	1.0	1.0	1.0	1.0
10	-	1.0	1.0	1.0	1.0	1.0	1.0	1.0	1.0	1.0	1.0	1.0	1.0	1.0	1.0	1.0	1.0	1.0	1.0	1.0	1.0	1.0	1.0
20	-	-	1.0	1.0	1.0	1.0	1.0	1.0	1.0	1.0	1.0	1.0	1.0	1.0	1.0	1.0	1.0	1.0	1.0	1.0	1.0	1.0	1.0
30	-	-	-	1.0	1.0	1.0	1.0	1.0	1.0	1.0	1.0	1.0	1.0	1.0	1.0	1.0	1.0	1.0	1.0	1.0	1.0	1.0	1.0
40	-	-	-	-	1.0	1.0	1.0	1.0	1.0	1.0	1.0	1.0	1.0	1.0	1.0	1.0	1.0	1.0	1.0	1.0	1.0	1.0	1.0
50	-	-	-	-	-	1.0	1.0	1.0	1.0	1.0	1.0	1.0	1.0	1.0	1.0	1.0	1.0	1.0	1.0	1.0	1.0	1.0	1.0
60	-	-	-	-	-	-	1.0	1.0	1.0	1.0	1.0	1.0	1.0	1.0	1.0	1.0	1.0	1.0	1.0	1.0	1.0	1.0	1.0
70	-	-	-	-	-	-	-	1.0	1.0	1.0	1.0	1.0	1.0	1.0	1.0	1.0	1.0	1.0	1.0	1.0	1.0	1.0	1.0
80	-	-	-	-	-	-	-	-	1.0	1.0	1.0	1.0	1.0	1.0	1.0	1.0	1.0	1.0	1.0	1.0	1.0	1.0	1.0
90	-	-	-	-	-	-	-	-	-	1.0	1.0	1.0	1.0	1.0	1.0	1.0	1.0	1.0	1.0	1.0	1.0	1.0	1.0
100	-	-	-	-	-	-	-	-	-	-	1.0	1.0	1.0	1.0	1.0	1.0	1.0	1.0	1.0	1.0	1.0	1.0	1.0
110	-	-	-	-	-	-	-	-	-	-	-	1.0	1.0	1.0	1.0	1.0	1.0	1.0	1.0	1.0	1.0	1.0	1.0

Symbols

- HU : Level difference between indoor and outdoor units where outdoor unit in upper position (m)
- HL : Level difference between indoor and outdoor units where outdoor unit in lower position (m)
- L : Equivalent pipe length (m)
- α : Capacity correction factor

8. Capacity Correction Factor

Note

- These figures illustrate the rate of change in capacity of a standard indoor unit system at maximum load under standard conditions. (Moreover, under partial load conditions there is only a minor deviation from the rate of change in capacity shown in the above figures.)
- With this outdoor unit, constant evaporating pressure control during cooling, and constant condensing pressure control during heating is carried out.
- If heat insulation of piping is insufficient, heat loss will become larger and capacity will decrease.
- Method of calculating cooling / heating capacity : maximum cooling / heating capacity of outside units = cooling / heating capacity of outdoor units obtained from capacity table X capacity correction factor due to piping length to the farthest indoor unit
- Equivalent piping length for Y Branch and other pipes can be calculated with following table.

mm (inch)	Ø6.35 (1/4)	Ø9.52 (3/8)	Ø12.7 (1/2)	Ø15.88 (5/8)	Ø19.05 (3/4)	Ø22.2 (7/8)	Ø25.4 (1)	Ø28.58 (1-1/8)	Ø31.8 (1-1/4)	Ø34.9 (1-3/8)	Ø38.1 (1-1/2)	Ø41.3 (1-5/8)	Ø44.5 (1-3/4)	Ø53.98 (2-1/8)
Elbow (m)	0.16	0.18	0.2	0.25	0.35	0.4	0.45	0.5	0.55	0.6	0.65	0.7	0.75	0.85
Y Branch (m)	0.5													
Header (m)	1													
HR unit (m)	2.5													

- When the any one (or both) of below conditions are satisfied, the diameter of main pipe must be increased.
 - The equivalent length between outdoor unit and the farthest indoor unit is 90m or more (Liquid and Gas pipes are increased)
 - The level difference (Outdoor unit ↔ Indoor unit) is 50m or more (Only liquid pipe is increased)

Refer to the table (Refrigerant pipe diameter from outdoor unit to first branch.) in the 'installation of outdoor units' part.

- Read cooling / heating capacity rate of change in the above figures based on the following equivalent length. : overall equivalent length = (equivalent length of main pipe) X correction factor + (equivalent length after first branching)
 - 10, 12, 14, 16, 18, 20, 22, 24, 26, 28, 30, 32, 34HP**

Rate of change (object piping)	Correction factor	
	standard size	size increase
Cooling(Gas pipe)	1	0.5
Heating(Liquid pipe)	1	0.2

- 36, 38, 40, 42, 44, 46, 48, 50, 52, 54, 56, 58, 60HP**

Rate of change (object piping)	Correction factor	
	standard size	size increase
Cooling(Gas pipe)	1	0.5
Heating(Liquid pipe)	1	0.4

- 62, 64, 66, 68, 70, 72, 74, 76, 78, 80, 82, 84, 86, 88, 90, 92, 94, 96, 98, 100, 102, 104 HP**

Rate of change (object piping)	Correction factor	
	standard size	size increase
Cooling(Gas pipe)	1	-
Heating(Liquid pipe)	1	0.4

8. Capacity Correction Factor

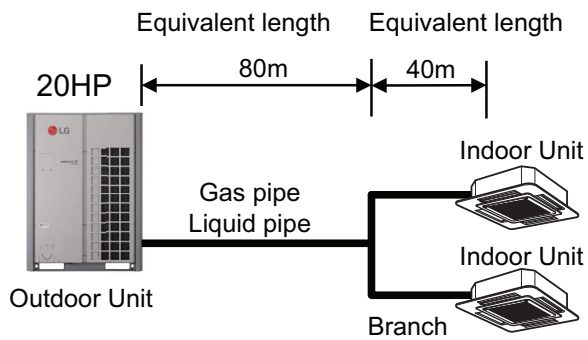

* (Cooling) Overall equivalent length = $80 \text{ m} \times 0.5 + 40 \text{ m} = 80 \text{ m}$

* (Heating) Overall equivalent length = $80 \text{ m} \times 0.2 + 40 \text{ m} = 56 \text{ m}$

The rate of change in
Cooling capacity when $HU=0\text{m}$ is thus approximately 0.92
Heating capacity when $HU=0\text{m}$ is thus approximately 1.00

8. Capacity Correction Factor

8.5 Defrosting Correction Factor for Heating Operation

The capacity table does not consider reduction in capacity when frost has accumulated or during defrosting.

The capacity values considered these factors, in other words the integrated heating capacity values, can be obtained as follows:

[Formula]

- Integrated Heating capacity = A
- Value given in table of capacity characteristics = B
- Integrated correction factor for frost accumulation = C
- $A=B \times C$

[Correction factor for finding integrated Heating capacity]

Inlet Air Temperature of Heat Exchanger (°C, RH 85%)	-7	-5	-3	0	3	5	7
Integrated Correction Factor for Frost Accumulation (Normal Defrost Operation)	0.92	0.90	0.86	0.84	0.85	0.90	1.0
Integrated Correction Factor for Frost Accumulation (Partial Defrost Operation)	0.92	0.90	0.86	0.90	0.93	0.95	1.0
Integrated Correction Factor for Frost Accumulation (Normal Defrost Operation / Dual sensing)	0.92	0.90	0.86	0.86	0.86	0.91	1.0
Integrated Correction Factor for Frost Accumulation (Partial Defrost Operation / Dual sensing)	0.92	0.90	0.86	0.91	0.94	0.95	1.0

◆ Normal Defrost Operation

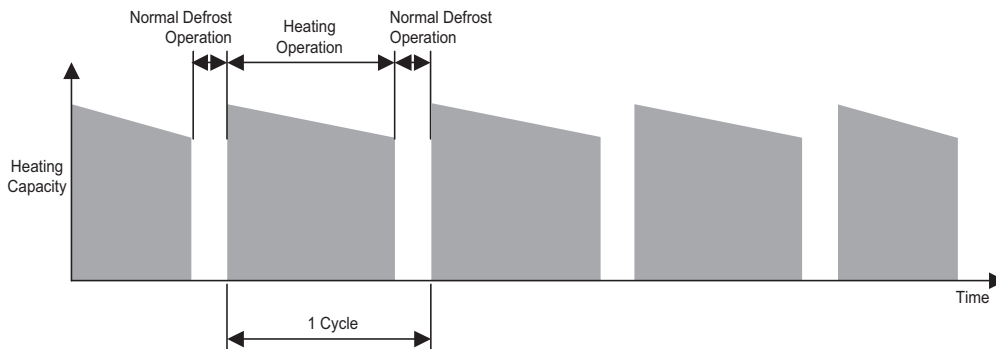

◆ Partial Defrost Operation

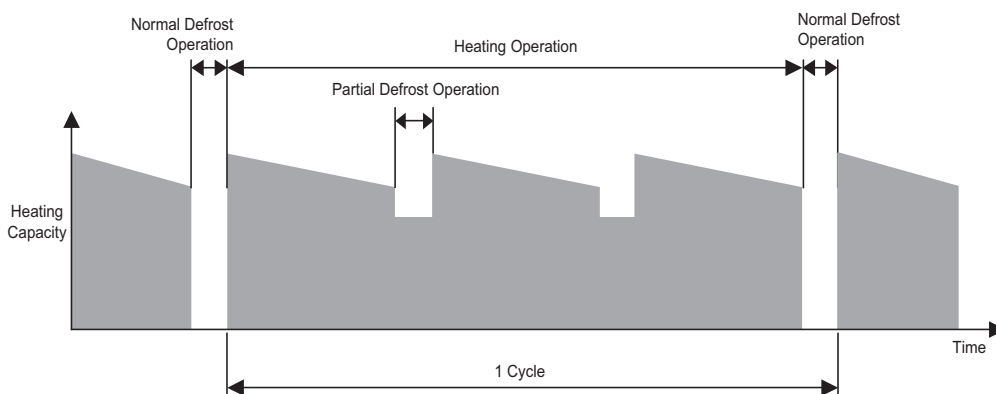

Please note that there will be temporary reduction in capacity when snow piles up on the outside surface of the outdoor unit heat exchanger. Of course, it will be different in degree depending on a number of other factors, for example, the outdoor temperature(°CDB), the relative humidity(RH) and the frosting amount.

9. Operation Limits

■ Cooling / Heating Operation

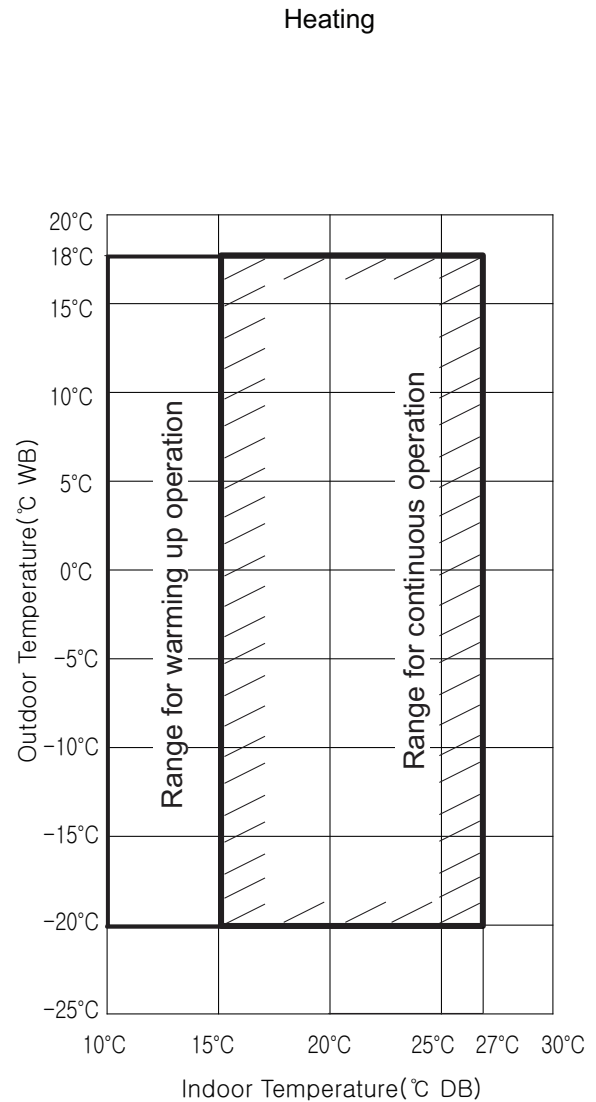
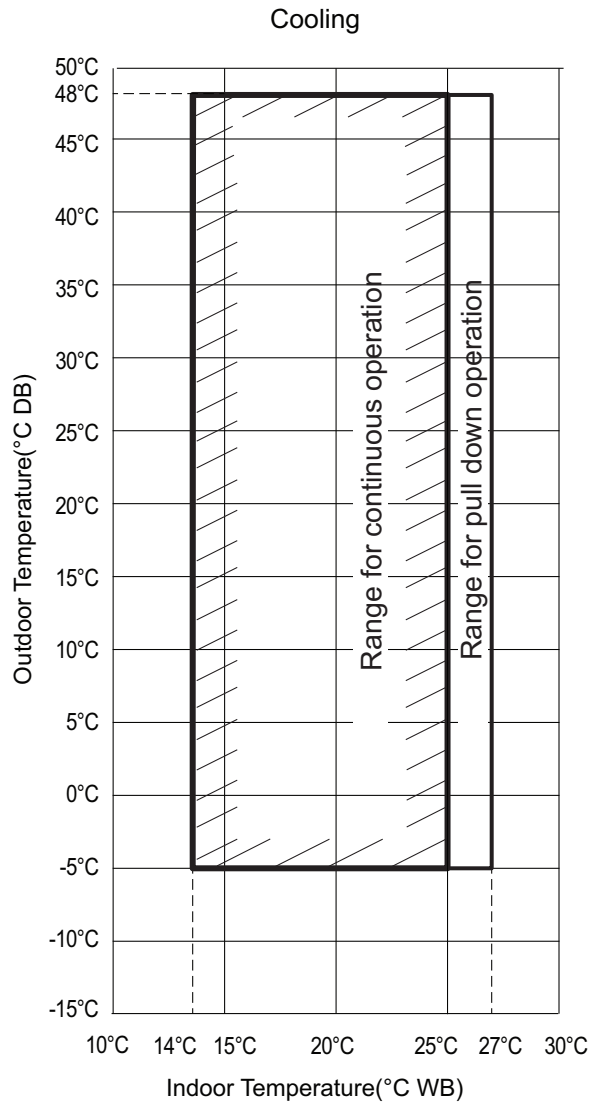

Note

- These figures assume the following operating conditions:
Equivalent piping length: 7.5m
Level difference: 0m
- Range of pull down operation:
If the relative humidity is too high, cooling capacity can be decreased by the sensible heat reduction.

10. Sound Levels

10.1 Sound Pressure Level

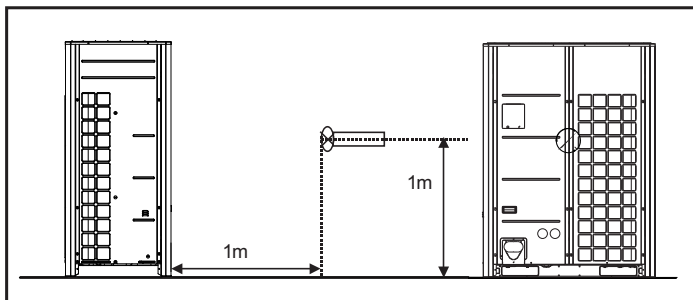
Note

- Data is valid at free field condition
- Data is valid at nominal operating condition
- Sound level will vary depending on a range of factors such as the construction (acoustic absorption coefficient) of particular room in which the equipment is installed
- Sound level can be increased in static pressure mode or air guide application.

Unit : dB(A)		
Model	Cooling	Heating
ARUN080LLS5	58.0	59.0
A(C)RUN100LLS5	58.0	59.0
A(C)RUN120LLS5	59.0	60.0
A(C)RUN140LLS5	60.0	61.0
A(C)RUN160LLS5	60.5	61.5
A(C)RUN180LLS5	62.0	64.5
A(C)RUN200LLS5	63.0	66.0
A(C)RUN220LLS5	64.0	67.0
A(C)RUN240LLS5	65.0	67.0
A(C)RUN260LLS5	65.0	67.0
A(C)RUN280LLS5	62.8	63.8
A(C)RUN300LLS5	63.8	65.8
A(C)RUN320LLS5	64.5	67.0
A(C)RUN340LLS5	65.2	67.8
A(C)RUN360LLS5	66.0	67.8
A(C)RUN380LLS5	66.0	67.8
A(C)RUN400LLS5	66.2	68.0
A(C)RUN420LLS5	66.3	68.1
A(C)RUN440LLS5	66.8	68.9
A(C)RUN460LLS5	67.1	69.5
A(C)RUN480LLS5	67.5	70.0
A(C)RUN500LLS5	68.0	70.0
A(C)RUN520LLS5	68.0	70.0
A(C)RUN540LLS5	67.1	68.7
A(C)RUN560LLS5	67.4	69.5
A(C)RUN580LLS5	67.7	70.0
A(C)RUN600LLS5	68.1	70.4
A(C)RUN620LLS5	68.5	70.4
A(C)RUN640LLS5	68.5	70.4
A(C)RUN660LLS5	68.6	70.5
A(C)RUN680LLS5	68.7	70.6
A(C)RUN700LLS5	69.0	71.1
A(C)RUN720LLS5	69.2	71.5
A(C)RUN740LLS5	69.5	71.8
A(C)RUN760LLS5	69.8	71.8
A(C)RUN780LLS5	69.8	71.8
A(C)RUN800LLS5	69.2	70.9
A(C)RUN820LLS5	69.4	71.4

10. Sound Levels

Model	Cooling	Heating
A(C)RUN840LLS5	69.6	71.8
A(C)RUN860LLS5	69.8	72.1
A(C)RUN880LLS5	70.1	72.1
A(C)RUN900LLS5	70.1	72.1
A(C)RUN920LLS5	70.2	72.1
A(C)RUN940LLS5	70.3	72.2
A(C)RUN960LLS5	70.4	72.5
A(C)RUN980LLS5	70.6	72.8
A(C)RUN1000LLS5	70.8	73.0
A(C)RUN1020LLS5	71.0	73.0
A(C)RUN1040LLS5	71.0	73.0

Unit : dB(A)

ARUN080LLS5

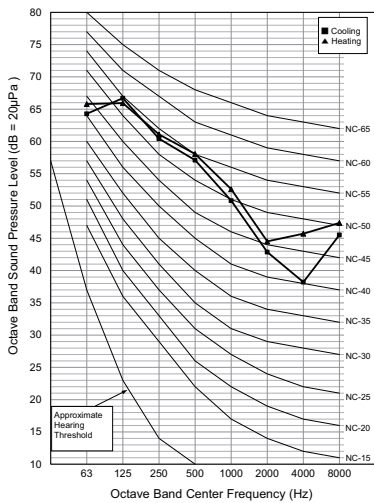

A(C)RUN100LLS5

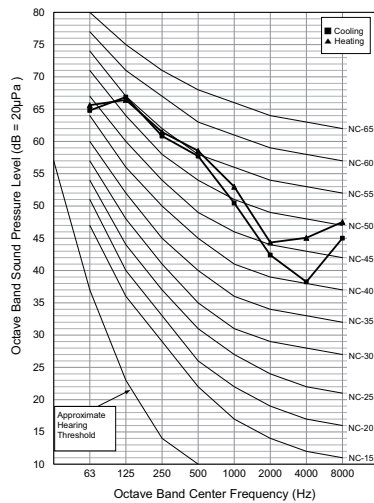

A(C)RUN120LLS5

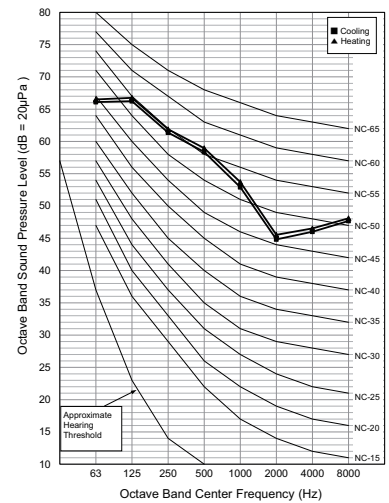

A(C)RUN140LLS5

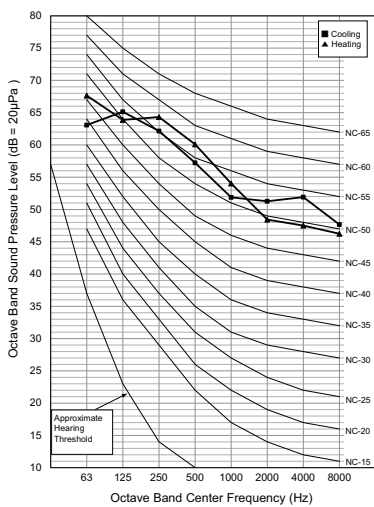

A(C)RUN160LLS5

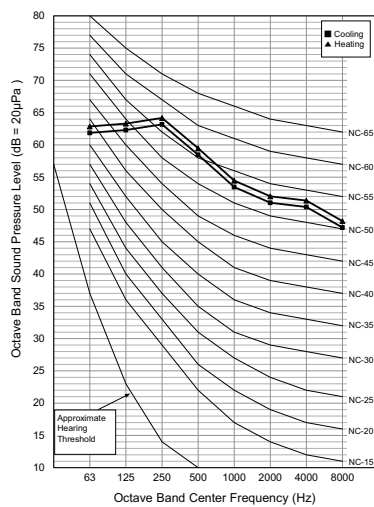

A(C)RUN180LLS5

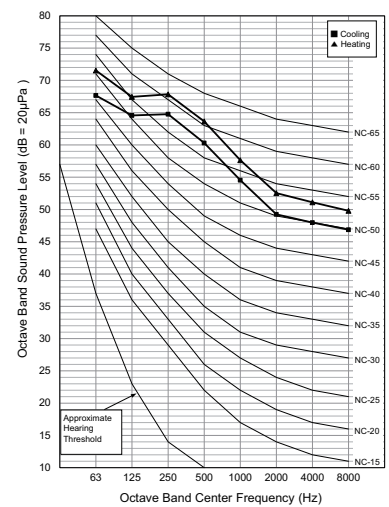

10. Sound Levels

A(C)RUN200LLS5

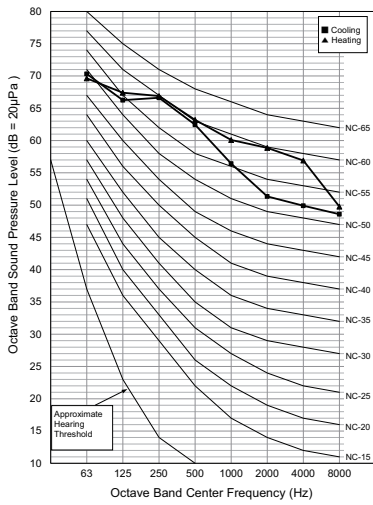

A(C)RUN220LLS5

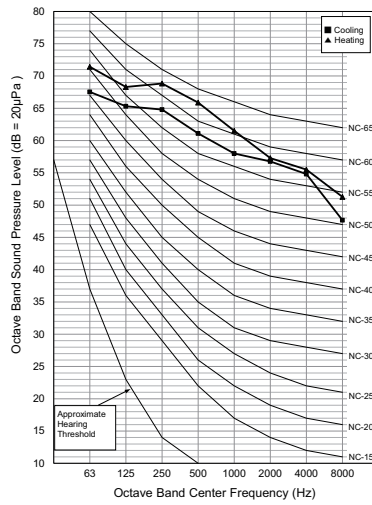

A(C)RUN240LLS5

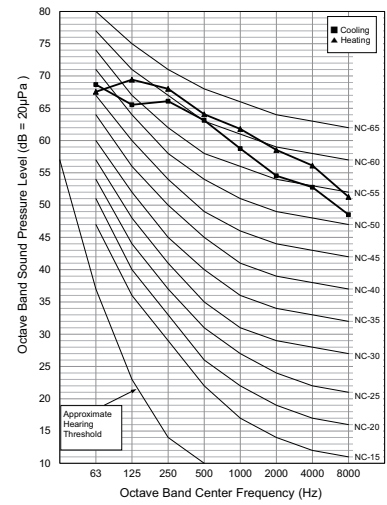

A(C)RUN260LLS5

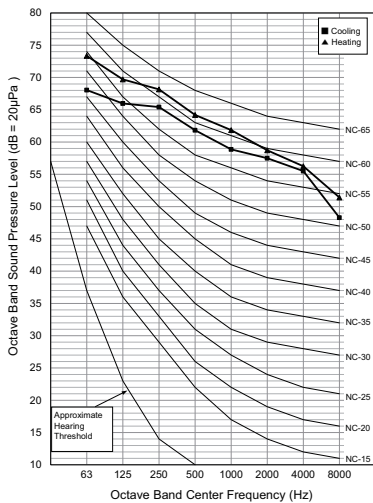

A(C)RUN280LLS5

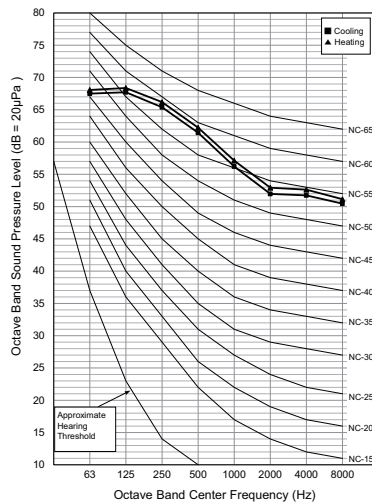

A(C)RUN300LLS5

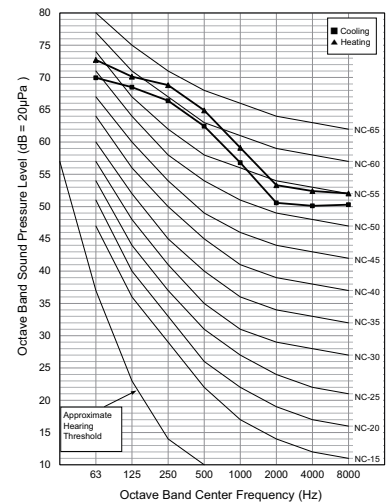

A(C)RUN320LLS5

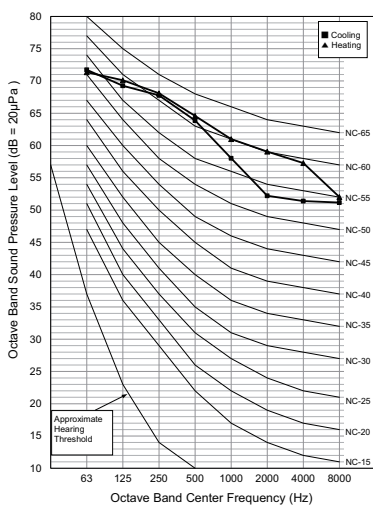

A(C)RUN340LLS5

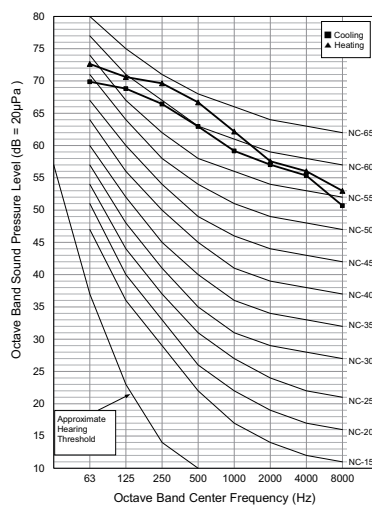

A(C)RUN360LLS5

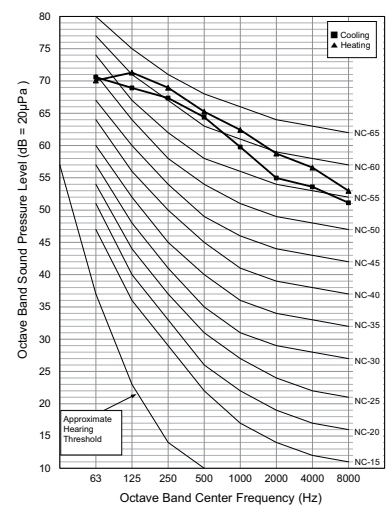

10. Sound Levels

A(C)RUN920LLS5

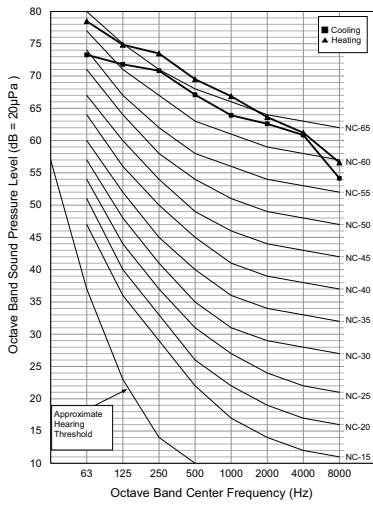

A(C)RUN940LLS5

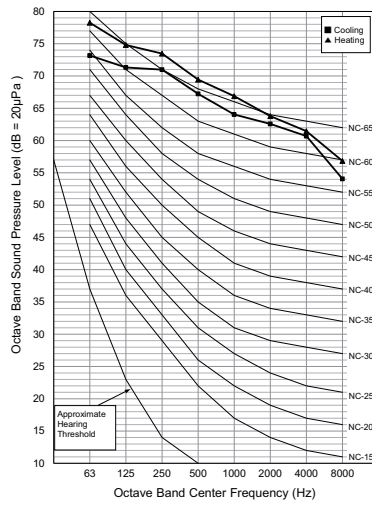

A(C)RUN960LLS5

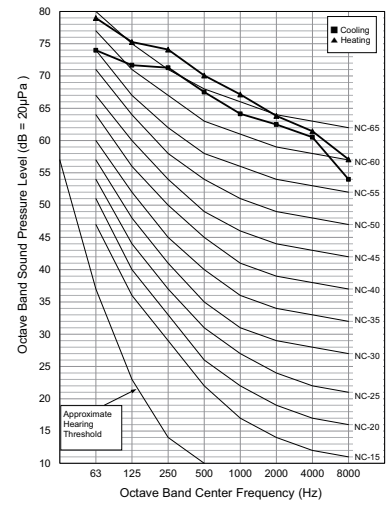

A(C)RUN980LLS5

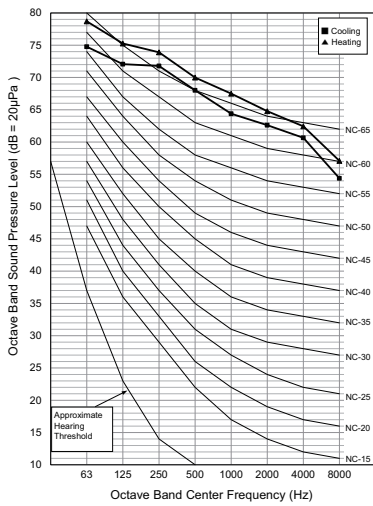

A(C)RUN1000LLS5

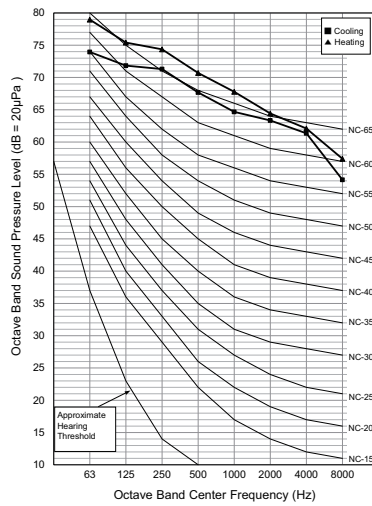

A(C)RUN1020LLS5

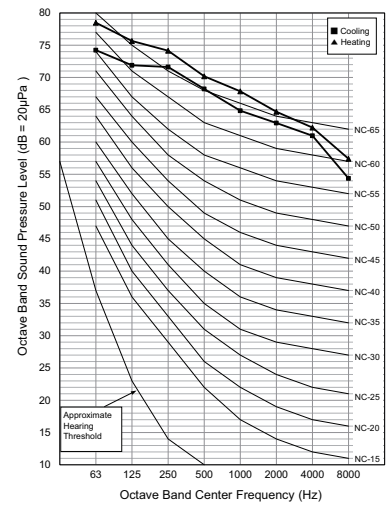

A(C)RUN1040LLS5

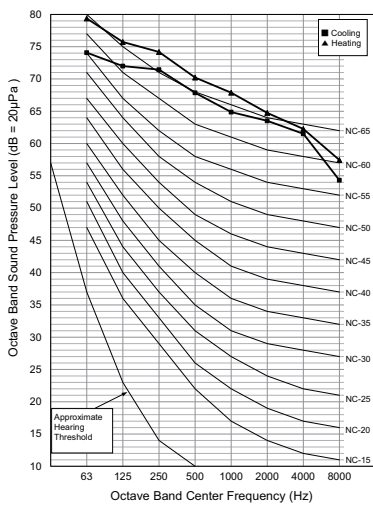

10. Sound Levels

10.2 Sound Power Level

Note

- Data is valid at diffuse field condition
- Data is valid at nominal operating condition
- Sound level can be increased in static pressure mode or used air guide.
- Sound power level is measured on the rated condition in the reverberation rooms.
- Sound level will vary depending on a range of factors such as the construction(acoustic absorption coefficient) of particular room in which the equipment in installed.
- Reference acoustic intensity 0dB = $10E-6\mu W/m^2$

Model	Unit : dB(A)	
	Cooling	Heating
ARUN080LLS5	78.0	79.0
A(C)RUN100LLS5	78.0	79.0
A(C)RUN120LLS5	79.0	80.0
A(C)RUN140LLS5	82.0	83.0
A(C)RUN160LLS5	83.0	85.0
A(C)RUN180LLS5	85.0	86.0
A(C)RUN200LLS5	86.0	89.0
A(C)RUN220LLS5	87.0	90.0
A(C)RUN240LLS5	88.0	90.0
A(C)RUN260LLS5	88.0	90.0
A(C)RUN280LLS5	84.5	86.2
A(C)RUN300LLS5	86.0	87.0
A(C)RUN320LLS5	86.8	89.5
A(C)RUN340LLS5	87.6	90.4
A(C)RUN360LLS5	88.5	90.4
A(C)RUN380LLS5	88.5	90.4
A(C)RUN400LLS5	89.0	90.8
A(C)RUN420LLS5	89.2	91.2
A(C)RUN440LLS5	89.8	91.5
A(C)RUN460LLS5	90.1	92.5
A(C)RUN480LLS5	90.5	93.0
A(C)RUN500LLS5	91.0	93.0
A(C)RUN520LLS5	91.0	93.0
A(C)RUN540LLS5	89.6	91.5
A(C)RUN560LLS5	90.1	91.8
A(C)RUN580LLS5	90.4	92.8
A(C)RUN600LLS5	90.8	93.2
A(C)RUN620LLS5	91.3	93.2
A(C)RUN640LLS5	91.3	93.2
A(C)RUN660LLS5	91.5	93.4
A(C)RUN680LLS5	91.6	93.6
A(C)RUN700LLS5	92.0	93.8
A(C)RUN720LLS5	92.2	94.5
A(C)RUN740LLS5	92.5	94.8
A(C)RUN760LLS5	92.8	94.8
A(C)RUN780LLS5	92.8	94.8
A(C)RUN800LLS5	91.9	93.8
A(C)RUN820LLS5	92.2	94.0

10. Sound Levels

Unit : dB(A)		
Model	Cooling	Heating
A(C)RUN840LLS5	92.4	94.6
A(C)RUN860LLS5	92.7	94.9
A(C)RUN880LLS5	92.9	94.9
A(C)RUN900LLS5	92.9	94.9
A(C)RUN920LLS5	93.1	95.1
A(C)RUN940LLS5	93.2	95.2
A(C)RUN960LLS5	93.4	95.3
A(C)RUN980LLS5	93.6	95.8
A(C)RUN1000LLS5	93.8	96.0
A(C)RUN1020LLS5	94.0	96.0
A(C)RUN1040LLS5	94.0	96.0

ARUN080LLS5

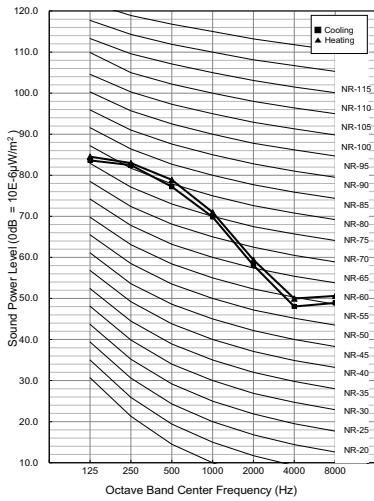

A(C)RUN100LLS5

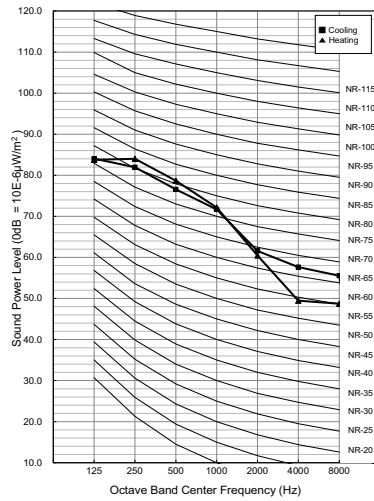

A(C)RUN120LLS5

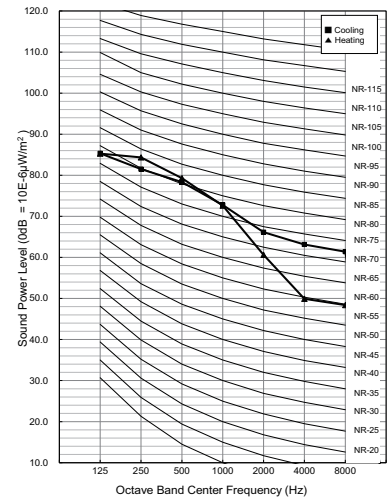

A(C)RUN140LLS5

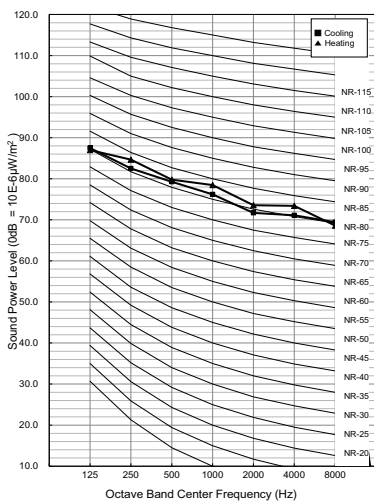

A(C)RUN160LLS5

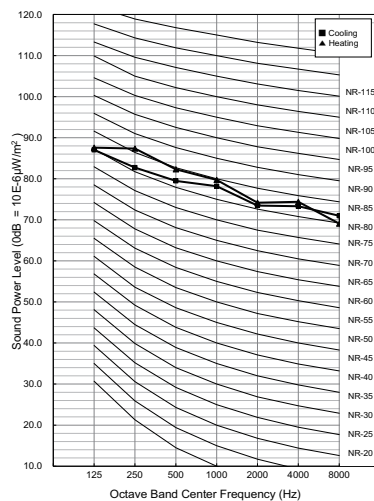

A(C)RUN180LLS5

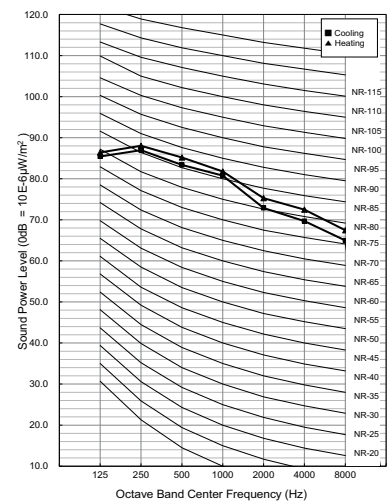

10. Sound Levels

A(C)RUN200LLS5

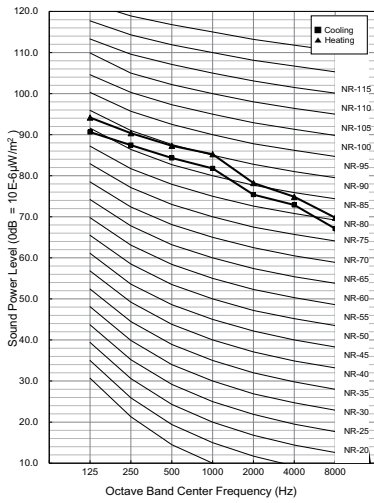

A(C)RUN220LLS5

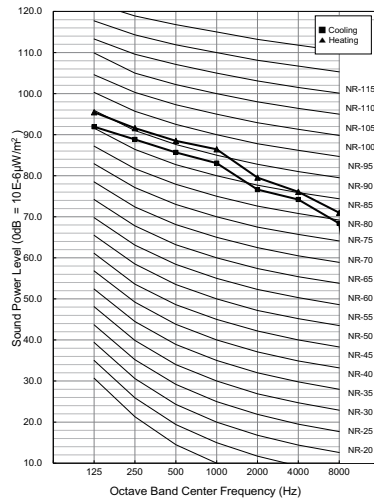

A(C)RUN240LLS5

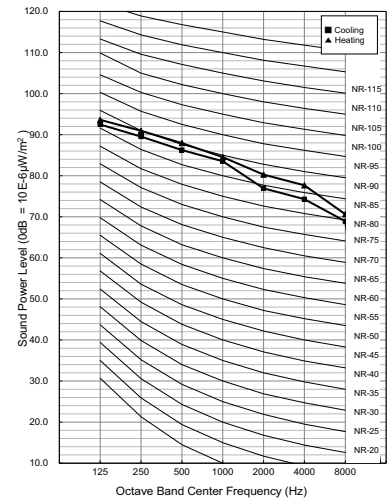

A(C)RUN260LLS5

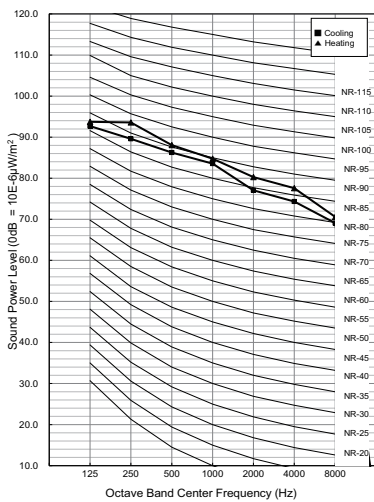

A(C)RUN280LLS5

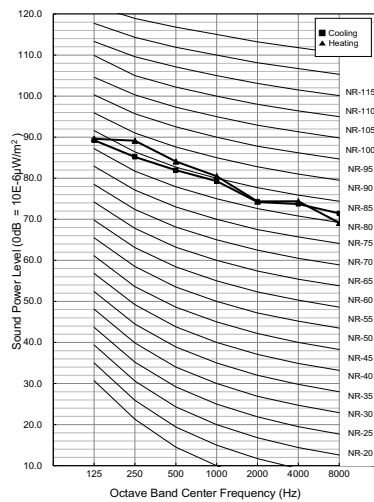

A(C)RUN300LLS5

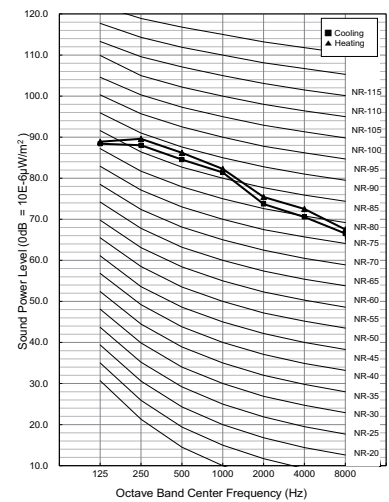

A(C)RUN320LLS5

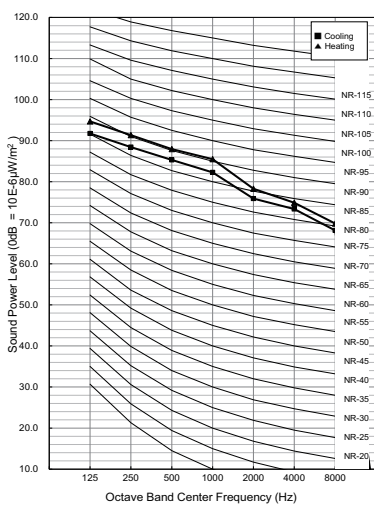

A(C)RUN340LLS5

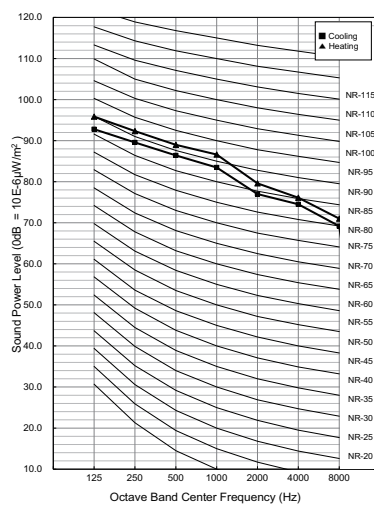

A(C)RUN360LLS5

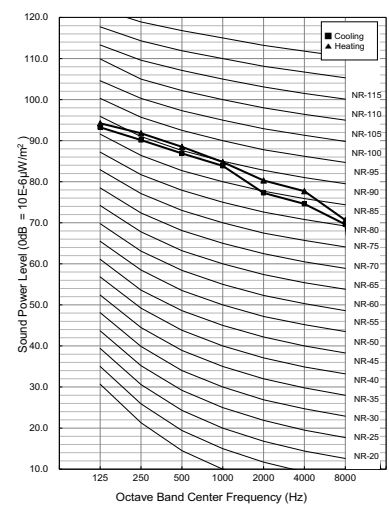

10. Sound Levels

A(C)RUN380LLS5

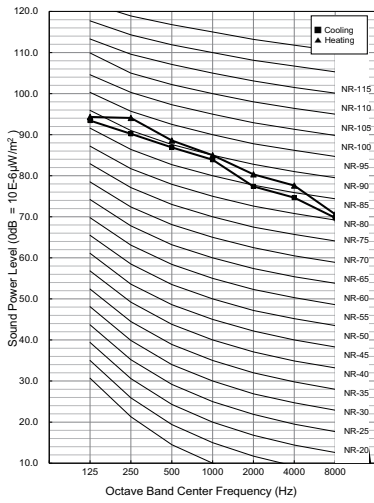

A(C)RUN400LLS5

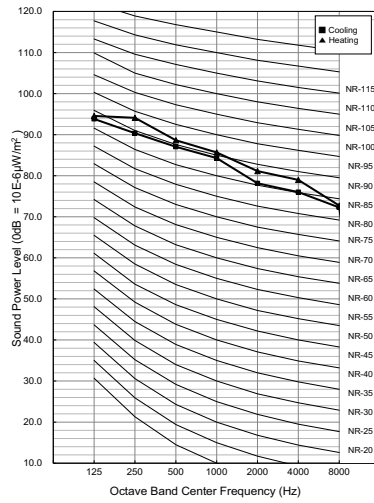

A(C)RUN420LLS5

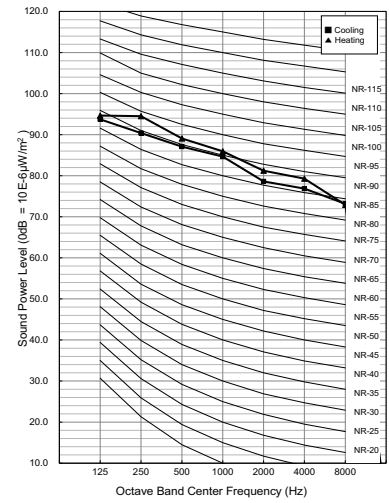

A(C)RUN440LLS5

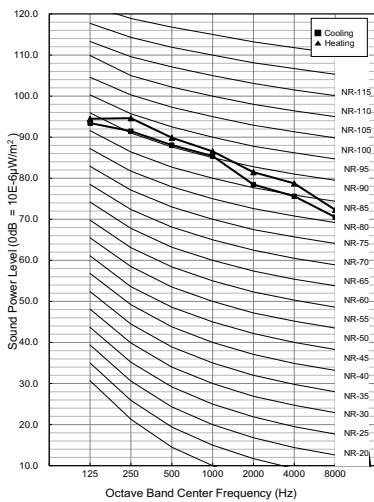

A(C)RUN460LLS5

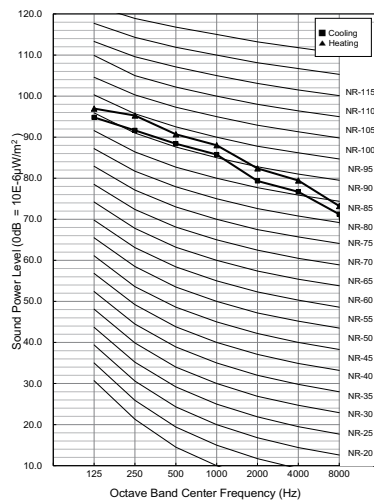

A(C)RUN480LLS5

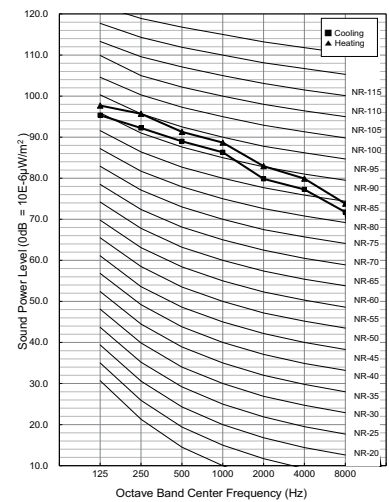

A(C)RUN500LLS5

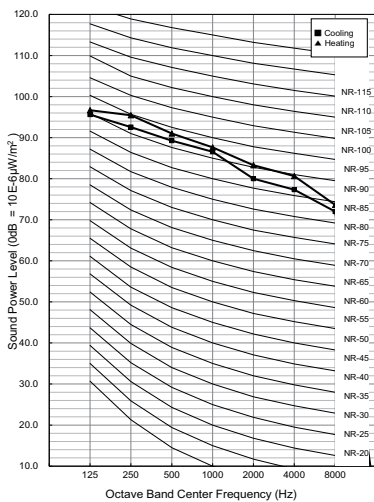

A(C)RUN520LLS5

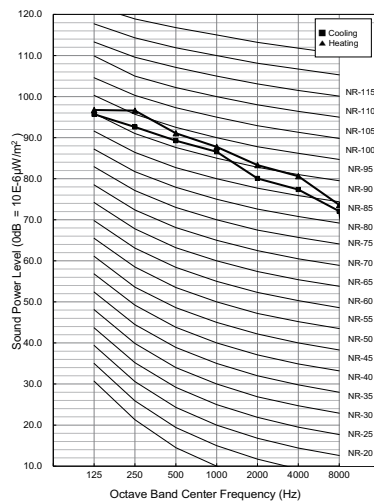

A(C)RUN540LLS5

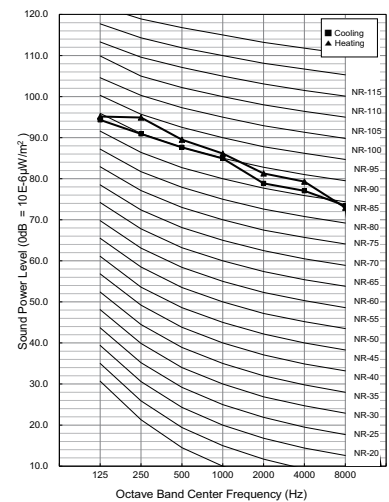

10. Sound Levels

A(C)RUN560LLS5

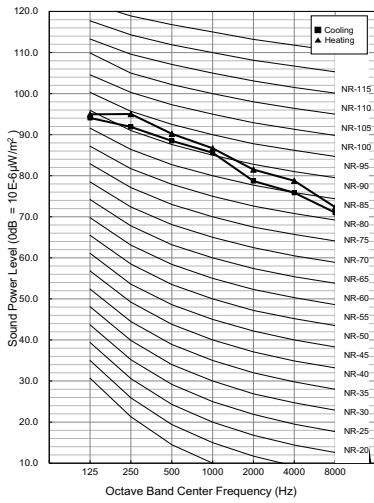

A(C)RUN580LLS5

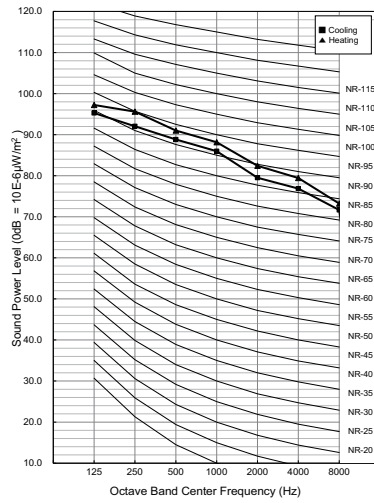

A(C)RUN600LLS5

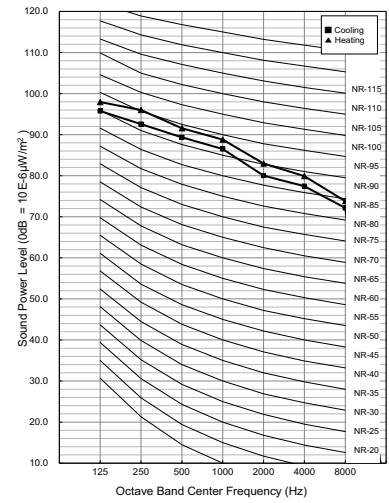

A(C)RUN620LLS5

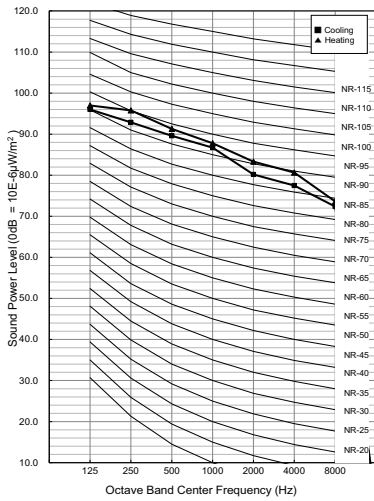

A(C)RUN640LLS5

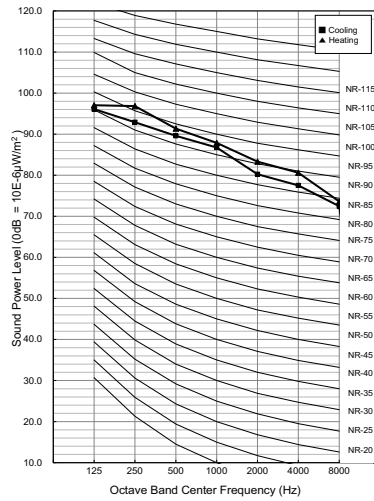

A(C)RUN660LLS5

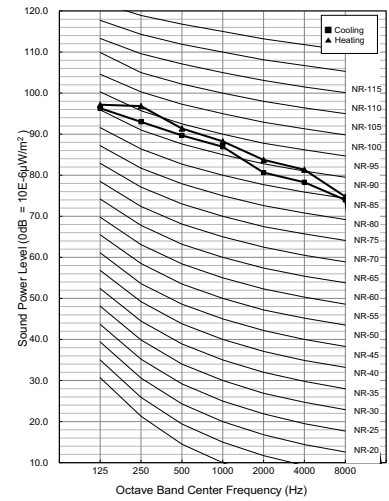

A(C)RUN680LLS5

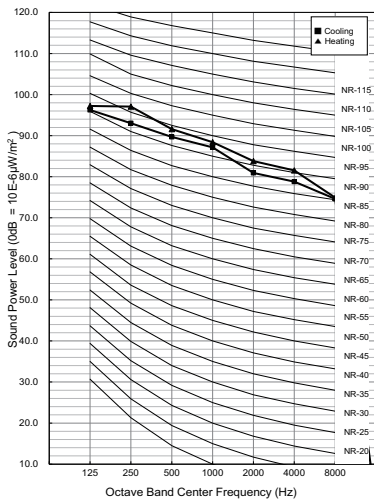

A(C)RUN700LLS5

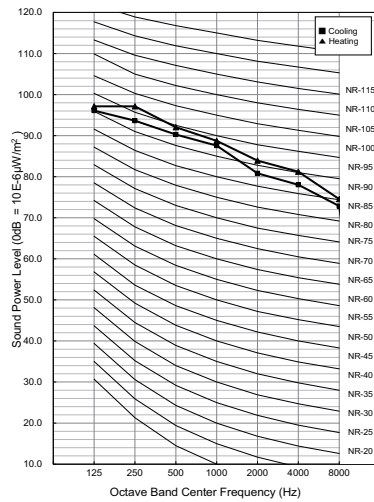

A(C)RUN720LLS5

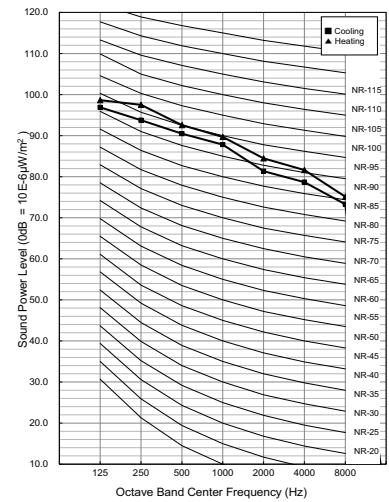

10. Sound Levels

A(C)RUN740LLS5

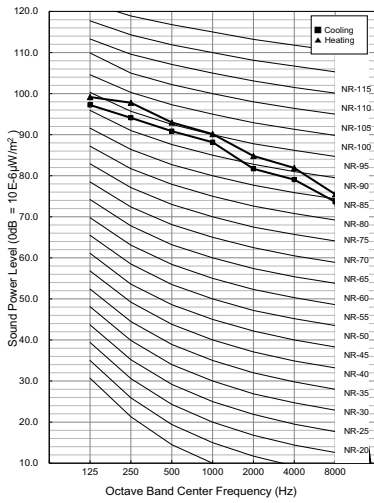

A(C)RUN760LLS5

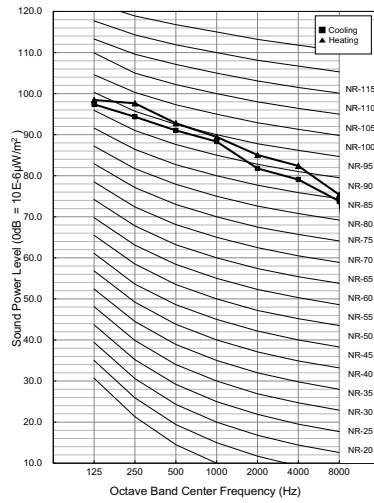

A(C)RUN780LLS5

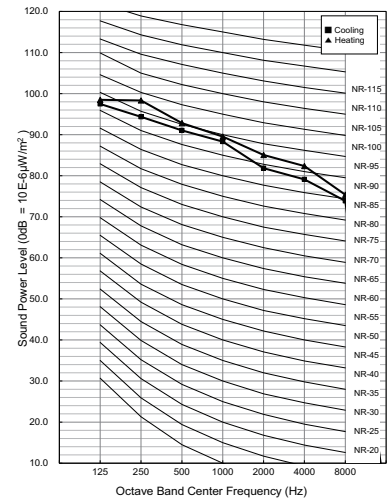

A(C)RUN800LLS5

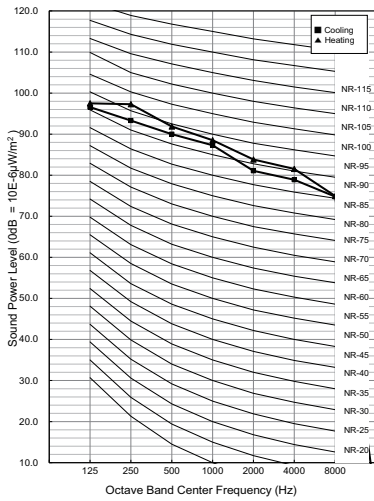

A(C)RUN820LLS5

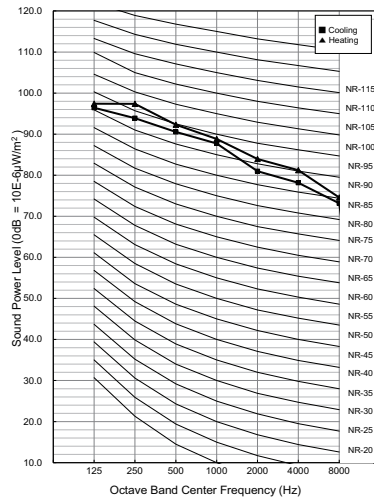

A(C)RUN840LLS5

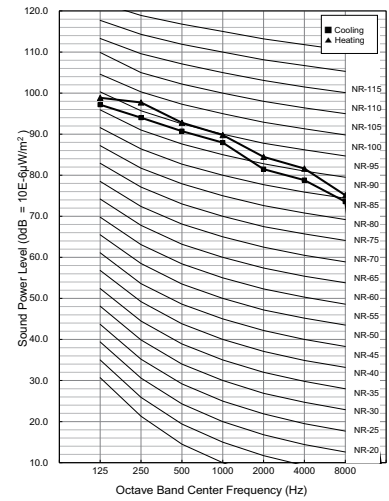

A(C)RUN860LLS5

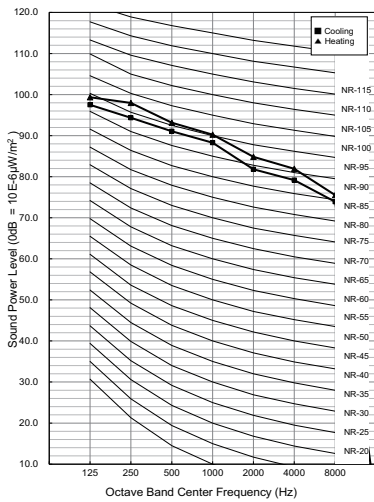

A(C)RUN880LLS5

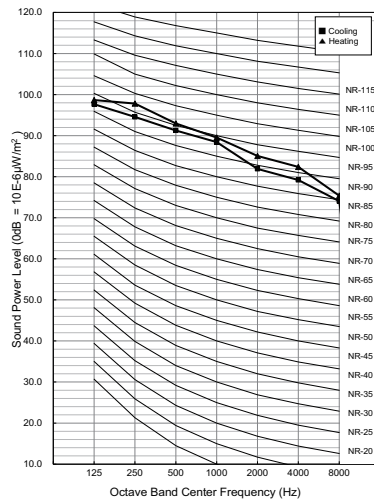

A(C)RUN900LLS5

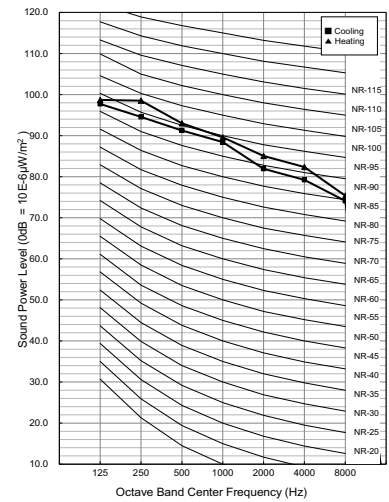

10. Sound Levels

A(C)RUN920LLS5

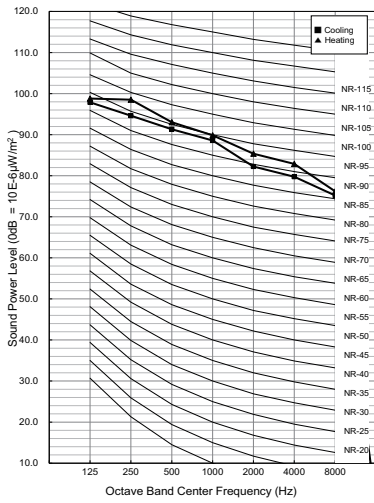

A(C)RUN940LLS5

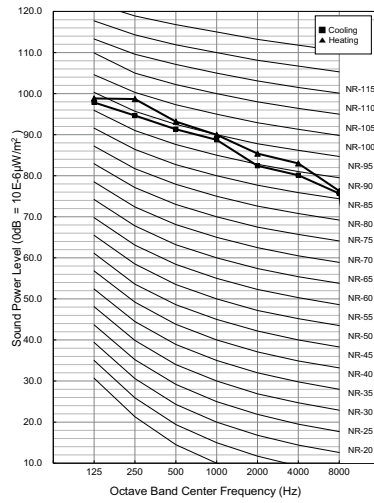

A(C)RUN960LLS5

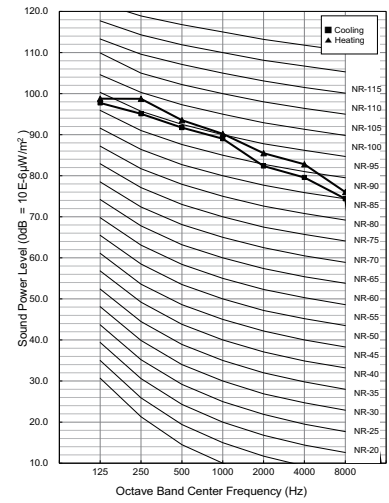

A(C)RUN980LLS5

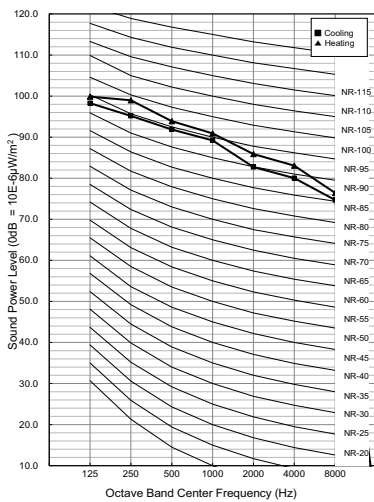

A(C)RUN1000LLS5

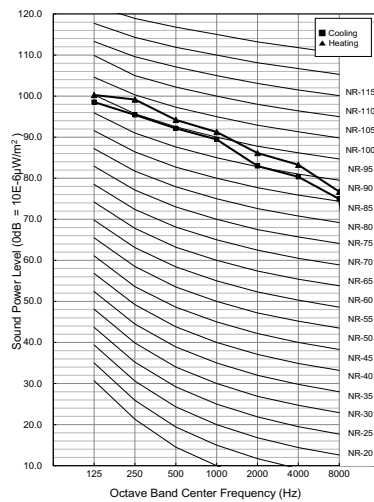

A(C)RUN1020LLS5

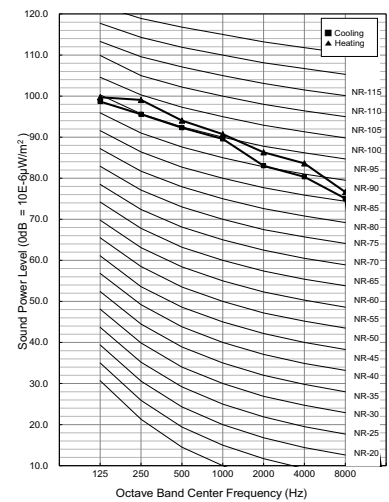

A(C)RUN1040LLS5

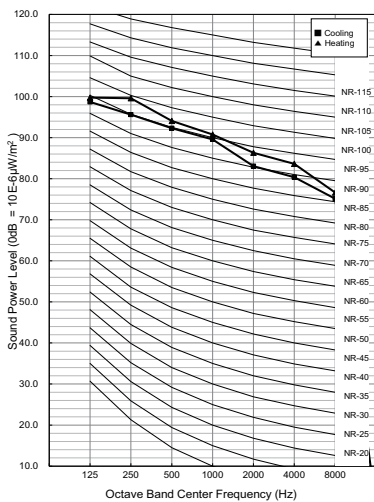

11. Accessories

■ Optional Accessories

No.	Name	Model
1	Y branch pipe	ARBLN01621
		ARBLN03321
		ARBLN07121
		ARBLN14521
		ARBLN23220
2	Header	ARBL054
		ARBL057
		ARBL104
		ARBL107
		ARBL1010
		ARBL2010
3	Connection pipe of Outdoor Units	ARCNN21
		ARCNN31
		ARCNN41

MULTI VTM 5

Installation of Outdoor Units

- 1. Alternative Refrigerant R410A**
- 2. Select the Best Location**
- 3. Installation Space**
- 4. Lifting Method**
- 5. Installation**
- 6. Refrigerant piping Installation**
- 7. Refrigerant piping system**
- 8. Electrical Wiring**
- 9. Setting Function**

1. Alternative Refrigerant R410A

- The refrigerant R410A has the property of higher operating pressure in comparison with R22. Therefore, all materials have the characteristics of higher resisting pressure than R22 ones and this characteristic should also be considered during the installation.
R410A is an azeotrope of R32 and R125 mixed at 50:50, so the ozone depletion potential (ODP) of R410A is 0.
-

CAUTION

- The wall thickness of the piping should comply with the relevant local and national regulations for the designed pressure 3.8MPa
 - Since R410A is a mixed refrigerant, the required additional refrigerant must be charged in its liquid state. If the refrigerant is charged in its gaseous state, its composition changes and the system will not work properly.
 - Do not place the refrigerant container under the direct rays of the sun to prevent it from exploding.
 - For high-pressure refrigerant, any unapproved pipe must not be used.
 - Do not heat pipes more than necessary to prevent them from softening.
 - Be careful not to install wrongly to minimize economic loss because it is expensive in comparison with R22.
-

2. Select the Best Location

Select space for installing outdoor unit, which will meet the following conditions:

- No direct thermal radiation from other heat sources
- No possibility of annoying neighbors due to noise of unit
- No exposition to strong wind
- With strength which bears weight of unit
- Note that drain flows out of unit when heating
- Because of the possibility of fire, do not install unit to the space where generation, inflow, stagnation, and leakage of combustible gas is expected.
- Avoid unit installation in a place where acidic solution and spray (sulfur) are often used.
- Do not use unit under any special environment where oil, steam and sulfuric gas exist.
- It is recommended to fence round the outdoor unit in order to prevent any person or animal from accessing the outdoor unit.
- If installation site is area of heavy snowfall, then the following directions should be observed.
 - Make the foundation as high as possible.
 - Fit a snow protection hood.
- Select installation location considering following conditions to avoid bad condition when additionally performing defrost operation.
 1. Install the outdoor unit at a place well ventilated and having a lot of sunshine in case of installing the product at a place with a high humidity in winter (near beach, coast, lake, etc).
(Ex) Rooftop where sunshine always shines.
 2. Performance of heating will be reduced and pre-heat time of the indoor unit may be lengthened in case of installing the outdoor unit in winter at following location:
 - 1) Shade position with a narrow space
 - 2) Location with much moisture in neighboring floor.
 - 3) Location with much humidity around.
 - 4) Location where liquid gathers since the floor is not even.

3. Installation Space

3.1 Individual Installation

During the installation of the unit, consider service, inlet, and outlet and acquire the minimum space as shown in the figures below. Side space should be more than 49 mm for operating of Auto Dust Removal mode.

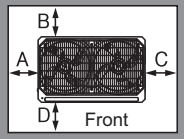
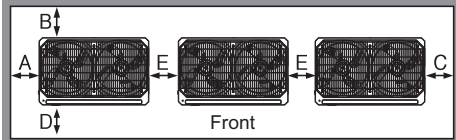
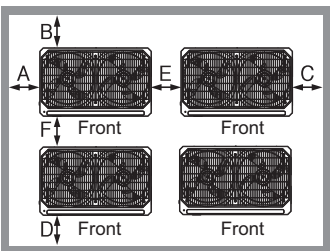
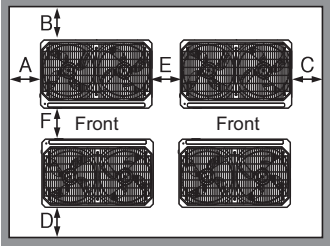
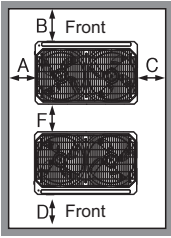
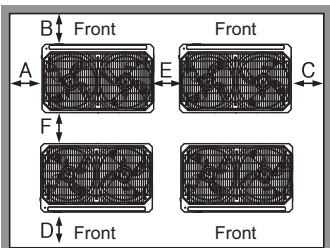
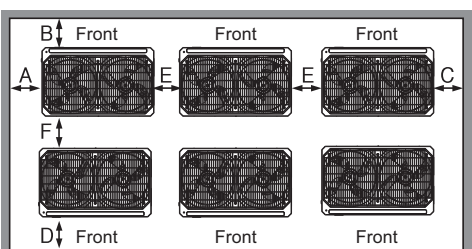
Category	Installation Space	Case 1 (10mm ≤ Side Space ≤ 49mm)	Case 2 (Side Space ≥ 49mm)
4 sides are walls		A ≥ 10 B ≥ 300 C ≥ 10 D ≥ 500	A ≥ 50 B ≥ 100 C ≥ 50 D ≥ 500
		A ≥ 10 B ≥ 300 C ≥ 10 D ≥ 500 E ≥ 20	A ≥ 50 B ≥ 100 C ≥ 50 D ≥ 500 E ≥ 100
		A ≥ 10 B ≥ 300 C ≥ 10 D ≥ 500 E ≥ 20 F ≥ 600	A ≥ 50 B ≥ 100 C ≥ 50 D ≥ 500 E ≥ 100 F ≥ 500
		A ≥ 10 B ≥ 300 C ≥ 10 D ≥ 300 E ≥ 20 F ≥ 500	A ≥ 50 B ≥ 100 C ≥ 50 D ≥ 100 E ≥ 100 F ≥ 500
Rear to Rear		A ≥ 10 B ≥ 500 C ≥ 10 D ≥ 500 F ≥ 900	A ≥ 50 B ≥ 500 C ≥ 50 D ≥ 500 F ≥ 600
		A ≥ 10 B ≥ 500 C ≥ 10 D ≥ 500 E ≥ 20 F ≥ 1200	A ≥ 50 B ≥ 500 C ≥ 50 D ≥ 500 E ≥ 100 F ≥ 900
		A ≥ 10 B ≥ 500 C ≥ 10 D ≥ 500 E ≥ 20 F ≥ 1800	A ≥ 50 B ≥ 500 C ≥ 50 D ≥ 500 E ≥ 100 F ≥ 1200

3. Installation Space

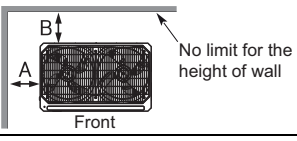
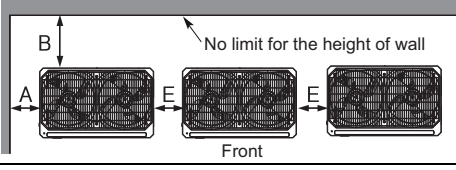
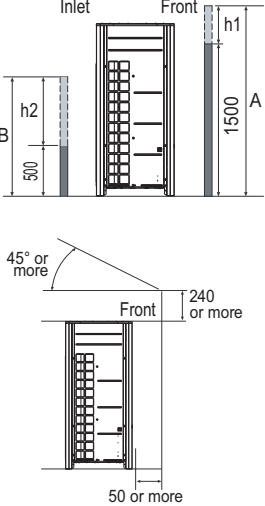
Category	Installation Space	Case 1 (10mm ≤ Side Space ≤ 49mm)	Case 2 (Side Space ≥ 49mm)
Only 2 sides are walls		-	A ≥ 200 B ≥ 300
		-	A ≥ 200 B ≥ 300 E ≥ 400
Limitations on the height of the wall (Refer to 4 side walls)		<ul style="list-style-type: none"> The height of the wall on the front side must be 1500mm or less. The height of the wall on the inlet side must be 500mm or less. There is no limit to the wall on the side. If the height of the walls on the front and the rear side are higher than the limit, there must be additional space on the front and the rear side. <ul style="list-style-type: none"> Additional Space on the front side by 1/2 of h1. Additional Space on the inlet side by 1/2 of h2 h1 = A(Actual height) - 1500 h2 = B(Actual height) - 500 	

■ Seasonal wind and cautions in winter

- Sufficient measures are required in a snow area or severe cold area in winter so that product can be operated well.
- Get ready for seasonal wind or snow in winter even in other areas.
- Install a suction and discharge duct not to let in snow or rain.
- Install the outdoor unit in such a way that it should not come in contact with snow directly. If snow piles up and freezes on the air suction hole, the system may malfunction. If it is installed at snowy area, attach the hood to the system.
- The raised support platform must be high enough to allow the unit to remain above possible snow drifts, and must be higher than the maximum anticipated snowfall for the location.
- Where snow accumulated on the upper part of the Outdoor Unit by more than 10cm, always remove snow for operation.

⚠ CAUTION

- Don't install the suction hole and discharge hole of the Outdoor Unit facing the seasonal wind.

4. Lifting Method

- When carrying the suspended, unit pass the ropes under the unit and use the two suspension points each at the front and rear.
- Always lift the unit with ropes attached at four points so that impact is not applied to the unit.
- Attach the ropes to the unit at an angle of 40° or less.

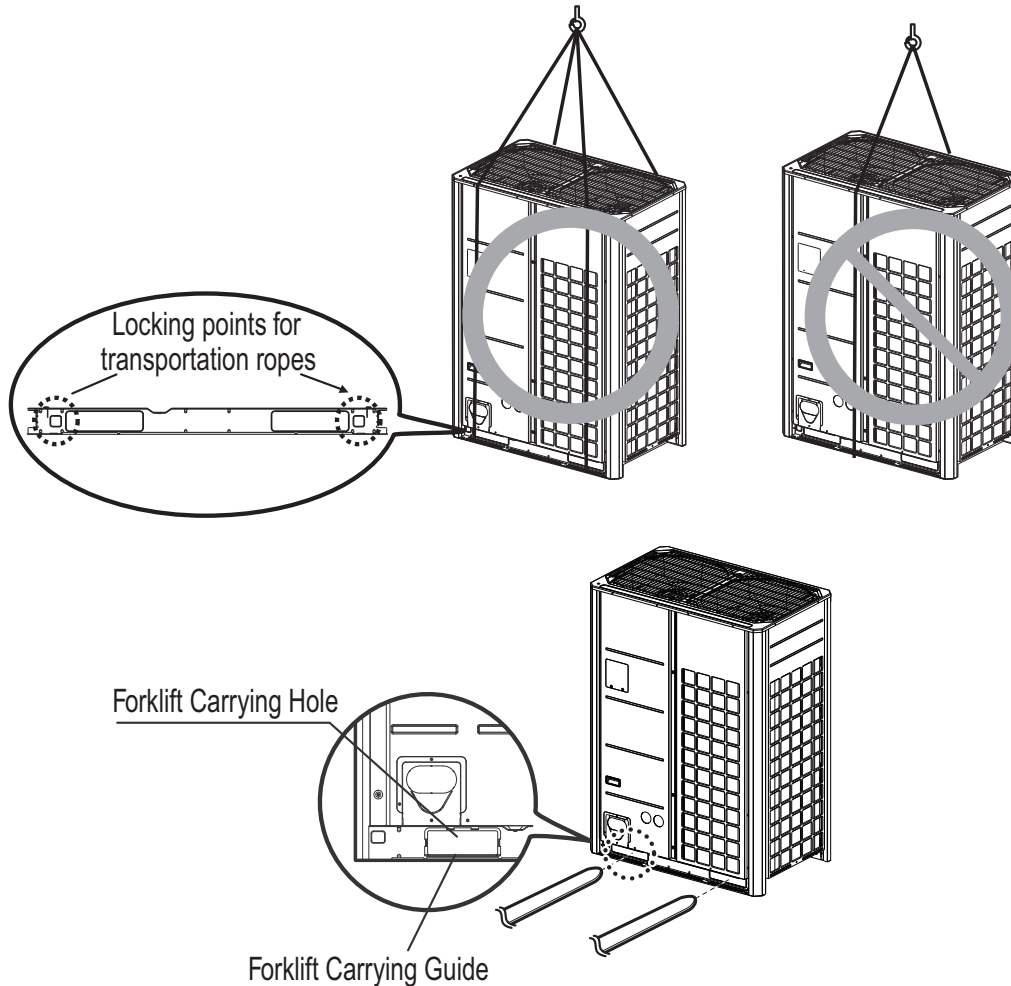

CAUTION

Be very careful while carrying the product.

- Do not have only one person carry product if it is more than 20kg(441lbs).
- PP bands are used to pack some products. Do not use them as a mean for transportation because they are dangerous.
- Do not touch heat exchanger fins with your bare hands. Otherwise you may get a cut in your hands.
- Tear plastic packaging bag and scrap it so that children cannot play with it. Otherwise plastic packaging bag may suffocate children to death.
- When carrying in Outdoor Unit, be sure to support it at four points. Carrying in and lifting with 3-point support may make Outdoor Unit unstable, resulting in a fall.
- Use 2 belts of at least 8m(26.2ft) long.
- Place extra cloth or boards in the locations where the casing comes in contact with the sling to prevent damage.
- Hoist the unit making sure it is being lifted at its center of gravity.

5. Installation

- Install at places where it can endure the weight and vibration/noise of the outdoor unit.
- The outdoor unit support block at the bottom shall have width of at least 100mm(3-15/16inch) under the units legs before being fixed.
- The outdoor unit support block should have minimum height of 200mm(7-7/8inch).
- Anchor bolts must be inserted at least 75mm(2-15/16inch).

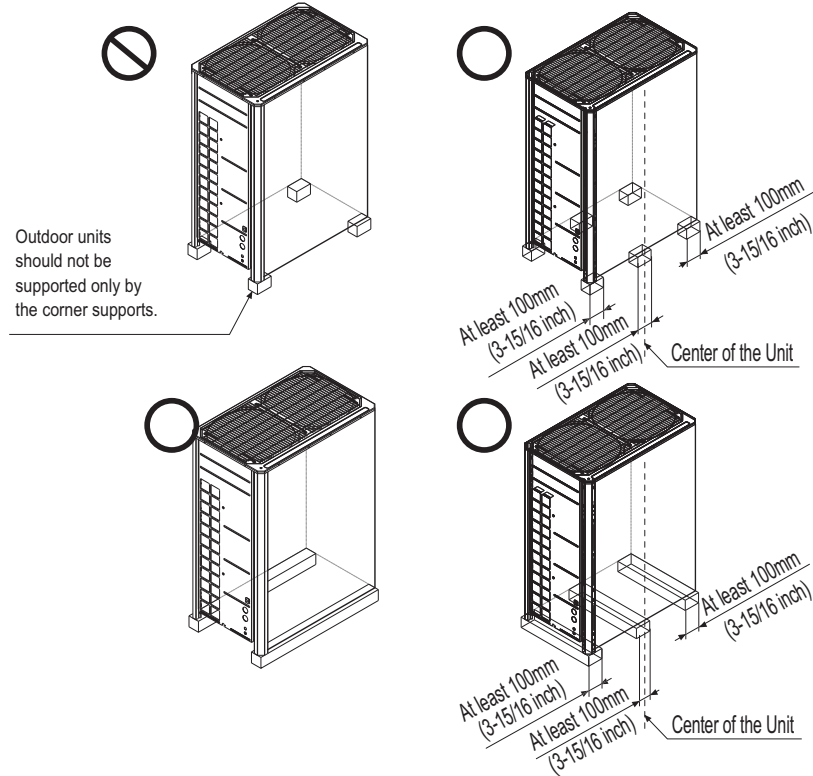

5.1 The location of the Anchor bolts

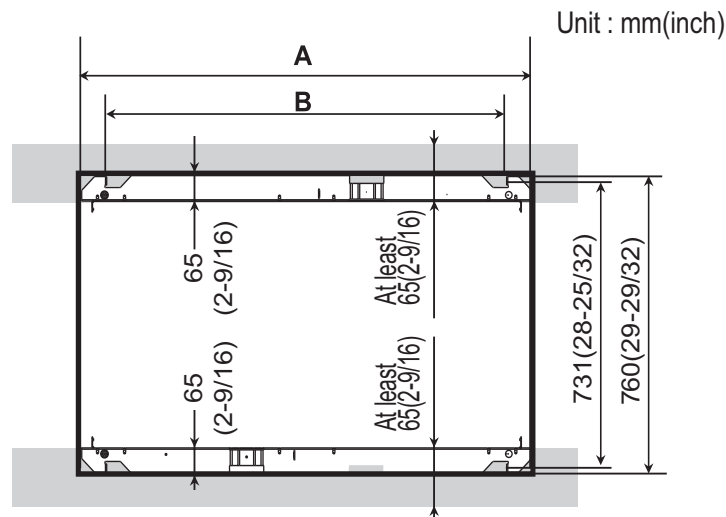

Chassis	A [mm(inch)]	B [mm(inch)]
UXA	930(36-5/8)	730(28-3/4)
UXB	1,240(48-13/16)	1,040(40-15/16)

5. Installation

5.2 Foundation for Installation

- Fix the unit tightly with bolts as shown below so that unit will not fall down due to earthquake or gust.
- Use the H-beam support as a base support
- Noise and vibration may occur from the floor or wall since vibration is transferred through the installation part depending on installation status. Thus, use anti-vibration materials (cushion pad) fully (The base pad shall be more than 200mm(7-7/8inch))

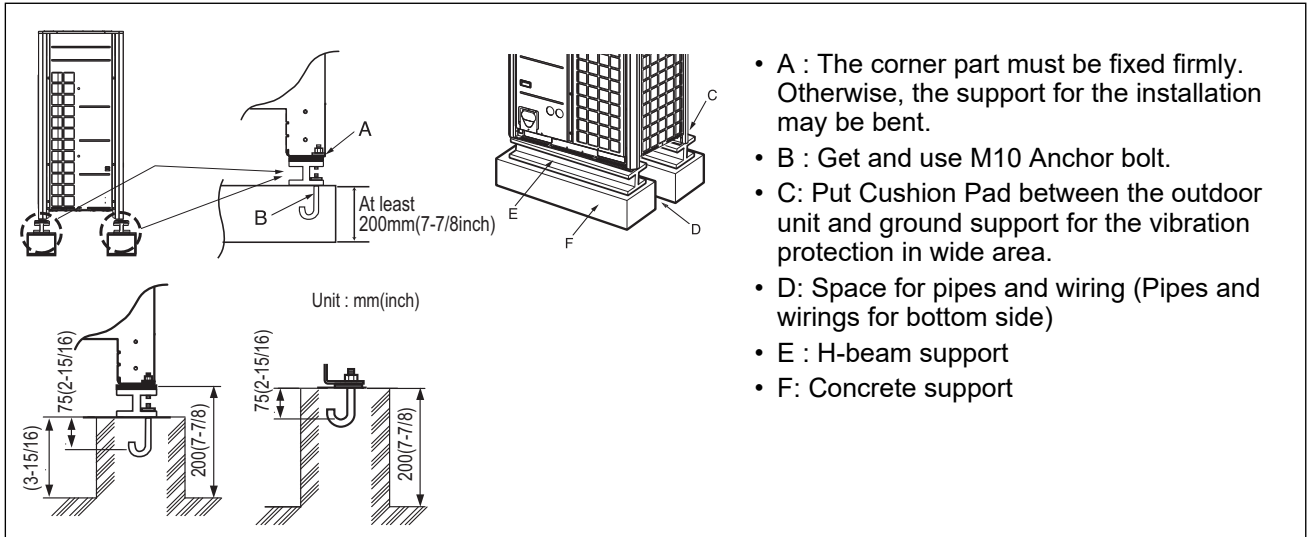

⚠ WARNING

- Install where it can sufficiently support the weight of the outdoor unit.
If the support strength is not enough, the outdoor unit may drop and hurt people.
- Install where the outdoor unit may not fall in strong wind or earthquake.
If there is a fault in the supporting conditions, the outdoor unit may fall and hurt people.
- Please take extra cautions on the supporting strength of the ground, liquid outlet treatment (treatment of the liquid flowing out of the outdoor unit in operation), and the passages of the pipe and wiring, when making the ground support.
- Do not use tube or pipe for liquid outlet in the Base pan. Use drainage instead for liquid outlet. The tube or pipe may freeze and the liquid may not be drained.

⚠ CAUTION

- Be sure to remove the MDF (wood support) of the bottom side of the outdoor unit Base Pan before fixing the bolt. It may cause the unstable state of the outdoor settlement, and may cause freezing of the heat exchanger resulting in abnormal operations.
- Be sure to remove the MDF (wood support) of the bottom side of the outdoor unit before welding. Not removing MDF causes hazard of fire during welding.

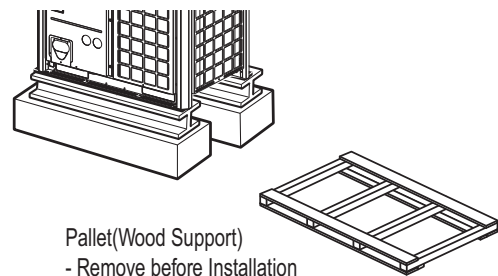

6. Refrigerant piping Installation

6.1 Precautions on Pipe connection / Valve operation

Pipe connection is done by connecting from the end of the pipe to the branching pipes, and the refrigerant pipe coming out of the outdoor unit is divided at the end to connect to each indoor unit. Flare connection for the indoor unit, and welding connection for the outdoor pipe and the branching parts.

- Use hexagonal wrench to open/close the valve.

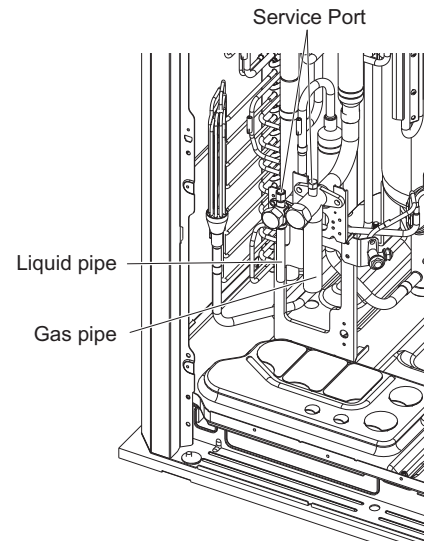

! WARNING

- Always careful not to leak the refrigerant during welding.
- The refrigerant generates poisonous gas harmful to human body if combusted.
- Do not perform welding in a closed space.
- Be sure to close the cap of the service port to prevent gas leakage after the work.

! CAUTION

Please block the pipe knock outs of the front and side panels after installing the pipes.
(Animals or foreign objects may be brought in to damage the cables.)

6. Refrigerant piping Installation

6.2 Connection of Outdoor units

When installing outdoor unit series, refer below picture.

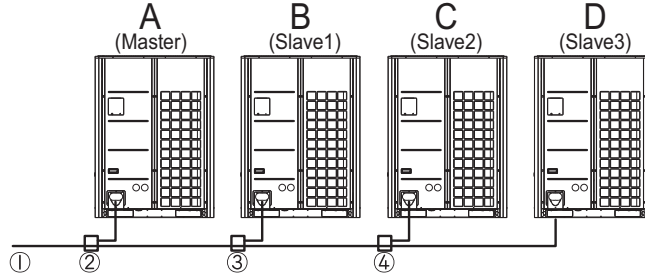

A ≥ B ≥ C ≥ D

- ① Indoor unit side connection pipe
- ② Outdoor unit to outdoor unit connection pipe (1st branch)
- ③ Outdoor unit to outdoor unit connection pipe (2st branch)
- ④ Outdoor unit to outdoor unit connection pipe (3rd branch)

■ Heat Pump System

Outdoor unit	Model	Liquid pipe [unit:mm]	Gas pipe [unit:mm]
	③ ARCNN21		
	⑤ ARCNN31		
	⑦ ARCNN41		

* For more information including installation method of connection pipe, refer accessory installation manual.

* The above System is representative Multi V 5 System. Actual combination of outdoor unit may be different by product line-up of region.

7. Refrigerant piping system

7.1 Pipe Connection Method between outdoor unit / indoor unit

7.1.1 Heat Pump System

■ Single Outdoor Unit Connection

Y branch method

- Ⓐ Outdoor Unit
- Ⓑ 1st branch (Y branch)
- Ⓓ Indoor Units

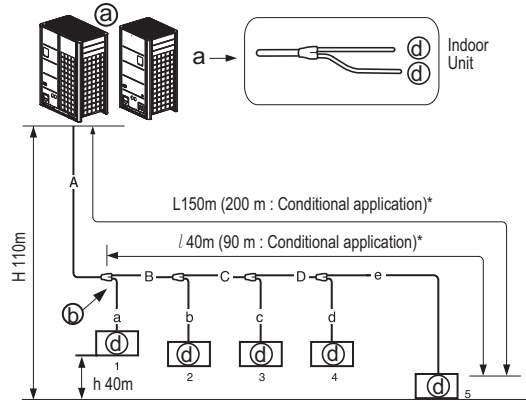

Combination of Y branch / header method

- Ⓐ Outdoor Unit
- Ⓑ 1st branch (Y branch)
- Ⓒ Y branch
- Ⓓ Indoor Units
- Ⓔ Header
- Ⓕ Sealed piping

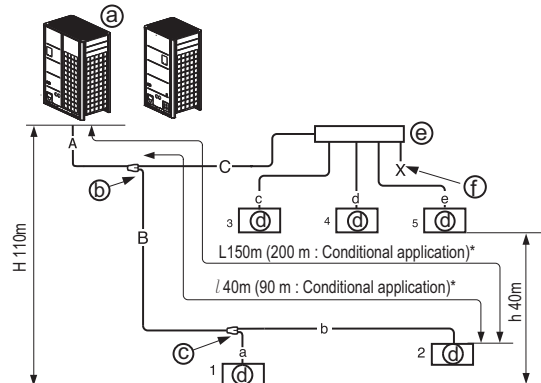

Header method

- Ⓐ Outdoor Unit
- Ⓓ Indoor Units
- Ⓔ Header
- Ⓕ Sealed piping

⚠ WARNING

Pipe length after header branching

- It is recommended that difference in length of the pipes connected to the indoor units (a~f) is minimized. Performance difference between indoor units may occur.

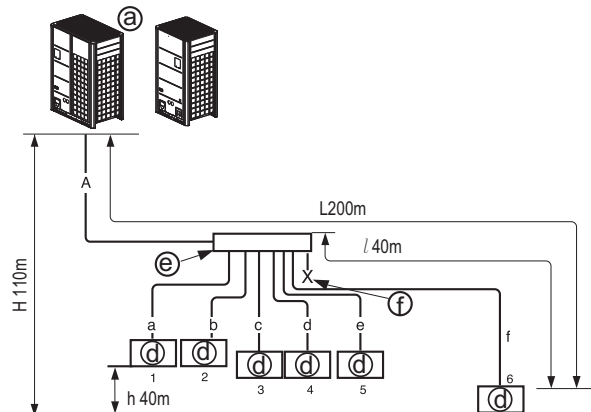

⚠ WARNING

- Branch pipe can not be used after header

7. Refrigerant piping system

Series Outdoor Unit Connection

Y branch method

- Ⓐ Outdoor Unit
- Ⓑ 1st branch (Y branch)
- Ⓓ Indoor Units
- Ⓔ Connection branch pipe between outdoor units (ARCNN41)
- Ⓕ Connection branch pipe between outdoor units (ARCNN31)
- Ⓖ Connection branch pipe between outdoor units (ARCNN21)

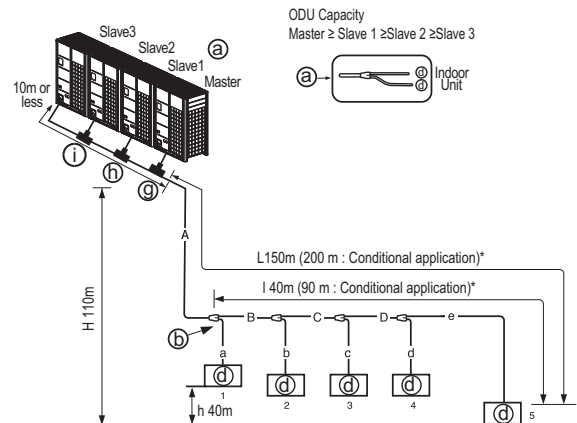

Combination of Y branch / header Method

- Ⓐ Outdoor Unit
- Ⓑ 1st branch (Y branch)
- Ⓒ Y branch
- Ⓓ Indoor Units
- Ⓔ Header
- Ⓕ Sealed piping
- Ⓖ Connection branch pipe between outdoor units (ARCNN41)
- Ⓕ Connection branch pipe between outdoor units (ARCNN31)
- Ⓖ Connection branch pipe between outdoor units (ARCNN21)

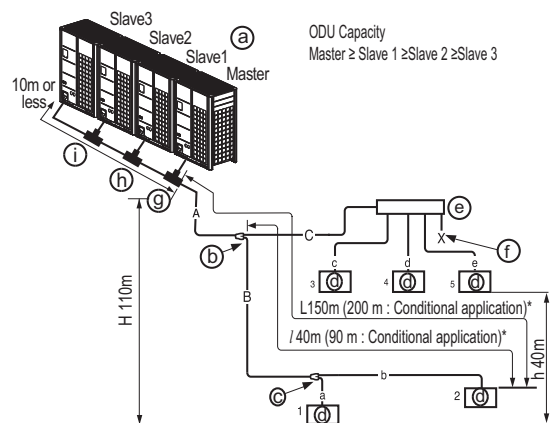

Header Method

- Ⓐ Outdoor Unit
- Ⓓ Indoor Units
- Ⓔ Header
- Ⓕ Sealed piping
- Ⓖ Connection branch pipe between outdoor units (ARCNN41)
- Ⓕ Connection branch pipe between outdoor units (ARCNN31)
- Ⓖ Connection branch pipe between outdoor units (ARCNN21)

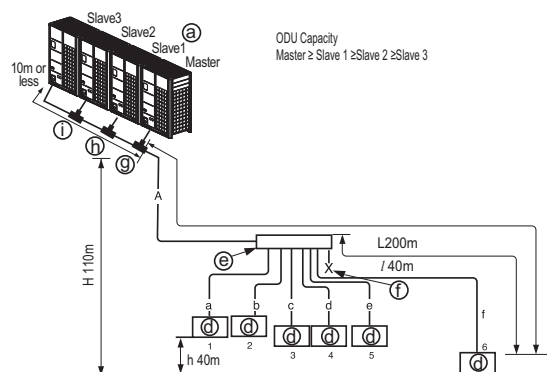

⚠ WARNING

Pipe length after header branching

- It is recommended that difference in length of the pipes connected to the indoor units (a~f) is minimized.

Performance difference between indoor units may occur.

⚠ WARNING

- Branch pipe can not be used after header

➤ Maximum number of connectable units could be different in accordance with model line up of target region.

7. Refrigerant piping system

■ Limits of pipe length and difference in height

Connection method		Y branch only	Combination of Y branch/header	Header only
Max. pipe length	Longest pipe length (L) : between Outdoor Unit and Indoor Unit	$A+B+C+D+e \leq 150\text{m}$ (200 m ^{**})	$A+B+b \leq 150\text{ m}$ (200 m ^{**}) $A+C+e \leq 150\text{ m}$ (200 m ^{**})	$A+f \leq 200\text{ m}$
	Longest pipe equivalent length* (L) : between Outdoor Unit and Indoor Unit	175 m (225m ^{**})	175 m (225 m [*])	225 m
	Longest pipe length after 1st branch (l)	40 m (90 m ^{**})	40 m (90 m ^{**})	40 m
	Total pipe length	1,000 m	1,000 m	1,000 m
Max. difference in height	Difference in height (H) : between Outdoor Unit and Indoor Unit	110 m	110 m	110 m
	Difference in height (h) : between Indoor Unit and Indoor Unit	40 m	40 m	40 m

Note

- * : Assume equivalent piping length of Y branch to be 0.5m, that of header to be 1m, calculation purpose.
- ** : To apply Conditional Application

WARNING

When the any one (or both) of below conditions are satisfied, the diameter of main pipe (A) must be increased according to below table.

- The equivalent length between outdoor unit and the farthest indoor unit is 90m or more (Liquid and Gas pipes are increased)
- The level difference (Outdoor unit ↔ Indoor unit) is 50m or more (Only liquid pipe is increased)

■ Refrigerant pipe diameter from outdoor unit to first branch. (A)

Upward Outdoor unit total capacity	Standard Pipe Diameter		Increased Pipe Diameter			
			When equivalent pipe length is 90m or more from ODU to farthest IDU		When level difference is 50m or more	
HP	Liquid pipe [mm(inch)]	Gas pipe [mm(inch)]	Liquid pipe [mm(inch)]	Gas pipe [mm(inch)]	Liquid pipe [mm(inch)]	Gas pipe [mm(inch)]
8	Ø 9.52(3/8)	Ø 19.05(3/4)	Ø 12.7(1/2)	Ø 22.2(7/8)	Ø 12.7(1/2)	not increased
10	Ø 9.52(3/8)	Ø 22.2(7/8)	Ø 12.7(1/2)	Ø 25.4(1) *	Ø 12.7(1/2)	not increased
12 ~ 14	Ø 12.7(1/2)	Ø 28.58(1-1/8)	Ø 15.88(5/8)	not increased	Ø 15.88(5/8)	not increased
16	Ø 12.7(1/2)	Ø 28.58(1-1/8)	Ø 15.88(5/8)	Ø 31.8(1-1/4) *	Ø 15.88(5/8)	not increased
18 ~ 22	Ø 15.88(5/8)	Ø 28.58(1-1/8)	Ø 19.05(3/4)	Ø 31.8(1-1/4) *	Ø 19.05(3/4)	not increased
24	Ø 15.88(5/8)	Ø 34.9(1-3/8)	Ø 19.05(3/4)	not increased	Ø 19.05(3/4)	not increased
26 ~ 34	Ø 19.05(3/4)	Ø 34.9(1-3/8)	Ø 22.2(7/8)	Ø 38.1(1-1/2) *	Ø 22.2(7/8)	not increased
36 ~ 60	Ø 19.05(3/4)	Ø 41.3(1-5/8)	Ø 22.2(7/8)	not increased	Ø 22.2(7/8)	not increased
62 ~ 64	Ø 22.2(7/8)	Ø 41.3(1-5/8)	Ø 25.4(1) *	Ø 53.98(2-1/8)	Ø 25.4(1) *	not increased
66 ~ 104	Ø 22.2(7/8)	Ø 53.98(2-1/8)	Ø 25.4(1) *	not increased	Ø 25.4(1) *	not increased

Note

- * : If available on site, select pipe size from the pipe diameter table according to capacity. Otherwise it doesn't need to be increased.
- Model line up could be different in accordance with target region.

7. Refrigerant piping system

■ Refrigerant pipe diameter from branch to branch (B,C,D)

Downward Indoor Unit total capacity [kW(Btu/h)]	Liquid pipe [mm(inch)]	Gas pipe [mm(inch)]
≤ 5.6(19,100)	Ø6.35(1/4)	Ø12.7(1/2)
< 16.0(54,600)	Ø9.52(3/8)	Ø15.88(5/8)
< 22.4(76,400)	Ø9.52(3/8)	Ø19.05(3/4)
< 33.6(114,700)	Ø9.52(3/8)	Ø22.2(7/8)
< 50.4(172,000)	Ø12.7(1/2)	Ø28.58(1-1/8)
< 67.2(229,300)	Ø15.88(5/8)	Ø28.58(1-1/8)
< 72.8(248,400)	Ø15.88(5/8)	Ø34.9(1-3/8)
< 100.8(344,000)	Ø19.05(3/4)	Ø34.9(1-3/8)
< 173.6(592,500)	Ø19.05(3/4)	Ø41.3(1-5/8)
< 184.8(630,700)	Ø22.2(7/8)	Ø41.3(1-5/8)
≤ 291.2(993,600)	Ø22.2(7/8)	Ø53.98(2-1/8)

■ Conditional Application (only for Y Branch method)

If the below conditions are satisfied, limit of longest pipe length after 1st branch(*l*) could be extended by 40 m → 90 m.

1. Pipe diameter Size Up

Pipe diameter(Liquid/Gas pipes) between 1st branch ↔ last branch(B,C,D) is increased by on step.

If the pipe diameter of B,C,D is same as A, it is not necessary.

: Ø 6.35 → Ø 9.52 → Ø 12.7 → Ø 15.88 → Ø 19.05 → Ø 22.2 → ...

If available on site, select pipe size from the pipe diameter table according to capacity.

Otherwise it doesn't need to be increased.

2. Correction for calculating the total pipe length

When calculating total pipe length, pipe B,C,D length should be calculated twice.

: $A+Bx2+Cx2+Dx2+a+b+c+d+e \leq 1,000$ m

3. Indoor unit pipe length

Length of pipe from each indoor unit to the closest branch (a, b, c, d, e) ≤ 40 m.

4. Difference in length between outdoor unit and the farthest or closest indoor unit

[Length of pipe from outdoor unit to the farthest indoor unit 5 (A + B + C + D + e)]

- [Length of pipe from outdoor unit to the closest indoor unit 1 (A + a)] ≤ 40 m

5. After 1st branch directly connected indoor unit

When installing pipe(a) of Indoor unit directly connected after 1st branch more than 40m and less than 90m,

-Pipe diameter is increased by one step.

: Ø 6.35 → Ø 9.52 → Ø 12.7 → Ø 15.88 → Ø 19.05 → Ø 22.2 → ...

-Pipe length should be calculated twice.

: $A+Bx2+Cx2+Dx2+ax2+b+c+d+e \leq 1,000$ m

7. Refrigerant piping system

Outdoor unit Connection

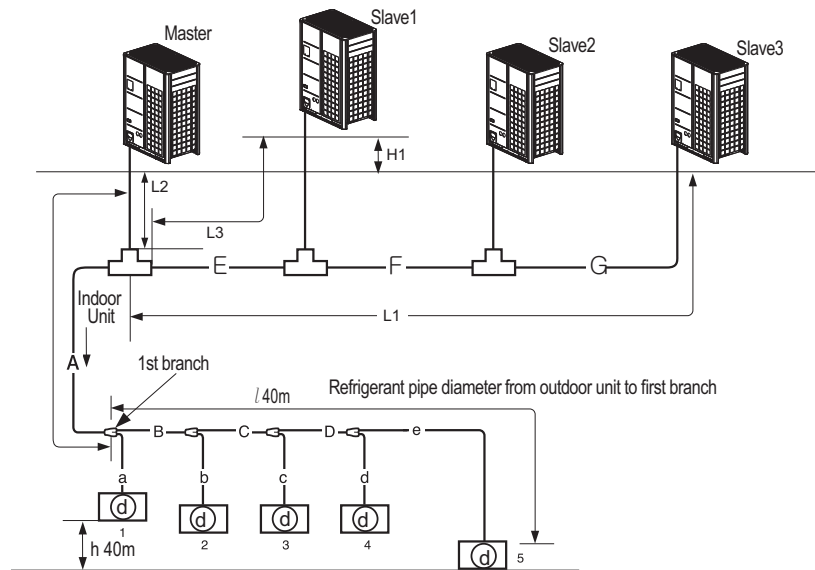

* Maximum number of connectable units could be different in accordance with model line up of target region.

A : Refrigerant pipe diameter from outdoor unit to first branch

E : Refrigerant pipe diameter for outdoor unit capacity (Slave 1+ Slave 2+ Slave 3)

F : Refrigerant pipe diameter for outdoor unit capacity (Slave 2+ Slave 3)

G : Refrigerant pipe diameter for outdoor unit capacity (Slave 3)

Level Difference (Outdoor unit ↔ Outdoor unit)	5m
Max length from first branch to each outdoor unit (L1, L2, L3)	Less than 10m (equivalent length of piping 13m)

⚠ WARNING

- In case of pipe diameter connected after first branch(B) is bigger than the main pipe diameter(A), B should be of the same size with A.
- Do not choose the main pipe diameter by downward indoor unit total capacity, but its outdoor unit model name.
- Do not let the connection pipe from branch to branch exceed the main pipe diameter chosen by outdoor unit model name.

[Example 1] In case indoor unit combination ratio 120% is connected to 24HP(67.2 kW) outdoor unit.

1. Outdoor unit main pipe diameter A : Ø34.9(Gas pipe), Ø15.88(liquid pipe)
2. Pipe diameter B after first branch according to 120% indoor unit ombination(80.6kW) : Ø34.9(gas pipe), Ø19.05(liquid pipe)

Therefore, pipe diameter B connected after first branch would be Ø34.9(gas pipe) / Ø15.88(liquid pipe) which is same with main pipe diameter.

[Example 2] Where connecting the indoor units to the 22 HP (61.6 kW) outdoor unit to 130% of its system capacity (80.1kW) and branching 7k (2.2kW) indoor unit at the 1st branch.

1. Main pipe diameter(22 HP outdoor unit): Ø28.58(gas pipe), Ø15.88(Liquid pipe)
2. Pipe diameter between 1st and 2nd branch (77.9kW indoor units) : Ø34.9(Gas pipe), Ø19.05(Liquid pipe) in conformity with downward indoor units.

Since the main pipe diameter of 22HP outdoor unit is Ø28.58(gas pipe), Ø15.88(Liquid pipe) is used as the main pipe and the connection pipe between 1st and 2nd branch.

7. Refrigerant piping system

7.2 Indoor Unit Connection

◆ Indoor Unit connecting pipe from branch (a, b, c, d, e, f)

Indoor Unit capacity [kW(Btu/h)]	Liquid pipe [mm(inch)]	Gas pipe [mm(inch)]
≤ 5.6(19,100)	Ø6.35(1/4)	Ø12.7(1/2)
< 16.0(54,600)	Ø9.52(3/8)	Ø15.88(5/8)
< 22.4(76,400)	Ø9.52(3/8)	Ø19.05(3/4)
≤ 28.0(95,900)	Ø9.52(3/8)	Ø22.2(7/8)

⚠ CAUTION

- Bending radius should be at least twice the diameter of the pipe.
- Bend pipe after 500mm or more from branch(or header).
Do not bend U type.
It may affect performance or result in noise.
If U type bending is required, the R should be more than 200mm.

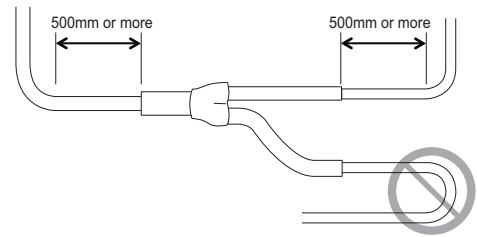

7. Refrigerant piping system

7.3 Pipe Connection Method/Precautions for Series connections between Outdoor units

- Separate Y branch joints are needed for series connections between outdoor units.
- Please refer to the below connection examples to install pipe connections between outdoor units.

7.3.1 Pipe connection between outdoor units (General Case)

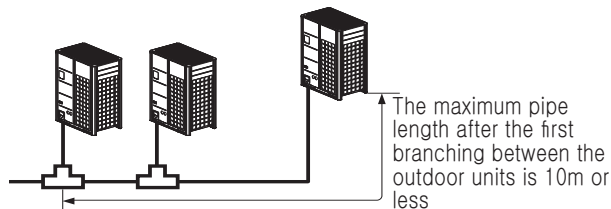

7.3.2 Pipes between outdoor units are 2m or less

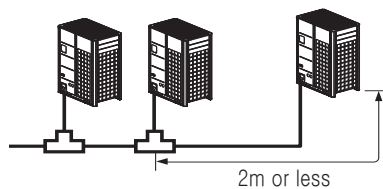

7.3.3 Pipes between outdoor units are 2m or longer

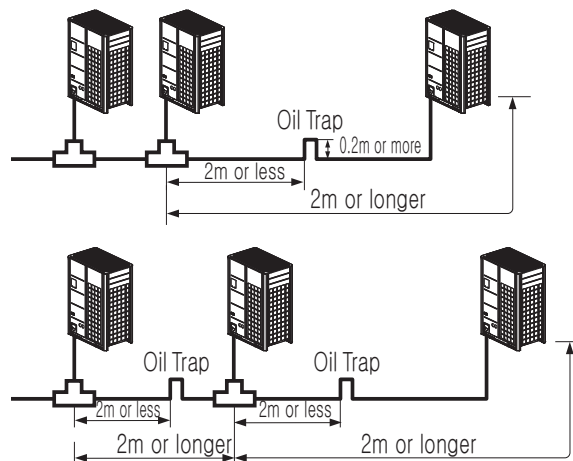

- If the distance between the outdoor units becomes more than 2m, apply Oil Traps between the gas pipes.
- If the outdoor unit is located lower than the main pipe, apply Oil Trap.

7. Refrigerant piping system

7.3.4 Examples of Wrong Pipe Connections

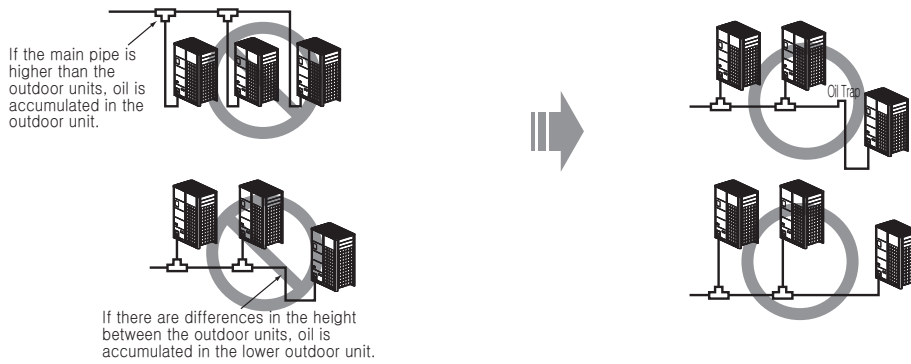

- The pipes between the outdoor units must maintain horizontal levelness or give an inclination to prevent a back flow toward the slave outdoor unit. Otherwise, the unit may not operate properly.

(Example 1)



(Example 2)



(Example 3)



- Apply Oil Trap as shown below when the length of the pipe between the outdoor units is more than 2m. Otherwise, the unit may not operate properly.

(Example 1)

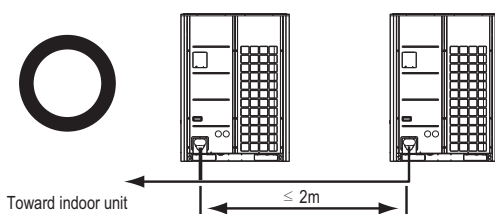

7. Refrigerant piping system

(Example 2)

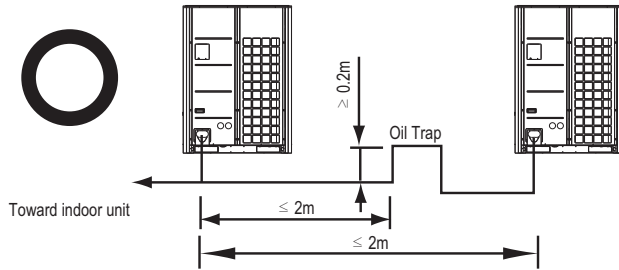

- Install Oil trap if the ODU is at lower level than main piping.
- When connecting the pipes between the outdoor units, the accumulation of oil in the slave outdoor unit should be avoided. Otherwise, the unit may not operate properly.

(Example 1)



(Example 2)

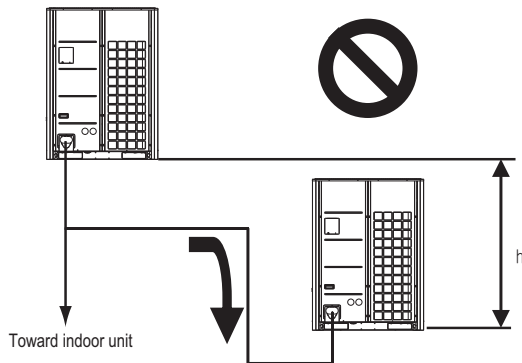

(Example 3)

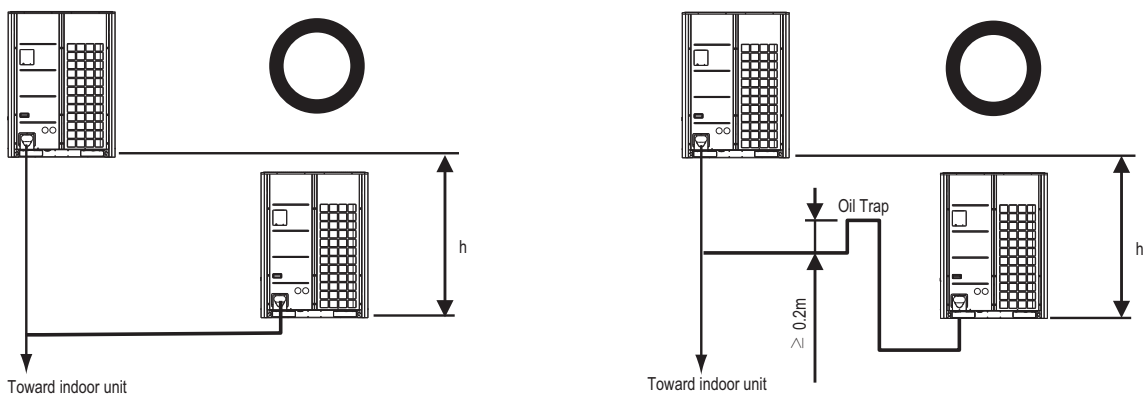

7. Refrigerant piping system

7.4 The amount of Refrigerant

The calculation of the additional charge should take into account the length of pipe and CF(correctionFactor) value of indoor unit.

Additional charge(kg)	=	Total liquid pipe : Ø25.4 mm	×	0.480(kg/m)
	+	Total liquid pipe : Ø22.2 mm	×	0.354(kg/m)
	+	Total liquid pipe : Ø19.05 mm	×	0.266(kg/m)
	+	Total liquid pipe : Ø15.88 mm	×	0.173(kg/m)
	+	Total liquid pipe : Ø12.7 mm	×	0.118(kg/m)
	+	Total liquid pipe : Ø9.52 mm	×	0.061(kg/m)
	+	Total liquid pipe : Ø6.35 mm	×	0.022(kg/m)
	+	Number of installed HR units(2,3,4port)	×	0.500(kg)
	+	Number of installed HR units(6,8port)	×	1.000(kg)
	+	CF value of indoor unit(kg/EA)		

Note

For CF value (additional refrigerant) table of indoor units, please refer to th PDB of indoor unit.

7. Refrigerant piping system

7.5 Selection of Y Branch and Header

7.5.1 Y Branch

■ Heat Pump System

Models	Gas pipe [unit:mm]	Liquid pipe [unit:mm]
ARBLN01621		
ARBLN03321		
ARBLN07121		
ARBLN14521		
ARBLN23220		

7. Refrigerant piping system

7.5.2 Header

Models	Gas pipe [unit:mm]	Liquid pipe [unit:mm]
4 branch ARBL054		
7 branch ARBL057		
4 branch ARBL104		
7 branch ARBL107		
10 branch ARBL1010		
10 branch ARBL2010		

7. Refrigerant piping system

7.6 Distribution Method

7.6.1 Horizontal Distribution

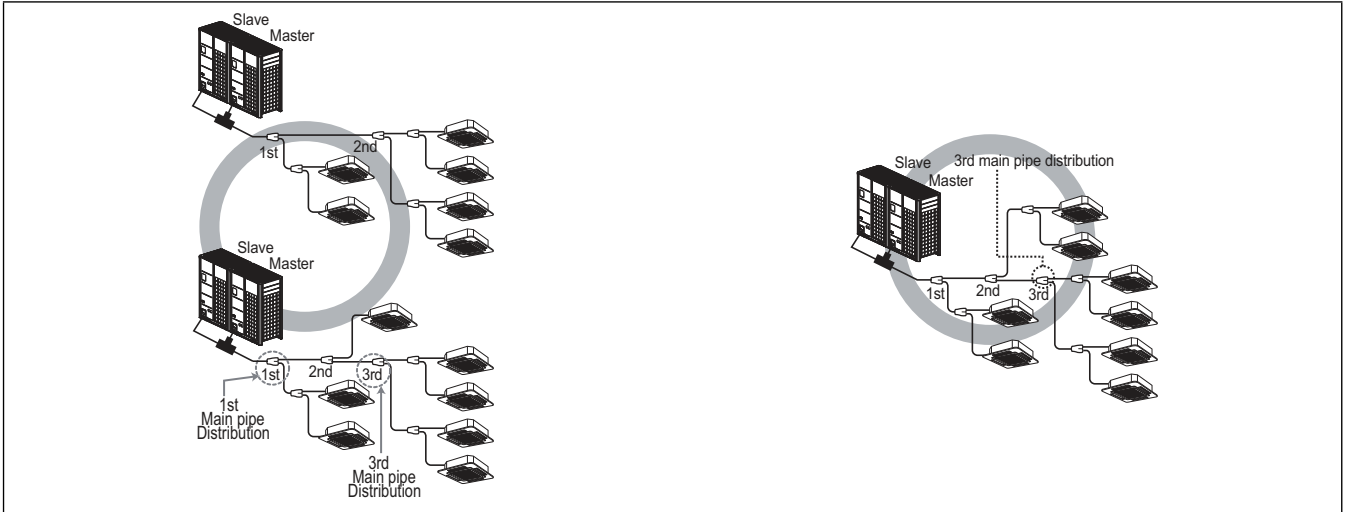

7.6.2 Vertical Distribution



7.6.3 The Others

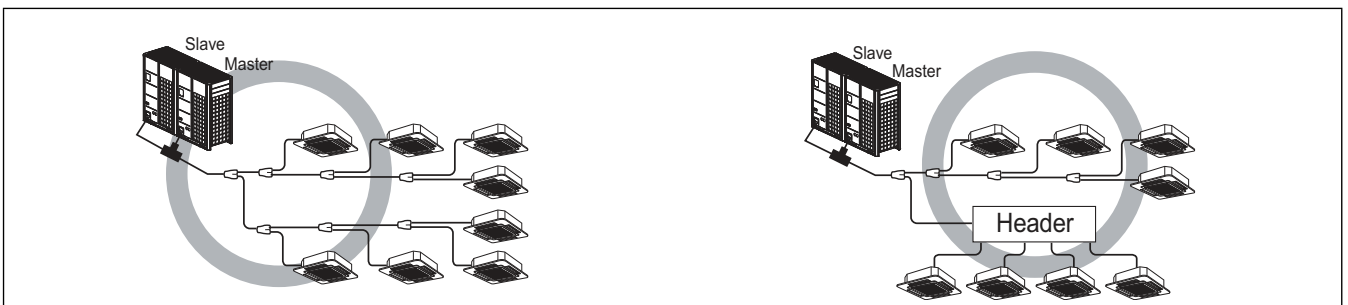

8. Electrical Wiring

8.1 Electrical Wiring

8.1.1 Caution

1. Follow ordinance of your governmental organization for technical standard related to electrical equipment, wiring regulations and guidance of each electric power company.

CAUTION

Be sure to have authorized electrical engineers do the electric work using special circuits in accordance with regulations and this installation manual. If power supply circuit has a lack of capacity or electric work deficiency, it may cause an electric shock or fire.

2. Install the Outdoor Unit communication line away from the power source wiring so that it is not affected by electric noise from the power source. (Do not run it through the same conduit.)
3. Be sure to provide designated grounding work to Outdoor Unit.

CAUTION

Be sure to correct the outdoor unit to earth. Do not connect earth line to any gas pipe, liquid pipe, lightning rod or telephone earth line. If earth is incomplete, it may cause an electric shock.

4. Give some allowance to wiring for electrical part box of Indoor and Outdoor Units, because the box is sometimes removed at the time of service work.
5. Never connect the main power source to terminal block of communication line. If connected, electrical parts will be burnt out.
6. Use 2-core shield cable for communication line. (O mark in the figure below) If communication lines of different systems are wired with the same multiple-core cable, the resultant poor transmitting and receiving will cause erroneous operations. (⊗ mark in the figure below)
7. Only the communication line specified should be connected to the terminal block for Outdoor Unit communication.

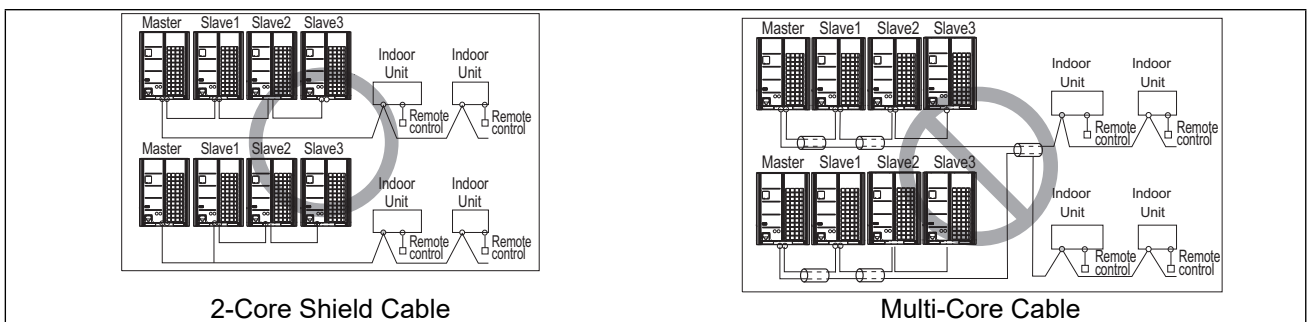

* The above System is representative Multi V 5 System. Actual combination of outdoor unit may be different by product line-up of region.

CAUTION

- Use the 2-core shield cables for communication lines. Never use them together with power cables.
- The conductive shielding layer of cable should be grounded to the metal part of both units.
- Never use multi-core cable
- As this unit is equipped with an inverter, to install a phase leading capacitor not only will deteriorate power factor improvement effect, but also may cause capacitor abnormal heating. Therefore, never install a phase leading capacitor.
- Make sure that the power unbalance ratio is not greater than 2%. If it is greater the units lifespan will be reduced.

8. Electrical Wiring

■ Precautions when laying power wiring

Use round pressure terminals for connections to the power terminal block.

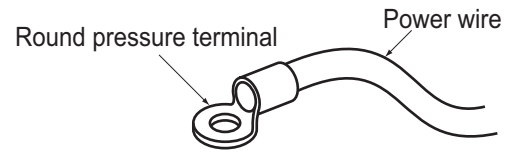

When none are available, follow the instructions below.

- not connect wiring of different thicknesses to the power terminal block. (Slack in the power wiring may cause abnormal heat.)
- When connecting wiring which is the same thickness, do as shown in the figure below.

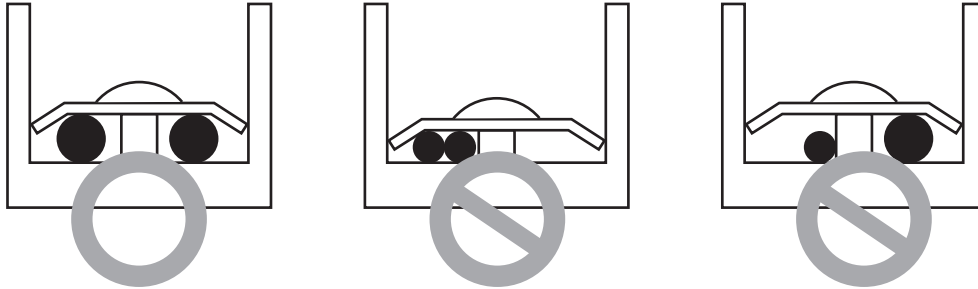

- For wiring, use the designated power wire and connect firmly, then secure to prevent outside pressure being exerted on the terminal block.
- Use an appropriate screwdriver for tightening the terminal screws. A screwdriver with a small head will strip the head and make proper tightening impossible.
- Over-tightening the terminal screws may break them.

⚠ CAUTION

When the 400 volt power supply is applied to "N" phase by mistake, replace inverter PCB and transformer in control box.

8. Electrical Wiring

8.1.2 Control box and connecting positioning of wiring

- Remove all of the screws at front panel and remove the panel by pulling it forward.

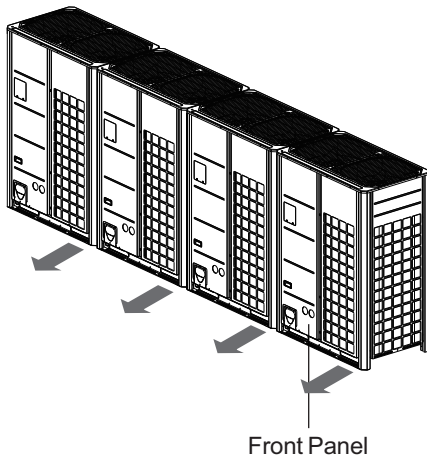

- Connect communication line between main and sub outdoor unit through the terminal block.
- Connect communication lines between outdoor unit and indoor units through the terminal block.
- When the central control system is connected to the outdoor unit, a dedicated PCB must be connected between them.
- When connecting communication line between outdoor unit and indoor units with shielded wire, connect the shield ground to the earth screw.

* Actual combination of outdoor unit may be different by product line-up of region.

WARNING

The temperature sensor for outdoor air should not be exposed to direct sunlight.

- Provide an appropriate cover to intercept direct sunlight.

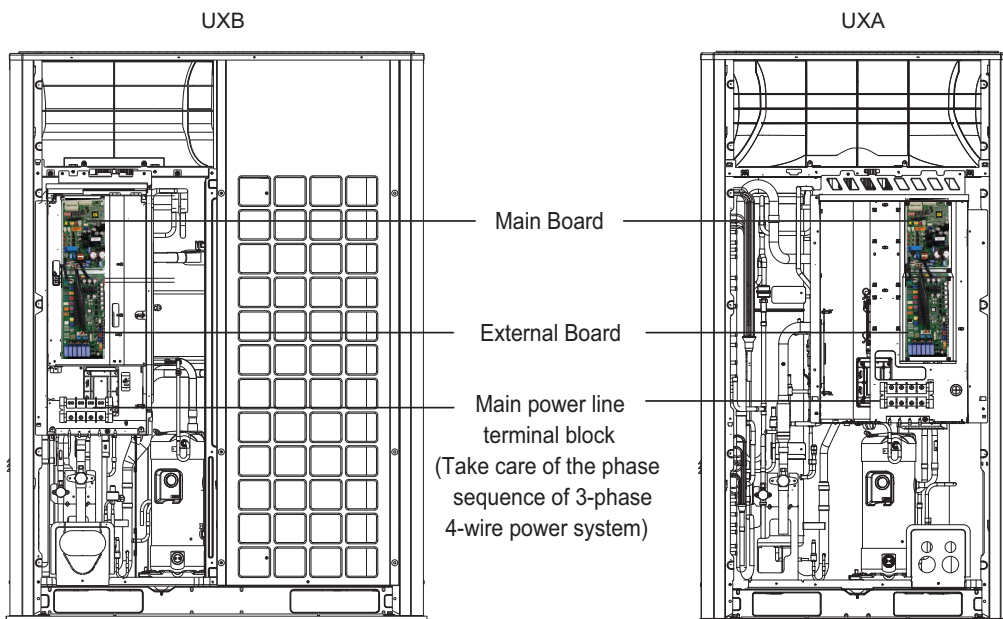

8. Electrical Wiring

8.1.3 Communication and Power Lines

1. Communication cable

- Types : shielded cables
- Use wires of size : over 1.0mm²
- Maximum allowable temperature: 60°C
- Maximum allowable line length: under 1,000m

2. Remote control cable

- Types : 3-core cable

3. Central control cable

Product type	Wire type	Diameter
ACP&AC Manager	2-core cables (shielded)	1.0~1.5mm ²
AC Smart	2-core cables (shielded)	1.0~1.5mm ²
Simple central controller	4-core cables (shielded)	1.0~1.5mm ²
AC Ez	4-core cables (shielded)	1.0~1.5mm ²

4. Separation of communication and power lines

- If communication and power lines are installed alongside each other then there is a strong likelihood of operational faults developing due to interference in the signal wiring caused by electrostatic and electromagnetic coupling.

The tables below indicates our recommendation as to appropriate spacing of communication and power lines where these are to be run side by side

Current capacity of power line	Spacing	
100V or more	10A	300mm
	50A	500mm
	100A	1,000mm
	Exceed 100A	1,500mm

Note

1. The figures are based on assumed length of parallel cabling up to 100m. For length in excess of 100m the figures will have to be recalculated in direct proportion to the additional length of line involved.
2. If the power supply waveform continues to exhibit some distortion the recommended spacing in the table should be increased.
 - If the lines are laid inside conduits then the following point must also be taken into account when grouping various lines together for introduction into the conduits
 - Power lines(including power supply to air conditioner) and signal lines must not be laid inside the same
 - In the same way, when grouping the lines power and signal lines should not be bunched together.

CAUTION

- If apparatus is not properly earthed then there is always a risk of electric shock, the grounding of the apparatus must be carried out by a qualified person.

8. Electrical Wiring

8.2 DIP Switch Setting

8.2.1 Checking according to dip switch setting

You can check the setting values of the Master outdoor unit from the 7 segment LED. The dip switch setting should be changed when the power is OFF.

8.2.2 Checking the setting of the Master unit

The number is sequentially appeared at the 7 segment in 5 seconds after applying the power. This number represents the setting condition.

- Initial display order

Order	No	Mean
①	8 ~ 26	Master model capacity
②	12 ~ 26	Slave 1 model capacity
③	12 ~ 26	Slave 2 model capacity
④	12 ~ 26	Slave 3 model capacity
⑤	8 ~ 104	Total capacity
⑥	2	Heat Pump
⑦	38	380V model
	46	460V model
	22	220V model
⑧	9	Product type

* In accordance with the number of combined outdoor unit or target region, it could not be applied to set the order ③, ④.

■ Master / Slave Dip Switch Setting

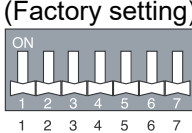
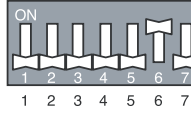
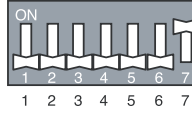
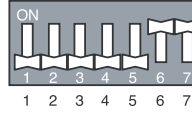
Dip switch setting	Master/Slave Unit			
	Master	Slave		
		Slave1	Slave2	Slave3
Heat Pump System (Factory setting)				

* In accordance with the number of combined outdoor unit or target region, Slave2 and Slave3 could not be applied to set.



CAUTION

Product may not properly operate if the relevant DIP switch is not properly setup.

8. Electrical Wiring

8.3 Automatic Addressing

■ The address of indoor units would be set by auto addressing

1. Wait for 3 minutes after supplying power. (Master and Slave outdoor units, indoor units)
2. Press RED button of the outdoor units for 5 seconds. (SW01C)
3. A "88" is indicated on 7-segment LED of the outdoor unit PCB.
4. For completing addressing, 2~7 minutes are required depending on numbers of connected indoor units
5. Numbers of connected indoor units whose addressing is completed are indicated for 30 seconds on 7-segment LED of the outdoor unit PCB
6. After completing addressing, address of each indoor unit is indicated on the wired remote control display window. (CH01, CH02, CH03,, CH06 : Indicated as numbers of connected wired indoor units)

◆ Main PCB

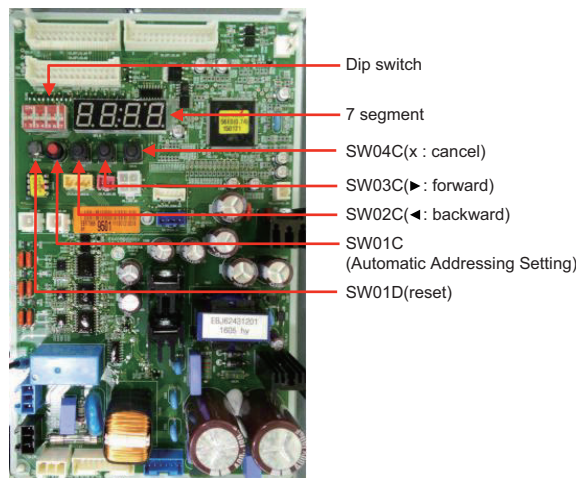

⚠ CAUTION

- In replacement of the indoor unit PCB, always perform Auto addressing setting again (At that time, please check about using Independent power module to any indoor unit.)
- If power supply is not applied to the indoor unit, operation error occur.
- Automatic Addressing has to be performed after more than 3 minutes to improve indoor unit communication when initial power is supplied.
- Please be sure that all the dip switch (except DIP switch 3) of master outdoor unit is OFF before Automatic Addressing setting.
 - Set the DIP switch 3 to "On" if all the indoor units are "ARN-4".
 - Set the DIP switch 3 to "Off" if not all the indoor units are "ARN-4".

8. Electrical Wiring

◆ The Procedure of Automatic Addressing

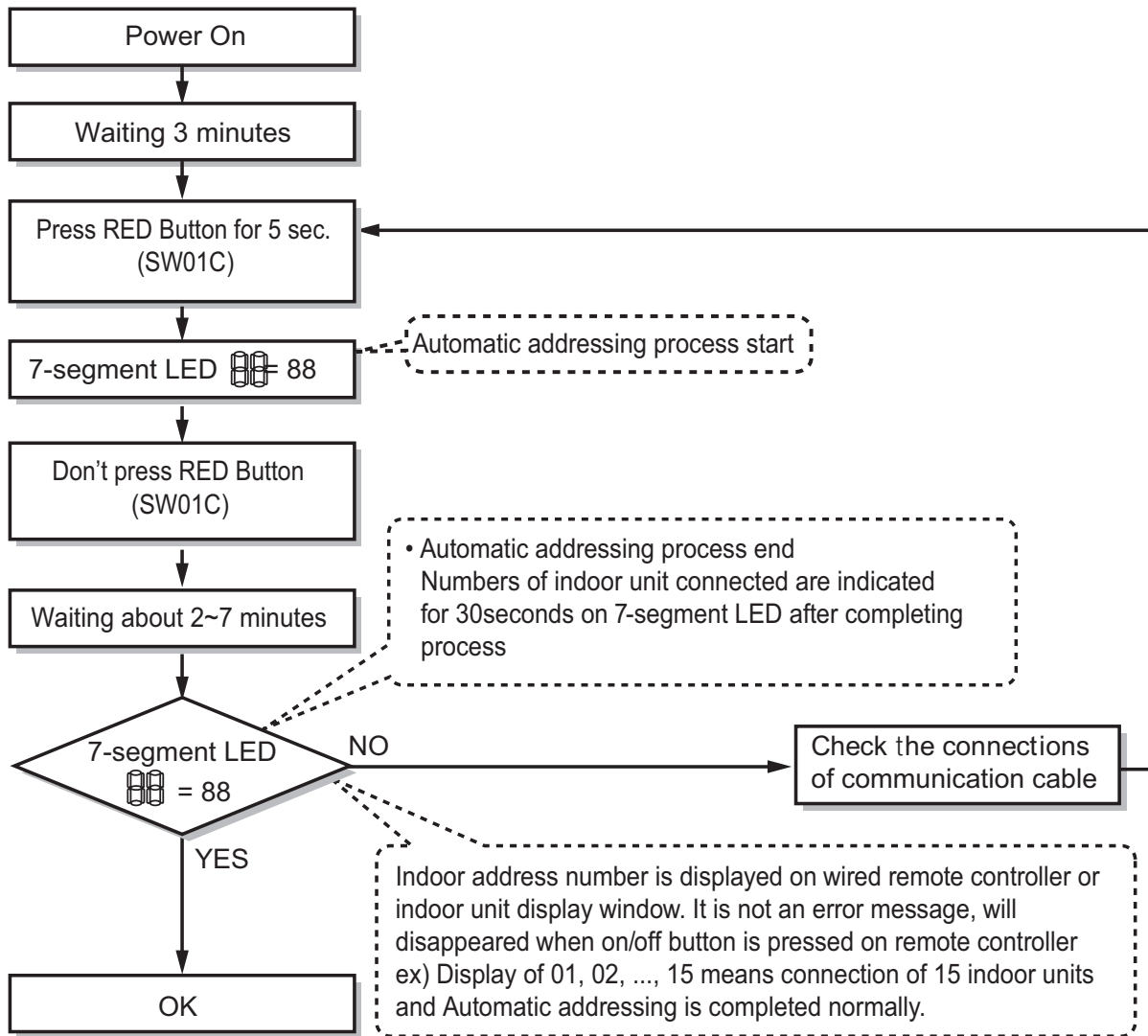

9. Setting the function

9.1 Function List

MODE	Display	Function	Description
Func	Fn1	Cool & Heat Selector	Set when Cool & Heat Selector is connected
	Fn2	Static pressure compensation	Function for increasing outdoor fan speed, when using duct's
	Fn3	Night low noise	In the middle of the night time, reduces the Fan rpm to reduce the noise from the outdoor unit fan
	Fn4	Overall defrost	Set for only using Overall Defrost (not applying Partial Defrost)
	Fn5	ODU address	Address for monitoring cycle view with LG control solutions
	Fn6	Snow removal & rapid defrost	Function for snow removal and rapid defrost function
	Fn7	IDU capacity adjusting	Decrease airflow of IDU in case of shortage of heating capacity
	Fn8	Target pressure adjusting	Adjust High/Low pressure target
	Fn9	Low Ambient Kit	Function for controlling Low Ambient Kit I/O Module *Low Ambient Kit : Kit for cooling operation at low temperature(-20℃)
	Fn10	High Efficiency Mode (Cooling Operation)	Adjust low pressure target according to outdoor temperature
	Fn11	Auto Dust Removal	Function for blowing dust on heat exchanger
	Fn12	Compressor frequency limitation	Max compressor frequency limitation
	Fn13	ODU fan limitation	Max fan RPM limitation
	Fn14	Smart load control	Adjust high pressure target for heating and low pressure target for cooling according to outdoor temperature to optimize energy input.
	Fn16	Humidity Reference	Adjust high pressure target according to humidity to optimize energy input
	Fn19	Central Control Connection at Indoor Unit side	For AC EZ use only. Connectable to comm. Line between ODU and IDU. * Do not use with other central controller (ACP, AC SAMART etc.)
	Fn20	Compressor Input Current Limit	Max input current limitation. 50~100% can be selected
	Fn21	Power Consumption Display on wired remote controller	Display Power Consumption on wired remote controller
	Fn22	Overall Defrost Operating in Low temperature (Heating)	Perform overall defrost periodically in low temperature to increase heating performance
	Fn23	Optional Base panel Heater	Set when base panel heater is installed

* The functions shown in the table above could be applicable depending on the model line up.

* For details, refer to installation manual and service manual(General).

9. Setting the function

9.2 Dip Switch Setting

Select the mode/function/option/value using '▶', '◀' Button and confirm that using the '●' button after dip switch No.5 is turned on.

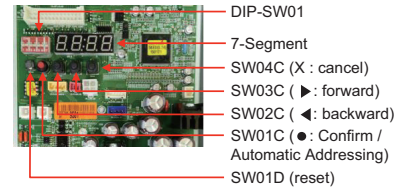
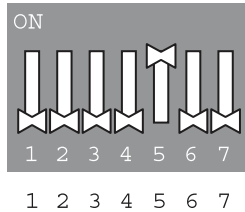

Optional Mode Selection		Function Selection		Option Selection		Remarks
Content	Display (◎)	Content	Display (◀, ▶ ◎)	Default	Optional (◀, ▶ ◎)	
FDD	Fdd	Automatic Refrigerant Charging (Cooling)	Fd1	-	-	-
		Automatic Refrigerant Charging (Heating)	Fd2	-	-	-
		Refrigerant Amount Check (Cooling)	Fd3	-	-	-
		Refrigerant Amount Check (Heating)	Fd4	-	-	-
		Automatic	Fd7	-	-	-
		All IDU operation (Cooling)	Fd8	-	-	Compulsory Operation
		All IDU operation (Heating)	Fd9	-	-	for 1hour
Installation	Func	Cool & Heat Selector	Fn 1	oFF	oFF, oP1~oP2	save in EEPROM
		High Static Pressure compensation	Fn 2	oFF	oFF, oP1~oP7	save in EEPROM
		Night low noise	Fn 3	oFF	oFF, oP1~oP12	save in EEPROM
		Overall Defrost	Fn 4	North America : oFF Europe : oFF Tropical : oN	on, oFF	save in EEPROM
		ODU Addressing	Fn 5	0	0~255	save in EEPROM
		Snow Removal & Rapid Defrost	Fn 6	oFF	oFF, oP1~oP3	save in EEPROM
		Capacity Up Airflow Adjusting for IDU (Heating)	Fn 7	oFF	on, oFF	save in EEPROM
		Target Pressure Adjusting	Fn 8	oFF	oFF, oP1~oP6	save in EEPROM
		Low Ambient Kit	Fn 9	oFF	on, oFF	save in EEPROM
		High Efficiency Mode (Cooling Operation)	Fn 10	oFF	on, oFF	save in EEPROM
		Auto Dust Removal Mode	Fn 11	oFF	oFF, oP1~oP5	save in EEPROM
		Compressor Max. Frequency Limit	Fn 12	oFF	oFF, oP1~oP9	save in EEPROM
		ODU Fan Max. RPM Limit	Fn 13	oFF	oFF, oP1~oP7	save in EEPROM
		Smart Load Control	Fn 14	oFF	oFF, oP1~oP3	save in EEPROM
		Humidity Reference	Fn 16	on	on, oFF	save in EEPROM
Compressor Input Current Limit	Fn 20	oFF	oFF, oP1~oP10	save in EEPROM		
Optional Base panel Heater	Fn 23	oFF	on, oFF	save in EEPROM		
Service	SvC	Vacuum mode	SE3	vACC	-	1time / 1 Selection
User	Idu	Continuous Cooling	Id10	EACH	-	save in EEPROM

- Functions "save in EEPROM" will be kept continuously, though the system power was reset.
- For detail information about SVC and IDU setting functions, refer to the installation manual or SVC manual.
- The Functions could be different in accordance with model line up of target region.

9. Setting the function

9.3 Night Low Noise Function

In cooling mode, this function makes the ODU fan operate at low RPM to reduce the fan noise of ODU at night which has low cooling load.

◆ Night low noise function setting method

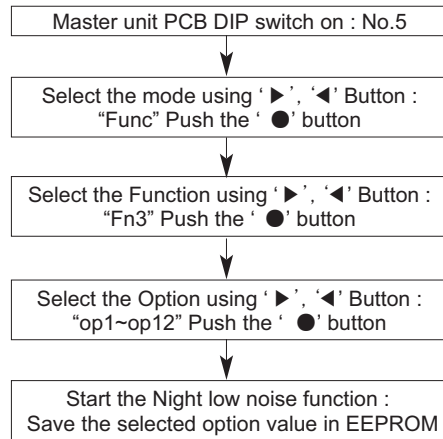

◆ Time Settings

Step	Judgment Time(Hr)	Operation Time(Hr)
op1	8	9
op2	6.5	10.5
op3	5	12
op4	8	9
op5	6.5	10.5
op6	5	12
op7	8	9
op8	6.5	10
op9	5	12
op10	Continuous operation	
op11	Continuous operation	
op12	Continuous operation	

◆ Noise

Capacity	8 ~ 14HP	16 ~ 22 HP	24 ~ 26 HP
Step	Noise(dB(A))		
op1 ~ op3, op10	55	59	60
op4 ~ op6, op11	52	56	57
op7 ~ op9, op12	49	53	55

* The Capacity of unit could be different in accordance with model line up of target region.

⚠ CAUTION

- Request installer to set the function during installation.
- If ODU RPM changes, cooling capacity may go down.

MULTI VTM **5**

Special Guide

- 1. Cautions for Refrigerant Leaks**
- 2. Guide for installing at seaside**

1. Caution For Refrigerant Leaks

The installer and system specialist shall secure safety against leakage according to local regulations or standards. The following standards may be applicable if local regulations are not available.

1.1 Introduction

Though the R410A refrigerant is harmless and incombustible itself, the room to equip the air conditioner should be large to such an extent that the refrigerant gas will not exceed the limiting concentration even if the refrigerant gas leaks in the room.

1.1.1 Concentration limit

Concentration limit is the limit of Freon gas concentration where immediate measures can be taken without hurting human body when refrigerant leaks in the air. The concentration limit shall be described in the unit of kg/m³ (Freon gas weight per unit air volume) for facilitating calculation.

Concentration limit : 0.44kg/m³(R410A)

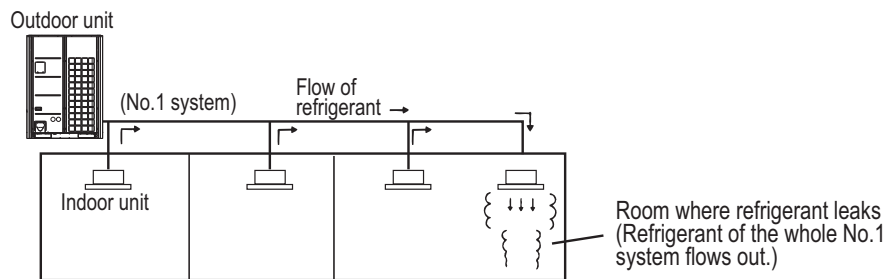

1.2 Checking procedure of limiting concentration

Check concentration limit along following steps and take appropriate measure depending on the situation.

1.2.1 Calculate amount of all the replenished refrigerant (kg) per each refrigerant system.

Amount of pre-charged refrigerant per single system

+

Amount of additional replenished refrigerant

=

Total amount of refrigerant in the system (kg)

Amount of replenished refrigerant at factory shipment

Amount of additionally replenished refrigerant depending on piping length or piping diameter by customer

Note : In case one refrigerant facility is divided into 2 or more refrigerant systems and each system is independent, amount of replenished refrigerant of each system shall be adopted.

1. Caution For Refrigerant Leaks

1.2.2 Calculate refrigerant concentration level

Calculate the volume of the room where indoor unit is installed as single room or the smallest room.

1. Without partition

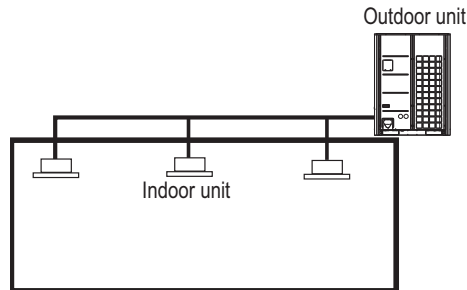

2. With partition but opened which serve passage of air to adjoining room

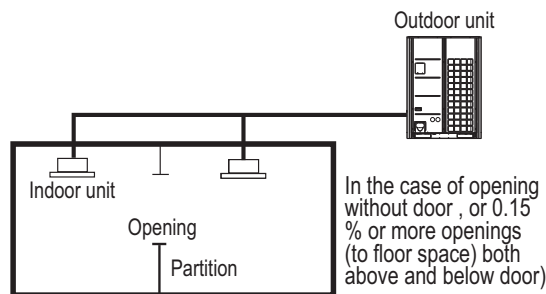

3. With partition and without opening which serve as passage of air to adjoining room

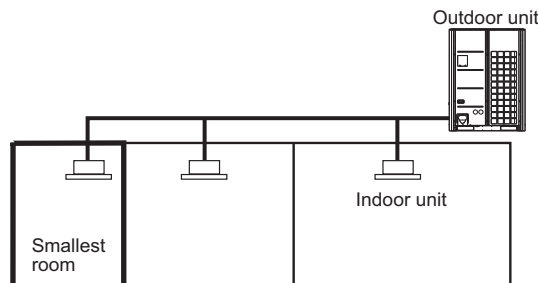

◆ Calculate refrigerant concentration

$$\frac{\text{Total amount of refrigerant system (kg)}}{\text{Volume of smallest room where indoor unit is installed (m}^3\text{)}} \leq$$

$$\begin{matrix} \text{Maximum concentration} \\ \text{limit} \\ | \\ \text{(kg/m}^3\text{)} \\ \text{(R410A)} \end{matrix}$$

In case the result of calculation exceeds the concentration limit, perform the same calculations by shifting to the second smallest, and the third smallest rooms until at last the result is below the concentration limit.

1. Caution For Refrigerant Leaks

◆ In case the concentration exceeds the limit

When the concentration exceeds the limit, change original plan or take one of the counter measure shown below:

- **Counter measure 1**
Provide opening for ventilation.
Provide 0.15% or more size of opening to floor space both above and below door, or provide opening without door.
- **Counter measure 2**
Provide gas leak alarm linked with mechanical ventilator.
- **Counter measure 3**
Reducing the system's refrigerant quantity by deviding into smaller separate system.

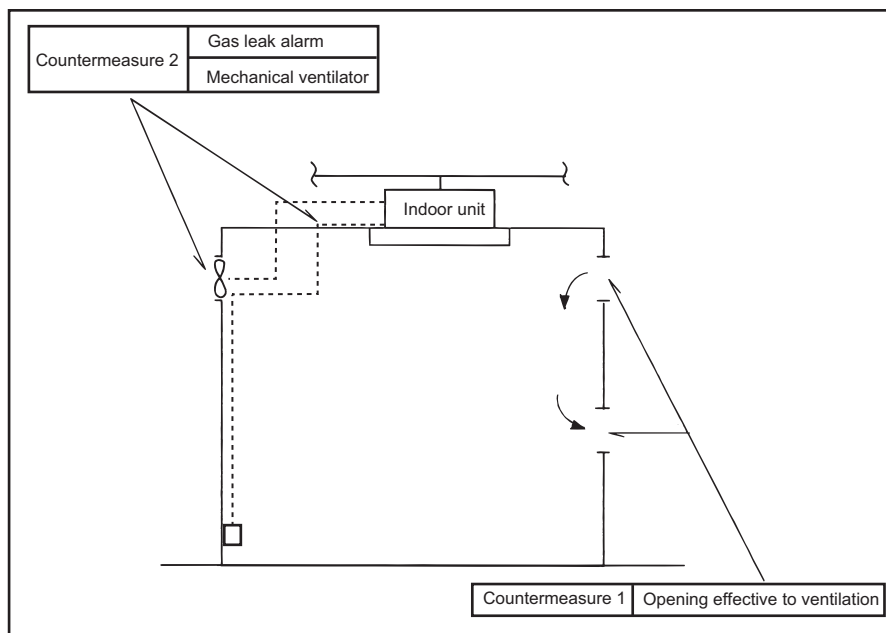

⚠ CAUTION

Pay a special attention to the place, such as a basement, etc. where refrigerant can stay, since refrigerant is heavier than air.

2. Guide for installing at seaside

⚠ CAUTION

1. Air conditioners must not be installed in areas where corrosive gases, such as acid or alkaline gas, are produced.
2. Avoid installing the product where it could be exposed to sea wind (salty wind) directly. It can result corrosion on the product. Corrosion, particularly on the condenser and evaporator fins, could cause product malfunction or inefficient operation.
3. If outdoor unit is installed close to the seaside, should avoid direct exposure to the sea wind.

2.1 Selecting the location(Outdoor Unit)

1. If the outdoor unit is to be installed close to the seaside, direct exposure to the sea wind should be avoided. Install the outdoor unit on the opposite side of the sea wind direction.

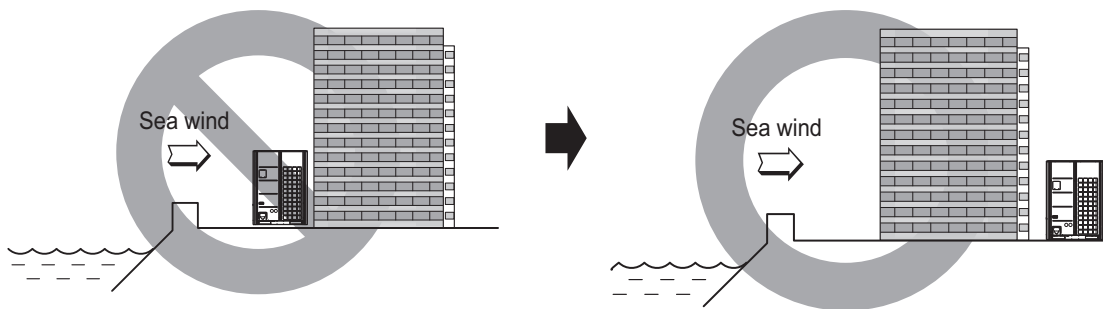

2. In case, to install the outdoor unit on the seaside, set up a windbreak not to be exposed to the sea wind.

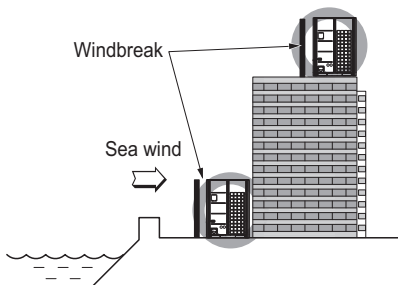

- It must be strong enough like concrete to prevent the sea wind from the sea.
- The height and width should be more than 150% of the outdoor unit.
- It must be kept more than 70 cm of distance between outdoor unit and the windbreak for smooth air flow.

3. Select a well-drained place.

⚠ CAUTION

Periodic (1 times per 6 months) cleaning of the dust or salt particles stuck on the heat exchanger is necessary by using clean water.

» If there is improper installation or maintenance not complying with the installation guide, product's performance and reliability is not guaranteed.

MULTI V™ **5**

Control System





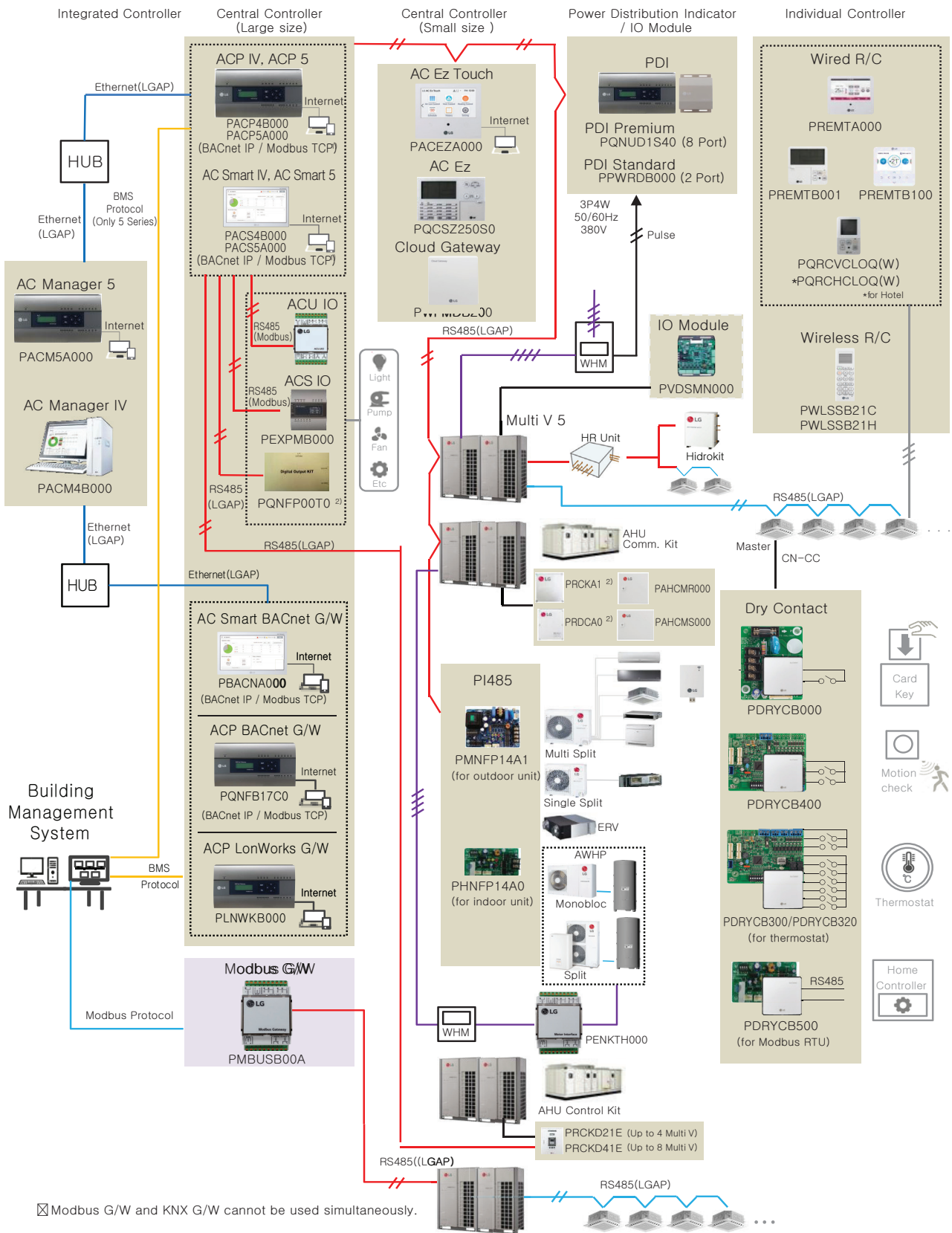

- 1. Solution Overview**
- 2. Control System List**
- 3. Function List**
- 4. Accessory Compatibility List**
- 5. Centralized Controller Compatibility List**

1. Solution Overview



- 1) It is available 5 series controllers (ACP5, AC Smart5) only.
- If you need more detail, please refer to the Control PDB or the manual of product. (<http://partner.lge.com/global> : Home> Doc.Library> Product > Control(BECON))

2. Control System List

Category	Controller name	Model name	Compatible Product	Dimensions (W x H x D, mm)	Feature
Individual controller	Premium Wired Remote Controller	PREMTA000(A/B) 	All IDU ERV ¹⁾ ERV DX	137 x 121 x 16.5	<ul style="list-style-type: none"> 5 inch color Display Touch Screen Group control (Max 16 indoor unit) Temp./Humid. sensing
	Standard Wired Remote Controller	PREMTB100 PREMTBB10 	All IDU ERV ¹⁾ ERV DX	120 x 120 x 16	<ul style="list-style-type: none"> 4.3 inch color Display Touch button Group control (Max 16 indoor unit) Temp./Humid. sensing 1 Digital Output available(on/off)
		PREMTB001 PREMTBB01 	All IDU ERV ¹⁾ ERV DX	120 x 120 x 16	<ul style="list-style-type: none"> 4.3 inch mono Display Hard button Group control (Max 16 indoor unit) 2-remote controller control Temp. sensing Basic / Advanced function* schedule function
	Simple Wired Remote Controller	PQRCVCL0Q(W) 	All IDU	120 x 64 x 15	<ul style="list-style-type: none"> 2.6 inch mono Display Hard button Group control (Max 16 indoor unit) 2-remote controller control Temp. sensing Basic function*
		PQRCHCA0Q(W) 	All IDU	120 x 64 x 15	<ul style="list-style-type: none"> 2.6 inch mono Display Hard button Group control (Max 16 indoor unit) 2-remote controller control Temp. sensing Basic function* (except mode change)
	Wireless Remote Controller	PQWRHQ0FDB 	All IDU	153 x 51 x 26	<ul style="list-style-type: none"> Heat Pump 2 inch mono Display Hard button Temp. sensing Basic function*
		PQWRCQ0FDB 	All IDU	153 x 51 x 26	<ul style="list-style-type: none"> Cooling Only 2 inch mono Display Hard button Temp. sensing Basic function*

- 1) ERV : Energy Recovery Ventilation
- * Basic/Advanced function refer [Function List /Individual Controller].
- If you need more detail, please refer to the Control PDB or the manual of product.
(<http://partner.lge.com/global> : Home> Doc.Library> Product > Control(BECON))

2. Control System List

Outline of system

1. Installation Method

12 V	Red
Signal	Yellow
GND	Black

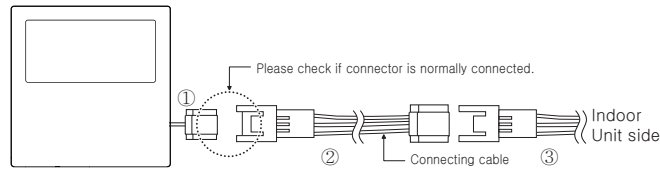

※ ① : AWG#24 / ②, ③ : AWG#22

⇒ The total cable length must not exceed 50m. (It can cause communication error.)

2. Group Control

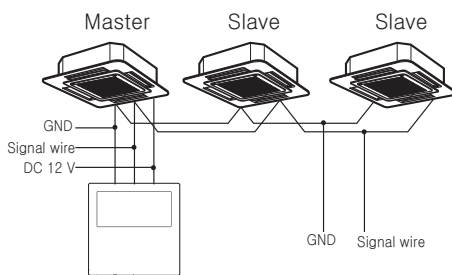

⇒ When controlling multiple indoor units with one remote controller, you must change the master/slave setting from the indoor unit.

3. 2-Remote Controller Control

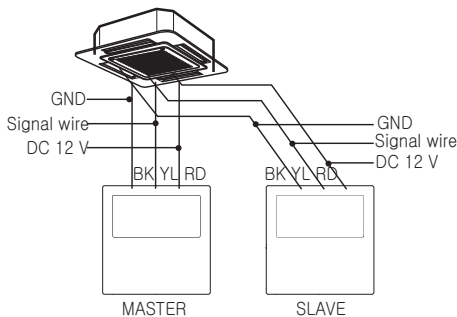

⇒ When installing more than 2 units of wired remote controller to one air conditioner, set one wired remote controller as master and the others all as slaves.

• 2-Remote Controller Control cable

- Model name : PZCWRC2
- Length : 0.25m

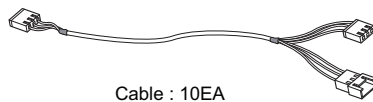

Cable : 10EA

• Extension cable

- Model name : PZCWRC1
- Length : 9.6m



Cable : 2EA

• Group Control cable

- Model name : PZCWRCG3
- Length : 0.25m

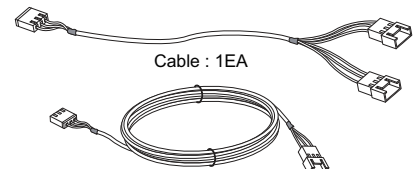







Cable : 1EA

Cable : 1EA

- If you need more detail, please refer to the Control PDB or the manual of product. (<http://partner.lge.com/global> : Home> Doc.Library> Product > Control(BECON))

2. Control System List

Category	Controller name	Model name	Compatible Product	Dimensions (W x H x D, mm)	Feature
Central controller	AC Manager 5	PACM5A000 	All IDU ERV ¹⁾ ERV DX Heating AHU Chiller*	270 x 155 x 65	<ul style="list-style-type: none"> • PC Access Controller • DC 12 V Adaptor • Max 8,192 indoor unit control (Supports 32 ACP IV or AC Smart IV) • Chrome(Recommended), Safari, Internet Explorer 11 support
	AC Manager IV	PACM4B000 	All IDU ERV ¹⁾ ERV DX Heating AHU Chiller*	-	<ul style="list-style-type: none"> • PC installation SW • Max 8,192 indoor unit control (Supports 32 ACP IV or AC Smart IV) • Windows XP/7/8/8.1/10 OS support
	ACP 5	PACP5A000 	All IDU ERV ¹⁾ ERV DX Heating AHU Chiller*	270 x 155 x 65	<ul style="list-style-type: none"> • PC Access Controller • DC 12 V Adaptor • Max 256 indoor unit control • RS-485 : 6 channels CH1~4 : indoor unit ²⁾ CH5 : LGAP(AHU) or Modbus(AHU, Chiller, ACS I/O) CH6 : Modbus(AHU, Chiller, ACS I/O) • DI 10EA, DO 4EA (DI1 : Emergency stop Only)
	ACP IV	PACP4B000 			
	ACP BACnet	PQNFB17C0 	All IDU ERV ¹⁾ ERV DX Heating AHU	270 x 155 x 65	<ul style="list-style-type: none"> • PC Access Controller • Max 256 indoor unit control • DC 12 V Adaptor • RS-485 : 6 channels CH1~4 : indoor unit ²⁾ CH5 : LGAP(AHU) CH6 : Modbus(AHU, Chiller, ACS I/O) • DI 10EA, DO 4EA (DI1 : Emergency stop Only) • BACnet IP Protocol Support • Modbus TCP Protocol Support • BTL Certified(B-ASC)
	ACP Lonworks	PLNWKB000 	All IDU ERV ¹⁾ ERV DX Heating AHU	270 x 155 x 65	<ul style="list-style-type: none"> • PC Access Controller • Max 64 indoor unit control • DC 12 V Adaptor • RS-485 : 6 channels Lon Comm. : 1 channel CH1~4 : indoor unit ²⁾ CH5 : LGAP(AHU) CH6 : Not use LON : Lon Talk • Lonworks Protocol Support

- 1) ERV : Energy Recovery Ventilation
- 2) Indoor unit : IDU, ERV, DX ERV, Hydro Kit, DO Kit
- * It needs to apply Chiller Option KIT.
- If you need more detail, please refer to the Control PDB or the manual of product.
(<http://partner.lge.com/global> : Home> Doc.Library> Product > Control(BECON))

2. Control System List

Outline of system

▶ When using a HUB, use Direct UTP Cable.

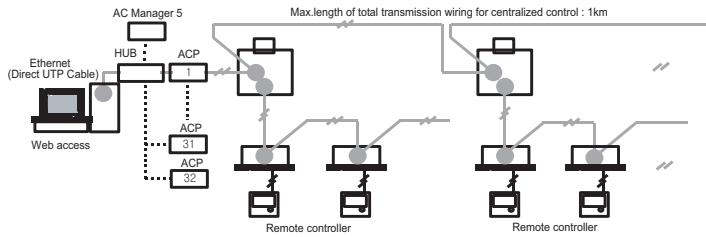

▶ When using a HUB, use Direct UTP Cable.

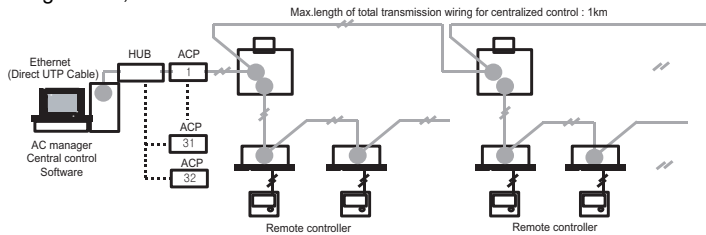

- Recommended PC Specifications for AC Manager IV
 - CPU : Dual Core 2.4GHz or faster
 - System Memory : 4 GB or more
 - Hard Disk Space : 100 GB or more
 - OS : Windows XP/7/8/8.1/10
 - Resolution : 1280 x 1024 or higher
 - Recommended Graphics: VGA: For NVidia, Geforce or later. For ATI, Radeon or later
 - ACP : ACP version 1.1.4p or higher

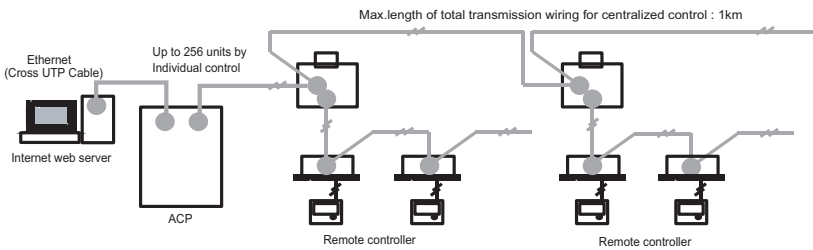

- Max. the number of connected node* in one RS485 Line : 32
- Communication cable
 - Types : shielding wire
 - Use wires of size : over 0.75 ~ 1.5 mm²
 - Max. allowable temperature of cable : 60 °C
 - Max. length of total transmission wiring (End to End) : 1 km

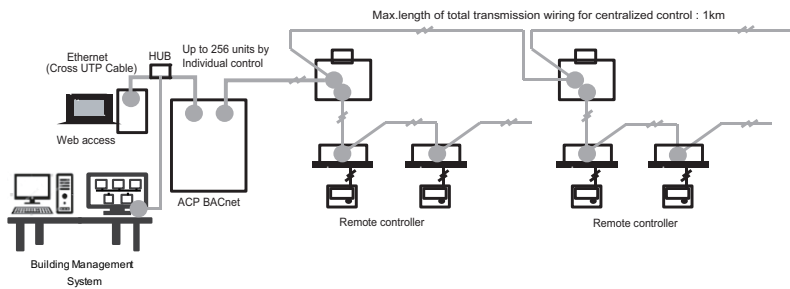



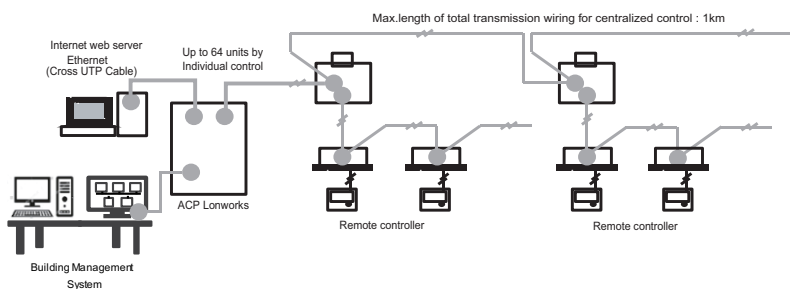



- Max. the number of connected node* in one RS485 Line : 32
- Communication cable
 - Types : shielding wire
 - Use wires of size : over 0.75 ~ 1.5 mm²
 - Max. allowable temperature of cable : 60 °C
 - Max. length of total transmission wiring (End to End) : 1 km

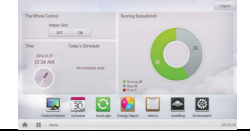

- Max. the number of connected node* in one RS485 Line : 32
- Communication cable
 - Types : shielding wire
 - Use wires of size : over 0.75 ~ 1.5 mm²
 - Max. allowable temperature of cable : 60 °C
 - Max. length of total transmission wiring (End to End) : 1 km

• * nodes : Central controller + (Multi V outdoor unit x 2) + Other PI 485 G/W ≤ 32 ea
 Ex) ACP 1ea + AC Smart Premium 2 ea + Multi V outdoor unit 6ea = 1 + 2 + (6 x 2) = 15 nodes
 • If you need more detail, please refer to the Control PDB or the manual of product.
 (<http://partner.lge.com/global> : Home> Doc.Library> Product > Control(BECON))

2. Control System List

Category	Controller name	Model name	Compatible Product	Dimensions (W x H x D, mm)	Feature
Central controller	AC Smart 5	PACS5A000 	All IDU ERV ¹⁾ ERV DX Heating AHU Chiller*	253.2 x 167.7 x 28.9	<ul style="list-style-type: none"> • 10.2 inch color Display • Touch Screen • DC 12 V Adaptor • Max 128 indoor unit control • RS-485 : 2 channels CH1 : <ul style="list-style-type: none"> - LGAP(AHU) or - Modbus(AHU, Chiller, ACS I/O) - Indoor unit ²⁾(AC Smart5 only³⁾) CH2 : Indoor unit ²⁾ • DI 2EA, DO 2EA
	AC Smart IV / AC Smart BACnet	PACS4B000 / PBACNA000 			
	AC Ez Touch	PACEZA000 	All IDU ERV ¹⁾ ERV DX Heating	137x 121 x 25	<ul style="list-style-type: none"> • 5inch color Display • Touch Screen • DC 12 V Adaptor • Max 64 indoor unit control • RS-485 : 1 channel • DI 1EA (Emergency stop Only)
	AC Ez	PQCSZ250S0 	All IDU ERV ¹⁾ ERV DX	190 x 120 x 20	<ul style="list-style-type: none"> • TN Mono Display & 18 LED • Button Control • DC 12 V • Max 32 indoor unit control • RS-485 : 1 channel
	PDI Premium	PQNUD1S40 	All IDU ERV DX Heating	[Controller] 270 x 155 x 65 [Power Module] 120 x 155 x 65	<ul style="list-style-type: none"> • EHP ODU 8EA(GHP 4EA) • 128 EHP Indoor Units (64 GHP Indoor Units) • AC 220~240 V Power Input • 8port Pulse Input
	PDI Standard	PPWRDB000 	All IDU ERV DX Heating	[Controller] 270 x 155 x 65 [Power Module] 120 x 155 x 65	<ul style="list-style-type: none"> • EHP ODU 2EA(GHP 1EA) • 128 EHP Indoor Units (64 GHP Indoor Units) • AC 220~240 V Power Input • 2port Pulse Input
	Cloud Gateway	PWFMDB200 	All IDU	120 x 120 x 29	<ul style="list-style-type: none"> • 12V DC • Max 16 indoor units • RS485 : 1 channel (LGAP) • Wired/Wireless LAN





- * It needs to apply Chiller Option KIT.
- 1) ERV : Energy Recovery Ventilation
- 2) Indoor unit : IDU, ERV, DX ERV, Heating
- 3) In case of using AC Smart IV or AC Smart BACnet, can't use CH1 for Indoor unit.
- If you need more detail, please refer to the Control PDB or the manual of product.
(<http://partner.lge.com/global> : Home> Doc.Library> Product > Control(BECON))

2. Control System List

Outline of system	
<p>Up to 128 units by individual control</p> <p>AC Smart IV</p> <p>Remote controller</p> <p>Remote controller</p> <p>Max. length of total transmission wiring for centralized control : 1km</p>	<ul style="list-style-type: none"> • Communication cable <ul style="list-style-type: none"> – Types : shielding wire – Use wires of size : over 0.75 ~ 1.5 mm² – Max. allowable temperature of cable : 60°C – Max. length of total transmission wiring (End to End) : 1 km
<p>Up to 64 units by individual control</p> <p>AC Ez Touch</p> <p>Remote controller</p> <p>Remote controller</p> <p>Max. length of total transmission wiring for centralized control : 1km</p>	<ul style="list-style-type: none"> • Communication cable <ul style="list-style-type: none"> – Types : shielding wire – Use wires of size : over 0.75 ~ 1.5 mm² – Max. allowable temperature of cable : 60°C – Max. length of total transmission wiring (End to End) : 1 km
<p>Up to 32 units by individual control</p> <p>AC Ez</p> <p>Remote controller</p> <p>Remote controller</p> <p>Max. length of total transmission wiring for centralized control : 1km</p>	<ul style="list-style-type: none"> • Communication cable <ul style="list-style-type: none"> – Types : shielding wire – Use wires of size : over 0.75 ~ 1.5 mm² – Max. allowable temperature of cable : 60°C – Max. length of total transmission wiring (End to End) : 1 km
<p>Power In single phase 220~240 V~, 50/60 Hz</p> <p>Power In 3 phase 4 wire 380~400 V~, 50/60 Hz</p> <p>Wattmeter</p> <p>RS485 (LGAP)</p> <p>Pulse signal</p> <p>Pulse signal</p> <p>(00) (01) (02) (03)</p> <p>(70) (71) (72) (73)</p> <p>AC Manager</p> <p>ACP</p> <p>RS485 (LGAP)</p>	<ul style="list-style-type: none"> • Communication cable <ul style="list-style-type: none"> – Types : shielding wire – Use wires of size : over 0.75 ~ 1.5 mm² – Max. allowable temperature of cable : 60°C – Max. length of total transmission wiring (End to End) : 1 km • Pulse cable <ul style="list-style-type: none"> – Types : shielding wire – Use wires of size : over 0.75 ~ 1.5 mm² – Max. allowable temperature of cable : 60°C – Max. length of total transmission wiring (End to End) : 10 m
<p>Up to 16 units by individual control</p> <p>Cloud Gateway</p> <p>Remote controller</p> <p>Remote controller</p> <p>Max. length of total transmission wiring for centralized control : 1km</p>	<ul style="list-style-type: none"> • Communication cable <ul style="list-style-type: none"> – Types : shielding wire – Use wires of size : over 0.75 ~ 1.5 mm² – Max. allowable temperature : 60°C – Max. length of total RS485 transmission wiring (End to End) : 1km

- * The maximum quantity of connected indoor unit is different depending on the quantity of connected I/O modules
- If you need more detail, please refer to the Control PDB or the manual of product. (<http://partner.lge.com/global> : Home> Doc.Library> Product > Control(BECON))

2. Control System List

Category	Controller name	Model name	Objective / Use	Dimensions (W x H x D, mm)	Feature
Interface Device	Dry Contract	PDRYCB000 PDRYCB100 	For Connect indoor unit to other forced on/off controller	120 x 120 x 36.5	<ul style="list-style-type: none"> • 1SET / 1 IDU • 1 Contact point • Input power AC 220V~240 V <ul style="list-style-type: none"> – PDRYCB000 : AC 220V~240V – PDRYCB100 : AC 24V • 2 output contacts(operation, error)
		PDRYCB300 	For Connect Indoor unit to Other Thermostat Controller. (Available from Multi V II series)	120 x 120 x 36.5	<ul style="list-style-type: none"> • 1SET / 1 IDU • 8 Contact point • No need AC input • Target temperature setting is possible • 2 output contacts(operation, error)
		PDRYCB400 	For Connect Indoor unit to other Forced on/off Controller. (Available from Multi V II series)	120 x 120 x 36.5	<ul style="list-style-type: none"> • 1SET / 1 IDU • 2 Contact point • No need AC input • Target temperature setting is possible • 2 output contacts(operation, error)
		PDRYCB500 	For Connect Indoor unit to external controller. (Available from Multi V II series)	120 x 120 x 36.5	<ul style="list-style-type: none"> • 1SET / 1 IDU • 2 wire RS-485 • MODBUS • Address range (01~08)
	Remote Temperature Sensor	PQRSTA0 	Sensor for detecting the room temperature	70 x 120 x 14.8	

- If you need more detail, please refer to the Control PDB or the manual of product.
(<http://partner.lge.com/global> : Home> Doc.Library> Product > Control(BECON))

2. Control System List

Outline of system

Connect CN-CC with Indoor PCB by the cable(provided)
 - Connection of Dry contact only

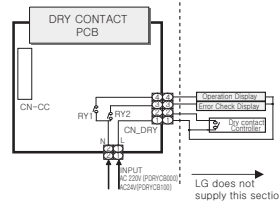
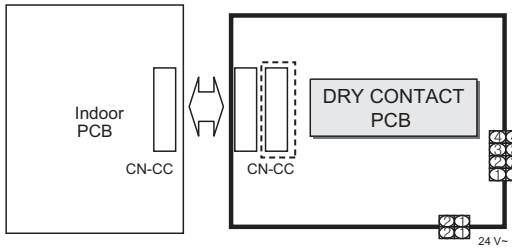

To Apply Power Source through PCB

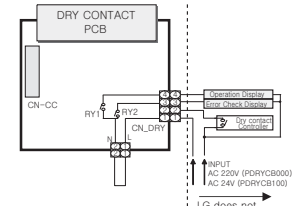

To Apply Power Source Directly to External Source

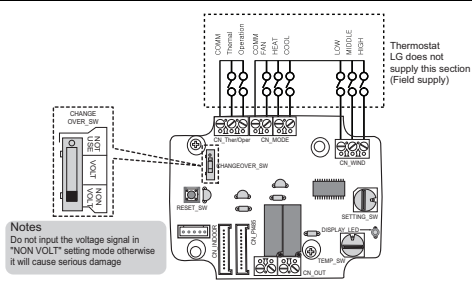

For no Power Contact Point signal Input

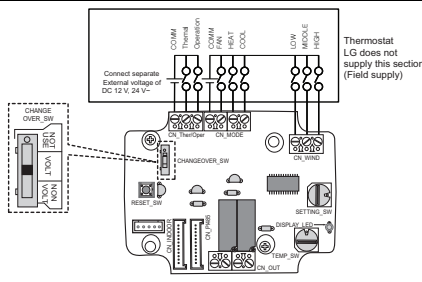

For Power Contact Point signal Input

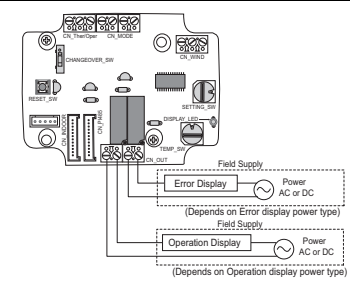

Indoor Unit Monitoring

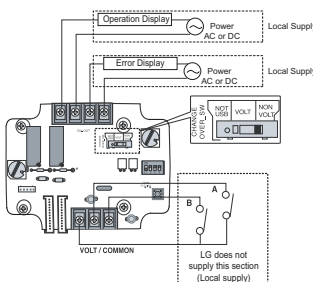

In Case Non Voltage Signal

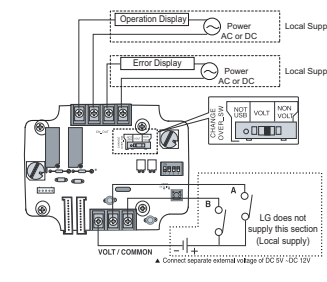

In Case Voltage Signal

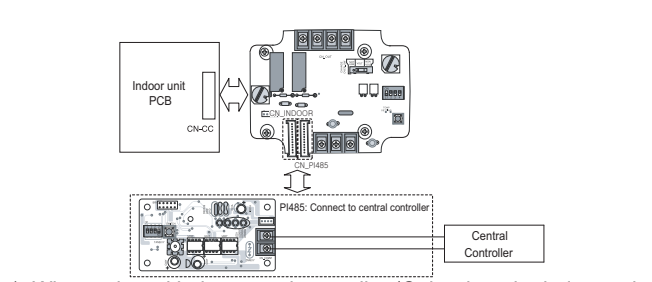

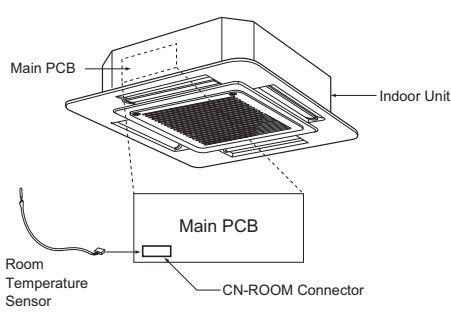
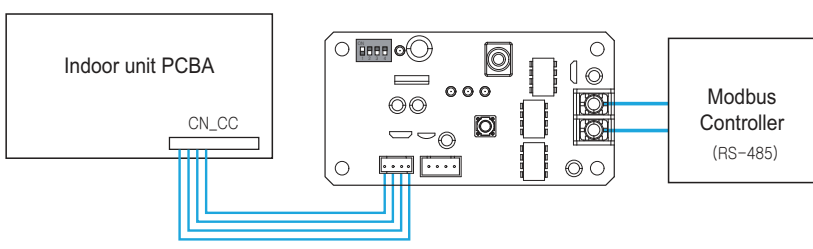

▶ When using with the central controller (Only when the indoor unit PCB is a non-communication model)



CAUTION
 Remote temperature sensor only applied to Cassette and Duct products.

- If you need more detail, please refer to the Control PDB or the manual of product. (<http://partner.lge.com/global> : Home> Doc.Library> Product > Control(BECON))

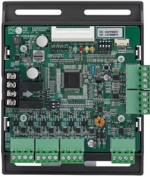
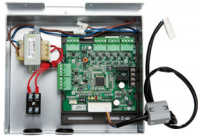
2. Control System List

Category	Controller name	Model name	Objective / Use	Dimensions (W x H x D, mm)	Feature
Interface Device	Cool/Heat Selector	PRDSBM 	To Select Operation Mode	74 x 120 x 103	<ul style="list-style-type: none"> • Push Button Type • Mode : Cooling, Heating, Fan
	IO(Input/Output) Module	PVDSMN000 	Expansion IO function (Available from Multi V IV series)	126 x 155 x 33	<ul style="list-style-type: none"> • AO 2EA (Voltage) • AI 2EA (Voltage) • DI 6EA (DryContact) • DO 2EA (operation, error) Relay Output / Normal Open
	Variable Water Flow Valve Control Kit ¹⁾	PWFCKN000 	Variable Water Flow Valve (Available from Multi V Water IV series)	218 x 200 x 85	<ul style="list-style-type: none"> • AO 2EA (Voltage) • AI 2EA (Voltage) • DI 6EA (DryContact) • DO 2EA (operation, error) Relay Output / Normal Open
	Low Ambient Control Kit	PRVC2 	Low Ambient (Available from Multi V IV series)	126 x 155 x 33	<ul style="list-style-type: none"> • AO 2EA (Voltage) • AI 2EA (Voltage) • DI 6EA (DryContact) • DO 2EA (operation, error) Relay Output / Normal Open
	ACS I/O Module	PEXPMB000 	ACP 5 ACP IV AC Smart 5 AC Smart IV	126 x 155 x 65	<ul style="list-style-type: none"> • 24 V~ Power Input • AO 4EA (Voltage) • UI 4EA (Voltage, Current, NTC 10k, PT1000, Ni1000, Dry Contact) • DI 3EA (Dry Contact) • DO 3EA (Relay Output / Normal Open) • RS-485 : 1 channel(Modbus)

- 1) It is available Multi V Water Outdoor unit only.
- If you need more detail, please refer to the Control PDB or the manual of product.
(<http://partner.lge.com/global> : Home> Doc.Library> Product > Control(BECON))

2. Control System List



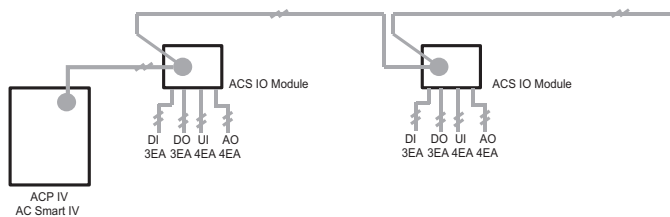
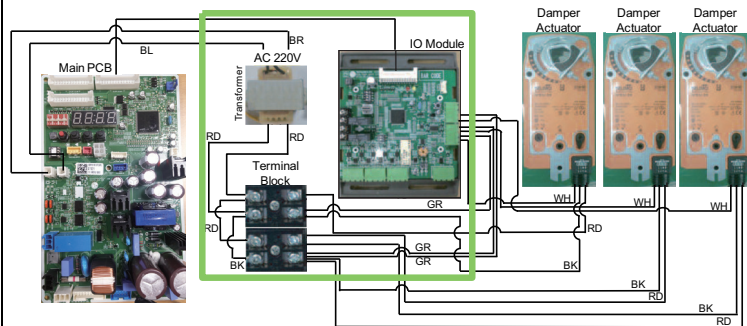
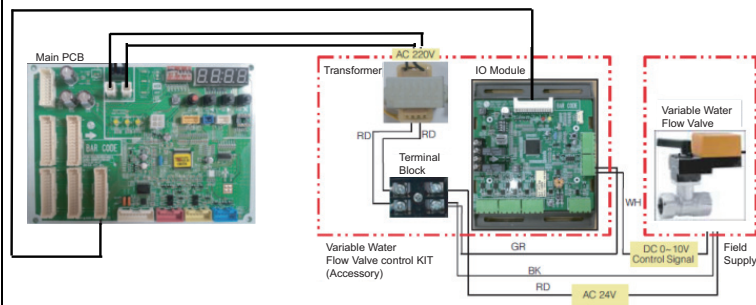
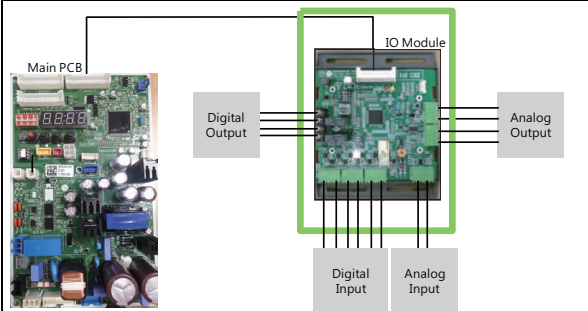
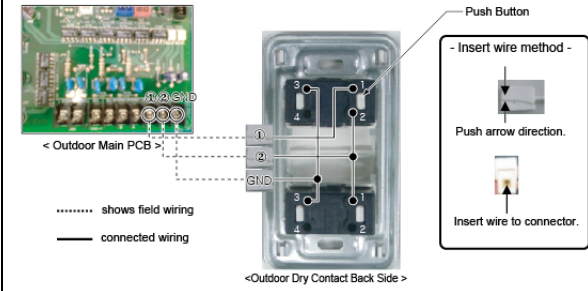

Outline of system



- ACP IV : Up to 16 ACS IO Modules*
- AC Smart IV : Up to 9 ACS IO Modules*
- Communication cable
 - Types : shielding wire
 - Use wires of size : over 0.75 ~ 1.5 mm²
 - Max. allowable temperature : 60°C
 - Max. length of total transmission wiring for centralized control : 1km
 - Max. length of I/O wiring : 100m

- If you need more detail, please refer to the Control PDB or the manual of product.
(<http://partner.lge.com/global> : Home> Doc.Library> Product > Control(BECON))

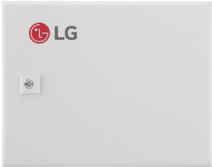
2. Control System List

Category	Controller name	Model name	Objective / Use	Dimensions (W x H x D, mm)	Feature
Interface Device	AHU Comm. Kit	PAHCMR000  <Product cover>  <Communication Module>	Return Air Temperature Control	300 X 300 X 155	<ul style="list-style-type: none"> • UI 4EA (AI/DI) • DO 3EA (Relay, A type) • T/B Spring Push Type
	AHU Comm. Kit	PAHCMS000  <Product cover>  <Main Module(left) and Communication Module(right)>	Discharge Air Temperature Control	380 X 300 X 155	<ul style="list-style-type: none"> • UI 15EA (AI/DI) • DI 3EA (Dry Contact) • DO 9EA (Relay,A type 8EA, C type 1EA) • AO 6EA (0~10V) • T/B Spring Push Type

- If you need more detail, please refer to the Control PDB or the manual of product.
(<http://partner.lge.com/global> : Home> Doc.Library> Product > Control(BECON))

2. Control System List

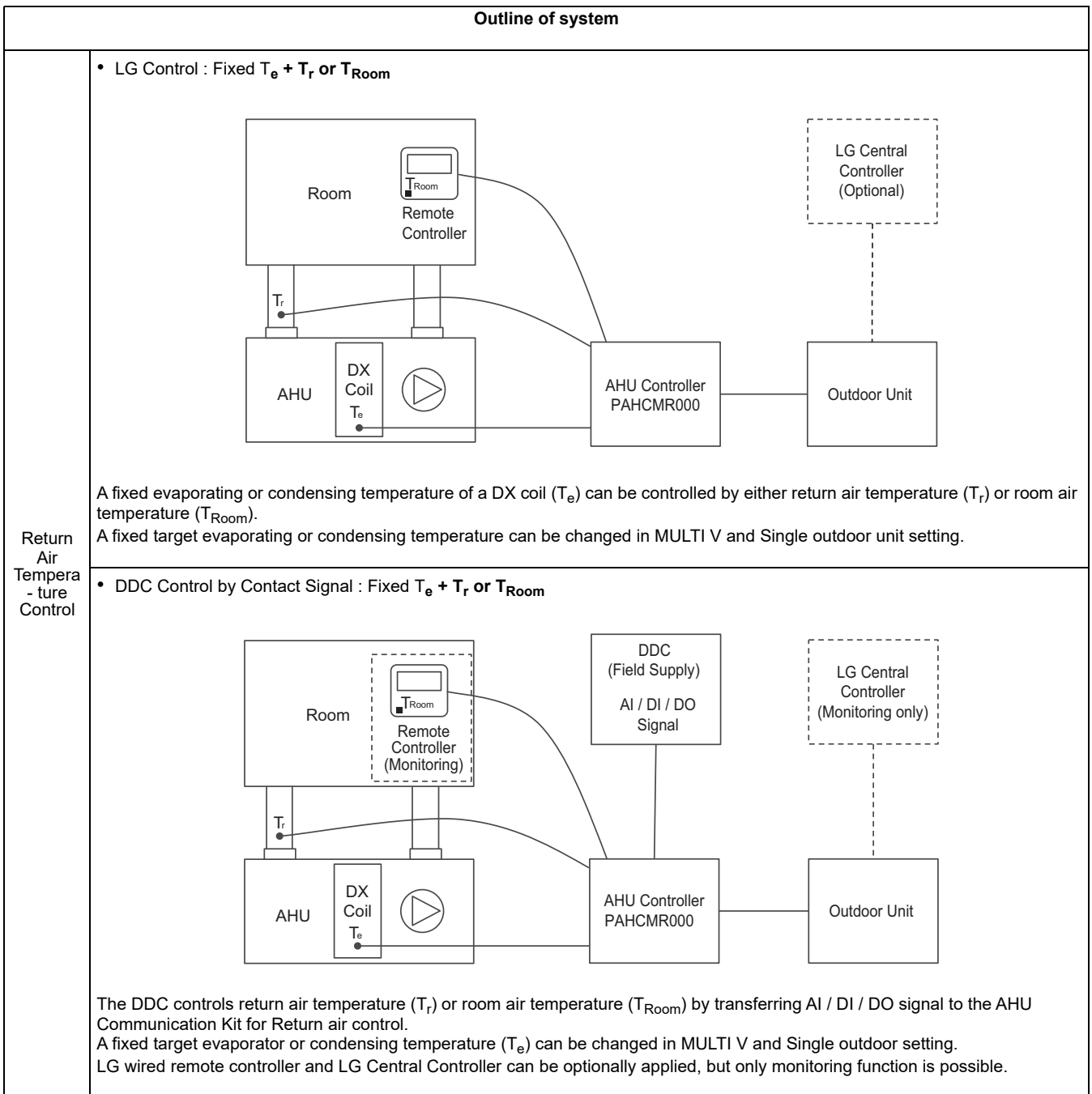

- If you need more detail, please refer to the Control PDB or the manual of product.
(<http://partner.lge.com/global> : Home> Doc.Library> Product > Control(BECON))

2. Control System List

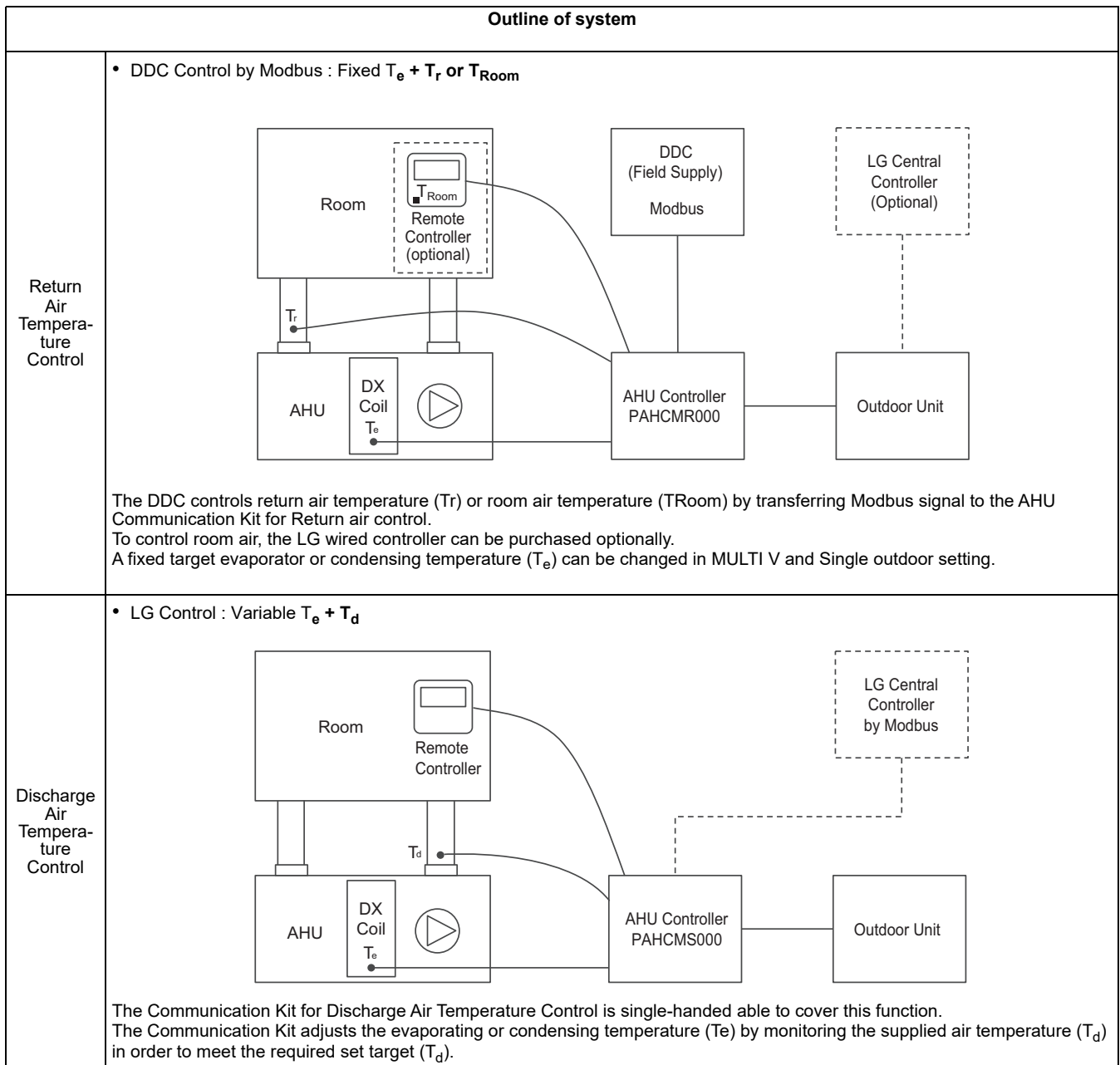

- If you need more detail, please refer to the Control PDB or the manual of product.
(<http://partner.lge.com/global> : Home> Doc.Library> Product > Control(BECON))

2. Control System List

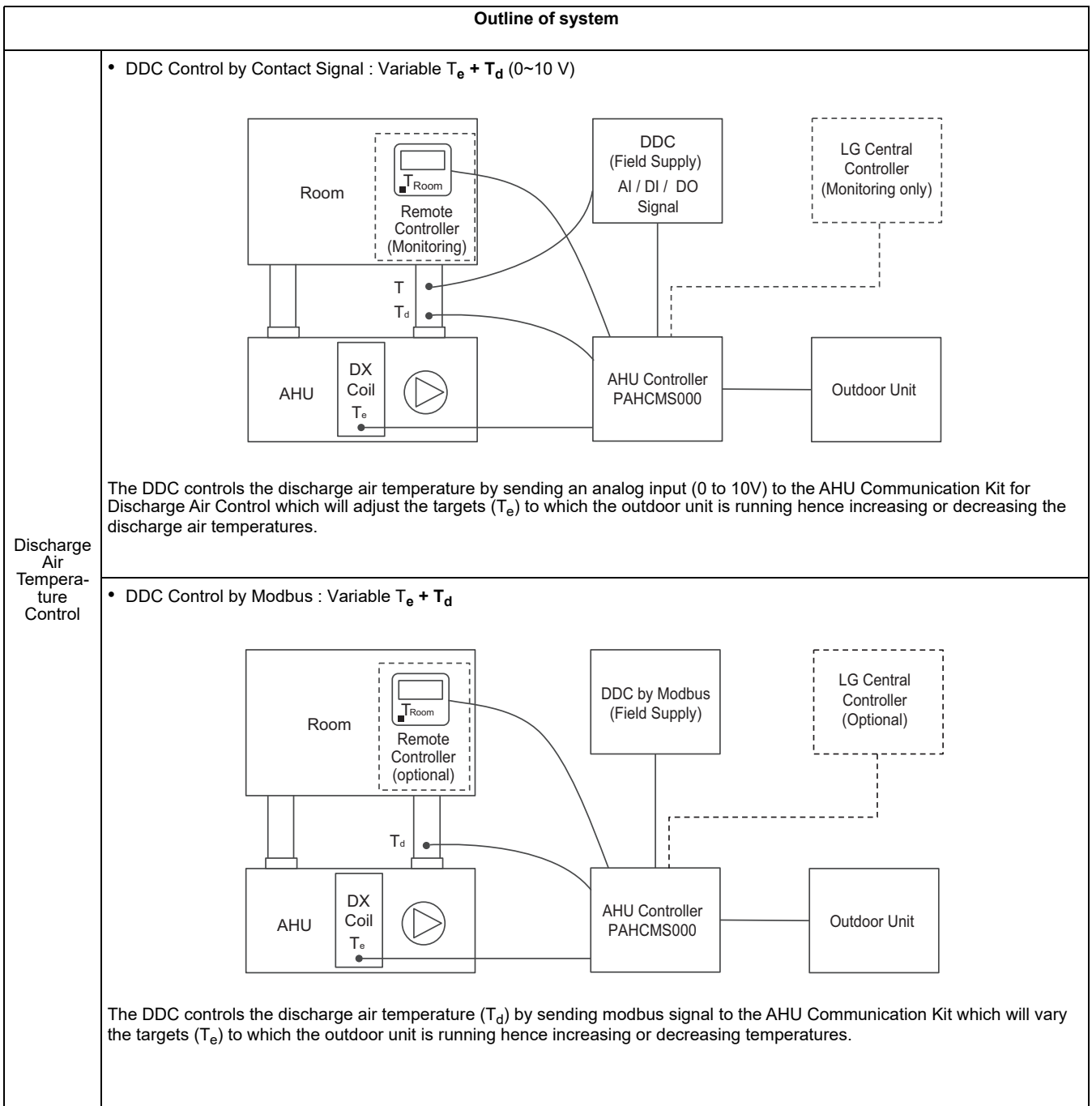

- If you need more detail, please refer to the Control PDB or the manual of product. (<http://partner.lge.com/global> : Home> Doc.Library> Product > Control(BECON))

2. Control System List

Category	Controller name	Model name	Objective /Use	Dimensions (W x H x D, mm)	Feature
Maintenance Accessory	LGMV	PRCTI10 	LGMV data monitoring via Personal Computer	105 x 78 x 36	<ul style="list-style-type: none"> Length of cable : 1m (3m extension cable is included) RS232(ODU), RS485(IDU) support USB type of connection are possible.

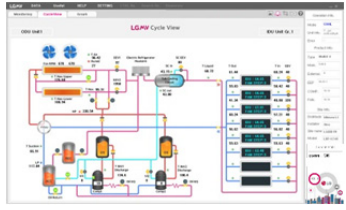
Category	Connected device	Installation Method	Feature
Maintenance Accessory	PC Program  	<ul style="list-style-type: none"> Web Install <ul style="list-style-type: none"> Connect to homepage (http://partner.lge.com) and select HVAC category then downloaded installation file on software menu. Automatic Install <ul style="list-style-type: none"> The accessory application program supports for automatic updates. CD Install <ul style="list-style-type: none"> It can be installed on from CD. 	<ul style="list-style-type: none"> Minimum Specification <ul style="list-style-type: none"> Windows XP MS Office 2003 Recommended Specification <ul style="list-style-type: none"> Windows7 (Win10 is possible) MS Office 2007 Resolution <ul style="list-style-type: none"> 2048 x 1536 (optimization) 1024 x 768 Basic specification <ul style="list-style-type: none"> CPU 1 GHz RAM 1 GB

- If you need more detail, please refer to the Control PDB or the manual of product. (<http://partner.lge.com/global> : Home> Doc.Library> Product > Control(BECON))

2. Control System List

Outline of system

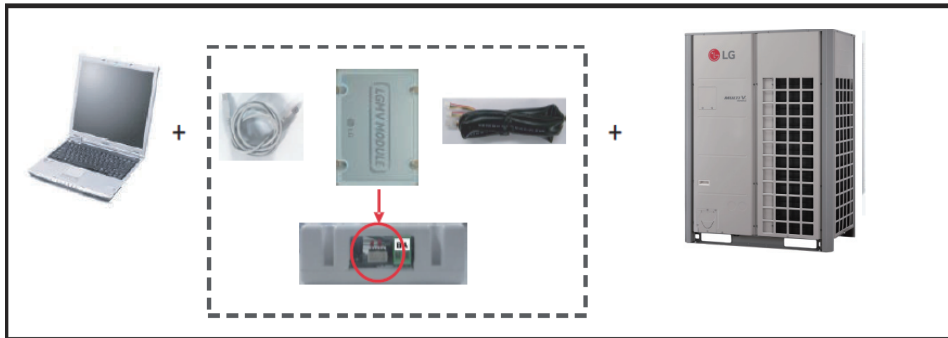

1. Outdoor connection

Connect LGMV cable to Multi V PCB LGMV port

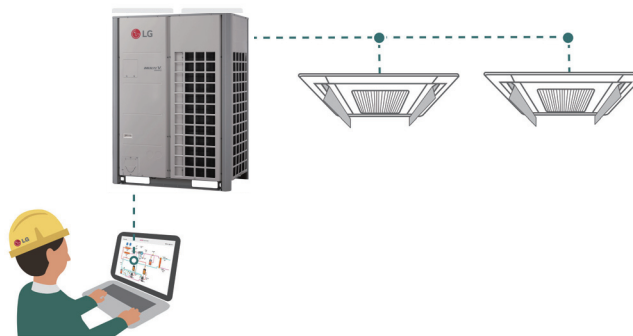

2. Indoor unit connection

Connect LGMV cable to Multi V Indoor unit communication port

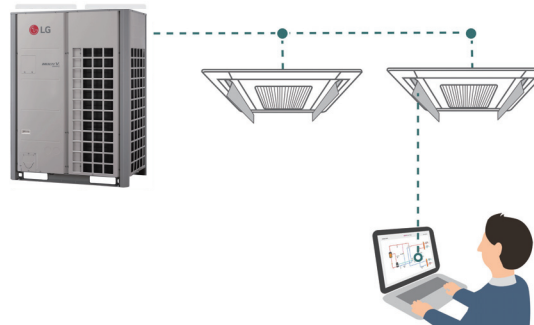

- If you need more detail, please refer to the Control PDB or the manual of product.
(<http://partner.lge.com/global> : Home> Doc.Library> Product > Control(BECON))

2. Control System List

Category	Controller name	Model name	Objective /Use	Dimensions (W x H x D, mm)	Feature
Maintenance Accessory	Mobile LGMV	<p>PLGMVW100</p> 	LGMV monitoring via mobile device	48 x 78 x 14.5	<ul style="list-style-type: none"> The effective distance for wireless communication is 10m The effective distance may be reduced by the communication environment.

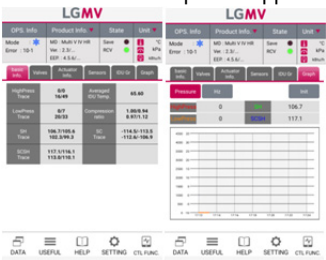
Category	Connected device	Installation Method	Feature
Maintenance Accessory	<p>iOS App. (iPad only)</p> 	<p>Tap the app Store icon on the screen. And then Search 'mobile lgmv'</p>	<ul style="list-style-type: none"> Minimum Specification <ul style="list-style-type: none"> iOS 7.1 Recommended Specification <ul style="list-style-type: none"> iOS 7.1/8.0/8.1 Resolution <ul style="list-style-type: none"> 2048 x 1536 (optimization) 1024 x 768
	<p>Android mobile phone App.</p> 	<p>Tap the Play Store icon on the screen. And then Search 'mobile lgmv'</p>	<ul style="list-style-type: none"> Basic specification <ul style="list-style-type: none"> Phone: Android OS 2.2 Pad: Android 4.4.2(Kitkat) CPU 1 GHz RAM 1 GB Recommended Specification <ul style="list-style-type: none"> Android OS 4.4.2(Kitkat) or higher, CPU 1 GHz Dual Core or higher, RAM 1 GB or higher 1280 x 720, 800 x 480 resolution (Optimized)

- If you need more detail, please refer to the Control PDB or the manual of product. (<http://partner.lge.com/global> : Home> Doc.Library> Product > Control(BECON))

2. Control System List



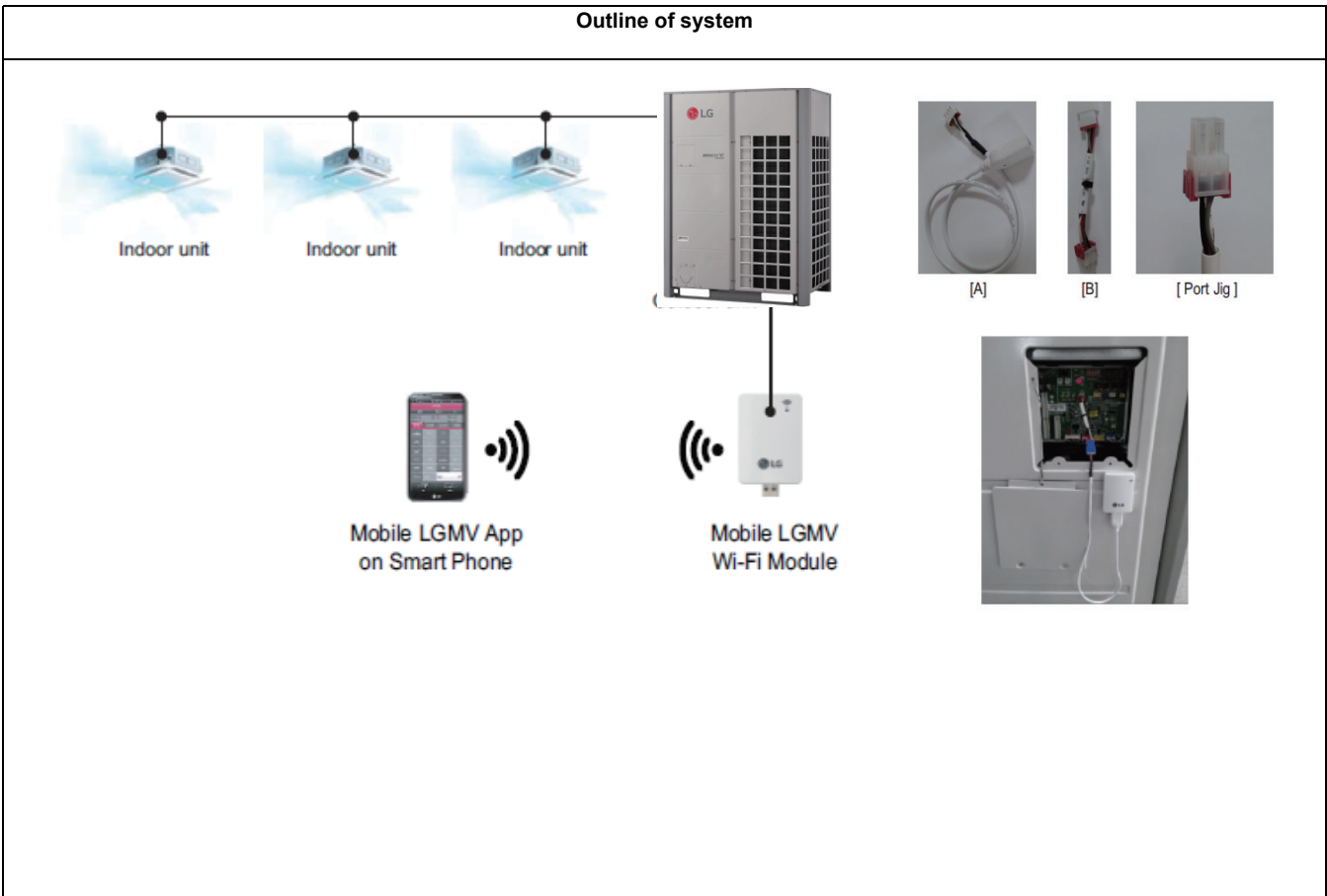



Outline of system



- If you need more detail, please refer to the Control PDB or the manual of product. (<http://partner.lge.com/global> : Home> Doc.Library> Product > Control(BECON))

3. Function List





Individual Controller

Controller Name		Premium Wired Remote Controller	Standard Wired Remote Controller		Simple Wired Remote Controller	Simple Wired Remote Controller	Wireless Remote Controller
Product Image							
Model Name		PREMTA000 PREMTA000A PREMTA000B	PREMTB100 PREMTBB10	PREMTB001 PREMTBB01	PQRCVCL0Q PQRCVCL0QW	PQRCHCA0Q PQRCHCA0QW	PQWRHQ0FDB
Basic	On / Off	O	O	O	O	O	O
	Fan Speed Control	O	O	O	O	O	O
	Temperature Setting	O	O	O	O	O	O
	Mode Change	O	O	O	O	X	O
	Auto Swing	O	O	O	O	O	O
	Vane Control (Louver Angle)	O	O	O	O	O	O
	E.S.P (External Static Pressure)	O	O	O	O	O	X
	Electric Failure Compensation	O	O	O	O	O	X
	Indoor Temperature Display	O	O	O	O	O	O
	ALL Button Lock (Child Lock)	O	O	O	O	O	X
Advanced	Schedule / Timer	O	O	O	X	X	O
	Additional Mode Setting*	O	O	O	X	X	X
	Time Display	O	O	O	X	X	O
	humid. Display	O	O	X	X	X	X
	Advanced Lock (mode, set point, set point range, on/off Lock)	Advanced Lock	Advanced Lock	Mode Lock	X	X	X
	Filter Sign	O	O	O	X	X	X
	EnergyManagement **	O	O	O	X	X	X
	Dual Set point	O	O	X	X	X	X
	Human Detection	X	O	X	X	X	X
	Temp, Humidity compensation	O	O	X	X	X	X
Wifi AP mode setting	O	O	O	O	O	O	
ETC	Operation StatusLED	O	O	O	O	O	X
	Wireless Remote Controller Receiver	O***	X	O***	O***	O***	X
	Display	5 inch Color Display	4.3 inch Color Display	4.3 inch mono Display	2.6 inch mono Display	2.6 inch mono Display	2 inch mono Display
	Size (W x H x D, mm)	137 x 121 x 16.5	120 x 120 x 16	120 x 120 x 15	64 x 120 x 15	64 x 120 x 15	51 x 153 x 26
	Black Light Control for Screen Saver	O	O	X	X	X	X

- O : Applied X : Not applied
- * It might not be indicated or operated at the partial product
- ** Centralized control (PACS5A000 / PACS4B000 / PACP5A000 / PACP4B000 / PQNFB17C0 / PLNWKB000) and PDI (PQNUD1S40 / PPWRDB000) should be installed for this function
- *** For ceiling type duct
- Indoor unit should have functions requested by the controller
- If you need more detail, please refer to the Control PDB or the manual of product.
(<http://partner.lge.com/global> : Home> Doc.Library> Product > Control(BECON))





3. Function List

■ Central Controller

Controller Name	AC Ez	AC Ez touch	AC Smart IV	AC Smart 5 ²⁾
Product Image				
Model Name	PQCSZ250S0	PACEZA000	PACS4B000	PACS5A000
Maximum Number of Indoor Units	32	64	128	128
Individual / Group Control (On & Off, Mode, Set Point, Fan Speed)	O	O	O	O
Individual Controller Lock	O (All)	O (Temperature, Mode, Fan, All)	O (Temperature, Mode, Fan, All)	O (Temperature, Mode, Fan, All)
Error Check	O	O	O	O
Mode Change	O	O	O	O
Schedule	8 Event	Daily, Weekly, Monthly, Yearly, Exception day	Daily, Weekly, Monthly, Yearly, Exception day	Daily, Weekly, Monthly, Yearly, Exception day
Operation History	X	X	O	O
Visual Navigation	X	X	O	O
Operation Time Limit	X	X	O	O
Temperature Limit	X	O	O	O
Remote Access ¹⁾	X	PC SW	Web	Web
Auto Changeover / Setback	X	O	O	O
Power Consumption Monitoring (with PDI)	X	O	O	O
Energy navigation	X	X	O	O
Interlock Control	X	X	O	O
Virtual Group Control	X	X	O	O
Emergency Alarm Display	X	O	O	O
ACS I/O Module Interlocking	X	X	O	O
External IO Port No.	X	DI 1EA	DI 2EA DO 2EA	DI 2EA DO 2EA
Connectable Products	Air conditioner ERV ERV DX	Air conditioner ERV ERV DX Hydro kit	Air conditioner ERV ERV DX Hydro kit AHU Chiller*	Air conditioner ERV ERV DX Hydro kit AHU Chiller*

- O : Applied X : Not applied
- 1) Assignment of public IP address is required to access central controller through internet.
- 2) Without additional device, ACP 5 and AC Smart 5 provide BACnet IP and Modbus TCP interface for BMS.
- * It needs to apply Chiller Option KIT.
- If you need more detail, please refer to the Control PDB or the manual of product.
(<http://partner.lge.com/global> : Home> Doc.Library> Product > Control(BECON))

3. Function List

Controller Name	ACP IV	ACP 5 ²⁾	AC Manager IV	AC Manager 5
Product Image				
Model Name	PACP4B000	PACP5A000	PACM4B000	PACM5A000
Maximum Number of Indoor Units	256	256	8,192	8,192
Individual / Group Control (On & Off, Mode, Set Point, Fan Speed)	O	O	O	O
Individual Controller Lock	O (Temperature, Mode, Fan, All)	O (Temperature, Mode, Fan, All)	O (Temperature, Mode, Fan, All)	O (Temperature, Mode, Fan, All)
Error Check	O	O	O	O
Mode Change	O	O	O	O
Schedule	Daily, Weekly, Monthly, Yearly, Exception day	Daily, Weekly, Monthly, Yearly, Exception day	Daily, Weekly, Monthly, Yearly, Exception day	Daily, Weekly, Monthly, Yearly, Exception day
Operation History	O	O	O	O
Visual Navigation	O	O	O	O
Operation Time Limit	O	O	O	O
Temperature Limit	O	O	O	O
Remote Access ¹⁾	Web	Web	PC SW	Web
Auto Changeover / Setback	O	O	O	O
Power Consumption Monitoring (with PDI)	O	O	O	O
Energy navigation	O	O	X	O
Interlock Control	O	O	O	O
Virtual Group Control	O	O	O	O
Emergency Alarm Display	O	O	O	O
ACS I/O Module Interlocking	O	O	O	O
External IO Port No.	DI 10EA DO 4EA	DI 10EA DO 4EA	X	X
Connectable Products	Air conditioner ERV ERV DX Hydro kit AHU Chiller*	Air conditioner ERV ERV DX Hydro kit AHU Chiller*	Air conditioner ERV ERV DX Hydro kit AHU Chiller*	Air conditioner ERV ERV DX Hydro kit AHU Chiller*

- O : Applied X : Not applied
- 1) Assignment of public IP address is required to access central controller through internet.
- 2) Without additional device, ACP 5 and AC Smart 5 provide BACnet IP and Modbus TCP interface for BMS.
- * It needs to apply Chiller Option KIT.
- If you need more detail, please refer to the Control PDB or the manual of product.
(<http://partner.lge.com/global> : Home> Doc.Library> Product > Control(BECON))

4. Accessory Compatibility List

Product		Model name	ETC	Compatibility
Wireless Remote Controller	-	PQWRH(C)Q0FDB	-	○
Wired Remote Controller	Simple	PQRCVCL0Q(W)	Simple	○*
		PQRCHCA0Q(W)	for Hotel	○*
	Standard	PREMTB001	Standard II (White)	○
		PREMTBB01	Standard II (Black)	○
		PREMTB100	Standard III (White)	○
		PREMTBB10	Standard III (Black)	○
Premium	PREMTA000(A/B)	Premium	○**	
Dry contact	Simple Contact	PDRYCB000	Simple Dry Contact	○
	Communication type	PDRYCB400	2 Points Dry Contact (For Setback)	○
		PDRYCB300	Dry Contact For 3rd Party Thermostat	○
		PDRYCB500	Dry Contact For Modbus	○
	IO Module	PQDSBCDVM0	Demand controller for MULTI V III	X
		PVDSMN000	Demand controller From MULTI V IV series	○
	Variable Water Flow Control kit	PRVC0	For MULTI V WATER II	X
PWFCKN000		For MULTI V WATER IV	○	
Gateway	IDU PI485	PHNFP14A0	Without Case	X
		PSNFP14A0	With Case	X
	ODU PI485	PMNFP14A1	PI 485 Gateway	X
	Cool/Heat Selector	PRDSBM	For MULTI V Heat Pump / Mode lock (Cool/Heat/Fan)	○
	Low Ambient Kit	PRVC2	From MULTI V IV series	○
	AHU Comm. Kit	PAHCMR000	Return Air Temperature Control	○
		PAHCMS000	Discharge Air Temperature Control	○
	Water Comm. Kit	PAHCMW000	Water Communication Module	○
	BACnet	PQNFB17C0	ACP BACnet	○
	Lonworks	PLNWKB000	ACP Lonworks	○
	Modbus	PMBUSB00A	Modbus RTU	○
Cloud Gateway	PWFMDB200	Cloud Gateway	○	
Central Controller	Simple	PQCSZ250S0	AC Ez	○
	AC Ez Touch	PACEZA000	AC Ez Touch	○
	AC Smart	PACS4B000	AC Smart IV	○
		PACS5A000	AC Smart 5	○
	ACP	PACP4B000	ACP IV	○
		PACP5A000	ACP 5	○
	AC Manager	PACM5A000	AC Manager 5	○***
ETC	Remote Temperature Sensor	PQRSTA0	-	○
	Zone Controller	ABZCA	-	X
	CO ₂ Sensor	AHCS100H0	For ERV, ERV DX Indoor units (Internal type)	○
	Group Control Wire	PZCWRCG3	0.25m	-
	2-Remo Control Wire	PZCWRC2	0.25m	-
	Extension Wire	PZCWRC1	10m	-
	Wi-Fi Controller*	PWFMDDB200	-	○
	PDI	PPWRDB000	PDI Standard	○
		PQNUD1S40	PDI Premium	○
	ACS I/O Module	PEXPMB000	-	-

- ○: Possible X: Impossible - : Not applicable
- * It is possible basic function only. (Refer [Function List – Individual Controller])
- ** It isn't possible some function
- *** PACS4B000, PACP4B000, PACS5A000, PACP5A000, PQNFB17C0 or PLNWKB000 is needed.
- 1) This product is provided by INTESIS.
- If you need more detail, please refer to the Control PDB or the manual of product. (<http://partner.lge.com/global> : Home> Doc.Library> Product > Control(BECON))

4. Accessory Compatibility List

■ E.O.L Model ¹⁾

Product		Model name	ETC	Compatibility
Wireless Remote Controller	-	PQWRH(C)DF0	-	○
Wired Remote Controller	Standard	PQRCVSL0	RS2 Wired (black)	○*
		PQRCVSL0QW	RS2 Wired (White)	○*
Dry contact	Simple Contact	PQDSA	-	○
		PQDSA(1)	-	○
		PQDSB(1)	-	○
	Communication type	PQDSBC	-	○
		PQDSBNGCM1	-	○
		PQDSBCGCD0	Dry Contact for Thermostat	○
		PQDSBC1	-	○
Central Controller	Simple	PQCSB101S0	Simple central controller	○
		+ PQCSC101S0	Function controller	○**
		+ PQCSD130A0	Function Scheduler	○**
	AC Smart	PQCSW320A1E	AC Smart II	○
		+ PQCSE341A0	Option Kit	○***
		+ PQCSE342A0	Option Kit	○***
		+ PQCSE440U0	Expansion Kit	○***
	ACP	PQCSW421E0A	AC Smart Premium	○
		PQCPA11A0E	ACP without IO	○
		PQCPC22N0	ACP Standard	○
		PQCPB11A0E	ACP with IO	○
	AC Manager	PQCPC22A0	ACP Premium	○
		PQCSS520A0E	AC Manager	○****
		PQCSSA21E0	AC Manager Plus	○****
		PACM4B000	AC Manager IV	○****
Gateway	ODU PI485	PMNFP14A0	PI 485 Gateway	X
		PV485N000	PI 485 Gateway (For Multi V IV)	X
	Low Ambient Kit	AQLA	-	X
	BACnet	PQNFB17B0	BACnet Gateway	○
	Lonworks	PQNFB16A1	Lonworks Gateway	○
ETC	PDI	PQNUD1S00	PDI	○
	Telecom Shelter Controller	PQCSA001T0	-	○
	Electronic Thermostat	AQETC	-	○
	CTI	PKFC0	-	○
	CO ₂ Sensor	PES-C0RV0	For ERV, ERV DX Indoor units (External type)	○
	DO KIT	PQNFP00T0	-	-

- O: Possible X: Impossible
- * It isn't possible some function.
- ** PQCSB101S0 is needed.
- *** PQCSW320A1E is needed.
- **** ACP is needed.
- 1) E.O.L Model has been discontinued, so stock is subject to availability.

5. Centralized Controller Compatibility List

Compatibility between Controllers

Master (A)	Slave (B)							
	AC Ez	AC Ez Touch	AC Smart IV AC Smart 5	ACP IV ACP 5	ACP BACnet	ACP Lonworks	PDI	Cloud Gateway
AC Ez	○	X	X	X	X	X	X	X
AC Ez Touch	○	○	X	X	X	X	○	X
AC Smart IV, AC Smart 5	○	○	○	X	X	X	○	X
ACP IV, ACP 5	○	○	○	X	X	X	○	X
ACP BACnet	○	○	○	X	X	X	○	X
ACP Lonworks	○	○	○	X	X	X	○	X
PDI	X	X	X	X	X	X	X	X
Cloud Gateway	○	X	X	X	X	X	X	X

Compatibility with Integrator

Integrator	Controller							
	AC Ez	AC Ez Touch	AC Smart IV AC Smart 5	ACP IV ACP 5	ACP BACnet	ACP Lonworks	PDI	Cloud Gateway
AC Manager IV	X	X	○	○	○	○	X	X
AC Manager 5	X	X	○	○	○	○	X	X

Compatibility with IO Module

IO Module (C)	Controller								
	AC Ez	AC Ez Touch	AC Smart IV AC Smart 5	AC Smart BACnet	ACP IV ACP 5	ACP BACnet	ACP Lonworks	PDI	Cloud Gateway
ACS I/O Module	X	X	○	○ ¹⁾	○	○ ¹⁾	○ ¹⁾	X	X

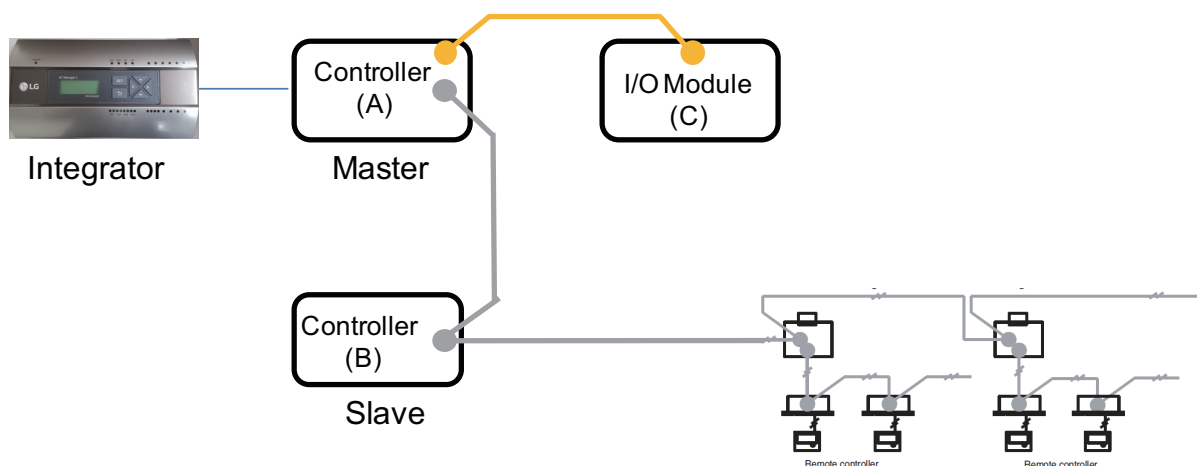

- If you need more detail, please refer to the Control PDB or the manual of product. (<http://partner.lge.com/global> : Home> Doc.Library> Product > Control(BECON))
- 1) This Function is possible to use in Web Only. (BMS Point is not applied)



Air Solution

LG Electronics Inc, 128, Yeoui-daero,
Yeongdeungpo-gu, Seoul, Korea
(07336)
<http://partner.lge.com>

Copyright © 2018-2023 LG Electronics Inc.
All Rights Reserved.
Printed in Korea June / 2023

The air conditioners manufactured by LG have received ISO9001 certificate for quality assurance and ISO14001 certificate for environmental management system.
The specifications, designs, and information in this brochure are subject to change without notice.