

LG

MULTI V™ Indoor unit

R410A (50Hz/60Hz)

0CVP0-13F (Replaces CVP0-13E)

TOTAL HVAC SOLUTION PROVIDER

ENGINEERING PRODUCT DATA BOOK

MULTI V™

Indoor Unit

General Information

- 1. Model Names**
- 2. External Appearance**
- 3. Nomenclature**
- 4. Indoor Unit Capacity Index**
- 5. ODU-IDU Combination / Compatibility Information**
- 6. Additional Refrigerant according to Indoor Unit Type**

1. Model Lineup

Category		Chassis Name	Capacity(Btu/h(kW))																
			5k	7k	9k	12k	15k	18k	21k	24k	28k	30k	36k	42k	48k	54k	60k	76k	96k
			1.6	2.2	2.8	3.6	4.5	5.6	6.2	7.1	8.2	9.0	10.6	12.3	14.1	15.8	17.5	22.4	28.0
Wall Mounted Unit	Standard	SJ	○	●	●	●	●												
		SK						●		●									
		SV										●	●						
ARTCOOL	Mirror	SJ	○	●	●	●	●												
	Gallery	SF		●	●	●			●										
Ceiling Mounted Cassette	1 Way	TU		●	●	●													
		TT						●		●									
	2 Way	TS			●	●			●		●								
		TR	○	●	●	●													
	4 Way Mini	TQ					●	●	●										
		TP-B								●	●	●							
	Dual Vane 4-Way	TM-A								●	●	●		●	●	●			
		TM-A	●	●	●	●	●	●		●	●		●	●	●				
	4 Way (compact)	TR			●		●												
	Round	TY								●			●		●				
Ceiling Concealed Duct	High Sensible	M2		●	●	●	●												
		M3						●		●	●								
		B8											●	●	●				
	High Static	M1		●	●	●	●	●		●								●	●
		M2									●			●	●				
		M3													●	●			
	High Static(2)	BH		●	●	●	●	●		●	●								
		M3												●	●				
	Low Static	L1	○	●	●														
		L2				●	●	●											
		L3							●	●									
	Low Static (Slim)	L4	○	●	●														
		L5				●	●	●											
L6								●	●										
Floor Standing Unit (1)	With Case	CE		○	●	●	●												
		CF						●		●									
	Without Case	CE		○	●	●	●												
		CF						●		●									
Floor Standing Unit (2)	PT3													●					
	PF2																	●	
Ceiling & Floor Convertible Unit	VE			●	●														
Console	QA		●	●	●	●													
Fresh Air Intake Unit	B8																●	●	
Ceiling Suspended Unit	VM1							●		●									
	VM2											●		●					

Note









- : It can be combined with EHP(Multi V series) only.
- : It can be combined with EHP(Multi V series) or GHP.
- In matters of combination with Outdoor unit system, refer the PDB of that outdoor units.
- This product contains Fluorinated Greenhouse Gases.(R410A)

2. External Appearance

Standard Model

<p>Ceiling Mounted Cassette (1-Way)</p> <p>ARNU07GTU*4 ARNU09GTU*4 ARNU12GTU*4</p>  <p>ARNU18GTT*4 ARNU24GTT*4</p> <p>*A:China only, B:Basic</p>	<p>Ceiling Mounted Cassette (2-Way)</p> <p>ARNU09GTS*4 ARNU12GTS*4 ARNU18GTS*4 ARNU24GTS*4</p> <p>* A:Basic, C:Ionizer(Acc.)</p> 																		
<p>Ceiling Mounted Cassette (4-Way Mini)</p> <p>ARNU05GTR*4 ARNU07GTR*4 ARNU09GTR*4 ARNU12GTR*4 ARNU15GTQB4 ARNU18GTQB4 ARNU21GTQB4</p>  <p>*A:China only, B:Basic</p>	<p>Ceiling Mounted Cassette (Dual Vane 4-Way)</p> <p>ARNU24GTBB4 ARNU28GTBB4 ARNU30GTBB4 ARNU36GTAB4 ARNU42GTAB4 ARNU48GTAB4</p> 																		
<p>Ceiling Mounted Cassette (Dual Vane 4-Way High sensible)</p> <p>ARNU05GTAA4 ARNU07GTAA4 ARNU09GTAA4 ARNU12GTAA4 ARNU15GTAA4 ARNU18GTAA4 ARNU24GTAA4 ARNU28GTAA4 ARNU36GTAA4 ARNU42GTAA4 ARNU48GTAA4</p> 	<p>Ceiling Concealed Duct (High Static)</p> <table border="0"> <tr> <td>ARNU07GM1A4</td> <td>ARNU28GM2A4</td> <td rowspan="10">  </td> </tr> <tr> <td>ARNU09GM1A4</td> <td>ARNU36GM2A4</td> </tr> <tr> <td>ARNU12GM1A4</td> <td>ARNU42GM2A4</td> </tr> <tr> <td>ARNU15GM1A4</td> <td>ARNU48GM3B4</td> </tr> <tr> <td>ARNU18GM1A4</td> <td>ARNU54GM3B4</td> </tr> <tr> <td>ARNU24GM1A4</td> <td>ARNU76GB8A4</td> </tr> <tr> <td></td> <td>ARNU96GB8A4</td> </tr> </table>	ARNU07GM1A4	ARNU28GM2A4		ARNU09GM1A4	ARNU36GM2A4	ARNU12GM1A4	ARNU42GM2A4	ARNU15GM1A4	ARNU48GM3B4	ARNU18GM1A4	ARNU54GM3B4	ARNU24GM1A4	ARNU76GB8A4		ARNU96GB8A4			
ARNU07GM1A4	ARNU28GM2A4																		
ARNU09GM1A4	ARNU36GM2A4																		
ARNU12GM1A4	ARNU42GM2A4																		
ARNU15GM1A4	ARNU48GM3B4																		
ARNU18GM1A4	ARNU54GM3B4																		
ARNU24GM1A4	ARNU76GB8A4																		
	ARNU96GB8A4																		
<p>Ceiling Concealed Duct (High Static(2))</p> <p>ARNU48GM3A4 ARNU54GM3A4</p> 	<p>Ceiling Concealed Duct (High Sensible)</p> <table border="0"> <tr> <td>ARNU07GM2A4</td> <td>ARNU24GM3A4</td> <td rowspan="6">  </td> </tr> <tr> <td>ARNU09GM2A4</td> <td>ARNU28GM3A4</td> </tr> <tr> <td>ARNU12GM2A4</td> <td>ARNU36GB8A4</td> </tr> <tr> <td>ARNU15GM2A4</td> <td>ARNU42GB8A4</td> </tr> <tr> <td>ARNU18GM3A4</td> <td>ARNU48GB8A4</td> </tr> </table>		ARNU07GM2A4		ARNU24GM3A4		ARNU09GM2A4	ARNU28GM3A4	ARNU12GM2A4	ARNU36GB8A4	ARNU15GM2A4	ARNU42GB8A4	ARNU18GM3A4	ARNU48GB8A4					
ARNU07GM2A4	ARNU24GM3A4																		
ARNU09GM2A4	ARNU28GM3A4																		
ARNU12GM2A4	ARNU36GB8A4																		
ARNU15GM2A4	ARNU42GB8A4																		
ARNU18GM3A4	ARNU48GB8A4																		
<p>Ceiling Concealed Duct (Low Static(Slim))</p> <table border="0"> <tr> <td>ARNU05GL4G4</td> <td>ARNU15GL5G4</td> <td rowspan="5">  </td> </tr> <tr> <td>ARNU07GL4G4</td> <td>ARNU18GL5G4</td> </tr> <tr> <td>ARNU09GL4G4</td> <td>ARNU21GL6G4</td> </tr> <tr> <td>ARNU12GL5G4</td> <td>ARNU24GL6G4</td> </tr> </table>	ARNU05GL4G4	ARNU15GL5G4			ARNU07GL4G4	ARNU18GL5G4	ARNU09GL4G4	ARNU21GL6G4	ARNU12GL5G4	ARNU24GL6G4	<p>Ceiling Concealed Duct (Low Static)</p> <table border="0"> <tr> <td>ARNU05GL1G4</td> <td>ARNU15GL2G4</td> <td rowspan="5">  </td> </tr> <tr> <td>ARNU07GL1G4</td> <td>ARNU18GL2G4</td> </tr> <tr> <td>ARNU09GL1G4</td> <td>ARNU21GL3G4</td> </tr> <tr> <td>ARNU12GL2G4</td> <td>ARNU24GL3G4</td> </tr> </table>	ARNU05GL1G4	ARNU15GL2G4		ARNU07GL1G4	ARNU18GL2G4	ARNU09GL1G4	ARNU21GL3G4	ARNU12GL2G4
ARNU05GL4G4	ARNU15GL5G4																		
ARNU07GL4G4	ARNU18GL5G4																		
ARNU09GL4G4	ARNU21GL6G4																		
ARNU12GL5G4	ARNU24GL6G4																		
ARNU05GL1G4	ARNU15GL2G4																		
ARNU07GL1G4	ARNU18GL2G4																		
ARNU09GL1G4	ARNU21GL3G4																		
ARNU12GL2G4	ARNU24GL3G4																		
<p>Ceiling & Floor Convertible Unit</p> <p>ARNU09GVEA4 ARNU12GVEA4</p> 	<p>Ceiling Suspended Unit</p> <p>ARNU18GV1A4 ARNU24GV1A4 ARNU36GV2A4 ARNU48GV2A4</p> 																		
<p>Note</p> <ul style="list-style-type: none"> In matters of combination with Outdoor unit system, refer the PDB of that outdoor units. 																			

2. External Appearance

<p>Floor Standing Unit (1)</p> <p>With case ARNU07GCEA4 ARNU15GCEA4 ARNU09GCEA4 ARNU18GCFA4 ARNU12GCEA4 ARNU24GCFA4</p>  <p>Without case ARNU07GCEU4 ARNU15GCEU4 ARNU09GCEU4 ARNU18GCFU4 ARNU12GCEU4 ARNU24GCFU4</p> 	<p>Floor Standing Unit (2) ARNU48GPTA4 ARNU96GPFA4</p> 
<p>ARTCOOL (Mirror) ARNU05GSJR4 ARNU15GSJR4 ARNU07GSJR4 ARNU18GSKR4 ARNU09GSJR4 ARNU24GSKR4 ARNU12GSJR4</p> 	<p>ARTCOOL (Gallery) ARNU07GSF14 ARNU09GSF14 ARNU12GSF14</p> 
<p>Fresh Air In take Unit ARNU76GB8Z4 ARNU96GB8Z4</p> 	<p>Console ARNU07GQAA4 ARNU09GQAA4 ARNU12GQAA4 ARNU15GQAA4</p> 
<p>Ceiling Mounted Cassette (Round) ARNU24GTYA4 ARNU36GTYA4 ARNU48GTYA4</p> 	<p>Wall Mounted Unit (Standard) ARNU05GSJ*4 ARNU15GSJ*4 ARNU07GSJ*4 ARNU18GSK*4 ARNU09GSJ*4 ARNU24GSK*4 ARNU12GSJ*4 * N, C:Ionizer ARNU30GSVA4 ARNU36GSVA4</p> 
<p>Note</p> <ul style="list-style-type: none"> In matters of combination with Outdoor unit system, refer the PDB of that outdoor units. 	

■ Compact Model

<p>Ceiling Mounted Cassette (4-Way) ARNU09GTR*4 *E:Basic, F:Plasma ARNU15GTR*4 *A:Basic, C:Plasma</p>	
--	--

Note

- In matters of combination with Outdoor unit system, refer the PDB of that outdoor units.

3. Nomenclature

Model Name	ARN	U	07	G	TU	A	4
No.	1	2	3	4	5	6	7

No.	Signification
1	Multi V System with Indoor Unit using R410A/ R32 ARN : Global line-up CRN : Brazil line-up only
2	Combination of Inverter Type and Cooling Only or Heat Pump U : DC Inverter and H/P and C/O
3	Total Cooling Capacity in Btu/h EX) 5,000 Btu/h Class → '05' 18,000 Btu/h Class → '18'
4	Electrical Ratings 2 : 1Ø, 220V, 60Hz 6 : 1Ø, 220 - 240V, 50Hz G : 1Ø, 220 - 240V, 50Hz / 1Ø, 220V, 60Hz
5	Code for chassis
6	Combinations of functions A, B: Basic function N, C: Ionizer (Wall Mounted Unit) C : Ionizer (Acc.) (Ceiling Mounted Cassette 2Way) A : China only (Ceiling Mounted Cassette 1Way / 4Way-mini) E : Compact model (Ceiling Mounted Cassette) F : Compact model+Plasma (Ceiling Mounted Cassette) G : Low Static, Low Static (Slim) U : Floor Standing Unit without Case Z : Fresh Air Intake Unit ART COOL Type : Panel Color Mirror type - R : Mirror Gallery type - 1: Kiss
7	Serial Number

4. Indoor Unit Capacity Index

■ Indoor unit capacity index

Unit Capacity (Btu/h)	5k	7k	9k	12k	15k	18k	21k	24k	28k
Capacity Index	1.6	2.2	2.8	3.6	4.5	5.6	6.2	7.1	8.2
Unit Capacity (Btu/h)	30k	36k	42k	48k	54k	60k	76k	96k	-
Capacity Index	9.0	10.6	12.3	14.1	15.8	17.5	22.4	28.0	-

- Capacity Index is same as the capacity with 'kW' unit.
- In matters of combination with Outdoor unit system, refer the PDB of that outdoor units.

5. ODU-IDU Combination / Compatibility Information

■ ODU-IDU Compatibility

O : Compatible, X : Not Compatible								
Line up	Outdoor Unit Type	Normal Indoor Units	Special Indoor Units ¹⁾					
			Hydro Kit ²⁾		Fresh Air Intake Unit (FAU)	ERV DX	AHU Comm. Kit & EEV Kit	
			Floor standing				Return (Room) air	Discharge (Supply) air
			Med. Temp	High Temp				
Multi V 5	Heat Pump & Heat Recovery	O	O	O	O	O	O	O (HP*only)
	Heat Pump	O	O	O	O	O	O	O
	Pro	O	X	X	O	O	O	O
	Cooling Only	O	O	X	O	O	O	O
	Tropical High Efficiency	O	O	O	O	O	O	O
	Tropical Standard	O	O	O	O	O	O	O
Multi V S	Tropical Pro	O	X	X	O	O	O	O
	R410A Heat Pump	O	O	O	O	O	O	O
	R410A Heat Recovery	O	O	O	X	O	O	X
	R410A Cooling Only	O	O	X	X	X	X	X
Multi V Water IV	Tropical	O	O	O	O	O	O	O
	Heat Pump	O	O	O	O	O	O	O
MULTI V M	Heat Recovery	O	O	O	X	O	O	X
	MULTI V M ³⁾	O	X	X	X	X	X	X

■ Combination Ratio for System with Special Indoor Units

Type		Hydro Kit ²⁾	ERV DX	Fresh Air Intake Unit (FAU)	AHU Comm. Kit & EEV Kit ⁴⁾	
					in Heat Recovery or Return Air Mixing AHU	in Fresh Air AHU
1 ODU : 1 IDU		50 ~ 105%				
One ODU with normal IDUs and Special IDUs	Total (Normal IDUs + Special IDUs)	Refer to 'Combination Ratio for System with Normal Indoor Units' in outdoor unit PDB	Refer to 'Combination Ratio for System with Normal Indoor Units' in outdoor unit PDB	50 ~ 105%	50 ~ 130 %	50 ~ 105%
	Max. Special IDUs	~105%		~ 30% (Max 4 Units)	~ 50% (~100% : With cooling only ODU)	~ 50%
One ODU with Multiple Special IDUs only (no normal IDUs)		50 ~ 105%		50 ~ 105%	50 ~ 130 %	50 ~ 105%

Note

- Special Indoor Unit : Hydro Kit, FAU, ERV DX, AHU Comm. Kit & EEV kit, Water. Comm. Module & EEV Kit.
If more than 2 types of special IDUs are connected, total combination ratio follows the small one.
- Hydro Kit cannot be combined with Multi V quadruple frame (4 units) system.
- Special Indoor Units cannot be combined with Multi V M.
- The combination ratio for systems with AHU Comm. Kit & EEV kit is determined by: (heat exchanger capacity + indoor unit nominal capacity index) / outdoor unit nominal cooling capacity. The on-coil temperature (i.e. coil inlet temperature) of Heat Recovery AHU should be within the operation range of the indoor units.
For more detail about AHU comm. Kit application, please refer to AHU Comm. Kit PDB.
- * : Heat Pump

6. Additional Refrigerant according to Indoor Unit Type

■ Calculation of the amount of additional refrigerant

The calculation of the additional charge should take into account the length of liquid pipe and CF(correctionFactor) value of indoor unit.

Additional charge(kg)	=	L1(m) : Total length of liquid pipe with Ø25.4mm	×	0.480(kg/m)
	+	L2(m) : Total length of liquid pipe with Ø22.2mm	×	0.354(kg/m)
	+	L3(m) : Total length of liquid pipe with Ø19.05mm	×	0.266(kg/m)
	+	L4(m) : Total length of liquid pipe with Ø15.88mm	×	0.173(kg/m)
	+	L5(m) : Total length of liquid pipe with Ø12.7mm	×	0.118(kg/m)
	+	L6(m) : Total length of liquid pipe with Ø9.52mm	×	0.061(kg/m)
	+	L7(m) : Total length of liquid pipe with Ø6.35mm	×	0.022(kg/m)
	+	Number of installed HR units*	×	0.500(kg/EA)
	+	CF value of indoor unit		

* : Only for Heat Recovery models.

◆ Additional refrigerant table (CF value of indoor unit)

Category		Model Name (ARNU**G)	Capacity [Btu/h(kW)]															
			5k	7k	9k	12k	15k	18k	21k	24k	28k	30K	36k	42k	48k	54k	76k	96k
			1.6	2.2	2.8	3.6	4.5	5.6	6.2	7.1	8.2	8.8	10.6	12.3	14.1	15.8	22.4	28.0
Wall Mounted Unit	Standard	SJ*4	0.24	0.24	0.24	0.24	0.24											
		SK*4						0.28			0.28							
		SV*4											0.46	0.46				
ARTCOOL	Mirror	SJ*4	0.24	0.24	0.24	0.24	0.24											
		SK*4						0.28			0.28							
	Gallery	SF*4		0.10	0.10	0.10												
Ceiling Mounted Cassette	1 Way	TU*4		0.20	0.20	0.20												
		TT*4						0.29			0.29							
	2 Way	TS*4			0.34	0.34			0.34			0.34						
			TR*4	0.18	0.18	0.25	0.25											
	4 Way Mini	TQB4					0.32	0.32	0.32									
		TBB4									0.32	0.32	0.32					
	Dual Vane 4-Way	TAB4												0.49	0.49	0.49		
			TAA4	0.68	0.68	0.68	0.68	0.68	0.68		0.68	0.68		0.68	0.68	0.68		
	4way	TP*4										0.32	0.32	0.32				
		TN*4												0.40				
TM*4														0.49	0.49	0.49		
4 way - Compact	TR*4			0.18		0.25												
	TYA4									0.49			0.49		0.49			
Ceiling Concealed Duct	High sensible	M2A4		0.35	0.35	0.35	0.35											
		M3A4						0.61			0.61	0.61						
		B8*4											1.00	1.00	1.00			
	High static	B8*4															1.00	1.00
		M1A4		0.24	0.24	0.24	0.24	0.24			0.36							
		M2A4										0.35		0.35	0.52			
	High static(2)	M3B4														0.61	0.61	
		BH*4		0.26	0.26	0.26	0.26	0.26			0.26	0.44						
	Low static	M3A4													0.61	0.61		
		L1G4	0.14	0.14	0.14													
	Low static (Slim)	L2G4				0.20	0.20	0.20										
		L3G4								0.26	0.26							
		L4G4	0.14	0.14	0.14													
L5G4					0.20	0.20	0.20											
	L6G4								0.26	0.26								
Ceiling & Floor Convertible unit	VE*4			0.10	0.10													
Ceiling Suspended unit	V1A4							0.53		0.53								
	V2A4											0.79		0.79				
Floor standing unit (1)	CE*4		0.17	0.17	0.17	0.17												
	CF*4							0.37			0.37							

6. Additional Refrigerant according to Indoor Unit Type

Category	Model Name (ARNH**G)	Capacity [Btu/h(kW)]															
		5k	7k	9k	12k	15k	18k	21k	24k	28k	30K	36k	42k	48k	54k	76k	96k
Floor standing unit (2)	PT3	1.6	2.2	2.8	3.6	4.5	5.6	6.2	7.1	8.2	8.8	10.6	12.3	14.1	15.8	22.4	28.0
	PF2													0.59			1.32
Console	QA*4		0.17	0.17	0.17	0.17											
Fresh Air Intake unit	B8Z4															1.00	1.00
Hydrokit (ARNH**G)	K2A4												0.80				1.60
	K3A4												0.80			1.00	

MULTI V[™]
Indoor Unit

Indoor Units

Standard Model

Compact Model

MULTI V™
Indoor Unit

Standard Model

- Ceiling Mounted Cassette (1-Way)**
- Ceiling Mounted Cassette (2-Way)**
- Ceiling Mounted Cassette (4-Way Mini)**
- Ceiling Mounted Cassette (Dual Vane 4-Way)**
- Ceiling Mounted Cassette (Dual Vane 4-Way High sensible)**
- Ceiling Mounted Cassette (Round)**
- Ceiling Concealed Duct (High Sensible)**
- Ceiling Concealed Duct (High Static)**
- Ceiling Concealed Duct (High Static(2))**
- Ceiling Concealed Duct (Low Static)**
- Ceiling Concealed Duct (Low Static(Slim))**
- Ceiling & Floor Convertible Unit**
- Ceiling Suspended Unit**
- Floor Standing Unit (1)**
- Floor Standing Unit (2)**
- Fresh Air Intake Unit**
- Wall Mounted Unit (Standard)**
- ARTCOOL (Mirror)**
- ARTCOOL (Gallery)**
- Console**

Ceiling Mounted Cassette (1-Way)

- 1. List of functions**
- 2. Specifications**
- 3. Dimensions**
- 4. Piping Diagrams**
- 5. Wiring Diagrams**
- 6. Capacity Tables**
- 7. Air Velocity and Temperature Distribution**
- 8. Electric Characteristics**
- 9. Sound Levels**

1. List of functions

Category	Function	ARNU07GTU*4, ARNU09GTU*4, ARNU12GTU*4, ARNU18GTT*4, ARNU24GTT*4
Air Flow	Air Supply Outlet	1
	Airflow Direction Control (left & right)	Auto
	Airflow Direction Control (up & down)	Auto
	Auto Swing (left & right)	O
	Auto Swing (up & down)	O
	Airflow Steps (fan/cool/heat)	4 / 5 / 4
	Fan Speed Auto*	Advanced
	Power Cool/Heat	O / X
	Swirl Wind*	X
	Refresh Mode**	X
	Smart Mode**	X
	Indirect Wind*	O
	Direct wind*	O
Dry Operation	O	
Air Purification	Air Purify	Accessory
	Ionizer	X
	UV-C	X
	Pre-Filter	O
Reliability	Hot Start	O
	Self Diagnosis	O
Convenience	Auto Mode	O
	Auto Dry Operation	O
	Auto Restart	O
	Child Lock*	O
	Forced Operation	O
	Group Control*	O
	Sleep Timer	O
	Turn On/Off Reservation	O
	Schedule*	O
	Two Thermistor Control*	O
External On/Off	O	
Installation	Drain Pump	O
	E.S.P. Control*	X
	High Ceiling Operation*	O
Special Functions	Wi-Fi	Accessory
	Auto Elevation Grille	X
	Human Detection Function**	X
	Floor Detection Function**	X

Note

- O : Applied, X : Not Applied, - : Unconfirmed or irrelevant
Embedded : A kit is provided by default for using this function when the product is manufactured.
Accessory : Ordered and purchased separately the accessory package referring to the model name provided and install at field. Accessory line-ups varies by region, so check your local catalogue or local sales material.
- Some functions can be limited by remote controller.
- In case of cassette type indoor units, Air Purification Kit and Auto Elevation Grille functions are not applicable at the same time.
- 'Auto Mode' varies depending on the outdoor unit type.
 - Auto Change Over(Heat Recovery Outdoor Unit)
 - Auto Mode Select(Heat Pump Outdoor Unit)
 - Auto Intensity Control(Cooling Only Outdoor Unit)
- * : These functions need to connect the wired remote controller.
- ** : This functions need to connect to the Standard III wired remote controller.

1. List of functions

■ Accessory Compatibility List

Category	Accessory Name	Model Name	Description	ARNU07GTU*4 ARNU09GTU*4 ARNU12GTU*4
Remote Controller	Wired - Premium	PREMTA000	-	○
		PREMTA000A	-	○
		PREMTA000B	-	○
	Wired - RS3 (Standard III)	PREMTB100/PREMTB101	White	○
		PREMTBB10/PREMTBB11	Black	○
	Wired - RS2 (Standard II)	PREMTB001	White	○
		PREMTBB01	Black	○
	Wired - Simple	PQRCVCL0QW	White	○
		PQRCVCL0Q	Black	○
	Wired - Simple for Hotel	PQRCHCA0QW	White	○
		PQRCHCA0Q	Black	○
	Wireless	PQWRCQ0FDB	For Cooling only	○
		PQWRHQ0FDB	For Heat pump	○
		PWLSSB21C	For Cooling only	○
PWLSSB21H		For Heat pump	○	
Dry Contact	Simple	PDRYCB000	1 input port, AC 220 - 240V	○
		PDRYCB100	1 input port, AC 24V	○
	Communication	PDRYCB400	2 input port	○
		PDRYCB300	8 input port, For 3rd party Thermostat	○
		PDRYCB320	8 input port, For 3rd Party Thermostat (Analog Input)	○
PDRYCB500	For 3rd Party Controller (Modbus RTU)	○		
Integration Device	Remote Temperature sensor	PQRSTA0	-	○
	Group Control wire	PZCWRCG3	Cable Assembly for group control (Y-type cable : 0.25m, cable : 9.6m)	○
ETC	Extension wire	PZCWRC1	Extension wire for IDU-wired remote controller (9.6m)	○
	2-Remo Control Wire	PZCWRC2	-	○
	Wi-Fi Modem	PWFMDD200	-	○
	Wi-Fi Extension cable	PWYREW000	USB Extension cable : 10 m	○
	Independent Power Module	PRIP0	-	○
	Multi-tenant Power Module	PINPMB001	-	○
	Refrigerant Leakage Detector	PRLDNVS0	For R410A only	○
	Human Detection Sensor	PTVSMA0	For Cassette 4-way	X
		PTVSA00	For Cassette Dual Vane 4-way	X
	Floor Detection Sensor	PTFSMA0	-	X
	Auto Elevation Grille	PTEGM0	For TP/TN/TM	X
	Air Purification Kit	PTAHTP0	For Cassette 1-way	○
		PTAHMP0	For Cassette 4-way	X
		PTAHYP0	For Cassette Round	X
	EEV Kit	PRGK024A0	For Multi V Indoor Unit	○
	Auxiliary Heater Relay Kit	PRARS1	For Wall Mounted and Art Cool Indoor Units	X
		PRARH1	For Cassette and Duct Indoor Units	○
	Ventilation Kit	PTVK430	For TR/TQ/TP/TN/TM	X
		PTVK410 + PTVK420	For TP/TN/TM	X
	Cassette Cover	PTDCQ	For TR/TQ	X
PTDCM		For TP/TN/TM	X	
PTDCA		For TM-A/TP-B	X	

Note

1. O: Possible, X: Impossible, -: Not applicable, Embedded: Included with product.
2. If there is a difference in development time between the product and the remote controller, some functions cannot be operated.
3. If using Wi-Fi controller, Some advanced functions controlled by remote controller cannot be operated.
4. If you need more detail, please refer to the **BECON** PDB or the manual of product. (<http://partner.lge.com/global> : Home> Doc.Library> Product > Control(BECON))

1. List of functions

Category	Accessory Name	Model Name	Description	ARNU18GTT*4 ARNU24GTT*4
Remote Controller	Wired - Premium	PREMTA000	-	○
		PREMTA000A	-	○
		PREMTA000B	-	○
	Wired - RS3 (Standard III)	PREMTB100/PREMTB101	White	○
		PREMTBB10/PREMTBB11	Black	○
	Wired - RS2 (Standard II)	PREMTB001	White	○
		PREMTBB01	Black	○
	Wired - Simple	PQRCVCL0QW	White	○
		PQRCVCL0Q	Black	○
	Wired - Simple for Hotel	PQRCHCA0QW	White	○
		PQRCHCA0Q	Black	○
	Wireless	PQWRCQ0FDB	For Cooling only	○
		PQWRHQ0FDB	For Heat pump	○
		PWLSSB21C	For Cooling only	○
PWLSSB21H		For Heat pump	○	
Dry Contact	Simple	PDRYCB000	1 input port, AC 220 - 240V	○
		PDRYCB100	1 input port, AC 24V	○
	Communication	PDRYCB400	2 input port	○
		PDRYCB300	8 input port, For 3rd party Thermostat	○
		PDRYCB320	8 input port, For 3rd Party Thermostat (Analog Input)	○
PDRYCB500	For 3rd Party Controller (Modbus RTU)	○		
Integration Device	Remote Temperature sensor	PQRSTA0	-	○
	Group Control wire	PZCWRCG3	Cable Assembly for group control (Y-type cable : 0.25m, cable : 9.6m)	○
ETC	Extension wire	PZCWRC1	Extension wire for IDU-wired remote controller (9.6m)	○
	2-Remo Control Wire	PZCWRC2	-	○
	Wi-Fi Modem	PWFMDD200	-	○
	Wi-Fi Extension cable	PWYREW000	USB Extension cable : 10 m	○
	Independent Power Module	PRIP0	-	○
	Multi-tenant Power Module	PINPMB001	-	○
	Refrigerant Leakage Detector	PRLDNVS0	For R410A only	○
	Human Detection Sensor	PTVSMA0	For Cassette 4-way	X
		PTVSA0	For Cassette Dual Vane 4-way	X
	Floor Detection Sensor	PTFSMA0	-	X
	Auto Elevation Grille	PTEGM0	For TP/TN/TM	X
	Air Purification Kit	PTAHTP0	For Cassette 1-way	○
		PTAHMP0	For Cassette 4-way	X
		PTAHYP0	For Cassette Round	X
	EEV Kit	PRGK024A0	For Multi V Indoor Unit	X
	Auxiliary Heater Relay Kit	PRARS1	For Wall Mounted and Art Cool Indoor Units	X
		PRARH1	For Cassette and Duct Indoor Units	○
	Ventilation Kit	PTVK430	For TR/TQ/TP/TN/TM	X
PTVK410 + PTVK420		For TP/TN/TM	X	
Cassette Cover	PTDCQ	For TR/TQ	X	
	PTDCM	For TP/TN/TM	X	
	PTDCA	For TM-A/TP-B	X	

Note

1. ○: Possible, X: Impossible, -: Not applicable, Embedded : Included with product.
2. If there is a difference in development time between the product and the remote controller, some functions cannot be operated.
3. If using Wi-Fi controller, Some advanced functions controlled by remote controller cannot be operated.
4. If you need more detail, please refer to the **BECON** PDB or the manual of product. (<http://partner.lge.com/global> : Home> Doc.Library> Product > Control(BECON))

1. List of functions

■ Panel(Accessory)

Model Name			PT-UUC	PT-UAHW0	PT-UUD	PT-UAHG0	PT-UPHG0
Applied Chassis	-		TU	TU	TU	TU	TU
Description	-		Standard Panel	Standard Panel	Standard Panel	Standard Panel	Premium Panel
Exterior Color	-		White	White	White	White	White
RAL Code	-		RAL 9003	RAL 9003	RAL 9003	RAL 9003	RAL 9003
Dual Vane	-		X	X	X	X	X
Dimensions (W x H x D)	Net	mm	1,100 x 34 x 500	1,100 x 34 x 500	1,100 x 34 x 500	1,160 x 34 x 500	1,160 x 34 x 500
	Shipping	mm	1,163 x 175 x 558	11,50 x 132 x 570	1,163 x 175 x 558	1,200 x 114 x 552	1,200 x 114 x 552
Weight	Net	kg	4.6	3.3	5.3	3.9	4.1
	Shipping	kg	6.3	4.7	8.1	5.6	5.8
Function	PM1.0 Sensor	-	X	X	X	X	O
Accessory	Air Purification Kit	-	X	X	X	x	PTAHTP0
	Floor Detection Sensor*	-	X	X	X	X	X
	Human Detection Sensor*	-	X	X	X	X	X

Note

- Accessory : Ordered and purchased separately the accessory package referring to the model name provided and install at field.
- * : This functions need to connect to the RS3 wired remote controller(Standard III).

Model Name			PT-UTC	PT-TAHW0	PT-UTD	PT-TAHG0	PT-TPHG0
Applied Chassis	-		TT	TT	TT	TT	TT
Description	-		Standard Panel	Standard Panel	Standard Panel	Standard Panel	Premium Panel
Exterior Color	-		White	White	White	White	White
RAL Code	-		RAL 9003	RAL 9003	RAL 9003	RAL 9003	RAL 9003
Dual Vane	-		X	X	X	X	X
Dimensions (W x H x D)	Net	mm	1,420 x 34 x 500	1,420 x 34 x 500	1,420 x 34 x 500	1,480 x 34 x 500	1,480 x 34 x 500
	Shipping	mm	1,475 x 180 x 562	1,470 x 132 x 570	1,483 x 175 x 558	1,520 x 114 x 552	1,520 x 114 x 552
Weight	Net	kg	5.5	4.5	5.6	4.8	4.9
	Shipping	kg	8.6	6.5	9.9	6.9	7.1
Function	PM1.0 Sensor	-	X	X	X	X	O
Accessory	Air Purification Kit	-	X	X	X	x	PTAHTP0
	Floor Detection Sensor*	-	X	X	X	X	X
	Human Detection Sensor*	-	X	X	X	X	X

Note

- Accessory : Ordered and purchased separately the accessory package referring to the model name provided and install at field.
- * : This functions need to connect to the RS3 wired remote controller(Standard III).

2. Specifications

* : A (China Only), B (Basic)

Model		Unit	ARNU07GTU*4	ARNU09GTU*D4
Cooling Capacity		kW	2.2	2.8
		kcal/h	1,900	2,400
		Btu/h	7,500	9,600
Heating Capacity		kW	2.5	3.2
		kcal/h	2,200	2,800
		Btu/h	8,500	10,900
Power Input (H / M / L)		W	20 / 18 / 16	22 / 20 / 18
Casing			Galvanized Steel Plate	Galvanized Steel Plate
Dimensions (WxHxD)	Body	mm	860 x 132 x 450	860 x 132 x 450
		inch	33-27/32 x 5-3/16 x 17-23/32	33-27/32 x 5-3/16 x 17-23/32
Coil	Rows x Columns x FPI		2 x 12 x 18	2 x 12 x 18
	Face Area	m ²	0.16	0.16
Fan	Type		Cross Flow Fan	Cross Flow Fan
	Motor Output x Number		W	30
	Air Flow Rate (H / M / L)	m ³ /min	8.2 / 7.3 / 6.4	9.2 / 8.6 / 8.2
		ft ³ /min	289.5 / 257.7 / 225.9	324.7 / 303.6 / 289.5
	Drive		Direct	Direct
Motor type		BLDC	BLDC	
Temperature Control			Microprocessor, Thermostat for cooling and heating	
Sound Absorbing Thermal Insulation Material			Foamed polystyrene	Foamed polystyrene
Safety Device			Fuse	Fuse
Pipe Connections	Liquid Side	mm(inch)	Ø6.35(1/4)	Ø6.35(1/4)
	Gas Side	mm(inch)	Ø12.7(1/2)	Ø12.7(1/2)
	Drain Pipe(Internal Dia.)	mm(inch)	25(1)	25(1)
Net Weight	Body	kg(lbs)	12.2(26.9)	12.2(26.9)
Sound Pressure Levels (H / M / L)		dB(A)	32 / 29 / 25	35 / 34 / 32
Sound Power Levels (H / M / L)		dB(A)	47 / 44 / 41	51 / 49 / 47
Power Supply		Ø, V, Hz	1, 220 - 230 - 240, 50/60	1, 220 - 230 - 240, 50/60
Running Current by voltage	Rated	A	0.15 - 0.14 - 0.14	0.17- 0.16 - 0.15
Maximum Running Current		A	0.18	0.18
Refrigerant	Type		-	R410A / R32
	Additional Charging Amount (CF Value of IDU)		kg(each)	0.20 / 0.17
	Control		-	EEV
Transmission cable			1.0~1.5 x 2C	1.0~1.5 x 2C

Note

1. Due to our policy of innovation some specifications may be changed without notification.
2. Wiring cable size must comply with the applicable local and national code. And "Electric characteristics" chapter should be considered for electrical work and design. Especially the power cable and circuit breaker should be selected in accordance with that.
3. Sound pressure level is measured on the rated condition in the anechoic rooms by ISO 3745 standard.
Sound power level is measured on the rated condition in the semi-anechoic rooms by ISO 9614 standard.
Therefore, these values can be increased owing to ambient conditions during operation.
4. Capacities are net capacities and based on the following conditions. Refer to the Outdoor Unit Specifications for calculating the real capacity.
 - Cooling : Indoor Ambient Temp. 27°CDB / 19°CWB, Outdoor Ambient Temp. 35°CDB / 24°CWB
 - Heating : Indoor Ambient Temp. 20°CDB / 15°CWB, Outdoor Ambient Temp. 7°CDB / 6°CWB
 - Interconnected Pipe is standard length and difference of Elevation (Outdoor ~ Indoor Unit) is 0m.
5. Refrigerant information (type, additional charging amount, etc.) must be applied by refrigerant type of the combined outdoor unit.
Adapt after checking the specifications of outdoor unit.

2. Specifications

* : A (China Only), B (Basic)

Model		Unit	ARNU12GTU*4
Cooling Capacity		kW	3.6
		kcal/h	3,100
		Btu/h	12,300
Heating Capacity		kW	4.0
		kcal/h	3,400
		Btu/h	13,600
Power Input (H / M / L)		W	24 / 22 / 20
Casing			Galvanized Steel Plate
Dimensions (WxHxD)	Body	mm	860 x 132 x 450
		inch	33-27/32 x 5-3/16 x 17-23/32
Coil	Rows x Columns x FPI		2 x 12 x 18
	Face Area	m ²	0.16
Fan	Type		Cross Flow Fan
	Motor Output x Number	W	30
	Air Flow Rate (H / M / L)	m ³ /min	10 / 9.2 / 8.2
		ft ³ /min	353 / 324.8 / 289.5
	Drive		Direct
Motor type		BLDC	
Temperature Control			Microprocessor, Thermostat for cooling and heating
Sound Absorbing Thermal Insulation Material			Foamed polystyrene
Safety Device			Fuse
Pipe Connections	Liquid Side	mm(inch)	Ø6.35(1/4)
	Gas Side	mm(inch)	Ø12.7(1/2)
	Drain Pipe(Internal Dia.)	mm(inch)	25(1)
Net Weight	Body	kg(lbs)	12.2(26.9)
Sound Pressure Levels (H / M / L)		dB(A)	38 / 35 / 32
Sound Power Levels (H / M / L)		dB(A)	52 / 51 / 47
Power Supply		Ø, V, Hz	1, 220 - 230 - 240, 50/60
Running Current by voltage	Rated	A	0.18 - 0.17 - 0.17
Maximum Running Current		A	0.18
Refrigerant	Type	-	R410A / R32
	Additional Charging Amount (CF Value of IDU)	kg(each)	0.20 / 0.17
	Control	-	EEV
Transmission cable			1.0~1.5 x 2C

Note

- Due to our policy of innovation some specifications may be changed without notification.
- Wiring cable size must comply with the applicable local and national code. And "Electric characteristics" chapter should be considered for electrical work and design. Especially the power cable and circuit breaker should be selected in accordance with that.
- Sound pressure level is measured on the rated condition in the anechoic rooms by ISO 3745 standard.
Sound power level is measured on the rated condition in the semi-anechoic rooms by ISO 9614 standard.
Therefore, these values can be increased owing to ambient conditions during operation.
- Capacities are net capacities and based on the following conditions. Refer to the Outdoor Unit Specifications for calculating the real capacity.
 - Cooling : Indoor Ambient Temp. 27°CDB / 19°CWB, Outdoor Ambient Temp. 35°CDB / 24°CWB
 - Heating : Indoor Ambient Temp. 20°CDB / 15°CWB, Outdoor Ambient Temp. 7°CDB / 6°CWB
 - Interconnected Pipe is standard length and difference of Elevation (Outdoor ~ Indoor Unit) is 0m.
- Refrigerant information (type, additional charging amount, etc.) must be applied by refrigerant type of the combined outdoor unit.
Adapt after checking the specifications of outdoor unit.

2. Specifications

* : A (China Only), B (Basic)

Model		Unit	ARNU18GTT*4	ARNU24GTT*4
Cooling Capacity		kW	5.6	7.1
		kcal/h	4,800	6,100
		Btu/h	19,100	24,200
Heating Capacity		kW	6.3	7.1
		kcal/h	5,400	6,100
		Btu/h	21,500	24,200
Power Input (H / M / L)		W	38 / 28 / 24	51 / 33 / 26
Casing			Galvanized Steel Plate	Galvanized Steel Plate
Dimensions (WxHxD)	Body	mm	1,180 x 132 x 450	1,180 x 132 x 450
		inch	46-15/32 x 5-3/16 x 17-23/32	46-15/32 x 5-3/16 x 17-23/32
Coil	Rows x Columns x FPI		2 x 12 x 18	2 x 12 x 18
	Face Area	m ²	0.24	0.24
Fan	Type		Cross Flow Fan	Cross Flow Fan
	Motor Output x Number	W	30	30
	Air Flow Rate (H / M / L)	m ³ /min	13.3 / 12.1 / 10.9	14.6 / 13.3 / 11.5
		ft ³ /min	469.5 / 427.1 / 384.8	515.4 / 469.5 / 406
	Drive		Direct	Direct
Motor type		BLDC	BLDC	
Temperature Control			Microprocessor, Thermostat for cooling and heating	
Sound Absorbing Thermal Insulation Material			Foamed polystyrene	Foamed polystyrene
Safety Device			Fuse	Fuse
Pipe Connections	Liquid Side	mm(inch)	Ø6.35(1/4)	Ø9.52(3/8)
	Gas Side	mm(inch)	Ø12.7(1/2)	Ø15.88(5/8)
	Drain Pipe(Internal Dia.)	mm(inch)	25(1)	25(1)
Net Weight	Body	kg(lbs)	15.3(33.7)	15.3(33.7)
Sound Pressure Levels (H / M / L)		dB(A)	40 / 37 / 35	43 / 40 / 36
Sound Power Levels (H / M / L)		dB(A)	55 / 51 / 47	58 / 53 / 49
Power Supply		Ø, V, Hz	1, 220 - 230 - 240, 50/60	1, 220 - 230 - 240, 50/60
Running Current by voltage	Rated	A	0.22 - 0.21 - 0.20	0.29 - 0.28 - 0.27
Maximum Running Current		A	0.30	0.30
Refrigerant	Type	-	R410A / R32	R410A / R32
	Additional Charging Amount (CF Value of IDU)	kg(each)	0.29 / 0.24	0.29 / 0.24
	Control	-	EEV	EEV
Transmission cable			1.0~1.5 x 2C	1.0~1.5 x 2C

Note

- Due to our policy of innovation some specifications may be changed without notification.
- Wiring cable size must comply with the applicable local and national code. And "Electric characteristics" chapter should be considered for electrical work and design. Especially the power cable and circuit breaker should be selected in accordance with that.
- Sound pressure level is measured on the rated condition in the anechoic rooms by ISO 3745 standard.
Sound power level is measured on the rated condition in the semi-anechoic rooms by ISO 9614 standard.
Therefore, these values can be increased owing to ambient conditions during operation.
- Capacities are net capacities and based on the following conditions. Refer to the Outdoor Unit Specifications for calculating the real capacity.
 - Cooling : Indoor Ambient Temp. 27°CDB / 19°CWB, Outdoor Ambient Temp. 35°CDB / 24°CWB
 - Heating : Indoor Ambient Temp. 20°CDB / 15°CWB, Outdoor Ambient Temp. 7°CDB / 6°CWB
 - Interconnected Pipe is standard length and difference of Elevation (Outdoor ~ Indoor Unit) is 0m.
- Refrigerant information (type, additional charging amount, etc.) must be applied by refrigerant type of the combined outdoor unit.
Adapt after checking the specifications of outdoor unit.

3. Dimensions

◆ ARNU07GTU*4 / ARNU09GTU*4 / ARNU12GTU*4 (Standard, Bright)

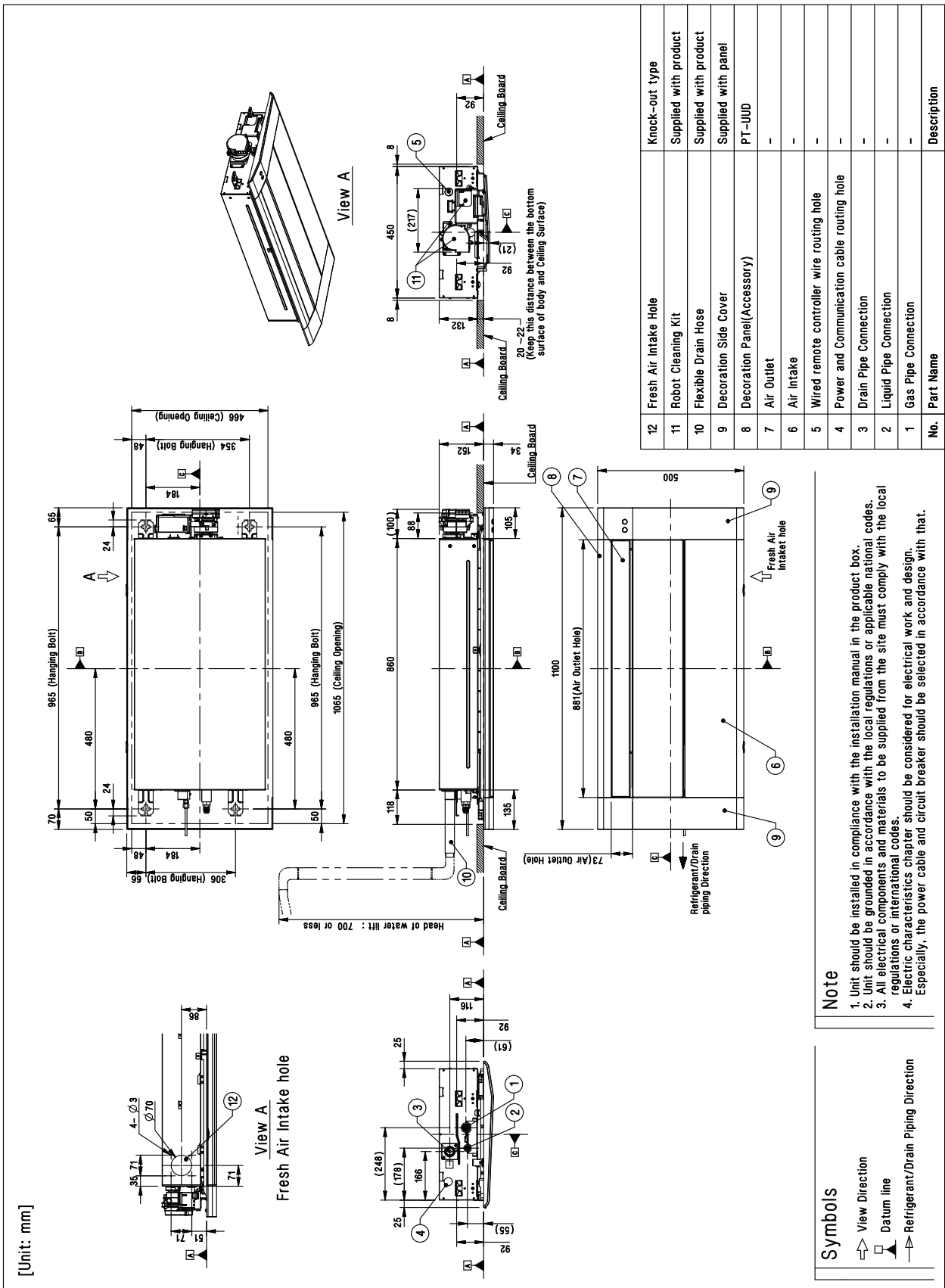

3. Dimensions

◆ ARNU07GTU*4 / ARNU09GTU*4 / ARNU12GTU*4 (Standard, Bright)

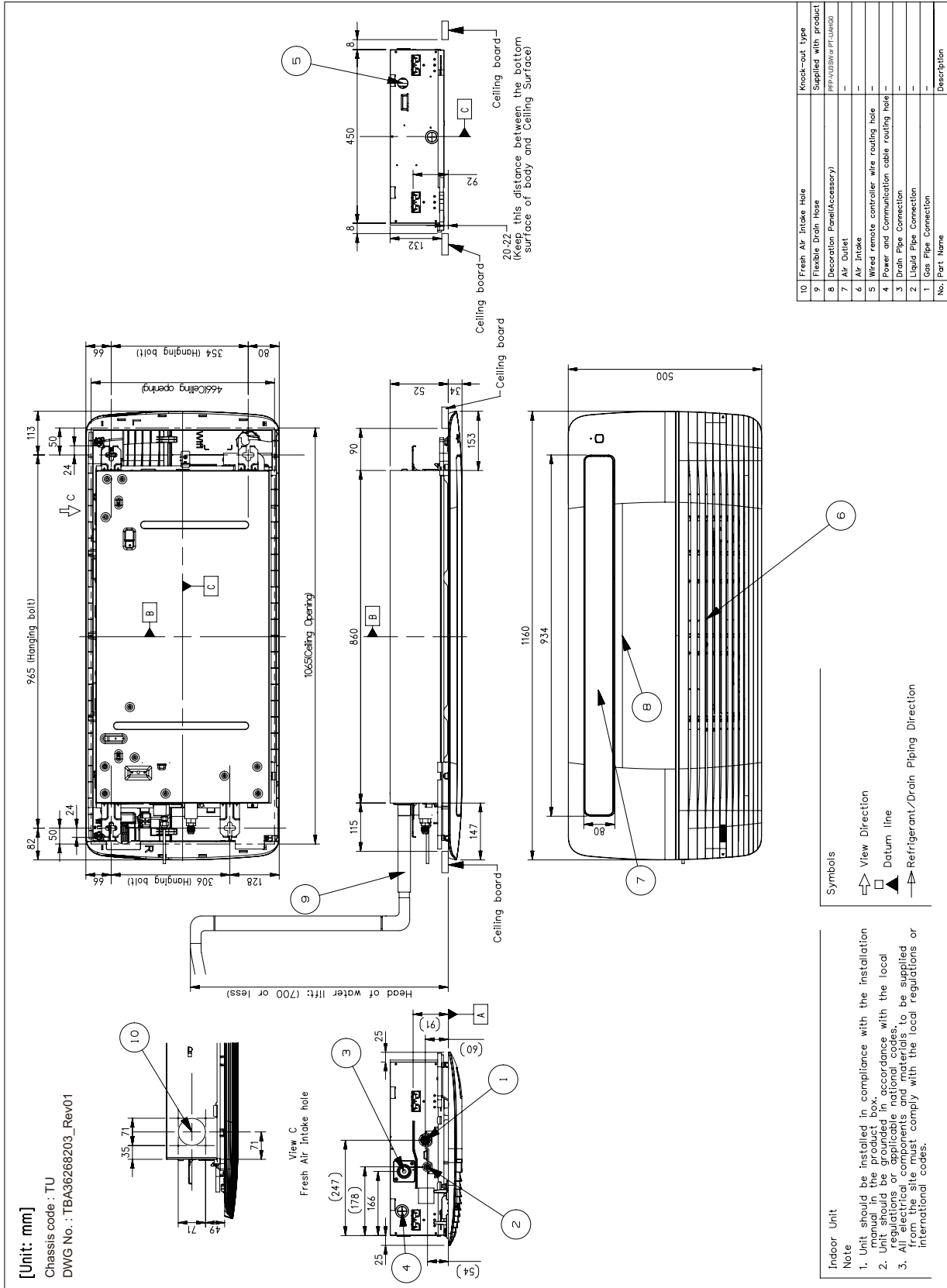

3. Dimensions

◆ ARNU07GTU*4 / ARNU09GTU*4 / ARNU12GTU*4 (Air Clean, Bright)

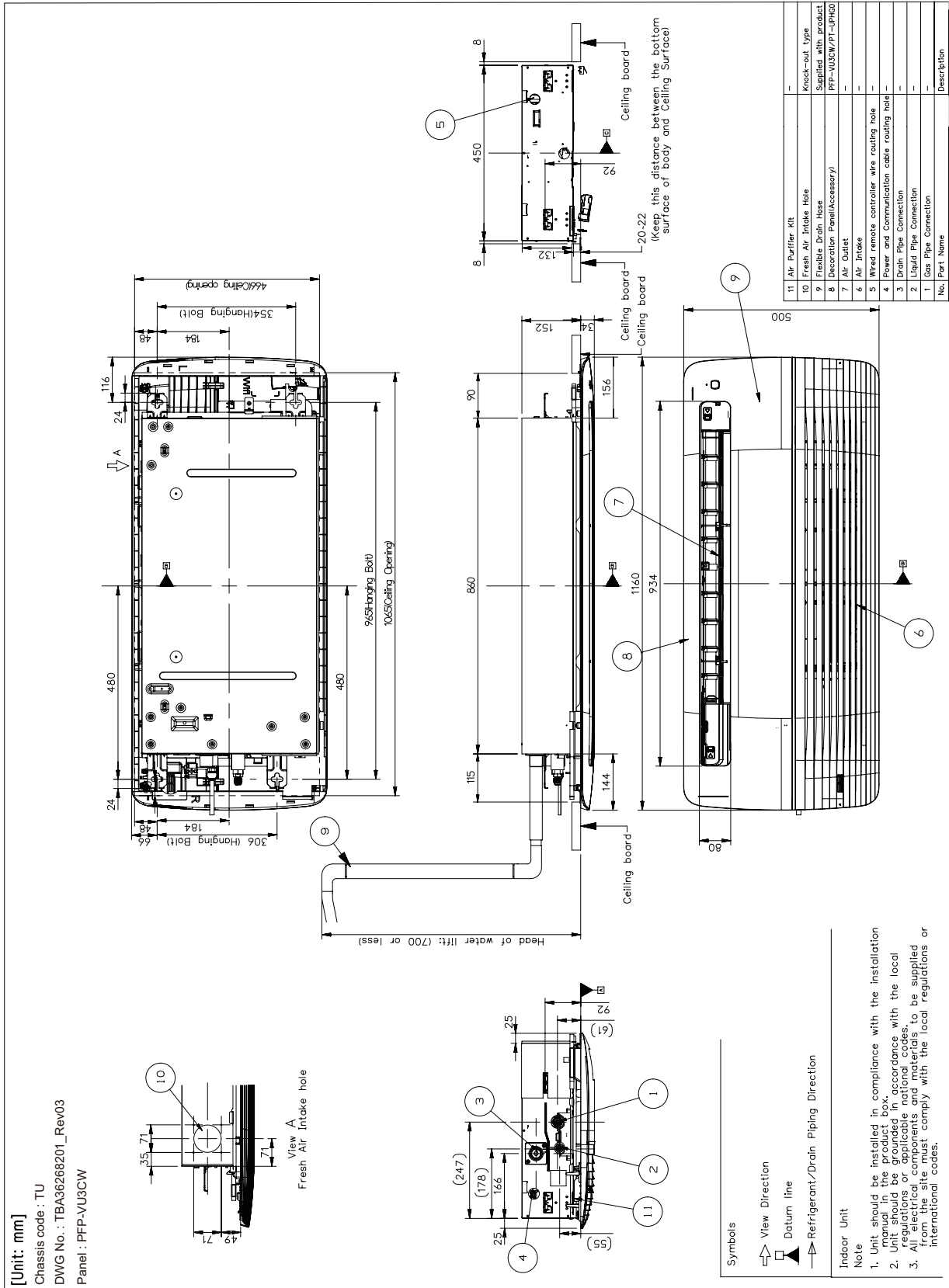

3. Dimensions

◆ ARNU18GTT*4 / ARNU24GTT*4 (Standard, Bright)

[Unit: mm]

Chassis code : TT
TBA35228701_Rev.01

View A
Fresh Air Intake hole

View B
Fresh Air Intake hole

3D View

No.	Part Name	Knock-out type	Description
12	Fresh Air Intake Hole	Supplied with product	
11	Robot Cleaning Kit	Supplied with product	
10	Flexible Drain Hose	Supplied with product	
9	Decoration Side Cover	Supplied with panel	
8	Decoration Panel(Accessory)	PT-UTD	
7	Air Outlet	-	
6	Air Intake	-	
5	Wired remote controller wire routing hole	-	
4	Power and Communication cable routing hole	-	
3	Drain Pipe Connection	-	
2	Liquid Pipe Connection	-	
1	Gas Pipe Connection	-	

Note

- Unit should be installed in compliance with the installation manual in the product box.
- Unit should be grounded in accordance with the local regulations or applicable national codes.
- All electrical components and materials to be supplied from the site must comply with the local regulations or international codes.
- Electric characteristics chapter should be considered for electrical work and design. Especially, the power cable and circuit breaker should be selected in accordance with that.

Symbols

- View Direction
- Datum line
- Refrigerant/Drain Piping Direction

3. Dimensions

◆ ARNU18GTT*4 / ARNU24GTT*4 (Standard, Bright)

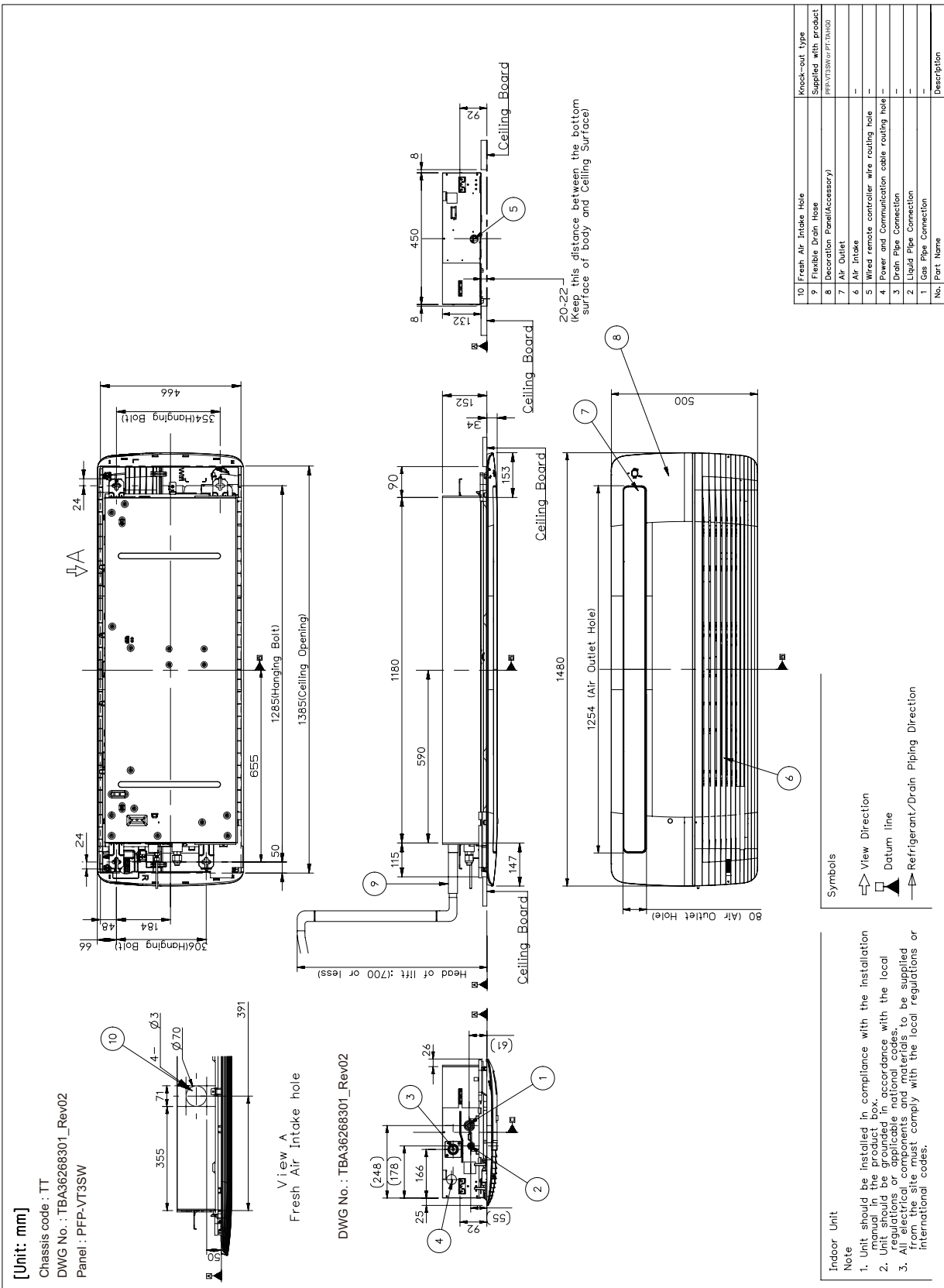

3. Dimensions

◆ ARNU18GTT*4 / ARNU24GTT*4 (Air Clean, Bright)

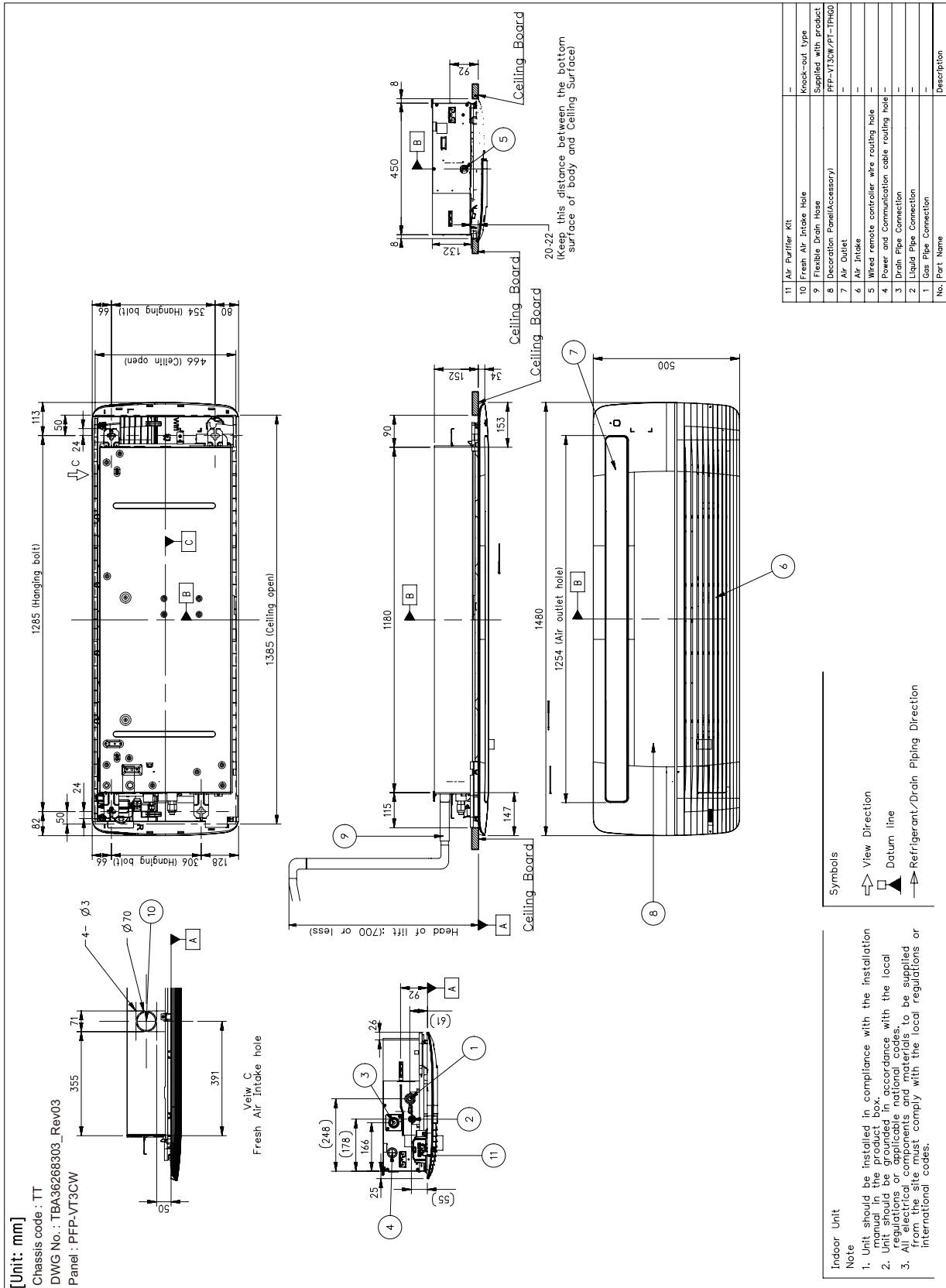

3. Dimensions

3.2 Installation Space

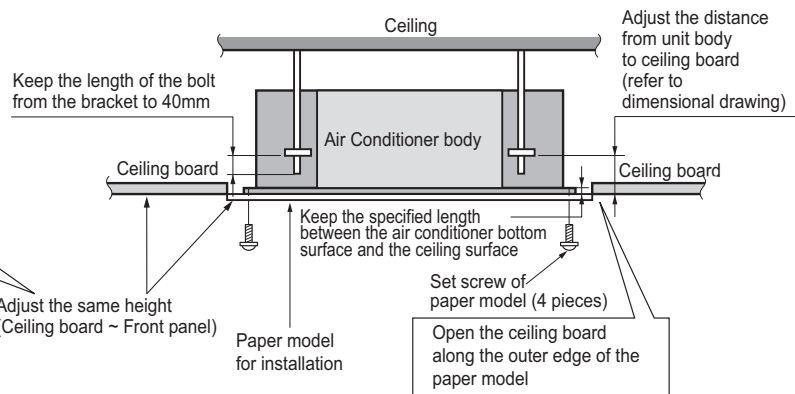
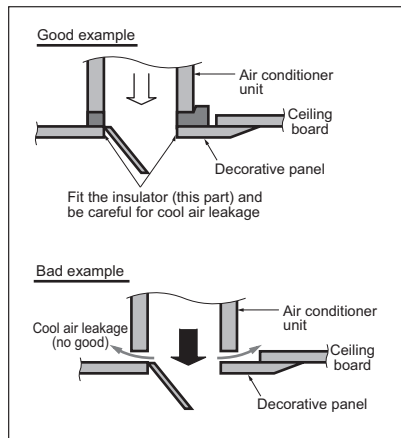
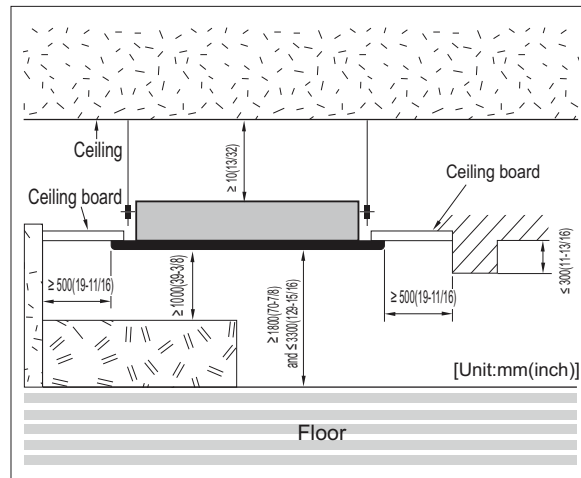

Note

- Places where products are installed should not be any obstacles to the air circulation or installation. Ensure the spaces from the wall, ceiling, or other obstacles.
- According to type of indoor unit, external appearance or installed structure could be different.
- According to product type, model line up, sales region..etc, applicability of each chassis could be different.
- Install certainly the decoration panel. Cool air leakage causes sweating or falling of water-drops.

4. Piping Diagrams

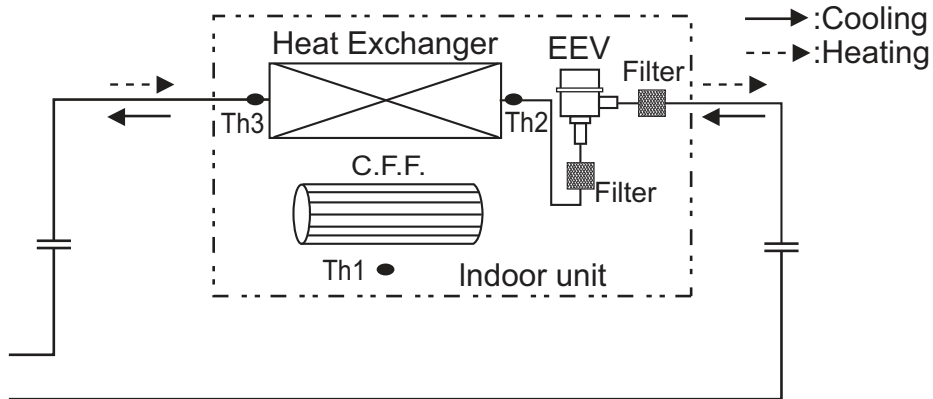

◆ Refrigerant pipe connection port diameter

Model	Gas [mm(inch)]	Liquid [mm(inch)]
ARNU07GTU*4	Ø12.7(1/2)	Ø6.35(1/4)
ARNU09GTU*4		
ARNU12GTU*4		
ARNU18GTT*4		
ARNU24GTT*4	Ø15.88(5/8)	Ø9.52(3/8)

LOC.	Description
Th1	Room thermistor
Th2	Pipe in thermistor
Th3	Pipe out thermistor

5. Wiring Diagrams

TU, TT Chassis

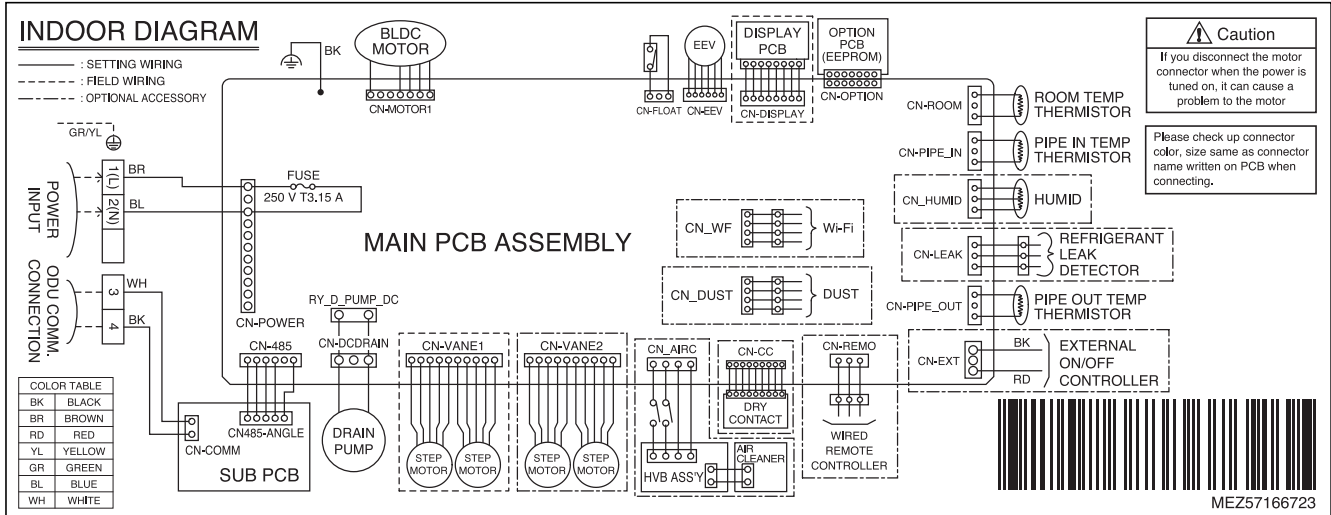

CONNECTOR NUMBER	LOCATION POINT	FUNCTION
CN-MOTOR1	Fan motor output	Motor output of BLDC
CN_DPUMP	Drain pump output	AC output for drain pump
CN-GRILL	Elevation grill	Elevation grill line
CN-PTC	Aux heater	Aux heater line
CN-LEAK	Refrigerant leak detector	Refrigerant leak detector line
CN-AIRC	Air cleaner	Air cleaner line
CN-DISPLAY	Display	Display of indoor status
CN-OPTION	Option pwb.	Communication between main and option
CN-EEV	EEV Output	EEV Control output : connect to EEV directly or through IPM(Independent Power Module)
CN-FLOAT	Float switch input	Float switch sensing
CN-ROOM	Room sensor	Room air thermistor
CN-PIPE_IN	Suction pipe sensor	Pipe in thermistor
CN-PIPE_OUT	Discharge pipe sensor	Pipe out thermistor
CN-REMO	Remote controller	Remote control line
CN-CC	Dry contact	Dry contact line
CN-COMM	Communication	Communication between indoor and outdoor
CN-VANE1	Step motor	Step motor output
CN-VANE2	Step motor	Step motor output
CN-485	Communication	Connection between indoor and outdoor
CN-EXT	External On/Off	External On/Off signal input
CN_WF	Wi-Fi Controller	Wifi control line
CN_DUST	Dust sensor	Dust detector line
CN_HUMID	Humid sensor	Humid sensing

Dip Switch Setting	Off	On	Remarks
SW3 GROUP	Master	Slave	Group Control setting using Wired Remote Controller
SW4 DRY CONTACT	Variable	Auto	Old Dry Contact Mode Setting 1. Variable : Auto/Manual Mode can be chosen by Wide wired remote controller or Wireless remote controller (When shipped from Factory → Manual Mode) 2. Auto : For Dry Contact, it is always Auto mode.
SW5 EXTRA 1	Off	On	1. Duct model -. OFF : Default(not operate continuously) -. ON : Fan operate continuously 2. Cassette Model : No Function 3. Ceiling Suspended Model -. OFF : Ceiling(default) -. ON : Floor

CAUTION
 For Multi V Model, Dip Switch 1,2,6,7,8 must be set OFF
 That dip switch is used for the other model.

6. Capacity Tables

■ Cooling Capacity

Nominal Capacity (kBtu/h) [Capacity Index (kW)]	Indoor air temp. (DB/WB, °C)													
	20		23		26		27		28		30		32	
	14		16		18		19		20		22		24	
	TC	SHC	TC	SHC	TC	SHC	TC	SHC	TC	SHC	TC	SHC	TC	SHC
7 [2.2]	1.5	1.3	1.8	1.4	2.0	1.6	2.2	1.6	2.4	1.7	2.4	1.6	2.4	1.4
9 [2.8]	1.9	1.6	2.2	1.8	2.6	2.0	2.8	2.0	3.0	2.1	3.0	2.0	3.1	1.8
12 [3.6]	2.4	2.1	2.9	2.3	3.3	2.5	3.6	2.6	3.9	2.7	3.9	2.5	4.0	2.3
18 [5.6]	3.8	3.2	4.5	3.5	5.2	3.8	5.6	3.9	6.0	4.1	6.1	3.8	6.2	3.5
24 [7.1]	4.8	3.8	5.7	4.4	6.6	4.9	7.1	5.1	7.6	5.2	7.7	4.9	7.8	4.5

Note

1. TC: Total Capacity(kW), SHC: Sensible Heat Capacity(kW)
2. Capacity tables show the average value of conditions which may occur.
3. Refer to Capacity tables and correction factor in the outdoor unit PDB for the actual performance data of each indoor unit and outdoor unit combination.

■ Heating Capacity

Nominal Capacity (kBtu/h) [Capacity Index (kW)]	Indoor air temp. (DB, °C)					
	16	18	20	21	22	24
	TC	TC	TC	TC	TC	TC
7 [2.2]	2.8	2.7	2.5	2.4	2.3	2.2
9 [2.8]	3.6	3.4	3.2	3.1	3.0	2.8
12 [3.6]	4.5	4.3	4.0	3.9	3.7	3.5
18 [5.6]	7.1	6.7	6.3	6.1	5.9	5.5
24 [7.1]	8.0	7.6	7.1	6.9	6.6	6.2

Note

1. TC: Total Capacity(kW)
2. Capacity tables show the average value of conditions which may occur.
3. Refer to Capacity tables and correction factor in the outdoor unit PDB for the actual performance data of each indoor unit and outdoor unit combination.

7. Air Velocity and Temperature Distribution

◆ ARNU07GTU*4

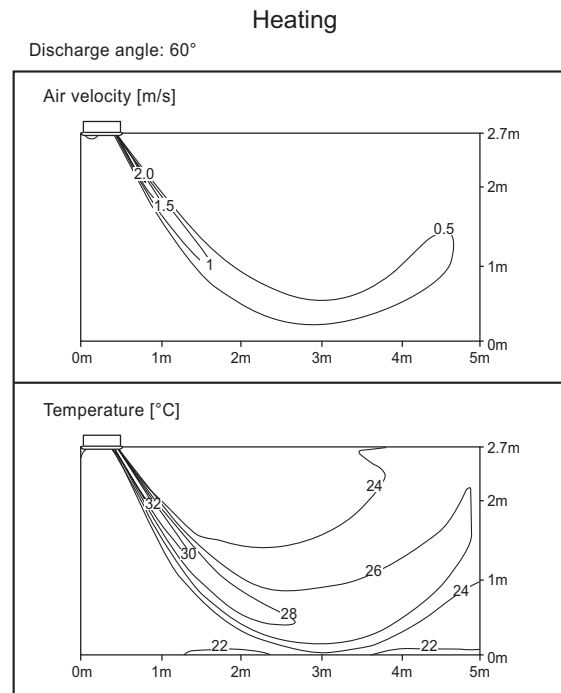
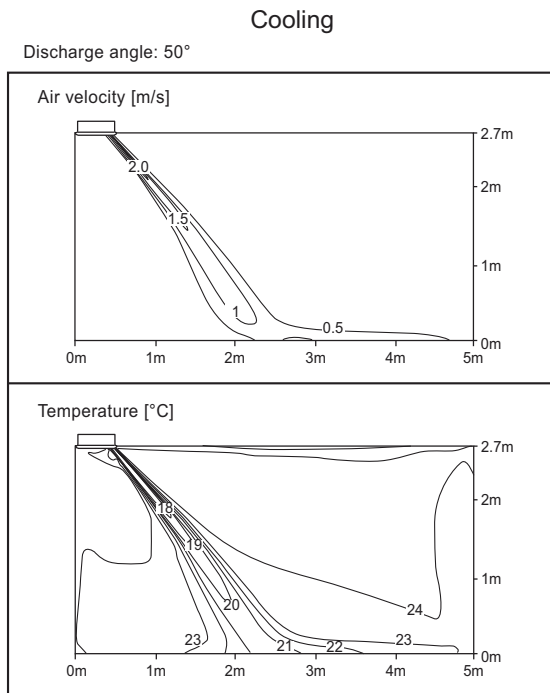

◆ ARNU09GTU*4

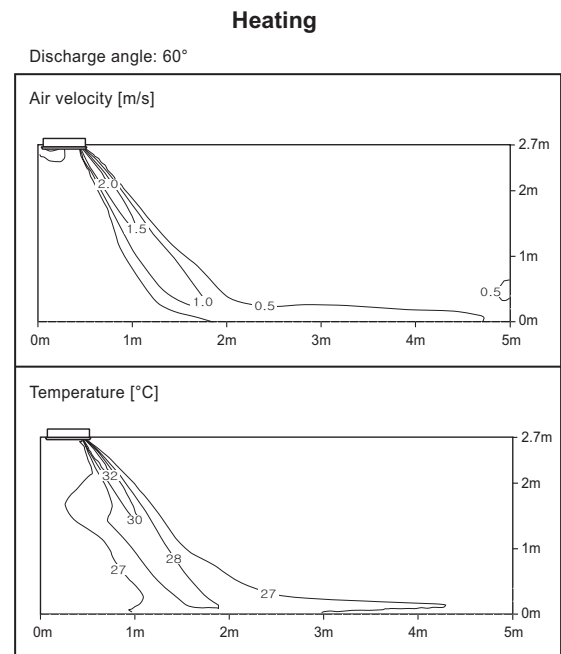
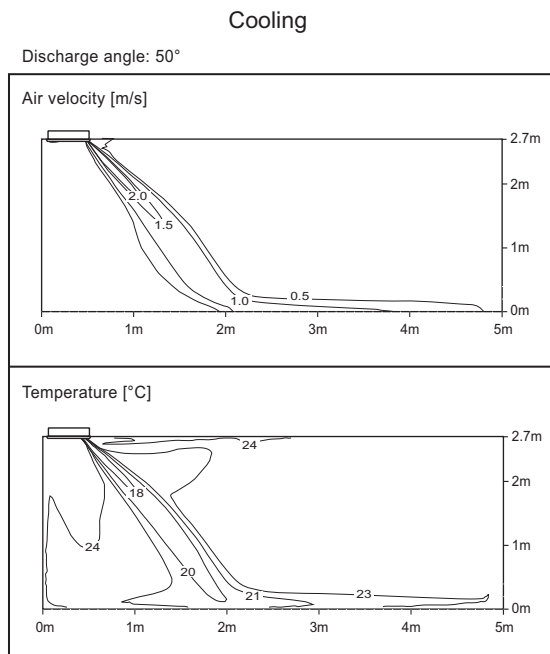

Note

- These figures are accordance with normal certain condition and environment. (Airflow step is 'High', Air discharge angle is fixed as indicated angle.)
- Indoor airflow distribution under actual installation or operating conditions depends on ambient temperature, ceiling height, product installation direction / location, indoor / Heating load, and other obstacles, etc.

7. Air Velocity and Temperature Distribution

◆ ARNU12GTU*4

Cooling

Discharge angle: 50°

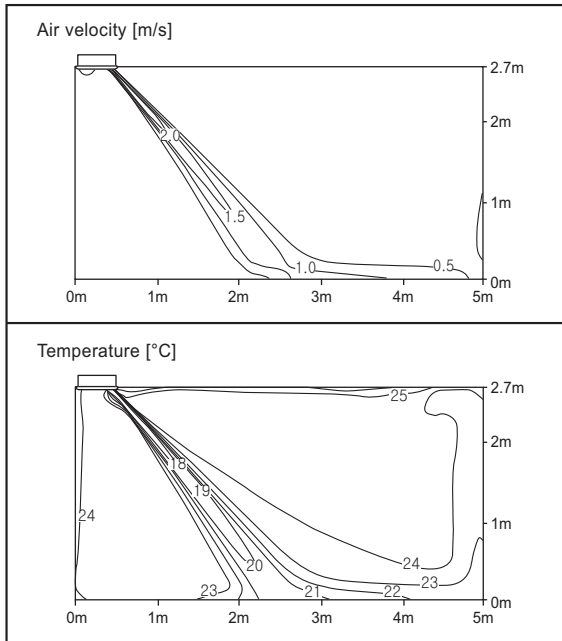

Heating

Discharge angle: 60°

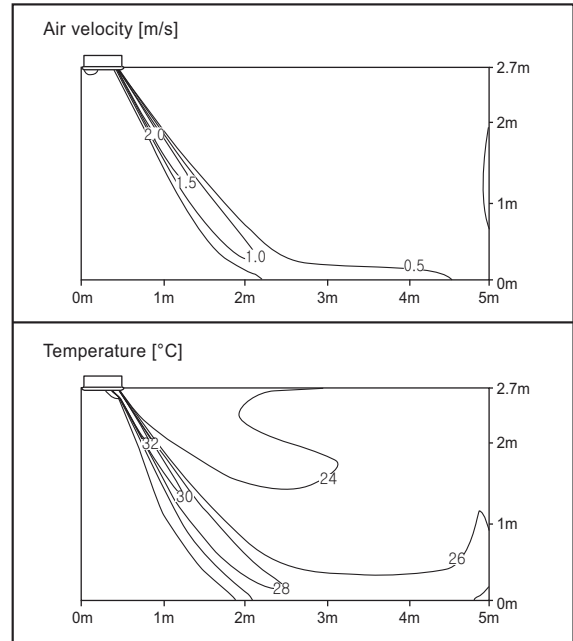

◆ ARNU18GTT*4

Cooling

Discharge angle: 50°

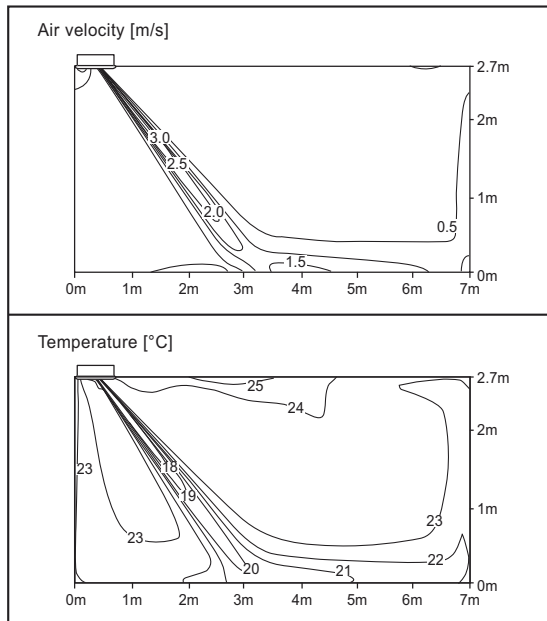

Heating

Discharge angle: 60°

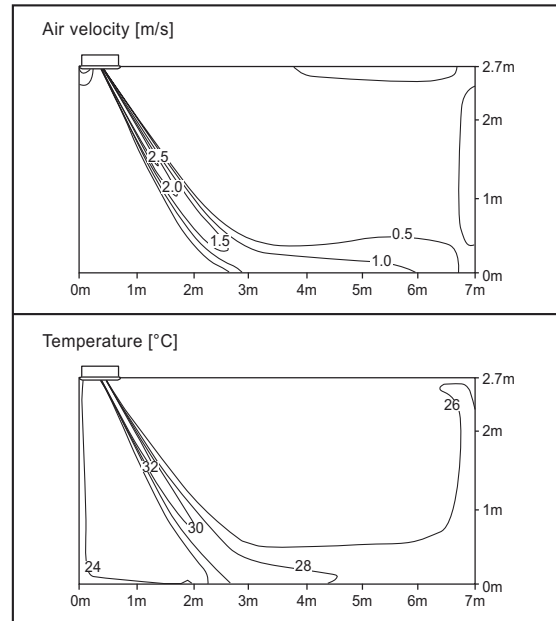

Note

- These figures are accordance with normal certain condition and environment. (Airflow step is 'High', Air discharge angle is fixed as indicated angle.)
- Indoor airflow distribution under actual installation or operating conditions depends on ambient temperature, ceiling height, product installation direction / location, indoor / Heating load, and other obstacles, etc.

7. Air Velocity and Temperature Distribution

◆ ARNU24GTT*4

Cooling

Discharge angle: 50°

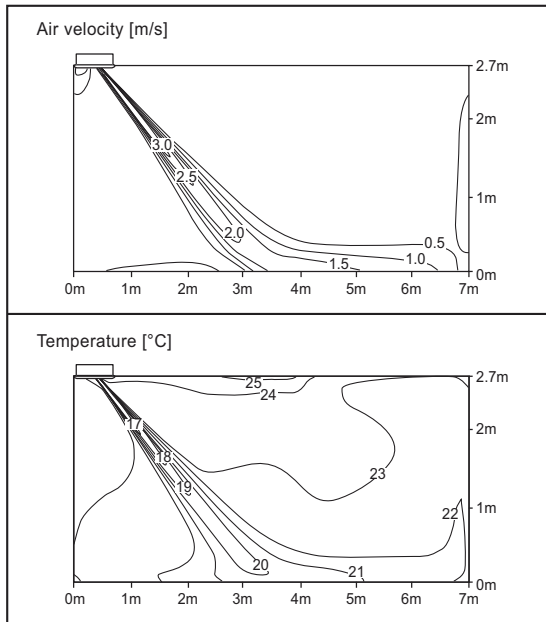

Heating

Discharge angle: 60°

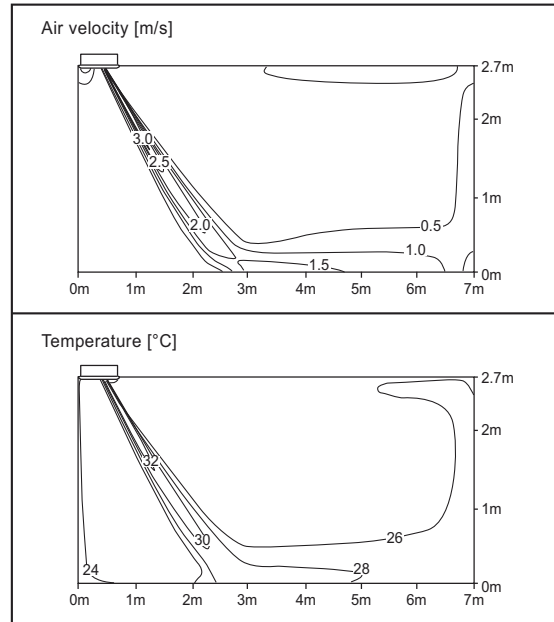

Note

- These figures are accordance with normal certain condition and environment. (Airflow step is 'High', Air discharge angle is fixed as indicated angle.)
- Indoor airflow distribution under actual installation or operating conditions depends on ambient temperature, ceiling height, product installation direction / location, indoor / Heating load, and other obstacles, etc.

8. Electric Characteristics

Units					Power Supply	IFM		PI	
Model	Type	Hz	Volts	Voltage Range	MCA	kW	FLA	Cooling	Heating
ARNU07GTU*4	TU	50	220-240	Max:264 Min:198	0.23	0.03	0.18	40	40
ARNU09GTU*4	TU				0.23	0.03	0.18	40	40
ARNU12GTU*4	TU				0.23	0.03	0.18	40	40
ARNU18GTT*4	TT				0.38	0.03	0.30	70	70
ARNU24GTT*4	TT				0.38	0.03	0.30	70	70
ARNU07GTU*4	TU	60	220	Max:242 Min:198	0.23	0.03	0.18	40	40
ARNU09GTU*4	TU				0.23	0.03	0.18	40	40
ARNU12GTU*4	TU				0.23	0.03	0.18	40	40
ARNU18GTT*4	TT				0.38	0.03	0.30	70	70
ARNU24GTT*4	TT				0.38	0.03	0.30	70	70

Symbols

MCA : Minimum Circuit Amperes (A)

kW : Fan Motor Rated Output (kW)

FLA : Full Load Amperes (A)

IFM : Indoor Fan Motor

PI : Maximum Power Input (W)

Note

- Voltage range
Units are suitable for use on electrical systems where voltage supplied to unit terminals is not below or above the listed range limits.
- Maximum allowable voltage unbalance between phases is 2%.
- MCA/MFA
 $MCA = 1.25 \times FLA$
 $MFA = 1.1 \times MCA, MFA \leq 4 \times FLA$
 (If MFA is smaller than minimum standard value, Use minimum standard value in region for selecting circuit breaker.)
- Select wire size based on the MCA
- Instead of fuse, use Circuit Breaker.

9. Sound Levels

9.1 Sound Pressure Levels

Overall

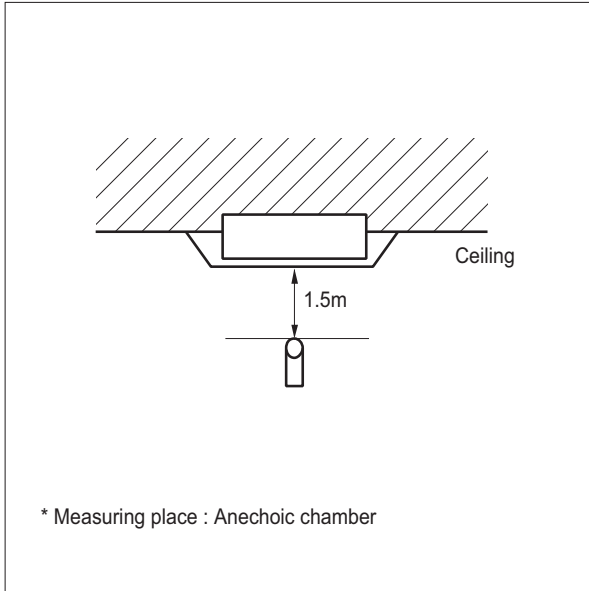

Note

1. Sound measured at some distance away from the center of the unit.
2. Data is valid at free field condition.
3. Reference acoustic pressure 0dB = 20μPa.
4. Data is valid at nominal operation condition.
Refer to the Model Specifications for nominal conditions (Power source and Ambient temperature, etc)
5. Sound levels can be increased in accordance with installation and operating conditions. (Static pressure mode, used air guide, Room target temperature setting, etc)
6. Sound level will vary depending on a range of factors such as the construction (acoustic absorption coefficient) of particular room in which the equipment is installed.
7. Sound pressure level is measured on the rated condition in the anechoic rooms by ISO 3745 standard.
Therefore, these values can be increased owing to ambient conditions during operation.

Model	Sound Pressure Levels [dB(A)]		
	H	M	L
ARNU07GTU*4	32	29	25
ARNU09GTU*4	35	34	32
ARNU12GTU*4	38	35	32
ARNU18GTT*4	40	37	35
ARNU24GTT*4	43	40	36

ARNU07GTU*4

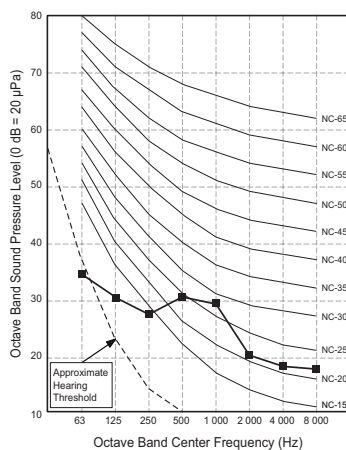

ARNU09GTU*4

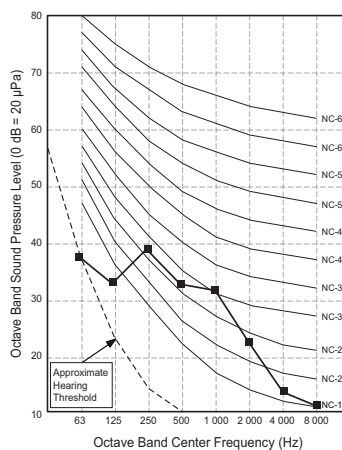

ARNU12GTU*4

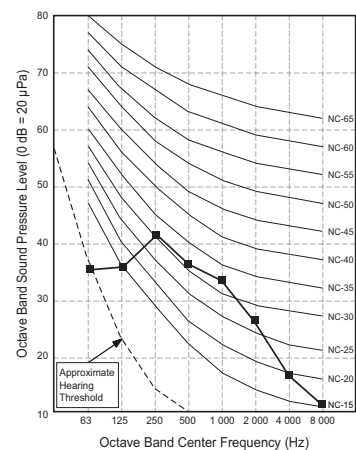

9. Sound Levels

ARNU18GTT*4

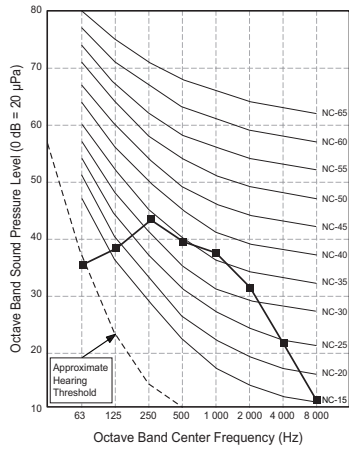

ARNU24GTT*4

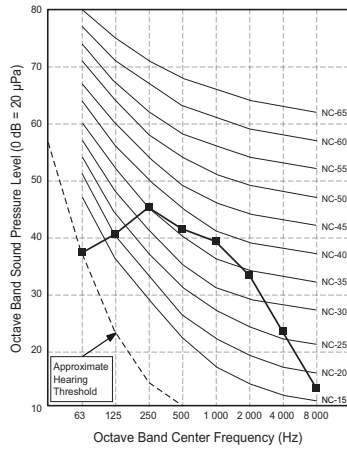

9. Sound Levels

9.2 Sound Power Levels

Note

- Data is valid at diffuse field condition
- Data is valid at nominal operating condition
- Sound level can be increased in static pressure mode or used air guide.
- Sound level will vary depending on a range of factors such as the construction (acoustic absorption coefficient) of particular room in which the equipment is installed.
- Reference acoustic intensity 0dB = $10E-6\mu W/m^2$
- Sound power level is measured on the rated condition in the semi-anechoic rooms by ISO 9614 standard. Therefore, these values can be increased owing to ambient conditions during operation.

Model	Sound Power Levels [dB(A)]		
	H	M	L
ARNU07GTU*4	47	44	41
ARNU09GTU*4	51	49	47
ARNU12GTU*4	52	51	47
ARNU18GTT*4	55	51	47
ARNU24GTT*4	58	53	49

ARNU07GTU*4

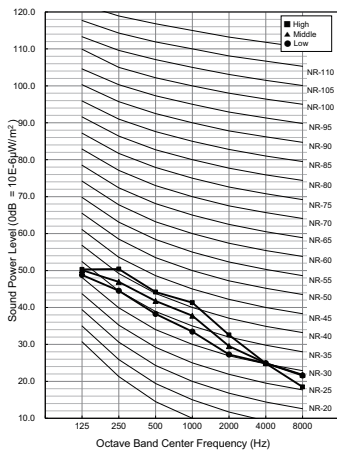

ARNU09GTU*4

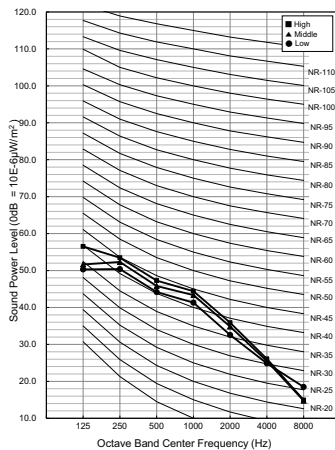

ARNU12GTU*4

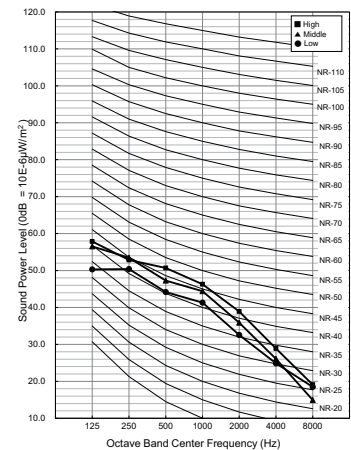

ARNU18GTT*4

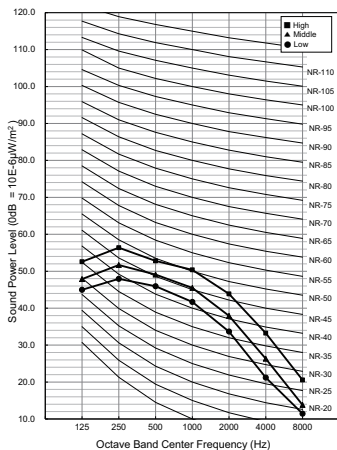

ARNU24GTT*4

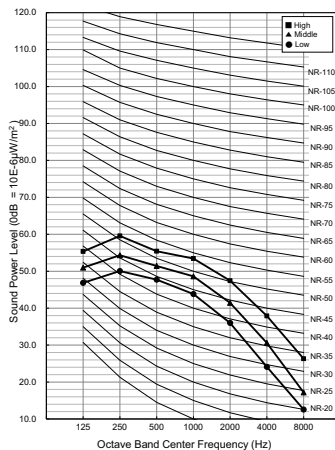

Ceiling Mounted Cassette (2-Way)

- 1. List of functions**
- 2. Specifications**
- 3. Dimensions**
- 4. Piping Diagrams**
- 5. Wiring Diagrams**
- 6. Capacity Tables**
- 7. Air Velocity and Temperature Distribution**
- 8. Electric Characteristics**
- 9. Sound Levels**

1. List of functions

List of functions

Category	Function	ARNU09GTS*4, ARNU12GTS*4 ARNU18GTS*4, ARNU24GTS*4
Air Flow	Air Supply Outlet	2
	Airflow Direction Control (left & right)	X
	Airflow Direction Control (up & down)	Auto
	Auto Swing (left & right)	X
	Auto Swing (up & down)	O
	Airflow Steps (fan/cool/heat)	4 / 5 / 4
	Fan Speed Auto*	Advanced
	Power Cool/Heat	O / X
	Swirl Wind*	X
	Refresh Mode**	X
	Smart Mode**	X
	Indirect Wind*	O
	Direct Wind*	O
Dry Operation	O	
Air Purification	Air Purify	X
	Ionizer	X
	UV-C	X
	Pre-Filter	O
Reliability	Hot Start	O
	Self Diagnosis	O
Convenience	Auto Mode	O
	Auto Dry Operation	O
	Auto Restart	O
	Child Lock*	O
	Forced Operation	O
	Group Control*	O
	Sleep Timer	O
	Turn On/Off Reservation	O
	Schedule*	O
	Two Thermistor Control*	O
External On/Off	O	
Installation	Drain Pump	O
	E.S.P. Control*	X
	High Ceiling Operation*	O
Special Functions	Wi-Fi	Accessory
	Auto Elevation Grille	X
	Human Detection Function**	X
	Floor Detection Function**	X

Note

- O : Applied, X : Not Applied, - : Unconfirmed or irrelevant
Embedded : A kit is provided by default for using this function when the product is manufactured.
Accessory : Ordered and purchased separately the accessory package referring to the model name provided and install at field. Accessory line-ups varies by region, so check your local catalogue or local sales material.
- Some functions can be limited by remote controller.
- In case of cassette type indoor units, Air Purification Kit and Auto Elevation Grille functions are not applicable at the same time.
- 'Auto Mode' varies depending on the outdoor unit type.
 - Auto Change Over(Heat Recovery Outdoor Unit)
 - Auto Mode Select(Heat Pump Outdoor Unit)
 - Auto Intensity Control(Cooling Only Outdoor Unit)
- * : These functions need to connect the wired remote controller.
- ** : This functions need to connect to the Standard III wired remote controller.

1. List of functions

■ Accessory Compatibility List

Category	Accessory Name	Model Name	Description	ARNU09GTS*4 ARNU12GTS*4 ARNU18GTS*4 ARNU24GTS*4
Remote Controller	Wired - Premium	PREMTA000	-	○
		PREMTA000A	-	○
		PREMTA000B	-	○
	Wired - RS3 (Standard III)	PREMTB100/PREMTB101	White	○
		PREMTBB10/PREMTBB11	Black	○
	Wired - RS2 (Standard II)	PREMTB001	White	○
		PREMTBB01	Black	○
	Wired - Simple	PQRCVCL0QW	White	○
		PQRCVCL0Q	Black	○
	Wired - Simple for Hotel	PQRCHCA0QW	White	○
		PQRCHCA0Q	Black	○
	Wireless	PQWRCQ0FDB	For Cooling only	○
PQWRHQ0FDB		For Heat pump	○	
PWLSSB21C		For Cooling only	○	
PWLSSB21H		For Heat pump	○	
Dry Contact	Simple	PDRYCB000	1 input port, AC 220 - 240V	○
		PDRYCB100	1 input port, AC 24V	○
	Communication	PDRYCB400	2 input port	○
		PDRYCB300	8 input port, For 3rd party Thermostat	○
		PDRYCB320	8 input port, For 3rd Party Thermostat (Analog Input)	○
PDRYCB500	For 3rd Party Controller (Modbus RTU)	○		
Integration Device	Remote Temperature sensor	PQRSTA0	-	○
	Group Control wire	PZCWRCG3	Cable Assembly for group control (Y-type cable : 0.25m, cable : 9.6m)	○
ETC	Extension wire	PZCWRC1	Extension wire for IDU-wired remote controller (9.6m)	○
	2-Remo Control Wire	PZCWRC2	-	○
	Wi-Fi Modem	PWFMDD200	-	○
	Wi-Fi Extension cable	PWYREW000	USB Extension cable : 10 m	○
	Independent Power Module	PRIP0	-	○
	Multi-tenant Power Module	PINPMB001	-	○
	Refrigerant Leakage Detector	PRLDNVS0	For R410A only	○
	Human Detection Sensor	PTVSMA0	For Cassette 4-way	X
		PTVSA0	For Cassette Dual Vane 4-way	X
	Floor Detection Sensor	PTFSMA0	-	X
	Auto Elevation Grille	PTEGM0	For TP/TN/TM	X
	Air Purification Kit	PTAHTP0	For Cassette 1-way	X
		PTAHMP0	For Cassette 4-way	X
		PTAHYP0	For Cassette Round	X
	EEV Kit	PRGK024A0	For Multi V Indoor Unit	○ (9/12/18k)
	Auxiliary Heater Relay Kit	PRARS1	For Wall Mounted and Art Cool Indoor Units	X
		PRARH1	For Cassette and Duct Indoor Units	○
	Ventilation Kit	PTVK430	For TR/TQ/TP/TN/TM	X
		PTVK410 + PTVK420	For TP/TN/TM	X
	Cassette Cover	PTDCQ	For TR/TQ	X
PTDCM		For TP/TN/TM	X	
PTDCA		For TM-A/TP-B	X	

Note

1. ○: Possible, X: Impossible, -: Not applicable, Embedded : Included with product.
2. If there is a difference in development time between the product and the remote controller, some functions cannot be operated.
3. If using Wi-Fi controller, Some advanced functions controlled by remote controller cannot be operated.
4. If you need more detail, please refer to the **BECON** PDB or the manual of product. (<http://partner.lge.com/global> : Home> Doc.Library> Product > Control(BECON))

2. Specifications

* Model Name (A:Basic, C:Ionizer(Acc.))

** The Line up may vary by region.

Model			Unit	ARNU09GTS*4	ARNU12GTS*4
Cooling Capacity			kW	2.8	3.6
			kcal/h	2,400	3,100
			Btu/h	9,600	12,300
Heating Capacity			kW	3.2	4.0
			kcal/h	2,800	3,400
			Btu/h	10,900	13,600
Power Input	H / M / L	W	16 / 14 / 11	18 / 14 / 11	
Casing				Galvanized Steel Plate	Galvanized Steel Plate
Dimensions (W×H×D)	Net	mm	830 × 225 × 600	830 × 225 × 600	
		inch	32-11/16 × 8-27/32 × 23-5/8	32-11/16 × 8-27/32 × 23-5/8	
	Shipping	mm	1,055 × 290 × 682	1,055 × 290 × 682	
		inch	41-17/32 × 11-13/32 × 26-27/32	41-17/32 × 11-13/32 × 26-27/32	
Weight	Net	kg (lbs)	18.1 (39.9)	18.1 (39.9)	
	Shipping	kg (lbs)	22.5 (49.6)	22.5 (49.6)	
Heat Exchanger	Rows x Columns x FPI		2 × 9 × 17	2 × 9 × 17	
	Face Area		m ²	0.32	0.32
Fan Type				Turbo Fan	Turbo Fan
Air Flow Rate	H / M / L	m ³ /min	10.8 / 9.8 / 9.1	11.1 / 10.3 / 9.1	
		ft ³ /min	381 / 346 / 321	392 / 364 / 321	
Fan Motor	Type			BLDC	BLDC
	Drive			Direct	Direct
	Output	W × No.	37 × 1	37 × 1	
	Full Load Ampere		A	0.67	0.67
Temperature Control				Microprocessor, Thermostat for cooling and heating	
Sound Absorbing Thermal Insulation Material				Foamed polystyrene	Foamed polystyrene
Safety Device				Fuse	Fuse
Pipe Connections	Liquid Side		mm (inch)	Ø6.35 (1/4)	Ø6.35 (1/4)
	Gas Side		mm (inch)	Ø12.7 (1/2)	Ø12.7 (1/2)
	Drain Pipe	Internal Dia.	mm (inch)	25 (1)	25 (1)
Sound Pressure Levels	H / M / L	dB(A)	33 / 31 / 29	34 / 32 / 29	
Sound Power Levels	H / M / L	dB(A)	44 / 41 / 40	44 / 42 / 40	
Power Supply			Ø, V, Hz	1, 220 - 230 - 240, 50/60	1, 220 - 230 - 240, 50/60
Running Current by voltage	Rated	A	0.13 - 0.13 - 0.12	0.15 - 0.14 - 0.14	
Maximum Running Current			A	0.19	0.20
Refrigerant	Type		-	R410A / R32	R410A / R32
	Additional Charging Amount (CF Value of IDU)		kg(each)	0.34 / 0.28	0.34 / 0.28
	Control		-	EEV	EEV
Communication cable			mm ²	1.0~1.5 × 2C	1.0~1.5 × 2C
Decoration Panel (Accessory)	Model Name			PT-USC	PT-USC
	Exterior Color			Morning fog	Morning fog
	Dimensions (W×H×D)	Net	mm	1,100 × 28 × 690	1,100 × 28 × 690
		Shipping	mm	1,140 × 100 × 754	1,140 × 100 × 754
	Net Weight		kg(lbs)	4.65 (10.3)	4.65 (10.3)
	Shipping Weight		kg(lbs)	6.50 (14.3)	6.50 (14.3)

Note

1. Due to our policy of innovation some specifications may be changed without notification.
2. Wiring cable size must comply with the applicable local and national code. And "Electric characteristics" chapter should be considered for electrical work and design. Especially the power cable and circuit breaker should be selected in accordance with that.
3. Sound pressure level is measured on the rated condition in the anechoic rooms by ISO 3745 standard.
Sound power level is measured on the rated condition in the semi-anechoic rooms by ISO 9614 standard.
Therefore, these values can be increased owing to ambient conditions during operation.
4. Capacities are net capacities and based on the following conditions. Refer to the Outdoor Unit Specifications for calculating the real capacity.
 - Cooling : Indoor Ambient Temp. 27°CDB / 19°CWB, Outdoor Ambient Temp. 35°CDB / 24°CWB
 - Heating : Indoor Ambient Temp. 20°CDB / 15°CWB, Outdoor Ambient Temp. 7°CDB / 6°CWB
 - Interconnected Pipe is standard length and difference of Elevation (Outdoor ~ Indoor Unit) is 0m.
5. Refrigerant information (type, additional charging amount, etc.) must be applied by refrigerant type of the combined outdoor unit.
Adapt after checking the specifications of outdoor unit.

2. Specifications

* Model Name (A:Basic, C:Ionizer(Acc.))

** The Line up may vary by region.

Model			Unit	ARNU18GTS*4	ARNU24GTS*4
Cooling Capacity			kW	5.6	7.1
			kcal/h	4,800	6,100
			Btu/h	19,100	24,200
Heating Capacity			kW	6.3	8.0
			kcal/h	5,400	6,900
			Btu/h	21,500	27,300
Power Input	H / M / L	W	19 / 16 / 14	31 / 22 / 14	
Casing				Galvanized Steel Plate	Galvanized Steel Plate
Dimensions (W×H×D)	Net	mm	830 × 225 × 600	830 × 225 × 600	
		inch	32-11/16 × 8-27/32 × 23-5/8	32-11/16 × 8-27/32 × 23-5/8	
	Shipping	mm	1,055 × 290 × 682	1,055 × 290 × 682	
		inch	41-17/32 × 11-13/32 × 26-27/32	41-17/32 × 11-13/32 × 26-27/32	
Weight	Net	kg (lbs)	18.1 (39.9)	18.1 (39.9)	
	Shipping	kg (lbs)	22.5 (49.6)	22.5 (49.6)	
Heat Exchanger	Rows x Columns x FPI		2 × 9 × 17	2 × 9 × 17	
	Face Area		m ²	0.32	0.32
Fan Type				Turbo Fan	Turbo Fan
Air Flow Rate	H / M / L	m ³ /min	11.8 / 10.8 / 9.8	14.5 / 12.4 / 10.3	
		ft ³ /min	417 / 381 / 346	512 / 438 / 364	
Fan Motor	Type			BLDC	BLDC
	Drive			Direct	Direct
	Output	W × No.	37 × 1	37 × 1	
	Full Load Ampere		A	0.67	0.67
Temperature Control				Microprocessor, Thermostat for cooling and heating	
Sound Absorbing Thermal Insulation Material				Foamed polystyrene	Foamed polystyrene
Safety Device				Fuse	Fuse
Pipe Connections	Liquid Side		mm (inch)	Ø6.35 (1/4)	Ø9.52 (3/8)
	Gas Side		mm (inch)	Ø12.7 (1/2)	Ø15.88 (5/8)
	Drain Pipe	Internal Dia.	mm (inch)	25 (1)	25 (1)
Sound Pressure Levels	H / M / L	dB(A)	35 / 33 / 31	40 / 37 / 33	
Sound Power Levels	H / M / L	dB(A)	45 / 44 / 41	51 / 48 / 42	
Power Supply			Ø, V, Hz	1, 220 - 230 - 240, 50/60	1, 220 - 230 - 240, 50/60
Running Current by voltage	Rated	A	0.16 - 0.15 - 0.14	0.26 - 0.25 - 0.23	
Maximum Running Current			A	0.24	0.30
Refrigerant	Type		-	R410A / R32	R410A / R32
	Additional Charging Amount (CF Value of IDU)		kg(each)	0.34 / 0.28	0.34 / 0.28
	Control		-	EEV	EEV
Communication cable			mm ²	1.0~1.5 × 2C	1.0~1.5 × 2C
Decoration Panel (Accessory)	Model Name			PT-USC	PT-USC
	Exterior Color			Morning fog	Morning fog
	Dimensions (W×H×D)	Net	mm	1,100 × 28 × 690	1,100 × 28 × 690
		Shipping	mm	1,140 × 100 × 754	1,140 × 100 × 754
	Net Weight		kg(lbs)	4.65 (10.3)	4.65 (10.3)
	Shipping Weight		kg(lbs)	6.50 (14.3)	6.50 (14.3)

Note

1. Due to our policy of innovation some specifications may be changed without notification.
2. Wiring cable size must comply with the applicable local and national code. And "Electric characteristics" chapter should be considered for electrical work and design. Especially the power cable and circuit breaker should be selected in accordance with that.
3. Sound pressure level is measured on the rated condition in the anechoic rooms by ISO 3745 standard.
Sound power level is measured on the rated condition in the semi-anechoic rooms by ISO 9614 standard.
Therefore, these values can be increased owing to ambient conditions during operation.
4. Capacities are net capacities and based on the following conditions. Refer to the Outdoor Unit Specifications for calculating the real capacity.
 - Cooling : Indoor Ambient Temp. 27°CDB / 19°CWB, Outdoor Ambient Temp. 35°CDB / 24°CWB
 - Heating : Indoor Ambient Temp. 20°CDB / 15°CWB, Outdoor Ambient Temp. 7°CDB / 6°CWB
 - Interconnected Pipe is standard length and difference of Elevation (Outdoor ~ Indoor Unit) is 0m.
5. Refrigerant information (type, additional charging amount, etc.) must be applied by refrigerant type of the combined outdoor unit.
Adapt after checking the specifications of outdoor unit.

3. Dimensions

3.2 Installation Space

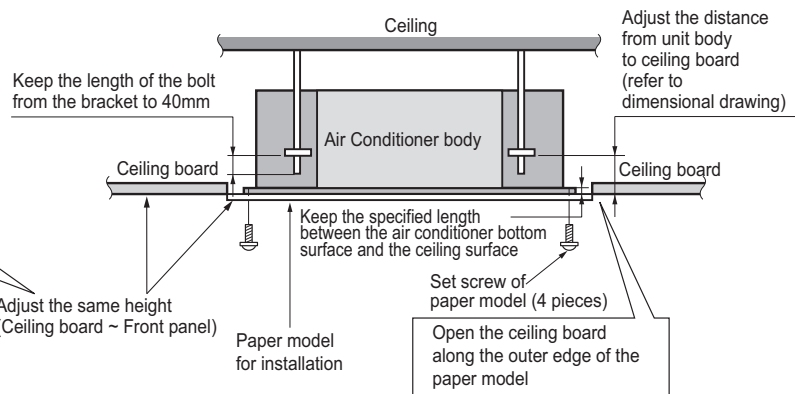
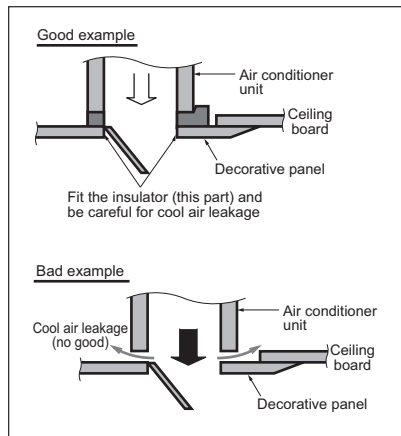
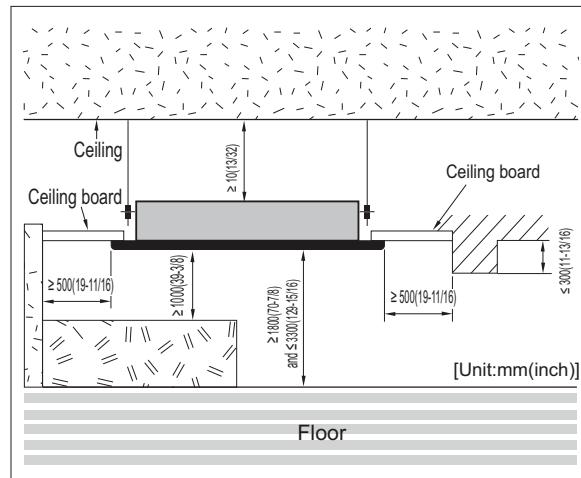

Note

- Places where products are installed should not be any obstacles to the air circulation or installation. Ensure the spaces from the wall, ceiling, or other obstacles.
- According to type of indoor unit, external appearance or installed structure could be different.
- According to product type, model line up, sales region..etc, applicability of each chassis could be different.
- Install certainly the decoration panel. Cool air leakage causes sweating or falling of water-drops.

4. Piping Diagrams

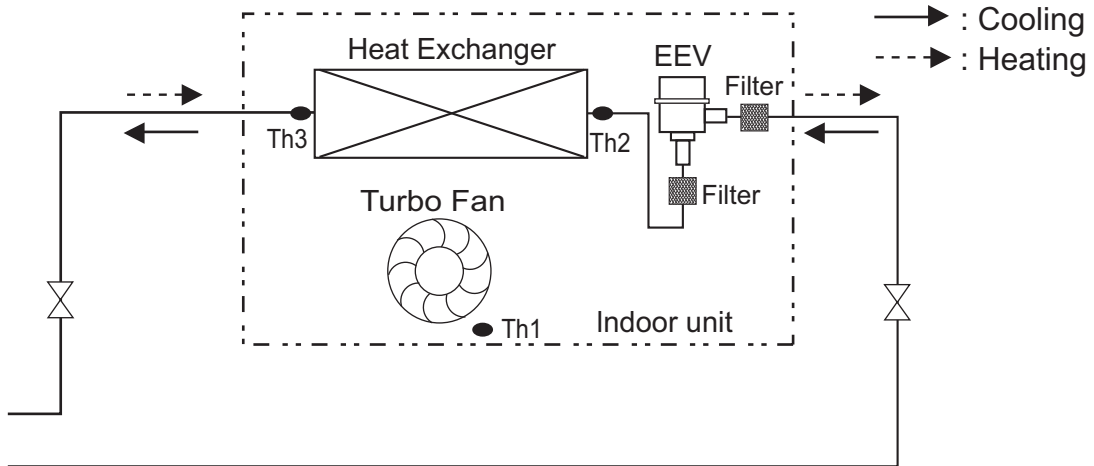

◆ Refrigerant pipe connection port diameter

Model	Gas [mm(inch)]	Liquid [mm(inch)]
ARNU09GTS*4	Ø12.7(1/2)	Ø6.35(1/4)
ARNU12GTS*4	Ø12.7(1/2)	Ø6.35(1/4)
ARNU18GTS*4	Ø12.7(1/2)	Ø6.35(1/4)
ARNU24GTS*4	Ø15.88(5/8)	Ø9.52(3/8)

LOC.	Description
Th1	Room thermistor
Th2	Pipe in thermistor
Th3	Pipe out thermistor

5. Wiring Diagrams

TS Chassis

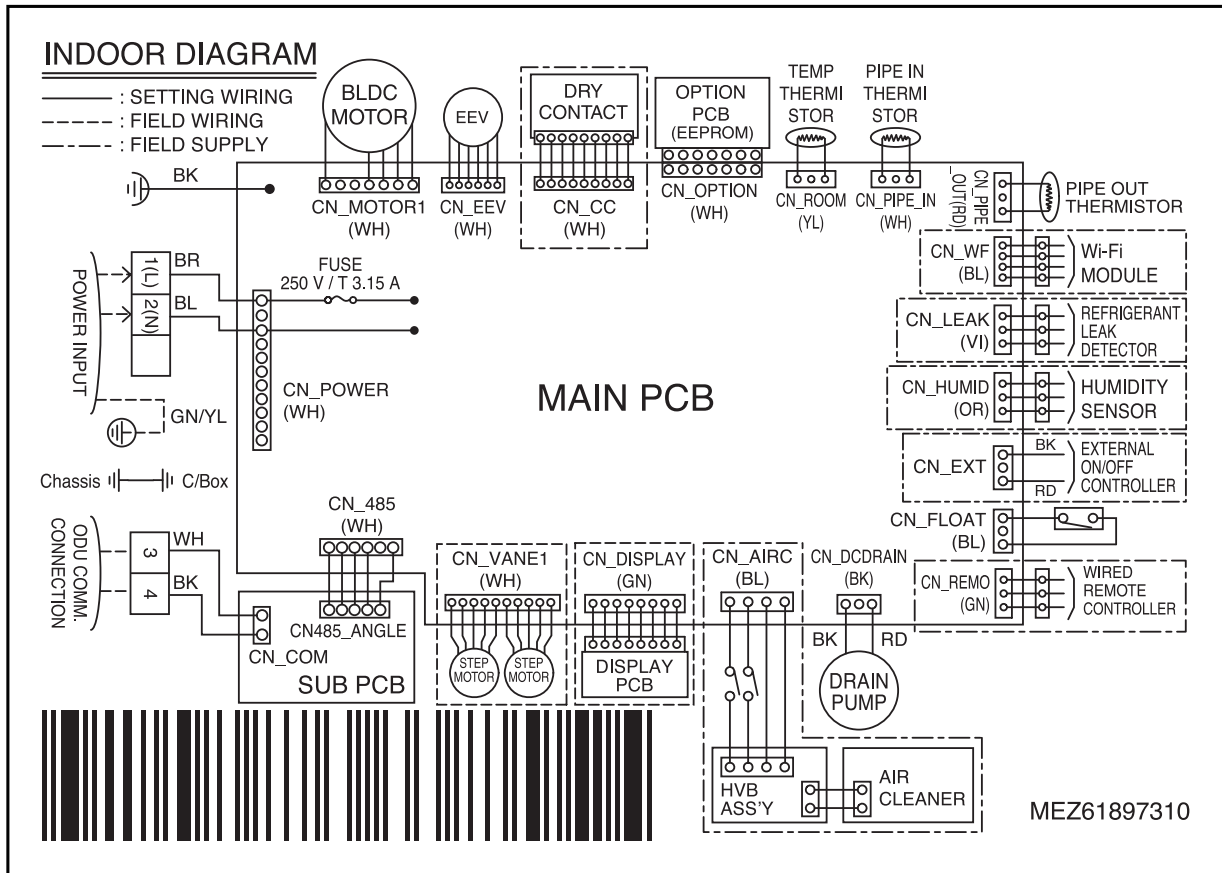

CONNECTOR NUMBER	SPEC	DESCRIPTION
CN-POWER	AC Power supply	AC Power line input for indoor controller
CN-MOTOR1	Fan motor output	Motor output of BLDC
CN-DCDRAIN	Drain pump output	AC output for drain pump
CN-485	Communication	Connection between indoor and outdoor
CN-DISPLAY	Display	Display of indoor status
CN-EEV	EEV Output	EEV Control output : connect to EEV directly or through IPM(Independent Power Module)
CN-VANE1	Step motor	Step motor output
CN-FLOAT	Float switch input	Float switch sensing
CN-PIPE/IN	Suction pipe sensor	Pipe in thermistor
CN-PIPE/OUT	Discharge pipe sensor	Pipe out thermistor
CN-ROOM	Room sensor	Room air thermistor
CN-REMO	Remote controller	Remote control line
CN-EXT	External On/Off	External On/Off signal input
CN-CC	Dry contact	Dry contact line
CN-OPTION	Option pwb.	Communication between main and option
CN-AIRC	Air cleaner (Ionizer)	Air cleaner (Ionizer) line
CN-LEAK	Refrigerant leak detector	Refrigerant leak detector line
CN-WF	Wi-Fi controller	Wi-Fi module line
CN-HUMID	Humidity Sensor	Humidity sensor line

5. Wiring Diagrams

Dip Switch Setting		Off	On	Remarks
SW3	GROUP Control	Master	Slave	Group Control setting using Wired Remote Controller
SW4	DRY CONTACT	Variable	Auto	Old Dry Contact Mode Setting 1. Variable : Auto/Manual Mode can be chosen by Wide wired remote controller or Wireless remote controller (When shipped from Factory → Manual Mode) 2. Auto : For Dry Contact, it is always Auto mode.
SW5	EXTRA 1	Off	On	1. Duct model -. OFF : Default(not operate continuously) -. ON : Fan operate continuously 2. Cassette Model : No Function 3. Ceiling Suspended Model -. OFF : Ceiling(default) -. ON : Floor

CAUTION

For Multi V Model, Dip Switch 1,2,6,7,8 must be set OFF

That dip switch is used for the other model.

6. Capacity Tables

■ Cooling Capacity

Nominal Capacity (kBtu/h) [Capacity Index (kW)]	Indoor air temp. (DB/WB, °C)													
	20		23		26		27		28		30		32	
	14		16		18		19		20		22		24	
	TC	SHC	TC	SHC	TC	SHC	TC	SHC	TC	SHC	TC	SHC	TC	SHC
9 [2.8]	1.9	1.6	2.3	1.7	2.6	1.9	2.8	1.9	3.0	2.0	3.4	2.1	3.1	1.7
12 [3.6]	2.4	2.1	2.9	2.2	3.3	2.5	3.6	2.5	3.9	2.6	4.4	2.7	4.0	2.2
18 [5.6]	3.8	3.0	4.6	3.6	5.2	3.9	5.6	4.0	6.0	4.1	6.8	4.2	6.2	3.6
24 [7.1]	4.8	3.8	5.8	4.5	6.6	4.9	7.1	5.0	7.6	5.1	8.6	5.2	7.9	4.5

Note

1. TC: Total Capacity(kW), SHC: Sensible Heat Capacity(kW)
2. Capacity tables show the average value of conditions which may occur.
3. Refer to Capacity tables and correction factor in the outdoor unit PDB for the actual performance data of each indoor unit and outdoor unit combination.

■ Heating Capacity

Nominal Capacity (kBtu/h) [Capacity Index (kW)]	Indoor air temp. (DB, °C)					
	16	18	20	21	22	24
	TC	TC	TC	TC	TC	TC
9 [2.8]	3.6	3.4	3.2	3.1	3.0	2.8
12 [3.6]	4.5	4.3	4.0	3.9	3.7	3.5
18 [5.6]	7.1	6.7	6.3	6.1	5.9	5.5
24 [7.1]	9.0	8.5	8.0	7.7	7.5	7.0

Note

1. TC: Total Capacity(kW)
2. Capacity tables show the average value of conditions which may occur.
3. Refer to Capacity tables and correction factor in the outdoor unit PDB for the actual performance data of each indoor unit and outdoor unit combination.

7. Air Velocity and Temperature Distribution

◆ ARNU09GTS*4

Cooling

Discharge angle: 50°

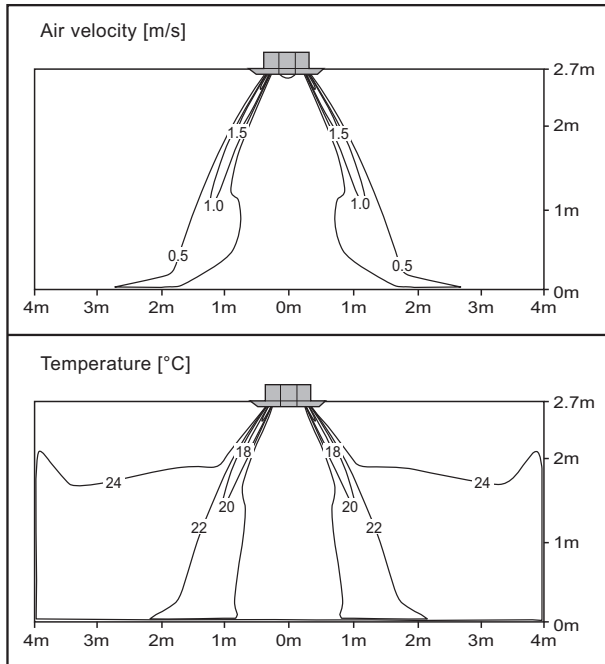

Heating

Discharge angle: 60°

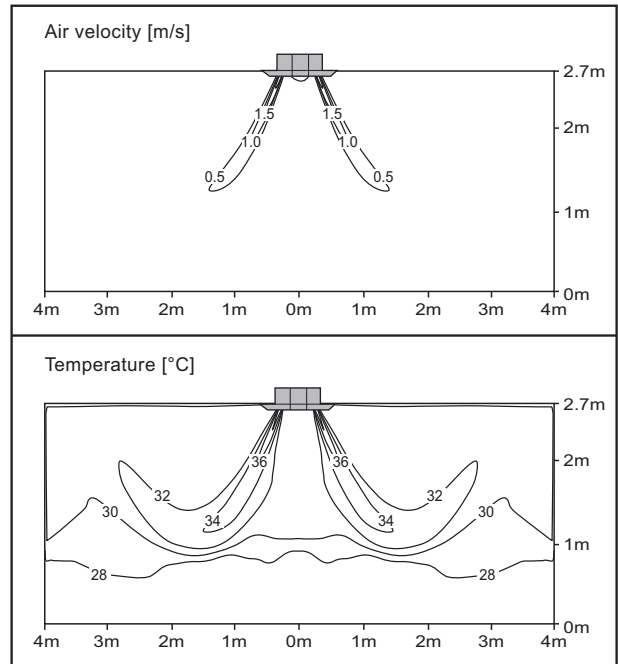

◆ ARNU12GTS*4

Cooling

Discharge angle: 50°

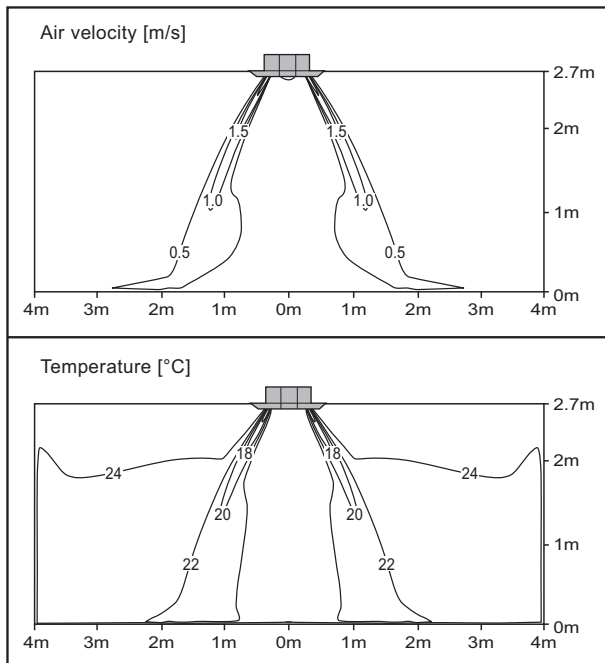

Heating

Discharge angle: 60°

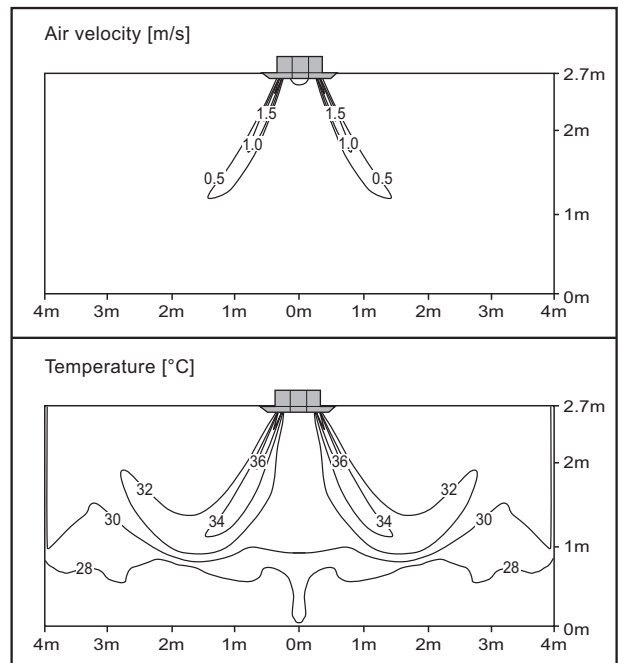

Note

- These figures are accordance with normal certain condition and environment. (Airflow step is 'High', Air discharge angle is fixed as indicated angle.)
- Indoor airflow distribution under actual installation or operating conditions depends on ambient temperature, ceiling height, product installation direction / location, indoor / Heating load, and other obstacles, etc.

7. Air Velocity and Temperature Distribution

◆ ARNU18GTS*4

Cooling

Discharge angle: 50°

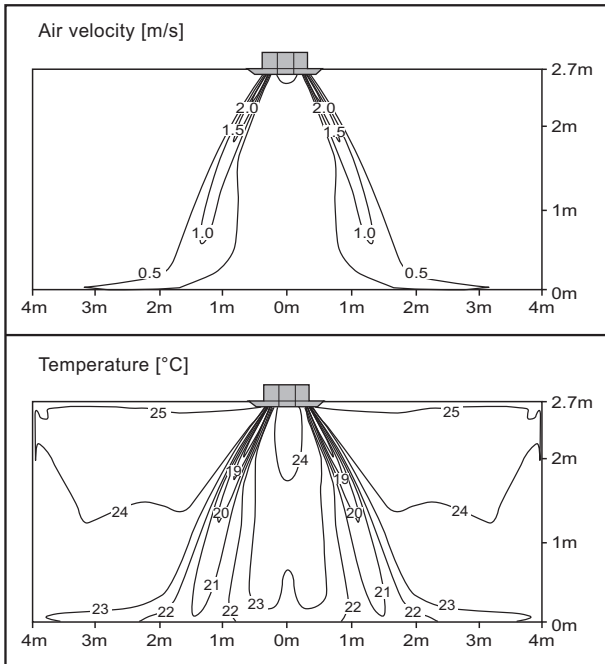

Heating

Discharge angle: 60°

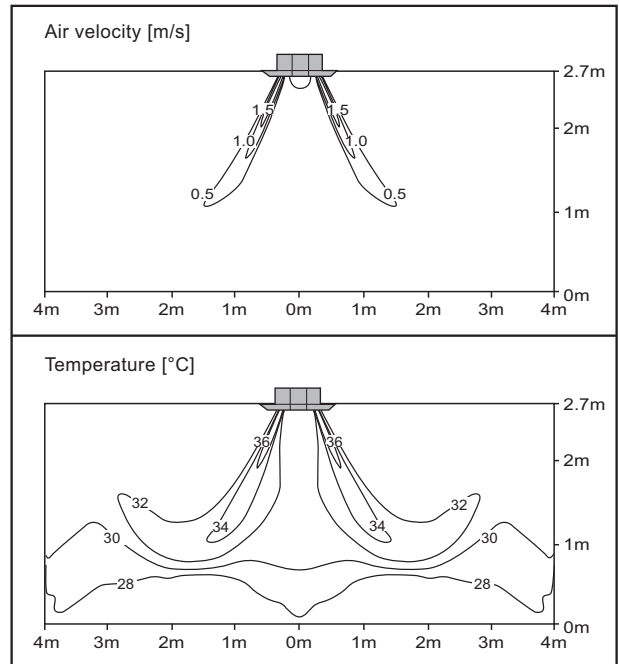

◆ ARNU24GTS*4

Cooling

Discharge angle: 50°

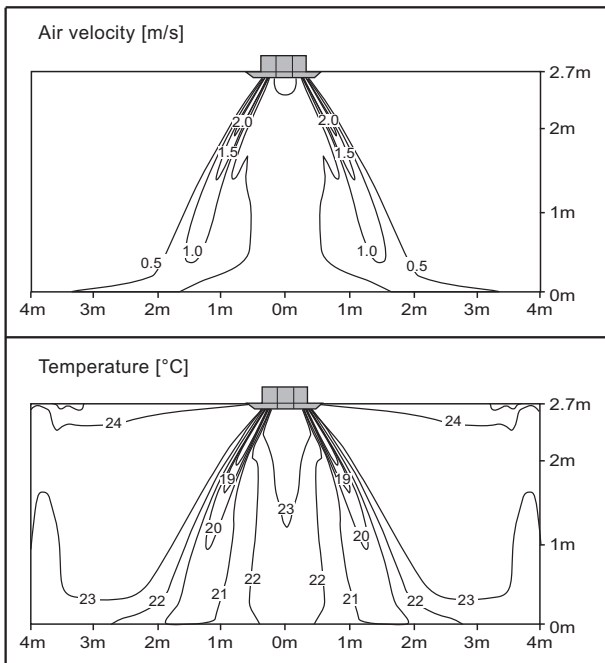

Heating

Discharge angle: 60°

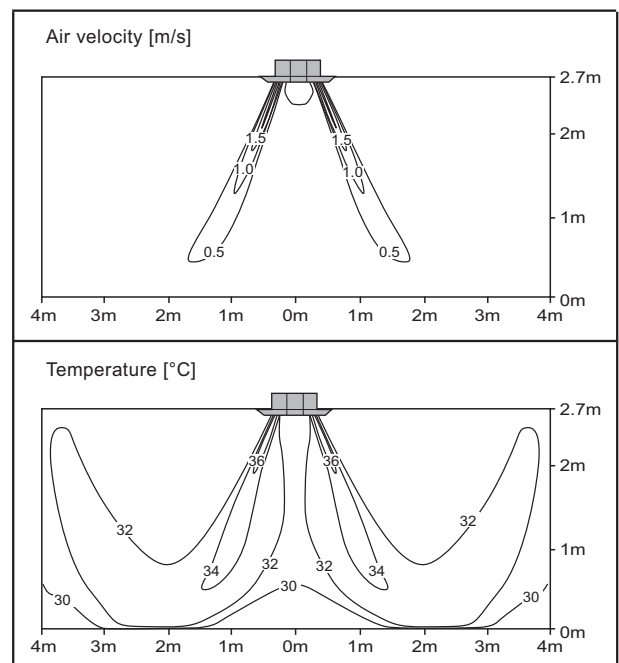

Note

- These figures are accordance with normal certain condition and environment. (Airflow step is 'High', Air discharge angle is fixed as indicated angle.)
- Indoor airflow distribution under actual installation or operating conditions depends on ambient temperature, ceiling height, product installation direction / location, indoor / Heating load, and other obstacles, etc.

8. Electric Characteristics

Units					Power Supply	IFM		PI	
Model	Type	Hz	Volts	Voltage Range	MCA	kW	FLA	Cooling	Heating
ARNU09GTS*4	TS	50	220-240	Max:264 Min:198	0.24	0.037	0.19	57	57
ARNU12GTS*4	TS				0.25	0.037	0.20	57	57
ARNU18GTS*4	TS				0.30	0.037	0.24	57	57
ARNU24GTS*4	TS				0.38	0.037	0.30	57	57
ARNU09GTS*4	TS	60	220	Max:242 Min:198	0.24	0.037	0.19	57	57
ARNU12GTS*4	TS				0.25	0.037	0.20	57	57
ARNU18GTS*4	TS				0.30	0.037	0.24	57	57
ARNU24GTS*4	TS				0.38	0.037	0.30	57	57

Symbols

MCA : Minimum Circuit Amperes (A)

MFA : Maximum Fuse Amperes (A)

kW : Fan Motor Rated Output (kW)

FLA : Full Load Amperes (A)

IFM : Indoor Fan Motor

PI : Maximum Power Input (W)

Note

1. Voltage range

Units are suitable for use on electrical systems where voltage supplied to unit terminals is not below or above the listed range limits.

2. Maximum allowable voltage unbalance between phases is 2%.

3. MCA/MFA

$MCA = 1.25 \times FLA$

$MFA = 1.1 \times MCA, MFA \leq 4 \times FLA$

(If MFA is smaller than minimum standard value, Use minimum standard value in region for selecting circuit breaker.)

4. Select wire size based on the MCA

5. Instead of fuse, use Circuit Breaker.

9. Sound Levels

9.1 Sound Pressure Levels

Overall

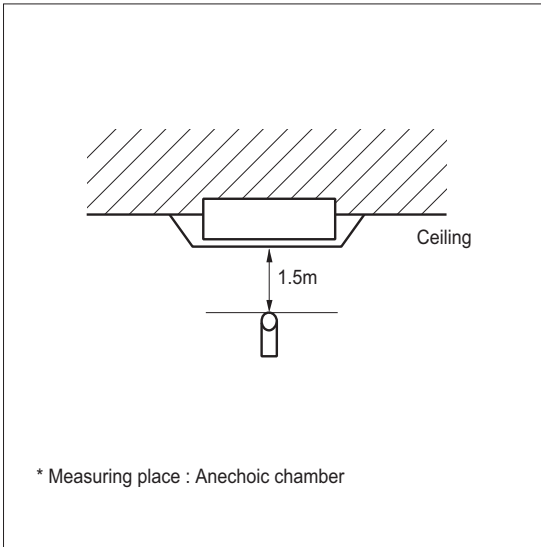

Note

- 1.Sound measured at some distance away from the center of the unit.
- 2.Data is valid at free field condition.
- 3.Reference acoustic pressure 0dB = 20μPa.
- 4.Data is valid at nominal operation condition.
Refer to the Model Specifications for nominal conditions(Power source and Ambient temperature, etc)
- 5.Sound levels can be increased in accordance with installation and operating conditions. (Static pressure mode, used air guide, Room target temperature setting, etc)
- 6.Sound level will vary depending on a range of factors such as the construction(acoustic absorption coefficient) of the particular room in which the equipment is installed.
- 7.Sound pressure level is measured on the rated condition in the anechoic rooms by ISO 3745 standard.
Therefore, these values can be increased owing to ambient conditions during operation.

Model	Sound Pressure Levels [dB(A)]		
	H	M	L
ARNU09GTS*4	33	31	29
ARNU12GTS*4	34	32	29
ARNU18GTS*4	35	33	31
ARNU24GTS*4	40	37	33

ARNU09GTS*4

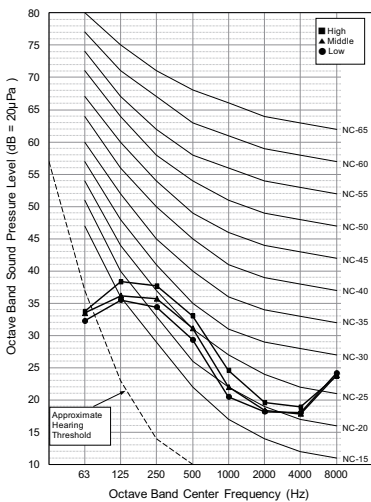

ARNU12GTS*4

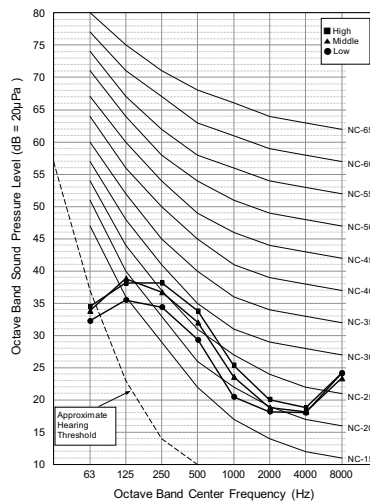

ARNU18GTS*4

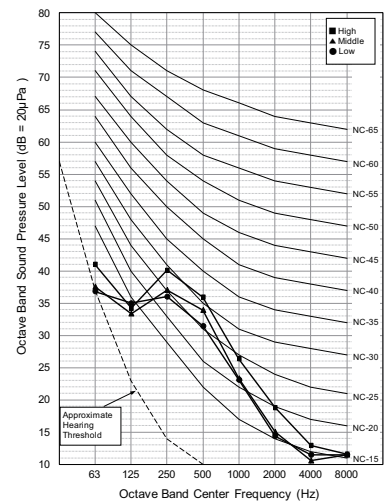

9. Sound Levels

ARNU24GTS*4

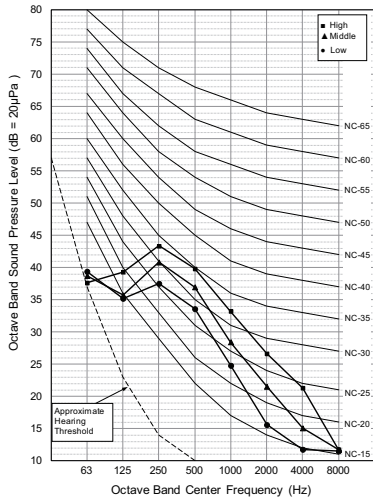

9. Sound Levels

9.2 Sound Power Levels

Note

- Data is valid at diffuse field condition
- Data is valid at nominal operating condition
- Sound level can be increased in static pressure mode or used air guide.
- Sound level will vary depending on a range of factors such as the construction (acoustic absorption coefficient) of particular room in which the equipment is installed.
- Reference acoustic intensity 0dB = $10E-6\mu W/m^2$
- Sound power level is measured on the rated condition in the semi-anechoic rooms by ISO 9614 standard. Therefore, these values can be increased owing to ambient conditions during operation.

Model	Sound Power Levels [dB(A)]		
	H	M	L
ARNU09GTS*4	44	41	40
ARNU12GTS*4	44	42	40
ARNU18GTS*4	45	44	41
ARNU24GTS*4	51	48	42

ARNU09GTS*4

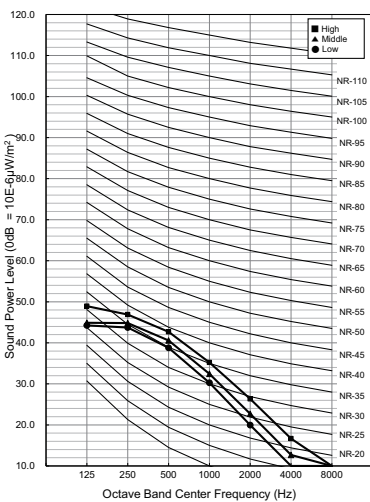

ARNU12GTS*4

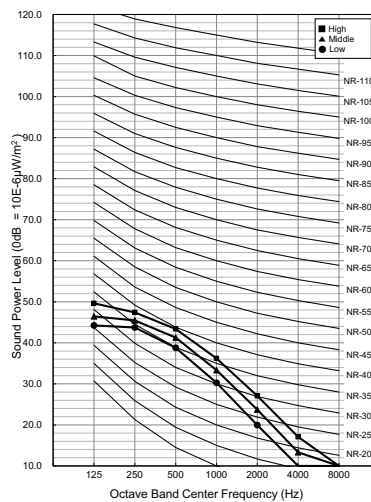

ARNU18GTS*4

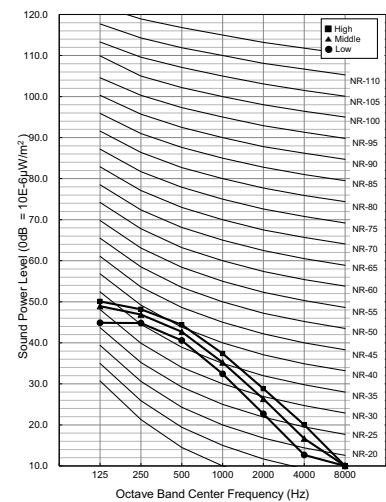

ARNU24GTS*4

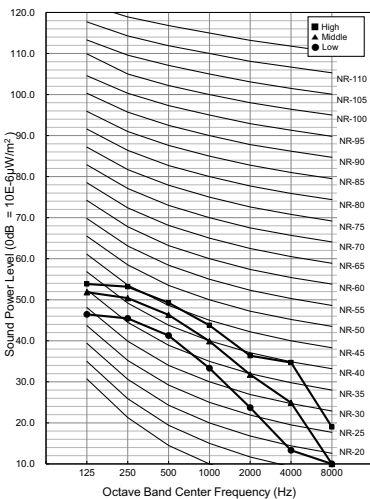

Ceiling Mounted Cassette (4-Way Mini)

- 1. List of functions**
- 2. Specifications**
- 3. Dimensions**
- 4. Piping Diagrams**
- 5. Wiring Diagrams**
- 6. Capacity Tables**
- 7. Air Velocity and Temperature Distribution**
- 8. Electric Characteristics**
- 9. Sound Levels**

1. List of functions

Category	Function	ARNU05GTR*4, ARNU07GTR*4, ARNU09GTR*4, ARNU12GTR*4, ARNU15GTQB4, ARNU18GTQB4, ARNU21GTQB4
Air Flow	Air Supply Outlet	4
	Airflow Direction Control (left & right)	X
	Airflow Direction Control (up & down)	Auto
	Auto Swing (left & right)	X
	Auto Swing (up & down)	O
	Airflow Steps (fan/cool/heat)	4 / 5 / 4
	Fan Speed Auto*	Advanced
	Power Cool/Heat	O / X
	Swirl Wind*	O
	Refresh Mode**	X
	Smart Mode**	X
	Indirect Wind*	O
	Direct Wind*	O
Dry Operation	O	
Air Purification	Air Purify	X
	Ionizer	X
	UV-C	X
	Pre-Filter	O
Reliability	Hot Start	O
	Self Diagnosis	O
Convenience	Auto Mode	O
	Auto Dry Operation	O
	Auto Restart	O
	Child Lock*	O
	Forced Operation	O
	Group Control*	O
	Sleep Timer	O
	Turn On/Off Reservation	O
	Schedule*	O
	Two Thermistor Control*	O
External On/Off	O	
Installation	Drain Pump	O
	E.S.P. Control*	X
	High Ceiling Operation*	O
Special Functions	Wi-Fi	Accessory(B4) , X(A4)
	Auto Elevation Grille	X
	Human Detection Function**	X
	Floor Detection Function**	X

Note

- O : Applied, X : Not Applied, - : Unconfirmed or irrelevant
Embedded : A kit is provided by default for using this function when the product is manufactured.
Accessory : Ordered and purchased separately the accessory package referring to the model name provided and install at field. Accessory line-ups varies by region, so check your local catalogue or local sales material.
- Some functions can be limited by remote controller.
- In case of cassette type indoor units, Air Purification Kit and Auto Elevation Grille functions are not applicable at the same time.
- 'Auto Mode' varies depending on the outdoor unit type.
 - Auto Change Over(Heat Recovery Outdoor Unit)
 - Auto Mode Select(Heat Pump Outdoor Unit)
 - Auto Intensity Control(Cooling Only Outdoor Unit)
- * : These functions need to connect the wired remote controller.
- ** : This functions need to connect to the Standard III wired remote controller.

1. List of functions

■ Accessory Compatibility List

Category	Accessory Name	Model Name	Description	ARNU05GTR*4 ARNU07GTR*4 ARNU09GTR*4 ARNU12GTR*4
Remote Controller	Wired - Premium	PREMTA000	-	○
		PREMTA000A	-	○
		PREMTA000B	-	○
	Wired - RS3 (Standard III)	PREMTB100/PREMTB101	White	○
		PREMTBB10/PREMTBB11	Black	○
	Wired - RS2 (Standard II)	PREMTB001	White	○
		PREMTBB01	Black	○
	Wired - Simple	PQRCVCL0QW	White	○
		PQRCVCL0Q	Black	○
	Wired - Simple for Hotel	PQRCHCA0QW	White	○
		PQRCHCA0Q	Black	○
	Wireless	PQWRCQ0FDB	For Cooling only	○
		PQWRHQ0FDB	For Heat pump	○
PWLSSB21C		For Cooling only	○	
PWLSSB21H		For Heat pump	○	
Dry Contact	Simple	PDRYCB000	1 input port, AC 220 - 240V	○
		PDRYCB100	1 input port, AC 24V	○
	Communication	PDRYCB400	2 input port	○
		PDRYCB300	8 input port, For 3rd party Thermostat	○
		PDRYCB320	8 input port, For 3rd Party Thermostat (Analog Input)	○
		PDRYCB500	For 3rd Party Controller (Modbus RTU)	○
Integration Device	Remote Temperature sensor	PQRSTA0	-	○
	Group Control wire	PZCWRCG3	Cable Assembly for group control (Y-type cable : 0.25m, cable : 9.6m)	○
ETC	Extension wire	PZCWRC1	Extension wire for IDU-wired remote controller (9.6m)	○
	2-Remo Control Wire	PZCWRC2	-	○
	Wi-Fi Modem	PWFMDD200	-	○(B4), X(A4)
	Wi-Fi Extension cable	PWYREW000	USB Extension cable : 10 m	○(B4), X(A4)
	Independent Power Module	PRIP0	-	○
	Multi-tenant Power Module	PINPMB001	-	○
	Refrigerant Leakage Detector	PRLDNVS0	For R410A only	○
	Human Detection Sensor	PTVSMA0	For Cassette 4-way	X
		PTVSA0	For Cassette Dual Vane 4-way	X
	Floor Detection Sensor	PTFSMA0	-	X
	Auto Elevation Grille	PTEGM0	For TP/TN/TM	X
	Ionizer	PAS-NATDR2	-	X
	Air Purification Kit	PTAHTP0	For Cassette 1-way	X
		PTAHMP0	For Cassette 4-way	X
		PTAHYP0	For Cassette Round	X
	EEV Kit	PRGK024A0	For Multi V Indoor Unit	○
	Auxiliary Heater Relay Kit	PRARS1	For Wall Mounted and Art Cool Indoor Units	X
		PRARH1	For Cassette and Duct Indoor Units	○
	Ventilation Kit	PTVK430	For TR/TQ/TP/TN/TM	○
		PTVK410 + PTVK420	For TP/TN/TM	X
Cassette Cover	PTDCQ	For TR/TQ	○	
	PTDCM	For TP/TN/TM	X	
	PTDCA	For TM-A/TP-B	X	

Note

1. ○: Possible, X: Impossible, -: Not applicable, Embedded : Included with product.
2. If there is a difference in development time between the product and the remote controller, some functions cannot be operated.
3. If using Wi-Fi controller, Some advanced functions controlled by remote controller cannot be operated.
4. If you need more detail, please refer to the **BECON** PDB or the manual of product. (<http://partner.lge.com/global> : Home> Doc.Library> Product > Control(BECON))

1. List of functions

Category	Accessory Name	Model Name	Description	ARNU15GTQB4 ARNU18GTQB4 ARNU21GTQB4
Remote Controller	Wired - Premium	PREMTA000	-	○
		PREMTA000A	-	○
		PREMTA000B	-	○
	Wired - RS3 (Standard III)	PREMTB100/PREMTB101	White	○
		PREMTBB10/PREMTBB11	Black	○
	Wired - RS2 (Standard II)	PREMTB001	White	○
		PREMTBB01	Black	○
	Wired - Simple	PQRCVCL0QW	White	○
		PQRCVCL0Q	Black	○
	Wired - Simple for Hotel	PQRCHCA0QW	White	○
		PQRCHCA0Q	Black	○
	Wireless	PQWRCQ0FDB	For Cooling only	○
		PQWRHQ0FDB	For Heat pump	○
PWLSSB21C		For Cooling only	○	
PWLSSB21H		For Heat pump	○	
Dry Contact	Simple	PDRYCB000	1 input port, AC 220 - 240V	○
		PDRYCB100	1 input port, AC 24V	○
	Communication	PDRYCB400	2 input port	○
		PDRYCB300	8 input port, For 3rd party Thermostat	○
		PDRYCB320	8 input port, For 3rd Party Thermostat (Analog Input)	○
		PDRYCB500	For 3rd Party Controller (Modbus RTU)	○
Integration Device	Remote Temperature sensor	PQRSTA0	-	○
	Group Control wire	PZCWRCG3	Cable Assembly for group control (Y-type cable : 0.25m, cable : 9.6m)	○
ETC	Extension wire	PZCWRC1	Extension wire for IDU-wired remote controller (9.6m)	○
	2-Remo Control Wire	PZCWRC2	-	○
	Wi-Fi Modem	PWFMDD200	-	○
	Wi-Fi Extension cable	PWYREW000	USB Extension cable : 10 m	○
	Independent Power Module	PRIP0	-	○
	Multi-tenant Power Module	PINPMB001	-	○
	Refrigerant Leakage Detector	PRLDNVS0	For R410A only	○
	Human Detection Sensor	PTVSMA0	For Cassette 4-way	X
		PTVSAA0	For Cassette Dual Vane 4-way	X
	Floor Detection Sensor	PTFSMA0	-	X
	Auto Elevation Grille	PTEGM0	For TP/TN/TM	X
	Ionizer	PAS-NATDR2	-	X
	Air Purification Kit	PTAHTP0	For Cassette 1-way	X
		PTAHMP0	For Cassette 4-way	X
		PTAHYP0	For Cassette Round	X
	EEV Kit	PRGK024A0	For Multi V Indoor Unit	○(15k)
	Auxiliary Heater Relay Kit	PRARS1	For Wall Mounted and Art Cool Indoor Units	X
		PRARH1	For Cassette and Duct Indoor Units	○
	Ventilation Kit	PTVK430	For TR/TQ/TP/TN/TM	○
		PTVK410 + PTVK420	For TP/TN/TM	X
Cassette Cover	PTDCQ	For TR/TQ	○	
	PTDCM	For TP/TN/TM	X	
	PTDCA	For TM-A/TP-B	X	

Note

1. ○: Possible, X: Impossible, -: Not applicable, Embedded : Included with product.
2. If there is a difference in development time between the product and the remote controller, some functions cannot be operated.
3. If using Wi-Fi controller, Some advanced functions controlled by remote controller cannot be operated.
4. If you need more detail, please refer to the **BECON** PDB or the manual of product. (<http://partner.lge.com/global> : Home> Doc.Library> Product > Control(BECON))

2. Specifications

* : A (China Only) / B (Basic)

Model		Unit	ARNU05GTR*4	ARNU07GTR*4
Cooling Capacity		kW	1.6	2.2
		kcal/h	1,400	1,900
		Btu/h	5,500	7,500
Heating Capacity		kW	1.8	2.5
		kcal/h	1,500	2,200
		Btu/h	6,100	8,500
Power Input (H / M / L)		W	13 / 12 / 11	13 / 12 / 11
Casing			Galvanized Steel Plate	Galvanized Steel Plate
Dimensions (W x H x D)	Body	mm	570 x 214 x 570	570 x 214 x 570
		inch	22-7/16 x 8-7/16 x 22-7/16	22-7/16 x 8-7/16 x 22-7/16
	Decoration Panel #1	-	PT-UQC	PT-UQC
		mm	700 x 22 x 700	700 x 22 x 700
		inch	27-9/16 x 7/8 x 27-9/16	27-9/16 x 7/8 x 27-9/16
		Decoration Panel #2	-	PT-QCHW0
	mm		620 x 34 x 620	620 x 34 x 620
		inch	24-13/32 x 1-11/32 x 24-13/32	24-13/32 x 1-11/32 x 24-13/32
		Decoration Panel #3	-	PT-QAGW0
	mm		620 x 35 x 620	620 x 35 x 620
	inch	24-13/32 x 1-3/8 x 24-13/32	24-13/32 x 1-3/8 x 24-13/32	
Panel Color		-	#1, #2 : Morning fog #3 : White	#1, #2 : Morning fog #3 : White
Coil	Rows x Columns x FPI		1 x 8 x 18	1 x 8 x 18
	Face Area	m ²	0.21	0.21
Fan	Type		Turbo Fan	Turbo Fan
	Motor Output x Number	W	43 x 1	43 x 1
	Air Flow Rate (H / M / L)	m ³ /min	7.5 / 7.0 / 6.6	7.5 / 7.0 / 6.6
		ft ³ /min	265 / 247 / 212	265 / 247 / 212
	Drive		Direct	Direct
Motor type		BLDC	BLDC	
Temperature Control			Microprocessor, Thermostat for cooling and heating	
Sound Absorbing Thermal Insulation Material			Foamed polystyrene	Foamed polystyrene
Safety Device			Fuse	Fuse
Pipe Connections	Liquid Side	mm(inch)	Ø6.35(1/4)	Ø6.35(1/4)
	Gas Side	mm(inch)	Ø12.7(1/2)	Ø12.7(1/2)
	Drain Pipe(Internal Dia.)	mm(inch)	25(1)	25(1)
Net Weight	Body	kg(lbs)	12.6(27.8)	12.6(27.8)
	Packaged	kg(lbs)	14.6(32.2)	14.6(32.2)
Sound Pressure Levels (H / M / L)		dB(A)	29 / 27 / 26	29 / 27 / 26
Sound Power Levels (H / M / L)		dB(A)	47 / 46 / 45	47 / 46 / 45
Power Supply		Ø, V, Hz	1, 220 - 230 - 240, 50/60	1, 220 - 230 - 240, 50/60
Running Current by voltage	Rated	A	0.09 - 0.09 - 0.08	0.09 - 0.09 - 0.08
Maximum Running Current		A	0.20	0.20
Refrigerant	Type	-	R410A / R32	R410A / R32
	Additional Charging Amount (CF Value of IDU)	kg(each)	0.18 / 0.15	0.18 / 0.15
	Control	-	EEV	EEV
Transmission cable		mm ²	1.0~1.5 x 2C	1.0~1.5 x 2C

Note

- Due to our policy of innovation some specifications may be changed without notification.
- Wiring cable size must comply with the applicable local and national code. And "Electric characteristics" chapter should be considered for electrical work and design. Especially the power cable and circuit breaker should be selected in accordance with that.
- Sound pressure level is measured on the rated condition in the anechoic rooms by ISO 3745 standard.
Sound power level is measured on the rated condition in the semi-anechoic rooms by ISO 9614 standard.
Therefore, these values can be increased owing to ambient conditions during operation.
- Capacities are net capacities and based on the following conditions. Refer to the Outdoor Unit Specifications for calculating the real capacity.
 - Cooling : Indoor Ambient Temp. 27°CDB / 19°CWB, Outdoor Ambient Temp. 35°CDB / 24°CWB
 - Heating : Indoor Ambient Temp. 20°CDB / 15°CWB, Outdoor Ambient Temp. 7°CDB / 6°CWB
 - Interconnected Pipe is standard length and difference of Elevation (Outdoor ~ Indoor Unit) is 0m.
- Refrigerant information (type, additional charging amount, etc.) must be applied by refrigerant type of the combined outdoor unit.
Adapt after checking the specifications of outdoor unit.

2. Specifications

* : A (China Only) / B (Basic)

Model		Unit	ARNU09GTR*4	ARNU12GTR*4
Cooling Capacity		kW	2.8	3.6
		kcal/h	2,400	3,100
		Btu/h	9,600	12,300
Heating Capacity		kW	3.2	4.0
		kcal/h	2,800	3,400
		Btu/h	10,900	13,600
Power Input (H / M / L)		W	14 / 13 / 12	17 / 15 / 13
Casing			Galvanized Steel Plate	Galvanized Steel Plate
Dimensions (W x H x D)	Body	mm	570 x 214 x 570	570 x 214 x 570
		inch	22-7/16 x 8-7/16 x 22-7/16	22-7/16 x 8-7/16 x 22-7/16
	Decoration Panel #1	-	PT-UQC	PT-UQC
		mm	700 x 22 x 700	700 x 22 x 700
		inch	27-9/16 x 7/8 x 27-9/16	27-9/16 x 7/8 x 27-9/16
		Decoration Panel #2	-	PT-QCHW0
	mm		620 x 34 x 620	620 x 34 x 620
		inch	24-13/32 x 1-11/32 x 24-13/32	24-13/32 x 1-11/32 x 24-13/32
		Decoration Panel #3	-	PT-QAGW0
	mm		620 x 35 x 620	620 x 35 x 620
	inch	24-13/32 x 1-3/8 x 24-13/32	24-13/32 x 1-3/8 x 24-13/32	
Panel Color		-	#1, #2 : Morning fog #3 : White	#1, #2 : Morning fog #3 : White
Coil	Rows x Columns x FPI		2 x 8 x 18	2 x 8 x 18
	Face Area	m ²	0.21	0.21
Fan	Type		Turbo Fan	Turbo Fan
	Motor Output x Number		W	43 x 1
	Air Flow Rate (H / M / L)	m ³ /min	8.0 / 7.5 / 7.1	8.7 / 8.0 / 7.0
		ft ³ /min	283 / 265 / 251	307 / 283 / 247
	Drive		Direct	Direct
Motor type		BLDC	BLDC	
Temperature Control			Microprocessor, Thermostat for cooling and heating	
Sound Absorbing Thermal Insulation Material			Foamed polystyrene	Foamed polystyrene
Safety Device			Fuse	Fuse
Pipe Connections	Liquid Side	mm(inch)	Ø6.35(1/4)	Ø6.35(1/4)
	Gas Side	mm(inch)	Ø12.7(1/2)	Ø12.7(1/2)
	Drain Pipe(Internal Dia.)	mm(inch)	25(1)	25(1)
Net Weight	Body	kg(lbs)	13.7(30.2)	13.7(30.2)
	Packaged	kg(lbs)	16.0(35.3)	16.0(35.3)
Sound Pressure Levels (H / M / L)		dB(A)	30 / 29 / 27	32 / 30 / 27
Sound Power Levels (H / M / L)		dB(A)	48 / 46 / 45	51 / 48 / 45
Power Supply		Ø, V, Hz	1, 220 - 230 - 240, 50/60	1, 220 - 230 - 240, 50/60
Running Current by voltage	Rated	A	0.10 - 0.09 - 0.09	0.12 - 0.11 - 0.11
Maximum Running Current		A	0.20	0.20
Refrigerant	Type	-	R410A / R32	R410A / R32
	Additional Charging Amount (CF Value of IDU)	kg(each)	0.25 / 0.21	0.25 / 0.21
	Control	-	EEV	EEV
Transmission cable		mm ²	1.0~1.5 x 2C	1.0~1.5 x 2C

Note

- Due to our policy of innovation some specifications may be changed without notification.
- Wiring cable size must comply with the applicable local and national code. And "Electric characteristics" chapter should be considered for electrical work and design. Especially the power cable and circuit breaker should be selected in accordance with that.
- Sound pressure level is measured on the rated condition in the anechoic rooms by ISO 3745 standard.
Sound power level is measured on the rated condition in the semi-anechoic rooms by ISO 9614 standard.
Therefore, these values can be increased owing to ambient conditions during operation.
- Capacities are net capacities and based on the following conditions. Refer to the Outdoor Unit Specifications for calculating the real capacity.
 - Cooling : Indoor Ambient Temp. 27°CDB / 19°CWB, Outdoor Ambient Temp. 35°CDB / 24°CWB
 - Heating : Indoor Ambient Temp. 20°CDB / 15°CWB, Outdoor Ambient Temp. 7°CDB / 6°CWB
 - Interconnected Pipe is standard length and difference of Elevation (Outdoor ~ Indoor Unit) is 0m.
- Refrigerant information (type, additional charging amount, etc.) must be applied by refrigerant type of the combined outdoor unit.
Adapt after checking the specifications of outdoor unit.

2. Specifications

Model		Unit	ARNU15GTQB4	ARNU18GTQB4
Cooling Capacity		kW	4.5	5.6
		kcal/h	3,900	4,800
		Btu/h	15,400	19,100
Heating Capacity		kW	5.0	6.3
		kcal/h	4,300	5,400
		Btu/h	17,100	21,500
Power Input (H / M / L)		W	24 / 21 / 18	25 / 22 / 19
Casing			Galvanized Steel Plate	Galvanized Steel Plate
Dimensions (W x H x D)	Body	mm	570 x 256 x 570	570 x 256 x 570
		inch	22-7/16 x 10-3/32 x 22-7/16	22-7/16 x 10-3/32 x 22-7/16
	Decoration Panel #1	-	PT-UQC	PT-UQC
		mm	700 x 22 x 700	700 x 22 x 700
	Decoration Panel #2	inch	27-9/16 x 7/8 x 27-9/16	27-9/16 x 7/8 x 27-9/16
		-	PT-QCHW0	PT-QCHW0
	Decoration Panel #3	mm	620 x 34 x 620	620 x 34 x 620
		inch	24-13/32 x 1-11/32 x 24-13/32	24-13/32 x 1-11/32 x 24-13/32
	Panel Color	-	PT-QAGW0	PT-QAGW0
		mm	620 x 35 x 620	620 x 35 x 620
Coil	Rows x Columns x FPI		2 x 10 x 18	2 x 10 x 18
	Face Area	m ²	0.27	0.27
Fan	Type		Turbo Fan	Turbo Fan
	Motor Output x Number	W	43 x 1	43 x 1
	Air Flow Rate (H / M / L)	m ³ /min	11.0 / 10.0 / 9.3	11.2 / 11.0 / 10.0
		ft ³ /min	388 / 353 / 328	396 / 388 / 353
	Drive		Direct	Direct
Motor type		BLDC	BLDC	
Temperature Control			Microprocessor, Thermostat for cooling and heating	
Sound Absorbing Thermal Insulation Material			Foamed polystyrene	Foamed polystyrene
Safety Device			Fuse	Fuse
Pipe Connections	Liquid Side	mm(inch)	Ø6.35(1/4)	Ø6.35(1/4)
	Gas Side	mm(inch)	Ø12.7(1/2)	Ø12.7(1/2)
	Drain Pipe(Internal Dia.)	mm(inch)	25(1)	25(1)
Net Weight	Body	kg(lbs)	15.0(33.1)	15.0(33.1)
	Packaged	kg(lbs)	17.0(37.5)	17.0(37.5)
Sound Pressure Levels (H / M / L)		dB(A)	36 / 34 / 32	37 / 35 / 34
Sound Power Levels (H / M / L)		dB(A)	52 / 50 / 46	52 / 50 / 46
Power Supply		Ø, V, Hz	1, 220 - 230 - 240, 50/60	1, 220 - 230 - 240, 50/60
Running Current by voltage	Rated	A	0.17 - 0.16 - 0.15	0.17 - 0.17 - 0.16
Maximum Running Current		A	0.20	0.20
Refrigerant	Type	-	R410A / R32	R410A / R32
	Additional Charging Amount (CF Value of IDU)	kg(each)	0.32 / 0.26	0.32 / 0.26
	Control	-	EEV	EEV
Transmission cable		mm ²	1.0~1.5 x 2C	1.0~1.5 x 2C

Note

1. Due to our policy of innovation some specifications may be changed without notification.
2. Wiring cable size must comply with the applicable local and national code. And "Electric characteristics" chapter should be considered for electrical work and design. Especially the power cable and circuit breaker should be selected in accordance with that.
3. Sound pressure level is measured on the rated condition in the anechoic rooms by ISO 3745 standard.
Sound power level is measured on the rated condition in the semi-anechoic rooms by ISO 9614 standard.
Therefore, these values can be increased owing to ambient conditions during operation.
4. Capacities are net capacities and based on the following conditions. Refer to the Outdoor Unit Specifications for calculating the real capacity.
 - Cooling : Indoor Ambient Temp. 27°CDB / 19°CWB, Outdoor Ambient Temp. 35°CDB / 24°CWB
 - Heating : Indoor Ambient Temp. 20°CDB / 15°CWB, Outdoor Ambient Temp. 7°CDB / 6°CWB
 - Interconnected Pipe is standard length and difference of Elevation (Outdoor ~ Indoor Unit) is 0m.
5. Refrigerant information (type, additional charging amount, etc.) must be applied by refrigerant type of the combined outdoor unit.
Adapt after checking the specifications of outdoor unit.

2. Specifications

Model		Unit	ARNU21GTQB4
Cooling Capacity		kW	6.0
		kcal/h	5,100
		Btu/h	20,500
Heating Capacity		kW	6.8
		kcal/h	5,800
		Btu/h	23,200
Power Input (H / M / L)		W	28 / 23 / 20
Casing			Galvanized Steel Plate
Dimensions (W x H x D)	Body	mm	570 x 256 x 570
		inch	22-7/16 x 10-3/32 x 22-7/16
	Decoration Panel #1	-	PT-UQC
		mm	700 x 22 x 700
	Decoration Panel #2	inch	27-9/16 x 7/8 x 27-9/16
		-	PT-QCHW0
	Decoration Panel #3	mm	620 x 34 x 620
		inch	24-13/32 x 1-11/32 x 24-13/32
		-	PT-QAGW0
	mm	620 x 35 x 620	
	inch	24-13/32 x 1-3/8 x 24-13/32	
Panel Color		-	#1, #2 : Morning fog #3 : White
Coil	Rows x Columns x FPI		2 x 10 x 18
	Face Area	m ²	0.27
Fan	Type		Turbo Fan
	Motor Output x Number	W	43 x 1
	Air Flow Rate (H / M / L)	m ³ /min	12.0 / 11.1 / 9.4
		ft ³ /min	424 / 392 / 332
	Drive		Direct
Motor type		BLDC	
Temperature Control			Microprocessor, Thermostat for cooling and heating
Sound Absorbing Thermal Insulation Material			Foamed polystyrene
Safety Device			Fuse
Pipe Connections	Liquid Side	mm(inch)	Ø9.52(3/8)
	Gas Side	mm(inch)	Ø15.88(5/8)
	Drain Pipe(Internal Dia.)	mm(inch)	25(1)
Net Weight	Body	kg(lbs)	15.0(33.0)
	Packaged	kg(lbs)	17.0(37.5)
Sound Pressure Levels (H / M / L)		dB(A)	40 / 38 / 34
Sound Power Levels (H / M / L)		dB(A)	54 / 52 / 46
Power Supply		Ø, V, Hz	1, 220 - 230 - 240, 50/60
Running Current by voltage	Rated	A	0.20 - 0.19 - 0.18
Maximum Running Current		A	0.20
Refrigerant	Type	-	R410A / R32
	Additional Charging Amount (CF Value of IDU)	kg(each)	0.32 / 0.26
	Control	-	EEV
Transmission cable		mm ²	1.0~1.5 x 2C

Note

- Due to our policy of innovation some specifications may be changed without notification.
- Wiring cable size must comply with the applicable local and national code. And "Electric characteristics" chapter should be considered for electrical work and design. Especially the power cable and circuit breaker should be selected in accordance with that.
- Sound pressure level is measured on the rated condition in the anechoic rooms by ISO 3745 standard.
Sound power level is measured on the rated condition in the semi-anechoic rooms by ISO 9614 standard.
Therefore, these values can be increased owing to ambient conditions during operation.
- Capacities are net capacities and based on the following conditions. Refer to the Outdoor Unit Specifications for calculating the real capacity.
 - Cooling : Indoor Ambient Temp. 27°CDB / 19°CWB, Outdoor Ambient Temp. 35°CDB / 24°CWB
 - Heating : Indoor Ambient Temp. 20°CDB / 15°CWB, Outdoor Ambient Temp. 7°CDB / 6°CWB
 - Interconnected Pipe is standard length and difference of Elevation (Outdoor ~ Indoor Unit) is 0m.
- Refrigerant information (type, additional charging amount, etc.) must be applied by refrigerant type of the combined outdoor unit.
Adapt after checking the specifications of outdoor unit.

3. Dimensions

◆ Panel Name : PT-QCHW0

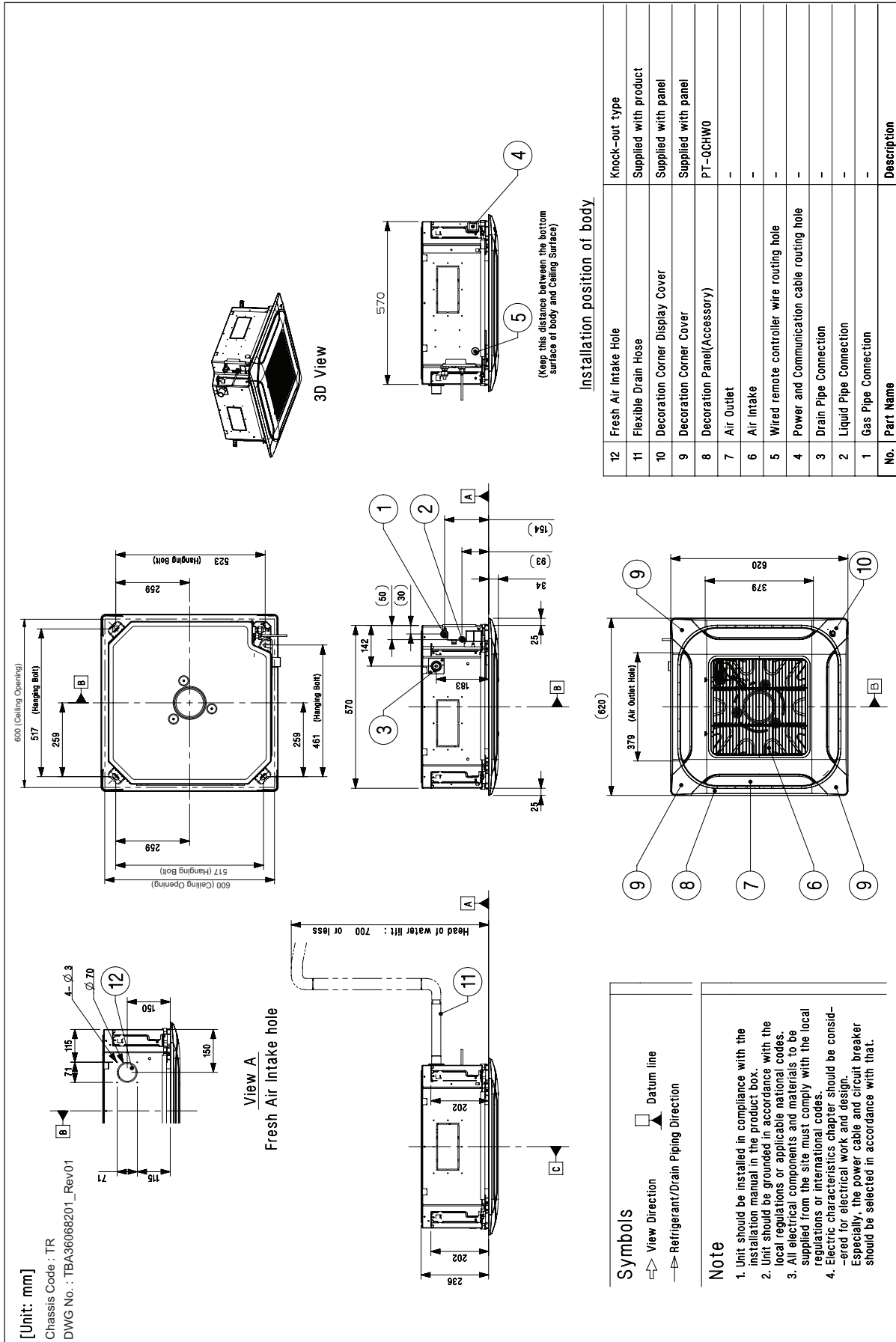

3. Dimensions

■ ARNU15GTQB4 / ARNU18GTQB4 / ARNU21GTQB4

◆ Panel Name : PT-UQC

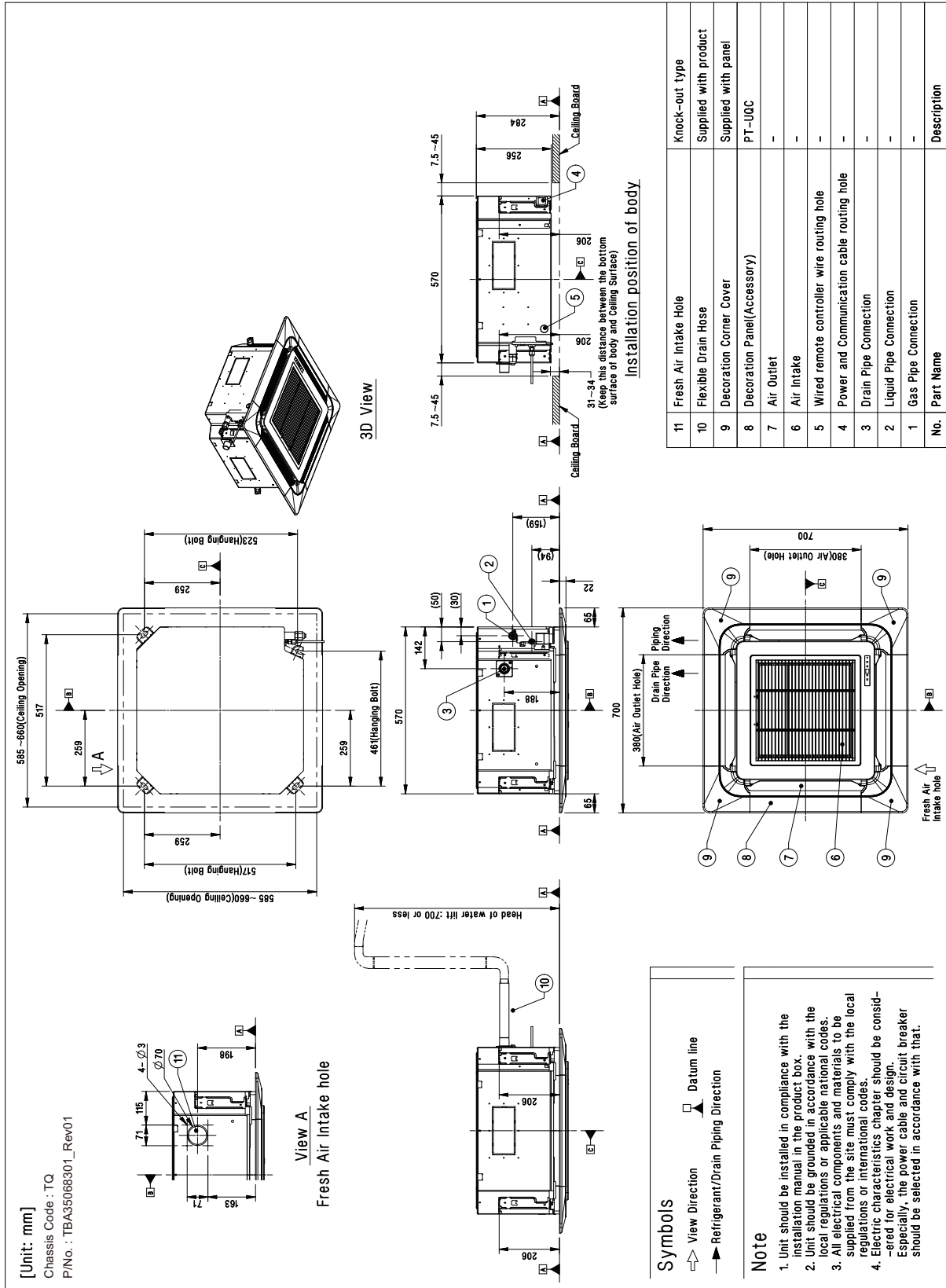

3. Dimensions

◆ Panel Name : PT-QCHW0

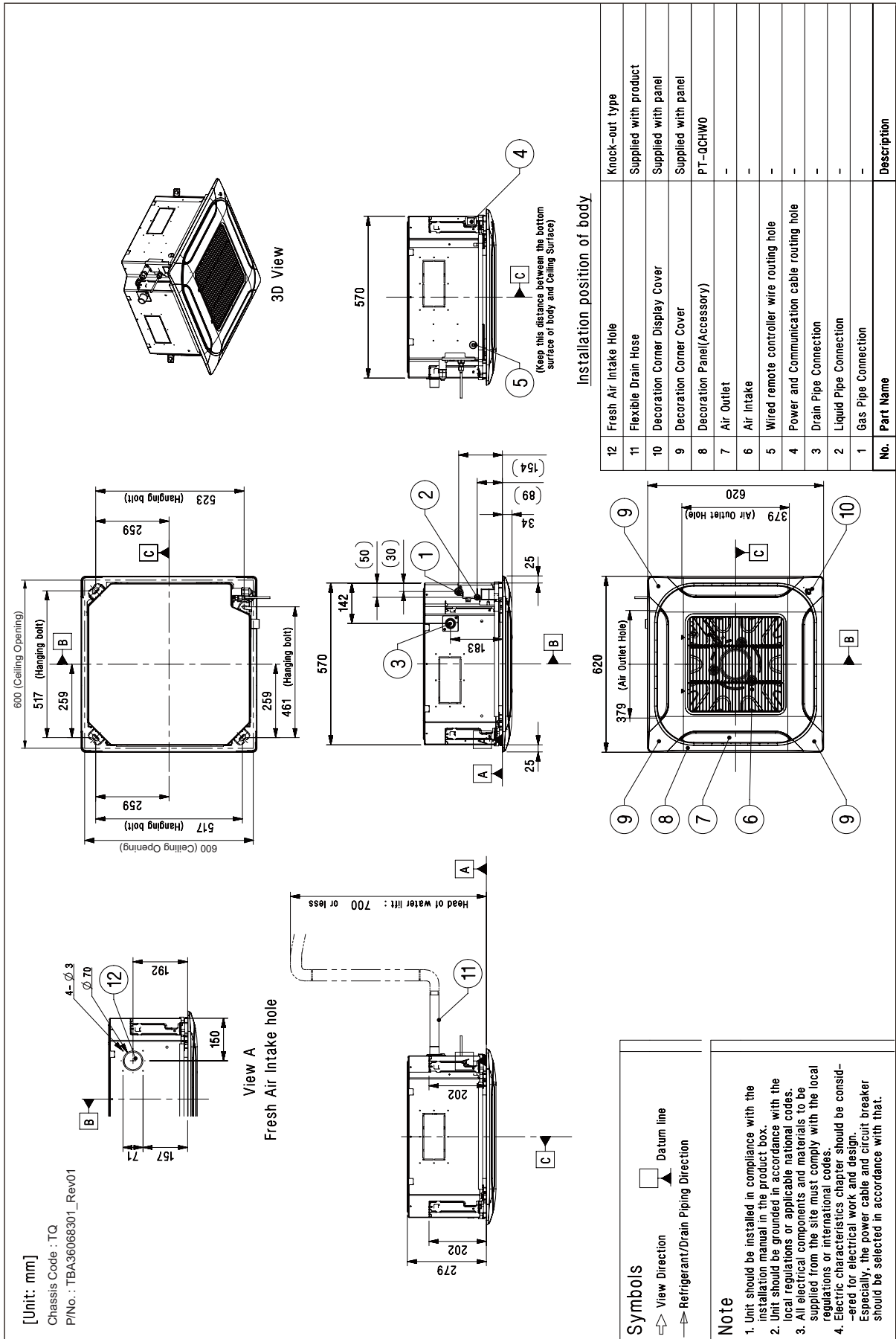

3. Dimensions

3.2 Installation Space

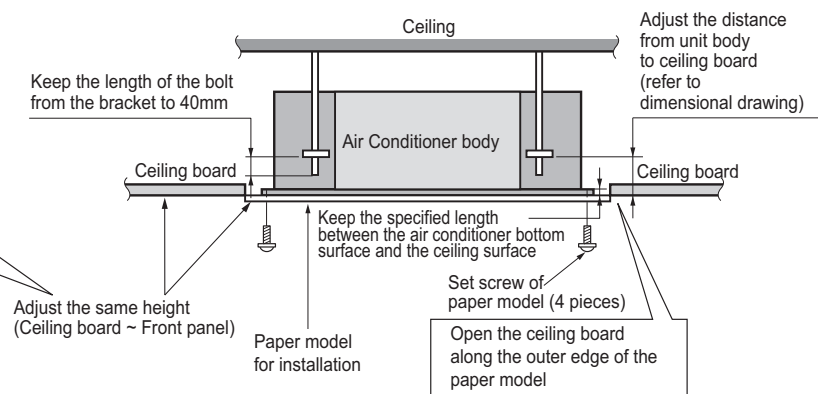
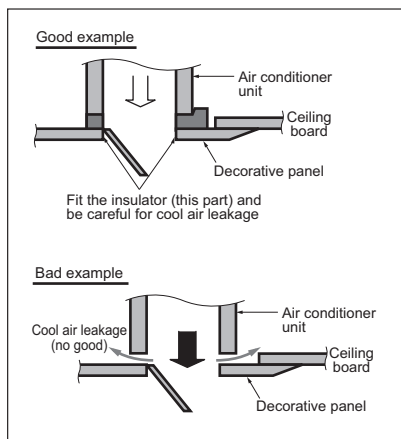
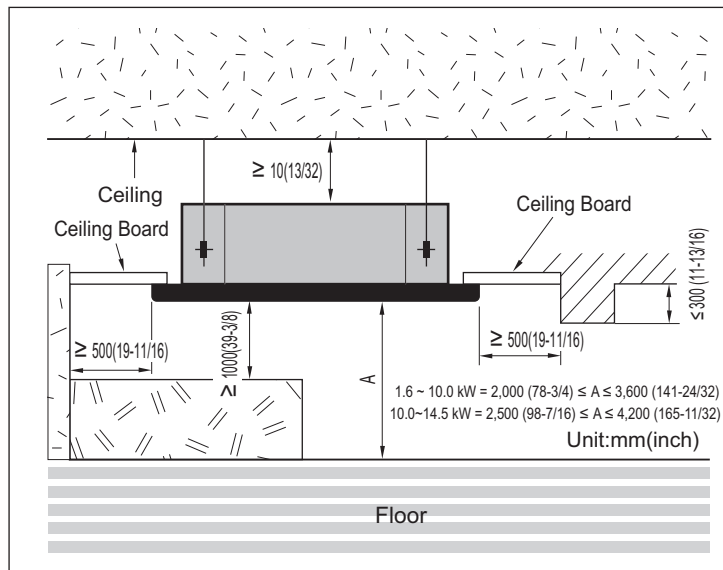

Note

- Places where products are installed should not be any obstacles to the air circulation or installation. Ensure the spaces from the wall, ceiling, or other obstacles.
- According to type of indoor unit, external appearance or installed structure could be different.
- According to product type, model line up, sales region..etc, applicability of each chassis could be different.
- Install certainly the decoration panel. Cool air leakage causes sweating or falling of water-drops.

4. Piping Diagrams

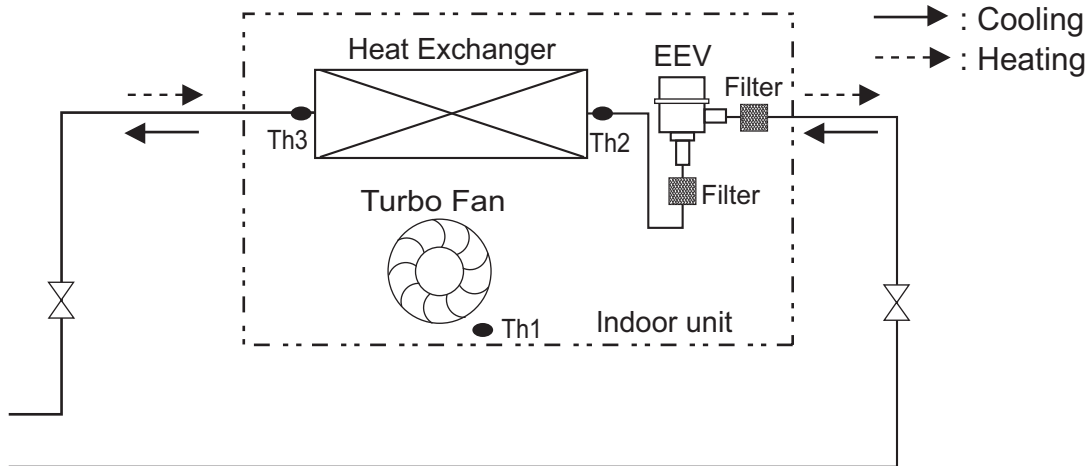

◆ Refrigerant pipe connection port diameter

Model	Gas [mm(inch)]	Liquid [mm(inch)]
ARNU05GTRB4	Ø12.7(1/2)	Ø6.35(1/4)
ARNU07GTRB4	Ø12.7(1/2)	Ø6.35(1/4)
ARNU09GTRB4	Ø12.7(1/2)	Ø6.35(1/4)
ARNU12GTRB4	Ø12.7(1/2)	Ø6.35(1/4)
ARNU15GTQB4	Ø12.7(1/2)	Ø6.35(1/4)
ARNU18GTQB4	Ø12.7(1/2)	Ø6.35(1/4)
ARNU21GTQB4	Ø15.88(5/8)	Ø9.52(3/8)

LOC.	Description
Th1	Room thermistor
Th2	Pipe in thermistor
Th3	Pipe out thermistor

5. Wiring Diagrams

TRA4

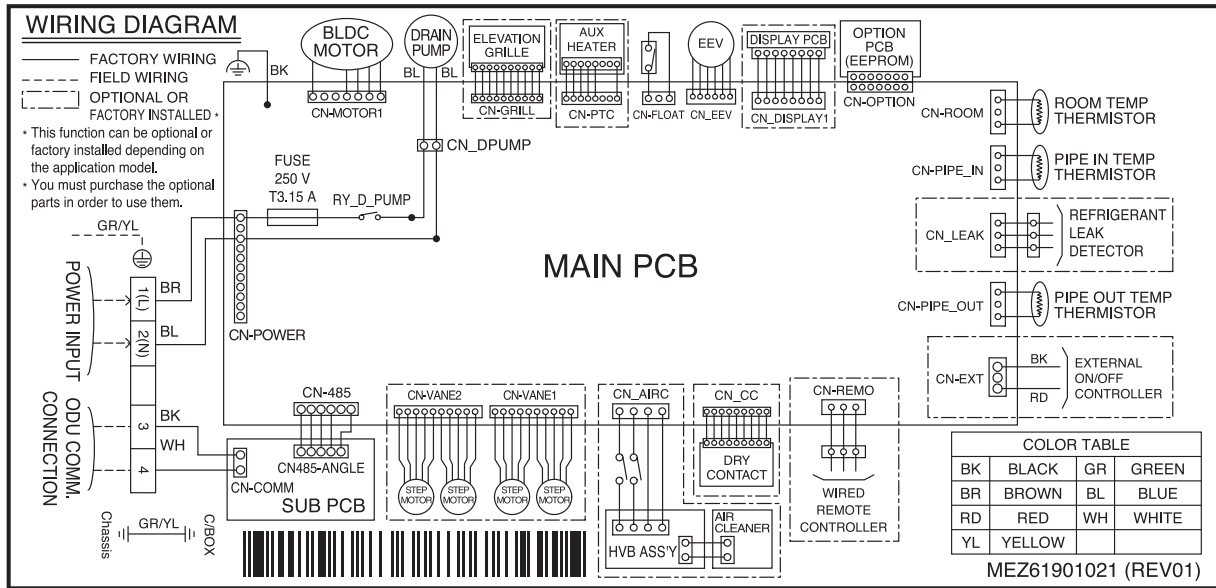

CONNECTOR NUMBER	LOCATION POINT	FUNCTION
CN-MOTOR1	Fan motor output	Motor output of BLDC
CN_DPUMP	Drain pump output	AC output for drain pump
CN-GRILL	Elevation grill	Elevation grill line
CN-PTC	Aux heater	Aux heater line
CN-LEAK	Refrigerant leak detector	Refrigerant leak detector line
CN-AIRC	Air cleaner	Air cleaner line
CN-DISPLAY	Display	Display of indoor status
CN-OPTION	Option pwb.	Communication between main and option
CN-EEV	EEV Output	EEV Control output
CN-FLOAT	Float switch input	Float switch sensing
CN-ROOM	Room sensor	Room air thermistor
CN-PIPE_IN	Suction pipe sensor	Pipe in thermistor
CN-PIPE_OUT	Discharge pipe sensor	Pipe out thermistor
CN-REMO	Remote controller	Remote control line
CN-CC	Dry contact	Dry contact line
CN-COMM	Communication	Communication between indoor and outdoor
CN-VANE1	Step motor	Step motor output
CN-VANE2	Step motor	Step motor output
CN-485	Communication	Connection between indoor and outdoor
CN-EXT	External On/Off	External On/Off signal input

Dip Switch Setting		Off	On	Remarks
SW3	GROUP	Master	Slave	Group Control setting using Wired Remote Controller
SW4	DRY CONTACT	Variable	Auto	Old Dry Contact Mode Setting 1. Variable : Auto/Manual Mode can be chosen by Wide wired remote controller or Wireless remote controller (When shipped from Factory → Manual Mode) 2. Auto : For Dry Contact, it is always Auto mode.
SW5	EXTRA 1	Off	On	1. Duct model -. OFF : Default(not operate continuously) -. ON : Fan operate continuously 2. Cassette Model : No Function 3. Ceiling Suspended Model -. OFF : Ceiling(default) -. ON : Floor

CAUTION

For Multi V Model, Dip Switch 1,2,6,7,8 must be set OFF
 Those are used for the other model.

5. Wiring Diagrams

TRB4 / TQ

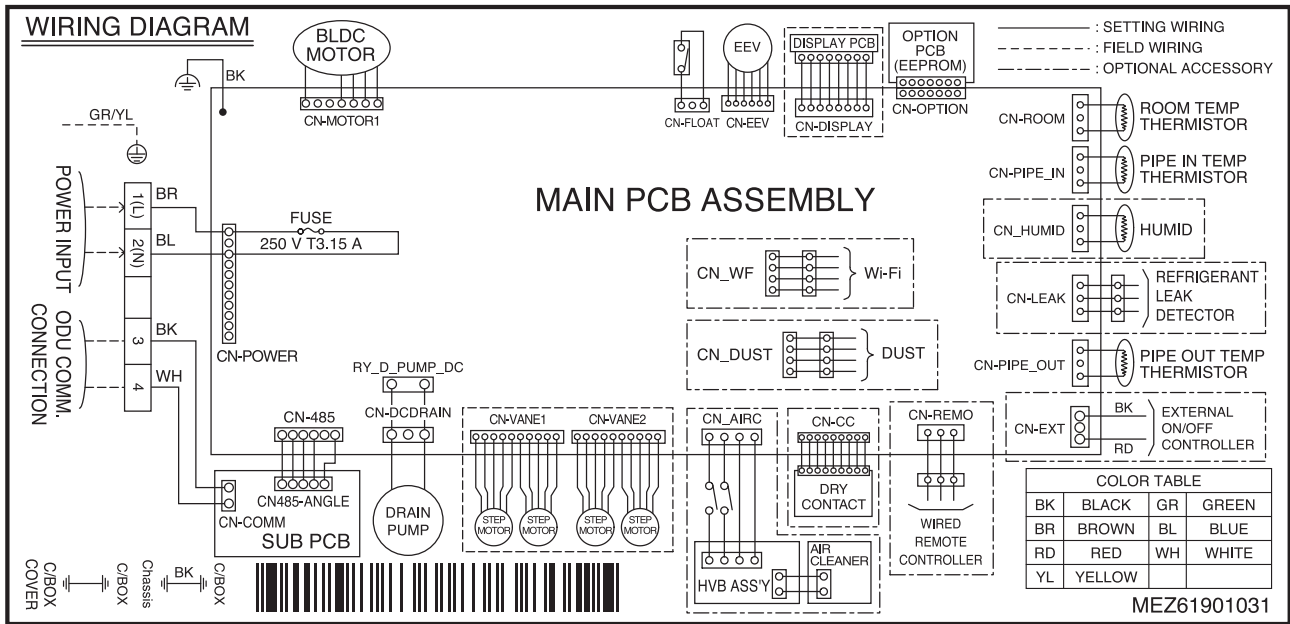

CONNECTOR NUMBER	LOCATION POINT	FUNCTION
CN-MOTOR1	Fan motor output	Motor output of BLDC
CN_DPUMP	Drain pump output	AC output for drain pump
CN-LEAK	Refrigerant leak detector	Refrigerant leak detector line
CN-AIRC	Air cleaner	Air cleaner line
CN-DISPLAY	Display	Display of indoor status
CN-OPTION	Option pwb.	Communication between main and option
CN-EEV	EEV Output	EEV Control output : connect to EEV directly or through IPM(Independent Power Module)
CN-FLOAT	Float switch input	Float switch sensing
CN-ROOM	Room sensor	Room air thermistor
CN-PIPE_IN	Suction pipe sensor	Pipe in thermistor
CN-PIPE_OUT	Discharge pipe sensor	Pipe out thermistor
CN-REMO	Remote controller	Remote control line
CN-CC	Dry contact	Dry contact line
CN-COMM	Communication	Communication between indoor and outdoor
CN-VANE1	Step motor	Step motor output
CN-VANE2	Step motor	Step motor output
CN-485	Communication	Connection between indoor and outdoor
CN-EXT	External On/Off	External On/Off signal input
CN_WF	Wi-Fi Controller	Wifi control line
CN_DUST	Dust sensor	Dust detector line
CN_HUMID	Humid sensor	Humid sensing

Dip Switch Setting		Off	On	Remarks
SW3	GROUP	Master	Slave	Group Control setting using Wired Remote Controller
SW4	DRY CONTACT	Variable	Auto	Old Dry Contact Mode Setting 1. Variable : Auto/Manual Mode can be chosen by Wide wired remote controller or Wireless remote controller (When shipped from Factory → Manual Mode) 2. Auto : For Dry Contact, it is always Auto mode.
SW5	EXTRA 1	Off	On	1. Duct model -. OFF : Default(not operate continuously) -. ON : Fan operate continuously 2. Cassette Model : No Function 3. Ceiling Suspended Model -. OFF : Ceiling(default) -. ON : Floor

CAUTION

For Multi V Model, Dip Switch 1,2,6,7,8 must be set OFF
 Those are used for the other model.

6. Capacity Tables

■ Cooling Capacity

Nominal Capacity (kBtu/h) [Capacity Index (kW)]	Indoor air temp. (DB/WB, °C)													
	20		23		26		27		28		30		32	
	14		16		18		19		20		22		24	
	TC	SHC	TC	SHC	TC	SHC	TC	SHC	TC	SHC	TC	SHC	TC	SHC
5 [1.6]	1.1	1.0	1.3	1.1	1.5	1.2	1.6	1.2	1.7	1.2	1.7	1.2	1.8	1.1
7 [2.2]	1.5	1.4	1.8	1.5	2.0	1.7	2.2	1.7	2.4	1.8	2.4	1.7	2.4	1.5
9 [2.8]	1.9	1.6	2.2	1.8	2.6	2.0	2.8	2.0	3.0	2.1	3.0	2.0	3.1	1.8
12 [3.6]	2.4	2.1	2.9	2.3	3.3	2.5	3.6	2.5	3.9	2.6	3.9	2.5	4.0	2.3
15 [4.5]	3.0	2.6	3.6	3.0	4.2	3.2	4.5	3.3	4.8	3.4	4.9	3.2	4.9	3.0
18 [5.6]	3.8	3.0	4.5	3.4	5.2	3.8	5.6	3.9	6.0	4.0	6.1	3.8	6.2	3.5
21 [6.2]	4.1	3.2	4.8	3.6	5.6	4.1	6.0	4.2	6.4	4.3	6.5	4.1	6.6	3.8

Note

1. TC: Total Capacity(kW), SHC: Sensible Heat Capacity(kW)
2. Capacity tables show the average value of conditions which may occur.
3. Refer to Capacity tables and correction factor in the outdoor unit PDB for the actual performance data of each indoor unit and outdoor unit combination.

■ Heating Capacity

Nominal Capacity (kBtu/h) [Capacity Index (kW)]	Indoor air temp. (DB, °C)									
	16		18		20		22		24	
	TC	TC	TC	TC	TC	TC	TC	TC		
5 [1.6]	2.0	1.9	1.8	1.7	1.7	1.6				
7 [2.2]	2.8	2.7	2.5	2.4	2.3	2.2				
9 [2.8]	3.6	3.4	3.2	3.1	3.0	2.8				
12 [3.6]	4.5	4.3	4.0	3.9	3.7	3.5				
15 [4.5]	5.6	5.3	5.0	4.8	4.7	4.4				
18 [5.6]	7.1	6.7	6.3	6.1	5.9	5.5				
21 [6.2]	7.7	7.2	6.8	6.6	6.4	5.9				

Note

1. TC: Total Capacity(kW)
2. Capacity tables show the average value of conditions which may occur.
3. Refer to Capacity tables and correction factor in the outdoor unit PDB for the actual performance data of each indoor unit and outdoor unit combination.

7. Air Velocity and Temperature Distribution(Reference Data)

◆ ARNU05GTR*4, ARNU07GTR*4, ARNU09GTR*4

Cooling

Discharge angle: 40°

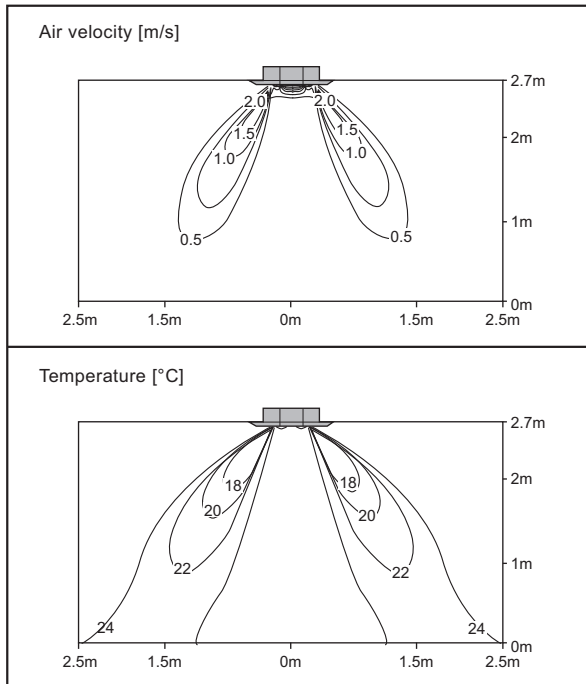

Heating

Discharge angle: 50°

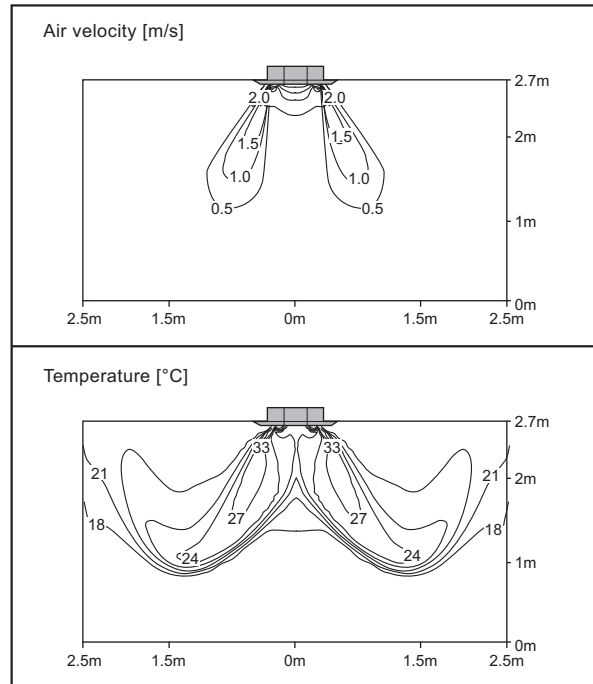

◆ ARNU12GTR*4

Cooling

Discharge angle: 40°

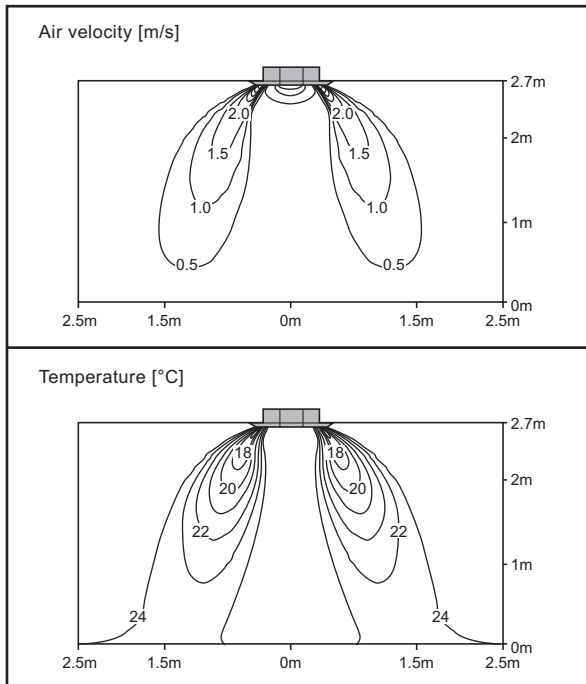

Heating

Discharge angle: 50°

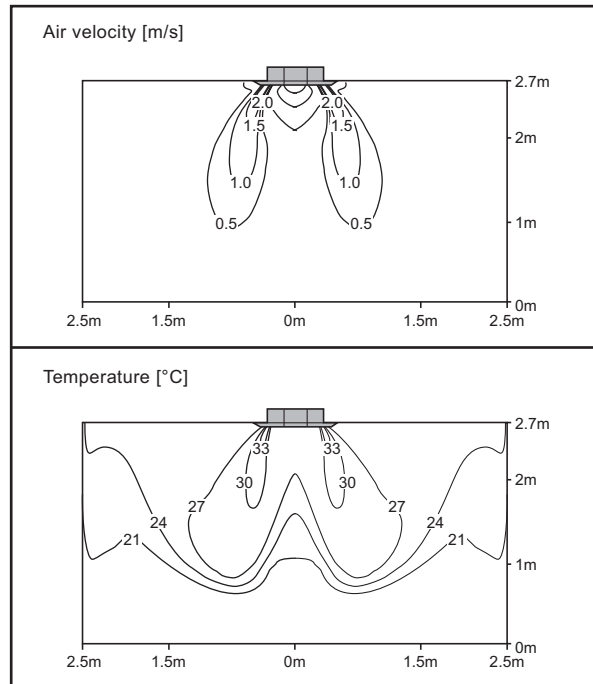

Note

- These figures are accordance with normal certain condition and environment. (Airflow step is 'High', Air discharge angle is fixed as indicated angle.)
- Indoor airflow distribution under actual installation or operating conditions depends on ambient temperature, ceiling height, product installation direction / location, indoor / Heating load, and other obstacles, etc.

7. Air Velocity and Temperature Distribution(Reference Data)

◆ ARNU15GTQB4

Cooling

Discharge angle: 40°

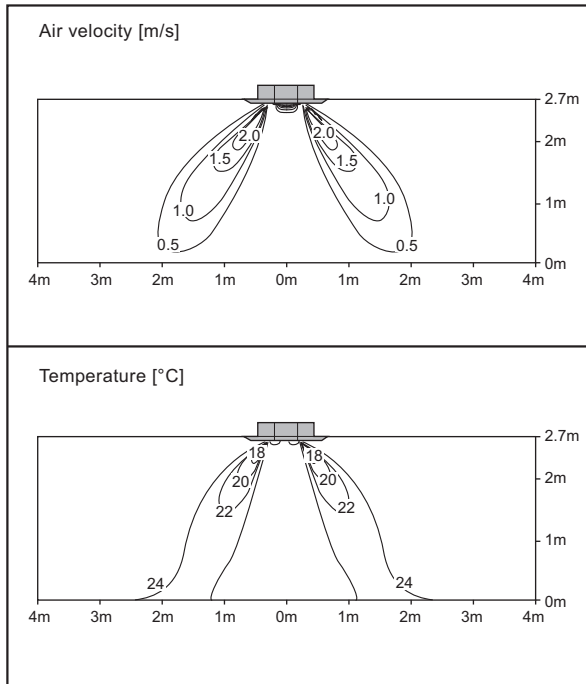

Heating

Discharge angle: 50°

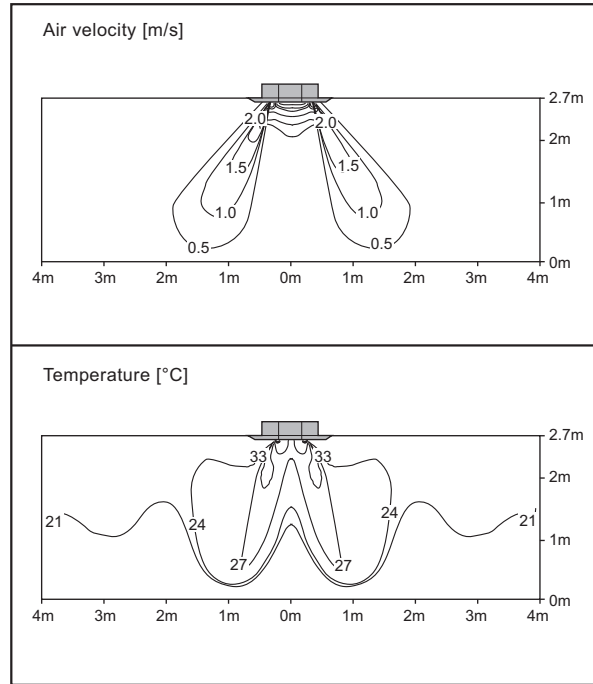

◆ ARNU18GTQB4

Cooling

Discharge angle: 40°

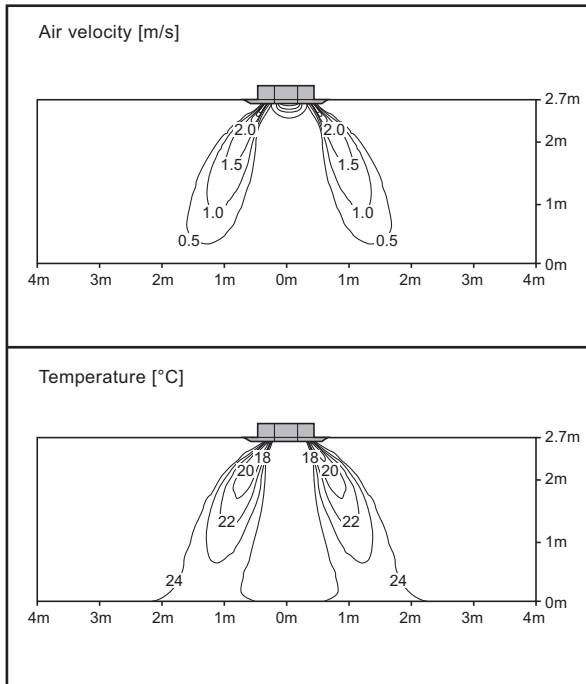

Heating

Discharge angle: 50°

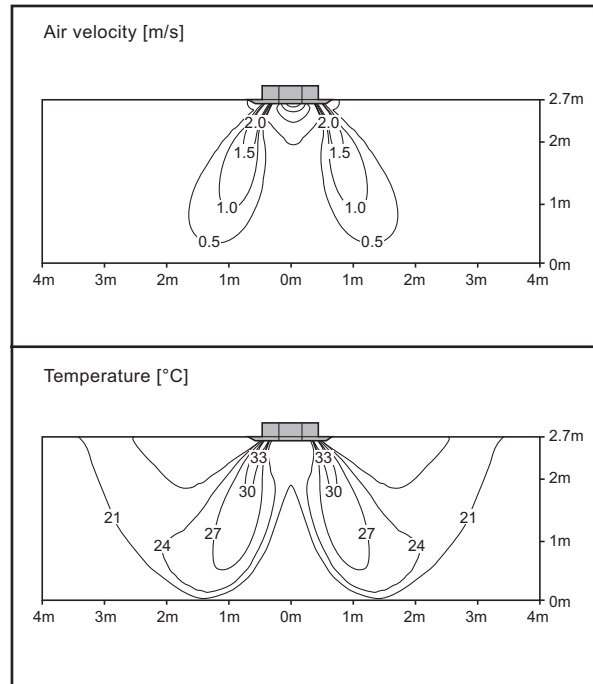

Note

- These figures are accordance with normal certain condition and environment. (Airflow step is 'High', Air discharge angle is fixed as indicated angle.)
- Indoor airflow distribution under actual installation or operating conditions depends on ambient temperature, ceiling height, product installation direction / location, indoor / Heating load, and other obstacles, etc.

7. Air Velocity and Temperature Distribution(Reference Data)

◆ ARNU21GTQB4

Cooling

Discharge angle: 40°

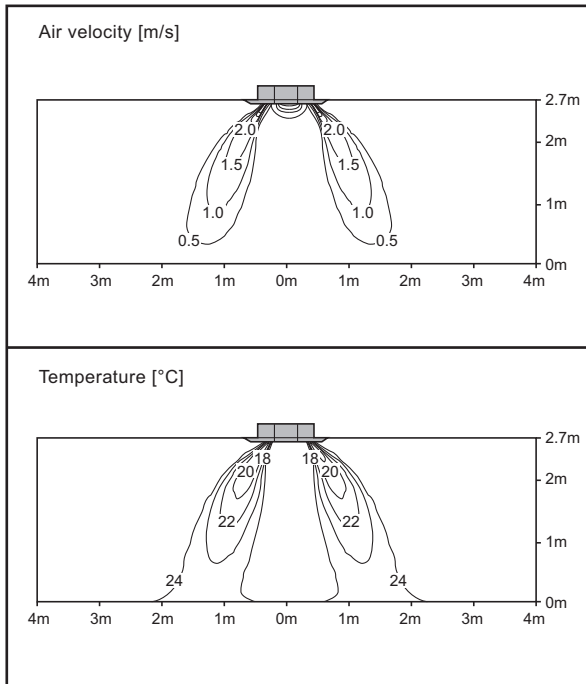

Heating

Discharge angle: 50°

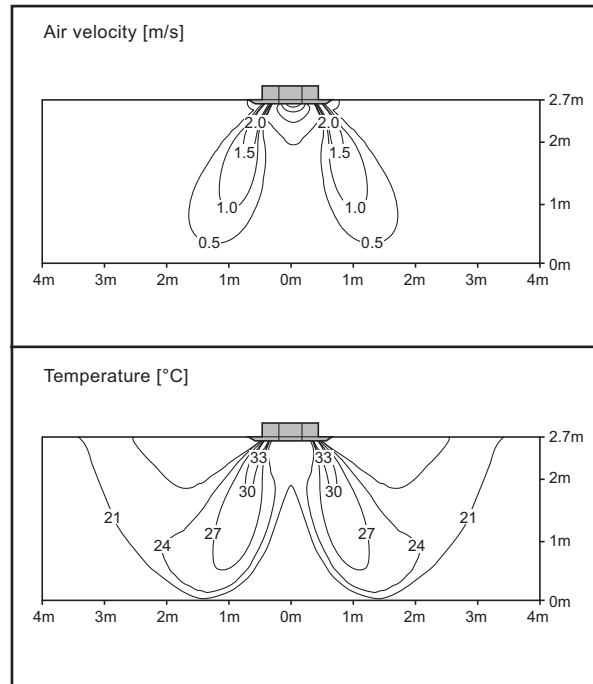

Note

- These figures are accordance with normal certain condition and environment. (Airflow step is 'High', Air discharge angle is fixed as indicated angle.)
- Indoor airflow distribution under actual installation or operating conditions depends on ambient temperature, ceiling height, product installation direction / location, indoor / Heating load, and other obstacles, etc.

8. Electric Characteristics

Units					Power Supply	IFM		PI	
Model	Type	Hz	Volts	Voltage Range	MCA	kW	FLA	Cooling	Heating
ARNU05GTR*4	TR	50	220-240	Max:264 Min:198	0.25	0.043	0.20	30	30
ARNU07GTR*4	TR				0.25	0.043	0.20	30	30
ARNU09GTR*4	TR				0.25	0.043	0.20	30	30
ARNU12GTR*4	TR				0.25	0.043	0.20	30	30
ARNU15GTQB4	TQ				0.25	0.043	0.20	30	30
ARNU18GTQB4	TQ				0.25	0.043	0.20	30	30
ARNU21GTQB4	TQ				0.25	0.043	0.20	30	30
ARNU05GTR*4	TR	60	220	Max:242 Min:198	0.25	0.043	0.20	30	30
ARNU07GTR*4	TR				0.25	0.043	0.20	30	30
ARNU09GTR*4	TR				0.25	0.043	0.20	30	30
ARNU12GTR*4	TR				0.25	0.043	0.20	30	30
ARNU15GTQB4	TQ				0.25	0.043	0.20	30	30
ARNU18GTQB4	TQ				0.25	0.043	0.20	30	30
ARNU21GTQB4	TQ				0.25	0.043	0.20	30	30

Symbols

MCA : Minimum Circuit Amperes (A)

kW : Fan Motor Rated Output (kW)

FLA : Full Load Amperes (A)

IFM : Indoor Fan Motor

PI : Maximum Power Input (W)

Note

- Voltage range
Units are suitable for use on electrical systems where voltage supplied to unit terminals is not below or above the listed range limits.
- Maximum allowable voltage unbalance between phases is 2%.
- MCA/MFA
 $MCA = 1.25 \times FLA$
 $MFA = 1.1 \times MCA, MFA \leq 4 \times FLA$
 (If MFA is smaller than minimum standard value, Use minimum standard value in region for selecting circuit breaker.)
- Select wire size based on the MCA
- Instead of fuse, use Circuit Breaker.

9. Sound Levels

9.1 Sound Pressure Levels

Overall

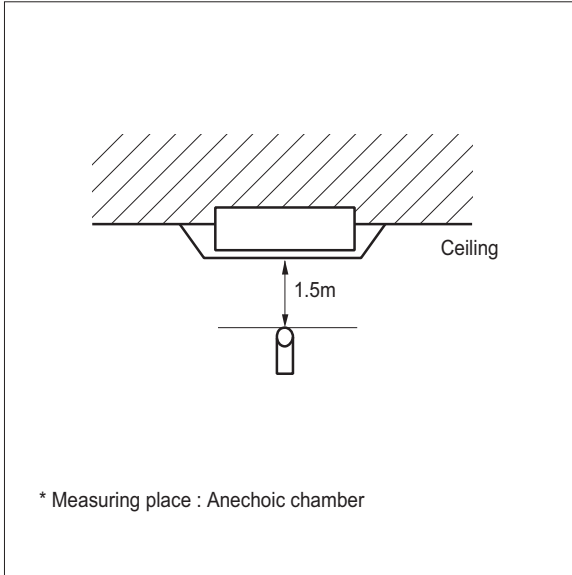

Note

1. Sound measured at some distance away from the center of the unit.
2. Data is valid at free field condition.
3. Reference acoustic pressure 0dB = 20μPa.
4. Data is valid at nominal operation condition.
Refer to the Model Specifications for nominal conditions(Power source and Ambient temperature, etc)
5. Sound levels can be increased in accordance with installation and operating conditions. (Static pressure mode, used air guide, Room target temperature setting, etc)
6. Sound level will vary depending on a range of factors such as the construction(acoustic absorption coefficient) of the particular room in which the equipment is installed.
7. Sound pressure level is measured on the rated condition in the anechoic rooms by ISO 3745 standard.
Therefore, these values can be increased owing to ambient conditions during operation.

Model	Sound Pressure Levels [dB(A)]		
	H	M	L
ARNU05GTR*4	29	27	26
ARNU07GTR*4	29	27	26
ARNU09GTR*4	30	29	27
ARNU12GTR*4	32	30	27
ARNU15GTQB4	36	34	32
ARNU18GTQB4	37	35	34
ARNU21GTQB4	40	38	34

ARNU05GTR*4

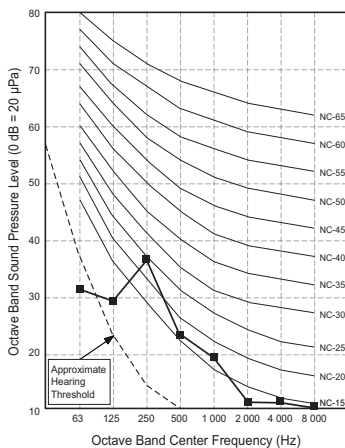

ARNU07GTR*4

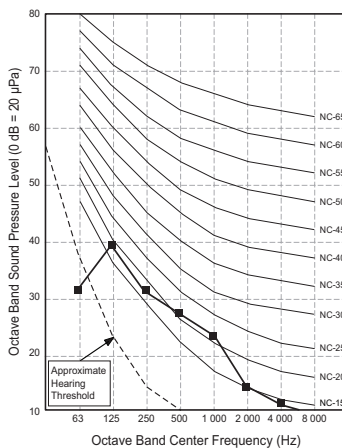

ARNU09GTR*4

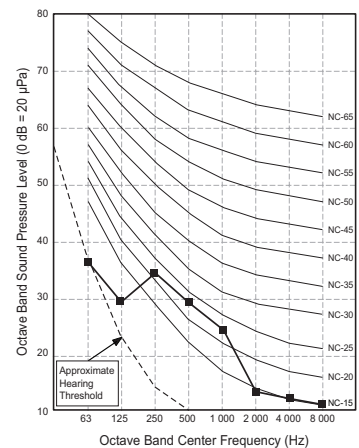

9. Sound Levels

ARNU12GTR*4

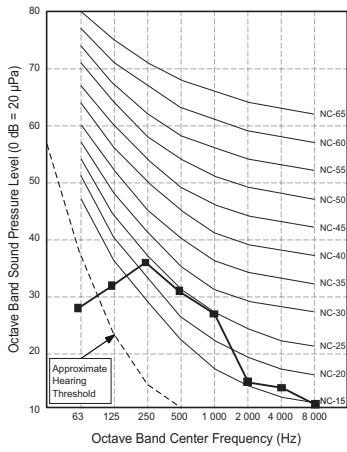

ARNU15GTQB4

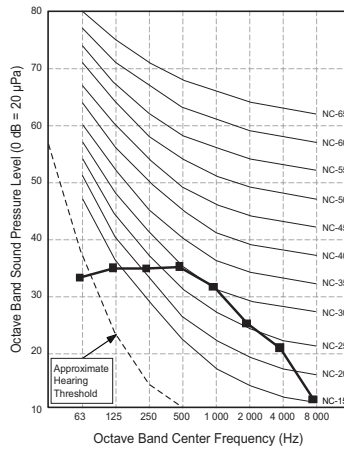

ARNU18GTQB4

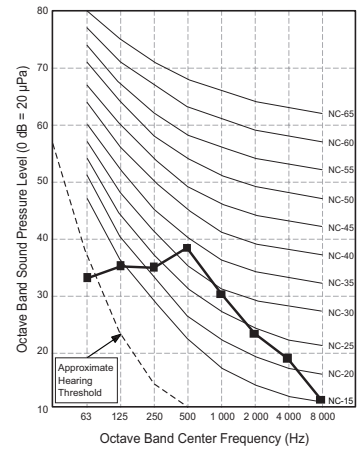

ARNU21GTQB4

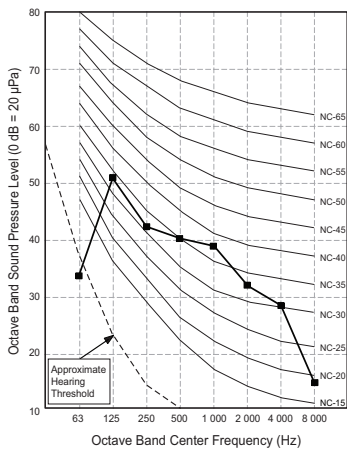

9. Sound Levels

9.2 Sound Power Levels

Note

- Data is valid at diffuse field condition
- Data is valid at nominal operating condition
- Sound level can be increased in static pressure mode or used air guide.
- Sound level will vary depending on a range of factors such as the construction (acoustic absorption coefficient) of particular room in which the equipment is installed.
- Reference acoustic intensity 0dB = 10E-6μW/m²
- Sound power level is measured on the rated condition in the semi-anechoic rooms by ISO 9614 standard. Therefore, these values can be increased owing to ambient conditions during operation.

Model	Sound Power Levels [dB(A)]		
	H	M	L
ARNU05GTR*4	47	46	45
ARNU07GTR*4	47	46	45
ARNU09GTR*4	48	46	45
ARNU12GTR*4	51	48	45
ARNU15GTQB4	52	50	46
ARNU18GTQB4	52	50	46
ARNU21GTQB4	54	52	46

**ARNU05GTR*4
ARNU07GTR*4**

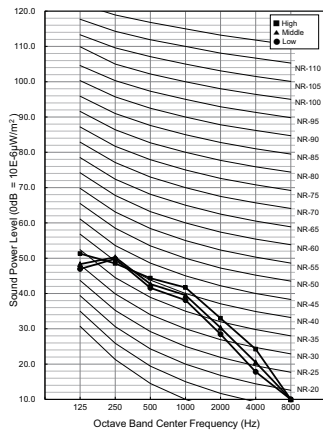

ARNU09GTR*4

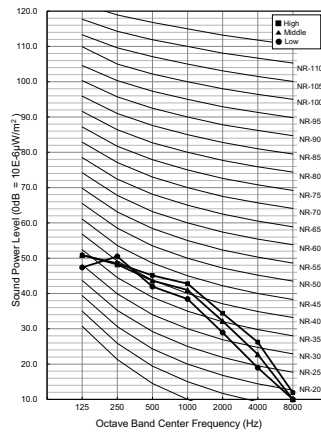

ARNU12GTR*4

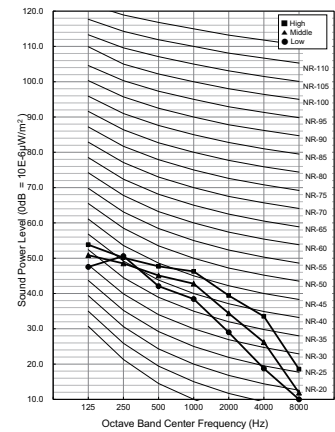

ARNU15GTQB4

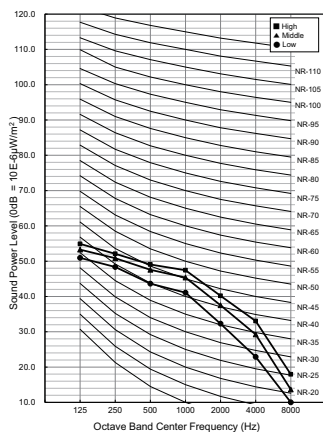

ARNU18GTQB4

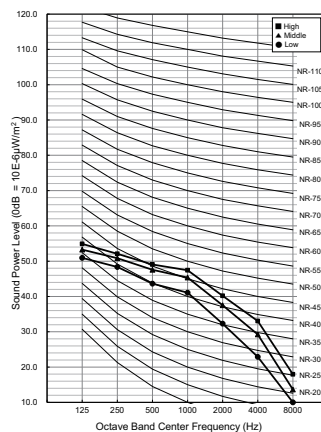

ARNU21GTQB4

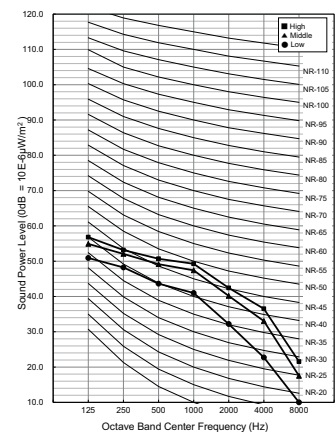

9. Sound Levels

Ceiling Mounted Cassette (Dual Vane 4-Way)

- 1. List of functions**
- 2. Specifications**
- 3. Dimensions**
- 4. Piping Diagrams**
- 5. Wiring Diagrams**
- 6. Capacity Tables**
- 7. Air Velocity and Temperature Distribution**
- 8. Electric Characteristics**
- 9. Sound Levels**

1. List of functions

Category	Function	ARNU24GTBB4, ARNU28GTBB4, ARNU30GTBB4 ARNU36GTAB4, ARNU42GTAB4, ARNU48GTAB4
Air Flow	Air Supply Outlet	4
	Airflow Direction Control (left & right)	X
	Airflow Direction Control (up & down)	Auto
	Auto Swing (left & right)	X
	Auto Swing (up & down)	O
	Airflow Steps (fan/cool/heat)	4 / 5 / 5
	Fan Speed Auto*	Advanced
	Power Cool/Heat	O / O
	Swirl Wind*	O
	Refresh Mode**	O
	Smart Mode**	O
	Indirect Wind*	O
	Direct Wind*	O
	Dry Operation	O
Air Purification	Air Purify	Accessory
	Ionizer	X
	UV-C	X
	Pre-Filter	O
Reliability	Hot Start	O
	Self Diagnosis	O
Convenience	Auto Mode	O
	Auto Dry Operation	O
	Auto Restart	O
	Child Lock*	O
	Forced Operation	O
	Group Control*	O
	Sleep Timer	O
	Turn On/Off Reservation	O
	Schedule*	O
	Two Thermistor Control*	O
External On/Off	O	
Installation	Drain Pump	O
	E.S.P. Control*	X
	High Ceiling Operation*	O
Special Functions	Wi-Fi	Accessory
	Auto Elevation Grille	X
	Human Detection Function**	Accessory
	Floor Detection Function**	Accessory

Note

- O : Applied, X : Not Applied, - : Unconfirmed or irrelevant
Embedded : A kit is provided by default for using this function when the product is manufactured.
Accessory : Ordered and purchased separately the accessory package referring to the model name provided and install at field. Accessory line-ups varies by region, so check your local catalogue or local sales material.
- Some functions can be limited by remote controller.
- In case of cassette type indoor units, Air Purification Kit and Auto Elevation Grille functions are not applicable at the same time.
- 'Auto Mode' varies depending on the outdoor unit type.
 - Auto Change Over(Heat Recovery Outdoor Unit)
 - Auto Mode Select(Heat Pump Outdoor Unit)
 - Auto Intensity Control(Cooling Only Outdoor Unit)
- * : These functions need to connect the wired remote controller.
- ** : This functions need to connect to the Standard III wired remote controller.

1. List of functions

■ Accessory Compatibility List

Category	Accessory Name	Model Name	Description	ARNU24GTBB4 ARNU28GTBB4 ARNU30GTBB4 ARNU36GTAB4 ARNU42GTAB4 ARNU48GTAB4
Remote Controller	Wired - Premium	PREMTA000	-	○
		PREMTA000A	-	○
		PREMTA000B	-	○
	Wired - RS3 (Standard III)	PREMTB100/PREMTB101	White	○
		PREMTBB10/PREMTBB11	Black	○
	Wired - RS2 (Standard II)	PREMTB001	White	X
		PREMTBB01	Black	X
	Wired - Simple	PQRCVCL0QW	White	X
		PQRCVCL0Q	Black	X
	Wired - Simple for Hotel	PQRCHCA0QW	White	X
		PQRCHCA0Q	Black	X
	Wireless	PQWRCQ0FDB	For Cooling only	○
PQWRHQ0FDB		For Heat pump	○	
PWLSSB21C		For Cooling only	○	
PWLSSB21H		For Heat pump	○	
Dry Contact	Simple	PDRYCB000	1 input port, AC 220 - 240V	○
		PDRYCB100	1 input port, AC 24V	○
	Communication	PDRYCB400	2 input port	○
		PDRYCB300	8 input port, For 3rd party Thermostat	○
		PDRYCB320	8 input port, For 3rd Party Thermostat (Analog Input)	○
		PDRYCB500	For 3rd Party Controller (Modbus RTU)	○
Integration Device	Remote Temperature sensor	PQRSTA0	-	○
	Group Control wire	PZCWRCG3	Cable Assembly for group control (Y-type cable : 0.25m, cable : 9.6m)	○
ETC	Extension wire	PZCWRC1	Extension wire for IDU-wired remote controller (9.6m)	○
	2-Remo Control Wire	PZCWRC2	-	○
	Wi-Fi Modem	PWFMDD200	-	○
	Wi-Fi Extension cable	PWYREW000	USB Extension cable : 10 m	○
	Independent Power Module	PRIP0	-	○
	Multi-tenant Power Module	PINPMB001	-	○
	Refrigerant Leakage Detector	PRLDNVS0	For R410A only	○
	Human Detection Sensor	PTVSMA0	For Cassette 4-way	X
		PTVSAA0	For Cassette Dual Vane 4-way	○
	Floor Detection Sensor	PTFSMA0	-	○
	Auto Elevation Grille	PTEGM0	For TP/TN/TM	X
	Ionizer	PAS-NATDR2	-	X
	Air Purification Kit	PTAHTP0	For Cassette 1-way	X
		PTAHMP0	For Cassette 4-way	○
		PTAHYP0	For Cassette Round	X
	EEV Kit	PRGK024A0	For Multi V Indoor Unit	X
	Auxiliary Heater Relay Kit	PRARS1	For Wall Mounted and Art Cool Indoor Units	X
		PRARH1	For Cassette and Duct Indoor Units	○
	Ventilation Kit	PTVK430	For TR/TQ/TP/TN/TM	X
		PTVK410 + PTVK420	For TP/TN/TM	X
Cassette Cover	PTDCQ	For TR/TQ	X	
	PTDCM	For TP/TN/TM	X	
	PTDCA	For TM-A/TP-B	○	

Note

1. ○: Possible, X: Impossible, -: Not applicable, Embedded : Included with product.
2. If there is a difference in development time between the product and the remote controller, some functions cannot be operated.
3. If using Wi-Fi controller, Some advanced functions controlled by remote controller cannot be operated.
4. If you need more detail, please refer to the **BECON** PDB or the manual of product. (<http://partner.lge.com/global> : Home> Doc.Library> Product > Control(BECON))

1. List of functions

■ Panel(Accessory)

Model Name			PT-AAGW0	PT-AFGW0
Description	-		Standard Panel	Premium Panel
Exterior Color	-		White	White
RAL Code	-		RAL 9003	RAL 9003
Dual Vane	-		O	O
Dimensions (W x H x D)	Net	mm	950 x 35 x 950	950 x 35 x 950
	Shipping	mm	1,006 x 102 x 1,006	1,006 x 117 x 1,006
Weight	Net	kg	7.1	7.5
	Shipping	kg	9.3	9.4
Function	PM1.0 Sensor	-	X	O
Accessory	Air Purification Kit	-	X	PTAHMP0
	Floor Detection Sensor*	-	PTFSMA0	PTFSMA0
	Human Detection Sensor*	-	PTVSAA0	PTVSAA0
Note				
1. Accessory : Ordered and purchased separately the accessory package referring to the model name provided and install at field.				
2. * : This functions need to connect to the RS3 wired remote controller(Standard III).				

2. Specifications

Model Name		Unit	ARNU24GTBB4	ARNU28GTBB4
Power Supply	#1	V, Φ , Hz	220-230-240, 1, 50/60	220-230-240, 1, 50/60
	Running Current by Voltage	A	0.34 / 0.32 / 0.31	0.37 / 0.36 / 0.34
Cooling Capacity	Rated	kW	7.1	8.2
		Btu/h	24,200	28,000
Heating Capacity	Rated	kW	8.0	9.2
		Btu/h	27,300	31,500
Power Input	H/M/L	W	32 / 27 / 20	37 / 30 / 22
Running Current	H/M/L	A	0.31 / 0.26 / 0.21	0.34 / 0.28 / 0.22
Fan	Type	-	3D Turbo Fan	3D Turbo Fan
	Air Flow Rate(H/M/L)	m ³ /min	18 / 17 / 15	19 / 17 / 15
Fan Motor	Type	-	Brushless DC	Brushless DC
	Drive	-	Direct	Direct
	Output	W	51	51
No.		1	1	
Heat Exchanger	Rows x Columns x FPI	-	3 x 8 x 21	3 x 8 x 21
	No.	-	1	1
	Face Area	m ²	0.33	0.33
Dimensions	Net(W x H x D)	mm	840 x 204 x 840	840 x 204 x 840
	Shipping(W x H x D)	mm	922 x 276 x 917	922 x 276 x 917
Weight	Net	kg	21.0	21.0
	Shipping	kg	26.0	26.0
Exterior	Color	-	White	White
	RAL Code	-	RAL 9003	RAL 9003
Air Filter	Type	-	Long life	Long life
Temperature Control	-	-	Microprocessor, Thermostat for cooling and heating	
Sound Absorbing / Thermal Insulation Material	-	-	Foamed polystyrene	Foamed polystyrene
Protection Device	-	-	Fuse	Fuse
Refrigerant	Type	-	R410A / R32	R410A / R32
	Additional Charging amount	kg(each)	0.32 / 0.26	0.32 / 0.26
	Control Type	-	EEV	EEV
Drain Pipe	O.D / I.D	mm(inch)	32/25	32/25
Piping Connection	Liquid	mm(inch)	Φ 9.52 (3/8)	Φ 9.52 (3/8)
	Gas	mm(inch)	Φ 15.88 (5/8)	Φ 15.88 (5/8)
	Connection Type(Liquid)	-	Flare	Flare
	Connection Type(Gas)	-	Flare	Flare
Sound Pressure Level (H / M / L)		dB(A)	39.0 / 37.0 / 35.0	40.0 / 38.0 / 35.0
Sound Power Level (H / M / L)		dB(A)	46.0 / 44.0 / 42.0	50.0 / 46.0 / 43.0
Connecting Cable	Power Supply Cable(H07RN-F)	mm ² × cores	2.5 x 3	2.5 x 3
	Communication Cable(VCTF-SB)	mm ² × cores	1.0~1.5 x 2	1.0~1.5 x 2

Note

- Due to our policy of innovation some specifications may be changed without notification.
- Wiring cable size must comply with the applicable local and national code. And "Electric characteristics" chapter should be considered for electrical work and design. Especially the power cable and circuit breaker should be selected in accordance with that.
- Sound pressure level is measured on the rated condition in the anechoic rooms by ISO 3745 standard.
Sound power level is measured on the rated condition in the semi-anechoic rooms by ISO 9614 standard.
Therefore, these values can be increased owing to ambient conditions during operation.
- Capacities are net capacities and based on the following conditions. Refer to the Outdoor Unit Specifications for calculating the real capacity.
 - Cooling : Indoor Ambient Temp. 27°CDB / 19°CWB, Outdoor Ambient Temp. 35°CDB / 24°CWB
 - Heating : Indoor Ambient Temp. 20°CDB / 15°CWB, Outdoor Ambient Temp. 7°CDB / 6°CWB
 - Interconnected Pipe is standard length and difference of Elevation (Outdoor ~ Indoor Unit) is 0m.
- Refrigerant information (type, additional charging amount, etc.) must be applied by refrigerant type of the combined outdoor unit.
Adapt after checking the specifications of outdoor unit.
- Air flow rate could be different in accordance with 'High ceiling operation' mode setting value.

2. Specifications

Model Name		Unit	ARNU30GTBB4	ARNU36GTAB4
Power Supply	#1	V, Φ , Hz	220-230-240, 1, 50/60	220-230-240, 1, 50/60
	Running Current by Voltage	A	0.47 / 0.45 / 0.43	0.68 / 0.65 / 0.62
Cooling Capacity	Rated	kW	9.0	10.6
		Btu/h	30,700	36,200
Heating Capacity	Rated	kW	10.0	11.9
		Btu/h	34,100	40,600
Power Input	H/M/L	W	48 / 36 / 25	69 / 49 / 37
Running Current	H/M/L	A	0.43 / 0.34 / 0.25	0.62 / 0.46 / 0.36
Fan	Type	-	3D Turbo Fan	3D Turbo Fan
	Air Flow Rate(H/M/L)	m ³ /min	21 / 19 / 16	29 / 26 / 22
Fan Motor	Type	-	Brushless DC	Brushless DC
	Drive	-	Direct	Direct
	Output	W No.	51 1	135 1
Heat Exchanger	Rows x Columns x FPI	-	3 x 8 x 21	3 x 12 x 21
	No.	-	1	1
	Face Area	m ²	0.33	0.50
Dimensions	Net(W x H x D)	mm	840 x 204 x 840	840 x 288 x 840
	Shipping(W x H x D)	mm	922 x 276 x 917	922 x 360 x 917
Weight	Net	kg	21.0	27.0
	Shipping	kg	26.0	31.5
Exterior	Color	-	White	White
	RAL Code	-	RAL 9003	RAL 9003
Air Filter	Type	-	Long life	Long life
Temperature Control	-	-	Microprocessor, Thermostat for cooling and heating	
Sound Absorbing / Thermal Insulation Material	-	-	Foamed polystyrene	Foamed polystyrene
Protection Device	-	-	Fuse	Fuse
Refrigerant	Type	-	R410A / R32	R410A / R32
	Additional Charging amount	kg(each)	0.32 / 0.26	0.49 / 0.41
	Control Type	-	EEV	EEV
Drain Pipe	O.D / I.D	mm(inch)	32/25	32/25
Piping Connection	Liquid	mm(inch)	Φ 9.52 (3/8)	Φ 9.52 (3/8)
	Gas	mm(inch)	Φ 15.88 (5/8)	Φ 15.88 (5/8)
	Connection Type(Liquid)	-	Flare	Flare
	Connection Type(Gas)	-	Flare	Flare
Sound Pressure Level (H / M / L)		dB(A)	43.0 / 40.0 / 36.0	43.0 / 40.0 / 37.0
Sound Power Level (H / M / L)		dB(A)	53.0 / 50.0 / 45.0	54.0 / 51.0 / 47.0
Connecting Cable	Power Supply Cable(H07RN-F)	mm ² × cores	2.5 x 3	2.5 x 3
	Communication Cable(VCTF-SB)	mm ² × cores	1.0~1.5 x 2	1.0~1.5 x 2

Note

- Due to our policy of innovation some specifications may be changed without notification.
- Wiring cable size must comply with the applicable local and national code. And "Electric characteristics" chapter should be considered for electrical work and design. Especially the power cable and circuit breaker should be selected in accordance with that.
- Sound pressure level is measured on the rated condition in the anechoic rooms by ISO 3745 standard.
Sound power level is measured on the rated condition in the semi-anechoic rooms by ISO 9614 standard.
Therefore, these values can be increased owing to ambient conditions during operation.
- Capacities are net capacities and based on the following conditions. Refer to the Outdoor Unit Specifications for calculating the real capacity.
 - Cooling : Indoor Ambient Temp. 27°CDB / 19°CWB, Outdoor Ambient Temp. 35°CDB / 24°CWB
 - Heating : Indoor Ambient Temp. 20°CDB / 15°CWB, Outdoor Ambient Temp. 7°CDB / 6°CWB
 - Interconnected Pipe is standard length and difference of Elevation (Outdoor ~ Indoor Unit) is 0m.
- Refrigerant information (type, additional charging amount, etc.) must be applied by refrigerant type of the combined outdoor unit.
Adapt after checking the specifications of outdoor unit.
- Air flow rate could be different in accordance with 'High ceiling operation' mode setting value.

2. Specifications

Model Name		Unit	ARNU42GTAB4	ARNU48GTAB4
Power Supply	#1	V, Φ , Hz	220-230-240, 1, 50/60	220-230-240, 1, 50/60
	Running Current by Voltage	A	0.93 / 0.89 / 0.85	1.04 / 0.99 / 0.95
Cooling Capacity	Rated	kW	12.3	14.1
		Btu/h	42,000	48,100
Heating Capacity	Rated	kW	13.8	15.9
		Btu/h	47,000	54,200
Power Input	H/M/L	W	97 / 69 / 49	110 / 76 / 61
Running Current	H/M/L	A	0.85 / 0.62 / 0.46	0.95 / 0.69 / 0.56
Fan	Type	-	3D Turbo Fan	3D Turbo Fan
	Air Flow Rate(H/M/L)	m ³ /min	33 / 29 / 26	34 / 30 / 28
Fan Motor	Type	-	Brushless DC	Brushless DC
	Drive	-	Direct	Direct
	Output	W	135	135
No.		1	1	
Heat Exchanger	Rows x Columns x FPI	-	3 x 12 x 21	3 x 12 x 21
	No.	-	1	1
	Face Area	m ²	0.50	0.50
Dimensions	Net(W x H x D)	mm	840 x 288 x 840	840 x 288 x 840
	Shipping(W x H x D)	mm	922 x 360 x 917	922 x 360 x 917
Weight	Net	kg	27.0	27.0
	Shipping	kg	31.5	31.5
Exterior	Color	-	White	White
	RAL Code	-	RAL 9003	RAL 9003
Air Filter	Type	-	Long life	Long life
Temperature Control	-	-	Microprocessor, Thermostat for cooling and heating	
Sound Absorbing / Thermal Insulation Material	-	-	Foamed polystyrene	Foamed polystyrene
Protection Device	-	-	Fuse	Fuse
Refrigerant	Type	-	R410A / R32	R410A / R32
	Additional Charging amount	kg(each)	0.49 / 0.41	0.49 / 0.41
	Control Type	-	EEV	EEV
Drain Pipe	O.D / I.D	mm(inch)	32/25	32/25
Piping Connection	Liquid	mm(inch)	Φ 9.52 (3/8)	Φ 9.52 (3/8)
	Gas	mm(inch)	Φ 15.88 (5/8)	Φ 15.88 (5/8)
	Connection Type(Liquid)	-	Flare	Flare
	Connection Type(Gas)	-	Flare	Flare
Sound Pressure Level (H / M / L)		dB(A)	47.0 / 43.0 / 40.0	48.0 / 44.0 / 42.0
Sound Power Level (H / M / L)		dB(A)	56.0 / 53.0 / 49.0	58.0 / 54.0 / 53.0
Connecting Cable	Power Supply Cable(H07RN-F)	mm ² × cores	2.5 x 3	2.5 x 3
	Communication Cable(VCTF-SB)	mm ² × cores	1.0~1.5 x 2	1.0~1.5 x 2

Note

- Due to our policy of innovation some specifications may be changed without notification.
- Wiring cable size must comply with the applicable local and national code. And "Electric characteristics" chapter should be considered for electrical work and design. Especially the power cable and circuit breaker should be selected in accordance with that.
- Sound pressure level is measured on the rated condition in the anechoic rooms by ISO 3745 standard.
Sound power level is measured on the rated condition in the semi-anechoic rooms by ISO 9614 standard.
Therefore, these values can be increased owing to ambient conditions during operation.
- Capacities are net capacities and based on the following conditions. Refer to the Outdoor Unit Specifications for calculating the real capacity.
 - Cooling : Indoor Ambient Temp. 27°CDB / 19°CWB, Outdoor Ambient Temp. 35°CDB / 24°CWB
 - Heating : Indoor Ambient Temp. 20°CDB / 15°CWB, Outdoor Ambient Temp. 7°CDB / 6°CWB
 - Interconnected Pipe is standard length and difference of Elevation (Outdoor ~ Indoor Unit) is 0m.
- Refrigerant information (type, additional charging amount, etc.) must be applied by refrigerant type of the combined outdoor unit.
Adapt after checking the specifications of outdoor unit.
- Air flow rate could be different in accordance with 'High ceiling operation' mode setting value.

3. Dimensions

3.1 Dimensional Drawings

◆ ARNU24GTBB4, ARNU28GTBB4, ARNU30GTBB4

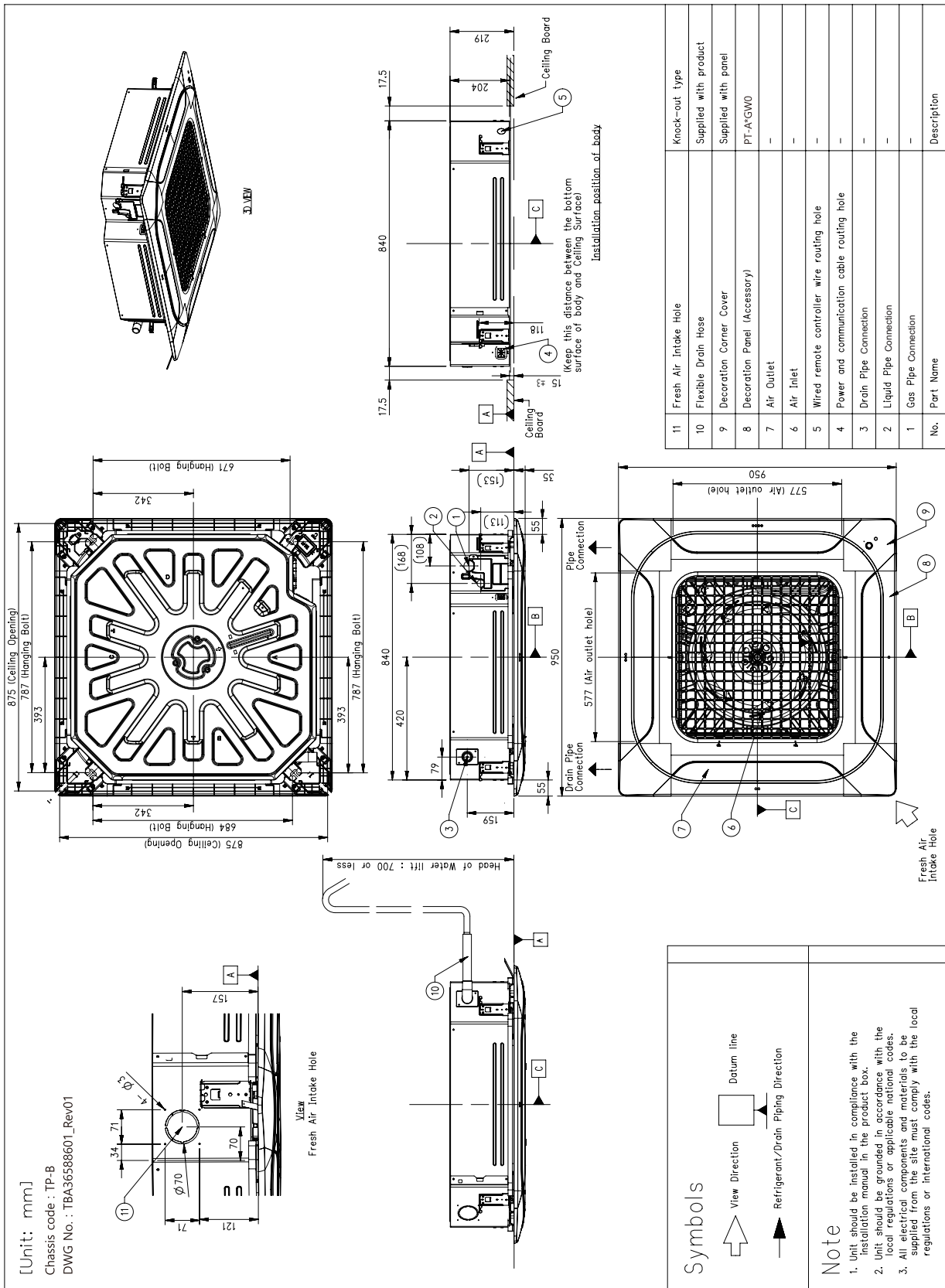

No.	Part Name	Description
11	Fresh Air Intake Hole	Knock-out Type
10	Flexible Drain Hose	Supplied with product
9	Decoration Corner Cover	Supplied with panel
8	Decoration Panel (Accessory)	PT-A'GW0
7	Air Outlet	-
6	Air Inlet	-
5	Wired remote controller wire routing hole	-
4	Power and communication cable routing hole	-
3	Drain Pipe Connection	-
2	Liquid Pipe Connection	-
1	Gas Pipe Connection	-

Symbols

- View Direction
- Datum line
- Refrigerant/Drain Piping Direction

Note

- Unit should be installed in compliance with the installation manual in the product box.
- Unit should be grounded in accordance with the local regulations or applicable national codes.
- All electrical components and materials to be supplied from the site must comply with the local regulations or international codes.

3. Dimensions

◆ ARNU36GTAB4, ARNU42GTAB4, ARNU48GTAB4

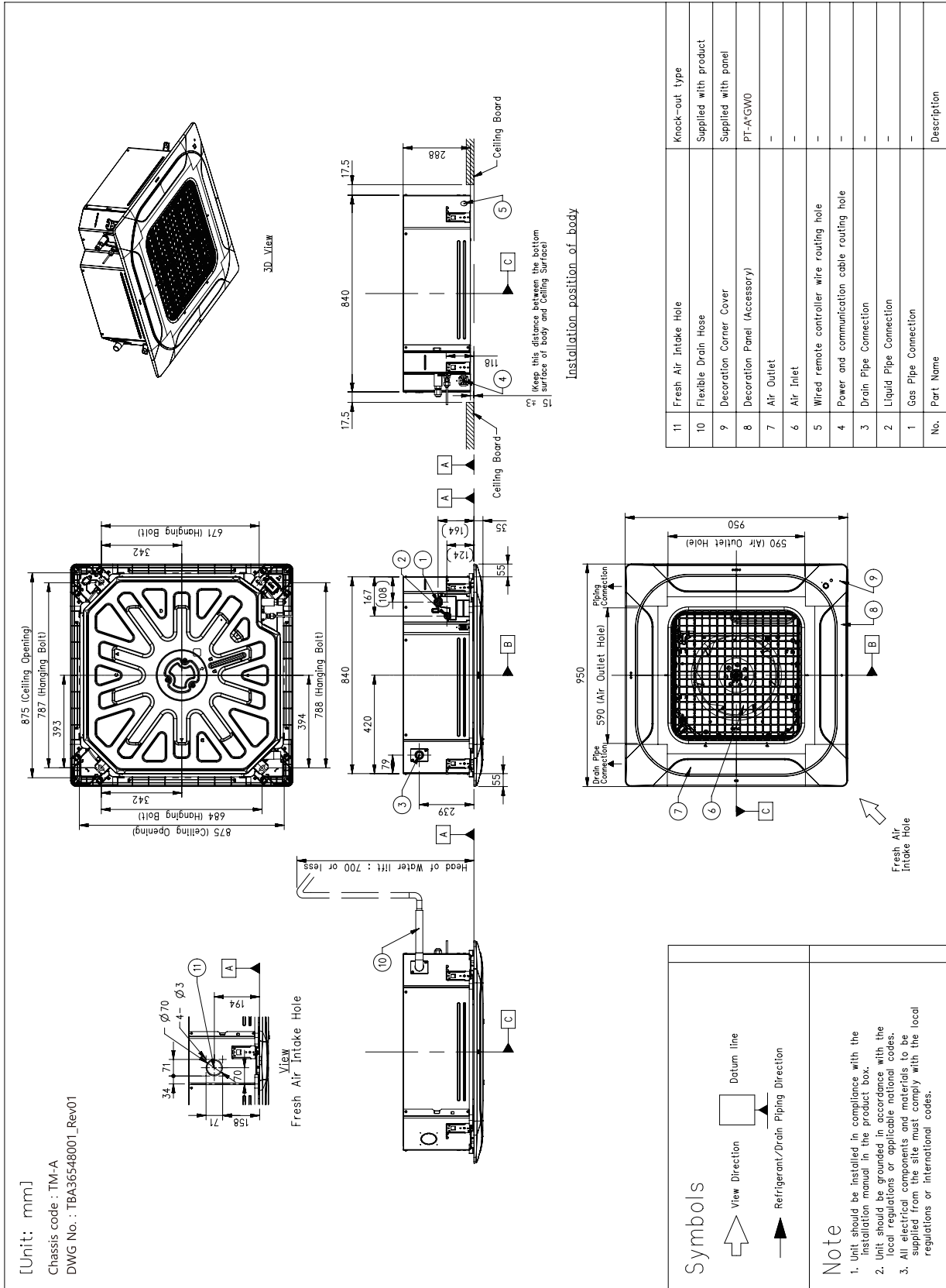

3. Dimensions

3.2 Installation Space

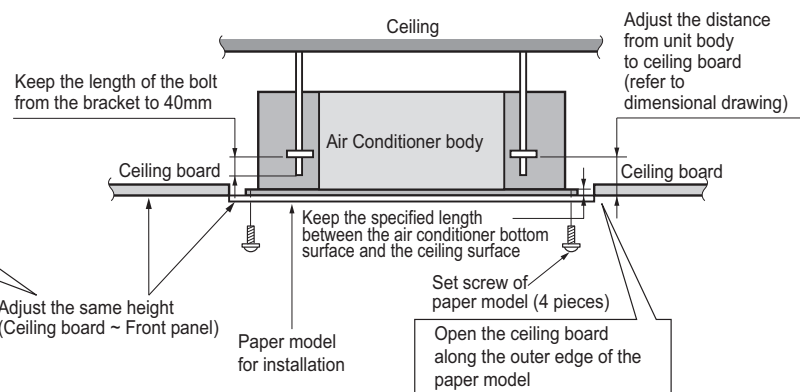
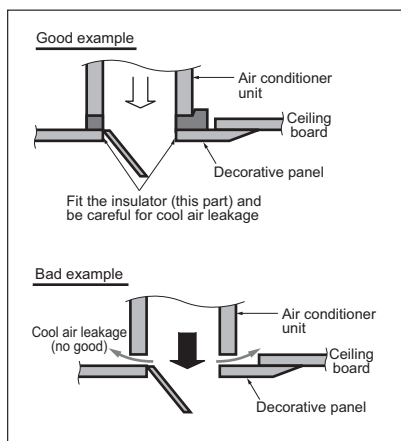
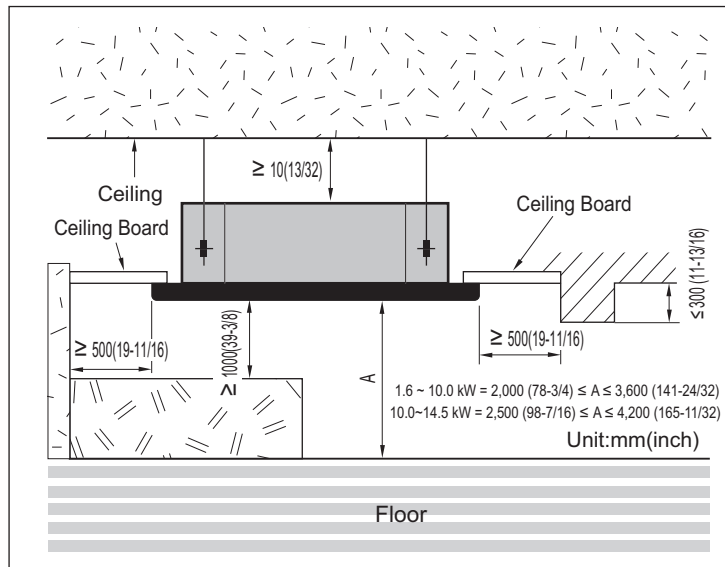

Note

- Places where products are installed should not be any obstacles to the air circulation or installation. Ensure the spaces from the wall, ceiling, or other obstacles.
- According to type of indoor unit, external appearance or installed structure could be different.
- According to product type, model line up, sales region..etc, applicability of each chassis could be different.
- Install certainly the decoration panel. Cool air leakage causes sweating or falling of water-drops.

4. Piping Diagrams

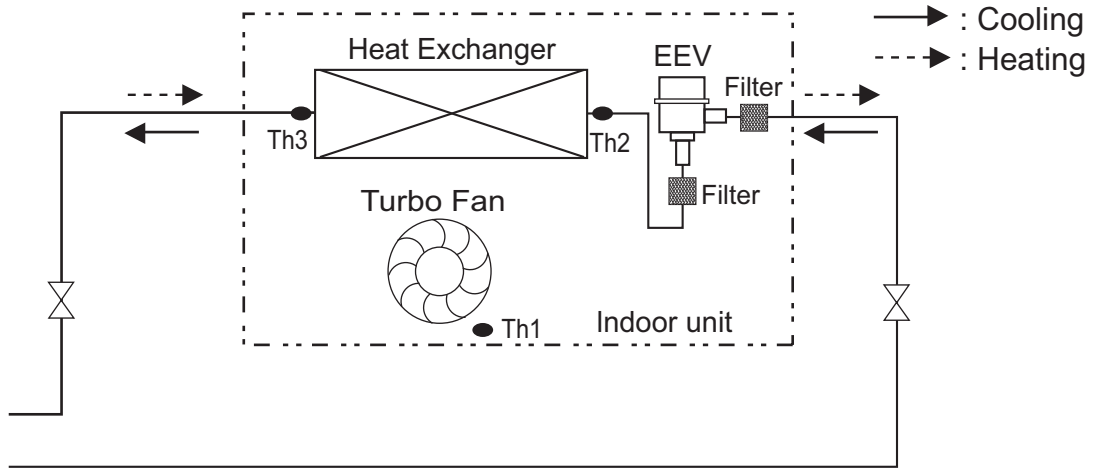

LOC.	Description
Th1	Room thermistor
Th2	Pipe in thermistor
Th3	Pipe out thermistor

6. Capacity Tables

■ Cooling Capacity

Nominal Capacity (kBtu/h) [Capacity Index (kW)]	Indoor air temp. (DB/WB, °C)													
	20		23		26		27		28		30		32	
	14		16		18		19		20		22		24	
	TC	SHC	TC	SHC	TC	SHC	TC	SHC	TC	SHC	TC	SHC	TC	SHC
24 [7.1]	4.8	4.2	5.7	4.6	6.6	5.0	7.1	5.1	7.6	5.3	8.2	5.3	8.3	4.9
28 [8.2]	5.5	4.6	6.6	5.4	7.7	5.8	8.2	5.9	8.7	6.1	9.4	6.2	9.6	5.6
30 [9.0]	6.1	5.1	7.2	5.8	8.4	6.3	9.0	6.5	9.6	6.7	10.4	6.7	10.5	6.2
36 [10.6]	7.2	6.3	8.5	6.9	9.9	7.5	10.6	7.6	11.3	7.9	11.4	7.4	11.7	6.8
42 [12.3]	8.3	7.3	9.9	8.0	11.5	8.7	12.3	8.9	13.1	9.1	13.3	8.6	13.5	7.9
48 [14.1]	9.5	8.3	11.3	9.2	13.2	10.0	14.1	10.2	15.0	10.5	15.2	9.9	15.5	9.1

Note

1. TC: Total Capacity(kW), SHC: Sensible Heat Capacity(kW)
2. Capacity tables show the average value of conditions which may occur.
3. Refer to Capacity tables and correction factor in the outdoor unit PDB for the actual performance data of each indoor unit and outdoor unit combination.

■ Heating Capacity

Nominal Capacity (kBtu/h) [Capacity Index (kW)]	Indoor air temp. (DB, °C)					
	16	18	20	21	22	24
	TC	TC	TC	TC	TC	TC
24 [7.1]	9.0	8.5	8.0	7.7	7.5	7.0
28 [8.2]	10.4	9.9	9.2	8.9	8.6	8.0
30 [9.0]	11.3	10.6	10.0	9.7	9.4	8.7
36 [10.6]	13.4	12.7	11.9	11.5	11.1	10.4
42 [12.3]	15.6	14.7	13.8	13.4	12.9	12.0
48 [14.1]	17.9	16.9	15.9	15.4	14.9	13.9

Note

1. TC: Total Capacity(kW)
2. Capacity tables show the average value of conditions which may occur.
3. Refer to Capacity tables and correction factor in the outdoor unit PDB for the actual performance data of each indoor unit and outdoor unit combination.

7. Air flow and temperature distributions (reference data)

Model : ARNU24GTBB4

Cooling

Discharge angle: Outer - 30°, Inner - 67°

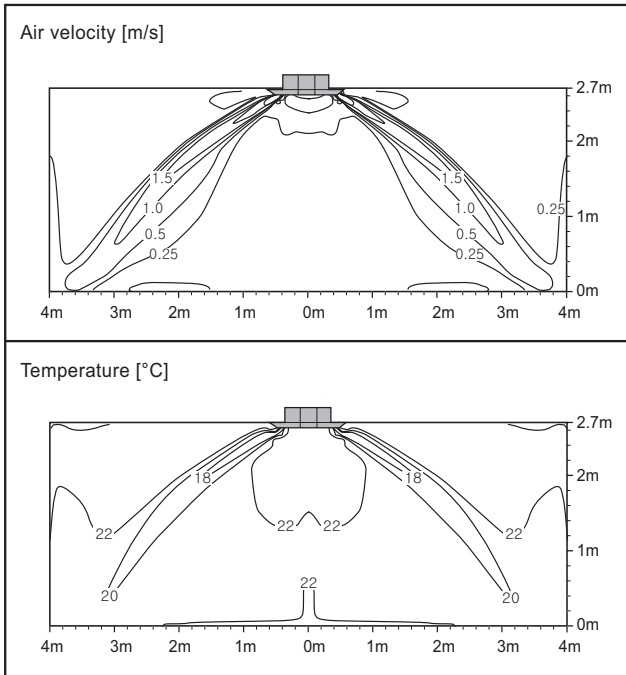

Heating

Discharge angle: Outer - 36°, Inner - 70°

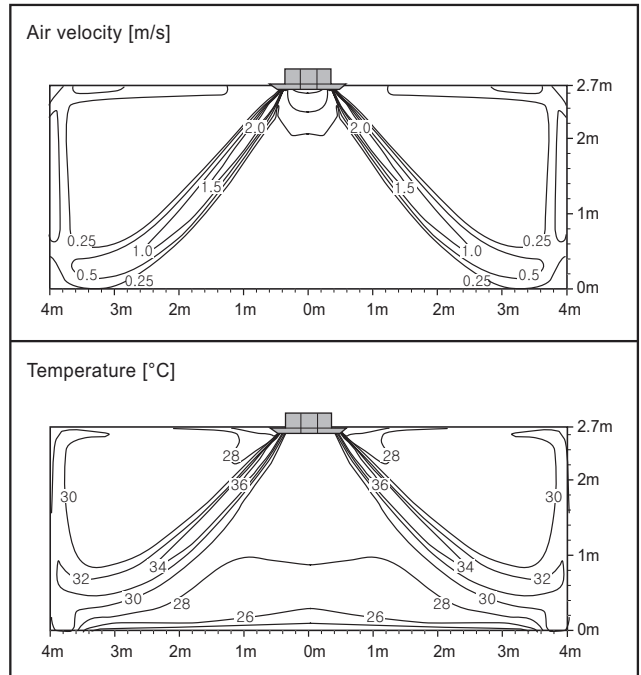

Model : ARNU28GTBB4

Cooling

Discharge angle: Outer - 30°, Inner - 67°

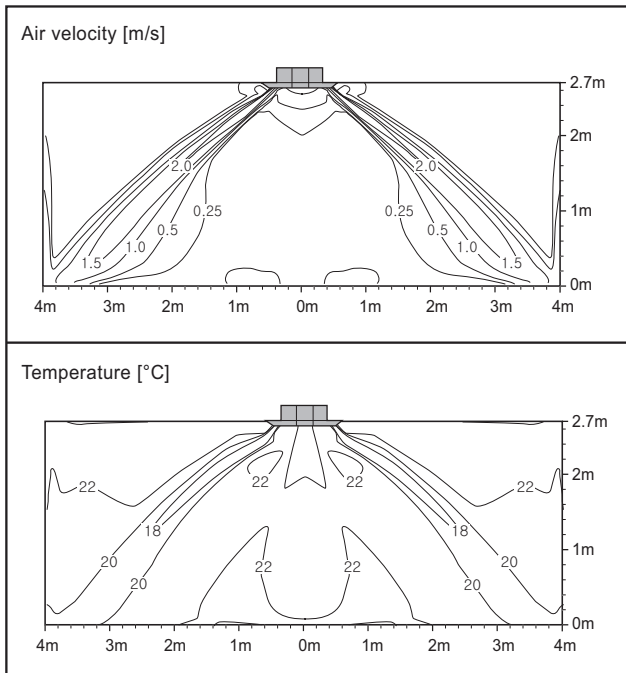

Heating

Discharge angle: Outer - 36°, Inner - 70°

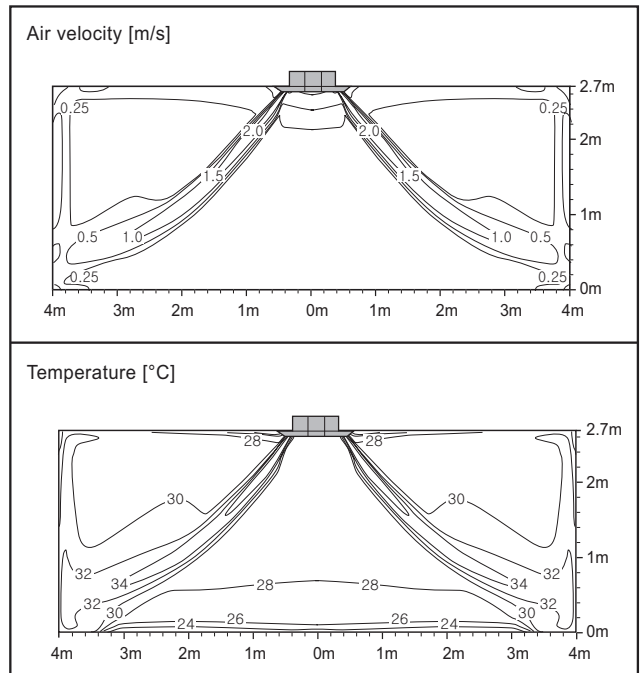

Note

- These figures are accordance with normal certain condition and environment. (Airflow step is 'High', Air discharge angle is fixed as indicated angle.)
- Indoor airflow distribution under actual installation or operating conditions depends on ambient temperature, ceiling height, product installation direction / location, indoor / Heating load, and other obstacles, etc.

7. Air flow and temperature distributions (reference data)

Model : ARNU30GTBB4

Cooling

Discharge angle: Outer - 30°, Inner - 67°

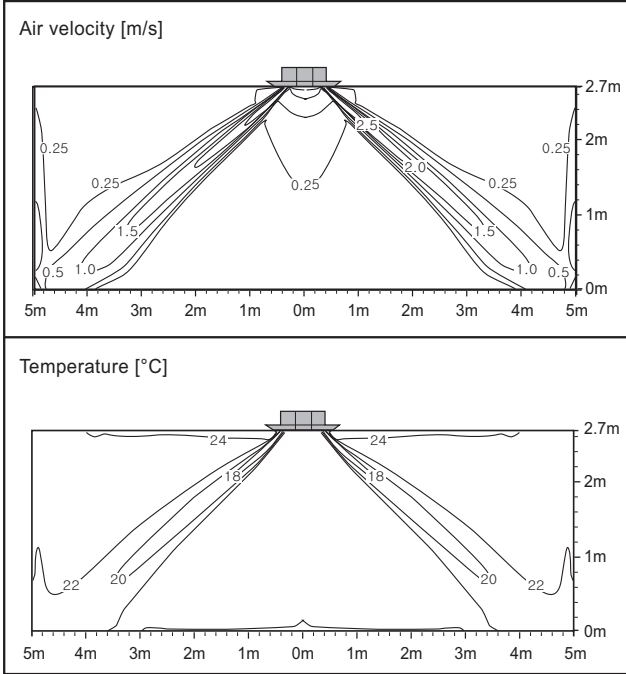

Heating

Discharge angle: Outer - 36°, Inner - 70°

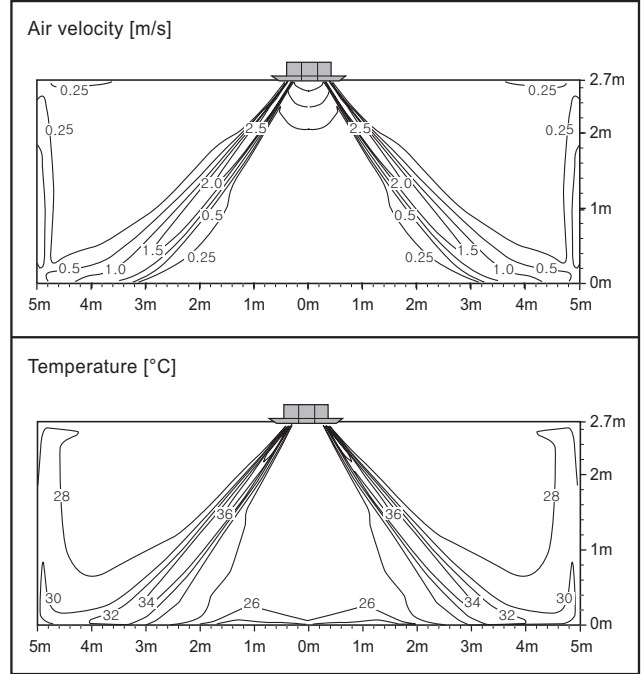

Model : ARNU36GTAB4

Cooling

Discharge angle: Outer - 30°, Inner - 67°

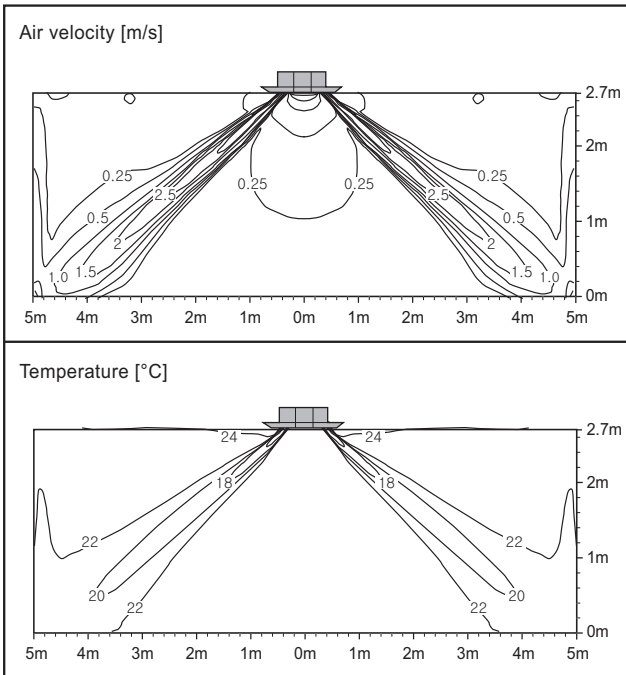

Heating

Discharge angle: Outer - 36°, Inner - 70°

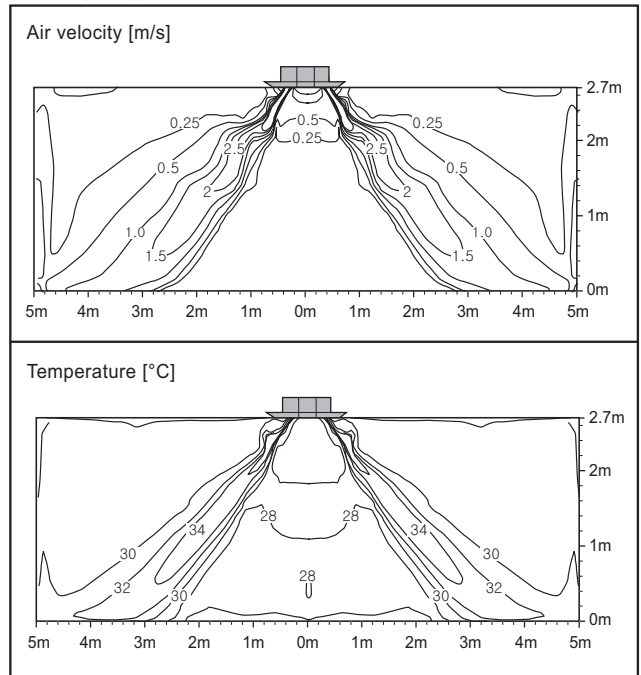

Note

- These figures are accordance with normal certain condition and environment. (Airflow step is 'High', Air discharge angle is fixed as indicated angle.)
- Indoor airflow distribution under actual installation or operating conditions depends on ambient temperature, ceiling height, product installation direction / location, indoor / Heating load, and other obstacles, etc.

7. Air flow and temperature distributions (reference data)

Model : ARNU42GTAB4

Cooling

Discharge angle: Outer - 30°, Inner - 67°

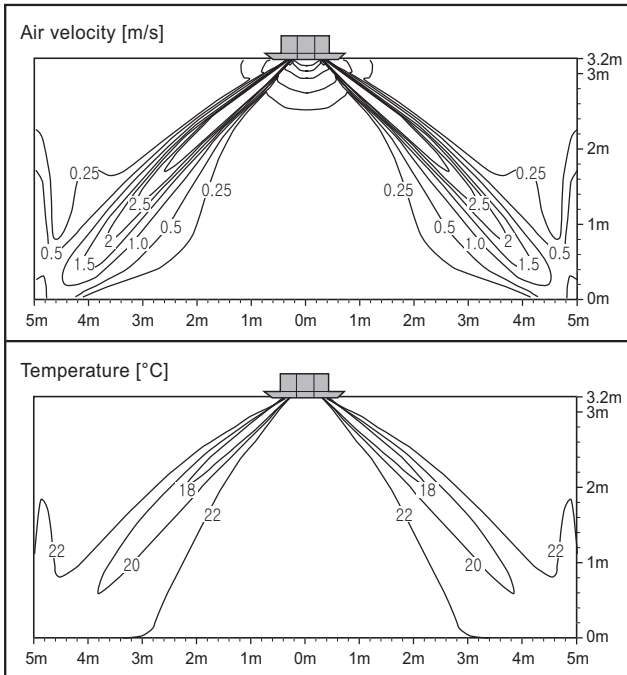

Heating

Discharge angle: Outer - 36°, Inner - 70°

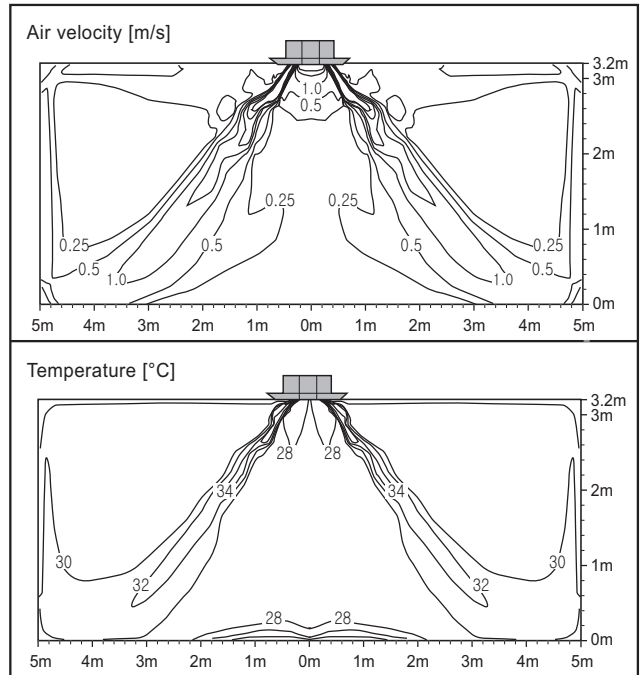

Model : ARNU48GTAB4

Cooling

Discharge angle: Outer - 30°, Inner - 67°

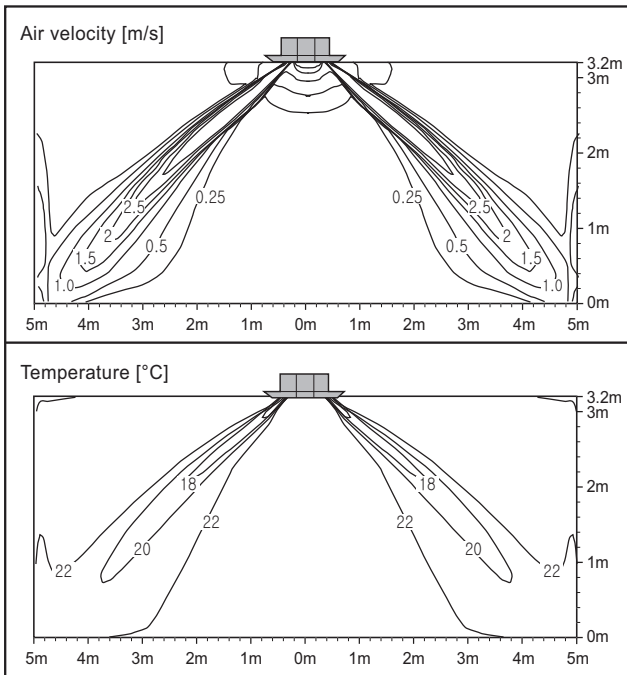

Heating

Discharge angle: Outer - 36°, Inner - 70°

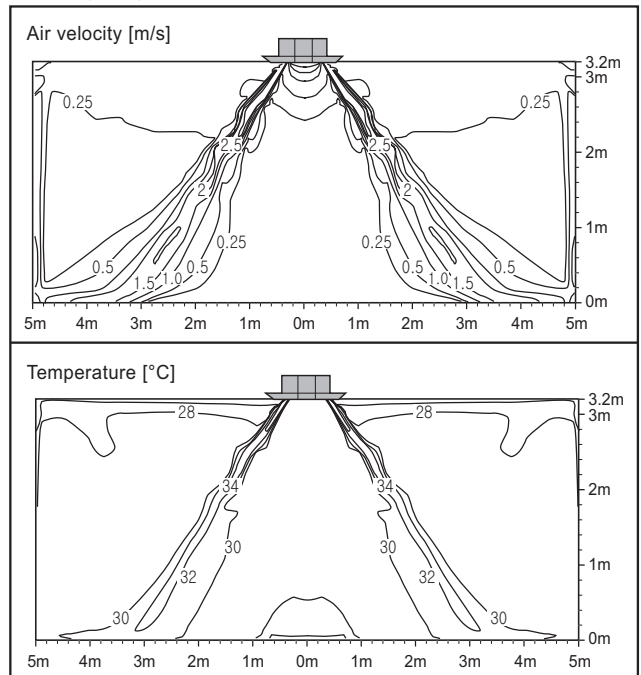

Note

- These figures are accordance with normal certain condition and environment. (Airflow step is 'High', Air discharge angle is fixed as indicated angle.)
- Indoor airflow distribution under actual installation or operating conditions depends on ambient temperature, ceiling height, product installation direction / location, indoor / Heating load, and other obstacles, etc.

8. Electric Characteristics

Units					Power Supply	IFM		PI	
Model	Type	Hz	Volts	Voltage Range	MCA	kW	FLA	Cooling	Heating
ARNU24GTBB4	TP-B	50	220-240	Max:264 Min:198	1.23	0.051	0.98	63	63
ARNU28GTBB4	TP-B				1.23	0.051	0.98	63	63
ARNU30GTBB4	TP-B				1.23	0.051	0.98	63	63
ARNU36GTAB4	TM-A				2.29	0.135	1.83	223	223
ARNU42GTAB4	TM-A				2.29	0.135	1.83	223	223
ARNU48GTAB4	TM-A				2.29	0.135	1.83	223	223
ARNU24GTBB4	TP-B	60	220	Max:242 Min:198	1.23	0.051	0.98	63	63
ARNU28GTBB4	TP-B				1.23	0.051	0.98	63	63
ARNU30GTBB4	TP-B				1.23	0.051	0.98	63	63
ARNU36GTAB4	TM-A				2.29	0.135	1.83	223	223
ARNU42GTAB4	TM-A				2.29	0.135	1.83	223	223
ARNU48GTAB4	TM-A				2.29	0.135	1.83	223	223

Symbols

MCA : Minimum Circuit Amperes (A)

MFA : Maximum Fuse Amperes (A)

kW : Fan Motor Rated Output (kW)

FLA : Full Load Amperes (A)

IFM : Indoor Fan Motor

PI : Maximum Power Input (W)

Note

- Voltage range
Units are suitable for use on electrical systems where voltage supplied to unit terminals is not below or above the listed range limits.
- Maximum allowable voltage unbalance between phases is 2%.
- MCA/MFA
MCA=1.25 x FLA
MFA = 1.1 x MCA, MFA ≤ 4 x FLA
(If MFA is smaller than minimum standard value, Use minimum standard value in region for selecting circuit breaker.)
- Select wire size based on the MCA
- Instead of fuse, use Circuit Breaker.

9. Sound levels

9.1 Sound pressure level

Overall

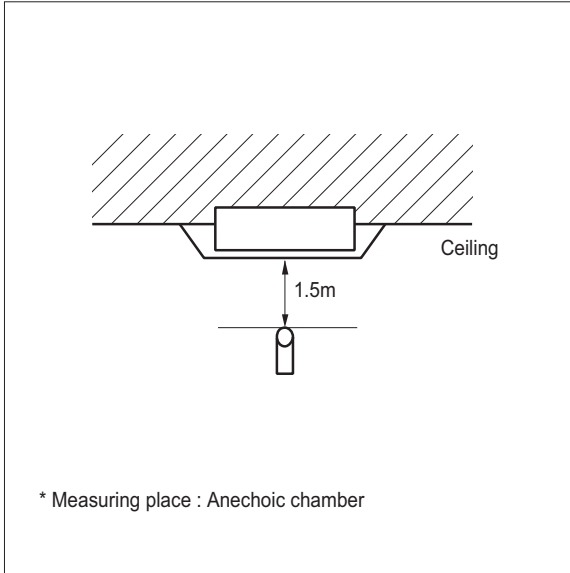

Note

- 1.Sound measured at some distance away from the center of the unit.
- 2.Data is valid at free field condition.
- 3.Reference acoustic pressure 0dB = 20μPa.
- 4.Data is valid at nominal operation condition.
Refer to the Model Specifications for nominal conditions(Power source and Ambient temperature, etc)
- 5.Sound levels can be increased in accordance with installation and operating conditions. (Static pressure mode, used air guide, Room target temperature setting, etc)
- 6.Sound level will vary depending on a range of factors such as the construction(acoustic absorption coefficient) of particular room in which the equipment is installed.
- 7.Sound pressure level is measured on the rated condition in the anechoic rooms by ISO 3745 standard.
Therefore, these values can be increased owing to ambient conditions during operation.

Model	Sound Pressure Levels [dB(A)]		
	H	M	L
ARNU24GTBB4	39	37	35
ARNU28GTBB4	40	38	35
ARNU30GTBB4	43	40	36
ARNU36GTAB4	43	40	37
ARNU42GTAB4	47	43	40
ARNU48GTAB4	48	44	42

ARNU24GTBB4

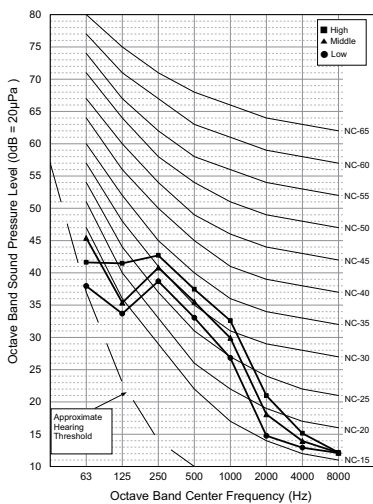

ARNU28GTBB4

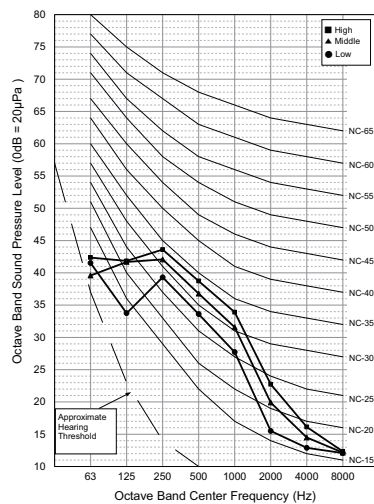

ARNU30GTBB4

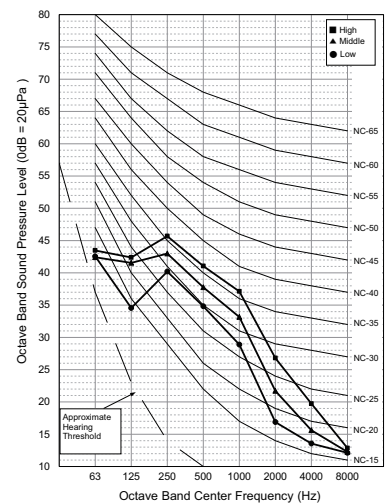

9. Sound levels

ARNU36GTAB4

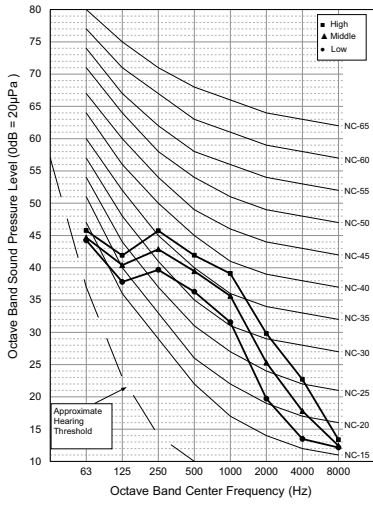

ARNU42GTAB4

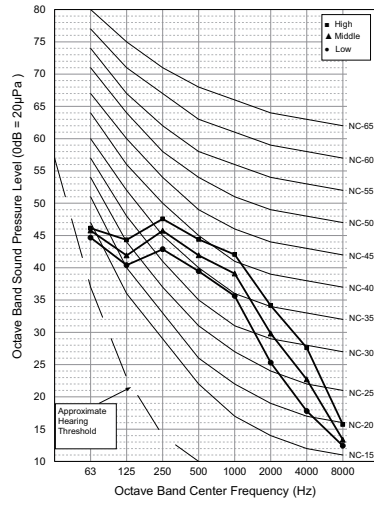

ARNU48GTAB4

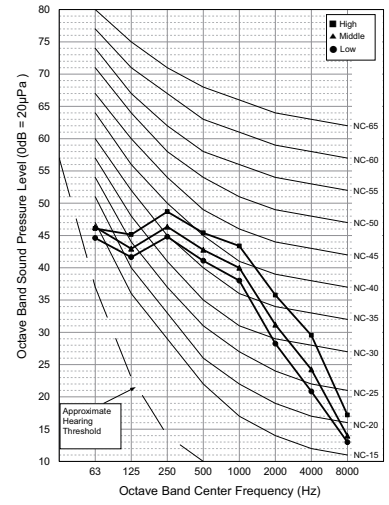

9. Sound levels

9.2 Sound power level

Note

- Data is valid at diffuse field condition
- Data is valid at nominal operating condition
- Sound level can be increased in static pressure mode or used air guide.
- Sound level will vary depending on a range of factors such as the construction (acoustic absorption coefficient) of particular room in which the equipment is installed.
- Reference acoustic intensity 0dB = $10E-6\mu W/m^2$
- Sound power level is measured on the rated condition in the semi-anechoic rooms by ISO 9614 standard. Therefore, these values can be increased owing to ambient conditions during operation.

Model	Sound Power Levels [dB(A)]		
	H	M	L
ARNU24GTBB4	46	44	42
ARNU28GTBB4	50	46	43
ARNU30GTBB4	53	50	45
ARNU36GTAB4	54	51	47
ARNU42GTAB4	56	53	49
ARNU48GTAB4	58	54	53

ARNU24GTBB4

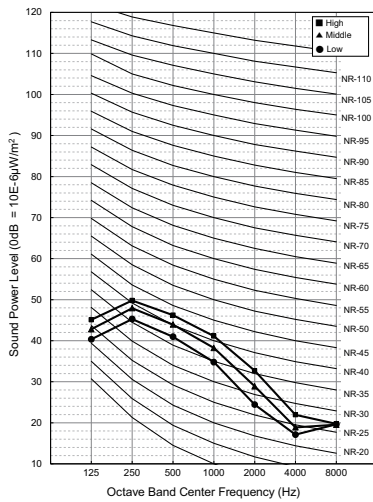

ARNU28GTBB4

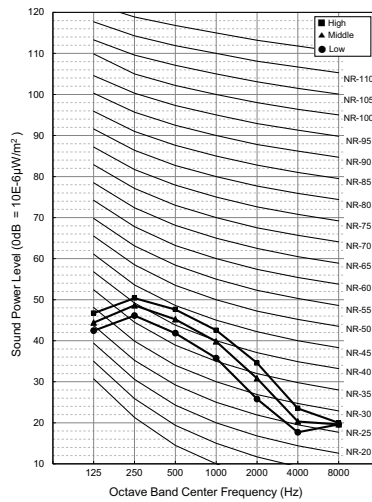

ARNU30GTBB4

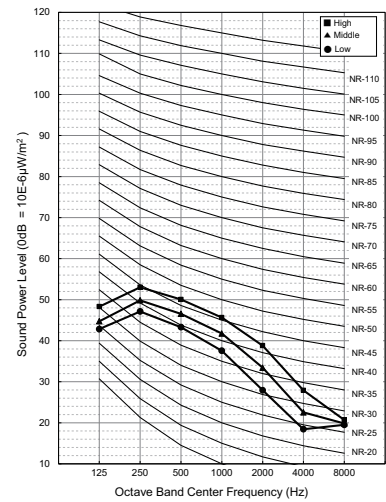

9. Sound levels

ARNU36GTAB4

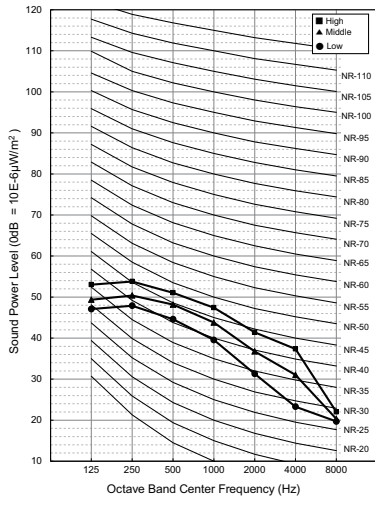

ARNU42GTAB4

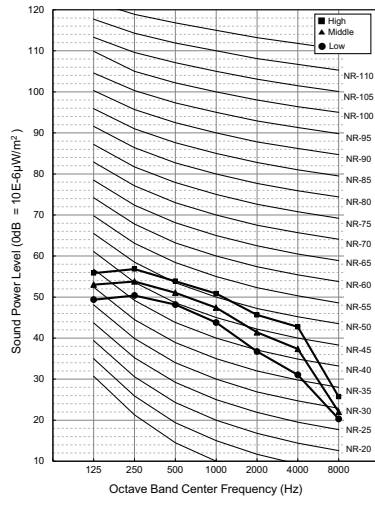

ARNU48GTAB4

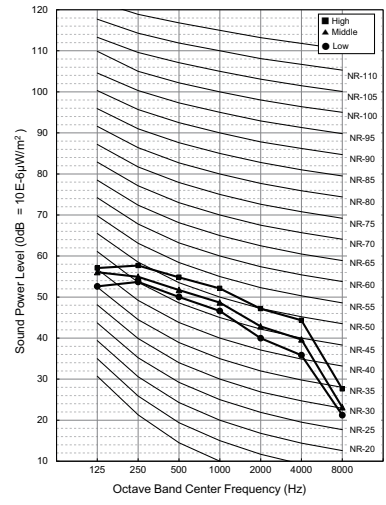

MULTI V™
Indoor Unit

Ceiling Mounted Cassette (Dual Vane 4way HighSensible)

- 1. List of functions**
- 2. Specifications**
- 3. Dimensions**
- 4. Piping Diagrams**
- 5. Wiring Diagrams**
- 6. Capacity Tables**
- 7. Air Velocity and Temperature Distribution**
- 8. Electric Characteristics**
- 9. Sound Levels**

1. List of functions

◆ List of functions

Category	Function	ARNU05GTAA4, ARNU07GTAA4, ARNU09GTAA4, ARNU12GTAA4, ARNU15GTAA4, ARNU18GTAA4, ARNU24GTAA4, ARNU28GTAA4, ARNU36GTAA4, ARNU42GTAA4, ARNU48GTAA4
Air Flow	Air Supply Outlet	4
	Airflow Direction Control (left & right)	X
	Airflow Direction Control (up & down)	Auto
	Auto Swing (left & right)	X
	Auto Swing (up & down)	O
	Airflow Steps (fan/cool/heat)	4 / 5 / 5
	Fan Speed Auto*	Advanced
	Power Cool/Heat	O / O
	Swirl Wind*	O
	Refresh Mode**	O
	Smart Mode**	O
	Indirect Wind*	O
	Direct Wind*	O
Dry Operation	O	
Air Purification	Air Purify	Accessory
	Ionizer	X
	UV-C	X
	Pre-Filter	O
Reliability	Hot Start	O
	Self Diagnosis	O
Convenience	Auto Mode	O
	Auto Dry Operation	O
	Auto Restart	O
	Child Lock*	O
	Forced Operation	O
	Group Control*	O
	Sleep Timer	O
	Turn On/Off Reservation	O
	Schedule*	O
	Two Thermistor Control*	O
External On/Off	O	
Installation	Drain Pump	O
	E.S.P. Control*	X
	High Ceiling Operation*	O
Special Functions	Wi-Fi	Accessory
	Auto Elevation Grille	X
	Human Detection Function**	Accessory
	Floor Detection Function**	Accessory

Note

- O : Applied, X : Not Applied, - : Unconfirmed or irrelevant
Embedded : A kit is provided by default for using this function when the product is manufactured.
Accessory : Ordered and purchased separately the accessory package referring to the model name provided and install at field. Accessory line-ups varies by region, so check your local catalogue or local sales material.
- Some functions can be limited by remote controller.
- In case of cassette type indoor units, Air Purification Kit and Auto Elevation Grille functions are not applicable at the same time.
- 'Auto Mode' varies depending on the outdoor unit type.
 - Auto Change Over(Heat Recovery Outdoor Unit)
 - Auto Mode Select(Heat Pump Outdoor Unit)
 - Auto Intensity Control(Cooling Only Outdoor Unit)
- * : These functions need to connect the wired remote controller.
- ** : This functions need to connect to the Standard III wired remote controller.

1. List of functions

■ Accessory Compatibility List

Category	Accessory Name	Model Name	Description	ARNU05GTAA4 ARNU07GTAA4 ARNU09GTAA4 ARNU12GTAA4 ARNU15GTAA4 ARNU18GTAA4 ARNU24GTAA4 ARNU28GTAA4 ARNU36GTAA4 ARNU42GTAA4 ARNU48GTAA4
Remote Controller	Wired - Premium	PREMTA000	-	O
		PREMTA000A	-	O
		PREMTA000B	-	O
	Wired - RS3 (Standard III)	PREMTB100/PREMTB101	White	O
		PREMTBB10/PREMTBB11	Black	O
	Wired - RS2 (Standard II)	PREMTB001	White	X
		PREMTBB01	Black	X
	Wired - Simple	PQRCVCL0QW	White	X
		PQRCVCL0Q	Black	X
	Wired - Simple for Hotel	PQRCHCA0QW	White	X
PQRCHCA0Q		Black	X	
Wireless	PQWRCQ0FDB	For Cooling only	O	
	PQWRHQ0FDB	For Heat pump	O	
	PWLSSB21C	For Cooling only	O	
	PWLSSB21H	For Heat pump	O	
Dry Contact	Simple	PDRYCB000	1 input port, AC 220 - 240V	O
		PDRYCB100	1 input port, AC 24V	O
	Communication	PDRYCB400	2 input port	O
		PDRYCB300	8 input port, For 3rd party Thermostat	O
		PDRYCB320	8 input port, For 3rd Party Thermostat (Analog Input)	O
PDRYCB500	For 3rd Party Controller (Modbus RTU)	O		
Integration Device	Remote Temperature sensor	PQRSTA0	-	O
	Group Control wire	PZCWRCG3	Cable Assembly for group control (Y-type cable : 0.25m, cable : 9.6m)	O
ETC	Extension wire	PZCWRC1	Extension wire for IDU-wired remote controller (9.6m)	O
	2-Remo Control Wire	PZCWRC2	-	O
	Wi-Fi Modem	PWFMDD200	-	O
	Wi-Fi Extension cable	PWYREW000	USB Extension cable : 10 m	O
	Independent Power Module	PRIP0	-	O
	Multi-tenant Power Module	PINPMB001	-	O
	Refrigerant Leakage Detector	PRLDNVS0	For R410A only	O
	Human Detection Sensor	PTVSMA0	For Cassette 4-way	X
		PTVSAA0	For Cassette Dual Vane 4-way	O
	Floor Detection Sensor	PTFSMA0	-	O
	Auto Elevation Grille	PTEGM0	For TP/TN/TM	X
	Ionizer	PAS-NATDR2	-	X
	Air Purification Kit	PTAHTP0	For Cassette 1-way	X
		PTAHMP0	For Cassette 4-way	O
		PTAHYP0	For Cassette Round	X
	EEV Kit	PRGK024A0	For Multi V Indoor Unit	X
	Auxiliary Heater Relay Kit	PRARS1	For Wall Mounted and Art Cool Indoor Units	X
		PRARH1	For Cassette and Duct Indoor Units	O
	Ventilation Kit	PTVK430	For TR/TQ/TP/TN/TM	X
		PTVK410 + PTVK420	For TP/TN/TM	X
Cassette Cover	PTDCQ	For TR/TQ	X	
	PTDCM	For TP/TN/TM	X	
	PTDCA	For TM-A/TP-B	O	

Note

1. O: Possible, X: Impossible, - : Not applicable, Embedded : Included with product.
2. If there is a difference in development time between the product and the remote controller, some functions cannot be operated.
3. If using Wi-Fi controller, Some advanced functions controlled by remote controller cannot be operated.
4. If you need more detail, please refer to the **BECON** PDB or the manual of product. (<http://partner.lge.com/global> : Home> Doc.Library> Product > Control(BECON))

1. List of functions

■ Panel(Accessory)

Model Name			PT-AAGW0	PT-AFGW0
Description	-		Standard Panel	Premium Panel
Exterior Color	-		White	White
RAL Code	-		RAL 9003	RAL 9003
Dual Vane	-		O	O
Dimensions (W x H x D)	Net	mm	950 x 35 x 950	950 x 35 x 950
	Shipping	mm	1,006 x 102 x 1,006	1,006 x 117 x 1,006
Weight	Net	kg	7.1	7.5
	Shipping	kg	9.3	9.4
Function	PM1.0 Sensor	-	X	O
Accessory	Air Purification Kit	-	X	PTAHMP0
	Floor Detection Sensor*	-	PTFSMA0	PTFSMA0
	Human Detection Sensor*	-	PTVSAA0	PTVSAA0

Note

1. Accessory : Ordered and purchased separately the accessory package referring to the model name provided and install at field.
2. * : This functions need to connect to the RS3 wired remote controller(Standard III).

2. Specifications

Model Name		Unit	ARNU05GTAA4	ARNU07GTAA4
Power Supply	#1	V, Φ , Hz	220-230-240, 1, 50/60	220-230-240, 1, 50/60
	Running Current by Voltage	A	0.23 / 0.22 / 0.21	0.25 / 0.24 / 0.23
Cooling Capacity	Rated	kW	1.6	2.2
		Btu/h	5,500	7,500
Heating Capacity	Rated	kW	1.8	2.5
		Btu/h	6,100	8,500
Power Input	H/M/L	W	20.4 / 14.8 / 10.9	23.3 / 16.1 / 10.9
Running Current	H/M/L	A	0.21 / 0.18 / 0.14	0.23 / 0.18 / 0.14
Fan	Type	-	3D Turbo Fan	3D Turbo Fan
	Air Flow Rate(H/M/L)	m ³ /min	18 / 15 / 13	19 / 16 / 13
Fan Motor	Type	-	Brushless DC	Brushless DC
	Drive	-	Direct	Direct
	Output	W	166	166
No.		1	1	
Heat Exchanger	Rows x Columns x FPI	-	3 x 18 x 22	3 x 18 x 22
	No.	-	1	1
	Face Area	m ²	0.54	0.54
Dimensions	Net(W x H x D)	mm	840 x 288 x 840	840 x 288 x 840
	Shipping(W x H x D)	mm	922 x 360 x 917	922 x 360 x 917
Weight	Net	kg	27.0	27.0
	Shipping	kg	32.5	32.5
Exterior	Color	-	White	White
	RAL Code	-	RAL 9003	RAL 9003
Air Filter	Type	-	Long life	Long life
Temperature Control	-	-	Microprocessor, Thermostat for cooling and heating	Microprocessor, Thermostat for cooling and heating
Sound Absorbing / Thermal Insulation Material	-	-	Foamed polystyrene	Foamed polystyrene
Protection Device	-	-	Fuse	Fuse
Refrigerant	Type	-	R410A / R32	R410A / R32
	Additional Charging amount	kg(each)	0.68 / 0.56	0.68 / 0.56
	Control Type	-	EEV	EEV
Drain Pipe	O.D / I.D	mm(inch)	32/25	32/25
Piping Connection	Liquid	mm(inch)	Φ 9.52 (3/8)	Φ 9.52 (3/8)
	Gas	mm(inch)	Φ 15.88 (5/8)	Φ 15.88 (5/8)
	Connection Type(Liquid)	-	Flare	Flare
	Connection Type(Gas)	-	Flare	Flare
Sound Pressure Level (H / M / L)	-	dB(A)	32.0 / 29.0 / 26.0	32.0 / 30.0 / 26.0
Sound Power Level (H / M / L)	-	dB(A)	40.0 / 37.0 / 36.0	41.0 / 38.0 / 36.0
Connecting Cable	Power Supply Cable(H07RN-F)	mm ² × cores	2.5 x 3	2.5 x 3
	Communication Cable(VCTF-SB)	mm ² × cores	1.0~1.5 x 2	1.0~1.5 x 2

Note

1. Due to our policy of innovation some specifications may be changed without notification.
2. Wiring cable size must comply with the applicable local and national code. And "Electric characteristics" chapter should be considered for electrical work and design. Especially the power cable and circuit breaker should be selected in accordance with that.
3. Sound pressure level is measured on the rated condition in the anechoic rooms by ISO 3745 standard.
Sound power level is measured on the rated condition in the semi-anechoic rooms by ISO 9614 standard.
Therefore, these values can be increased owing to ambient conditions during operation.
4. Capacities are net capacities and based on the following conditions. Refer to the Outdoor Unit Specifications for calculating the real capacity.
 - Cooling : Indoor Ambient Temp. 27°CDB / 19°CWB, Outdoor Ambient Temp. 35°CDB / 24°CWB
 - Heating : Indoor Ambient Temp. 20°CDB / 15°CWB, Outdoor Ambient Temp. 7°CDB / 6°CWB
 - Interconnected Pipe is standard length and difference of Elevation (Outdoor ~ Indoor Unit) is 0m.
5. Refrigerant information (type, additional charging amount, etc.) must be applied by refrigerant type of the combined outdoor unit.
Adapt after checking the specifications of outdoor unit.
6. Air flow rate could be different in accordance with 'High ceiling operation' mode setting value.

2. Specifications

Model Name		Unit	ARNU09GTAA4	ARNU12GTAA4
Power Supply	#1	V, Φ , Hz	220-230-240, 1, 50/60	220-230-240, 1, 50/60
	Running Current by Voltage	A	0.27 / 0.26 / 0.25	0.27 / 0.26 / 0.25
Cooling Capacity	Rated	kW	2.8	3.6
		Btu/h	9,600	12,300
Heating Capacity	Rated	kW	3.2	4.0
		Btu/h	10,900	13,600
Power Input	H/M/L	W	24.7 / 17.6 / 10.9	26.1 / 19.2 / 13.3
Running Current	H/M/L	A	0.25 / 0.19 / 0.14	0.25 / 0.20 / 0.16
Fan	Type	-	3D Turbo Fan	3D Turbo Fan
	Air Flow Rate(H/M/L)	m ³ /min	19 / 16 / 13	20 / 17 / 15
Fan Motor	Type	-	Brushless DC	Brushless DC
	Drive	-	Direct	Direct
	Output	W	166	166
No.		1	1	
Heat Exchanger	Rows x Columns x FPI	-	3 x 18 x 22	3 x 18 x 22
	No.	-	1	1
	Face Area	m ²	0.54	0.54
Dimensions	Net(W x H x D)	mm	840 x 288 x 840	840 x 288 x 840
	Shipping(W x H x D)	mm	922 x 360 x 917	922 x 360 x 917
Weight	Net	kg	27.0	27.0
	Shipping	kg	32.5	32.5
Exterior	Color	-	White	White
	RAL Code	-	RAL 9003	RAL 9003
Air Filter	Type	-	Long life	Long life
Temperature Control	-	-	Microprocessor, Thermostat for cooling and heating	Microprocessor, Thermostat for cooling and heating
Sound Absorbing / Thermal Insulation Material	-	-	Foamed polystyrene	Foamed polystyrene
Protection Device	-	-	Fuse	Fuse
Refrigerant	Type	-	R410A / R32	R410A / R32
	Additional Charging amount	kg(each)	0.68 / 0.56	0.68 / 0.56
	Control Type	-	EEV	EEV
Drain Pipe	O.D / I.D	mm(inch)	32/25	32/25
Piping Connection	Liquid	mm(inch)	Φ 9.52 (3/8)	Φ 9.52 (3/8)
	Gas	mm(inch)	Φ 15.88 (5/8)	Φ 15.88 (5/8)
	Connection Type(Liquid)	-	Flare	Flare
	Connection Type(Gas)	-	Flare	Flare
Sound Pressure Level (H / M / L)	-	dB(A)	33.0 / 30.0 / 26.0	34.0 / 31.0 / 27.0
Sound Power Level (H / M / L)	-	dB(A)	42.0 / 39.0 / 36.0	42.0 / 40.0 / 37.0
Connecting Cable	Power Supply Cable(H07RN-F)	mm ² × cores	2.5 x 3	2.5 x 3
	Communication Cable(VCTF-SB)	mm ² × cores	1.0~1.5 x 2	1.0~1.5 x 2

Note

1. Due to our policy of innovation some specifications may be changed without notification.
2. Wiring cable size must comply with the applicable local and national code. And "Electric characteristics" chapter should be considered for electrical work and design. Especially the power cable and circuit breaker should be selected in accordance with that.
3. Sound pressure level is measured on the rated condition in the anechoic rooms by ISO 3745 standard.
Sound power level is measured on the rated condition in the semi-anechoic rooms by ISO 9614 standard.
Therefore, these values can be increased owing to ambient conditions during operation.
4. Capacities are net capacities and based on the following conditions. Refer to the Outdoor Unit Specifications for calculating the real capacity.
 - Cooling : Indoor Ambient Temp. 27°CDB / 19°CWB, Outdoor Ambient Temp. 35°CDB / 24°CWB
 - Heating : Indoor Ambient Temp. 20°CDB / 15°CWB, Outdoor Ambient Temp. 7°CDB / 6°CWB
 - Interconnected Pipe is standard length and difference of Elevation (Outdoor ~ Indoor Unit) is 0m.
5. Refrigerant information (type, additional charging amount, etc.) must be applied by refrigerant type of the combined outdoor unit.
Adapt after checking the specifications of outdoor unit.
6. Air flow rate could be different in accordance with 'High ceiling operation' mode setting value.

2. Specifications

Model Name		Unit	ARNU15GTAA4	ARNU18GTAA4
Power Supply	#1	V, Φ , Hz	220-230-240, 1, 50/60	220-230-240, 1, 50/60
	Running Current by Voltage	A	0.29 / 0.28 / 0.27	0.31 / 0.29 / 0.28
Cooling Capacity	Rated	kW	4.5	5.6
		Btu/h	15,400	19,100
Heating Capacity	Rated	kW	5.0	6.3
		Btu/h	17,100	21,500
Power Input	H/M/L	W	28.5 / 20.4 / 14.8	31.1 / 23.3 / 16.1
Running Current	H/M/L	A	0.27 / 0.21 / 0.18	0.28 / 0.23 / 0.18
Fan	Type	-	3D Turbo Fan	3D Turbo Fan
	Air Flow Rate(H/M/L)	m ³ /min	20 / 17 / 15	21 / 19 / 16
Fan Motor	Type	-	Brushless DC	Brushless DC
	Drive	-	Direct	Direct
	Output	W	166	166
No.		1	1	
Heat Exchanger	Rows x Columns x FPI	-	3 x 18 x 22	3 x 18 x 22
	No.	-	1	1
	Face Area	m ²	0.54	0.54
Dimensions	Net(W x H x D)	mm	840 x 288 x 840	840 x 288 x 840
	Shipping(W x H x D)	mm	922 x 360 x 917	922 x 360 x 917
Weight	Net	kg	27.0	27.0
	Shipping	kg	32.5	32.5
Exterior	Color	-	White	White
	RAL Code	-	RAL 9003	RAL 9003
Air Filter	Type	-	Long life	Long life
Temperature Control	-	-	Microprocessor, Thermostat for cooling and heating	Microprocessor, Thermostat for cooling and heating
Sound Absorbing / Thermal Insulation Material	-	-	Foamed polystyrene	Foamed polystyrene
Protection Device	-	-	Fuse	Fuse
Refrigerant	Type	-	R410A / R32	R410A / R32
	Additional Charging amount	kg(each)	0.68 / 0.56	0.68 / 0.56
	Control Type	-	EEV	EEV
Drain Pipe	O.D / I.D	mm(inch)	32/25	32/25
Piping Connection	Liquid	mm(inch)	Φ 9.52 (3/8)	Φ 9.52 (3/8)
	Gas	mm(inch)	Φ 15.88 (5/8)	Φ 15.88 (5/8)
	Connection Type(Liquid)	-	Flare	Flare
	Connection Type(Gas)	-	Flare	Flare
Sound Pressure Level (H / M / L)	-	dB(A)	34.0 / 32.0 / 29.0	35.0 / 32.0 / 30.0
Sound Power Level (H / M / L)	-	dB(A)	43.0 / 40.0 / 38.0	44.0 / 41.0 / 38.0
Connecting Cable	Power Supply Cable(H07RN-F)	mm ² × cores	2.5 x 3	2.5 x 3
	Communication Cable(VCTF-SB)	mm ² × cores	1.0~1.5 x 2	1.0~1.5 x 2

Note

1. Due to our policy of innovation some specifications may be changed without notification.
2. Wiring cable size must comply with the applicable local and national code. And "Electric characteristics" chapter should be considered for electrical work and design. Especially the power cable and circuit breaker should be selected in accordance with that.
3. Sound pressure level is measured on the rated condition in the anechoic rooms by ISO 3745 standard.
Sound power level is measured on the rated condition in the semi-anechoic rooms by ISO 9614 standard.
Therefore, these values can be increased owing to ambient conditions during operation.
4. Capacities are net capacities and based on the following conditions. Refer to the Outdoor Unit Specifications for calculating the real capacity.
 - Cooling : Indoor Ambient Temp. 27°CDB / 19°CWB, Outdoor Ambient Temp. 35°CDB / 24°CWB
 - Heating : Indoor Ambient Temp. 20°CDB / 15°CWB, Outdoor Ambient Temp. 7°CDB / 6°CWB
 - Interconnected Pipe is standard length and difference of Elevation (Outdoor ~ Indoor Unit) is 0m.
5. Refrigerant information (type, additional charging amount, etc.) must be applied by refrigerant type of the combined outdoor unit.
Adapt after checking the specifications of outdoor unit.
6. Air flow rate could be different in accordance with 'High ceiling operation' mode setting value.

2. Specifications

Model Name		Unit	ARNU24GTAA4	ARNU28GTAA4
Power Supply	#1	V, Φ , Hz	220-230-240, 1, 50/60	220-230-240, 1, 50/60
	Running Current by Voltage	A	0.37 / 0.36 / 0.34	0.41 / 0.40 / 0.38
Cooling Capacity	Rated	kW	7.1	8.2
		Btu/h	24,200	28,000
Heating Capacity	Rated	kW	8.0	9.2
		Btu/h	27,300	31,500
Power Input	H/M/L	W	40.0 / 31.1 / 24.7	45.5 / 35.2 / 26.1
Running Current	H/M/L	A	0.38 / 0.30 / 0.25	0.46 / 0.34 / 0.25
Fan	Type	-	3D Turbo Fan	3D Turbo Fan
	Air Flow Rate(H/M/L)	m ³ /min	23 / 21 / 19	24 / 22 / 20
Fan Motor	Type	-	Brushless DC	Brushless DC
	Drive	-	Direct	Direct
	Output	W	166	166
No.		1	1	
Heat Exchanger	Rows x Columns x FPI	-	3 x 18 x 22	3 x 18 x 22
	No.	-	1	1
	Face Area	m ²	0.54	0.54
Dimensions	Net(W x H x D)	mm	840 x 288 x 840	840 x 288 x 840
	Shipping(W x H x D)	mm	922 x 360 x 917	922 x 360 x 917
Weight	Net	kg	27.0	27.0
	Shipping	kg	32.5	32.5
Exterior	Color	-	White	White
	RAL Code	-	RAL 9003	RAL 9003
Air Filter	Type	-	Long life	Long life
Temperature Control	-	-	Microprocessor, Thermostat for cooling and heating	Microprocessor, Thermostat for cooling and heating
Sound Absorbing / Thermal Insulation Material	-	-	Foamed polystyrene	Foamed polystyrene
Protection Device	-	-	Fuse	Fuse
Refrigerant	Type	-	R410A / R32	R410A / R32
	Additional Charging amount	kg(each)	0.68 / 0.56	0.68 / 0.56
	Control Type	-	EEV	EEV
Drain Pipe	O.D / I.D	mm(inch)	32/25	32/25
Piping Connection	Liquid	mm(inch)	Φ 9.52 (3/8)	Φ 9.52 (3/8)
	Gas	mm(inch)	Φ 15.88 (5/8)	Φ 15.88 (5/8)
	Connection Type(Liquid)	-	Flare	Flare
	Connection Type(Gas)	-	Flare	Flare
Sound Pressure Level (H / M / L)	-	dB(A)	39.0 / 36.0 / 33.0	40.0 / 37.0 / 34.0
Sound Power Level (H / M / L)	-	dB(A)	47.0 / 45.0 / 42.0	48.0 / 46.0 / 42.0
Connecting Cable	Power Supply Cable(H07RN-F)	mm ² × cores	2.5 x 3	2.5 x 3
	Communication Cable(VCTF-SB)	mm ² × cores	1.0~1.5 x 2	1.0~1.5 x 2

Note

1. Due to our policy of innovation some specifications may be changed without notification.
2. Wiring cable size must comply with the applicable local and national code. And "Electric characteristics" chapter should be considered for electrical work and design. Especially the power cable and circuit breaker should be selected in accordance with that.
3. Sound pressure level is measured on the rated condition in the anechoic rooms by ISO 3745 standard.
Sound power level is measured on the rated condition in the semi-anechoic rooms by ISO 9614 standard.
Therefore, these values can be increased owing to ambient conditions during operation.
4. Capacities are net capacities and based on the following conditions. Refer to the Outdoor Unit Specifications for calculating the real capacity.
 - Cooling : Indoor Ambient Temp. 27°CDB / 19°CWB, Outdoor Ambient Temp. 35°CDB / 24°CWB
 - Heating : Indoor Ambient Temp. 20°CDB / 15°CWB, Outdoor Ambient Temp. 7°CDB / 6°CWB
 - Interconnected Pipe is standard length and difference of Elevation (Outdoor ~ Indoor Unit) is 0m.
5. Refrigerant information (type, additional charging amount, etc.) must be applied by refrigerant type of the combined outdoor unit.
Adapt after checking the specifications of outdoor unit.
6. Air flow rate could be different in accordance with 'High ceiling operation' mode setting value.

2. Specifications

Model Name		Unit	ARNU36GTAA4	ARNU42GTAA4
Power Supply	#1	V, Φ , Hz	220-230-240, 1, 50/60	220-230-240, 1, 50/60
	Running Current by Voltage	A	0.65 / 0.63 / 0.60	0.87 / 0.84 / 0.80
Cooling Capacity	Rated	kW	10.6	12.3
		Btu/h	36,200	42,000
Heating Capacity	Rated	kW	11.9	13.8
		Btu/h	40,600	47,000
Power Input	H/M/L	W	64.7 / 43.4 / 31.1	85.8 / 64.7 / 43.4
Running Current	H/M/L	A	0.60 / 0.40 / 0.28	0.80 / 0.60 / 0.40
Fan	Type	-	3D Turbo Fan	3D Turbo Fan
	Air Flow Rate(H/M/L)	m ³ /min	28 / 24 / 21	31 / 28 / 24
Fan Motor	Type	-	Brushless DC	Brushless DC
	Drive	-	Direct	Direct
	Output	W	166	166
No.		1	1	
Heat Exchanger	Rows x Columns x FPI	-	3 x 18 x 22	3 x 18 x 22
	No.	-	1	1
	Face Area	m ²	0.54	0.54
Dimensions	Net(W x H x D)	mm	840 x 288 x 840	840 x 288 x 840
	Shipping(W x H x D)	mm	922 x 360 x 917	922 x 360 x 917
Weight	Net	kg	27.0	27.0
	Shipping	kg	32.5	32.5
Exterior	Color	-	White	White
	RAL Code	-	RAL 9003	RAL 9003
Air Filter	Type	-	Long life	Long life
Temperature Control	-	-	Microprocessor, Thermostat for cooling and heating	Microprocessor, Thermostat for cooling and heating
Sound Absorbing / Thermal Insulation Material	-	-	Foamed polystyrene	Foamed polystyrene
Protection Device	-	-	Fuse	Fuse
Refrigerant	Type	-	R410A / R32	R410A / R32
	Additional Charging amount	kg(each)	0.68 / 0.56	0.68 / 0.56
	Control Type	-	EEV	EEV
Drain Pipe	O.D / I.D	mm(inch)	32/25	32/25
Piping Connection	Liquid	mm(inch)	Φ 9.52 (3/8)	Φ 9.52 (3/8)
	Gas	mm(inch)	Φ 15.88 (5/8)	Φ 15.88 (5/8)
	Connection Type(Liquid)	-	Flare	Flare
	Connection Type(Gas)	-	Flare	Flare
Sound Pressure Level (H / M / L)	-	dB(A)	42.0 / 39.0 / 35.0	46.0 / 42.0 / 39.0
Sound Power Level (H / M / L)	-	dB(A)	51.0 / 48.0 / 44.0	54.0 / 51.0 / 48.0
Connecting Cable	Power Supply Cable(H07RN-F)	mm ² × cores	2.5 x 3	2.5 x 3
	Communication Cable(VCTF-SB)	mm ² × cores	1.0~1.5 x 2	1.0~1.5 x 2

Note

1. Due to our policy of innovation some specifications may be changed without notification.
2. Wiring cable size must comply with the applicable local and national code. And "Electric characteristics" chapter should be considered for electrical work and design. Especially the power cable and circuit breaker should be selected in accordance with that.
3. Sound pressure level is measured on the rated condition in the anechoic rooms by ISO 3745 standard.
Sound power level is measured on the rated condition in the semi-anechoic rooms by ISO 9614 standard.
Therefore, these values can be increased owing to ambient conditions during operation.
4. Capacities are net capacities and based on the following conditions. Refer to the Outdoor Unit Specifications for calculating the real capacity.
 - Cooling : Indoor Ambient Temp. 27°CDB / 19°CWB, Outdoor Ambient Temp. 35°CDB / 24°CWB
 - Heating : Indoor Ambient Temp. 20°CDB / 15°CWB, Outdoor Ambient Temp. 7°CDB / 6°CWB
 - Interconnected Pipe is standard length and difference of Elevation (Outdoor ~ Indoor Unit) is 0m.
5. Refrigerant information (type, additional charging amount, etc.) must be applied by refrigerant type of the combined outdoor unit.
Adapt after checking the specifications of outdoor unit.
6. Air flow rate could be different in accordance with 'High ceiling operation' mode setting value.

2. Specifications

Model Name		Unit	ARNU48GTAA4
Power Supply	#1	V, Φ , Hz	220-230-240, 1, 50/60
	Running Current by Voltage	A	0.96 / 0.92 / 0.88
Cooling Capacity	Rated	kW	14.1
		Btu/h	48,100
Heating Capacity	Rated	kW	15.9
		Btu/h	54,200
Power Input	H/M/L	W	100 / 66.8 / 53.1
Running Current	H/M/L	A	0.88 / 0.63 / 0.51
Fan	Type	-	3D Turbo Fan
	Air Flow Rate(H/M/L)	m ³ /min	33 / 28 / 26
Fan Motor	Type	-	Brushless DC
	Drive	-	Direct
	Output	W No.	166 1
Heat Exchanger	Rows x Columns x FPI	-	3 x 18 x 22
	No.	-	1
	Face Area	m ²	0.54
Dimensions	Net(W x H x D)	mm	840 x 288 x 840
	Shipping(W x H x D)	mm	922 x 360 x 917
Weight	Net	kg	27.0
	Shipping	kg	32.5
Exterior	Color	-	White
	RAL Code	-	RAL 9003
Air Filter	Type	-	Long life
Temperature Control	-	-	Microprocessor, Thermostat for cooling and heating
Sound Absorbing / Thermal Insulation Material	-	-	Foamed polystyrene
Protection Divice	-	-	Fuse
Refrigerant	Type	-	R410A / R32
	Additional Charging amount	kg(each)	0.68 / 0.56
	Control Type	-	EEV
Drain Pipe	O.D / I.D	mm(inch)	32/25
Piping Connection	Liquid	mm(inch)	Φ 9.52 (3/8)
	Gas	mm(inch)	Φ 15.88 (5/8)
	Connection Type(Liquid)	-	Flare
	Connection Type(Gas)	-	Flare
Sound Pressure Level (H / M / L)		dB(A)	47.0 / 43.0 / 41.0
Sound Power Level (H / M / L)		dB(A)	56.0 / 52.0 / 50.0
Connecting Cable	Power Supply Cable(H07RN-F)	mm ² × cores	2.5 x 3
	Communication Cable(VCTF-SB)	mm ² × cores	1.0~1.5 x 2

Note

- Due to our policy of innovation some specifications may be changed without notification.
- Wiring cable size must comply with the applicable local and national code. And "Electric characteristics" chapter should be considered for electrical work and design. Especially the power cable and circuit breaker should be selected in accordance with that.
- Sound pressure level is measured on the rated condition in the anechoic rooms by ISO 3745 standard.
Sound power level is measured on the rated condition in the semi-anechoic rooms by ISO 9614 standard.
Therefore, these values can be increased owing to ambient conditions during operation.
- Capacities are net capacities and based on the following conditions. Refer to the Outdoor Unit Specifications for calculating the real capacity.
 - Cooling : Indoor Ambient Temp. 27°CDB / 19°CWB, Outdoor Ambient Temp. 35°CDB / 24°CWB
 - Heating : Indoor Ambient Temp. 20°CDB / 15°CWB, Outdoor Ambient Temp. 7°CDB / 6°CWB
 - Interconnected Pipe is standard length and difference of Elevation (Outdoor ~ Indoor Unit) is 0m.
- Refrigerant information (type, additional charging amount, etc.) must be applied by refrigerant type of the combined outdoor unit.
Adapt after checking the specifications of outdoor unit.
- Air flow rate could be different in accordance with 'High ceiling operation' mode setting value.

3. Dimensions

3.1 Dimensional Drawings

ARNU05GTAA4, ARNU07GTAA4, ARNU09GTAA4, ARNU12GTAA4, ARNU15GTAA4, ARNU18GTAA4, ARNU24GTAA4, ARNU28GTAA4, ARNU36GTAA4, ARNU42GTAA4, ARNU48GTAA4

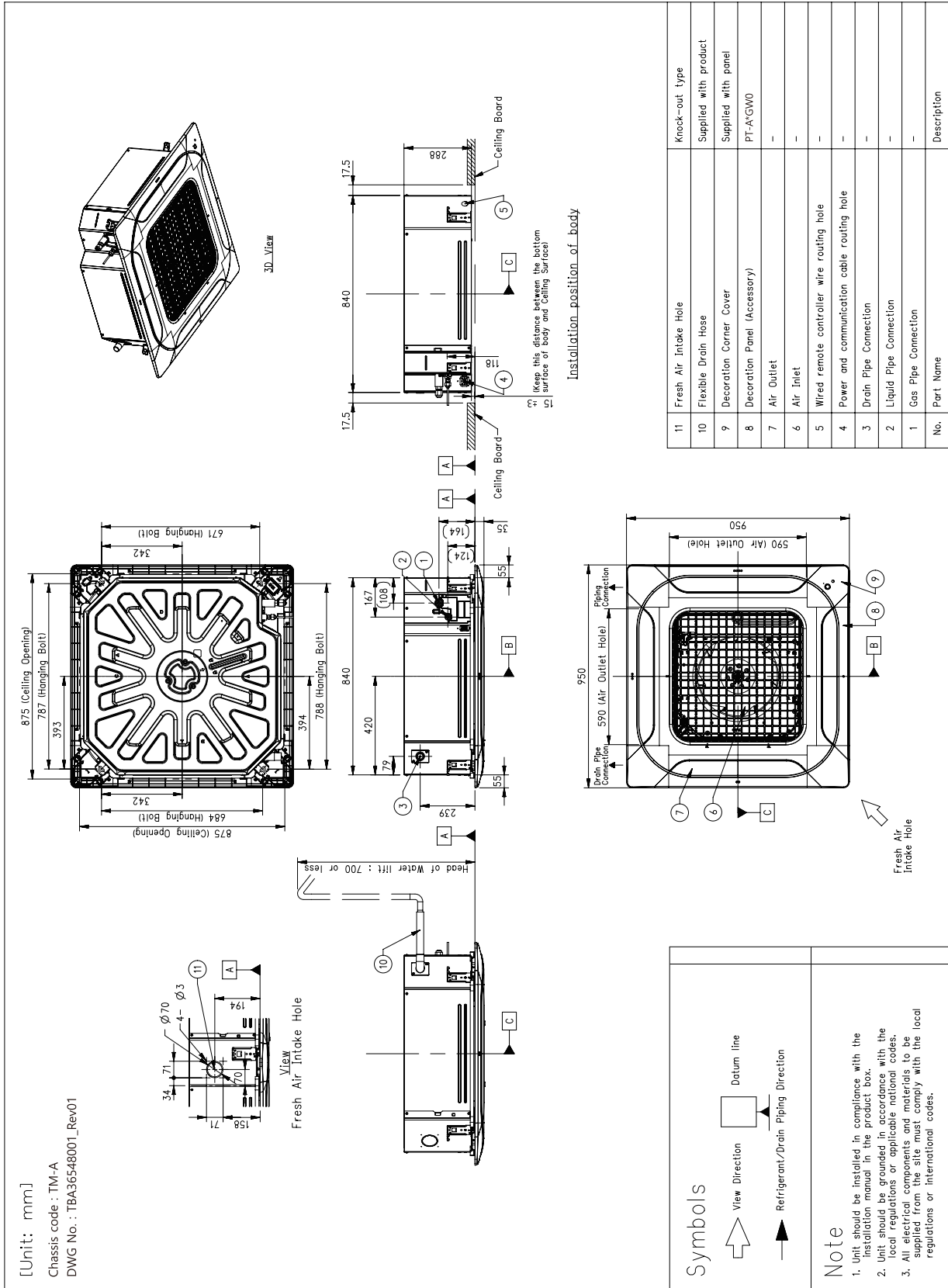

3. Dimensions

3.2 Installation Space

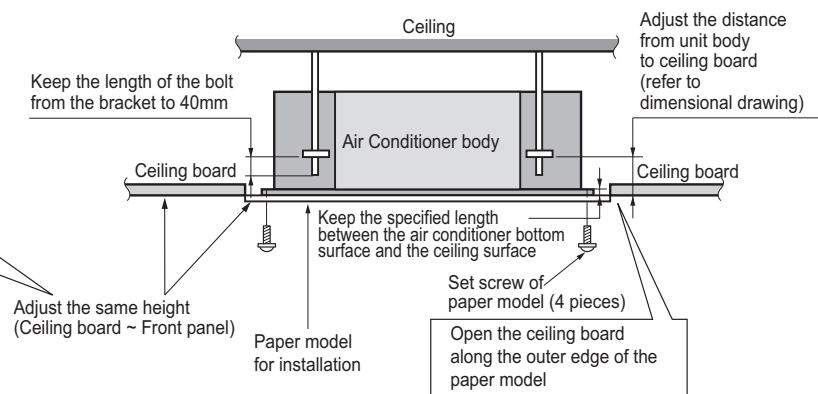
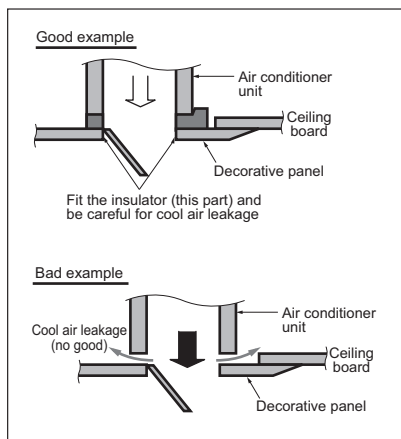
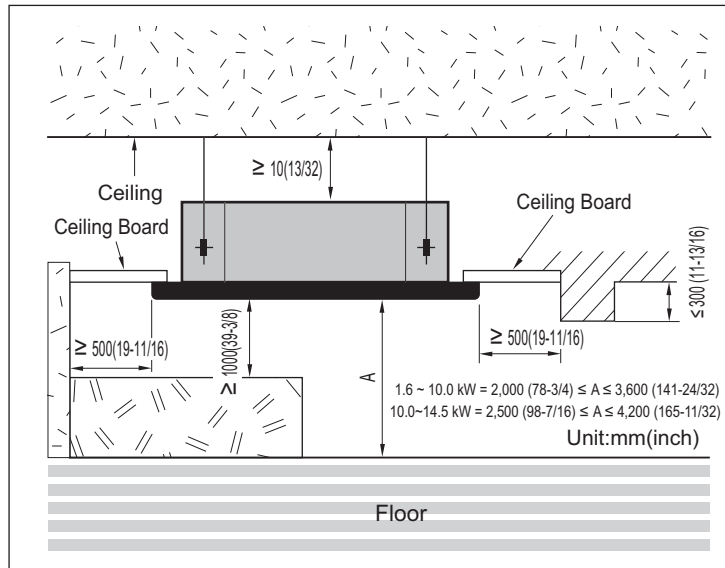

Note

- Places where products are installed should not be any obstacles to the air circulation or installation. Ensure the spaces from the wall, ceiling, or other obstacles.
- According to type of indoor unit, external appearance or installed structure could be different.
- According to product type, model line up, sales region..etc, applicability of each chassis could be different.
- Install certainly the decoration panel. Cool air leakage causes sweating or falling of water-drops.

4. Piping Diagrams

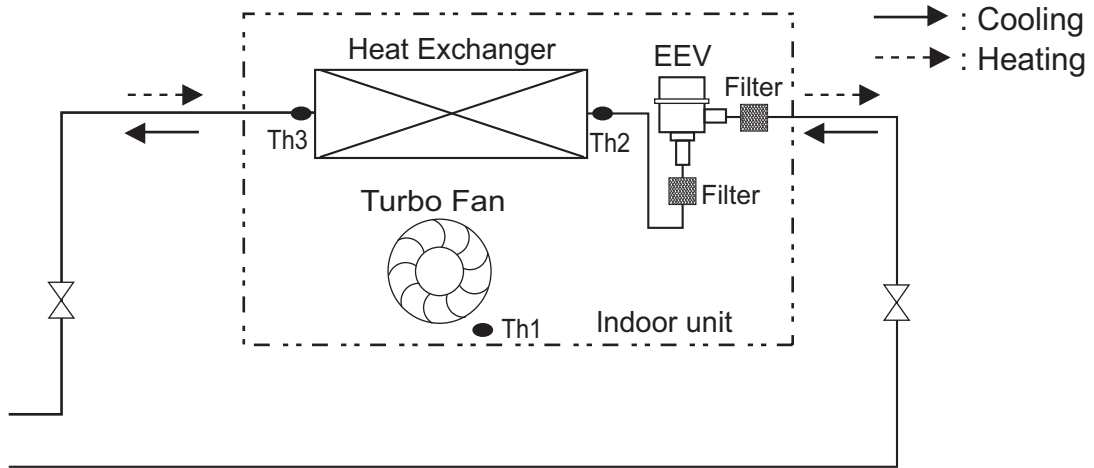

LOC.	Description
Th1	Room thermistor
Th2	Pipe in thermistor
Th3	Pipe out thermistor

5. Wiring Diagrams

- Model : ARNU05GTAA4, ARNU07GTAA4, ARNU09GTAA4, ARNU12GTAA4, ARNU15GTAA4, ARNU18GTAA4, ARNU24GTAA4, ARNU28GTAA4, ARNU36GTAA4, ARNU42GTAA4, ARNU48GTAA4

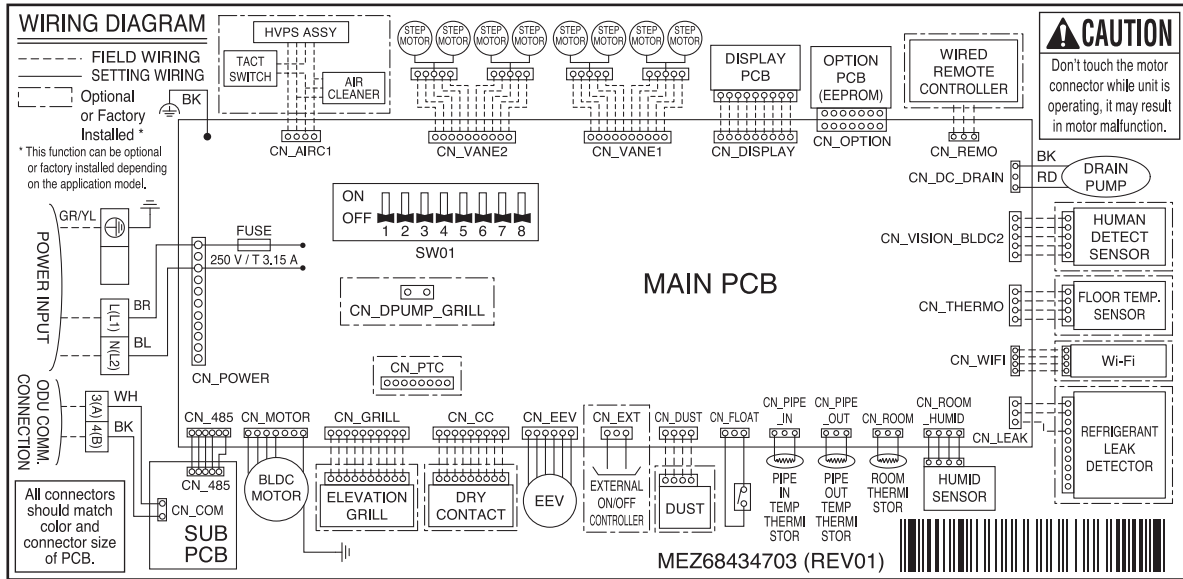

6. Capacity Tables

■ Cooling Capacity

Nominal Capacity (kBtu/h) [Capacity Index (kW)]	Indoor air temp. (DB/WB, °C)													
	20		23		26		27		28		30		32	
	14		16		18		19		20		22		24	
	TC	SHC	TC	SHC	TC	SHC	TC	SHC	TC	SHC	TC	SHC	TC	SHC
5 [1.6]	1.1	1.1	1.3	1.3	1.5	1.5	1.6	1.5	1.7	1.6	1.7	1.5	1.8	1.4
7 [2.2]	1.5	1.5	1.8	1.8	2.0	2	2.2	2.1	2.4	2.2	2.4	2	2.4	1.9
9 [2.8]	1.9	1.9	2.2	2.2	2.6	2.6	2.8	2.7	3.0	2.8	3.0	2.6	3.1	2.4
12 [3.6]	2.4	2.4	2.9	2.9	3.3	3.3	3.6	3.4	3.9	3.6	3.9	3.4	4.0	3.1
15 [4.5]	3.0	3.0	3.6	3.6	4.2	4.2	4.5	4.3	4.8	4.4	4.9	4.2	4.9	3.9
18 [5.6]	3.8	3.8	4.5	4.5	5.2	5.2	5.6	5.3	6.0	5.5	6.1	5.2	6.2	4.8
24 [7.1]	4.8	4.8	5.7	5.5	6.6	6.2	7.1	6.3	7.6	6.4	7.7	6.2	7.8	6.1
28 [8.2]	5.5	5.2	6.6	6.0	7.6	6.7	8.2	6.9	8.8	7.0	8.9	6.8	9.0	6.6
36 [10.6]	7.2	6.4	8.5	7.4	9.9	8.3	10.6	8.4	11.3	8.5	11.5	8.3	11.6	8.0
42 [12.3]	8.3	7.3	9.9	8.4	11.4	9.4	12.3	9.5	13.2	9.7	13.3	9.4	13.5	9.1
48 [14.1]	9.5	8.1	11.3	9.3	13.1	10.4	14.1	10.5	15.1	10.7	15.3	10.4	15.5	10.1

Note

1. TC: Total Capacity(kW), SHC: Sensible Heat Capacity(kW)
2. Capacity tables show the average value of conditions which may occur.
3. Refer to Capacity tables and correction factor in the outdoor unit PDB for the actual performance data of each indoor unit and outdoor unit combination.

■ Heating Capacity

Nominal Capacity (kBtu/h) [Capacity Index (kW)]	Indoor air temp. (DB, °C)					
	16	18	20	21	22	24
	TC	TC	TC	TC	TC	TC
5 [1.6]	2.0	1.9	1.8	1.7	1.7	1.6
7 [2.2]	2.8	2.7	2.5	2.4	2.3	2.2
9 [2.8]	3.6	3.4	3.2	3.1	3.0	2.8
12 [3.6]	4.5	4.3	4.0	3.9	3.7	3.5
15 [4.5]	5.6	5.3	5.0	4.8	4.7	4.4
18 [5.6]	7.1	6.7	6.3	6.1	5.9	5.5
24 [7.1]	9.0	8.5	8.0	7.7	7.5	7.0
28 [8.2]	10.4	9.8	9.2	8.9	8.6	8.0
36 [10.6]	13.4	12.7	11.9	11.5	11.1	10.4
42 [12.3]	15.6	14.7	13.8	13.4	12.9	12.0
48 [14.1]	17.9	16.9	15.9	15.4	14.9	13.9

Note

1. TC: Total Capacity(kW)
2. Capacity tables show the average value of conditions which may occur.
3. Refer to Capacity tables and correction factor in the outdoor unit PDB for the actual performance data of each indoor unit and outdoor unit combination.

7. Air flow and temperature distributions (reference data)

Model : ARNU05GTAA4

Cooling

Discharge angle: Outer - 30°, Inner - 67°

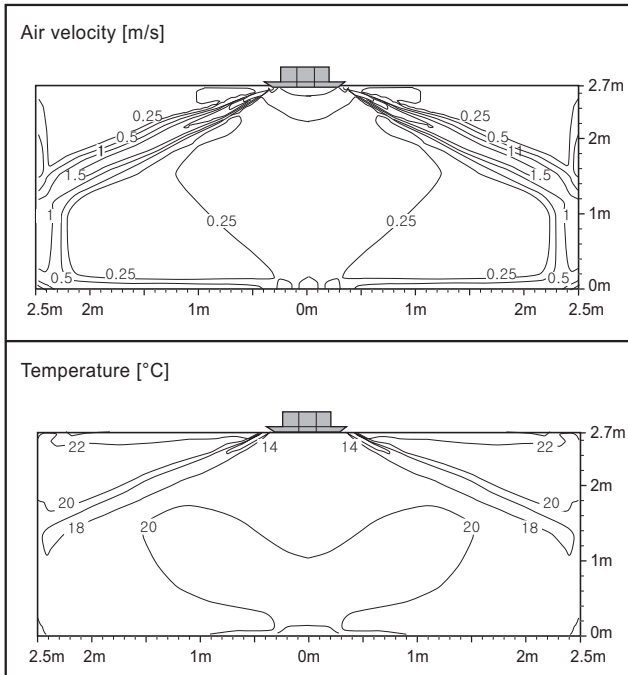

Heating

Discharge angle: Outer - 36°, Inner - 70°

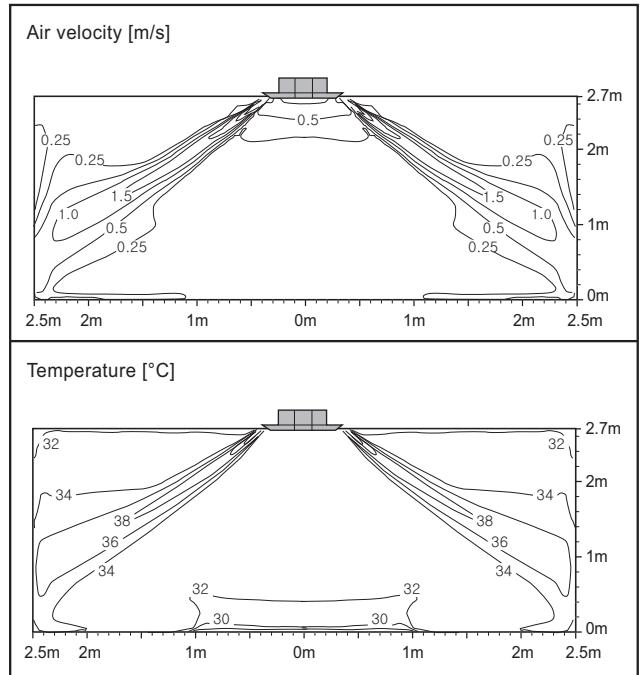

Model : ARNU07GTAA4

Cooling

Discharge angle: Outer - 30°, Inner - 67°

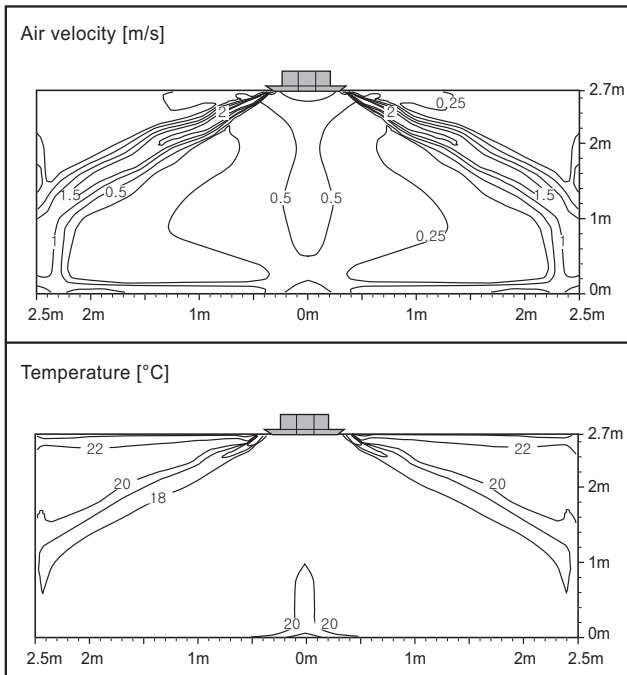

Heating

Discharge angle: Outer - 36°, Inner - 70°

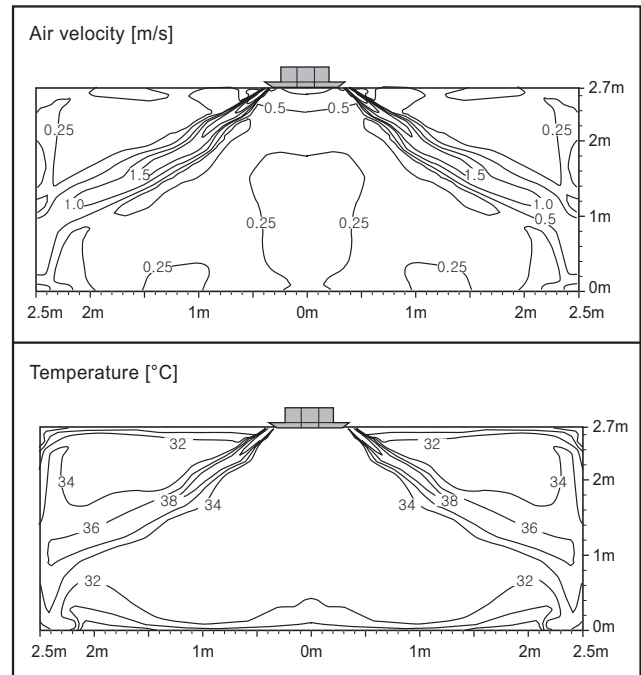

Note

- These figures are accordance with normal certain condition and environment. (Airflow step is 'High', Air discharge angle is fixed as indicated angle.)
- Indoor airflow distribution under actual installation or operating conditions depends on ambient temperature, ceiling height, product installation direction / location, indoor / Heating load, and other obstacles, etc.

7. Air flow and temperature distributions (reference data)

■ Model : ARNU09GTAA4

Cooling

Discharge angle: Outer - 30°, Inner - 67°

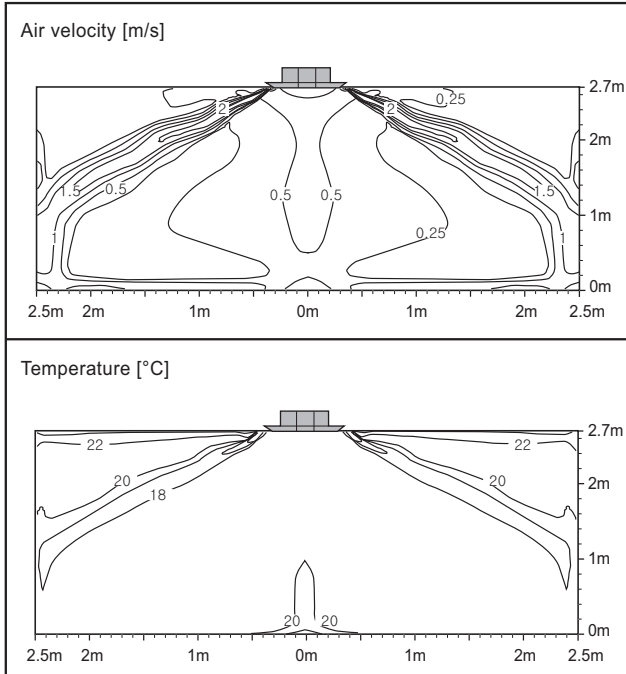

Heating

Discharge angle: Outer - 36°, Inner - 70°

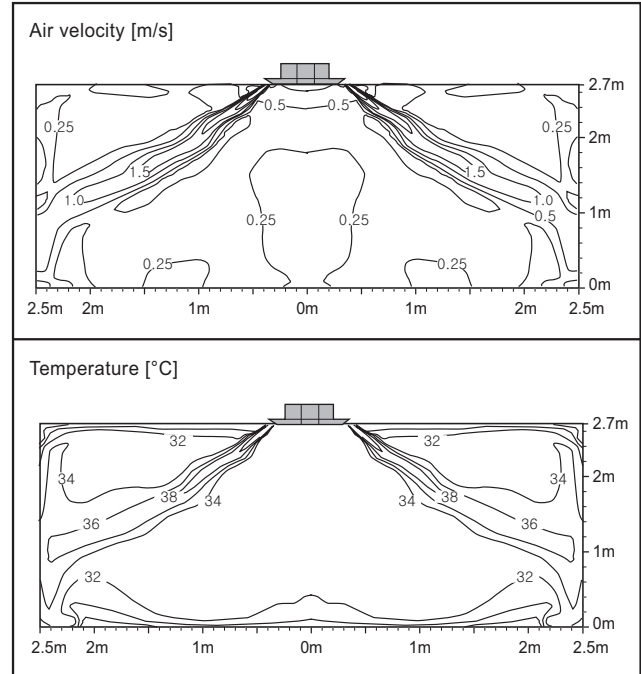

■ Model : ARNU12GTAA4

Cooling

Discharge angle: Outer - 30°, Inner - 67°

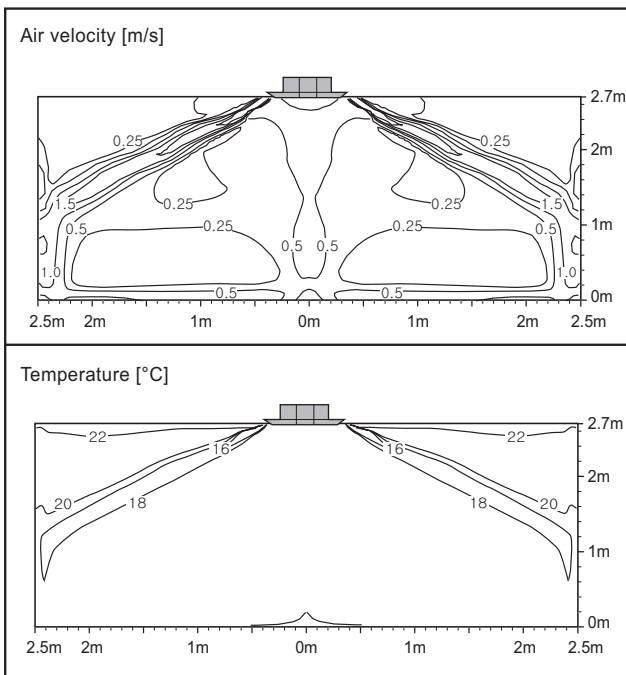

Heating

Discharge angle: Outer - 36°, Inner - 70°

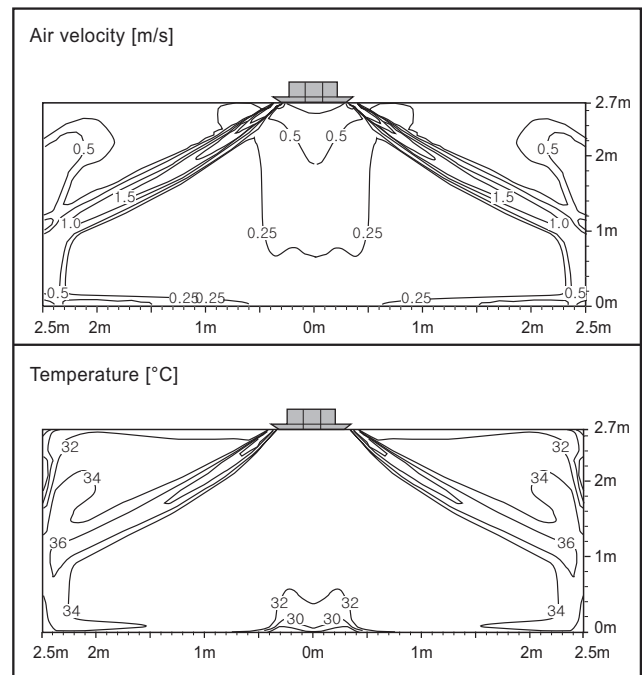

Note

- These figures are accordance with normal certain condition and environment. (Airflow step is 'High', Air discharge angle is fixed as indicated angle.)
- Indoor airflow distribution under actual installation or operating conditions depends on ambient temperature, ceiling height, product installation direction / location, indoor / Heating load, and other obstacles, etc.

7. Air flow and temperature distributions (reference data)

Model : ARNU15GTAA4

Cooling

Discharge angle: Outer - 30°, Inner - 67°

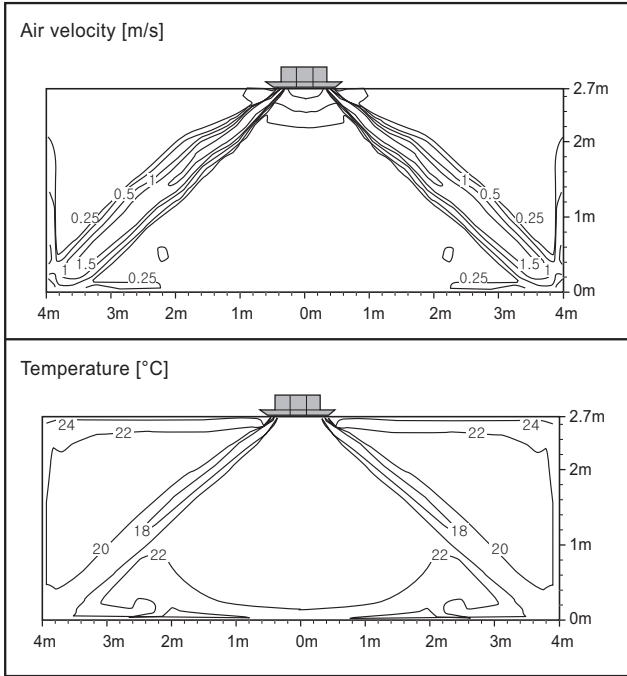

Heating

Discharge angle: Outer - 36°, Inner - 70°

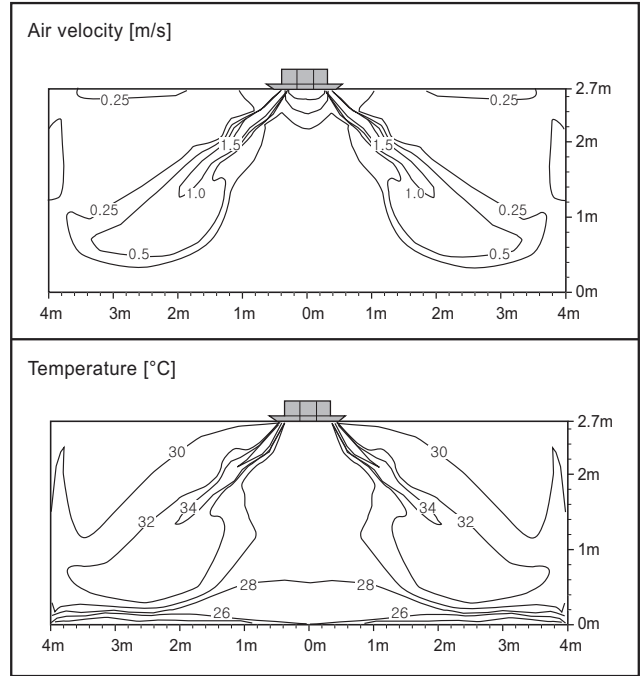

Model : ARNU18GTAA4

Cooling

Discharge angle: Outer - 30°, Inner - 67°

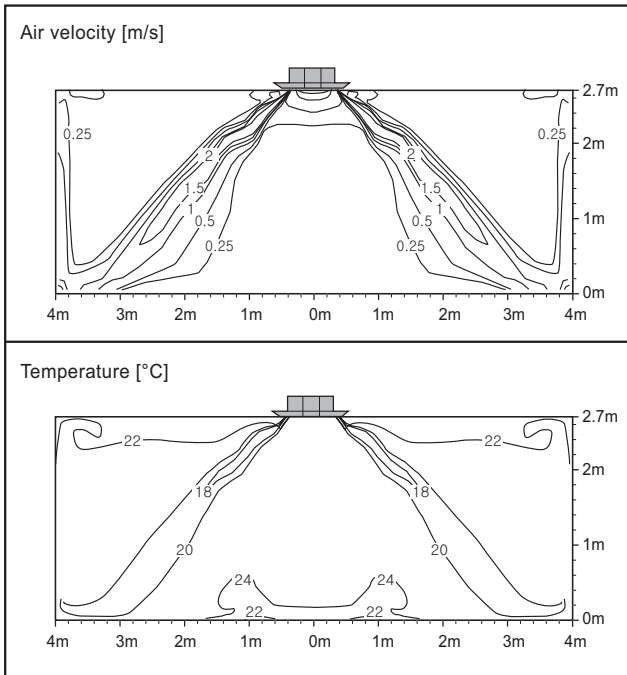

Heating

Discharge angle: Outer - 36°, Inner - 70°

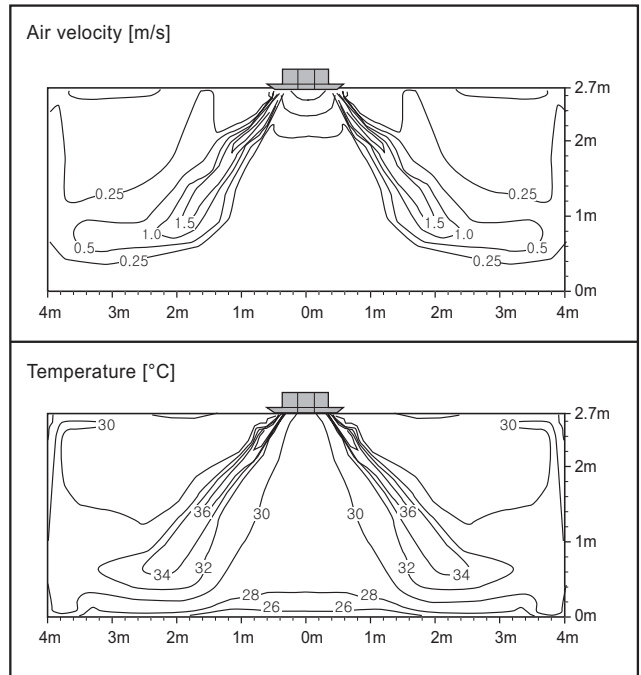

Note

- These figures are accordance with normal certain condition and environment. (Airflow step is 'High', Air discharge angle is fixed as indicated angle.)
- Indoor airflow distribution under actual installation or operating conditions depends on ambient temperature, ceiling height, product installation direction / location, indoor / Heating load, and other obstacles, etc.

7. Air flow and temperature distributions (reference data)

■ Model : ARNU24GTAA4

Cooling

Discharge angle: Outer - 30°, Inner - 67°

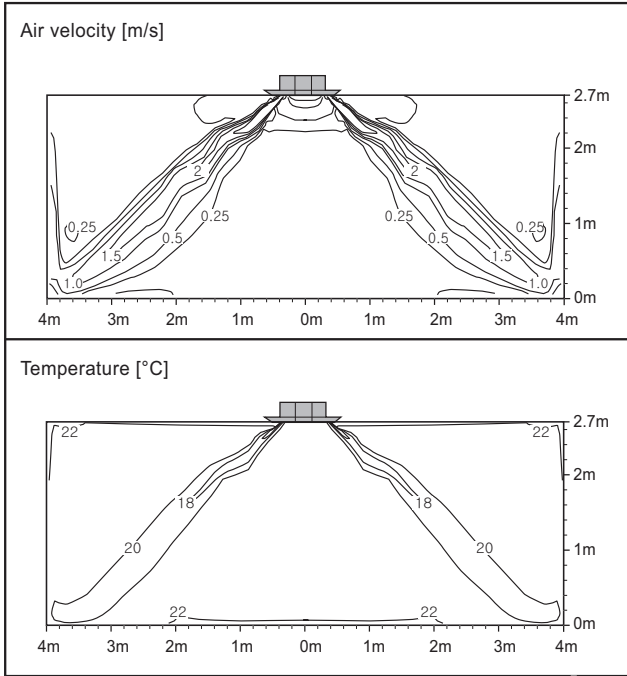

Heating

Discharge angle: Outer - 36°, Inner - 70°

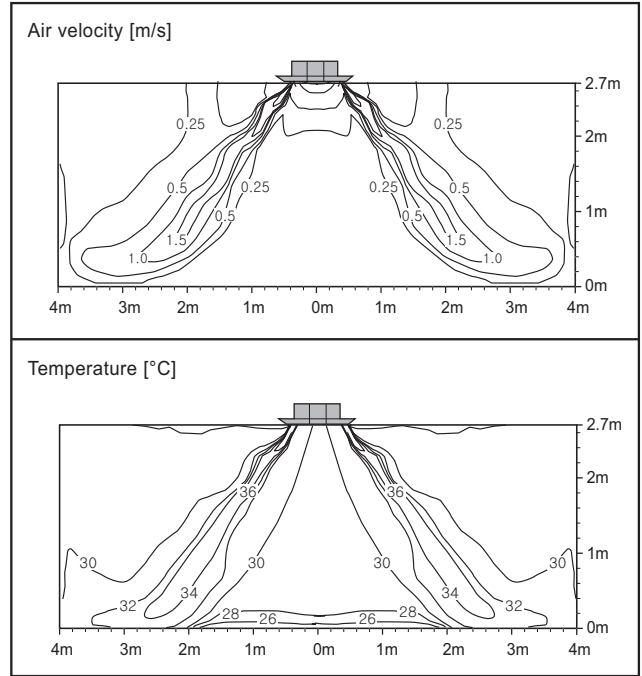

■ Model : ARNU28GTAA4

Cooling

Discharge angle: Outer - 30°, Inner - 67°

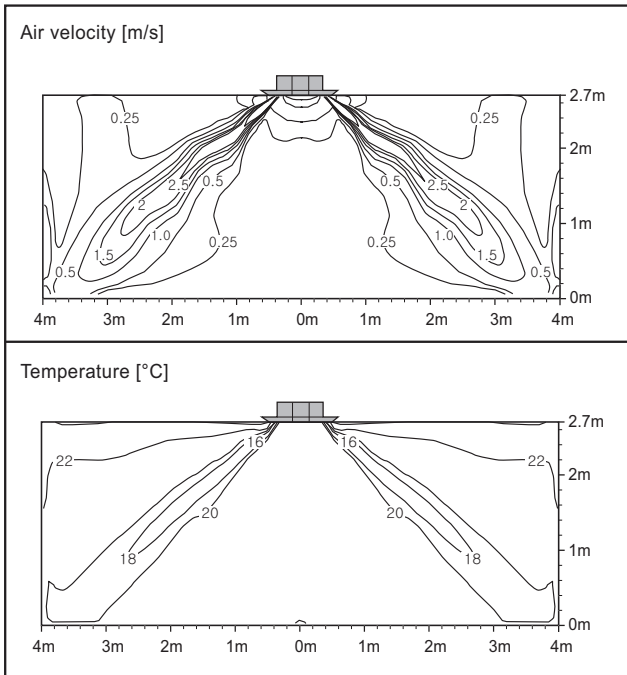

Heating

Discharge angle: Outer - 36°, Inner - 70°

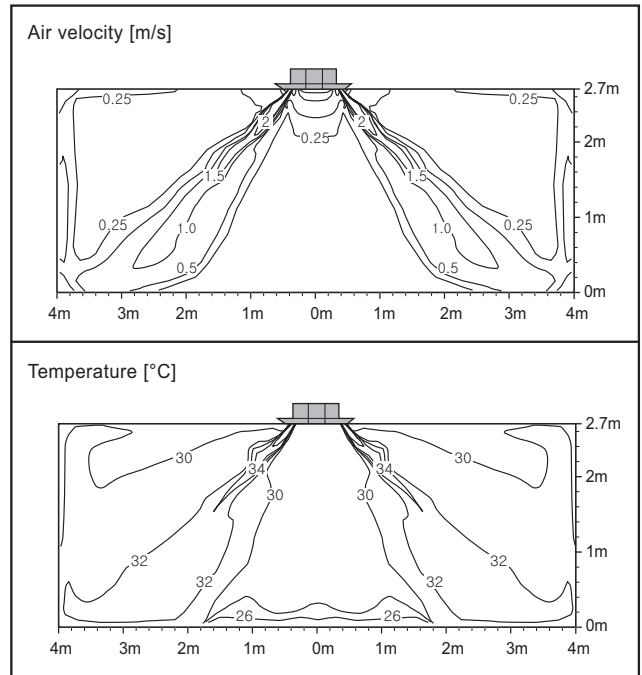

Note

- These figures are accordance with normal certain condition and environment. (Airflow step is 'High', Air discharge angle is fixed as indicated angle.)
- Indoor airflow distribution under actual installation or operating conditions depends on ambient temperature, ceiling height, product installation direction / location, indoor / Heating load, and other obstacles, etc.

7. Air flow and temperature distributions (reference data)

Model : ARNU36GTAA4

Cooling

Discharge angle: Outer - 30°, Inner - 67°

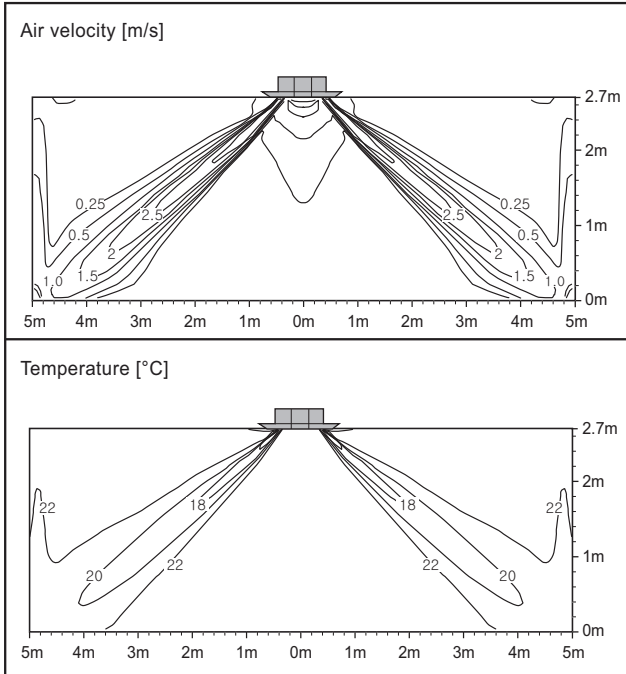

Heating

Discharge angle: Outer - 36°, Inner - 70°

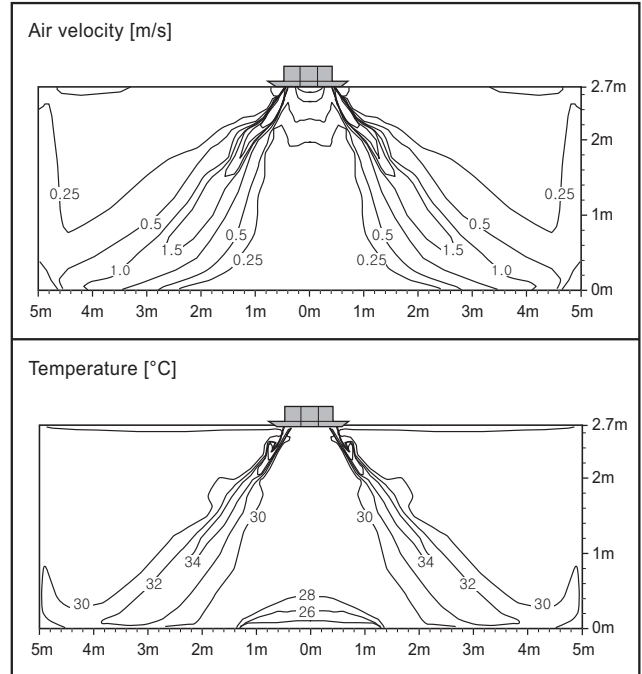

Model : ARNU42GTAA4

Cooling

Discharge angle: Outer - 30°, Inner - 67°

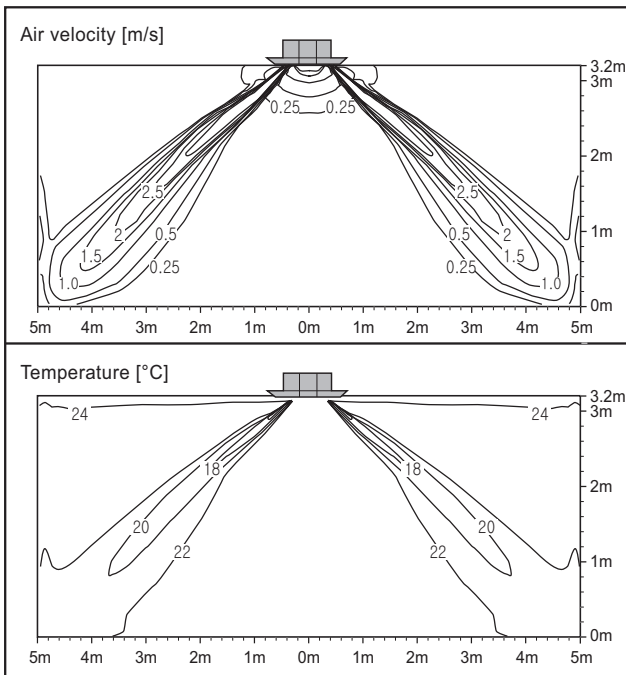

Heating

Discharge angle: Outer - 36°, Inner - 70°

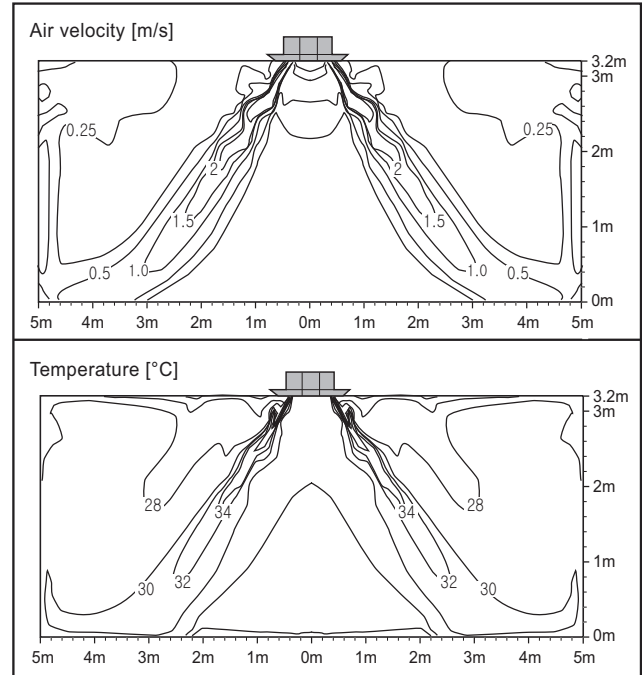

Note

- These figures are accordance with normal certain condition and environment. (Airflow step is 'High', Air discharge angle is fixed as indicated angle.)
- Indoor airflow distribution under actual installation or operating conditions depends on ambient temperature, ceiling height, product installation direction / location, indoor / Heating load, and other obstacles, etc.

7. Air flow and temperature distributions (reference data)

Model : ARNU48GTAA4

Cooling

Discharge angle: Outer - 30°, Inner - 67°

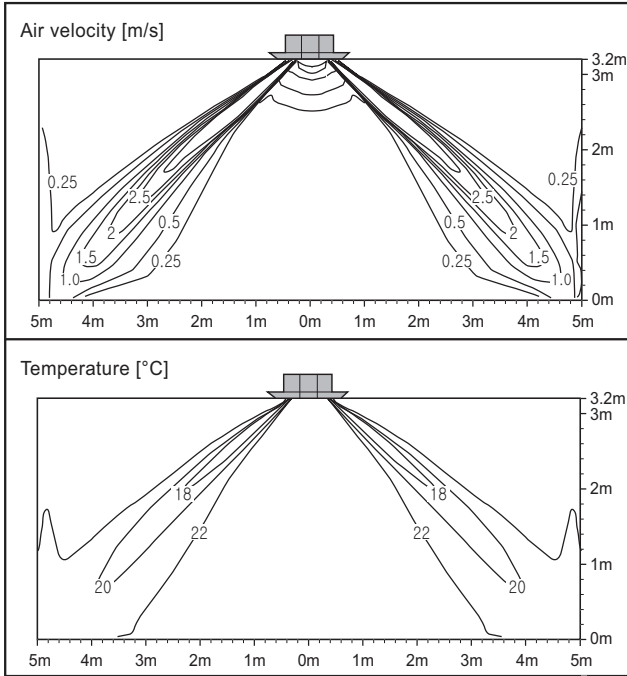

Heating

Discharge angle: Outer - 36°, Inner - 70°

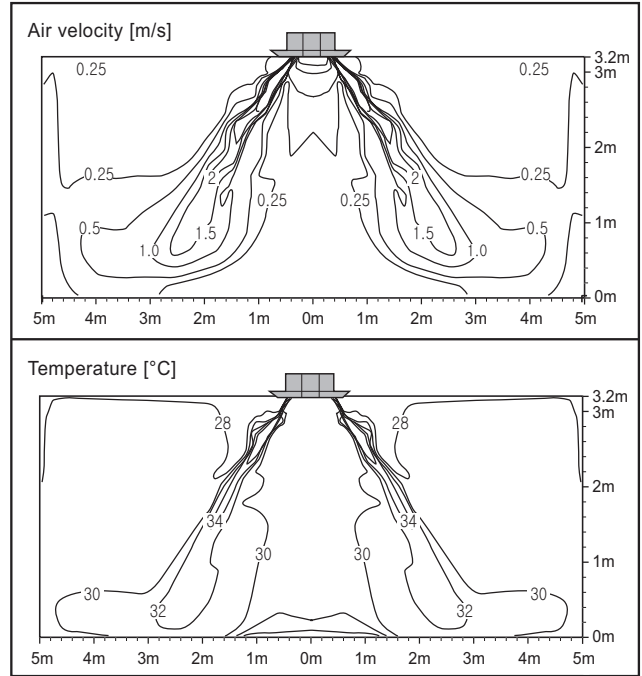

Note

- These figures are accordance with normal certain condition and environment. (Airflow step is 'High', Air discharge angle is fixed as indicated angle.)
- Indoor airflow distribution under actual installation or operating conditions depends on ambient temperature, ceiling height, product installation direction / location, indoor / Heating load, and other obstacles, etc.

8. Electric Characteristics

Units					Power Supply	IFM		PI	
Model	Type	Hz	Volts	Voltage Range	MCA	kW	FLA	Cooling	Heating
ARNU05GTAA4	TM-A	50	220-240	Max:264 Min:198	2.09	0.166	1.67	79	79
ARNU07GTAA4	TM-A				2.09	0.166	1.67	79	79
ARNU09GTAA4	TM-A				2.09	0.166	1.67	79	79
ARNU12GTAA4	TM-A				2.09	0.166	1.67	79	79
ARNU15GTAA4	TM-A				2.09	0.166	1.67	79	79
ARNU18GTAA4	TM-A				2.09	0.166	1.67	79	79
ARNU24GTAA4	TM-A				2.09	0.166	1.67	199	199
ARNU28GTAA4	TM-A				2.09	0.166	1.67	199	199
ARNU36GTAA4	TM-A				2.09	0.166	1.67	199	199
ARNU42GTAA4	TM-A				2.09	0.166	1.67	199	199
ARNU48GTAA4	TM-A	60	220	Max:242 Min:198	2.09	0.166	1.67	199	199
ARNU05GTAA4	TM-A				2.09	0.166	1.67	79	79
ARNU07GTAA4	TM-A				2.09	0.166	1.67	79	79
ARNU09GTAA4	TM-A				2.09	0.166	1.67	79	79
ARNU12GTAA4	TM-A				2.09	0.166	1.67	79	79
ARNU15GTAA4	TM-A				2.09	0.166	1.67	79	79
ARNU18GTAA4	TM-A				2.09	0.166	1.67	79	79
ARNU24GTAA4	TM-A				2.09	0.166	1.67	199	199
ARNU28GTAA4	TM-A				2.09	0.166	1.67	199	199
ARNU36GTAA4	TM-A				2.09	0.166	1.67	199	199
ARNU42GTAA4	TM-A	2.09	0.166	1.67	199	199			
ARNU48GTAA4	TM-A	2.09	0.166	1.67	199	199			

Symbols

MCA : Minimum Circuit Amperes (A)

MFA : Maximum Fuse Amperes (A)

kW : Fan Motor Rated Output (kW)

FLA : Full Load Amperes (A)

IFM : Indoor Fan Motor

PI : Maximum Power Input (W)

Note

- Voltage range
Units are suitable for use on electrical systems where voltage supplied to unit terminals is not below or above the listed range limits.
- Maximum allowable voltage unbalance between phases is 2%.
- MCA/MFA
 $MCA = 1.25 \times FLA$
 $MFA = 1.1 \times MCA, MFA \leq 4 \times FLA$
 (If MFA is smaller than minimum standard value, Use minimum standard value in region for selecting circuit breaker.)
- Select wire size based on the MCA
- Instead of fuse, use Circuit Breaker.

9. Sound levels

9.1 Sound pressure level

Overall

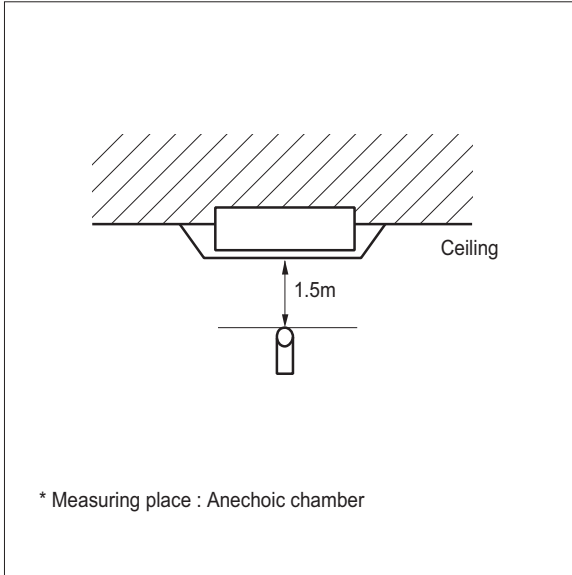

Note

- 1.Sound measured at some distance away from the center of the unit.
- 2.Data is valid at free field condition.
- 3.Reference acoustic pressure 0dB = 20μPa.
- 4.Data is valid at nominal operation condition.
Refer to the Model Specifications for nominal conditions(Power source and Ambient temperature, etc)
- 5.Sound levels can be increased in accordance with installation and operating conditions. (Static pressure mode, used air guide, Room target temperature setting, etc)
- 6.Sound level will vary depending on a range of factors such as the construction(acoustic absorption coefficient) of particular room in which the equipment is installed.
- 7.Sound pressure level is measured on the rated condition in the anechoic rooms by ISO 3745 standard.
Therefore, these values can be increased owing to ambient conditions during operation.

Model	Sound Pressure Levels [dB(A)]		
	H	M	L
ARNU05GTAA4	32	29	26
ARNU07GTAA4	32	30	26
ARNU09GTAA4	33	30	26
ARNU12GTAA4	34	31	27
ARNU15GTAA4	34	32	29
ARNU18GTAA4	35	32	30
ARNU24GTAA4	39	36	33
ARNU28GTAA4	40	37	34
ARNU36GTAA4	42	39	35
ARNU42GTAA4	46	42	39
ARNU48GTAA4	47	43	41

ARNU05GTAA4

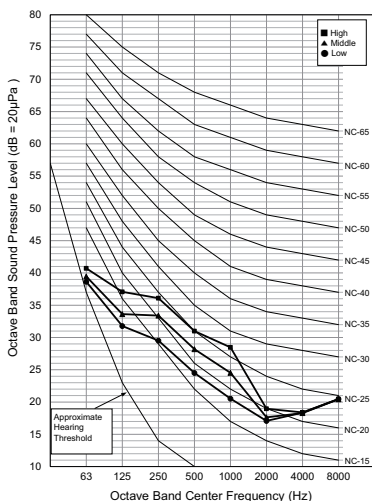

ARNU07GTAA4

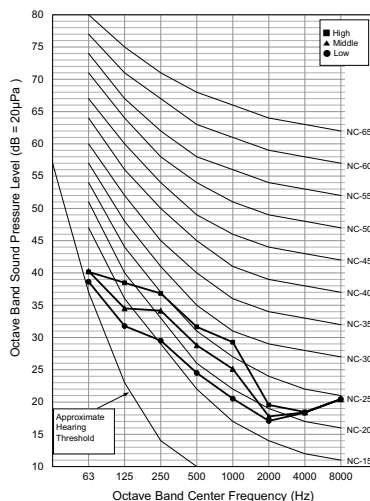

ARNU09GTAA4

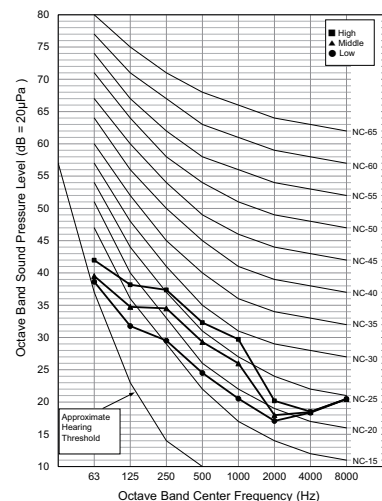

9. Sound levels

ARNU12GTAA4

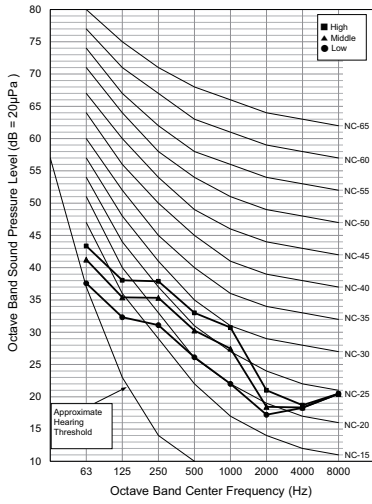

ARNU15GTAA4

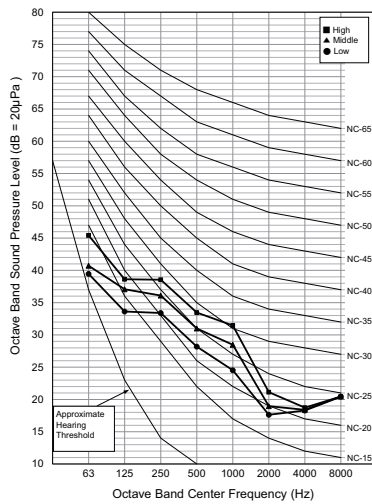

ARNU18GTAA4

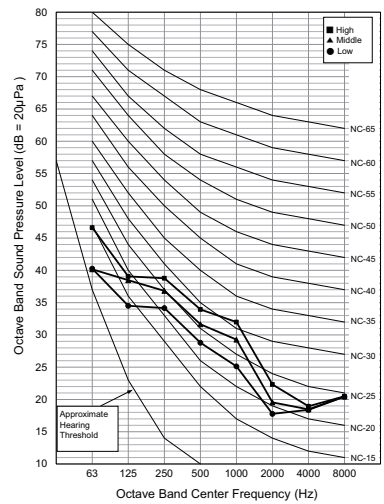

ARNU24GTAA4

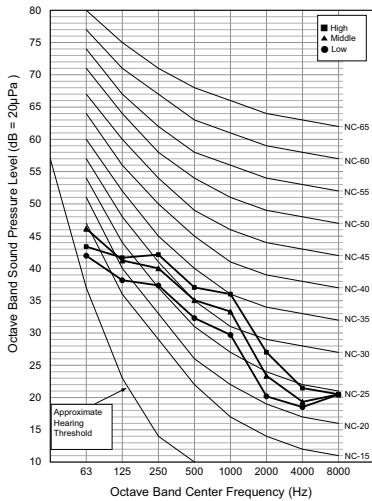

ARNU28GTAA4

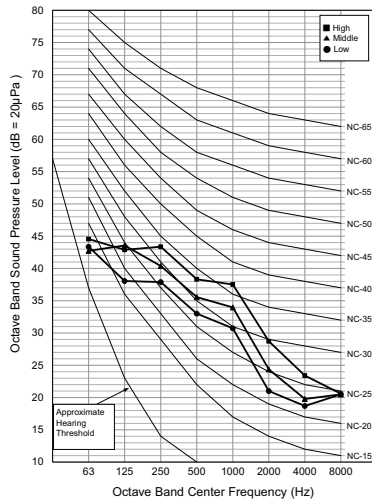

ARNU36GTAA4

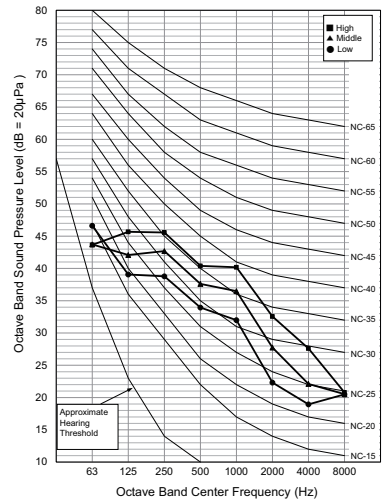

ARNU42GTAA4

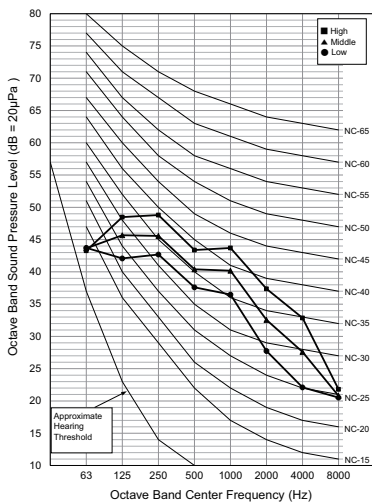

ARNU48GTAA4

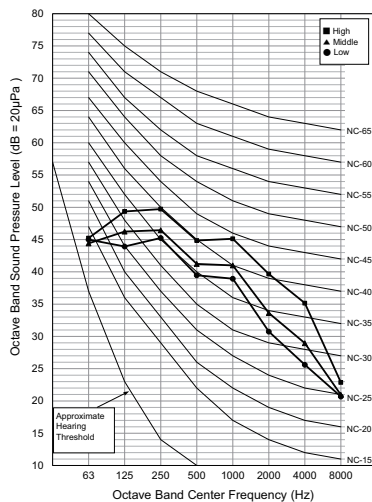

9. Sound levels

9.2 Sound power level

Note

- Data is valid at diffuse field condition
- Data is valid at nominal operating condition
- Sound level can be increased in static pressure mode or used air guide.
- Sound level will vary depending on a range of factors such as the construction (acoustic absorption coefficient) of particular room in which the equipment is installed.
- Reference acoustic intensity $0\text{dB} = 10\text{E-}6\mu\text{W/m}^2$
- Sound power level is measured on the rated condition in the semi-anechoic rooms by ISO 9614 standard. Therefore, these values can be increased owing to ambient conditions during operation.

Model	Sound Power Levels [dB(A)]		
	H	M	L
ARNU05GTAA4	40	37	36
ARNU07GTAA4	41	38	36
ARNU09GTAA4	42	39	36
ARNU12GTAA4	42	40	37
ARNU15GTAA4	43	40	38
ARNU18GTAA4	44	41	38
ARNU24GTAA4	47	45	42
ARNU28GTAA4	48	46	42
ARNU36GTAA4	51	48	44
ARNU42GTAA4	54	51	48
ARNU48GTAA4	56	52	50

9. Sound levels

ARNU05GTAA4

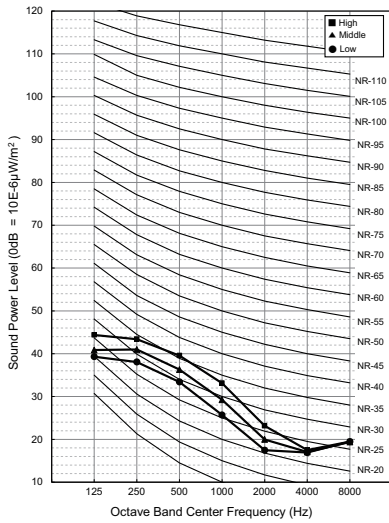

ARNU07GTAA4

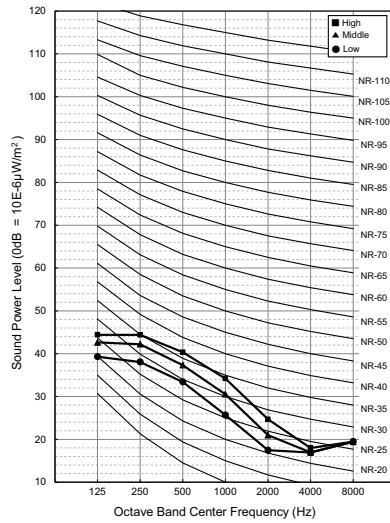

ARNU09GTAA4

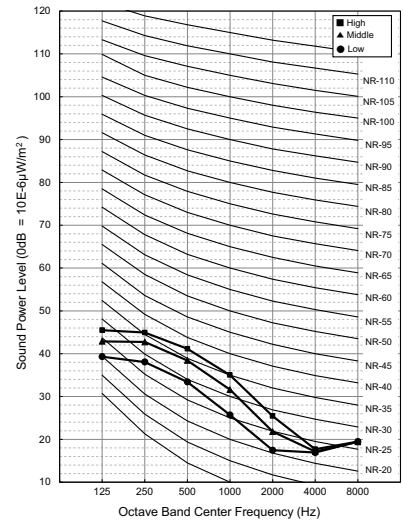

ARNU12GTAA4

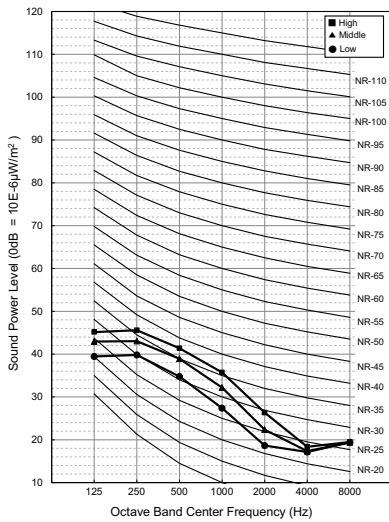

ARNU15GTAA4

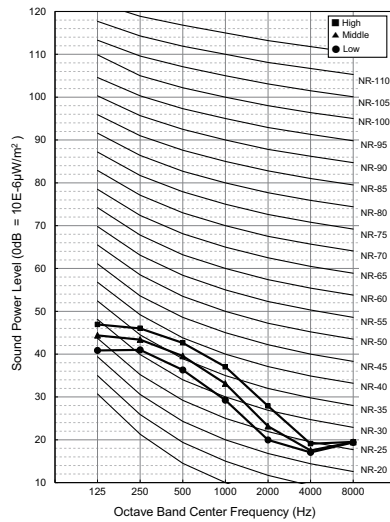

ARNU18GTAA4

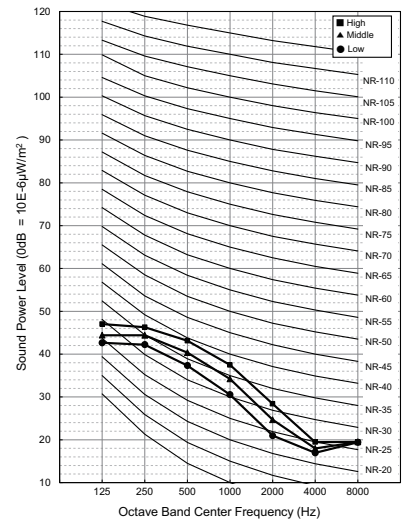

ARNU24GTAA4

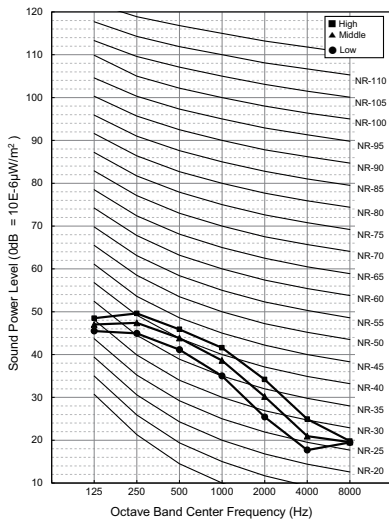

ARNU28GTAA4

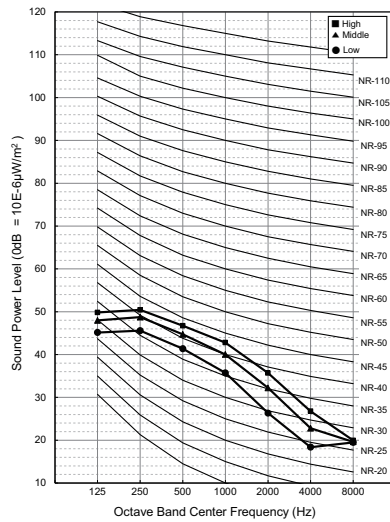

ARNU36GTAA4

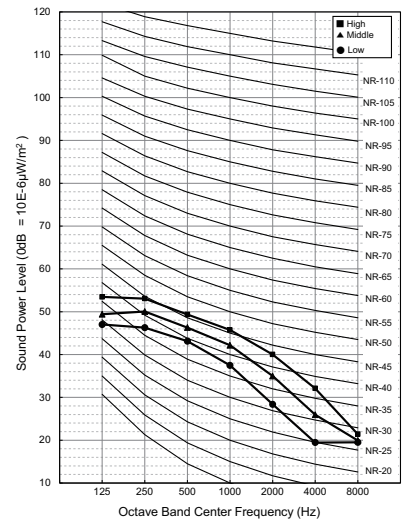

9. Sound levels

ARNU42GTAA4

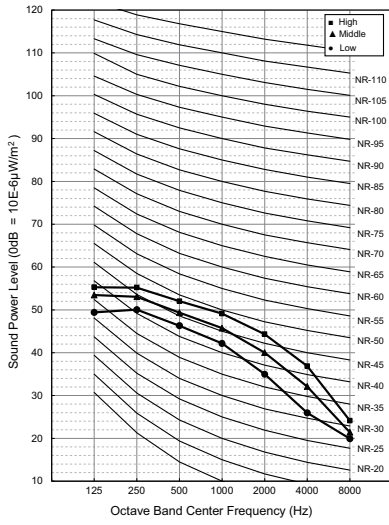

ARNU48GTAA4

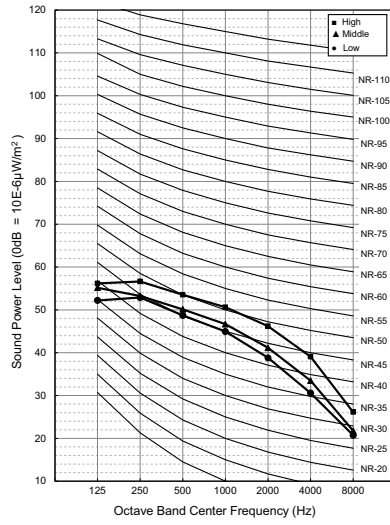

Ceiling Mounted Cassette (Round)

- 1. List of functions**
- 2. Specifications**
- 3. Dimensions**
- 4. Piping Diagrams**
- 5. Wiring Diagrams**
- 6. Capacity Tables**
- 7. Air Velocity and Temperature Distribution**
- 8. Electric Characteristics**
- 9. Sound Levels**

1. List of functions

Category	Function	ARNU24GTYA4 ARNU36GTYA4 ARNU48GTYA4
Air Flow	Air Supply Outlet	Round
	Airflow Direction Control (left & right)	X
	Airflow Direction Control (up & down)	Auto
	Auto Swing (left & right)	X
	Auto Swing (up & down)	O
	Airflow Steps (fan/cool/heat)	4 / 5 / 4
	Fan Speed Auto*	Advanced
	Power Cool/Heat	O / X
	Swirl Wind*	-
	Refresh Mode**	X
	Smart Mode**	X
	Indirect Wind*	O
	Direct Wind*	O
Dry Operation	O	
Air Purification	Air Purify	Accessory
	Ionizer	X
	UV-C	X
	Pre-Filter	O
Reliability	Hot Start	O
	Self Diagnosis	O
Convenience	Auto Mode	O
	Auto Dry Operation	O
	Auto Restart	O
	Child Lock*	O
	Forced Operation	O
	Group Control*	O
	Sleep Timer	O
	Turn On/Off Reservation	O
	Schedule*	O
	Two Thermistor Control*	O
External On/Off	O	
Installation	Drain Pump	O
	E.S.P. Control*	X
	High Ceiling Operation*	O
Special Functions	Wi-Fi	Accessory
	Auto Elevation Grille	X
	Human Detection Function**	X
	Floor Detection Function**	X

Note

- O : Applied, X : Not Applied, - : Unconfirmed or irrelevant
Embedded : A kit is provided by default for using this function when the product is manufactured.
Accessory : Ordered and purchased separately the accessory package referring to the model name provided and install at field. Accessory line-ups varies by region, so check your local catalogue or local sales material.
- Some functions can be limited by remote controller.
- In case of cassette type indoor units, Air Purification Kit and Auto Elevation Grille functions are not applicable at the same time.
- 'Auto Mode' varies depending on the outdoor unit type.
 - Auto Change Over(Heat Recovery Outdoor Unit)
 - Auto Mode Select(Heat Pump Outdoor Unit)
 - Auto Intensity Control(Cooling Only Outdoor Unit)
- * : These functions need to connect the wired remote controller.
- ** : This functions need to connect to the Standard III wired remote controller.

1. List of functions

■ Accessory Compatibility List

Category	Accessory Name	Model Name	Description	ARNU24GTYA4 ARNU36GTYA4 ARNU48GTYA4
Remote Controller	Wired - Premium	PREMTA000	-	○
		PREMTA000A	-	○
		PREMTA000B	-	○
	Wired - RS3 (Standard III)	PREMTB100/PREMTB101	White	○
		PREMTBB10/PREMTBB11	Black	○
	Wired - RS2 (Standard II)	PREMTB001	White	○
		PREMTBB01	Black	○
	Wired - Simple	PQRCVCL0QW	White	○
		PQRCVCL0Q	Black	○
	Wired - Simple for Hotel	PQRCHCA0QW	White	○
		PQRCHCA0Q	Black	○
	Wireless	PQWRCQ0FDB	For Cooling only	○
PQWRHQ0FDB		For Heat pump	○	
PWLSSB21C		For Cooling only	○	
PWLSSB21H		For Heat pump	○	
Dry Contact	Simple	PDRYCB000	1 input port, AC 220 - 240V	○
		PDRYCB100	1 input port, AC 24V	○
	Communication	PDRYCB400	2 input port	○
		PDRYCB300	8 input port, For 3rd party Thermostat	○
		PDRYCB320	8 input port, For 3rd Party Thermostat (Analog Input)	○
PDRYCB500	For 3rd Party Controller (Modbus RTU)	○		
Integration Device	Remote Temperature sensor	PQRSTA0	-	○
	Group Control wire	PZCWRCG3	Cable Assembly for group control (Y-type cable : 0.25m, cable : 9.6m)	○
ETC	Extension wire	PZCWRC1	Extension wire for IDU-wired remote controller (9.6m)	○
	2-Remo Control Wire	PZCWRC2	-	X
	Wi-Fi Modem	PWFMDD200	-	○
	Wi-Fi Extension cable	PWYREW000	USB Extension cable : 10 m	○
	Independent Power Module	PRIP0	-	○
	Multi-tenant Power Module	PINPMB001	-	○
	Refrigerant Leakage Detector	PRLDNVS0	For R410A only	○
	Human Detection Sensor	PTVSMA0	For Cassette 4-way	X
		PTVSAA0	For Cassette Dual Vane 4-way	X
	Floor Detection Sensor	PTFSMA0	-	X
	Auto Elevation Grille	PTEGM0	For TP/TN/TM	X
	Air Purification Kit	PTAHTP0	For Cassette 1-way	X
		PTAHMP0	For Cassette 4-way	X
		PTAHYP0	For Cassette Round	○
	EEV Kit	PRGK024A0	For Multi V Indoor Unit	X
	Auxiliary Heater Relay Kit	PRARS1	For Wall Mounted and Art Cool Indoor Units	X
		PRARH1	For Cassette and Duct Indoor Units	X
	Ventilation Kit	PTVK430	For TR/TQ/TP/TN/TM	X
		PTVK410 + PTVK420	For TP/TN/TM	X
	Cassette Cover	PTDCQ	For TR/TQ	X
PTDCM		For TP/TN/TM	X	
PTDCA		For TM-A/TP-B	X	

Note

1. ○: Possible, X: Impossible, - : Not applicable, Embedded : Included with product.
2. If there is a difference in development time between the product and the remote controller, some functions cannot be operated.
3. If using Wi-Fi controller, Some advanced functions controlled by remote controller cannot be operated.
4. If you need more detail, please refer to the **BECON** PDB or the manual of product. (<http://partner.lge.com/global> : Home> Doc.Library> Product > Control(BECON))

2. Specifications

Model Name		Unit	ARNU24GTYA4	ARNU36GTYA4	ARNU48GTYA4
Power Supply	-	V, Φ , Hz	220-230-240, 1, 50/60	220-230-240, 1, 50/60	220-230-240, 1, 50/60
	Running Current by voltage	A	0.47 - 0.45 - 0.43	0.67 - 0.64 - 0.61	0.99 - 0.95 - 0.91
Cooling Capacity	Rated	kW	7.1	10.6	14.1
		kcal/h	6,100	9,100	12,100
		Btu/h	24,200	36,200	48,100
Heating Capacity	Rated	kW	8.0	11.9	15.9
		kcal/h	6,900	10,200	13,200
		Btu/h	27,300	40,600	54,200
Power Input	H/M/L	W	44 / 36 / 29	63 / 47 / 36	98 / 70 / 44
Running Current	H/M/L	A	0.47 / 0.40 / 0.32	0.67 / 0.52 / 0.40	0.99 / 0.74 / 0.47
Fan	Type	-	3D Turbo Fan	3D Turbo Fan	3D Turbo Fan
	Air Flow Rate(H/M/L)	m ³ /min	22 / 21 / 19	27 / 24 / 21	32 / 28 / 23
Fan Motor	Type	-	Brushless DC	Brushless DC	Brushless DC
	Drive	-	Direct	Direct	Direct
	Output	W x No.	157 x 1	157 x 1	157 x 1
	FLA(Full Load Ampere)	A	1.97	1.97	1.97
Heat Exchanger	(Rows x Columns x FPI) x No.	-	(3 x 12 x 21) x 1	(3 x 12 x 21) x 1	(3 x 12 x 21) x 1
	Face Area	m ²	0.5	0.5	0.5
Dimensions	Net(W x H x D)	mm	1,050 x 330 x 1,050	1,050 x 330 x 1,050	1,050 x 330 x 1,050
	Shipping(W x H x D)	mm	1,137 x 395 x 1,132	1,137 x 395 x 1,132	1,137 x 395 x 1,132
Weight	Net	kg	30.0	30.0	30.0
	Shipping	kg	37.9	37.9	37.9
Exterior	Color	-	White	White	White
	RAL Code	-	RAL 9003	RAL 9003	RAL 9003
Air Filter	Type	-	Long life	Long life	Long life
Temperature Control	-	-	Microprocessor, Thermostat for cooling and heating		
Sound Absorbing / Thermal Insulation Material	-	-	Foamed polystyrene		
Safety Device	-	-	Fuse	Fuse	Fuse
Refrigerant	Type	-	R410A/R32	R410A/R32	R410A/R32
	Additional Charging Amount (CF Value of IDU)	kg(each)	0.49/0.41	0.49/0.41	0.49/0.41
	Control Type	-	EEV	EEV	EEV
Drain Pipe	O.D / I.D	mm(inch)	32 / 25	32 / 25	32 / 25
Piping Connection	Liquid	mm(inch)	Φ 9.52 (3/8)	Φ 9.52 (3/8)	Φ 9.52 (3/8)
	Gas	mm(inch)	Φ 15.88 (5/8)	Φ 15.88 (5/8)	Φ 15.88 (5/8)
	Connection Type(Liquid)	-	Flare	Flare	Flare
	Connection Type(Gas)	-	Flare	Flare	Flare
Sound Pressure Level (H / M / L)	-	dB(A)	39 / 37 / 34	43 / 39 / 37	47 / 44 / 39
Sound Power Level (H / M / L)	-	dB(A)	48 / 46 / 43	52 / 48 / 46	56 / 53 / 48
Connecting Cable	Communication Cable (VCTF-SB)	mm ² x cores	1.0~1.5 x 2C	1.0~1.5 x 2C	1.0~1.5 x 2C

Note

- Due to our policy of innovation some specifications may be changed without notification.
- Wiring cable size must comply with the applicable local and national code. And "Electric characteristics" chapter should be considered for electrical work and design. Especially the power cable and circuit breaker should be selected in accordance with that.
- Sound pressure level is measured on the rated condition in the anechoic rooms by ISO 3745 standard.
Sound power level is measured on the rated condition in the semi-anechoic rooms by ISO 9614 standard.
Therefore, these values can be increased owing to ambient conditions during operation.
- Capacities are net capacities and based on the following conditions. Refer to the Outdoor Unit Specifications for calculating the real capacity.
 - Cooling : Indoor Ambient Temp. 27°CDB / 19°CWB, Outdoor Ambient Temp. 35°CDB / 24°CWB
 - Heating : Indoor Ambient Temp. 20°CDB / 15°CWB, Outdoor Ambient Temp. 7°CDB / 6°CWB
 - Interconnected Pipe is standard length and difference of Elevation (Outdoor ~ Indoor Unit) is 0m.
- Refrigerant information (type, additional charging amount, etc.) must be applied by refrigerant type of the combined outdoor unit.
Adapt after checking the specifications of outdoor unit.

3. Dimensions

3.1 Dimensional Drawings

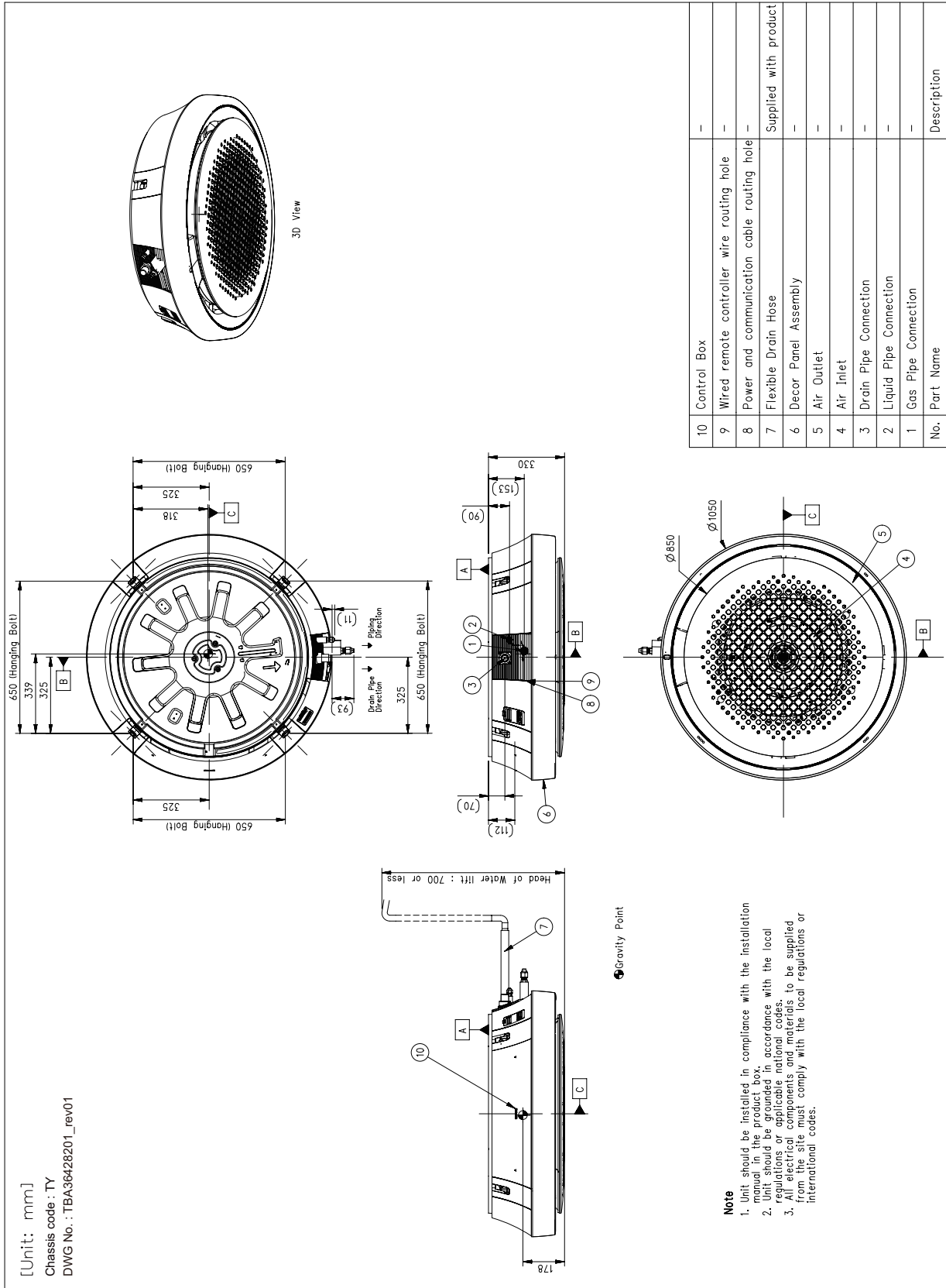

4. Piping Diagrams

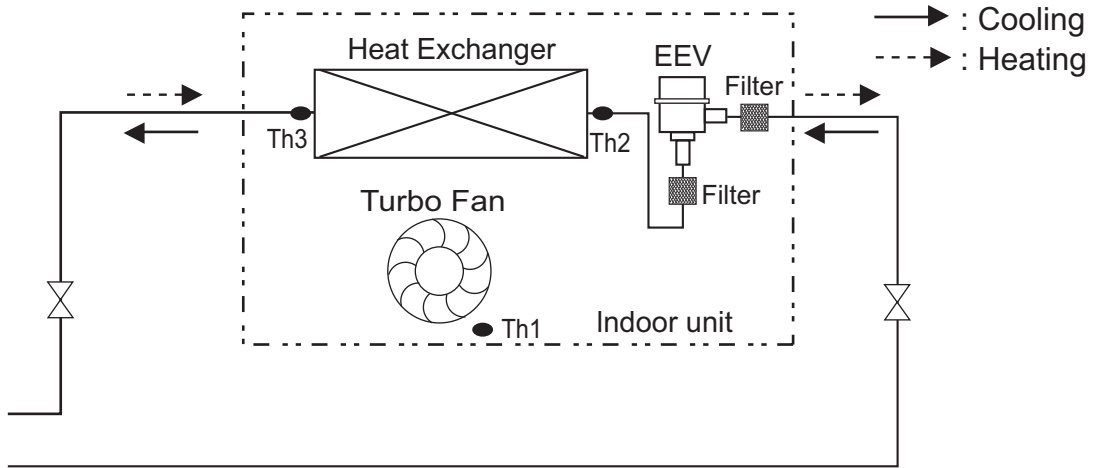

LOC.	Description
Th1	Room thermistor
Th2	Pipe in thermistor
Th3	Pipe out thermistor

5. Wiring Diagrams

◆ ARNU24GTYA4, ARNU36GTYA4, ARNU48GTYA4

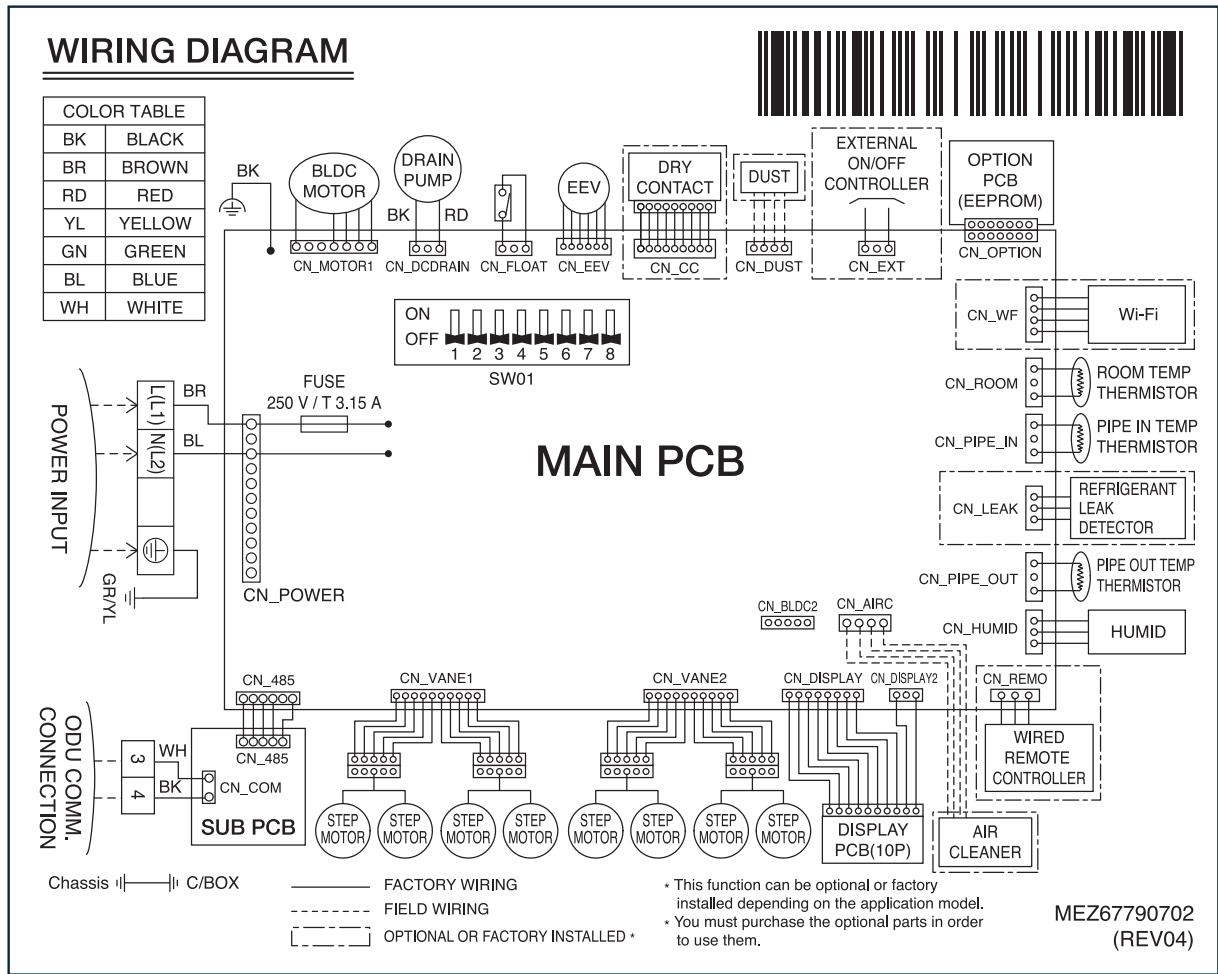

6. Capacity Tables

■ Cooling Capacity

Capacity Index (kW)	Indoor air temp. (DB/WB, °C)													
	20		23		26		27		28		30		32	
	14		16		18		19		20		22		24	
	TC	SHC	TC	SHC	TC	SHC	TC	SHC	TC	SHC	TC	SHC	TC	SHC
7.1	4.8	4.1	5.7	4.5	6.6	4.9	7.1	5.0	7.6	5.2	7.7	4.9	7.8	4.5
10.6	7.2	6.3	8.5	6.9	9.9	7.5	10.6	7.6	11.3	7.9	11.5	7.5	11.6	6.9
14.1	9.5	8.0	11.3	9.1	13.1	9.9	14.1	10.1	15.1	10.5	15.3	9.9	15.5	9.1

■ Heating Capacity

Capacity Index (kW)	Indoor air temp. (DB, °C)					
	16	18	20	21	22	24
	TC	TC	TC	TC	TC	TC
7.1	9.0	8.5	8.0	7.7	7.5	7.0
10.6	13.4	12.7	11.9	11.5	11.1	10.4
14.1	17.9	16.9	15.9	15.4	14.9	13.9

Note

1. TC: Total Capacity(kW), SHC: Sensible Heat Capacity(kW)
2. Capacity tables show the average value of conditions which may occur.
3. Refer to Capacity tables and correction factor in the outdoor unit PDB for the actual performance data of each indoor unit and outdoor unit combination.

7. Air Velocity and Temperature Distribution

◆ ARNU24GTYA4

Cooling

Vane : 0 mm

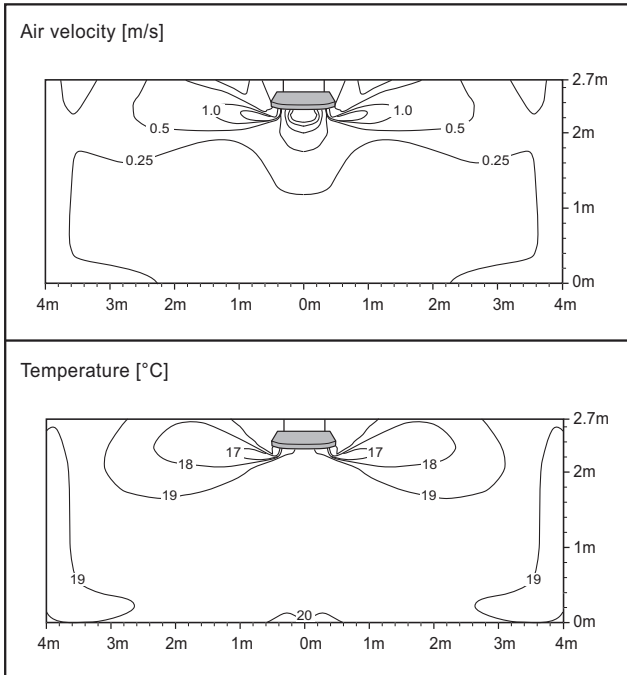

Heating

Vane : 15 mm

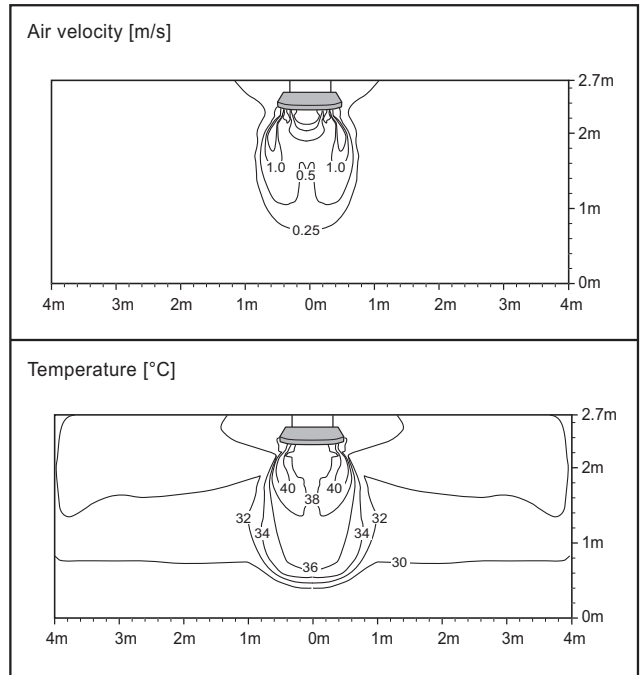

◆ ARNU36GTYA4

Cooling

Vane : 0 mm

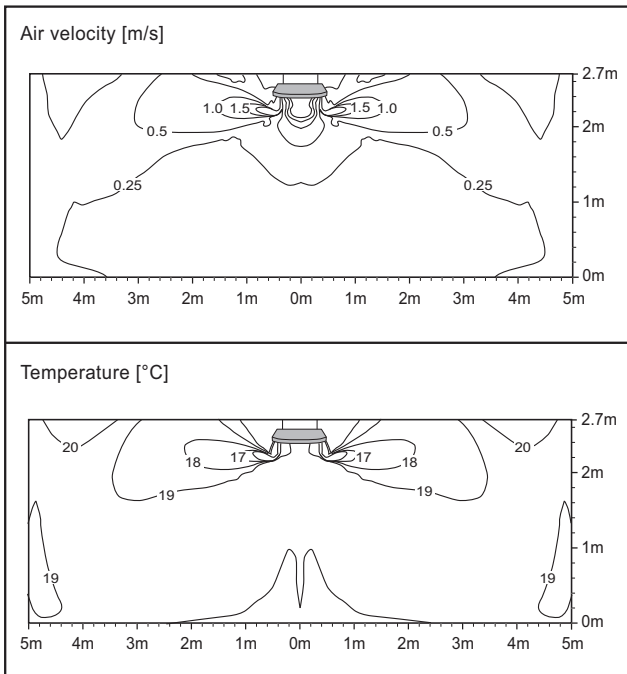

Heating

Vane : 15 mm

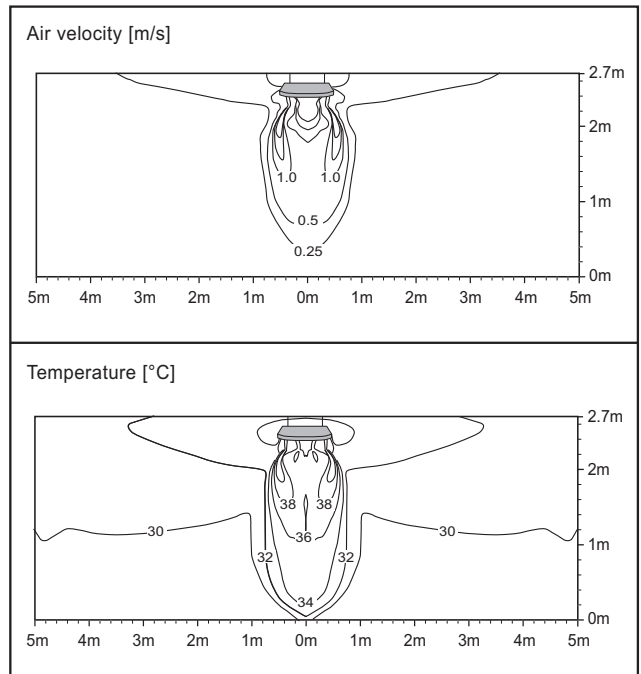

Note

- These figures are accordance with normal certain condition and environment. (Airflow step is 'High', Air discharge angle is fixed as indicated angle.)
- Indoor airflow distribution under actual installation or operating conditions depends on ambient temperature, ceiling height, product installation direction / location, indoor / Heating load, and other obstacles, etc.

7. Air Velocity and Temperature Distribution

◆ ARNU48GTYA4

Cooling

Vane : 1 step

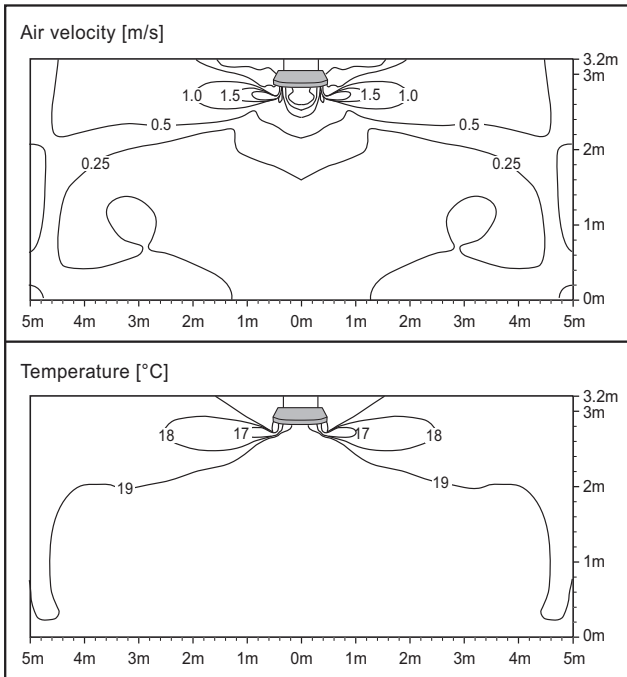

Heating

Vane : 6 step

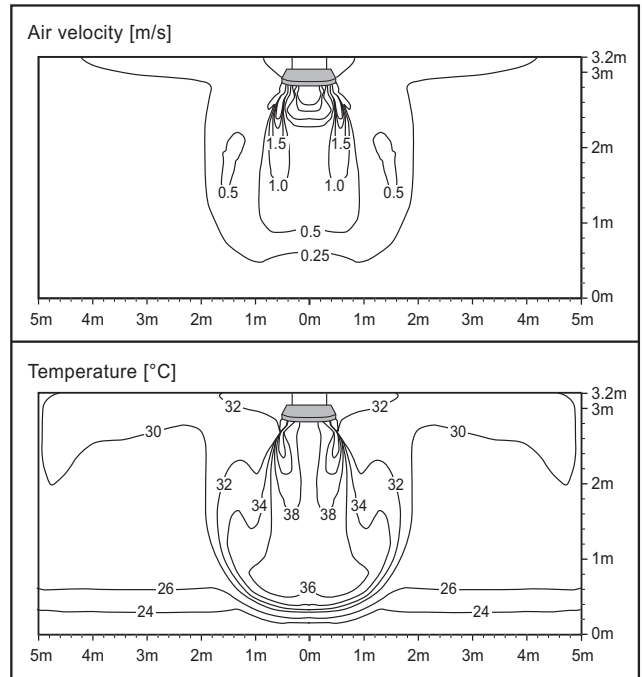

Note

- These figures are accordance with normal certain condition and environment. (Airflow step is 'High', Air discharge angle is fixed as indicated angle.)
- Indoor airflow distribution under actual installation or operating conditions depends on ambient temperature, ceiling height, product installation direction / location, indoor / Heating load, and other obstacles, etc.

8. Electric Characteristics

Units					Power Supply	IFM		PI	
Model	Type	Hz	Volts	Voltage Range	MCA	kW	FLA	Cooling	Heating
ARNU24GTYA4	TY	50	220-240	Max. : 264 Min. : 198	2.50	0.157	1.97	55	55
ARNU36GTYA4					2.50	0.157	1.97	90	90
ARNU48GTYA4					2.50	0.157	1.97	120	120
ARNU24GTYA4	TY	60	230	Max. : 253 Min. : 207	2.50	0.157	1.97	55	55
ARNU36GTYA4					2.50	0.157	1.97	90	90
ARNU48GTYA4					2.50	0.157	1.97	120	120

Symbols

MCA : Minimum Circuit Amperes (A)

MFA : Maximum Fuse Amperes (A)

kW : Fan Motor Rated Output (kW)

FLA : Full Load Amperes (A)

IFM : Indoor Fan Motor

PI : Maximum Power Input (W)

Note

- Voltage range
Units are suitable for use on electrical systems where voltage supplied to unit terminals is not below or above the listed range limits.
- Maximum allowable voltage unbalance between phases is 2%.
- MCA/MFA
 $MCA = 1.25 \times FLA$
 $MFA = 1.1 \times MCA, MFA \leq 4 \times FLA$
 (If MFA is smaller than minimum standard value, Use minimum standard value in region for selecting circuit breaker.)
- Select wire size based on the MCA
- Instead of fuse, use Circuit Breaker.

9. Sound Levels

9.1 Sound Pressure Levels

Overall

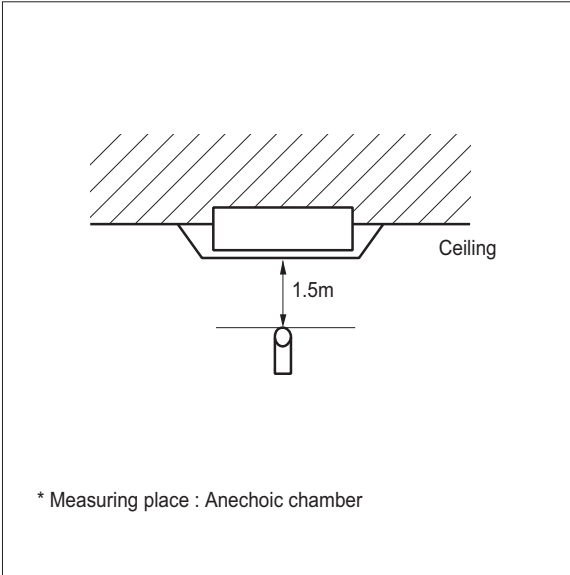

Note

- 1.Sound measured at some distance away from the center of the unit.
- 2.Data is valid at free field condition.
- 3.Reference acoustic pressure 0dB = 20μPa.
- 4.Data is valid at nominal operation condition.
Refer to the Model Specifications for nominal conditions(Power source and Ambient temperature, etc)
- 5.Sound levels can be increased in accordance with installation and operating conditions. (Static pressure mode, used air guide, Room target temperature setting, etc)
- 6.Sound level will vary depending on a range of factors such as the construction(acoustic absorption coefficient) of particular room in which the equipment is installed.
- 7.Sound pressure level is measured on the rated condition in the anechoic rooms by ISO 3745 standard.
Therefore, these values can be increased owing to ambient conditions during operation.

Model	Sound Pressure Levels [dB(A)]		
	H	M	L
ARNU24GTYA4	39	37	34
ARNU36GTYA4	43	39	37
ARNU48GTYA4	47	44	39

ARNU24GTYA4

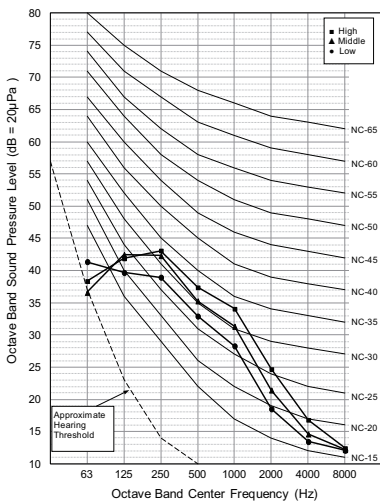

ARNU36GTYA4

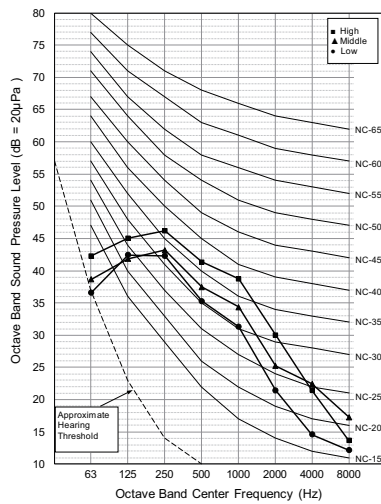

ARNU48GTYA4

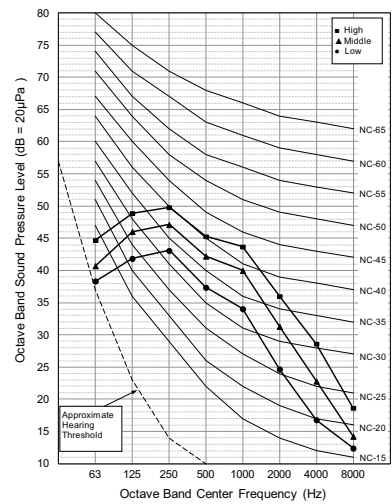

9. Sound Levels

9.2 Sound Power Levels

Note

- Data is valid at diffuse field condition
- Data is valid at nominal operating condition
- Sound level can be increased in static pressure mode or used air guide.
- Sound level will vary depending on a range of factors such as the construction (acoustic absorption coefficient) of particular room in which the equipment is installed.
- Reference acoustic intensity 0dB = $10E-6\mu W/m^2$
- Sound power level is measured on the rated condition in the semi-anechoic rooms by ISO 9614 standard. Therefore, these values can be increased owing to ambient conditions during operation.

Model	Sound Power Levels [dB(A)]		
	H	M	L
ARNU24GTYA4	48	46	43
ARNU36GTYA4	52	48	46
ARNU48GTYA4	56	53	48

ARNU24GTYA4

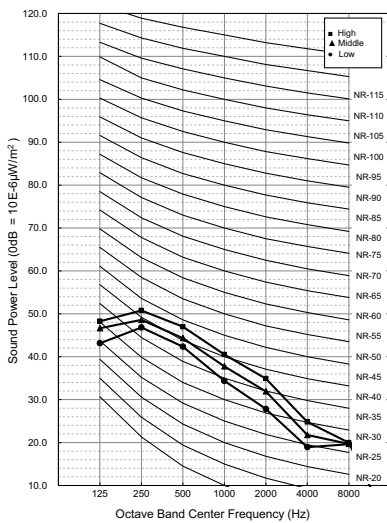

ARNU36GTYA4

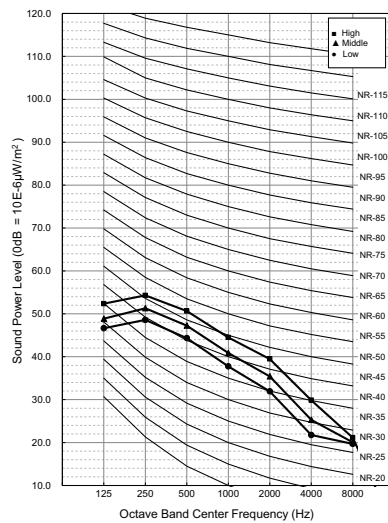

ARNU48GTYA4

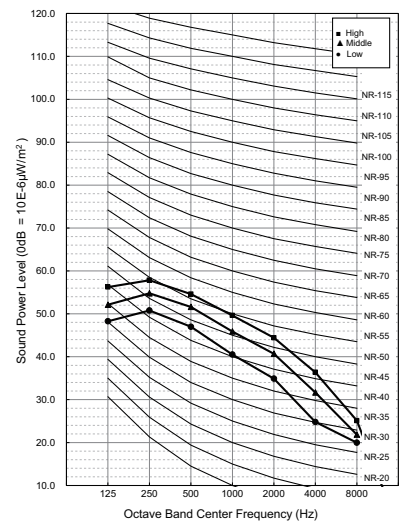

Ceiling Concealed Duct (High Sensible)

- 1. List of functions**
- 2. Specifications**
- 3. Dimensions & Gravity Point**
- 4. Piping Diagrams**
- 5. Wiring Diagrams**
- 6. Capacity Tables**
- 7. External Static Pressure (E.S.P) & Air Flow**
- 8. Electric Characteristics**
- 9. Sound Levels**

1. List of functions

◆ List of functions

Category	Function	ARNU07GM2A4, ARNU09GM2A4, ARNU12GM2A4 ARNU15GM2A4, ARNU18GM3A4, ARNU24GM3A4 ARNU28GM3A4
Air Flow	Air Supply Outlet	1
	Airflow Steps (fan/cool/heat)	3 / 3 / 3
	Fan Speed Auto*	X
	Power Cool/Heat	X / X
	Dry Operation	O
Air Purification	Air Purify	Accessory
	UV-C	Accessory
	Pre-Filter	O
Reliability	Hot Start	O
	Self Diagnosis	O
Convenience	Auto Mode	O
	Auto Dry Operation	O
	Auto Restart	O
	Child Lock*	O
	Group Control*	O
	Sleep Timer	O
	Turn On/Off Reservation	O
	Schedule*	O
	Two Thermistor Control*	O
External On/Off	O	
Installation	Drain Pump	O
	E.S.P. Setting*	O
	Auto E.S.P. Control*	O
Special Functions	Wi-Fi	Accessory

Note

- O : Applied, X : Not Applied, - : Unconfirmed or irrelevant
Embedded : A kit is provided by default for using this function when the product is manufactured.
Accessory : Ordered and purchased separately the accessory package referring to the model name provided and install at field. Accessory line-ups varies by region, so check your local catalogue or local sales material.
- Some functions can be limited by remote controller.
- Selecting a wireless remote controller in case of ducted type indoor units requires either a connection to the wired remote controller (Standard II) or an IR receiver accessory to be connected to the duct in order to receive the signal.
- 'Auto Mode' varies depending on the outdoor unit type.
 - Auto Change Over(Heat Recovery Outdoor Unit)
 - Auto Mode Select(Heat Pump Outdoor Unit)
 - Auto Intensity Control(Cooling Only Outdoor Unit)
- * : These functions need to connect the wired remote controller.

1. List of functions

◆ List of functions

Category	Function	ARNU36GB8A4, ARNU42GB8A4, ARNU48GB8A4
Air Flow	Air Supply Outlet	2
	Airflow Steps (fan/cool/heat)	3 / 3 / 3
	Fan Speed Auto*	X
	Power Cool/Heat	X / X
	Dry Operation	O
Air Purification	Air Purify	X
	UV-C	X
	Pre-Filter	O
Reliability	Hot Start	O
	Self Diagnosis	O
Convenience	Auto Mode	O
	Auto Dry Operation	O
	Auto Restart	O
	Child Lock*	O
	Group Control*	O
	Sleep Timer	O
	Turn On/Off Reservation	O
	Schedule*	O
	Two Thermistor Control*	O
External On/Off	O	
Installation	Drain Pump	O
	E.S.P. Setting*	O
	Auto E.S.P. Control*	X
Special Functions	Wi-Fi	Accessory

Note

- O : Applied, X : Not Applied, - : Unconfirmed or irrelevant
Embedded : A kit is provided by default for using this function when the product is manufactured.
Accessory : Ordered and purchased separately the accessory package referring to the model name provided and install at field. Accessory line-ups varies by region, so check your local catalogue or local sales material.
- Some functions can be limited by remote controller.
- Selecting a wireless remote controller in case of ducted type indoor units requires either a connection to the wired remote controller (Standard II) or an IR receiver accessory to be connected to the duct in order to receive the signal.
- 'Auto Mode' varies depending on the outdoor unit type.
 - Auto Change Over(Heat Recovery Outdoor Unit)
 - Auto Mode Select(Heat Pump Outdoor Unit)
 - Auto Intensity Control(Cooling Only Outdoor Unit)
- * : These functions need to connect the wired remote controller.

1. List of functions

◆ Accessory Compatibility List

Category	Accessory Name	Model Name	Description	ARNU**M2A4 ARNU**M3A4
Remote Controller	Wired - Premium	PREMTA000	-	○
		PREMTA000A	-	○
		PREMTA000B	-	○
	Wired - RS3 (Standard III)	PREMTB100/PREMTB101	White	○
		PREMTBB10/PREMTBB11	Black	○
	Wired - RS2 (Standard II)	PREMTB001	White	○
		PREMTBB01	Black	○
	Wired - Simple	PQRCVCL0QW	White	○
		PQRCVCL0Q	Black	○
	Wired - Simple for Hotel	PQRCHCA0QW	White	○
		PQRCHCA0Q	Black	○
	Wireless	PQWRCQ0FDB	For Cooling only	○
		PQWRHQ0FDB	For Heat pump	○
PWLSSB21C		For Cooling only	○	
PWLSSB21H		For Heat pump	○	
Dry Contact	Simple	PDRYCB000	1 input port, AC 220 - 240V	○
		PDRYCB100	1 input port, AC 24V	○
	Communication	PDRYCB400	2 input port	○
		PDRYCB300	8 input port, For 3rd party Thermostat	○
		PDRYCB320	8 input port, For 3rd Party Thermostat (Analog Input)	○
		PDRYCB500	For 3rd Party Controller (Modbus RTU)	○
Integration Device	Remote Temperature sensor	PQRSTA0	-	○
	Zone Controller	ABZCA	For Duct, 4zone, 220-240V	○
	Group Control wire	PZCWRCG3	Cable Assembly For group control (Y-type cable : 0.25m, cable : 9.6m)	○
ETC	Extension wire	PZCWRC1	Extension wire For IDU-wired remote controller (9.6m)	X
	2-Remo Control Wire	PZCWRC2	-	X
	Wi-Fi Modem	PWFMDD200	-	○
	Wi-Fi Extension cable	PWYREW000	USB Extension cable : 10 m	○
	IR Receiver	PWLRVN000	For wireless remote controller with Duct	○
	Independent Power Module	PRIP0	-	○
	Multi-tenant Power module	PINPMB001	-	○
	Refrigerant Leakage Detector	PRLDNVS0	For R410A only	○
	UVnano Filter Box	PBM13M1UA0	For M1 Chassis	X
		PBM13M2UA0	For M2 Chassis	○
		PBM13M3UA0	For M3 Chassis	○
	High Efficiency Filter (Main Filter of Filter Box)	FBM13M1UA0	For M1 UVnano Filter Box	X
		FBM13M2UA0	For M2 UVnano Filter Box	○
		FBM13M3UA0	For M3 UVnano Filter Box	○
	EEV Kit	PRGK024A0	For Multi V Indoor Unit	X
Auxiliary Heater Relay Kit	PRARH1	For Cassette and Duct Indoor Units	○	

Note

1. ○: Possible, X: Impossible, -: Not applicable, Embedded : Included with product.
2. If there is a difference in development time between the product and the remote controller, some functions cannot be operated.
3. If using Wi-Fi controller, Some advanced functions controlled by remote controller cannot be operated.
4. Selecting a wireless remote controller in case of ducted type indoor units requires either a connection to the wired remote controller (Standard II) or an IR receiver accessory to be connected to the duct in order to receive the signal.
5. If you need more detail, please refer to the **BECON** PDB or the manual of product. (<http://partner.lge.com/global> : Home> Doc.Library> Product > Control(BECON))

1. List of functions

◆ Accessory Compatibility List

Category	Accessory Name	Model Name	Description	ARNU**B8A4
Remote Controller	Wired - Premium	PREMTA000	-	○
		PREMTA000A	-	○
		PREMTA000B	-	○
	Wired - RS3 (Standard III)	PREMTB100/PREMTB10	White	○
		PREMTBB10/PREMTBB11	Black	○
	Wired - RS2 (Standard II)	PREMTB001	White	○
		PREMTBB01	Black	○
	Wired - Simple	PQRCVCL0QW	White	○
		PQRCVCL0Q	Black	○
	Wired - Simple for Hotel	PQRCHCA0QW	White	○
		PQRCHCA0Q	Black	○
	Wireless	PQWRCQ0FDB	For Cooling only	○
		PQWRHQ0FDB	For Heat pump	○
		PWLSSB21C	For Cooling only	○
PWLSSB21H		For Heat pump	○	
Dry Contact	Simple	PDRYCB000	1 input port, AC 220 - 240V	○
		PDRYCB100	1 input port, AC 24V	○
	Communication	PDRYCB400	2 input port	○
		PDRYCB300	8 input port, For 3rd party Thermostat	○
		PDRYCB320	8 input port, For 3rd Party Thermostat (Analog Input)	○
PDRYCB500	For 3rd Party Controller (Modbus RTU)	○		
Integration Device	Remote Temperature sensor	PQRSTA0	-	○
	Zone Controller	ABZCA	For Duct, 4zone, 220-240V	○
	Group Control wire	PZCWRCG3	Cable Assembly For group control (Y-type cable : 0.25m, cable : 9.6m)	○
ETC	Extension wire	PZCWRC1	Extension wire For IDU-wired remote controller (9.6m)	X
	2-Remo Control Wire	PZCWRC2	-	X
	Wi-Fi Modem	PWFMDD200	-	○
	Wi-Fi Extension cable	PWYREW000	USB Extension cable : 10 m	○
	IR Receiver	PWLRVN000	For wireless remote controller with Duct	○
	Independent Power Module	PRIP0	-	○
	Multi-tenant Power module	PINPMB001	-	○
	Refrigerant Leakage Detector	PRLDNVS0	For R410A only	○
	UVnano Filter Box	PBM13M1UA0	For M1 Chassis	X
		PBM13M2UA0	For M2 Chassis	X
		PBM13M3UA0	For M3 Chassis	X
	High Efficiency Filter (Main Filter of Filter Box)	FBM13M1UA0	For M1 UVnano Filter Box	X
		FBM13M2UA0	For M2 UVnano Filter Box	X
FBM13M3UA0		For M3 UVnano Filter Box	X	
EEV Kit	PRGK024A0	For Multi V Indoor Unit	X	
Auxiliary Heater Relay Kit	PRARH1	For Cassette and Duct Indoor Units	○	

Note

1. ○: Possible, X: Impossible, - : Not applicable, Embedded : Included with product.
2. If there is a difference in development time between the product and the remote controller, some functions cannot be operated.
3. If using Wi-Fi controller, Some advanced functions controlled by remote controller cannot be operated.
4. Selecting a wireless remote controller in case of ducted type indoor units requires either a connection to the wired remote controller (Standard II) or an IR receiver accessory to be connected to the duct in order to receive the signal.
5. If you need more detail, please refer to the **BECON** PDB or the manual of product. (<http://partner.lge.com/global> : Home> Doc.Library> Product > Control(BECON))

2. Specifications

Type		Ceiling Concealed Duct - High Sensible		
Model		Unit	ARNU07GM2A4	ARNU09GM2A4
Cooling Capacity		kW	2.2	2.8
		kcal/h	1,900	2,400
		Btu/h	7,500	9,600
Heating Capacity		kW	2.5	3.2
		kcal/h	2,200	2,800
		Btu/h	8,500	10,900
Power Input (H / M / L)		W	32 / 29 / 27	32 / 29 / 27
Casing			Galvanized Steel Plate	Galvanized Steel Plate
Dimensions (WxHxD)	Body	mm	1,250 × 270 × 700	1,250 × 270 × 700
		inch	49-7/32 x 10-5/8 x 27-9/16	49-7/32 x 10-5/8 x 27-9/16
Coil	Rows x Columns x FPI		2 x 13 x 18	2 x 13 x 18
	Face Area	m ²	0.27	0.27
Fan	Type		Sirocco Fan	Sirocco Fan
	Motor Output x Number		W	350 x 1
	Air Flow Rate(H / M / L) (Factory set)	m ³ /min	13.3 / 9.4 / 6.8	13.3 / 9.4 / 6.8
		ft ³ /min	470 / 332 / 240	470 / 332 / 240
	External Static Pressure		mmAq (Pa)	6(59)
	External Static Pressure (Min ~ Max)		mmAq (Pa)	4(39) ~ 18(177)
	Air Flow Rate Range* (Min. ~ Max.)		m ³ /min	6.8 ~ 38.0
			ft ³ /min	240 ~ 1,342
Drive			Direct	
Motor type			BLDC	
Temperature Control			Microprocessor, Thermostat for cooling and heating	
Sound Absorbing Thermal Insulation Material			Foamed polystyrene	Foamed polystyrene
Air Filter			-	-
Safety Device			Fuse	Fuse
Pipe Connections	Liquid Side	mm(inch)	Ø9.52(3/8)	Ø9.52(3/8)
	Gas Side	mm(inch)	Ø15.88(5/8)	Ø15.88(5/8)
	Drain Pipe(Internal Dia.)	mm(inch)	25(1)	25(1)
Net Weight		kg(lbs)	36.0(79)	36.0(79)
Sound Pressure Levels (H / M / L)		dB(A)	33 / 33 / 32	33 / 33 / 32
Sound Power Levels (H / M / L)		dB(A)	52 / 52 / 52	52 / 52 / 52
Power Supply		Ø, V, Hz	1, 220 - 230 - 240, 50/60	1, 220 - 230 - 240, 50/60
Running Current by voltage	Rated	A	0.18 - 0.17 - 0.16	0.18 - 0.17 - 0.16
Maximum Running Current		A	2.30	2.30
Refrigerant	Type		-	R410A / R32
	Additional Charging Amount (CF Value of IDU)		kg(each)	0.35 / 0.29
	Control		-	EEV
Transmission cable		mm ²	1.0~1.5 x 2C	1.0~1.5 x 2C

Note

- Due to our policy of innovation some specifications may be changed without notification.
- Wiring cable size must comply with the applicable local and national code. And "Electric characteristics" chapter should be considered for electrical work and design. Especially the power cable and circuit breaker should be selected in accordance with that.
- Sound pressure level is measured on the rated condition in the anechoic rooms by ISO 3745 standard.
Sound power level is measured on the rated condition in the semi-anechoic rooms by ISO 9614 standard.
Therefore, these values can be increased owing to ambient conditions during operation.
- Capacities are net capacities and based on the following conditions. Refer to the Outdoor Unit Specifications for calculating the real capacity.
 - Cooling : Indoor Ambient Temp. 27°CDB / 19°CWB, Outdoor Ambient Temp. 35°CDB / 24°CWB
 - Heating : Indoor Ambient Temp. 20°CDB / 15°CWB, Outdoor Ambient Temp. 7°CDB / 6°CWB
 - Interconnected Pipe is standard length and difference of Elevation (Outdoor ~ Indoor Unit) is 0m.
- Refrigerant information (type, additional charging amount, etc.) must be applied by refrigerant type of the combined outdoor unit.
Adapt after checking the specifications of outdoor unit.
- Sound levels are measured at 50Pa External Static Pressure condition.
- * : Air flow rate could be different in accordance with External Static Pressure and setting value.

2. Specifications

Type		Ceiling Concealed Duct - High Sensible		
Model		Unit	ARNU12GM2A4	ARNU15GM2A4
Cooling Capacity		kW	3.6	4.5
		kcal/h	3,100	3,900
		Btu/h	12,300	15,400
Heating Capacity		kW	4.0	5.0
		kcal/h	3,400	4,300
		Btu/h	13,600	17,100
Power Input (H / M / L)		W	33 / 30 / 28	33 / 30 / 28
Casing			Galvanized Steel Plate	Galvanized Steel Plate
Dimensions (WxHxD)	Body	mm	1,250 × 270 × 700	1,250 × 270 × 700
		inch	49-7/32 x 10-5/8 x 27-9/16	49-7/32 x 10-5/8 x 27-9/16
Coil	Rows x Columns x FPI		2 x 13 x 18	2 x 13 x 18
	Face Area	m ²	0.27	0.27
Fan	Type		Sirocco Fan	Sirocco Fan
	Motor Output x Number	W	350 x 1	350 x 1
	Air Flow Rate(H / M / L) (Factory set)	m ³ /min	14.8 / 10.2 / 7.4	14.8 / 10.2 / 7.4
		ft ³ /min	523 / 360 / 261	523 / 360 / 261
	External Static Pressure	mmAq (Pa)	6(59)	6(59)
	External Static Pressure (Min ~ Max)	mmAq (Pa)	4(39) ~ 18(177)	4(39) ~ 18(177)
	Air Flow Rate Range* (Min. ~ Max.)	m ³ /min	6.8 ~ 38.0	6.8 ~ 38.0
		ft ³ /min	240 ~ 1,342	240 ~ 1,342
Drive		Direct	Direct	
Motor type		BLDC	BLDC	
Temperature Control			Microprocessor, Thermostat for cooling and heating	
Sound Absorbing Thermal Insulation Material			Foamed polystyrene	Foamed polystyrene
Air Filter			-	-
Safety Device			Fuse	Fuse
Pipe Connections	Liquid Side	mm(inch)	Ø9.52(3/8)	Ø9.52(3/8)
	Gas Side	mm(inch)	Ø15.88(5/8)	Ø15.88(5/8)
	Drain Pipe(Internal Dia.)	mm(inch)	25(1)	25(1)
Net Weight		kg(lbs)	36.0(79)	36.0(79)
Sound Pressure Levels (H / M / L)		dB(A)	34 / 33 / 32	34 / 33 / 32
Sound Power Levels (H / M / L)		dB(A)	53 / 52 / 52	53 / 52 / 52
Power Supply		Ø, V, Hz	1, 220 - 230 - 240, 50/60	1, 220 - 230 - 240, 50/60
Running Current by voltage	Rated	A	0.18 - 0.18 - 0.17	0.18 - 0.18 - 0.17
Maximum Running Current		A	2.30	2.30
Refrigerant	Type		R410A / R32	R410A / R32
	Additional Charging Amount (CF Value of IDU)	kg(each)	0.35 / 0.29	0.35 / 0.29
	Control		EEV	EEV
Transmission cable		mm ²	1.0~1.5 x 2C	1.0~1.5 x 2C

Note

- Due to our policy of innovation some specifications may be changed without notification.
- Wiring cable size must comply with the applicable local and national code. And "Electric characteristics" chapter should be considered for electrical work and design. Especially the power cable and circuit breaker should be selected in accordance with that.
- Sound pressure level is measured on the rated condition in the anechoic rooms by ISO 3745 standard.
Sound power level is measured on the rated condition in the semi-anechoic rooms by ISO 9614 standard.
Therefore, these values can be increased owing to ambient conditions during operation.
- Capacities are net capacities and based on the following conditions. Refer to the Outdoor Unit Specifications for calculating the real capacity.
 - Cooling : Indoor Ambient Temp. 27°CDB / 19°CWB, Outdoor Ambient Temp. 35°CDB / 24°CWB
 - Heating : Indoor Ambient Temp. 20°CDB / 15°CWB, Outdoor Ambient Temp. 7°CDB / 6°CWB
 - Interconnected Pipe is standard length and difference of Elevation (Outdoor ~ Indoor Unit) is 0m.
- Refrigerant information (type, additional charging amount, etc.) must be applied by refrigerant type of the combined outdoor unit.
Adapt after checking the specifications of outdoor unit.
- Sound levels are measured at 50Pa External Static Pressure condition.
- * : Air flow rate could be different in accordance with External Static Pressure and setting value.

2. Specifications

Type		Ceiling Concealed Duct - High Sensible		
Model		Unit	ARNU18GM3A4	ARNU24GM3A4
Cooling Capacity		kW	5.6	7.1
		kcal/h	4,800	6,100
		Btu/h	19,100	24,200
Heating Capacity		kW	6.3	8.0
		kcal/h	5,400	6,900
		Btu/h	21,500	27,300
Power Input (H / M / L)		W	97 / 70 / 51	109 / 83 / 60
Casing			Galvanized Steel Plate	Galvanized Steel Plate
Dimensions (WxHxD)	Body	mm	1,250 × 360 × 700	1,250 × 360 × 700
		inch	49-7/32 x 14-3/16 x 27-9/16	49-7/32 x 14-3/16 x 27-9/16
Coil	Rows x Columns x FPI		3 x 16 x 18	3 x 16 x 18
	Face Area	m ²	0.32	0.32
Fan	Type		Sirocco Fan	Sirocco Fan
	Motor Output x Number		W	500 x 1
	Air Flow Rate(H / M / L) (Factory set)	m ³ /min	32.7 / 26.7 / 23.0	35.5 / 30.6 / 26.2
		ft ³ /min	1,155 / 943 / 812	1,254 / 1081 / 925
	External Static Pressure		mmAq (Pa)	6(59)
	External Static Pressure (Min ~ Max)		mmAq (Pa)	4(39) ~ 20(196)
	Air Flow Rate Range* (Min. ~ Max.)	m ³ /min	23.0 ~ 50.0	23.0 ~ 50.0
		ft ³ /min	812 ~ 1,766	812 ~ 1,766
Drive			Direct	
Motor type			BLDC	
Temperature Control			Microprocessor, Thermostat for cooling and heating	
Sound Absorbing Thermal Insulation Material			Foamed polystyrene	Foamed polystyrene
Air Filter			-	-
Safety Device			Fuse	Fuse
Pipe Connections	Liquid Side	mm(inch)	Ø9.52(3/8)	Ø9.52(3/8)
	Gas Side	mm(inch)	Ø15.88(5/8)	Ø15.88(5/8)
	Drain Pipe(Internal Dia.)	mm(inch)	25(1)	25(1)
Net Weight		kg(lbs)	42.2(93)	42.2(93)
Sound Pressure Levels (H / M / L)		dB(A)	38 / 36 / 34	39 / 37 / 35
Sound Power Levels (H / M / L)		dB(A)	52 / 51 / 50	53 / 52 / 51
Power Supply		Ø, V, Hz	1, 220 - 230 - 240, 50/60	1, 220 - 230 - 240, 50/60
Running Current by voltage	Rated	A	0.59 - 0.56 - 0.54	0.66 - 0.63 - 0.61
Maximum Running Current		A	2.50	2.50
Refrigerant	Type		-	R410A / R32
	Additional Charging Amount (CF Value of IDU)		kg(each)	0.61 / 0.50
	Control		-	EEV
Transmission cable		mm ²	1.0~1.5 x 2C	1.0~1.5 x 2C

Note

- Due to our policy of innovation some specifications may be changed without notification.
- Wiring cable size must comply with the applicable local and national code. And "Electric characteristics" chapter should be considered for electrical work and design. Especially the power cable and circuit breaker should be selected in accordance with that.
- Sound pressure level is measured on the rated condition in the anechoic rooms by ISO 3745 standard.
Sound power level is measured on the rated condition in the semi-anechoic rooms by ISO 9614 standard.
Therefore, these values can be increased owing to ambient conditions during operation.
- Capacities are net capacities and based on the following conditions. Refer to the Outdoor Unit Specifications for calculating the real capacity.
 - Cooling : Indoor Ambient Temp. 27°CDB / 19°CWB, Outdoor Ambient Temp. 35°CDB / 24°CWB
 - Heating : Indoor Ambient Temp. 20°CDB / 15°CWB, Outdoor Ambient Temp. 7°CDB / 6°CWB
 - Interconnected Pipe is standard length and difference of Elevation (Outdoor ~ Indoor Unit) is 0m.
- Refrigerant information (type, additional charging amount, etc.) must be applied by refrigerant type of the combined outdoor unit.
Adapt after checking the specifications of outdoor unit.
- Sound levels are measured at 50Pa External Static Pressure condition.
- * : Air flow rate could be different in accordance with External Static Pressure and setting value.

2. Specifications

Type			Ceiling Concealed Duct - High Sensible		
Model		Unit	ARNU28GM3A4	ARNU36GB8A4	
Cooling Capacity		kW	8.2	10.6	
		kcal/h	7,100	9,100	
		Btu/h	28,000	36,200	
Heating Capacity		kW	9.2	11.9	
		kcal/h	8,000	10,200	
		Btu/h	31,500	40,600	
Power Input (H / M / L)		W	109 / 83 / 60	420 / 403 / 378	
Casing			Galvanized Steel Plate	Galvanized Steel Plate	
Dimensions (WxHxD)	Body	mm	1,250 × 360 × 700	1,562 × 460 × 688	
		inch	49-7/32 × 14-3/16 × 27-9/16	61-1/2 × 18-1/8 × 27-3/32	
Coil	Rows x Columns x FPI		3 x 16 x 18	3 x 21 x 19	
	Face Area	m ²	0.32	0.59	
Fan	Type		Sirocco Fan	Sirocco Fan	
	Motor Output x Number		W	500 x 1	
	Air Flow Rate(H / M / L) (Factory set)	m ³ /min		35.5 / 30.6 / 26.2	49.0 / 37.3 / 30.2
		ft ³ /min		1,254 / 1,081 / 925	1,730 / 1,317 / 1,066
	External Static Pressure		mmAq (Pa)	6(59)	18 (176)
	External Static Pressure (Min ~ Max)		mmAq (Pa)	4(39) ~ 20(196)	9(98) ~ 25(245)
	Air Flow Rate Range* (Min. ~ Max.)	m ³ /min		23.0 ~ 50.0	30.2 ~ 100.0
		ft ³ /min		812 ~ 1,766	1,066 ~ 3,531
Drive			Direct	Direct	
Motor type			BLDC	BLDC	
Temperature Control			Microprocessor, Thermostat for cooling and heating		
Sound Absorbing Thermal Insulation Material			Foamed polystyrene		
Air Filter			-		
Safety Device			Fuse		
Pipe Connections	Liquid Side	mm(inch)	Ø9.52(3/8)	Ø9.52(3/8)	
	Gas Side	mm(inch)	Ø15.88(5/8)	Ø19.05(3/4)	
	Drain Pipe(Internal Dia.)	mm(inch)	25(1)	25(1)	
Net Weight		kg(lbs)	42.2(93)	87(192)	
Sound Pressure Levels (H / M / L)		dB(A)	39 / 37 / 35	46 / 45 / 42	
Sound Power Levels (H / M / L)		dB(A)	53 / 52 / 51	65 / 64 / 62	
Power Supply		Ø, V, Hz	1, 220 - 230 - 240, 50/60	1, 220 - 230 - 240, 50/60	
Running Current by voltage	Rated	A	0.66 - 0.63 - 0.61	2.55 - 2.43 - 2.33	
Maximum Running Current		A	2.50	5.20	
Refrigerant	Type		-	R410A / R32	
	Additional Charging Amount (CF Value of IDU)		kg(each)	0.61 / 0.50	
	Control		-	EEV	
Transmission cable		mm ²	1.0~1.5 x 2C	1.0~1.5 x 2C	

Note

- Due to our policy of innovation some specifications may be changed without notification.
- Wiring cable size must comply with the applicable local and national code. And "Electric characteristics" chapter should be considered for electrical work and design. Especially the power cable and circuit breaker should be selected in accordance with that.
- Sound pressure level is measured on the rated condition in the anechoic rooms by ISO 3745 standard.
Sound power level is measured on the rated condition in the semi-anechoic rooms by ISO 9614 standard.
Therefore, these values can be increased owing to ambient conditions during operation.
- Capacities are net capacities and based on the following conditions. Refer to the Outdoor Unit Specifications for calculating the real capacity.
 - Cooling : Indoor Ambient Temp. 27°CDB / 19°CWB, Outdoor Ambient Temp. 35°CDB / 24°CWB
 - Heating : Indoor Ambient Temp. 20°CDB / 15°CWB, Outdoor Ambient Temp. 7°CDB / 6°CWB
 - Interconnected Pipe is standard length and difference of Elevation (Outdoor ~ Indoor Unit) is 0m.
- Refrigerant information (type, additional charging amount, etc.) must be applied by refrigerant type of the combined outdoor unit.
Adapt after checking the specifications of outdoor unit.
- Sound levels are measured at 50Pa External Static Pressure condition.
- * : Air flow rate could be different in accordance with External Static Pressure and setting value.

2. Specifications

Type			Ceiling Concealed Duct - High Sensible	
Model		Unit	ARNU42GB8A4	ARNU48GB8A4
Cooling Capacity		kW	12.3	14.1
		kcal/h	10,600	12,100
		Btu/h	42,000	48,100
Heating Capacity		kW	13.8	15.9
		kcal/h	11,000	13,200
		Btu/h	47,000	54,200
Power Input (H / M / L)		W	528 / 497 / 465	538 / 505 / 482
Casing			Galvanized Steel Plate	Galvanized Steel Plate
Dimensions (WxHxD)	Body	mm	1,562 x 460 x 688	1,562 x 460 x 688
		inch	61-1/2 x 18-1/8 x 27-3/32	61-1/2 x 18-1/8 x 27-3/32
Coil	Rows x Columns x FPI		3 x 21 x 19	3 x 21 x 19
	Face Area	m ²	0.59	0.59
Fan	Type		Sirocco Fan	Sirocco Fan
	Motor Output x Number		W	375 x 2
	Air Flow Rate(H / M / L) (Factory set)	m ³ /min	54.2 / 41.3 / 31.8	57.2 / 43.0 / 34.0
		ft ³ /min	1,914 / 1,458 / 1,123	2,019 / 1,518 / 1,200
	External Static Pressure		mmAq (Pa)	18 (176)
	External Static Pressure (Min ~ Max)		mmAq (Pa)	9(98) ~ 25(245)
	Air Flow Rate Range* (Min. ~ Max.)		m ³ /min	30.2 ~ 100.0
			ft ³ /min	1,066 ~ 3,531
Drive			Direct	
Motor type			BLDC	
Temperature Control			Microprocessor, Thermostat for cooling and heating	
Sound Absorbing Thermal Insulation Material			Foamed polystyrene	
Air Filter			-	
Safety Device			Fuse	
Pipe Connections	Liquid Side	mm(inch)	Ø9.52(3/8)	Ø9.52(3/8)
	Gas Side	mm(inch)	Ø19.05(3/4)	Ø19.05(3/4)
	Drain Pipe(Internal Dia.)	mm(inch)	25(1)	25(1)
Net Weight		kg(lbs)	87(192)	87(192)
Sound Pressure Levels (H / M / L)		dB(A)	47 / 46 / 43	47 / 46 / 44
Sound Power Levels (H / M / L)		dB(A)	66 / 65 / 63	66 / 65 / 64
Power Supply		Ø, V, Hz	1, 220 - 230 - 240, 50/60	1, 220 - 230 - 240, 50/60
Running Current by voltage	Rated	A	3.20 - 3.06 - 2.93	3.26 - 3.12 - 2.99
Maximum Running Current		A	5.20	5.20
Refrigerant	Type		-	R410A / R32
	Additional Charging Amount (CF Value of IDU)		kg(each)	1.00 / 0.83
	Control		-	EEV
Transmission cable		mm ²	1.0~1.5 x 2C	1.0~1.5 x 2C

Note

- Due to our policy of innovation some specifications may be changed without notification.
- Wiring cable size must comply with the applicable local and national code. And "Electric characteristics" chapter should be considered for electrical work and design. Especially the power cable and circuit breaker should be selected in accordance with that.
- Sound pressure level is measured on the rated condition in the anechoic rooms by ISO 3745 standard.
Sound power level is measured on the rated condition in the semi-anechoic rooms by ISO 9614 standard.
Therefore, these values can be increased owing to ambient conditions during operation.
- Capacities are net capacities and based on the following conditions. Refer to the Outdoor Unit Specifications for calculating the real capacity.
 - Cooling : Indoor Ambient Temp. 27°CDB / 19°CWB, Outdoor Ambient Temp. 35°CDB / 24°CWB
 - Heating : Indoor Ambient Temp. 20°CDB / 15°CWB, Outdoor Ambient Temp. 7°CDB / 6°CWB
 - Interconnected Pipe is standard length and difference of Elevation (Outdoor ~ Indoor Unit) is 0m.
- Refrigerant information (type, additional charging amount, etc.) must be applied by refrigerant type of the combined outdoor unit.
Adapt after checking the specifications of outdoor unit.
- Sound levels are measured at 50Pa External Static Pressure condition.
- * : Air flow rate could be different in accordance with External Static Pressure and setting value.

3. Dimensions & Gravity point

3.1 Dimensional Drawings

ARNU07GM2A4 / ARNU09GM2A4 / ARNU12GM2A4 / ARNU15GM2A4

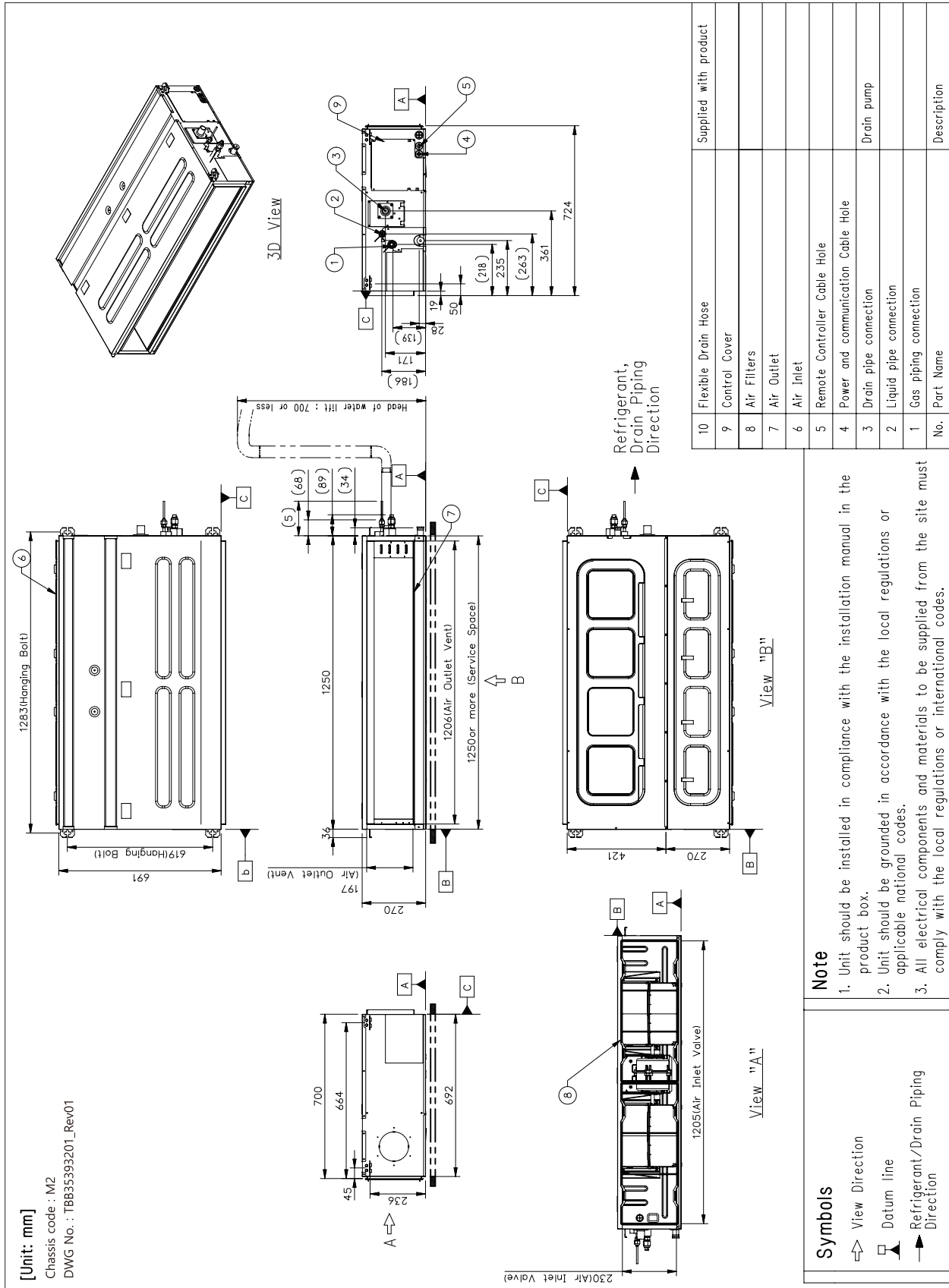

3. Dimensions & Gravity point

ARNU18GM3A4 / ARNU24GM3A4 / ARNU28GM3A4

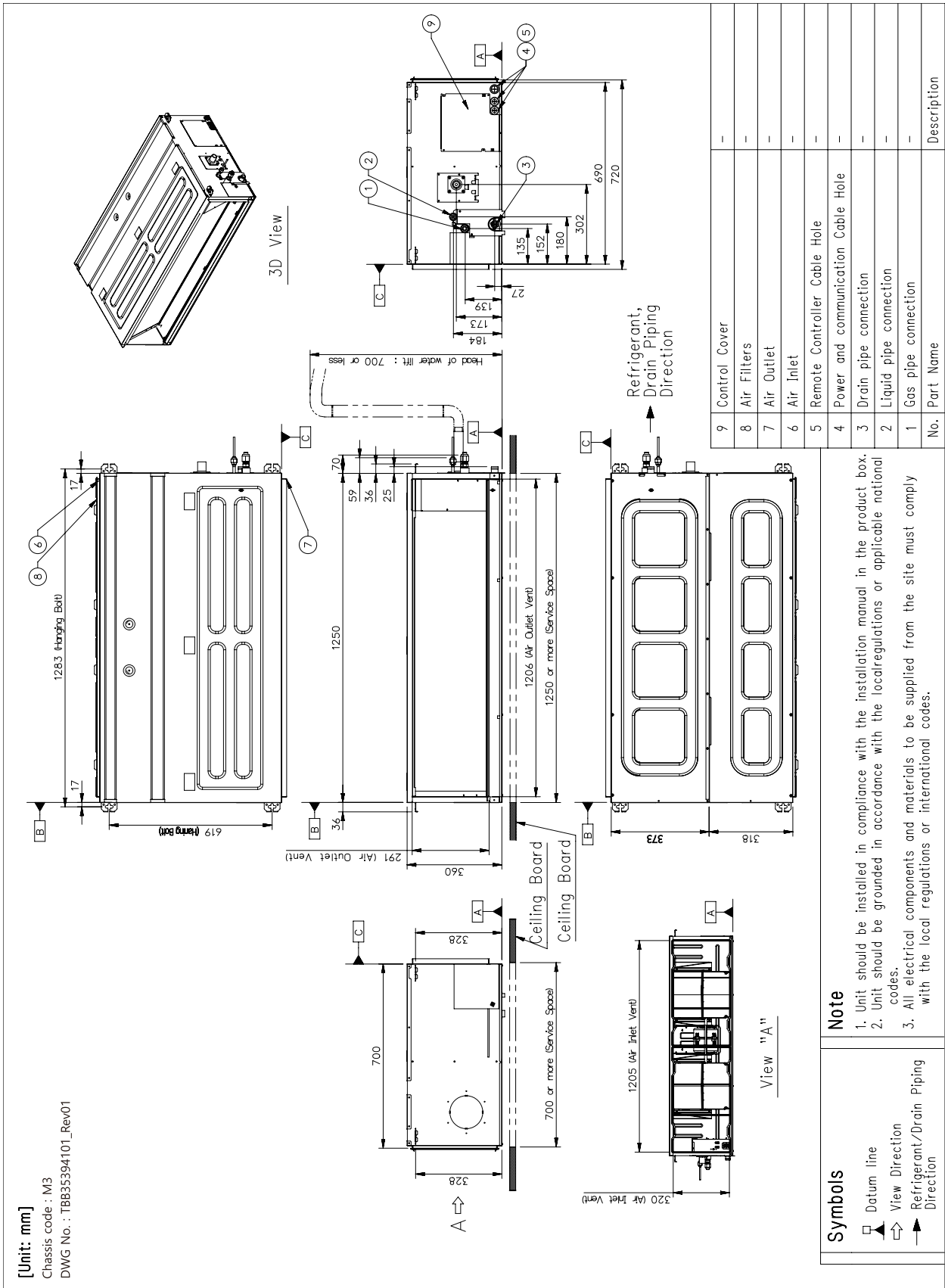

3. Dimensions & Gravity point

ARNU36GB8A4 / ARNU42GB8A4 / ARNU48GB8A4

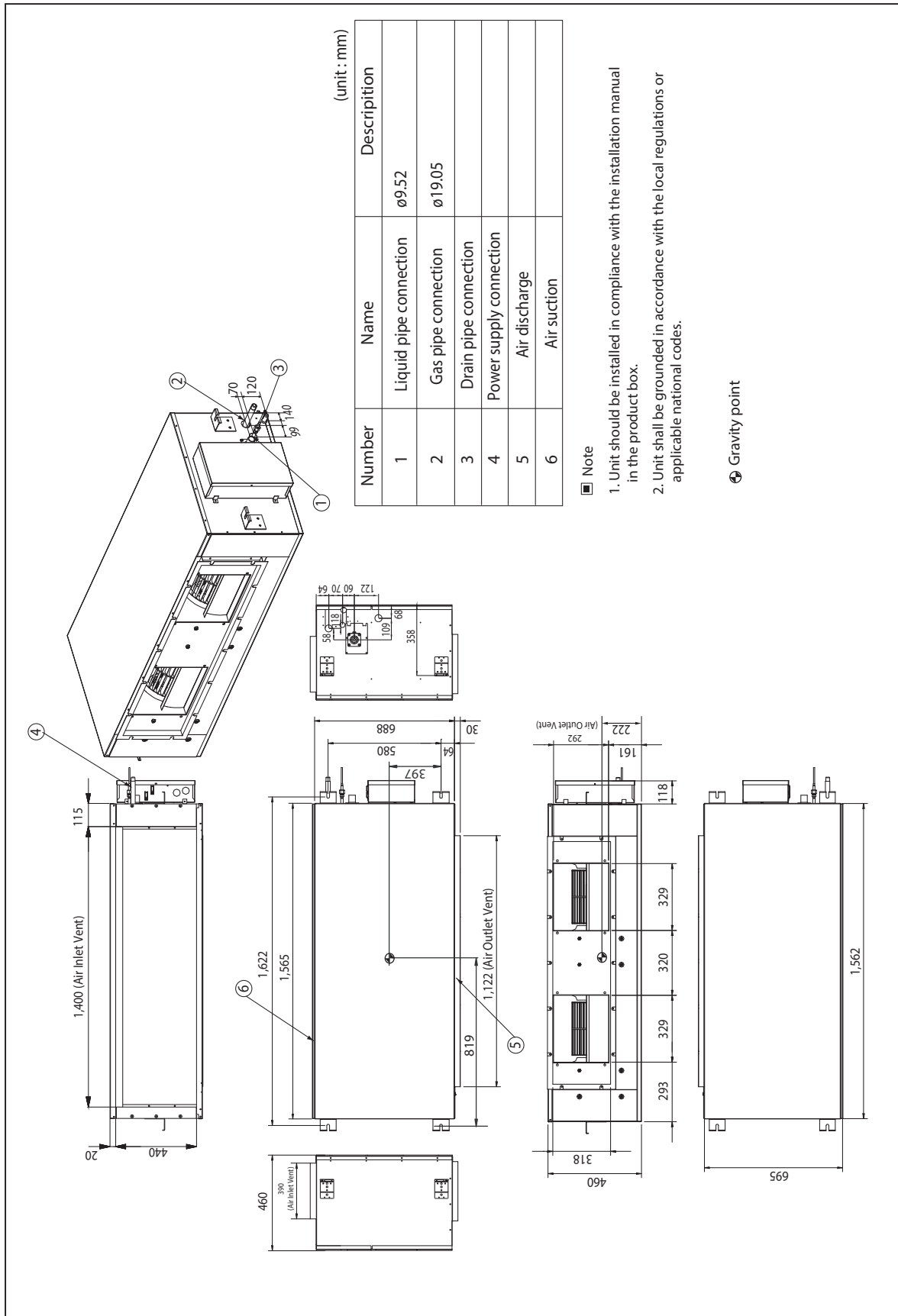

3. Dimensions & Gravity point

3.2 Installation Space

Top view

[Unit: mm(inch)]

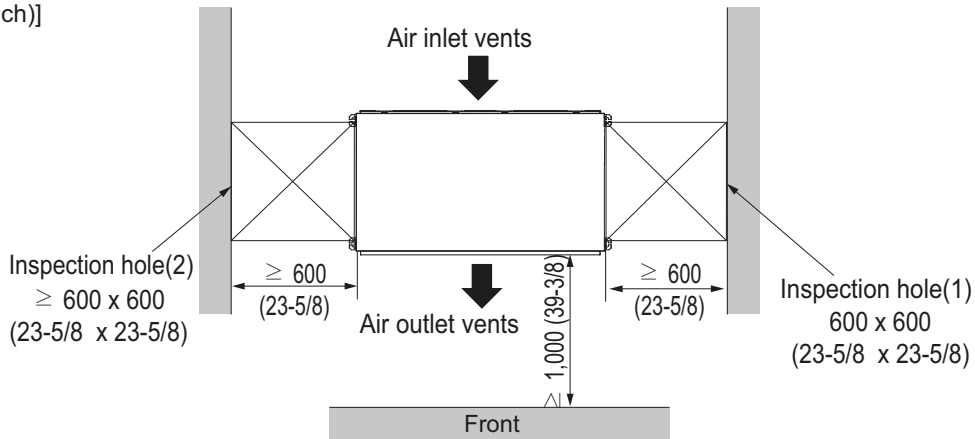

* If distance between false ceiling and actual ceiling is more than 100cm (39-3/8 inch), the number of inspection hole could be decreased to 1. But if that is less than 20cm (7-7/8 inch), the hole size should be more than size of Indoor Unit.

Front view

[Unit: mm(inch)]

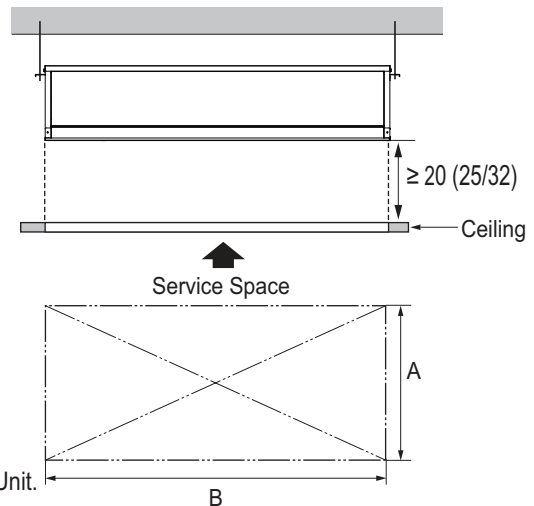
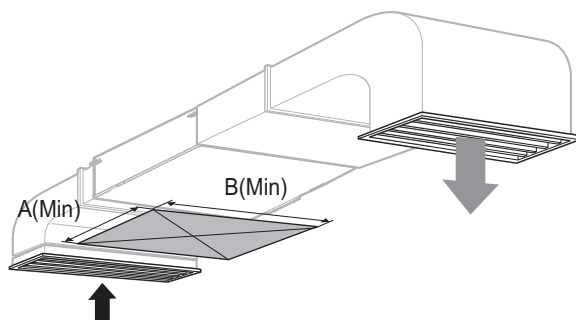

* If distance between false ceiling and actual ceiling is less than 20cm (7-7/8 inch), the hole size should be more than size of Indoor Unit.

* These figures are representative. Actual appearance of indoor unit may be different but clearances will stay the same.

Note

- Places where products are installed should not be any obstacles to the air circulation or installation. Ensure the spaces from the wall, ceiling, or other obstacles.
- According to type of indoor unit, external appearance or installed structure could be different.
- According to product type, model line up, sales region..etc, applicability of each chassis could be different.
- Install certainly the decoration panel. Cool air leakage causes sweating or falling of water-drops.

4. Piping Diagrams

■ M2, M3 Chassis

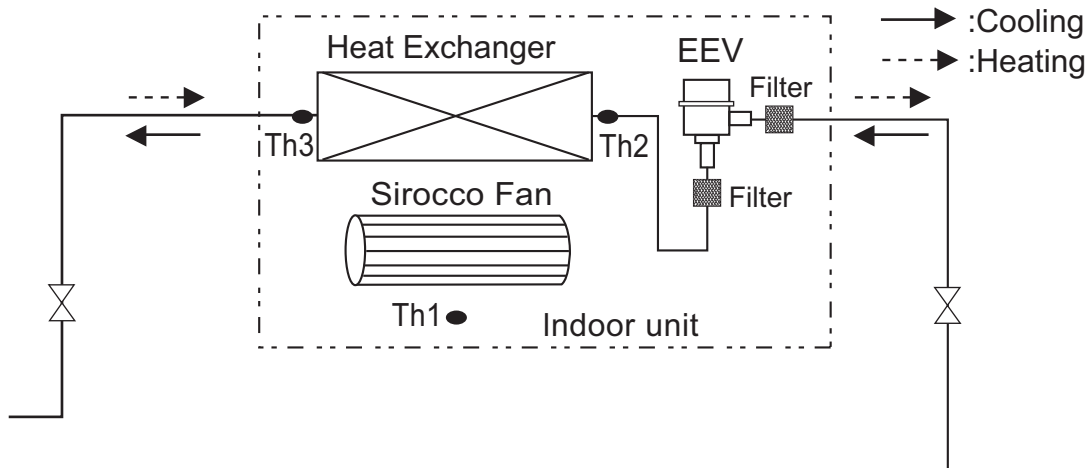

◆ Refrigerant pipe connection port diameter

Model	Gas [mm(inch)]	Liquid [mm(inch)]
ARNU07GM2A4	Ø15.88(5/8)	Ø9.52(3/8)
ARNU09GM2A4	Ø15.88(5/8)	Ø9.52(3/8)
ARNU12GM2A4	Ø15.88(5/8)	Ø9.52(3/8)
ARNU15GM2A4	Ø15.88(5/8)	Ø9.52(3/8)
ARNU18GM3A4	Ø15.88(5/8)	Ø9.52(3/8)
ARNU24GM3A4	Ø15.88(5/8)	Ø9.52(3/8)
ARNU28GM3A4	Ø15.88(5/8)	Ø9.52(3/8)

LOC.	Description
Th1	Thermistor for room air temperature
Th2	Thermistor for pipe in temperature
Th3	Thermistor for pipe out temperature

4. Piping Diagrams

■ B8 Chassis

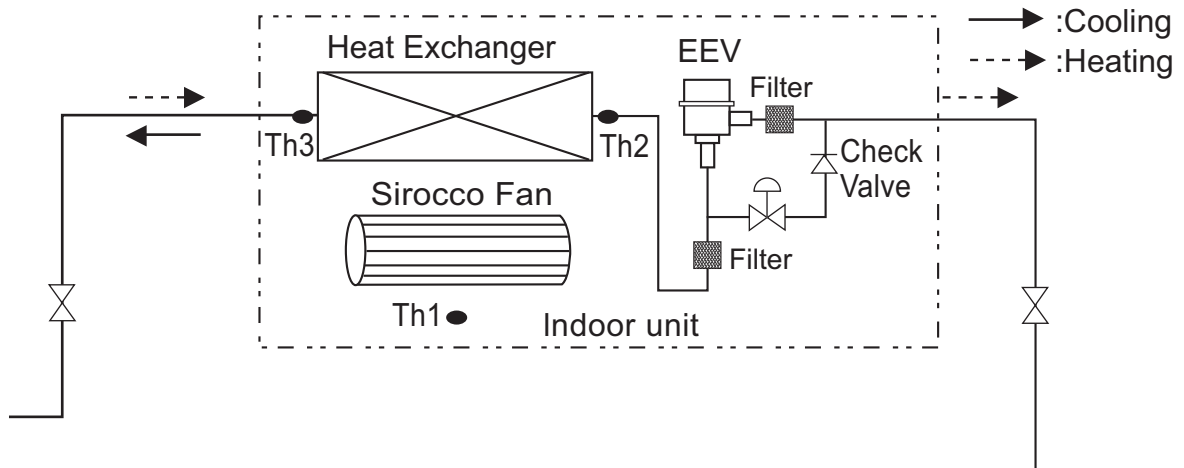

◆ Refrigerant pipe connection port diameter

Model	Gas [mm(inch)]	Liquid [mm(inch)]
ARNU36GB8A4	Ø19.05(3/4)	Ø9.52(3/8)
ARNU42GB8A4	Ø19.05(3/4)	Ø9.52(3/8)
ARNU48GB8A4	Ø19.05(3/4)	Ø9.52(3/8)

* A : Global line-up, C : Brazil line-up only

LOC.	Description	PCB Connector (Color)
Th1	Thermistor for room air temperature	CN-ROOM (Yellow)
Th2	Thermistor for pipe in temperature	CN-PIPE_IN (White)
Th3	Thermistor for pipe out temperature	CN-PIPE_OUT (Red)

5. Wiring Diagrams

M2 Chassis

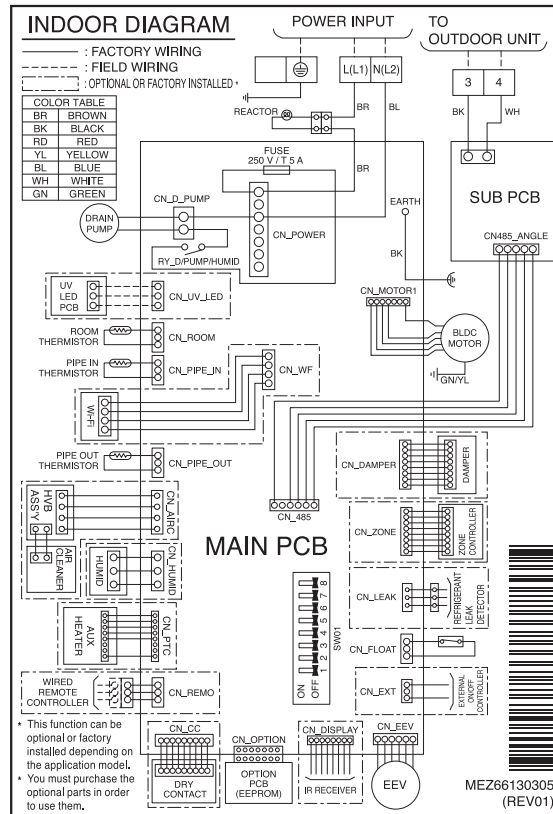

CONNECTOR NUMBER	LOCATION POINT	FUNCTION
CN-POWER	AC Power supply	AC Power line input for indoor controller
CN-MOTOR1	Fan motor output	Motor output of BLDC
CN-MOTOR2	Fan motor output	Motor output of BLDC
CN-D_PUMP	Drain pump output	AC output for drain pump
CN-COM	Communication	Connection between indoor and outdoor
CN-EEV	EEV Output	EEV Control output : connect to EEV directly or through IPM(Independent Power Module)
CN-LEAK	Refrigerant leak detector	Refrigerant leak detector line
CN-FLOAT	Float switch input	Float switch sensing
CN-PIPE_IN	Suction pipe sensor	Pipe in thermistor
CN-PIPE_OUT	Discharge pipe sensor	Pipe out thermistor
CN-ROOM	Room sensor	Room air thermistor
CN-REMO	Remote controller	Remote control line
CN-ZONE	Zontroller	Zone control line
CN-DISPLAY	RF Remote controller	RF Remote control line
CN-CC	Dry contact	Dry contact line
CN-EXT	External On/Off	External On/Off signal input
CN_WF	Wi-Fi Controller	Wifi control line
CN_HUMID	Humidity sensor	Humid sensing
CN_UV_LED	UV LED PCB	UV LED

	Function	Description	Setting Off	Setting On	Default
SW1	Communication	N/A (Default)	-	-	Off
SW2	Cycle	N/A (Default)	-	-	Off
SW3	Group Control	Selection of Master or Slave	Master	Slave	Off
SW4	Dry Contact Mode	Selection of Dry Contact Mode	Wired/Wireless remote controller selection of Manual or Auto operation Mode	Auto	Off
SW5	Installation	Fan continuous operation	Continuous operation Removal	-	Off
SW6	Heater linkage	N/A	-	-	Off
SW7	Ventilator linkage	Selection of Ventilator linkage	Linkage Removal	Working	Off
	Vane selection (Console)	Selection of up/down side Vane	Up side + Down side Vane	Up side Vane Only	
	Region selection	Selection tropical region	General model	Tropical model	
SW8	Etc.	Spare	-	-	Off

5. Wiring Diagrams

 **CAUTION**

For Multi V Models, DIP switch 1, 2, 6, 8 must be set OFF

5. Wiring Diagrams

M3 Chassis

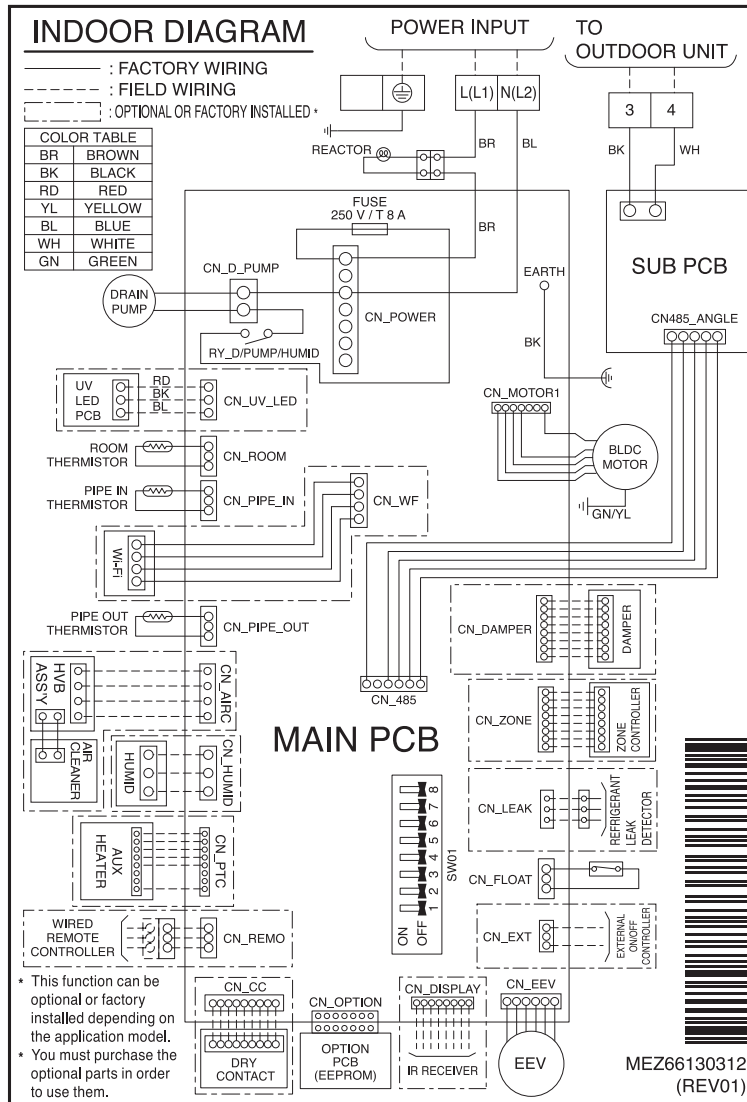

CONNECTOR NUMBER	LOCATION POINT	FUNCTION
CN-POWER	AC Power supply	AC Power line input for indoor controller
CN-MOTOR1	Fan motor output	Motor output of BLDC
CN-MOTOR2	Fan motor output	Motor output of BLDC
CN-D_PUMP	Drain pump output	AC output for drain pump
CN-COM	Communication	Connection between indoor and outdoor
CN-EEV	EEV Output	EEV Control output : connect to EEV directly or through IPM(Independent Power Module)
CN-LEAK	Refrigerant leak detector	Refrigerant leak detector line
CN-FLOAT	Float switch input	Float switch sensing
CN-PIPE_IN	Suction pipe sensor	Pipe in thermistor
CN-PIPE_OUT	Discharge pipe sensor	Pipe out thermistor
CN-ROOM	Room sensor	Room air thermistor
CN-REMO	Remote controller	Remote control line
CN-ZONE	Zontroller	Zone control line
CN-DISPLAY	RF Remote controller	RF Remote control line
CN-CC	Dry contact	Dry contact line
CN-EXT	External On/Off	External On/Off signal input
CN_WF	Wi-Fi Controller	Wifi control line
CN_HUMID	Humidity sensor	Humid sensing
CN_UV_LED	UV LED PCB	UV LED

	Function	Description	Setting Off	Setting On	Default
SW1	Communication	N/A (Default)	-	-	Off
SW2	Cycle	N/A (Default)	-	-	Off

5. Wiring Diagrams

	Function	Description	Setting Off	Setting On	Default
SW3	Group Control	Selection of Master or Slave	Master	Slave	Off
SW4	Dry Contact Mode	Selection of Dry Contact Mode	Wired/Wireless remote controller selection of Manual or Auto operation Mode	Auto	Off
SW5	Installation	Fan continuous operation	Continuous operation Removal	-	Off
SW6	Heater linkage	N/A	-	-	Off
SW7	Ventilator linkage	Selection of Ventilator linkage	Linkage Removal	Working	Off
	Vane selection (Console)	Selection of up/down side Vane	Up side + Down side Vane	Up side Vane Only	
	Region selection	Selection tropical region	General model	Tropical model	
SW8	Etc.	Spare	-	-	Off

CAUTION

For Multi V Models, DIP switch 1, 2, 6, 8 must be set OFF

5. Wiring Diagrams

B8 Chassis

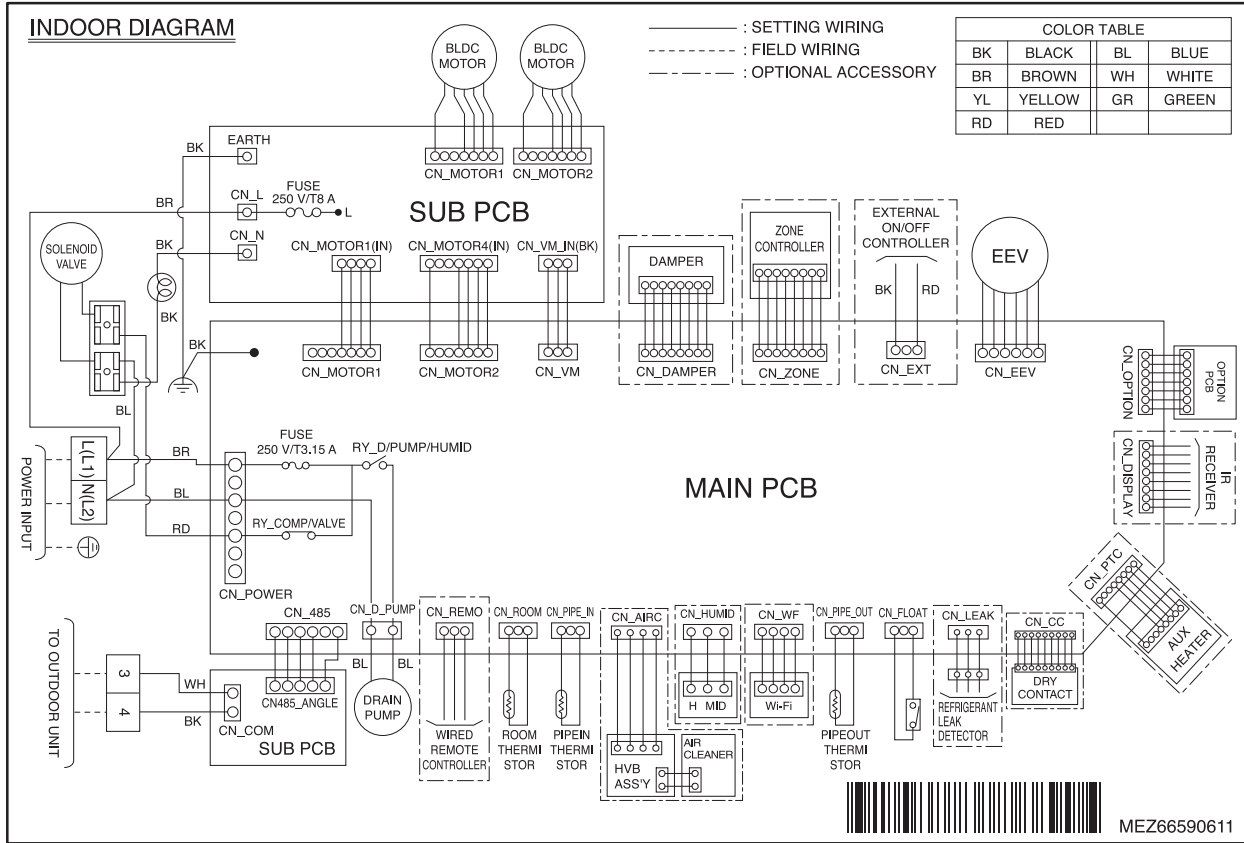

CONNECTOR NUMBER	LOCATION POINT	FUNCTION
CN-POWER	AC Power supply	AC Power line input for indoor controller
CN-MOTOR1, CN-MOTOR2	Fan motor output	Motor output of BLDC
CN-D/PUMP	Drain pump output	AC Output for drain pump
CN-COM	Communication	Connection between indoor and outdoor
CN-EEV	EEV Output	EEV Control output : connect to EEV directly or through IPM(Independent Power Module)
CN-LEAK	Refrigerant leak detector	Refrigerant leak detector line
CN-FLOAT	Float switch input	Float switch sensing
CN-PIPE/IN	Suction pipe sensor	Pipe in thermistor
CN-PIPE/OUT	Discharge pipe sensor	Pipe out thermistor
CN-ROOM	Room sensor	Room thermistor
CN-REMO	Remote controller	Remote control line
CN-CC	Dry contact	Dry contact line
CN-DISPLAY	RF Remocon	RF Remocon receiver
CN-OPTION	Option PCB	Option PCB connector
CN-ZONE	Zone controller	Zone controller line
CN-EXT	External On/Off	External On/Off signal input
CN_WF	Wi-Fi Controller	Wifi control line
CN_HUMID	Humid sensor	Humid sensing

5. Wiring Diagrams

	Function	Description	Setting Off	Setting On	Default
SW1	Communication	N/A (Default)	-	-	Off
SW2	Cycle	N/A (Default)	-	-	Off
SW3	Group Control	Selection of Master or Slave	Master	Slave	Off
SW4	Dry Contact Mode	Selection of Dry Contact Mode	Wired/Wireless remote controller selection of Manual or Auto operation Mode	Auto	Off
SW5	Installation	Fan continuous operation	Continuous operation Removal	-	Off
SW6	Heater linkage	N/A	-	-	Off
SW7	Ventilator linkage	Selection of Ventilator linkage	Linkage Removal	Working	Off
	Vane selection (Console)	Selection of up/down side Vane	Up side + Down side Vane	Up side Vane Only	
	Region selection	Selection tropical region	General model	Tropical model	
SW8	Etc.	Spare	-	-	Off

CAUTION

For Multi V Models, DIP switch 1, 2, 6, 8 must be set OFF

6. Capacity Tables

■ Cooling Capacity

Nominal Capacity (kBtu/h) [Capacity Index (kW)]	Indoor air temp. (DB/WB, °C)													
	20		23		26		27		28		30		32	
	14		16		18		19		20		22		24	
	TC	SHC	TC	SHC	TC	SHC	TC	SHC	TC	SHC	TC	SHC	TC	SHC
7 [2.2]	1.5	1.5	1.8	1.8	2.0	2.0	2.2	2.1	2.4	2.2	2.4	2.1	2.4	1.9
9 [2.8]	1.9	1.9	2.2	2.2	2.6	2.6	2.8	2.7	3.0	2.8	3.0	2.7	3.1	2.4
12 [3.6]	2.4	2.4	2.9	2.9	3.3	3.3	3.6	3.5	3.9	3.6	3.9	3.4	4.0	3.1
15 [4.5]	3.0	3.0	3.6	3.5	4.2	4.0	4.5	4.0	4.8	4.1	4.9	4.0	4.9	3.9
18 [5.6]	3.8	3.8	4.5	4.5	5.2	5.2	5.6	5.3	6.0	5.5	6.1	5.2	6.2	4.7
24 [7.1]	4.8	4.8	5.7	5.7	6.6	6.5	7.1	6.6	7.6	6.9	7.7	6.5	7.8	6.0
28 [8.2]	5.5	5.5	6.6	6.6	7.6	7.3	8.2	7.5	8.8	7.8	8.9	7.3	9.0	6.7
36 [10.6]	7.2	7.2	8.5	8.5	9.9	9.9	10.6	10.1	11.3	10.5	11.5	9.9	11.6	9.1
42 [12.3]	8.3	8.3	9.9	9.9	11.4	11.4	12.3	11.7	13.2	12.1	13.3	11.5	13.5	10.5
48 [14.1]	9.5	9.5	11.3	11.3	13.1	13.1	14.1	13.4	15.1	13.9	15.3	13.1	15.5	12.1

Note

1. TC: Total Capacity(kW), SHC: Sensible Heat Capacity(kW)
2. Capacity tables show the average value of conditions which may occur.
3. Refer to Capacity tables and correction factor in the outdoor unit PDB for the actual performance data of each indoor unit and outdoor unit combination.

■ Heating Capacity

Nominal Capacity (kBtu/h) [Capacity Index (kW)]	Indoor air temp. (DB, °C)					
	16	18	20	21	22	24
	TC	TC	TC	TC	TC	TC
7 [2.2]	2.8	2.7	2.5	2.4	2.3	2.2
9 [2.8]	3.6	3.4	3.2	3.1	3.0	2.8
12 [3.6]	4.5	4.3	4.0	3.9	3.7	3.5
15 [4.5]	5.6	5.3	5.0	4.8	4.7	4.4
18 [5.6]	7.1	6.7	6.3	6.1	5.9	5.5
24 [7.1]	9.0	8.5	8.0	7.7	7.5	7.0
28 [8.2]	10.4	9.8	9.2	8.9	8.6	8.0
36 [10.6]	13.4	12.7	11.9	11.5	11.1	10.4
42 [12.3]	15.6	14.7	13.8	13.4	12.9	12.0
48 [14.1]	17.9	16.9	15.9	15.4	14.9	13.9

Note

1. TC: Total Capacity(kW)
2. Capacity tables show the average value of conditions which may occur.
3. Refer to Capacity tables and correction factor in the outdoor unit PDB for the actual performance data of each indoor unit and outdoor unit combination.

7. External Static Pressure(E.S.P) & Air Flow

◆ ARNU07GM2A4, ARNU09GM2A4

PQ Curve

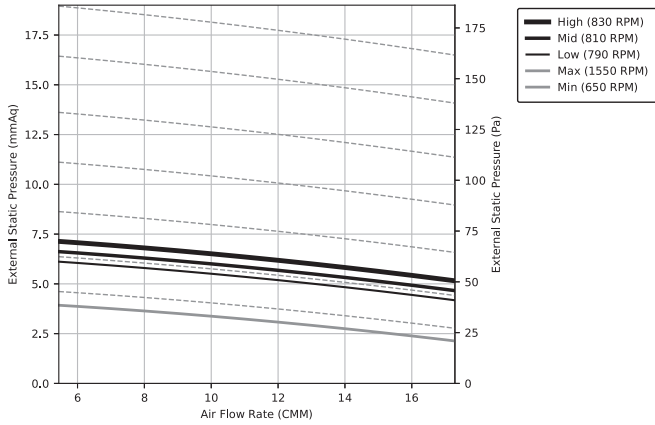

Auto E.S.P Setting Range

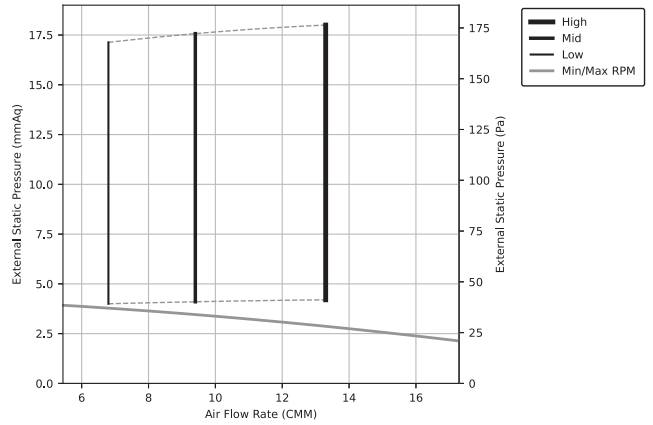

◆ ARNU12GM2A4, ARNU15GM2A4

PQ Curve

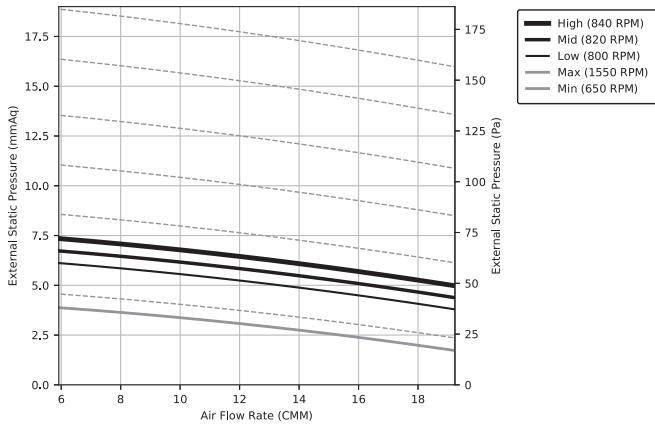

Auto E.S.P Setting Range

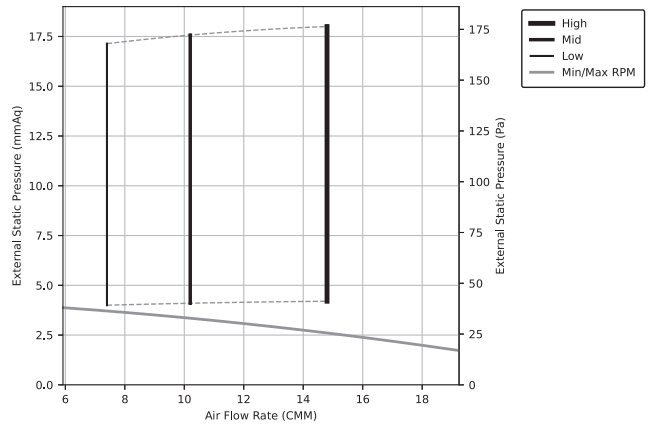

Note

1. Each dash line represents for each 100 RPM step
2. If operation range is out of auto E.S.P setting range, air flow rate should be adjusted manually by wired remotecontroller. (ESP Set Value = RPM / 10)
For more information, please see the installation manual.
3. The above P-Q Curve shows available E.S.P. range. If the E.S.P value is out of min/max RPM at desired air flow, indoor components could be failed and performance would be decreased.
4. Automatic constant air volume is a function that controls air volume automatically when installation, and the air volume is not set automatically during operation.

7. External Static Pressure(E.S.P) & Air Flow

◆ ARNU18GM3A4

PQ Curve

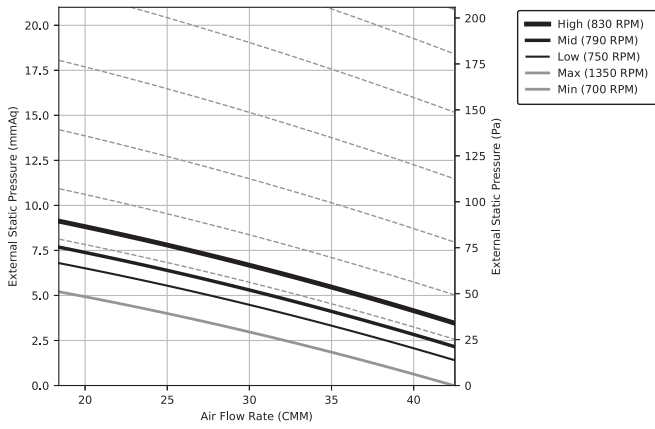

Auto E.S.P Setting Range

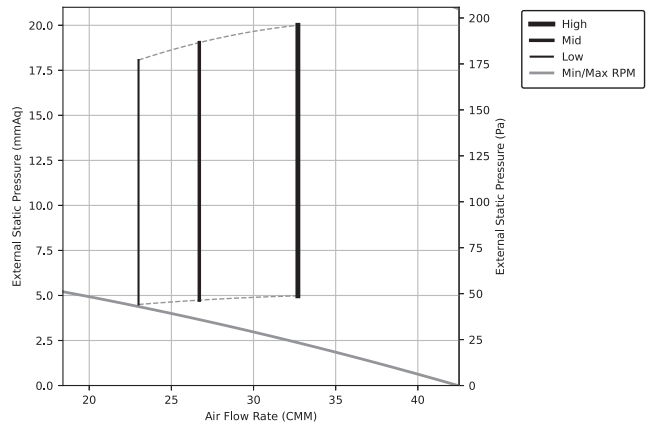

◆ ARNU24GM3A4, ARNU28GM3A4

PQ Curve

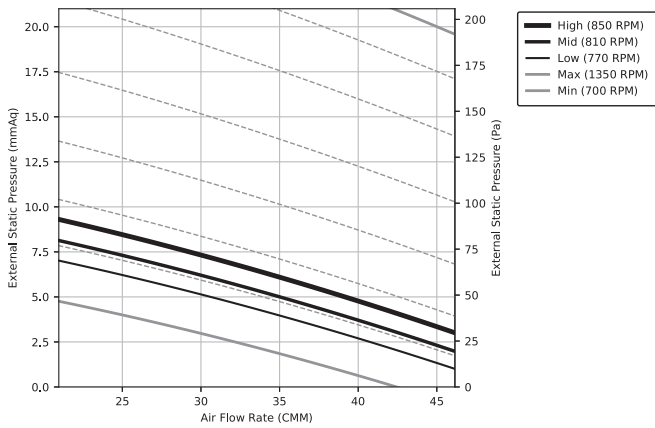

Auto E.S.P Setting Range

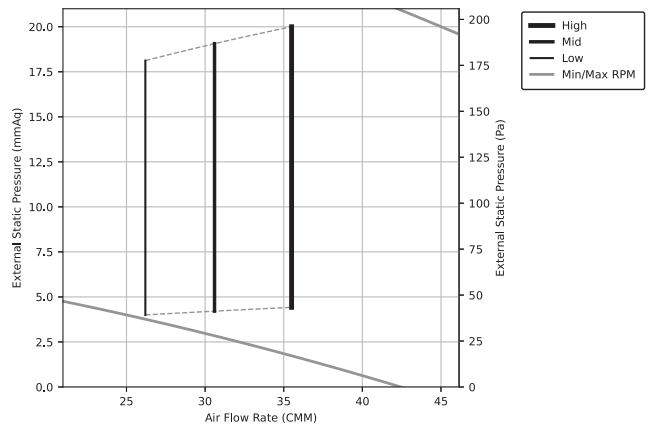

Note

1. Each dash line represents for each 100 RPM step
2. If operation range is out of auto E.S.P setting range, air flow rate should be adjusted manually by wired remotecontroller. (ESP Set Value = RPM / 10)
For more information, please see the installation manual.
3. The above P-Q Curve shows available E.S.P. range. If the E.S.P value is out of min/max RPM at desired air flow, indoor components could be failed and performance would be decreased.
4. Automatic constant air volume is a function that controls air volume automatically when installation, and the air volume is not set automatically during operation.

7. External Static Pressure(E.S.P) & Air Flow

◆ ARNU36GB8A4, ARNU42GB8A4, ARNU48GB8A4

Setting Value	Static Pressure(mmAq(Pa))											
	3(29)	4(39)	5(49)	6(59)	9(88)	12(118)	15(147)	18(177)	20(196)	22(216)	23(226)	25(245)
	Air Flow Rate (m³/min)											
50	40.3	36.2	-	-	-	-	-	-	-	-	-	-
55	48.8	44.2	36.4	-	-	-	-	-	-	-	-	-
60	54.9	50.2	49.7	45.0	-	-	-	-	-	-	-	-
65	62.6	60.4	55.1	52.9	-	-	-	-	-	-	-	-
70	67.9	64.5	62.1	60.7	47.1	-	-	-	-	-	-	-
75	75.5	72.2	69.0	68.5	56.9	44.7	-	-	-	-	-	-
80	82.6	80.9	76.6	75.4	69.7	55.2	-	-	-	-	-	-
85	88.8	85.9	82.0	81.6	78.6	67.4	55.9	-	-	-	-	-
91	94.7	93.0	90.4	90.2	87.1	78.9	67.6	54.2	-	-	-	-
95	-	-	-	-	-	86.1	77.0	66.4	50.6	30.0	-	-
100	-	-	-	-	-	-	84.9	75.9	69.5	60.8	43.1	-
105	-	-	-	-	-	-	-	81.1	77.4	72.0	67.9	51.3

Note

1. The above table shows the correlation between the air rates and E.S.P.
2. The set value of the remote controller is proportional to the RPM of the blower and can be changed by the wired remote controller operation. For more information on how to change it, refer to the manual included with the remote controller or product.
3. The above table shows the available E.S.P range. If the E.S.P values of the installed indoor system is less or more than mentioned in the table, indoor components could be failed and performance would be decreased.
4. Refer to the installation manual included with the how to set E.S.P.

◆ Fan Performance (ARNU36/42/48GB8A4)

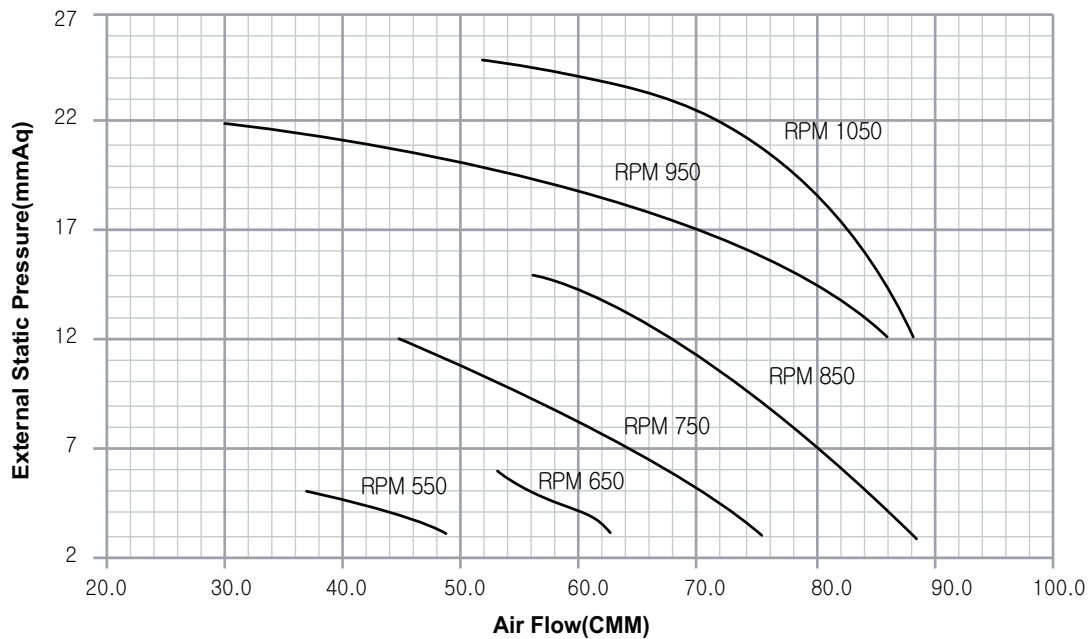

7. External Static Pressure(E.S.P) & Air Flow

■ Lower and Upper Limit of External Static Pressure

◆ ARNU07GM2A4, ARNU09GM2A4, ARNU12GM2A4, ARNU15GM2A4

Capacity	Mode		Set value	Standard ESP (mmAq(Pa))	CMM	Lower Limit of External Static Pressure(mmAq(Pa))	Upper Limit of External Static Pressure(mmAq(Pa))
7k	High (factory set)	HI	83	6(59)	13.3	4(39)	18(177)
		Mid	81		9.4		
		Low	79		6.8		
	Standard	HI	81	5(49)	13.3	4(39)	18(177)
		Mid	79		9.4		
		Low	77		6.8		
9k	High (factory set)	HI	83	6(59)	13.3	4(39)	18(177)
		Mid	81		9.4		
		Low	79		6.8		
	Standard	HI	81	5(49)	13.3	4(39)	18(177)
		Mid	79		9.4		
		Low	77		6.8		
12k	High (factory set)	HI	84	6(59)	14.8	4(39)	18(177)
		Mid	82		10.2		
		Low	80		7.4		
	Standard	HI	82	5(49)	14.8	4(39)	18(177)
		Mid	80		10.2		
		Low	78		7.4		
15k	High (factory set)	HI	84	6(59)	14.8	4(39)	18(177)
		Mid	82		10.2		
		Low	80		7.4		
	Standard	HI	82	5(49)	14.8	4(39)	18(177)
		Mid	80		10.2		
		Low	78		7.4		

Note

1. The above table shows the available E.S.P range. If the E.S.P values of the installed indoor system is less or more than mentioned in the table, indoor components could be failed and performance would be decreased.

◆ ARNU18GM3A4, ARNU24GM3A4, ARNU28GM3A4

Capacity	Mode		Set value	Standard ESP (mmAq(Pa))	CMM	Lower Limit of External Static Pressure(mmAq(Pa))	Upper Limit of External Static Pressure(mmAq(Pa))
18k	High (factory set)	HI	83	6(59)	32.7	4(39)	20(196)
		Mid	79		26.7		
		Low	75		23.0		
	Standard	HI	80	5(49)	32.7	4(39)	20(196)
		Mid	76		26.7		
		Low	70		23.0		
24k	High (factory set)	HI	85	6(59)	35.5	4(39)	20(196)
		Mid	81		30.6		
		Low	77		26.2		
	Standard	HI	83	5(49)	35.5	4(39)	20(196)
		Mid	79		30.6		
		Low	75		26.2		
28k	High (factory set)	HI	85	6(59)	35.5	4(39)	20(196)
		Mid	81		30.6		
		Low	77		26.2		
	Standard	HI	83	5(49)	35.5	4(39)	20(196)
		Mid	79		30.6		
		Low	75		26.2		

Note

1. The above table shows the available E.S.P range. If the E.S.P values of the installed indoor system is less or more than mentioned in the table, indoor components could be failed and performance would be decreased.

7. External Static Pressure(E.S.P) & Air Flow

◆ ARNU36GB8A4, ARNU42GB8A4, ARNU48GB8A4

Capacity	Mode		Set value	Standard ESP (mmAq(Pa))	CMM	Lower Limit of External Static Pressure(mmAq(Pa))	Upper Limit of External Static Pressure(mmAq(Pa))
36k	High (factory set)	HI	90	18(176)	49.0	9(88)	25(245)
		Mid	87		37.3		
		Low	84		30.2		
	Standard	HI	72	9(88)	53.7	9(88)	25(245)
		Mid	69		49.5		
		Low	66		43.9		
42k	High (factory set)	HI	91	18(176)	54.2	9(88)	25(245)
		Mid	88		41.3		
		Low	85		31.8		
	Standard	HI	73	9(88)	55.6	9(88)	25(245)
		Mid	70		50.6		
		Low	67		45.0		
48k	High (factory set)	HI	92	18(176)	57.2	9(88)	25(245)
		Mid	89		43.0		
		Low	86		34.0		
	Standard	HI	74	9(88)	58.0	9(88)	25(245)
		Mid	71		52.3		
		Low	68		47.3		

Note

1. The above table shows the available E.S.P range. If the E.S.P values of the installed indoor system is less or more than mentioned in the table, indoor components could be failed and performance would be decreased.

8. Electric Characteristics

Unit					Power Supply	IFM		PI	
Model	Type	Hz	Volts	Voltage Range	MCA	kW	FLA	cooling	Heating
ARNU07GM2A4	M2	50	220-240	Max:264 Min:198	2.90	0.350	2.30	430	430
ARNU09GM2A4	M2				2.90	0.350	2.30	430	430
ARNU12GM2A4	M2				2.90	0.350	2.30	430	430
ARNU15GM2A4	M2				2.90	0.350	2.30	430	430
ARNU18GM3A4	M3				3.10	0.500	2.50	650	650
ARNU24GM3A4	M3				3.10	0.500	2.50	650	650
ARNU28GM3A4	M3				3.10	0.500	2.50	650	650
ARNU36GB8A4	B8				6.50	0.750	5.20	800	800
ARNU42GB8A4	B8				6.50	0.750	5.20	800	800
ARNU48GB8A4	B8				6.50	0.750	5.20	800	800
ARNU07GM2A4	M2	60	220	Max:242 Min:198	2.90	0.350	2.30	430	430
ARNU09GM2A4	M2				2.90	0.350	2.30	430	430
ARNU12GM2A4	M2				2.90	0.350	2.30	430	430
ARNU15GM2A4	M2				2.90	0.350	2.30	430	430
ARNU18GM3A4	M3				3.10	0.500	2.50	650	650
ARNU24GM3A4	M3				3.10	0.500	2.50	650	650
ARNU28GM3A4	M3				3.10	0.500	2.50	650	650
ARNU36GB8A4	B8				6.50	0.750	5.20	800	800
ARNU42GB8A4	B8				6.50	0.750	5.20	800	800
ARNU48GB8A4	B8				6.50	0.750	5.20	800	800

Symbols

MCA : Minimum Circuit Amperes (A)

kW : Fan Motor Rated Output (kW)

FLA : Full Load Amperes (A)

IFM : Indoor Fan Motor

PI : Maximum Power Input (W)

Note

- Voltage range
Units are suitable for use on electrical systems where voltage supplied to unit terminals is not below or above the listed range limits.
- Maximum allowable voltage unbalance between phases is 2%.
- MCA/MFA
MCA=1.25 x FLA
MFA = 1.1 x MCA, MFA ≤ 4 x FLA
(If MFA is smaller than minimum standard value, Use minimum standard value in region for selecting circuit breaker.)
- Select wire size based on the MCA
- Instead of fuse, use Circuit Breaker.

9. Sound Levels

9.1 Sound Pressure Levels

Overall

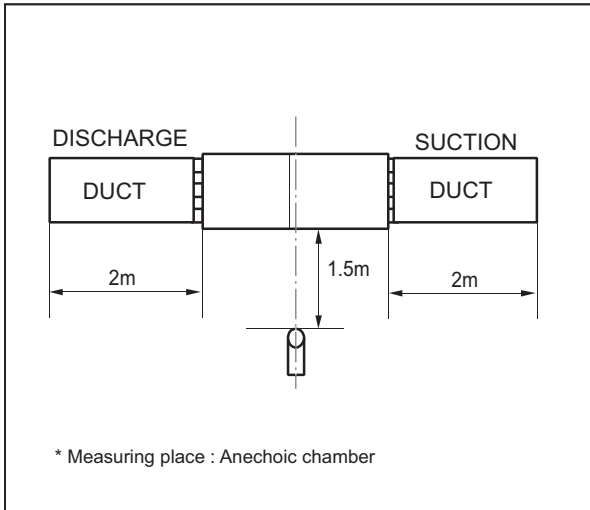

Note

1. Sound measured at some distance away from the center of the unit.
2. Data is valid at free field condition.
3. Reference acoustic pressure 0dB = 20µPa.
4. Data is valid at nominal operation condition.
Refer to the Model Specifications for nominal conditions (Power source and Ambient temperature, etc)
5. Sound levels can be increased in accordance with installation and operating conditions. (Static pressure mode, used air guide, Room target temperature setting, etc)
6. Sound level will vary depending on a range of factors such as the construction (acoustic absorption coefficient) of particular room in which the equipment is installed.
7. Sound pressure level is measured on the rated condition in the anechoic rooms by ISO 3745 standard.
Therefore, these values can be increased owing to ambient conditions during operation.

Model	Sound Pressure Levels [dB(A),H-M-L]				
	External Static Pressure [Pa]				
	39	49	59	147	177
ARNU07GM2A4 ARNU09GM2A4	32-31-29	33-33-32	38-37-36	38-37-36	42-42-41
ARNU12GM2A4 ARNU15GM2A4	32-32-29	34-33-32	38-37-36	38-37-37	43-42-41

Sound Pressure Level (39Pa)

**ARNU07GM2A4
ARNU09GM2A4**

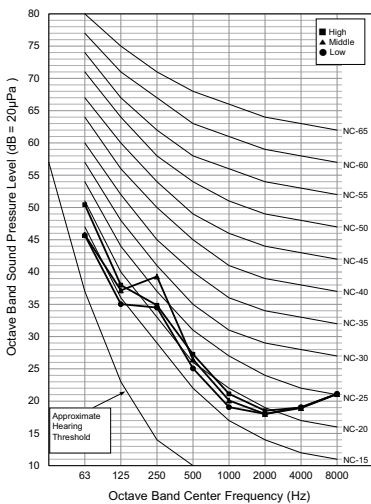

**ARNU12GM2A4
ARNU15GM2A4**

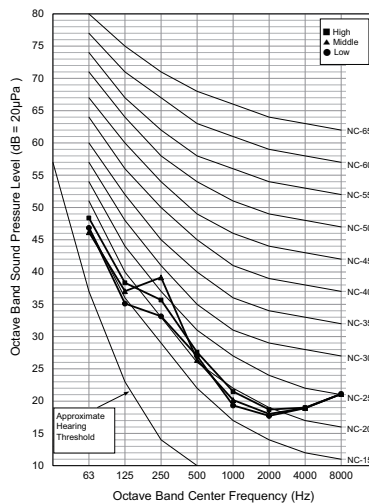

9. Sound Levels

■ Sound Pressure Level (49Pa)

**ARNU07GM2A4
ARNU09GM2A4**

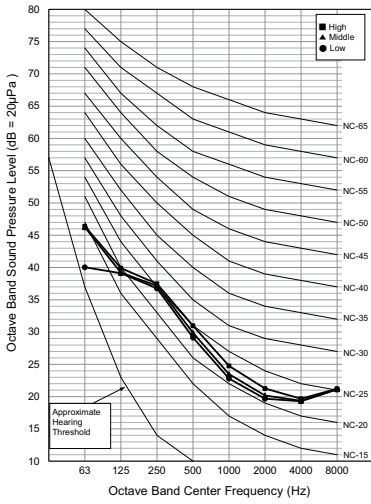

**ARNU12GM2A4
ARNU15GM2A4**

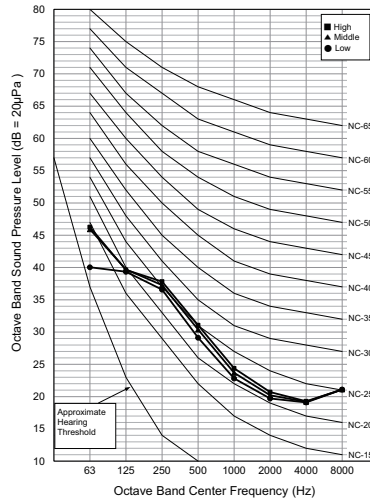

■ Sound Pressure Level (59Pa)

**ARNU07GM2A4
ARNU09GM2A4**

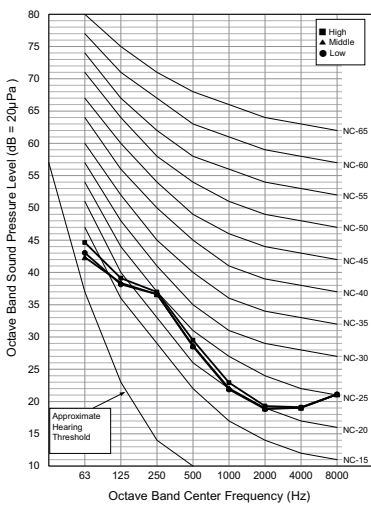

**ARNU12GM2A4
ARNU15GM2A4**

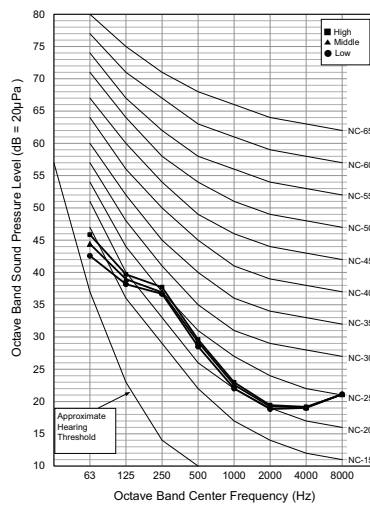

9. Sound Levels

■ Sound Pressure Level (147Pa)

**ARNU07GM2A4
ARNU09GM2A4**

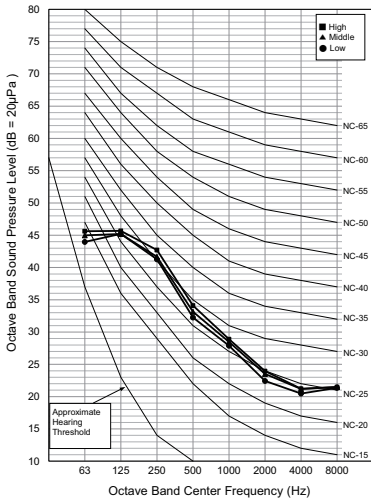

**ARNU12GM2A4
ARNU15GM2A4**

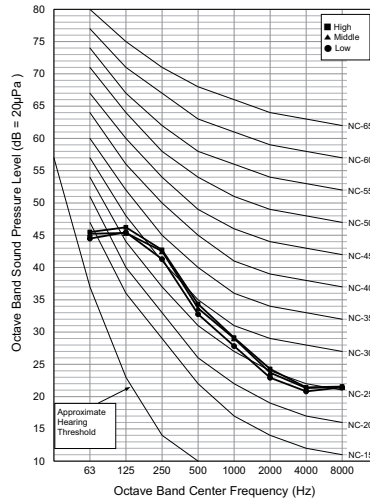

■ Sound Pressure Level (177Pa)

**ARNU07GM2A4
ARNU09GM2A4**

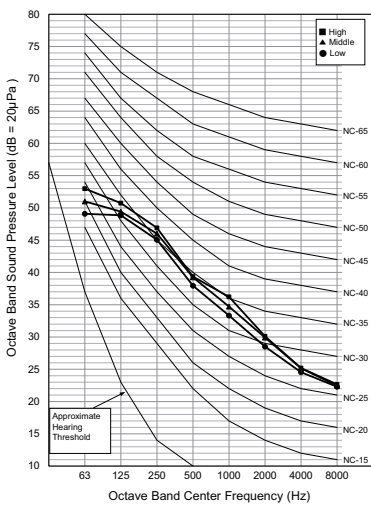

**ARNU12GM2A4
ARNU15GM2A4**

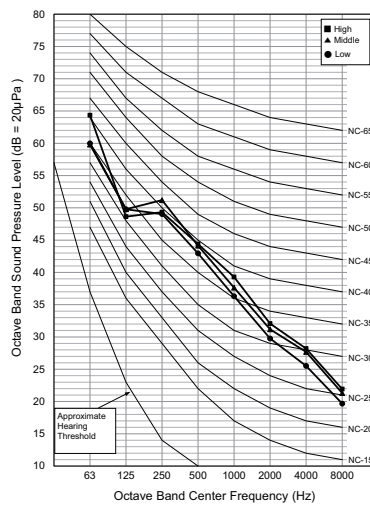

9. Sound Levels

Model	Sound Pressure Levels [dB(A),H-M-L]				
	External Static Pressure [Pa]				
	39	49	59	147	196
ARNU18GM3A4	37-34-32	38-36-34	40-38-37	45-45-45	46-45-45
ARNU24GM3A4 ARNU28GM3A4	38-37-33	39-37-35	40-39-37	46-46-45	46-46-45

■ Sound Pressure Level (39Pa)

ARNU18GM3A4

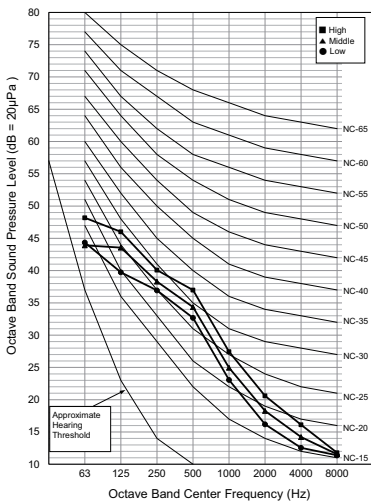

ARNU24GM3A4
ARNU28GM3A4

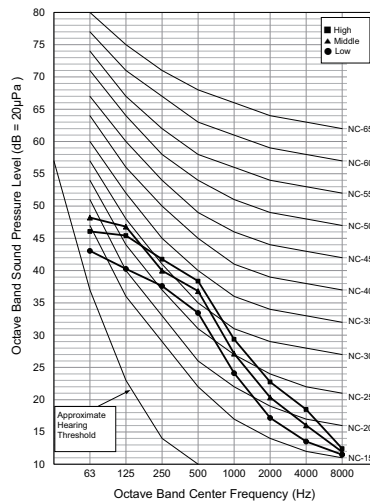

■ Sound Pressure Level (49Pa)

ARNU18GM3A4

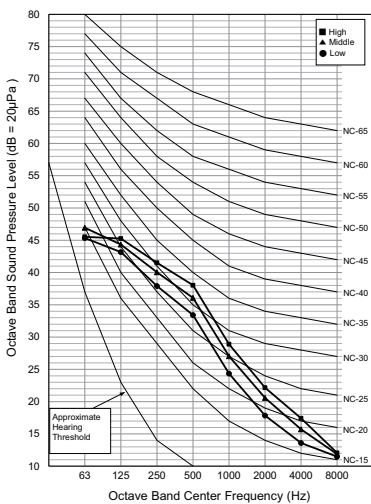

ARNU24GM3A4
ARNU28GM3A4

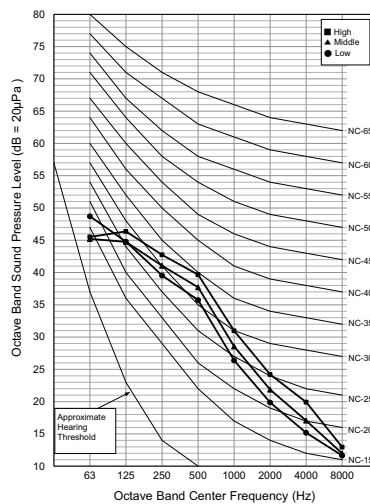

9. Sound Levels

■ Sound Pressure Level (59Pa)

ARNU18GM3A4

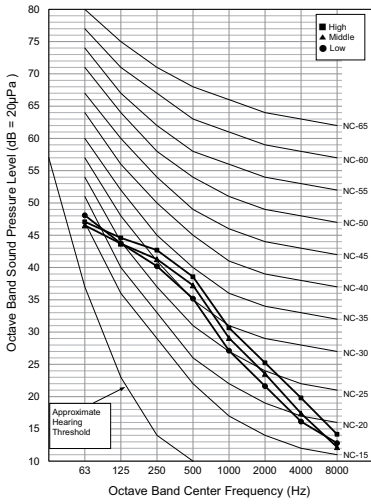

**ARNU24GM3A4
ARNU28GM3A4**

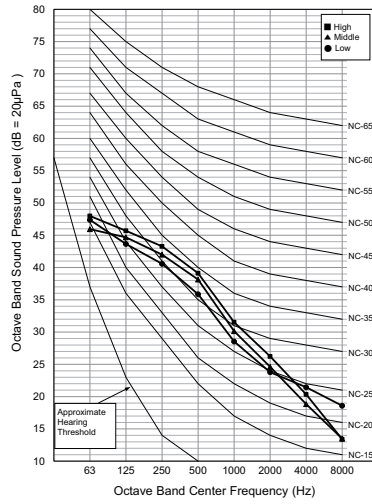

■ Sound Pressure Level (147Pa)

ARNU18GM3A4

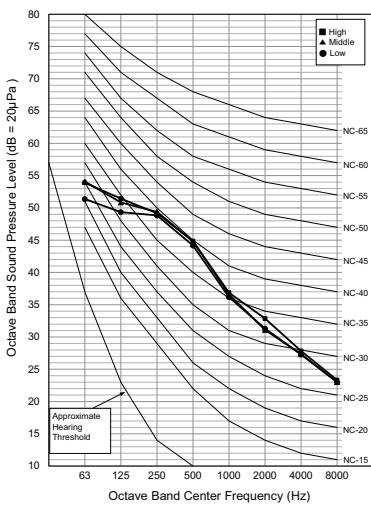

**ARNU24GM3A4
ARNU28GM3A4**

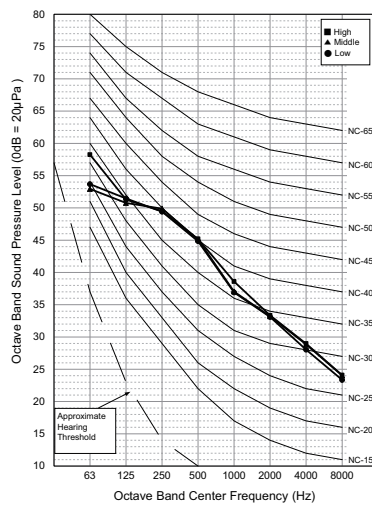

9. Sound Levels

■ Sound Pressure Level (196Pa)

ARNU18GM3A4

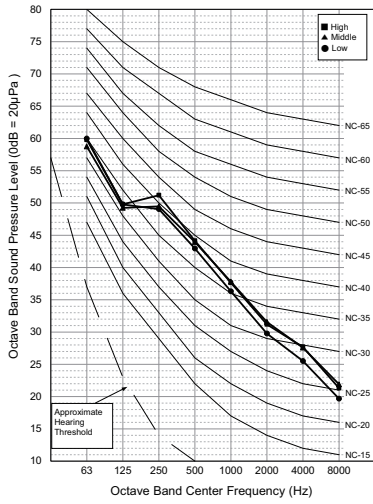

**ARNU24GM3A4
ARNU28GM3A4**

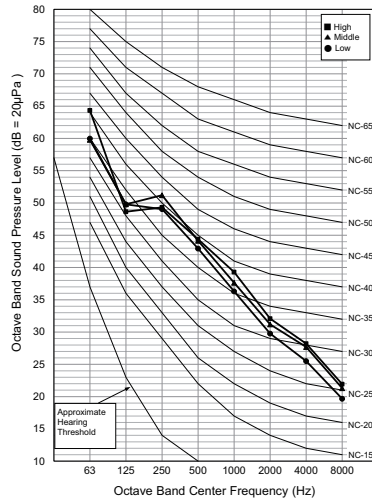

Model	Sound Level [dB(A)]		
	H	M	L
ARNU36GB8A4	46	45	42
ARNU42GB8A4	47	46	43
ARNU48GB8A4	47	46	44

ARNU36GB8A4

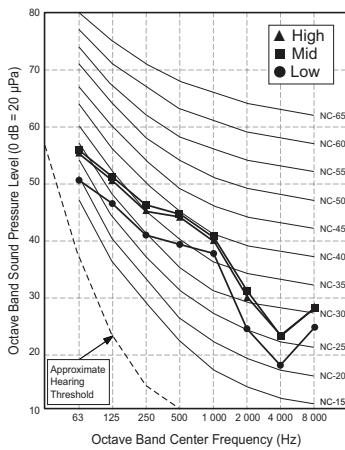

ARNU42GB8A4

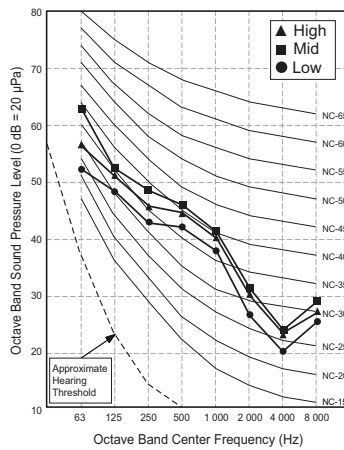

ARNU48GB8A4

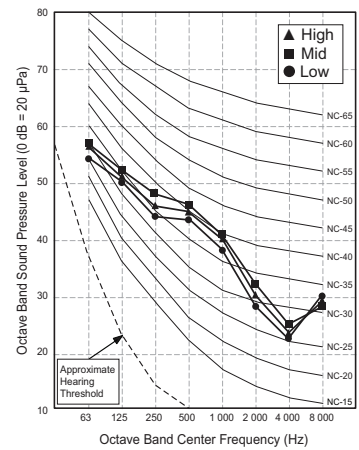

9. Sound Levels

9.2 Sound Power Levels

Note

- Data is valid at diffuse field condition
- Data is valid at nominal operating condition
- Sound level can be increased in static pressure mode or used air guide.
- Sound level will vary depending on a range of factors such as the construction (acoustic absorption coefficient) of particular room in which the equipment is installed.
- Reference acoustic intensity 0dB = $10E-6\mu W/m^2$
- Sound power level is measured on the rated condition in the semi-anechoic rooms by ISO 9614 standard. Therefore, these values can be increased owing to ambient conditions during operation.

Model	Sound Power Levels [dB(A),H-M-L]				
	External Static Pressure [Pa]				
	39	49	59	147	177
ARNU07GM2A4 ARNU09GM2A4	51-51-50	52-52-52	53-52-52	54-54-54	63-61-59
ARNU12GM2A4 ARNU15GM2A4	52-51-50	53-52-52	53-53-52	55-54-54	64-62-60

■ Sound Power Level (39Pa)

**ARNU07GM2A4
ARNU09GM2A4**

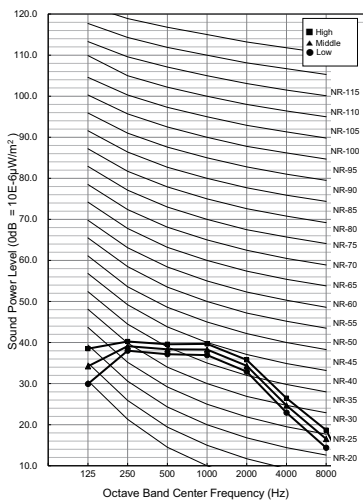

**ARNU12GM2A4
ARNU15GM2A4**

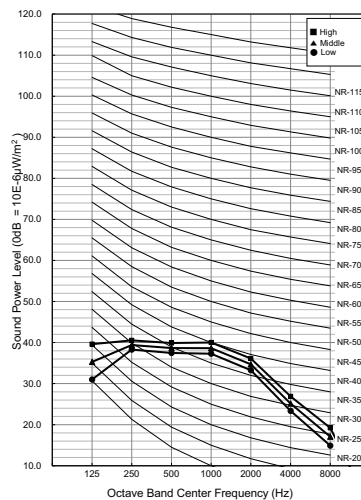

9. Sound Levels

■ Sound Power Level (49Pa)

**ARNU07GM2A4
ARNU09GM2A4**

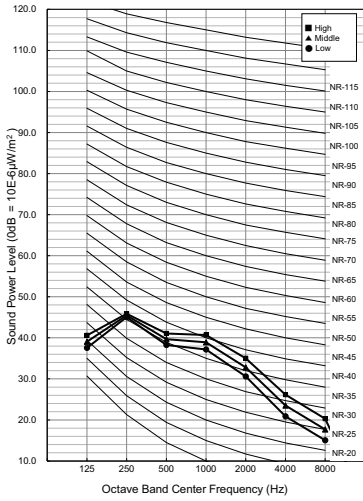

**ARNU12GM2A4
ARNU15GM2A4**

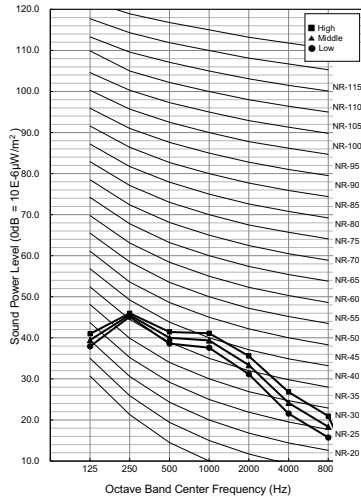

■ Sound Power Level (59Pa)

**ARNU07GM2A4
ARNU09GM2A4**

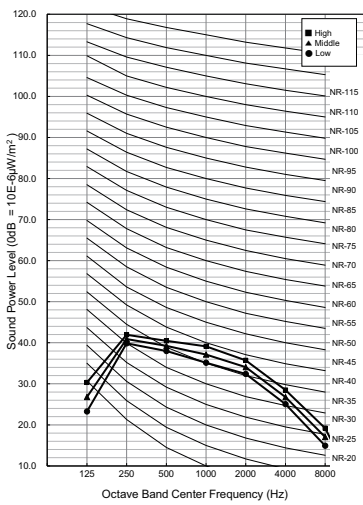

**ARNU12GM2A4
ARNU15GM2A4**

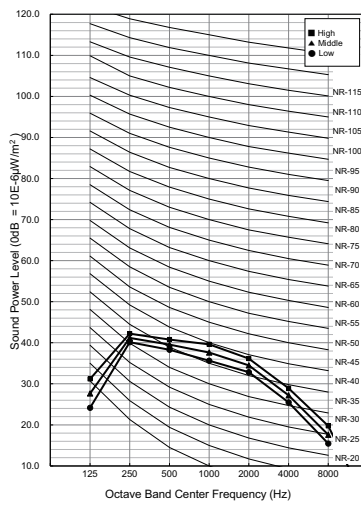

9. Sound Levels

■ Sound Power Level (147Pa)

**ARNU07GM2A4
ARNU09GM2A4**

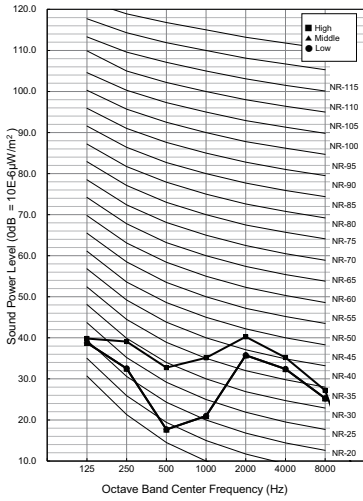

**ARNU12GM2A4
ARNU15GM2A4**

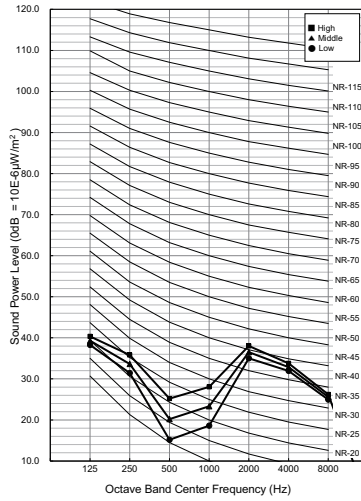

■ Sound Power Level (177Pa)

**ARNU07GM2A4
ARNU09GM2A4**

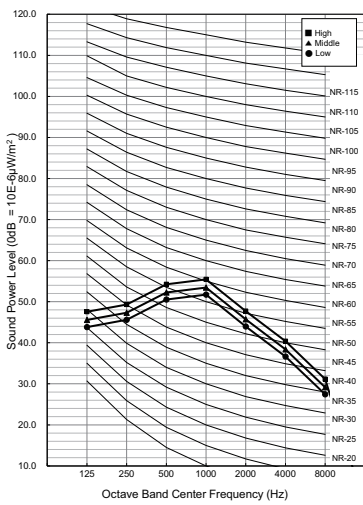

**ARNU12GM2A4
ARNU15GM2A4**

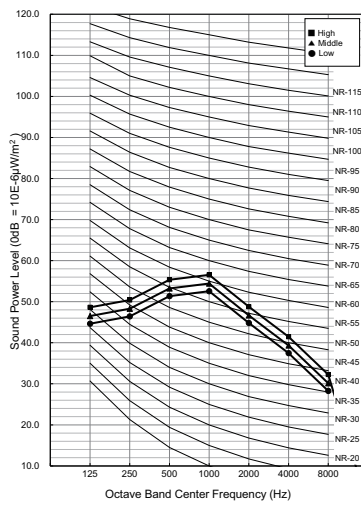

9. Sound Levels

Model	Sound Power Levels [dB(A),H-M-L]				
	External Static Pressure [Pa]				
	39	49	59	147	196
ARNU18GM3A4	51-50-49	52-51-50	53-52-51	58-58-58	70-70-69
ARNU24GM3A4 ARNU28GM3A4	52-51-49	53-52-51	54-52-51	59-58-58	70-70-69

■ Sound Power Level (39Pa)

ARNU18GM3A4

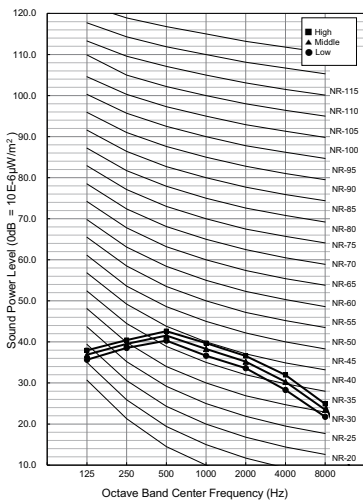

ARNU24GM3A4
ARNU28GM3A4

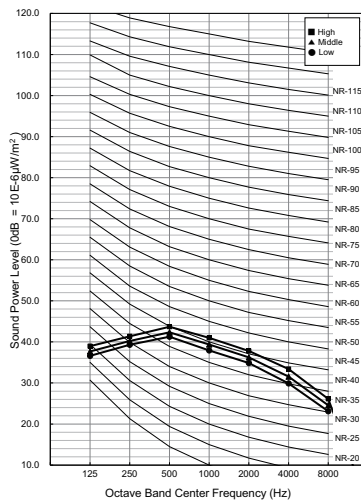

■ Sound Power Level (49Pa)

ARNU18GM3A4

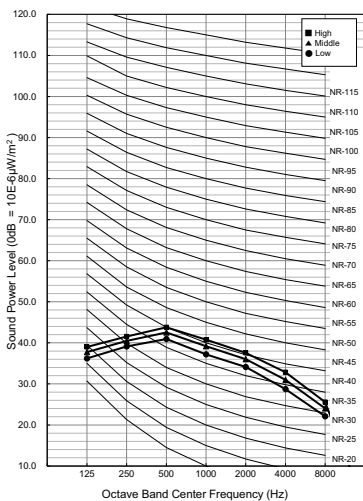

ARNU24GM3A4
ARNU28GM3A4

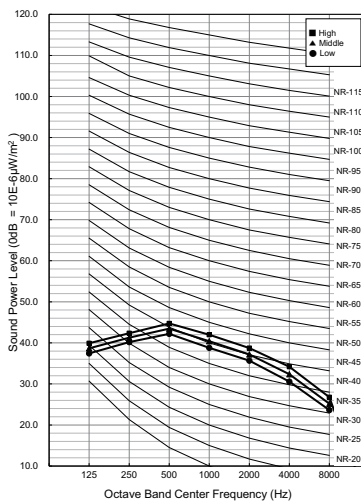

9. Sound Levels

■ Sound Power Level (59Pa)

ARNU18GM3A4

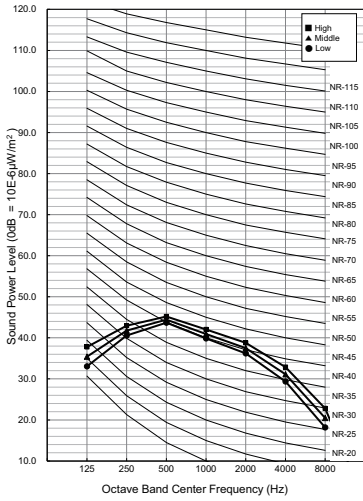

**ARNU24GM3A4
ARNU28GM3A4**

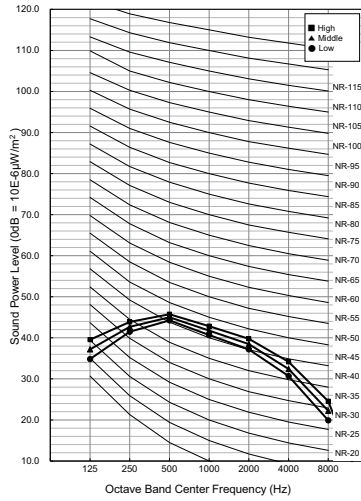

■ Sound Power Level (147Pa)

ARNU18GM3A4

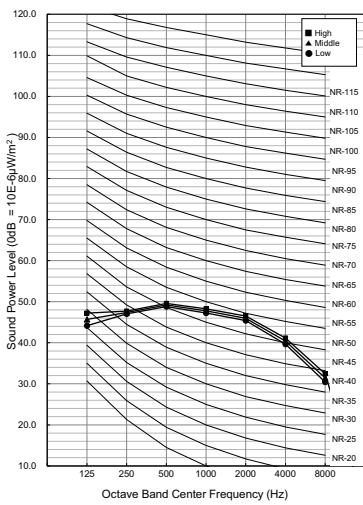

**ARNU24GM3A4
ARNU28GM3A4**

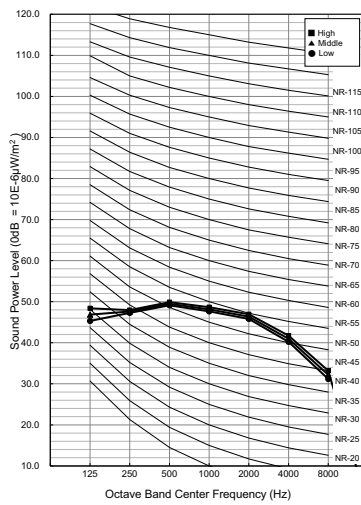

9. Sound Levels

■ Sound Power Level (196Pa)

ARNU18GM3A4

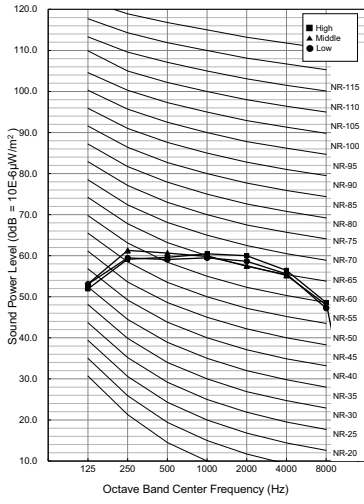

**ARNU24GM3A4
ARNU28GM3A4**

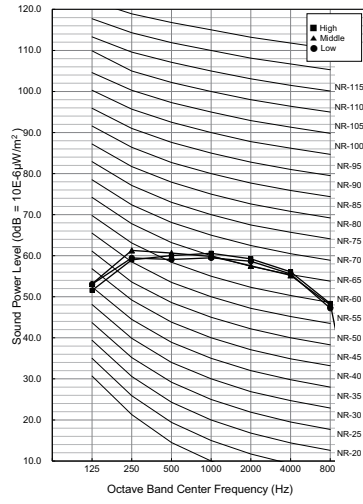

Ceiling Concealed Duct (High Static)

- 1. List of functions**
- 2. Specifications**
- 3. Dimensions & Gravity Point**
- 4. Piping Diagrams**
- 5. Wiring Diagrams**
- 6. Capacity Tables**
- 7. External Static Pressure (E.S.P) & Air Flow**
- 8. Electric Characteristics**
- 9. Sound Levels**

1. List of functions

◆ List of functions

Category	Function	ARNU07GM1A4, ARNU09GM1A4, ARNU12GM1A4 ARNU15GM1A4, ARNU18GM1A4, ARNU24GM1A4 ARNU28GM2A4, ARNU36GM2A4, ARNU42GM2A4 ARNU48GM3B4, ARNU54GM3B4
Air Flow	Air Supply Outlet	2
	Airflow Steps (fan/cool/heat)	3 / 3 / 3
	Fan Speed Auto*	X
	Power Cool/Heat	X / X
	Dry Operation	O
Air Purification	Air Purify	Accessory
	UV-C	Accessory
	Pre-Filter	O
Reliability	Hot Start	O
	Self Diagnosis	O
Convenience	Auto Mode	O
	Auto Dry Operation	O
	Auto Restart	O
	Child Lock*	O
	Group Control*	O
	Sleep Timer	O
	Turn On/Off Reservation	O
	Schedule*	O
	Two Thermistor Control*	O
External On/Off	O	
Installation	Drain Pump	O
	E.S.P. Setting*	O
	Auto E.S.P. Control*	O
Special Functions	Wi-Fi	Accessory

Note

- O : Applied, X : Not Applied, - : Unconfirmed or irrelevant
Embedded : A kit is provided by default for using this function when the product is manufactured.
Accessory : Ordered and purchased separately the accessory package referring to the model name provided and install at field. Accessory line-ups varies by region, so check your local catalogue or local sales material.
- Some functions can be limited by remote controller.
- Selecting a wireless remote controller in case of ducted type indoor units requires either a connection to the wired remote controller (Standard II) or an IR receiver accessory to be connected to the duct in order to receive the signal.
- 'Auto Mode' varies depending on the outdoor unit type.
 - Auto Change Over(Heat Recovery Outdoor Unit)
 - Auto Mode Select(Heat Pump Outdoor Unit)
 - Auto Intensity Control(Cooling Only Outdoor Unit)
- * : These functions need to connect the wired remote controller.

1. List of functions

◆ List of functions

Category	Function	ARNU76GB8A4, ARNU96GB8A4
Air Flow	Air Supply Outlet	2
	Airflow Steps (fan/cool/heat)	3 / 3 / 3
	Fan Speed Auto*	X
	Power Cool/Heat	X / X
	Dry Operation	O
Air Purification	Air Purify	X
	UV-C	X
	Pre-Filter	O
Reliability	Hot Start	O
	Self Diagnosis	O
Convenience	Auto Mode	O
	Auto Dry Operation	O
	Auto Restart	O
	Child Lock*	O
	Group Control*	O
	Sleep Timer	O
	Turn On/Off Reservation	O
	Schedule*	O
	Two Thermistor Control*	O
External On/Off	O	
Installation	Drain Pump	O
	E.S.P. Control*	O
	Auto E.S.P. Control*	X
Special Functions	Wi-Fi	Accessory

Note

- O : Applied, X : Not Applied, - : Unconfirmed or irrelevant
 Embedded : A kit is provided by default for using this function when the product is manufactured.
 Accessory : Ordered and purchased separately the accessory package referring to the model name provided and install at field. Accessory line-ups varies by region, so check your local catalogue or local sales material.
- Some functions can be limited by remote controller.
- Selecting a wireless remote controller in case of ducted type indoor units requires either a connection to the wired remote controller (Standard II) or an IR receiver accessory to be connected to the duct in order to receive the signal.
- 'Auto Mode' varies depending on the outdoor unit type.
 - Auto Change Over(Heat Recovery Outdoor Unit)
 - Auto Mode Select(Heat Pump Outdoor Unit)
 - Auto Intensity Control(Cooling Only Outdoor Unit)
- * : These functions need to connect the wired remote controller.

1. List of functions

◆ Accessory Compatibility List

Category	Accessory Name	Model Name	Description	ARNU**M1A4 ARNU**M2A4 ARNU**M3A4
Remote Controller	Wired - Premium	PREMTA000	-	○
		PREMTA000A	-	○
		PREMTA000B	-	○
	Wired - RS3 (Standard III)	PREMTB100/PREMTB101	White	○
		PREMTBB10/PREMTBB11	Black	○
	Wired - RS2 (Standard II)	PREMTB001	White	○
		PREMTBB01	Black	○
	Wired - Simple	PQRCVCL0QW	White	○
		PQRCVCL0Q	Black	○
	Wired - Simple for Hotel	PQRCHCA0QW	White	○
		PQRCHCA0Q	Black	○
	Wireless	PQWRCQ0FDB	For Cooling only	○
PQWRHQ0FDB		For Heat pump	○	
PWLSSB21C		For Cooling only	○	
PWLSSB21H		For Heat pump	○	
Dry Contact	Simple	PDRYCB000	1 input port, AC 220 - 240V	○
		PDRYCB100	1 input port, AC 24V	○
	Communication	PDRYCB400	2 input port	○
		PDRYCB300	8 input port, For 3rd party Thermostat	○
		PDRYCB320	8 input port, For 3rd Party Thermostat (Analog Input)	○
PDRYCB500	For 3rd Party Controller (Modbus RTU)	○		
Integration Device	Remote Temperature sensor	PQRSTA0	-	○
	Zone Controller	ABZCA	For Duct, 4zone, 220-240V	○
	Group Control wire	PZCWRCG3	Cable Assembly For group control (Y-type cable : 0.25m, cable : 9.6m)	○
ETC	Extension wire	PZCWRC1	Extension wire For IDU-wired remote controller (9.6m)	X
	2-Remo Control Wire	PZCWRC2	-	X
	Wi-Fi Modem	PWFMDD200	-	○
	Wi-Fi Extension cable	PWYREW000	USB Extension cable : 10 m	○
	IR Receiver	PWLRVN000	For wireless remote controller with Duct	○
	Independent Power Module	PRIP0	-	○
	Multi-tenant Power module	PINPMB001	-	○
	Refrigerant Leakage Detector	PRLDNVS0	For R410A only	○
	UVnano Filter Box	PBM13M1UA0	For M1 Chassis	○
		PBM13M2UA0	For M2 Chassis	○
		PBM13M3UA0	For M3 Chassis	○
	High Efficiency Filter (Main Filter of Filter Box)	FBM13M1UA0	For M1 UVnano Filter Box	○
		FBM13M2UA0	For M2 UVnano Filter Box	○
		FBM13M3UA0	For M3 UVnano Filter Box	○
	EEV Kit	PRGK024A0	For Multi V Indoor Unit	○ (M1 : ~18k)
Auxiliary Heater Relay Kit	PRARH1	For Cassette and Duct Indoor Units	○	

Note

1. ○: Possible, X: Impossible, -: Not applicable, Embedded : Included with product.
2. If there is a difference in development time between the product and the remote controller, some functions cannot be operated.
3. If using Wi-Fi controller, Some advanced functions controlled by remote controller cannot be operated.
4. Selecting a wireless remote controller in case of ducted type indoor units requires either a connection to the wired remote controller (Standard II) or an IR receiver accessory to be connected to the duct in order to receive the signal.
5. If you need more detail, please refer to the **BECON** PDB or the manual of product. (<http://partner.lge.com> > Select Your Region : Home> Doc.Library> Product > Control(BECON))

1. List of functions

◆ Accessory Compatibility List

Category	Accessory Name	Model Name	Description	ARNU**B8A4
Remote Controller	Wired - Premium	PREMTA000	-	○
		PREMTA000A	-	○
		PREMTA000B	-	○
	Wired - RS3 (Standard III)	PREMTB100/PREMTB101	White	○
		PREMTBB10/PREMTBB11	Black	○
	Wired - RS2 (Standard II)	PREMTB001	White	○
		PREMTBB01	Black	○
	Wired - Simple	PQRCVCL0QW	White	○
		PQRCVCL0Q	Black	○
	Wired - Simple for Hotel	PQRCHCA0QW	White	○
		PQRCHCA0Q	Black	○
	Wireless	PQWRCQ0FDB	For Cooling only	○
		PQWRHQ0FDB	For Heat pump	○
		PWLSSB21C	For Cooling only	○
PWLSSB21H		For Heat pump	○	
Dry Contact	Simple	PDRYCB000	1 input port, AC 220 - 240V	○
		PDRYCB100	1 input port, AC 24V	○
	Communication	PDRYCB400	2 input port	○
		PDRYCB300	8 input port, For 3rd party Thermostat	○
		PDRYCB320	8 input port, For 3rd Party Thermostat (Analog Input)	○
PDRYCB500	For 3rd Party Controller (Modbus RTU)	○		
Integration Device	Remote Temperature sensor	PQRSTA0	-	○
	Zone Controller	ABZCA	For Duct, 4zone, 220-240V	○
	Group Control wire	PZCWRCG3	Cable Assembly For group control (Y-type cable : 0.25m, cable : 9.6m)	○
ETC	Extension wire	PZCWRC1	Extension wire For IDU-wired remote controller (9.6m)	X
	2-Remo Control Wire	PZCWRC2	-	X
	Wi-Fi Modem	PWFMDD200	-	○
	Wi-Fi Extension cable	PWYREW000	USB Extension cable : 10 m	○
	IR Receiver	PWLRVN000	For wireless remote controller with Duct	○
	Independent Power Module	PRIP0	-	○
	Multi-tenant Power module	PINPMB001	-	○
	Refrigerant Leakage Detector	PRLDNVS0	For R410A only	○
	UVnano Filter Box	PBM13M1UA0	For M1 Chassis	X
		PBM13M2UA0	For M2 Chassis	X
		PBM13M3UA0	For M3 Chassis	X
	High Efficiency Filter (Main Filter of Filter Box)	FBM13M1UA0	For M1 UVnano Filter Box	X
		FBM13M2UA0	For M2 UVnano Filter Box	X
		FBM13M3UA0	For M3 UVnano Filter Box	X
EEV Kit	PRGK024A0	For Multi V Indoor Unit	X	
Auxiliary Heater Relay Kit	PRARH1	For Cassette and Duct Indoor Units	○	

Note

1. ○: Possible, X: Impossible, -: Not applicable, Embedded : Included with product.
2. If there is a difference in development time between the product and the remote controller, some functions cannot be operated.
3. If using Wi-Fi controller, Some advanced functions controlled by remote controller cannot be operated.
4. Selecting a wireless remote controller in case of ducted type indoor units requires either a connection to the wired remote controller (Standard II) or an IR receiver accessory to be connected to the duct in order to receive the signal.
5. If you need more detail, please refer to the **BECON** PDB or the manual of product. (<http://partner.lge.com> > Select Your Region : Home> Doc.Library> Product > Control(BECON))

2. Specifications

Type			Ceiling Concealed Duct (High Static)	
Model		Unit	ARNU07GM1A4	ARNU09GM1A4
Cooling Capacity		kW	2.2	2.8
		kcal/h	1,900	2,400
		Btu/h	7,500	9,600
Heating Capacity		kW	2.5	3.2
		kcal/h	2,200	2,800
		Btu/h	8,500	10,900
Power Input (H / M / L)		W	39 / 30 / 25	40 / 32 / 26
Casing			Galvanized Steel Plate	Galvanized Steel Plate
Dimensions (WxHxD)	Body	mm	900 × 270 × 700	900 × 270 × 700
		inch	35-7/16 x 10-5/8 x 27-9/16	35-7/16 x 10-5/8 x 27-9/16
Coil	Rows x Columns x FPI		2 x 13 x 18	2 x 13 x 18
	Face Area	m ²	0.21	0.21
Fan	Type		Sirocco Fan	Sirocco Fan
	Motor Output x Number		W	136 x 1
	Air Flow Rate (H / M / L) (Factory set)	m ³ /min	9.0 / 7.5 / 6.0	9.5 / 7.5 / 6.0
		ft ³ /min	318 / 265 / 212	336 / 265 / 212
	External Static Pressure		mmAq(Pa)	6(59)
	External Static Pressure (Min ~ Max)		mmAq (Pa)	2(20) ~ 15(147)
	Drive			Direct
Motor type			BLDC	
Temperature Control			Microprocessor, Thermostat for cooling and heating	
Sound Absorbing Thermal Insulation Material			Foamed polystyrene	Foamed polystyrene
Air Filter			-	-
Safety Device			Fuse	Fuse
Pipe Connections	Liquid Side	mm(inch)	Ø6.35(1/4)	Ø6.35(1/4)
	Gas Side	mm(inch)	Ø12.7(1/2)	Ø12.7(1/2)
	Drain Pipe(Internal Dia.)	mm(inch)	25(1)	25(1)
Net Weight	Body	kg(lbs)	25.0(55)	25.0(55)
Sound Pressure Levels (H / M / L)		dB(A)	26 / 24 / 23	27 / 25 / 23
Sound Power Levels (H / M / L, Body)		dB(A)	43 / 41 / 40	43 / 42 / 40
Power Supply		Ø, V, Hz	1, 220 - 230 - 240, 50/60	1, 220 - 230 - 240, 50/60
Running Current by voltage	Rated	A	0.34 - 0.33 - 0.31	0.35 - 0.34 - 0.32
Maximum Running Current		A	1.60	1.60
Refrigerant	Type		-	R410A / R32
	Additional Charging Amount (CF Value of IDU)		kg(each)	0.24 / 0.20
	Control		-	EEV
Transmission cable		mm ²	1.0~1.5 x 2C	1.0~1.5 x 2C

Note

- Due to our policy of innovation some specifications may be changed without notification.
- Wiring cable size must comply with the applicable local and national code. And "Electric characteristics" chapter should be considered for electrical work and design. Especially the power cable and circuit breaker should be selected in accordance with that.
- Sound pressure level is measured on the rated condition in the anechoic rooms by ISO 3745 standard.
Sound power level is measured on the rated condition in the semi-anechoic rooms by ISO 9614 standard.
Therefore, these values can be increased owing to ambient conditions during operation.
- Capacities are net capacities and based on the following conditions. Refer to the Outdoor Unit Specifications for calculating the real capacity.
 - Cooling : Indoor Ambient Temp. 27°CDB / 19°CWB, Outdoor Ambient Temp. 35°CDB / 24°CWB
 - Heating : Indoor Ambient Temp. 20°CDB / 15°CWB, Outdoor Ambient Temp. 7°CDB / 6°CWB
 - Interconnected Pipe is standard length and difference of Elevation (Outdoor ~ Indoor Unit) is 0m.
- Refrigerant information (type, additional charging amount, etc.) must be applied by refrigerant type of the combined outdoor unit.
Adapt after checking the specifications of outdoor unit.

2. Specifications

Type			Ceiling Concealed Duct (High Static)	
Model		Unit	ARNU12GM1A4	ARNU15GM1A4
Cooling Capacity		kW	3.6	4.5
		kcal/h	3,100	3,900
		Btu/h	12,300	15,400
Heating Capacity		kW	4.0	5.0
		kcal/h	3,400	4,300
		Btu/h	13,600	17,100
Power Input (H / M / L)		W	46 / 38 / 31	67 / 53 / 46
Casing			Galvanized Steel Plate	Galvanized Steel Plate
Dimensions (WxHxD)	Body	mm	900 × 270 × 700	900 × 270 × 700
		inch	35-7/16 x 10-5/8 x 27-9/16	35-7/16 x 10-5/8 x 27-9/16
Coil	Rows x Columns x FPI		2 x 13 x 18	2 x 13 x 18
	Face Area	m ²	0.21	0.21
Fan	Type		Sirocco Fan	Sirocco Fan
	Motor Output x Number	W	136 x 1	136 x 1
	Air Flow Rate (H / M / L) (Factory set)	m ³ /min	11.0 / 9.0 / 7.0	16.0 / 12.0 / 9.0
		ft ³ /min	388 / 318 / 247	565 / 424 / 318
	External Static Pressure	mmAq(Pa)	6(59)	6(59)
	External Static Pressure (Min ~ Max)	mmAq (Pa)	2(20) ~ 15(147)	2(20) ~ 15(147)
	Drive		Direct	Direct
Motor type		BLDC	BLDC	
Temperature Control			Microprocessor, Thermostat for cooling and heating	
Sound Absorbing Thermal Insulation Material			Foamed polystyrene	Foamed polystyrene
Air Filter			-	-
Safety Device			Fuse	Fuse
Pipe Connections	Liquid Side	mm(inch)	Ø6.35(1/4)	Ø6.35(1/4)
	Gas Side	mm(inch)	Ø12.7(1/2)	Ø12.7(1/2)
	Drain Pipe(Internal Dia.)	mm(inch)	25(1)	25(1)
Net Weight	Body	kg(lbs)	25.0(55)	25.0(55)
Sound Pressure Levels (H / M / L)		dB(A)	27 / 25 / 23	30 / 27 / 23
Sound Power Levels (H / M / L, Body)		dB(A)	44 / 42 / 41	48 / 44 / 42
Power Supply		Ø, V, Hz	1, 220 - 230 - 240, 50/60	1, 220 - 230 - 240, 50/60
Running Current by voltage	Rated	A	0.40 - 0.39 - 0.37	0.59 - 0.56 - 0.54
Maximum Running Current		A	1.60	1.60
Refrigerant	Type	-	R410A / R32	R410A / R32
	Additional Charging Amount (CF Value of IDU)	kg(each)	0.24 / 0.20	0.24 / 0.20
	Control	-	EEV	EEV
Transmission cable		mm ²	1.0~1.5 x 2C	1.0~1.5 x 2C

Note

- Due to our policy of innovation some specifications may be changed without notification.
- Wiring cable size must comply with the applicable local and national code. And "Electric characteristics" chapter should be considered for electrical work and design. Especially the power cable and circuit breaker should be selected in accordance with that.
- Sound pressure level is measured on the rated condition in the anechoic rooms by ISO 3745 standard.
Sound power level is measured on the rated condition in the semi-anechoic rooms by ISO 9614 standard.
Therefore, these values can be increased owing to ambient conditions during operation.
- Capacities are net capacities and based on the following conditions. Refer to the Outdoor Unit Specifications for calculating the real capacity.
 - Cooling : Indoor Ambient Temp. 27°CDB / 19°CWB, Outdoor Ambient Temp. 35°CDB / 24°CWB
 - Heating : Indoor Ambient Temp. 20°CDB / 15°CWB, Outdoor Ambient Temp. 7°CDB / 6°CWB
 - Interconnected Pipe is standard length and difference of Elevation (Outdoor ~ Indoor Unit) is 0m.
- Refrigerant information (type, additional charging amount, etc.) must be applied by refrigerant type of the combined outdoor unit.
Adapt after checking the specifications of outdoor unit.

2. Specifications

Type			Ceiling Concealed Duct (High Static)		
Model		Unit	ARNU18GM1A4	ARNU24GM1A4	
Cooling Capacity		kW	5.6	7.1	
		kcal/h	4,800	6,100	
		Btu/h	19,100	24,200	
Heating Capacity		kW	6.3	8.0	
		kcal/h	5,400	6,900	
		Btu/h	21,500	27,300	
Power Input (H / M / L)		W	85 / 63 / 55	91 / 74 / 58	
Casing			Galvanized Steel Plate	Galvanized Steel Plate	
Dimensions (WxHxD)	Body	mm	900 × 270 × 700	900 × 270 × 700	
		inch	35-7/16 x 10-5/8 x 27-9/16	35-7/16 x 10-5/8 x 27-9/16	
Coil	Rows x Columns x FPI		2 x 13 x 18	3 x 13 x 18	
	Face Area	m ²	0.21	0.21	
Fan	Type		Sirocco Fan	Sirocco Fan	
	Motor Output x Number		W	136 x 1	
	Air Flow Rate (H / M / L) (Factory set)	m ³ /min		17.0 / 14.5 / 12.0	19.0 / 16.0 / 14.0
		ft ³ /min		600 / 512 / 424	671 / 565 / 494
	External Static Pressure		mmAq(Pa)	6(59)	6(59)
	External Static Pressure (Min ~ Max)		mmAq (Pa)	2(20) ~ 15(147)	2(20) ~ 15(147)
	Drive			Direct	Direct
Motor type			BLDC	BLDC	
Temperature Control			Microprocessor, Thermostat for cooling and heating		
Sound Absorbing Thermal Insulation Material			Foamed polystyrene	Foamed polystyrene	
Air Filter			-	-	
Safety Device			Fuse	Fuse	
Pipe Connections	Liquid Side	mm(inch)	Ø6.35(1/4)	Ø9.52(3/8)	
	Gas Side	mm(inch)	Ø12.7(1/2)	Ø15.88(5/8)	
	Drain Pipe(Internal Dia.)	mm(inch)	25(1)	25(1)	
Net Weight	Body	kg(lbs)	25.0(55)	25.9(57)	
Sound Pressure Levels (H / M / L)		dB(A)	31 / 28 / 25	32 / 29 / 26	
Sound Power Levels (H / M / L, Body)		dB(A)	49 / 48 / 44	51 / 49 / 48	
Power Supply		Ø, V, Hz	1, 220 - 230 - 240, 50/60	1, 220 - 230 - 240, 50/60	
Running Current by voltage	Rated	A	0.75 - 0.72 - 0.69	0.80 - 0.77 - 0.73	
Maximum Running Current		A	1.60	1.60	
Refrigerant	Type		-	R410A / R32	
	Additional Charging Amount (CF Value of IDU)		kg(each)	0.24 / 0.20	
	Control		-	EEV	
Transmission cable		mm ²	1.0~1.5 x 2C	1.0~1.5 x 2C	

Note

- Due to our policy of innovation some specifications may be changed without notification.
- Wiring cable size must comply with the applicable local and national code. And "Electric characteristics" chapter should be considered for electrical work and design. Especially the power cable and circuit breaker should be selected in accordance with that.
- Sound pressure level is measured on the rated condition in the anechoic rooms by ISO 3745 standard.
Sound power level is measured on the rated condition in the semi-anechoic rooms by ISO 9614 standard.
Therefore, these values can be increased owing to ambient conditions during operation.
- Capacities are net capacities and based on the following conditions. Refer to the Outdoor Unit Specifications for calculating the real capacity.
 - Cooling : Indoor Ambient Temp. 27°CDB / 19°CWB, Outdoor Ambient Temp. 35°CDB / 24°CWB
 - Heating : Indoor Ambient Temp. 20°CDB / 15°CWB, Outdoor Ambient Temp. 7°CDB / 6°CWB
 - Interconnected Pipe is standard length and difference of Elevation (Outdoor ~ Indoor Unit) is 0m.
- Refrigerant information (type, additional charging amount, etc.) must be applied by refrigerant type of the combined outdoor unit.
Adapt after checking the specifications of outdoor unit.

2. Specifications

Type			Ceiling Concealed Duct (High Static)		
Model		Unit	ARNU28GM2A4	ARNU36GM2A4	
Cooling Capacity		kW	8.2	10.6	
		kcal/h	7,100	9,100	
		Btu/h	28,000	36,200	
Heating Capacity		kW	9.2	11.9	
		kcal/h	8,000	10,200	
		Btu/h	31,500	40,600	
Power Input (H / M / L)		W	123 / 81 / 57	184 / 123 / 81	
Casing			Galvanized Steel Plate	Galvanized Steel Plate	
Dimensions (WxHxD)	Body	mm	1,250 × 270 × 700	1,250 × 270 × 700	
		inch	49-7/32 x 10-5/8 x 27-9/16	49-7/32 x 10-5/8 x 27-9/16	
Coil	Rows x Columns x FPI		2 x 13 x 18	2 x 13 x 18	
	Face Area	m ²	0.27	0.27	
Fan	Type		Sirocco Fan	Sirocco Fan	
	Motor Output x Number		W	350 x 1	
	Air Flow Rate (H / M / L) (Factory set)	m ³ /min		28.0 / 24.0 / 21.0	32.0 / 28.0 / 24.0
		ft ³ /min		989 / 848 / 742	1,130 / 989 / 848
	External Static Pressure		mmAq(Pa)	6(59)	6(59)
	External Static Pressure (Min ~ Max)		mmAq (Pa)	4(39) ~ 18(176)	4(39) ~ 18(176)
	Drive			Direct	Direct
Motor type			BLDC	BLDC	
Temperature Control			Microprocessor, Thermostat for cooling and heating		
Sound Absorbing Thermal Insulation Material			Foamed polystyrene	Foamed polystyrene	
Air Filter			-	-	
Safety Device			Fuse	Fuse	
Pipe Connections	Liquid Side	mm(inch)	Ø9.52(3/8)	Ø9.52(3/8)	
	Gas Side	mm(inch)	Ø15.88(5/8)	Ø15.88(5/8)	
	Drain Pipe(Internal Dia.)	mm(inch)	25(1)	25(1)	
Net Weight	Body	kg(lbs)	36.0(79)	36.0(79)	
Sound Pressure Levels (H / M / L)		dB(A)	38 / 36 / 35	40 / 38 / 36	
Sound Power Levels (H / M / L, Body)		dB(A)	48 / 46 / 44	51 / 48 / 46	
Power Supply		Ø, V, Hz	1, 220 - 230 - 240, 50/60	1, 220 - 230 - 240, 50/60	
Running Current by voltage	Rated	A	0.69 - 0.66 - 0.63	1.03 - 0.98 - 0.94	
Maximum Running Current		A	2.30	2.30	
Refrigerant	Type		-	R410A / R32	
	Additional Charging Amount (CF Value of IDU)		kg(each)	0.35 / 0.29	
	Control		-	EEV	
Transmission cable		mm ²	1.0~1.5 x 2C	1.0~1.5 x 2C	

Note

- Due to our policy of innovation some specifications may be changed without notification.
- Wiring cable size must comply with the applicable local and national code. And "Electric characteristics" chapter should be considered for electrical work and design. Especially the power cable and circuit breaker should be selected in accordance with that.
- Sound pressure level is measured on the rated condition in the anechoic rooms by ISO 3745 standard.
Sound power level is measured on the rated condition in the semi-anechoic rooms by ISO 9614 standard.
Therefore, these values can be increased owing to ambient conditions during operation.
- Capacities are net capacities and based on the following conditions. Refer to the Outdoor Unit Specifications for calculating the real capacity.
 - Cooling : Indoor Ambient Temp. 27°CDB / 19°CWB, Outdoor Ambient Temp. 35°CDB / 24°CWB
 - Heating : Indoor Ambient Temp. 20°CDB / 15°CWB, Outdoor Ambient Temp. 7°CDB / 6°CWB
 - Interconnected Pipe is standard length and difference of Elevation (Outdoor ~ Indoor Unit) is 0m.
- Refrigerant information (type, additional charging amount, etc.) must be applied by refrigerant type of the combined outdoor unit.
Adapt after checking the specifications of outdoor unit.

2. Specifications

Type			Ceiling Concealed Duct (High Static)
Model	Unit		ARNU42GM2A4
Cooling Capacity	kW		12.3
	kcal/h		10,600
	Btu/h		42,000
Heating Capacity	kW		13.8
	kcal/h		11,800
	Btu/h		47,000
Power Input (H / M / L)		W	231 / 162 / 111
Casing			Galvanized Steel Plate
Dimensions (WxHxD)	Body	mm	1,250 × 270 × 700
		inch	49-7/32 x 10-5/8 x 27-9/16
Coil	Rows x Columns x FPI		3 x 13 x 18
	Face Area	m ²	0.27
Fan	Type		Sirocco Fan
	Motor Output x Number	W	350 x 1
	Air Flow Rate (H / M / L) (Factory set)	m ³ /min	38.0 / 33.0 / 28.0
		ft ³ /min	1,342 / 1,165 / 989
	External Static Pressure	mmAq(Pa)	6(59)
	External Static Pressure (Min ~ Max)	mmAq (Pa)	4(39) ~ 18(176)
	Drive		Direct
Motor type		BLDC	
Temperature Control			Microprocessor, Thermostat for cooling and heating
Sound Absorbing Thermal Insulation Material			Foamed polystyrene
Air Filter			-
Safety Device			Fuse
Pipe Connections	Liquid Side	mm(inch)	Ø9.52(3/8)
	Gas Side	mm(inch)	Ø15.88(5/8)
	Drain Pipe(Internal Dia.)	mm(inch)	25(1)
Net Weight	Body	kg(lbs)	37.2(82)
Sound Pressure Levels (H / M / L)		dB(A)	42 / 41 / 39
Sound Power Levels (H / M / L, Body)		dB(A)	54 / 52 / 29
Power Supply		Ø, V, Hz	1, 220 - 230 - 240, 50/60
Running Current by voltage	Rated	A	1.29 - 1.24 - 1.18
Maximum Running Current		A	2.30
Refrigerant	Type	-	R410A / R32
	Additional Charging Amount (CF Value of IDU)	kg(each)	0.52 / 0.43
	Control	-	EEV
Transmission cable		mm ²	1.0~1.5 x 2C

Note

- Due to our policy of innovation some specifications may be changed without notification.
- Wiring cable size must comply with the applicable local and national code. And "Electric characteristics" chapter should be considered for electrical work and design. Especially the power cable and circuit breaker should be selected in accordance with that.
- Sound pressure level is measured on the rated condition in the anechoic rooms by ISO 3745 standard.
Sound power level is measured on the rated condition in the semi-anechoic rooms by ISO 9614 standard.
Therefore, these values can be increased owing to ambient conditions during operation.
- Capacities are net capacities and based on the following conditions. Refer to the Outdoor Unit Specifications for calculating the real capacity.
 - Cooling : Indoor Ambient Temp. 27°CDB / 19°CWB, Outdoor Ambient Temp. 35°CDB / 24°CWB
 - Heating : Indoor Ambient Temp. 20°CDB / 15°CWB, Outdoor Ambient Temp. 7°CDB / 6°CWB
 - Interconnected Pipe is standard length and difference of Elevation (Outdoor ~ Indoor Unit) is 0m.
- Refrigerant information (type, additional charging amount, etc.) must be applied by refrigerant type of the combined outdoor unit.
Adapt after checking the specifications of outdoor unit.

2. Specifications

Type			Ceiling Concealed Duct (High Static)		
Model		Unit	ARNU48GM3B4	ARNU54GM3B4	
Cooling Capacity		kW	14.1	15.8	
		kcal/h	12,100	13,600	
		Btu/h	48,100	54,000	
Heating Capacity		kW	15.9	18.0	
		kcal/h	13,600	15,500	
		Btu/h	54,200	61,400	
Power Input (H / M / L)		W	172 / 105 / 65	260 / 215 / 172	
Casing			Galvanized Steel Plate	Galvanized Steel Plate	
Dimensions (WxHxD)	Body	mm	1250 × 360 × 700	1250 × 360 × 700	
		inch	49-7/32 x 14-3/16 x 27-9/16	49-7/32 x 14-3/16 x 27-9/16	
Coil	Rows x Columns x FPI		3 x 16 x 18	3 x 16 x 18	
	Face Area	m ²	0.32	0.32	
Fan	Type		Sirocco Fan	Sirocco Fan	
	Motor Output x Number		W	500 x 1	
	Air Flow Rate (H / M / L) (Factory set)	m ³ /min		40.0 / 34.0 / 28.0	50.0 / 45.0 / 40.0
		ft ³ /min		1413 / 1201 / 989	1766 / 1589 / 1413
	External Static Pressure		mmAq(Pa)	6(59)	6(59)
	External Static Pressure (Min ~ Max)		mmAq (Pa)	4(39) ~ 20(196)	4(39) ~ 20(196)
	Drive			Direct	Direct
Motor type			BLDC	BLDC	
Temperature Control			Microprocessor, Thermostat for cooling and heating		
Sound Absorbing Thermal Insulation Material			Foamed polystyrene	Foamed polystyrene	
Air Filter			-	-	
Safety Device			Fuse	Fuse	
Pipe Connections	Liquid Side	mm(inch)	Ø9.52(3/8)	Ø9.52(3/8)	
	Gas Side	mm(inch)	Ø15.88(5/8)	Ø19.05(3/4)	
	Drain Pipe(Internal Dia.)	mm(inch)	25(1)	25(1)	
Net Weight		kg(lbs)	42.2(93)	42.2(93)	
Sound Pressure Levels (H / M / L)		dB(A)	39 / 37 / 35	42 / 40 / 39	
Sound Power Levels (H / M / L)		dB(A)	63 / 60 / 59	65 / 64 / 62	
Power Supply		Ø, V, Hz	1, 220 - 230 - 240, 50/60	1, 220 - 230 - 240, 50/60	
Running Current by voltage	Rated	A	1.04 - 1.00 - 0.96	1.58 - 1.51 - 1.44	
Maximum Running Current		A	2.50	2.50	
Refrigerant	Type		-	R410A / R32	
	Additional Charging Amount (CF Value of IDU)		kg(each)	0.61 / 0.50	
	Control		-	EEV	
Transmission cable		mm ²	1.0~1.5 x 2C	1.0~1.5 x 2C	

Note

- Due to our policy of innovation some specifications may be changed without notification.
- Wiring cable size must comply with the applicable local and national code. And "Electric characteristics" chapter should be considered for electrical work and design. Especially the power cable and circuit breaker should be selected in accordance with that.
- Sound pressure level is measured on the rated condition in the anechoic rooms by ISO 3745 standard.
Sound power level is measured on the rated condition in the semi-anechoic rooms by ISO 9614 standard.
Therefore, these values can be increased owing to ambient conditions during operation.
- Capacities are net capacities and based on the following conditions. Refer to the Outdoor Unit Specifications for calculating the real capacity.
 - Cooling : Indoor Ambient Temp. 27°CDB / 19°CWB, Outdoor Ambient Temp. 35°CDB / 24°CWB
 - Heating : Indoor Ambient Temp. 20°CDB / 15°CWB, Outdoor Ambient Temp. 7°CDB / 6°CWB
 - Interconnected Pipe is standard length and difference of Elevation (Outdoor ~ Indoor Unit) is 0m.
- Refrigerant information (type, additional charging amount, etc.) must be applied by refrigerant type of the combined outdoor unit.
Adapt after checking the specifications of outdoor unit.
- Sound levels are measured at 50Pa External Static Pressure condition.

2. Specifications

Type		Ceiling Concealed Duct (High Static)		
Model	Unit	ARNU76GB8A4	ARNU96GB8A4	
Cooling Capacity	kW	22.4	28.0	
	kcal/h	19,300	24,100	
	Btu/h	76,400	95,900	
Heating Capacity	kW	25.2	31.5	
	kcal/h	21,700	27,100	
	Btu/h	86,000	107,500	
Power Input (H / M / L)		W	765 / 500 / 500	
Casing		Galvanized Steel Plate	Galvanized Steel Plate	
Dimensions (WxHxD)	Body	mm	1,562 x 460 x 688	
		inch	61-1/2 x 18-1/8 x 27-3/32	
Coil	Rows x Columns x FPI		3 x 21 x 19	
	Face Area	m ²	0.59	
Fan	Type		Sirocco Fan	
	Motor Output x Number	W	375 x 2	
	Air Flow Rate (H / M / L) (Factory set)	m ³ /min	60.0 / 50.0 / 50.0	72.0 / 64.0 / 64.0
		ft ³ /min	2,119 / 1,766 / 1,766	2542 / 2,260 / 2,260
	External Static Pressure	mmAq(Pa)	22(216)	22(216)
	External Static Pressure (Min ~ Max)	mmAq (Pa)	10(98) ~ 25(245)	10(98) ~ 25(245)
	Air Flow Rate (H / M / L) (Standard Mode)	m ³ /min	64.0 / 50.0 / 50.0	76.0 / 64.0 / 64.0
		ft ³ /min	2,260 / 1,766 / 1,766	2,684 / 2,260 / 2,260
	External Static Pressure	mmAq(Pa)	15(147)	15(147)
Drive		Direct	Direct	
Motor type		BLDC	BLDC	
Temperature Control			Microprocessor, Thermostat for cooling and heating	
Sound Absorbing Thermal Insulation Material			Foamed polystyrene	
Air Filter			Long Life Filter	
Safety Device			Fuse	
Pipe Connections	Liquid Side	mm(inch)	Ø9.52(3/8)	
	Gas Side	mm(inch)	Ø19.05(3/4)	
	Drain Pipe(Internal Dia.)	mm(inch)	25(1)	
Net Weight		kg(lbs)	87(192)	
Sound Pressure Levels (H / M / L)		dB(A)	45 / 41 / 40	
Sound Power Levels (H / M / L)		dB(A)	67 / 62 / 60	
Power Supply		Ø, V, Hz	1, 220 - 230 - 240, 50/60	
Running Current by voltage	Rated	A	4.64 - 4.43 - 4.25	
Maximum Running Current		A	5.20	
Refrigerant	Type	-	R410A / R32	
	Additional Charging Amount (CF Value of IDU)	kg(each)	1.00 / 0.83	
	Control	-	EEV	
Transmission cable		mm ²	1.0~1.5 x 2C	

Note

- Due to our policy of innovation some specifications may be changed without notification.
- Wiring cable size must comply with the applicable local and national code. And "Electric characteristics" chapter should be considered for electrical work and design. Especially the power cable and circuit breaker should be selected in accordance with that.
- Sound pressure level is measured on the rated condition in the anechoic rooms by ISO 3745 standard.
Sound power level is measured on the rated condition in the semi-anechoic rooms by ISO 9614 standard.
Therefore, these values can be increased owing to ambient conditions during operation.
- Capacities are net capacities and based on the following conditions. Refer to the Outdoor Unit Specifications for calculating the real capacity.
 - Cooling : Indoor Ambient Temp. 27°CDB / 19°CWB, Outdoor Ambient Temp. 35°CDB / 24°CWB
 - Heating : Indoor Ambient Temp. 20°CDB / 15°CWB, Outdoor Ambient Temp. 7°CDB / 6°CWB
 - Interconnected Pipe is standard length and difference of Elevation (Outdoor ~ Indoor Unit) is 0m.
- Refrigerant information (type, additional charging amount, etc.) must be applied by refrigerant type of the combined outdoor unit.
Adapt after checking the specifications of outdoor unit.
- Sound pressure levels are measured at External Static Pressure condition like below.
 - ARNU76GB8A4 / ARNU96GB8A4 (H/M/L) : 220Pa / 150Pa / 120Pa

3. Dimensions & Gravity point

3.1 Dimensional Drawings

ARNU07GM1A4 / ARNU09GM1A4 / ARNU12GM1A4

ARNU15GM1A4 / ARNU18GM1A4 / ARNU24GM1A4

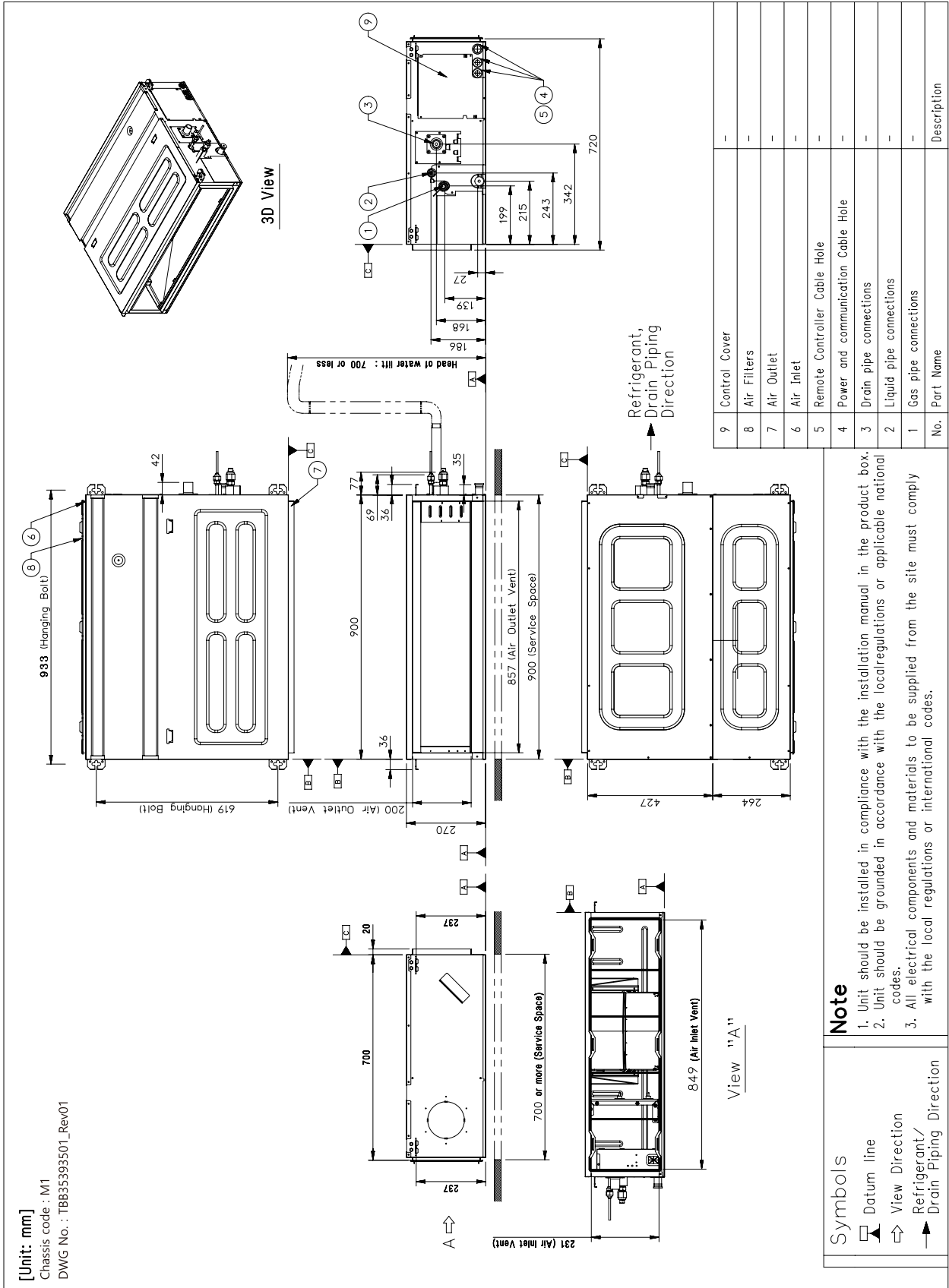

3. Dimensions & Gravity point

ARNU28GM2A4 / ARNU36GM2A4 / ARNU42GM2A4

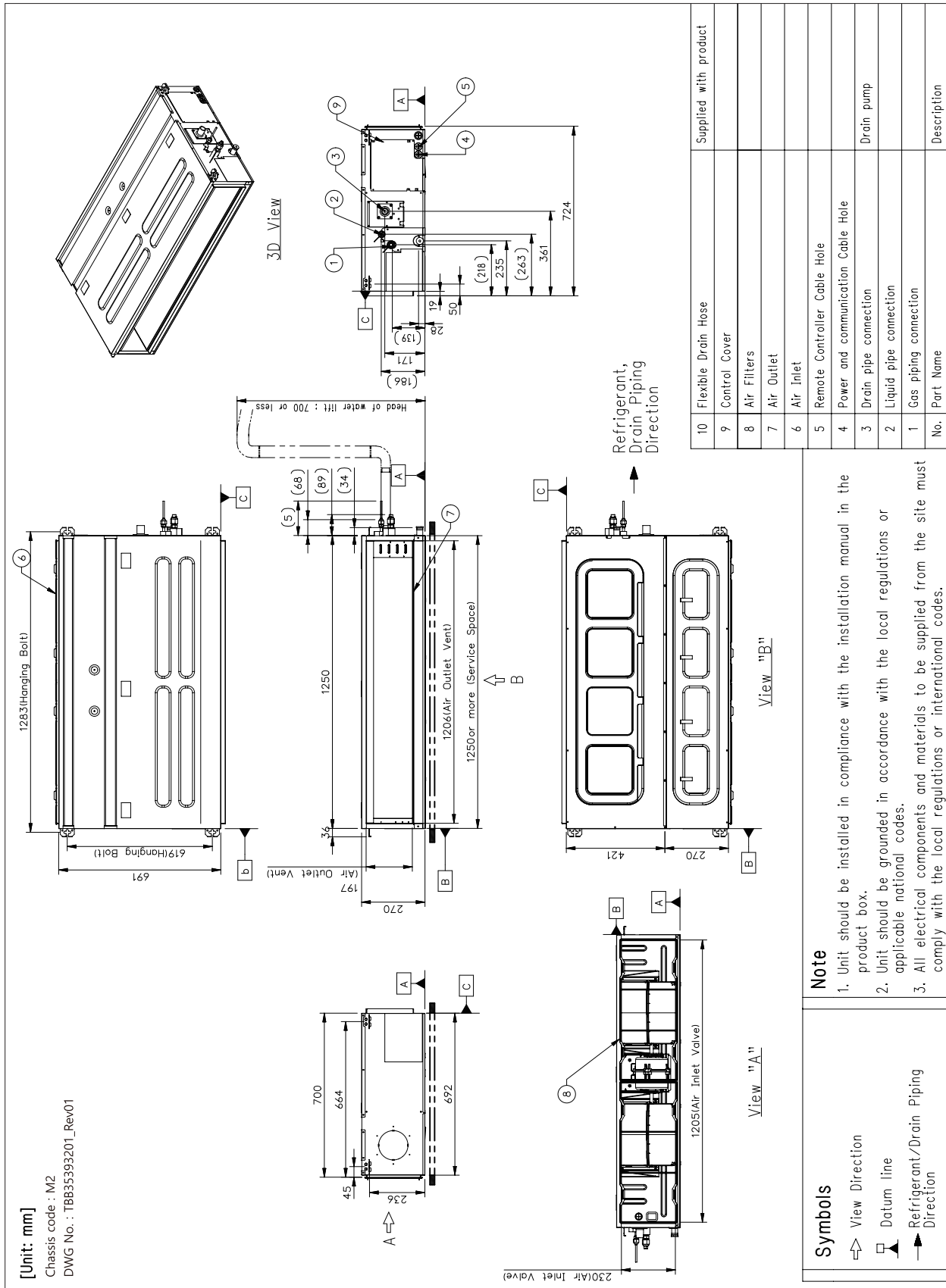

3. Dimensions & Gravity point

ARNU48GM3B4 / ARNU54GM3B4

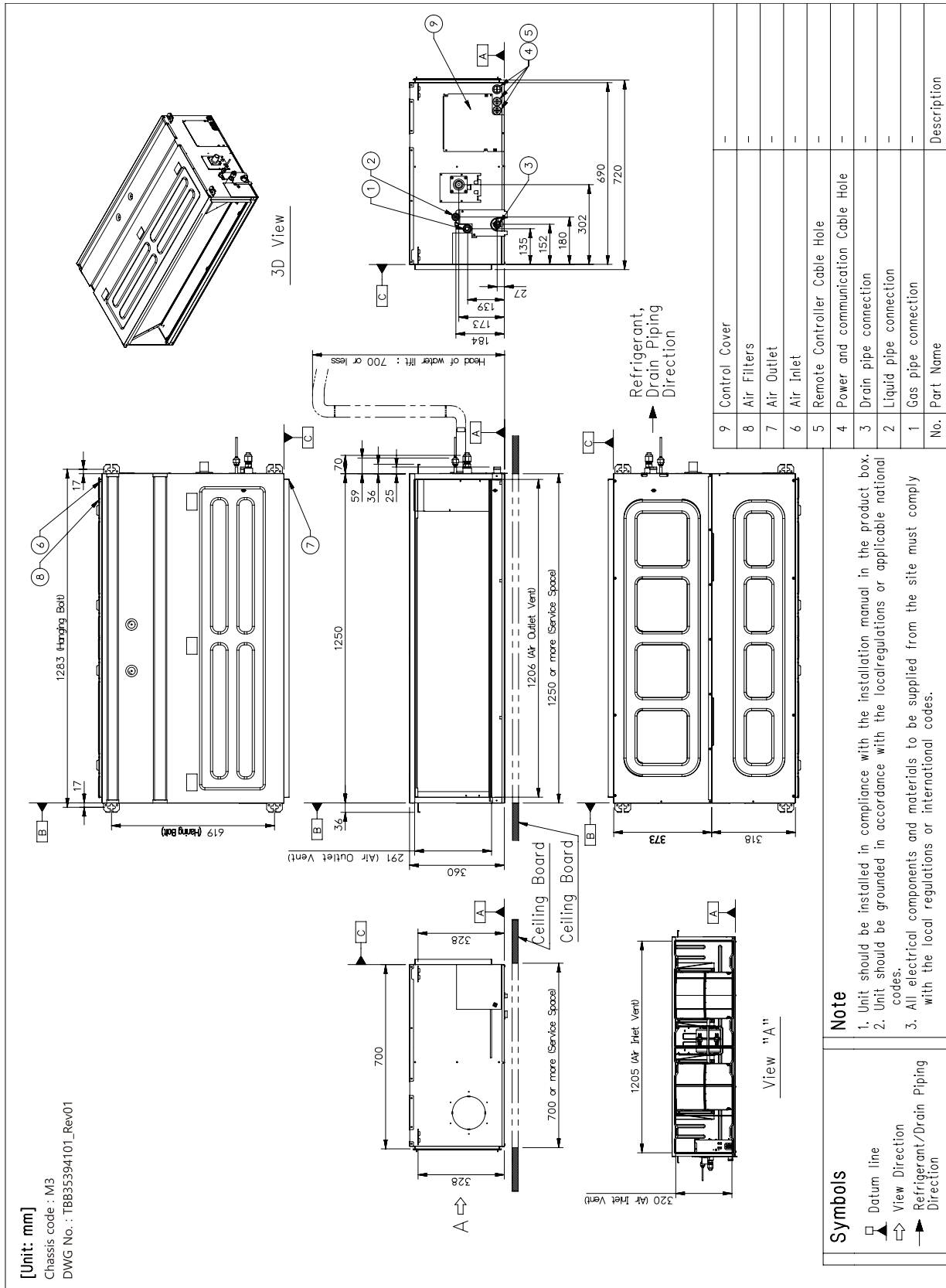

3. Dimensions & Gravity point

ARNU76GB8A4 / ARNU96GB8A4

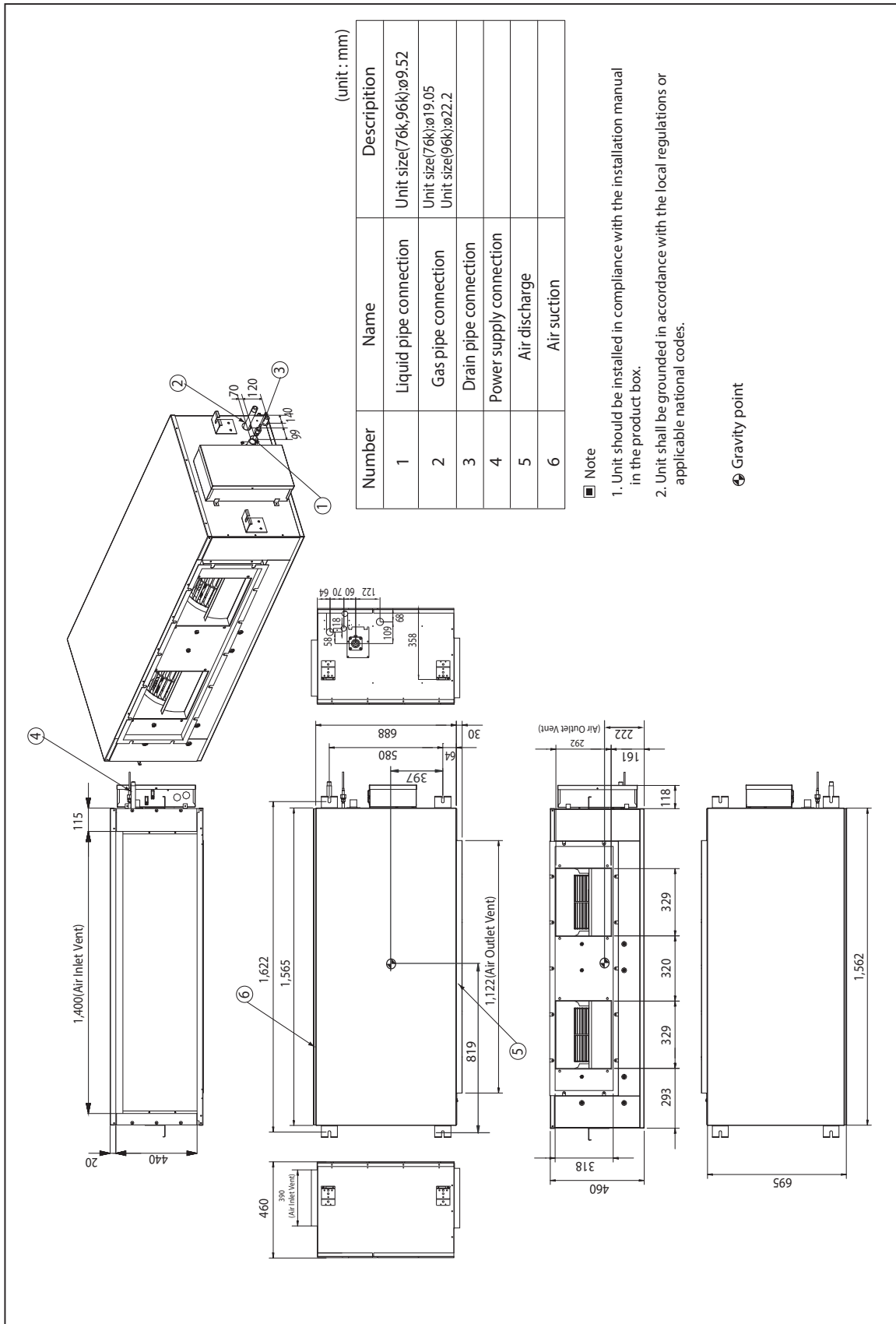

3. Dimensions & Gravity point

3.2 Installation Space

Top view
[Unit: mm(inch)]

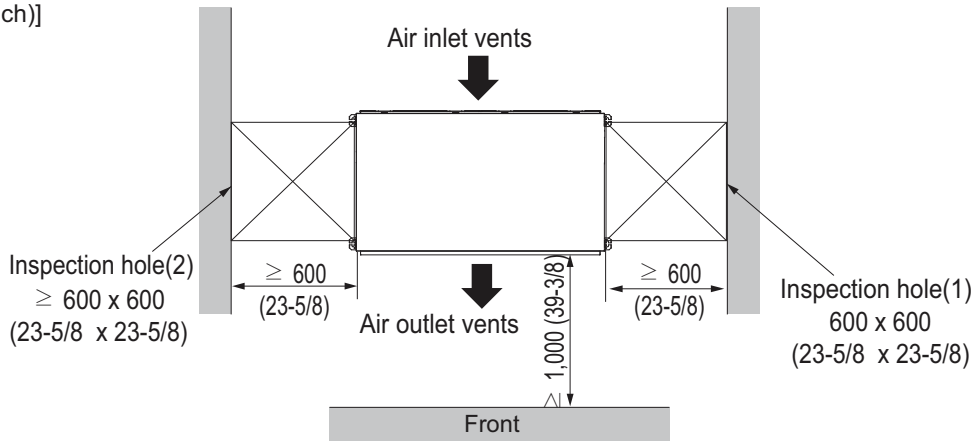

* If distance between false ceiling and actual ceiling is more than 100cm (39-3/8 inch), the number of inspection hole could be decreased to 1. But if that is less than 20cm (7-7/8 inch), the hole size should be more than size of Indoor Unit.

Front view
[Unit: mm(inch)]

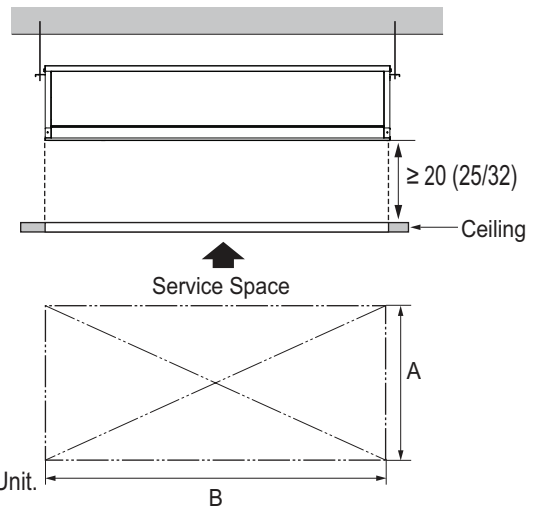
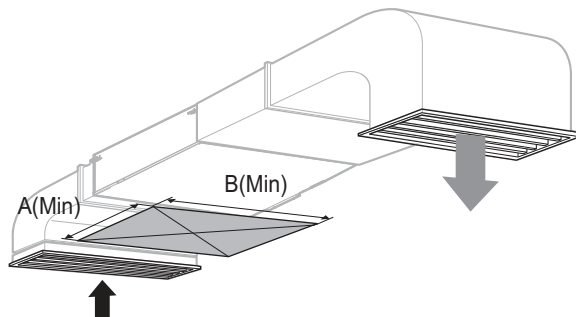

* If distance between false ceiling and actual ceiling is less than 20cm (7-7/8 inch), the hole size should be more than size of Indoor Unit.

* These figures are representative. Actual appearance of indoor unit may be different but clearances will stay the same.

Note

- Places where products are installed should not be any obstacles to the air circulation or installation. Ensure the spaces from the wall, ceiling, or other obstacles.
- According to type of indoor unit, external appearance or installed structure could be different.
- According to product type, model line up, sales region..etc, applicability of each chassis could be different.
- Install certainly the decoration panel. Cool air leakage causes sweating or falling of water-drops.

4. Piping Diagrams

■ M1, M2, M3 Chassis

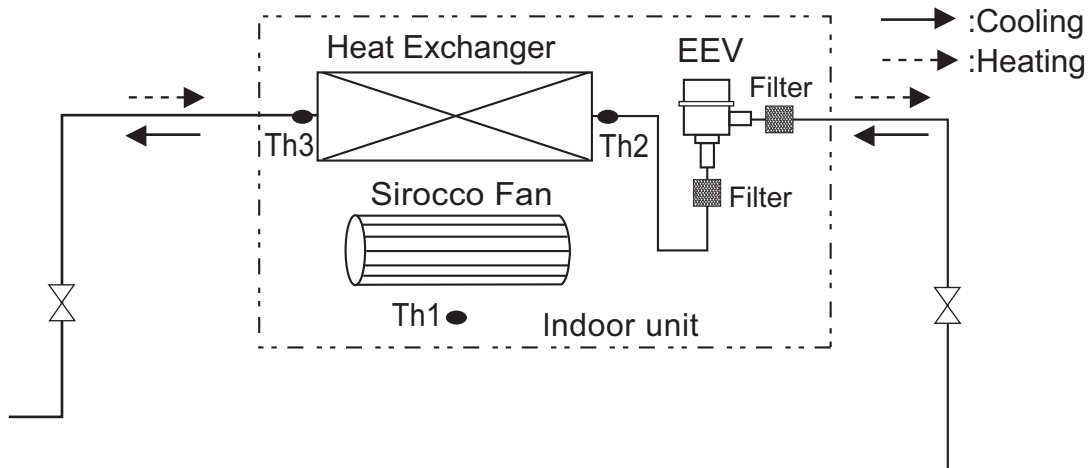

◆ Refrigerant pipe connection port diameter

Model	Gas [mm(inch)]	Liquid [mm(inch)]
ARNU07GM1A4	Ø12.7(1/2)	Ø6.35(1/4)
ARNU09GM1A4	Ø12.7(1/2)	Ø6.35(1/4)
ARNU12GM1A4	Ø12.7(1/2)	Ø6.35(1/4)
ARNU15GM1A4	Ø12.7(1/2)	Ø6.35(1/4)
ARNU18GM1A4	Ø12.7(1/2)	Ø6.35(1/4)
ARNU24GM1A4	Ø15.88(5/8)	Ø9.52(3/8)
ARNU28GM2A4	Ø15.88(5/8)	Ø9.52(3/8)
ARNU36GM2A4	Ø15.88(5/8)	Ø9.52(3/8)
ARNU42GM2A4	Ø15.88(5/8)	Ø9.52(3/8)
ARNU48GM3B4	Ø15.88(5/8)	Ø9.52(3/8)
ARNU54GM3B4	Ø19.05(3/4)	Ø9.52(3/8)

LOC.	Description
Th1	Thermistor for room air temperature
Th2	Thermistor for pipe in temperature
Th3	Thermistor for pipe out temperature

4. Piping Diagrams

■ B8 Chassis

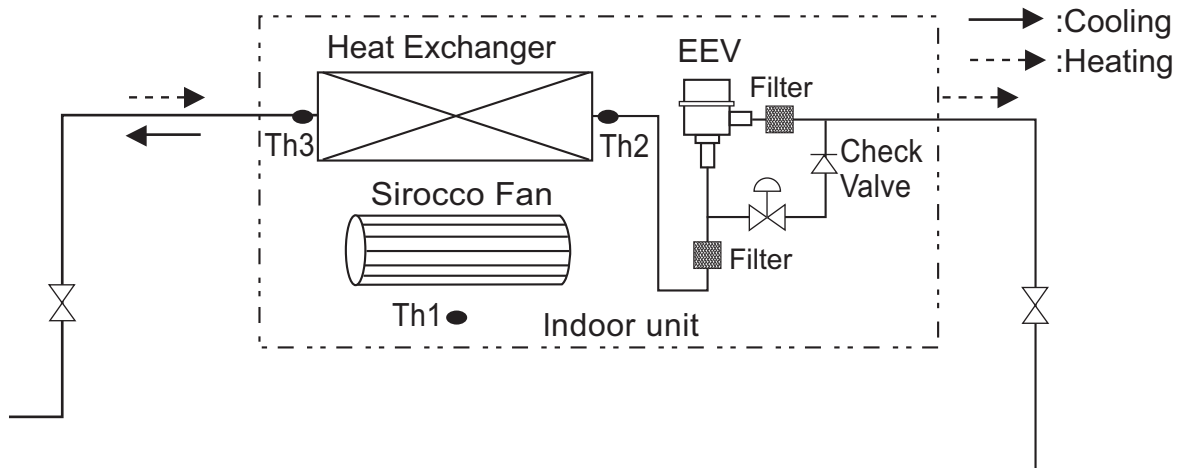

◆ Refrigerant pipe connection port diameter

Model	Gas [mm(inch)]	Liquid [mm(inch)]
ARNU76GB8A4	Ø19.05(3/4)	Ø9.52(3/8)
ARNU96GB8A4	Ø22.2(7/8)	Ø9.52(3/8)

LOC.	Description
Th1	Thermistor for room air temperature
Th2	Thermistor for pipe in temperature
Th3	Thermistor for pipe out temperature

5. Wiring Diagrams

M1 Chassis

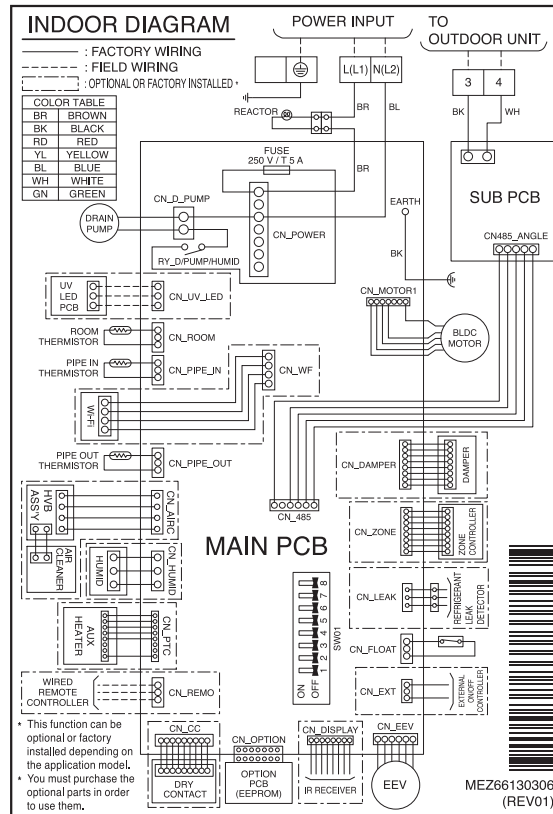

CONNECTOR NUMBER	LOCATION POINT	FUNCTION
CN-POWER	AC Power supply	AC Power line input for indoor controller
CN-MOTOR1	Fan motor output	Motor output of BLDC
CN-MOTOR2	Fan motor output	Motor output of BLDC
CN-D_PUMP	Drain pump output	AC output for drain pump
CN-COM	Communication	Connection between indoor and outdoor
CN-EEV	EEV Output	EEV Control output : connect to EEV directly or through IPM(Independent Power Module)
CN-LEAK	Refrigerant leak detector	Refrigerant leak detector line
CN-FLOAT	Float switch input	Float switch sensing
CN-PIPE_IN	Suction pipe sensor	Pipe in thermistor
CN-PIPE_OUT	Discharge pipe sensor	Pipe out thermistor
CN-ROOM	Room sensor	Room air thermistor
CN-REMO	Remote controller	Remote control line
CN-ZONE	Zontroller	Zone control line
CN-DISPLAY	RF Remote controller	RF Remote control line
CN-CC	Dry contact	Dry contact line
CN-EXT	External On/Off	External On/Off signal input
CN_WF	Wi-Fi Controller	Wifi control line
CN_HUMID	Humidity sensor	Humid sensing
CN_UV_LED	UV LED PCB	UV LED

	Function	Description	Setting Off	Setting On	Default
SW1	Communication	N/A (Default)	-	-	Off
SW2	Cycle	N/A (Default)	-	-	Off
SW3	Group Control	Selection of Master or Slave	Master	Slave	Off
SW4	Dry Contact Mode	Selection of Dry Contact Mode	Wired/Wireless remote controller selection of Manual or Auto operation Mode	Auto	Off
SW5	Installation	Fan continuous operation	Continuous operation Removal	-	Off
SW6	Heater linkage	N/A	-	-	Off
SW7	Ventilator linkage	Selection of Ventilator linkage	Linkage Removal	Working	Off
	Vane selection (Console)	Selection of up/down side Vane	Up side + Down side Vane	Up side Vane Only	
SW8	Region selection	Selection tropical region	General model	Tropical model	Off
	Etc.	Spare	-	-	

5. Wiring Diagrams

CAUTION

For Multi V Models, DIP switch 1, 2, 6, 8 must be set OFF.

5. Wiring Diagrams

M2 Chassis

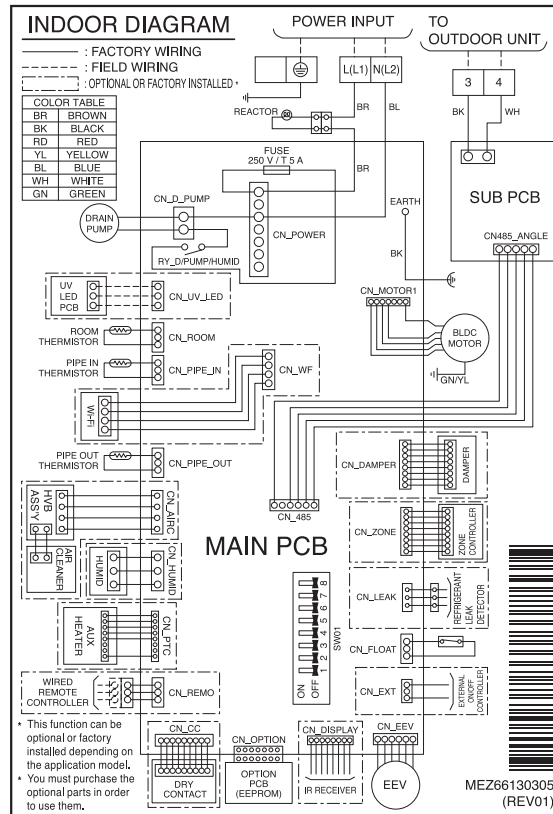

CONNECTOR NUMBER	LOCATION POINT	FUNCTION
CN-POWER	AC Power supply	AC Power line input for indoor controller
CN-MOTOR1	Fan motor output	Motor output of BLDC
CN-MOTOR2	Fan motor output	Motor output of BLDC
CN-D_PUMP	Drain pump output	AC output for drain pump
CN-COM	Communication	Connection between indoor and outdoor
CN-EEV	EEV Output	EEV Control output : connect to EEV directly or through IPM(Independent Power Module)
CN-LEAK	Refrigerant leak detector	Refrigerant leak detector line
CN-FLOAT	Float switch input	Float switch sensing
CN-PIPE_IN	Suction pipe sensor	Pipe in thermistor
CN-PIPE_OUT	Discharge pipe sensor	Pipe out thermistor
CN-ROOM	Room sensor	Room air thermistor
CN-REMO	Remote controller	Remote control line
CN-ZONE	Zontroller	Zone control line
CN-DISPLAY	RF Remote controller	RF Remote control line
CN-CC	Dry contact	Dry contact line
CN-EXT	External On/Off	External On/Off signal input
CN_WF	Wi-Fi Controller	Wifi control line
CN_HUMID	Humidity sensor	Humid sensing
CN_UV_LED	UV LED PCB	UV LED

	Function	Description	Setting Off	Setting On	Default
SW1	Communication	N/A (Default)	-	-	Off
SW2	Cycle	N/A (Default)	-	-	Off
SW3	Group Control	Selection of Master or Slave	Master	Slave	Off
SW4	Dry Contact Mode	Selection of Dry Contact Mode	Wired/Wireless remote controller selection of Manual or Auto operation Mode	Auto	Off
SW5	Installation	Fan continuous operation	Continuous operation Removal	-	Off
SW6	Heater linkage	N/A	-	-	Off
SW7	Ventilator linkage	Selection of Ventilator linkage	Linkage Removal	Working	Off
	Vane selection (Console)	Selection of up/down side Vane	Up side + Down side Vane	Up side Vane Only	
SW8	Region selection	Selection tropical region	General model	Tropical model	Off
	Etc.	Spare	-	-	

5. Wiring Diagrams

 **CAUTION**

For Multi V Models, DIP switch 1, 2, 6, 8 must be set OFF

5. Wiring Diagrams

M3 Chassis (M3B4)

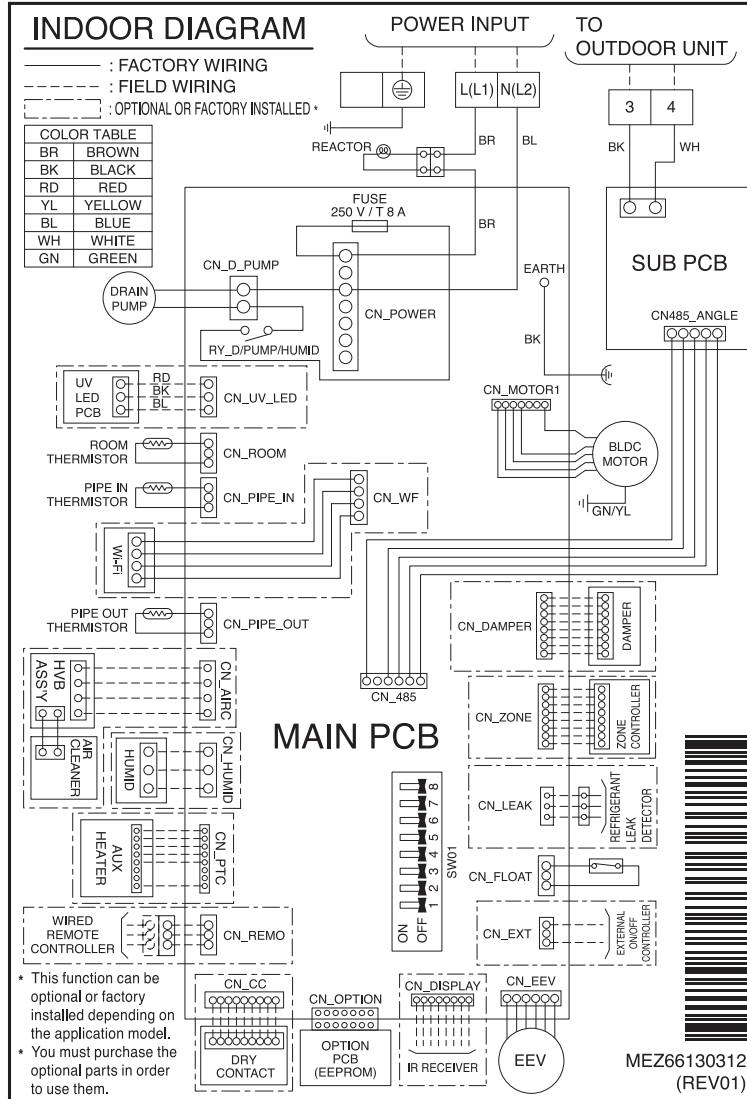

CONNECTOR NUMBER	LOCATION POINT	FUNCTION
CN-POWER	AC Power supply	AC Power line input for indoor controller
CN-MOTOR1	Fan motor output	Motor output of BLDC
CN-MOTOR2	Fan motor output	Motor output of BLDC
CN-D_PUMP	Drain pump output	AC output for drain pump
CN-COM	Communication	Connection between indoor and outdoor
CN-EEV	EEV Output	EEV Control output : connect to EEV directly or through IPM(Independent Power Module)
CN-LEAK	Refrigerant leak detector	Refrigerant leak detector line
CN-FLOAT	Float switch input	Float switch sensing
CN-PIPE_IN	Suction pipe sensor	Pipe in thermistor
CN-PIPE_OUT	Discharge pipe sensor	Pipe out thermistor
CN-ROOM	Room sensor	Room air thermistor
CN-REMO	Remote controller	Remote control line
CN-ZONE	Zontroller	Zone control line
CN-DISPLAY	RF Remote controller	RF Remote control line
CN-CC	Dry contact	Dry contact line
CN-EXT	External On/Off	External On/Off signal input
CN_WF	Wi-Fi Controller	Wifi control line
CN_HUMID	Humidity sensor	Humid sensing
CN_UV_LED	UV LED PCB	UV LED

	Function	Description	Setting Off	Setting On	Default
SW1	Communication	N/A (Default)	-	-	Off
SW2	Cycle	N/A (Default)	-	-	Off

5. Wiring Diagrams

	Function	Description	Setting Off	Setting On	Default
SW3	Group Control	Selection of Master or Slave	Master	Slave	Off
SW4	Dry Contact Mode	Selection of Dry Contact Mode	Wired/Wireless remote controller selection of Manual or Auto operation Mode	Auto	Off
SW5	Installation	Fan continuous operation	Continuous operation Removal	-	Off
SW6	Heater linkage	N/A	-	-	Off
SW7	Ventilator linkage	Selection of Ventilator linkage	Linkage Removal	Working	Off
	Vane selection (Console)	Selection of up/down side Vane	Up side + Down side Vane	Up side Vane Only	
	Region selection	Selection tropical region	General model	Tropical model	
SW8	Etc.	Spare	-	-	Off

CAUTION

For Multi V Models, DIP switch 1, 2, 6, 8 must be set OFF

5. Wiring Diagrams

B8 Chassis

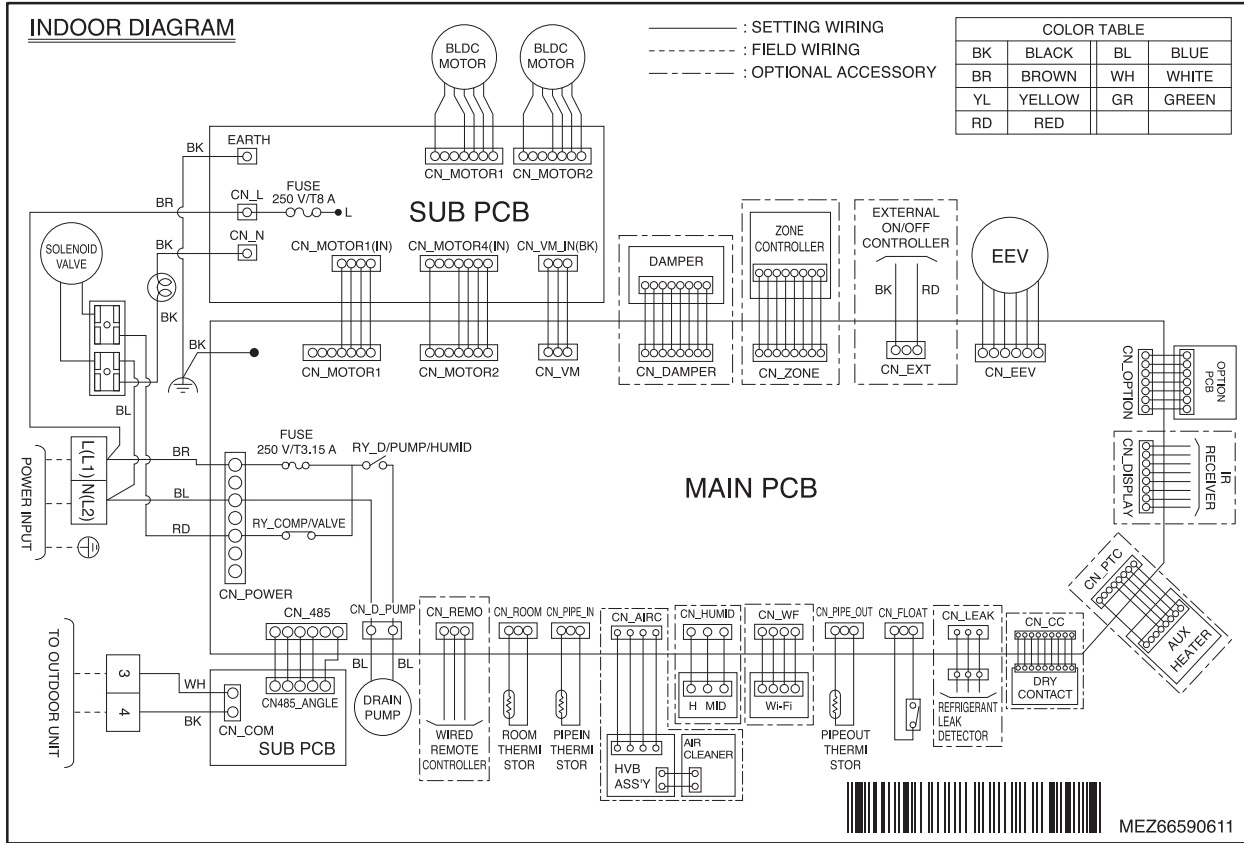

CONNECTOR NUMBER	LOCATION POINT	FUNCTION
CN-POWER	AC Power supply	AC Power line input for indoor controller
CN-MOTOR1, CN-MOTOR2	Fan motor output	Motor output of BLDC
CN-D/PUMP	Drain pump output	AC Output for drain pump
CN-COM	Communication	Connection between indoor and outdoor
CN-EEV	EEV Output	EEV Control output : connect to EEV directly or through IPM(Independent Power Module)
CN-LEAK	Refrigerant leak detector	Refrigerant leak detector line
CN-FLOAT	Float switch input	Float switch sensing
CN-PIPE/IN	Suction pipe sensor	Pipe in thermistor
CN-PIPE/OUT	Discharge pipe sensor	Pipe out thermistor
CN-ROOM	Room sensor	Room thermistor
CN-REMO	Remote controller	Remote control line
CN-CC	Dry contact	Dry contact line
CN-DISPLAY	RF Remocon	RF Remocon receiver
CN-OPTION	Option PCB	Option PCB connector
CN-ZONE	Zone controller	Zone controller line
CN-EXT	External On/Off	External On/Off signal input
CN_WF	Wi-Fi Controller	Wifi control line
CN_HUMID	Humid sensor	Humid sensing

5. Wiring Diagrams

	Function	Description	Setting Off	Setting On	Default
SW1	Communication	N/A (Default)	-	-	Off
SW2	Cycle	N/A (Default)	-	-	Off
SW3	Group Control	Selection of Master or Slave	Master	Slave	Off
SW4	Dry Contact Mode	Selection of Dry Contact Mode	Wired/Wireless remote controller selection of Manual or Auto operation Mode	Auto	Off
SW5	Installation	Fan continuous operation	Continuous operation Removal	-	Off
SW6	Heater linkage	N/A	-	-	Off
SW7	Ventilator linkage	Selection of Ventilator linkage	Linkage Removal	Working	Off
	Vane selection (Console)	Selection of up/down side Vane	Up side + Down side Vane	Up side Vane Only	
	Region selection	Selection tropical region	General model	Tropical model	
SW8	Etc.	Spare	-	-	Off

CAUTION

For Multi V Models, DIP switch 1, 2, 6, 8 must be set OFF

6. Capacity Table

■ Cooling Capacity

◆ M1 / M2 / M3 Chassis

Nominal Capacity (kBtu/h) [Capacity Index (kW)]	Indoor air temp. (DB/WB, °C)													
	20		23		26		27		28		30		32	
	14		16		18		19		20		22		24	
	TC	SHC	TC	SHC	TC	SHC	TC	SHC	TC	SHC	TC	SHC	TC	SHC
7 [2.2]	1.5	1.4	1.8	1.5	2.0	1.7	2.2	1.7	2.4	1.8	2.4	1.7	2.4	1.5
9 [2.8]	1.9	1.8	2.2	2.0	2.6	2.2	2.8	2.2	3.0	2.3	3.0	2.2	3.1	2.0
12 [3.6]	2.4	2.3	2.9	2.5	3.3	2.7	3.6	2.8	3.9	2.9	3.9	2.7	4.0	2.5
15 [4.5]	3.0	2.9	3.6	3.2	4.2	3.4	4.5	3.5	4.8	3.6	4.9	3.4	4.9	3.2
18 [5.6]	3.8	3.4	4.5	3.7	5.2	4.0	5.6	4.1	6.0	4.2	6.0	4.0	6.2	3.6
24 [7.1]	4.8	4.3	5.7	4.7	6.6	5.1	7.1	5.2	7.6	5.3	7.7	5.0	7.8	4.6
28 [8.2]	5.5	5.0	6.6	5.5	7.7	6.0	8.2	6.1	8.7	6.2	8.9	5.9	9.0	5.4
36 [10.6]	7.2	6.4	8.5	7.1	9.9	7.7	10.6	7.8	11.3	8.1	11.4	7.6	11.7	7.0
42 [12.3]	8.3	7.5	9.9	8.3	11.5	9.0	12.3	9.1	13.1	9.4	13.3	8.8	13.5	8.1
48 [14.1]	9.5	8.7	11.3	9.6	13.2	10.4	14.1	10.6	15.0	10.9	15.2	10.3	15.5	9.4
54 [15.8]	10.7	10.1	12.7	11.1	14.7	12.1	15.8	12.3	16.9	12.8	17.1	12.1	17.4	11.1

◆ B8 Chassis

Nominal Capacity (kBtu/h) [Capacity Index (kW)]	Indoor air temp. (DB/WB, °C)													
	20		23		26		27		28		30		32	
	14		16		18		19		20		22		24	
	TC	SHC	TC	SHC	TC	SHC	TC	SHC	TC	SHC	TC	SHC	TC	SHC
76 [22.4]	15.1	12.9	18.0	14.2	20.8	15.4	22.4	15.7	24.0	16.3	24.3	15.4	24.6	14.2
96 [28.0]	18.9	16.1	22.5	17.7	26.0	19.2	28.0	19.6	30.0	20.4	30.4	19.2	30.8	17.7

Note

1. TC: Total Capacity(kW), SHC: Sensible Heat Capacity(kW)
2. Capacity tables show the average value of conditions which may occur.
3. Refer to Capacity tables and correction factor in the outdoor unit PDB for the actual performance data of each indoor unit and outdoor unit combination.

■ Heating Capacity

◆ M1 / M2 / M3 / B8 Chassis

Nominal Capacity (kBtu/h) [Capacity Index (kW)]	Indoor air temp. (DB, °C)					
	16	18	20	21	22	24
	TC	TC	TC	TC	TC	TC
7 [2.2]	2.8	2.7	2.5	2.4	2.3	2.2
9 [2.8]	3.6	3.4	3.2	3.1	3.0	2.8
12 [3.6]	4.5	4.3	4.0	3.9	3.7	3.5
15 [4.5]	5.6	5.3	5.0	4.8	4.7	4.4
18 [5.6]	7.1	6.7	6.3	6.1	5.9	5.5
24 [7.1]	9.0	8.5	8.0	7.7	7.5	7.0
28 [8.2]	10.4	9.8	9.2	8.9	8.6	8.0
36 [10.6]	13.4	12.7	11.9	11.5	11.1	10.4
42 [12.3]	15.6	14.7	13.8	13.4	12.9	12.0
48 [14.1]	17.9	16.9	15.9	15.4	14.9	13.9
54 [15.8]	20.3	19.2	18.0	17.4	16.8	15.7
76 [22.4]	28.4	26.8	25.2	24.4	23.6	22.0
96 [28.0]	35.5	33.5	31.5	30.5	29.5	27.5

Note

1. TC: Total Capacity(kW)
2. Capacity tables show the average value of conditions which may occur.
3. Refer to Capacity tables and correction factor in the outdoor unit PDB for the actual performance data of each indoor unit and outdoor unit combination.

7. External Static Pressure(E.S.P) & Air Flow

◆ ARNU07GM1A4

PQ Curve

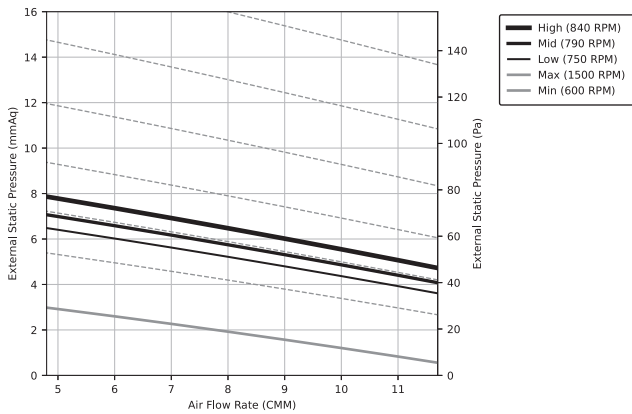

Auto E.S.P Setting Range

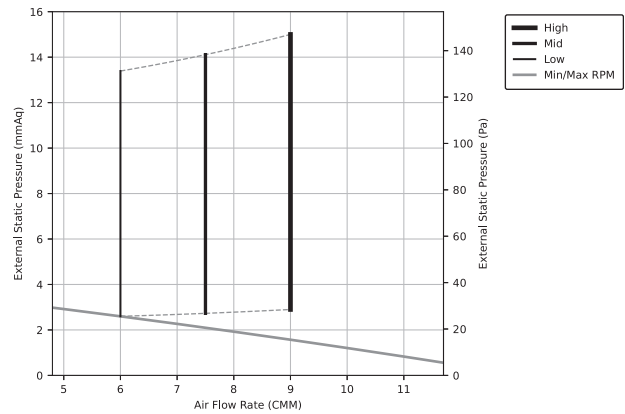

◆ ARNU09GM1A4

PQ Curve

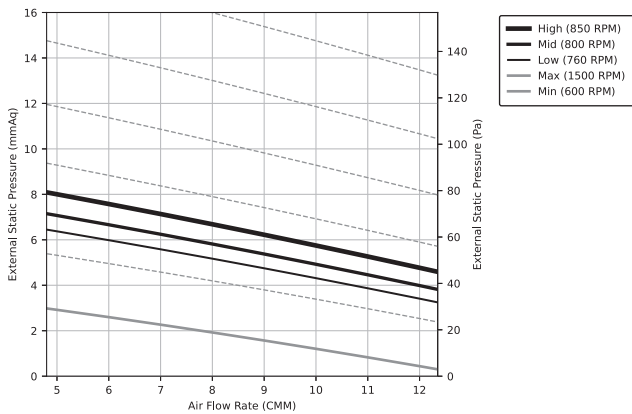

Auto E.S.P Setting Range

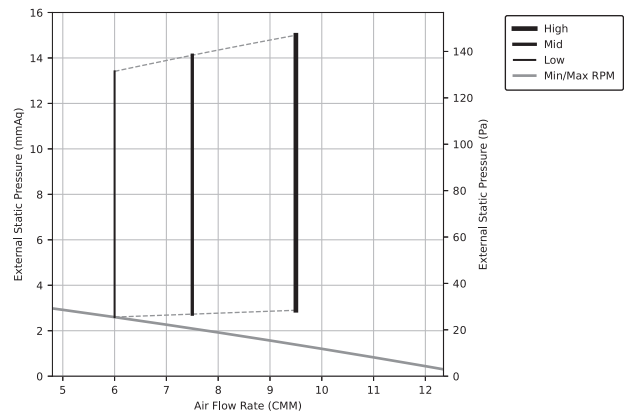

Note

1. Each dash line represents for each 100 RPM step
2. If operation range is out of auto E.S.P setting range, air flow rate should be adjusted manually by wired remotecontroller. (ESP Set Value = RPM / 10)
For more information, please see the installation manual.
3. The above P-Q Curve shows available E.S.P. range. If the E.S.P value is out of min/max RPM at desired air flow, indoor components could be failed and performance would be decreased.
4. Automatic constant air volume is a function that controls air volume automatically when installation, and the air volume is not set automatically during operation.

7. External Static Pressure(E.S.P) & Air Flow

◆ ARNU12GM1A4

PQ Curve

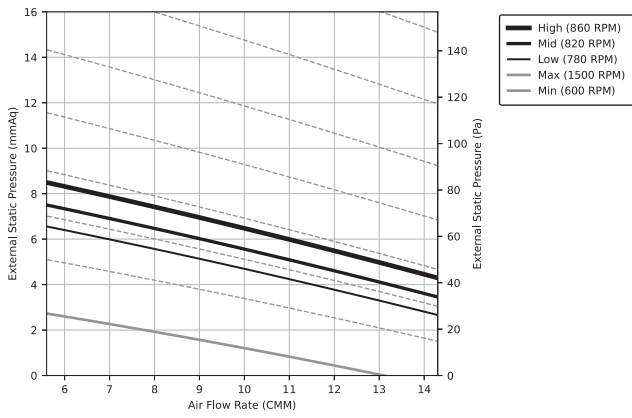

Auto E.S.P Setting Range

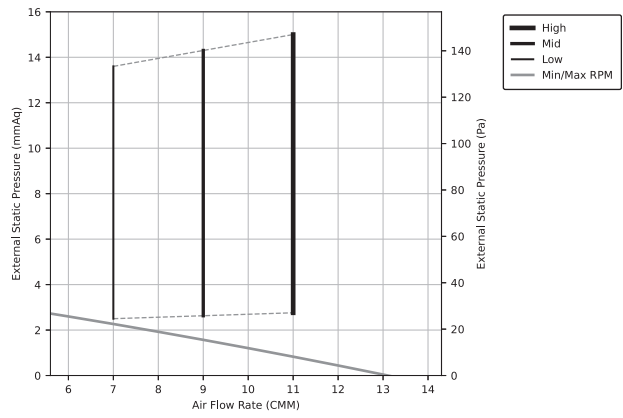

◆ ARNU15GM1A4

PQ Curve

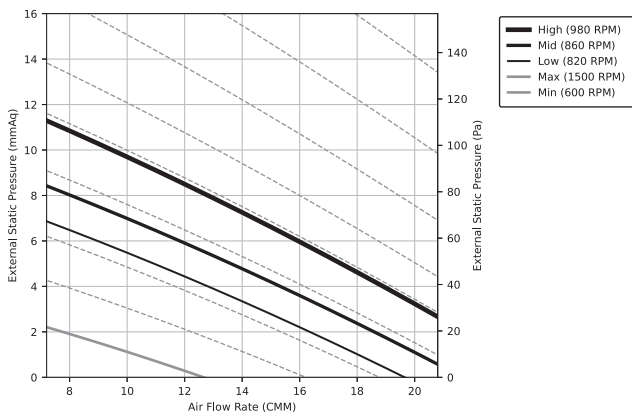

Auto E.S.P Setting Range

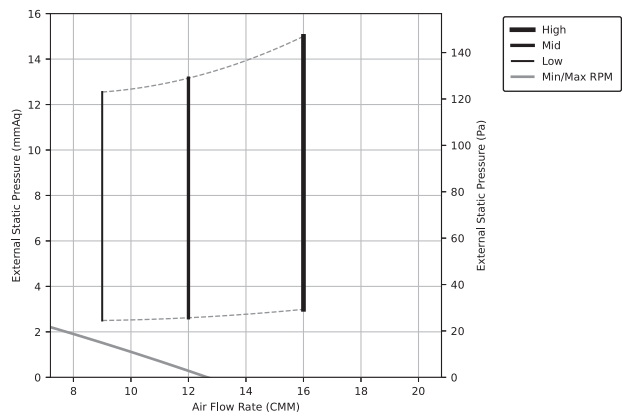

Note

1. Each dash line represents for each 100 RPM step
2. If operation range is out of auto E.S.P setting range, air flow rate should be adjusted manually by wired remotecontroller. (ESP Set Value = RPM / 10)
For more information, please see the installation manual.
3. The above P-Q Curve shows available E.S.P. range. If the E.S.P value is out of min/max RPM at desired air flow, indoor components could be failed and performance would be decreased.
4. Automatic constant air volume is a function that controls air volume automatically when installation, and the air volume is not set automatically during operation.

7. External Static Pressure(E.S.P) & Air Flow

◆ ARNU18GM1A4

PQ Curve

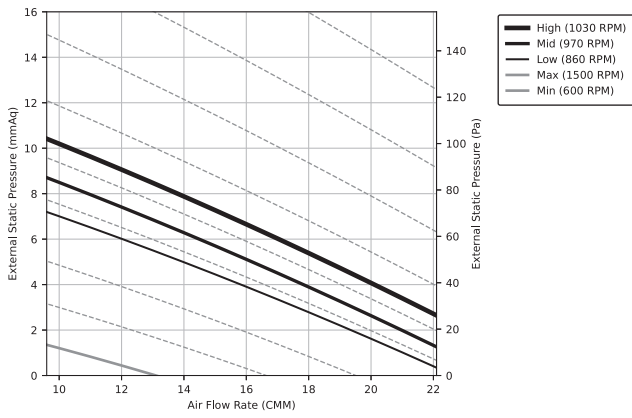

Auto E.S.P Setting Range

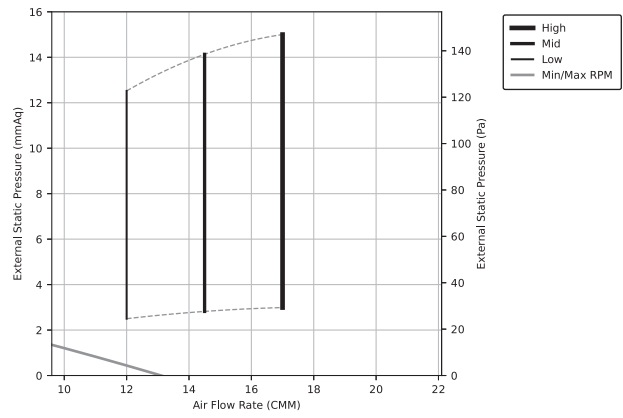

◆ ARNU24GM1A4

PQ Curve

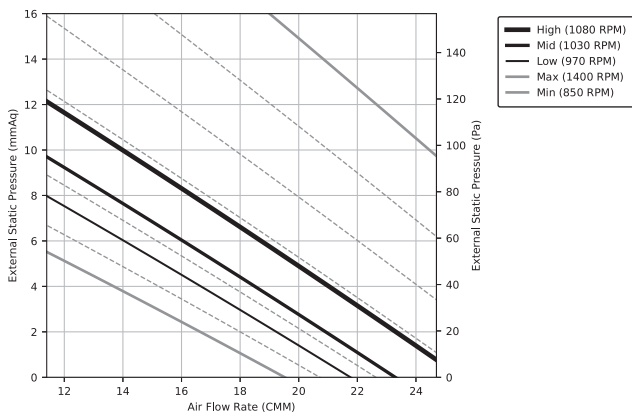

Auto E.S.P Setting Range

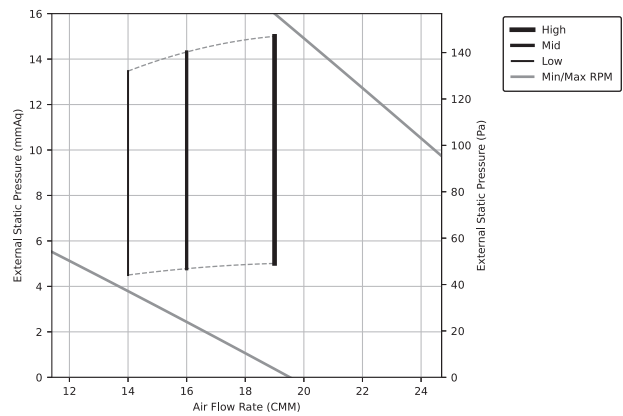

Note

1. Each dash line represents for each 100 RPM step
2. If operation range is out of auto E.S.P setting range, air flow rate should be adjusted manually by wired remotecontroller. (ESP Set Value = RPM / 10)
For more information, please see the installation manual.
3. The above P-Q Curve shows available E.S.P. range. If the E.S.P value is out of min/max RPM at desired air flow, indoor components could be failed and performance would be decreased.
4. Automatic constant air volume is a function that controls air volume automatically when installation, and the air volume is not set automatically during operation.

7. External Static Pressure(E.S.P) & Air Flow

◆ ARNU18GM1A4

PQ Curve

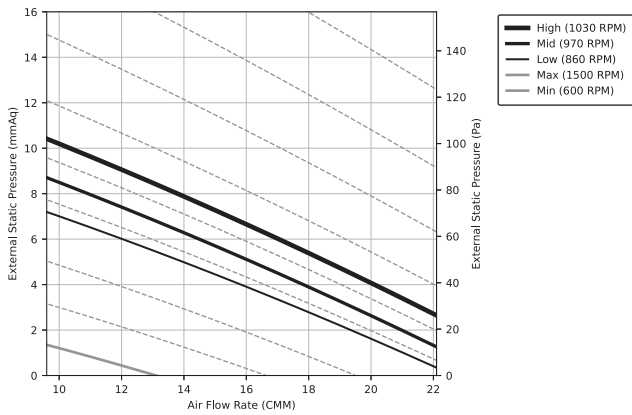

Auto E.S.P Setting Range

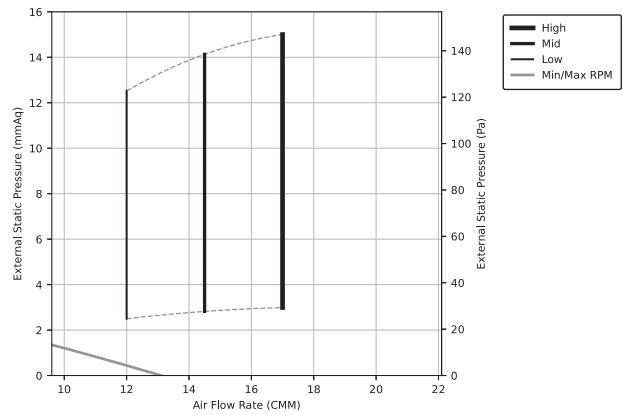

◆ ARNU24GM1A4

PQ Curve

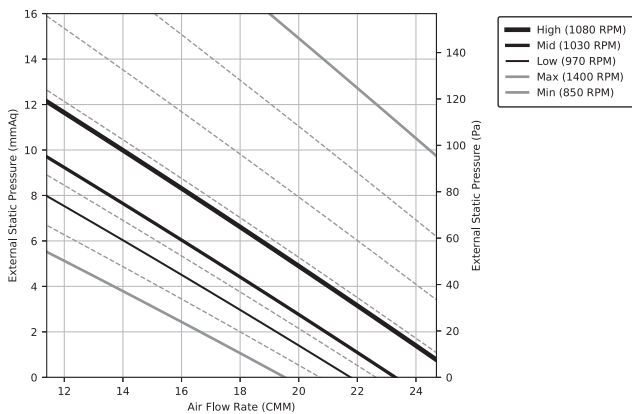

Auto E.S.P Setting Range

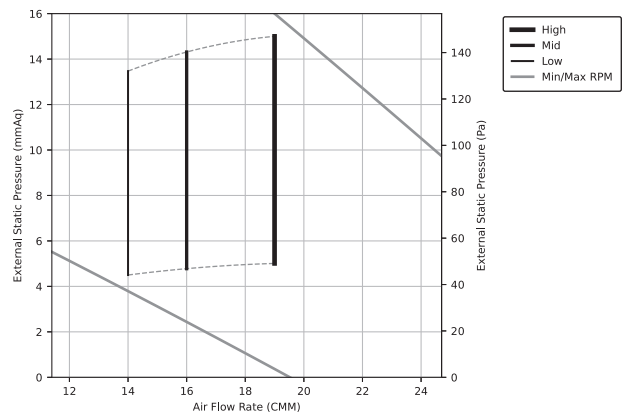

Note

1. Each dash line represents for each 100 RPM step
2. If operation range is out of auto E.S.P setting range, air flow rate should be adjusted manually by wired remotecontroller. (ESP Set Value = RPM / 10)
For more information, please see the installation manual.
3. The above P-Q Curve shows available E.S.P. range. If the E.S.P value is out of min/max RPM at desired air flow, indoor components could be failed and performance would be decreased.
4. Automatic constant air volume is a function that controls air volume automatically when installation, and the air volume is not set automatically during operation.

7. External Static Pressure(E.S.P) & Air Flow

◆ ARNU28GM2A4

PQ Curve

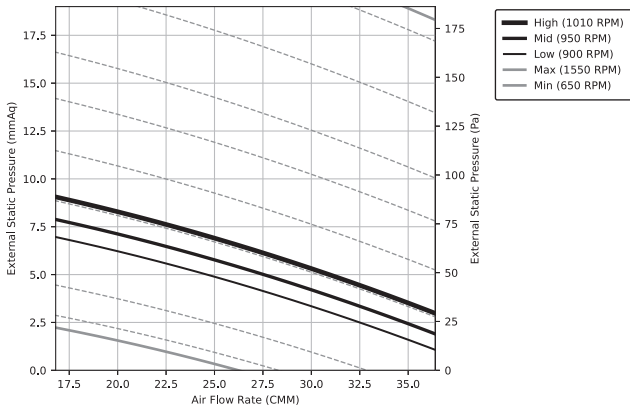

Auto E.S.P Setting Range

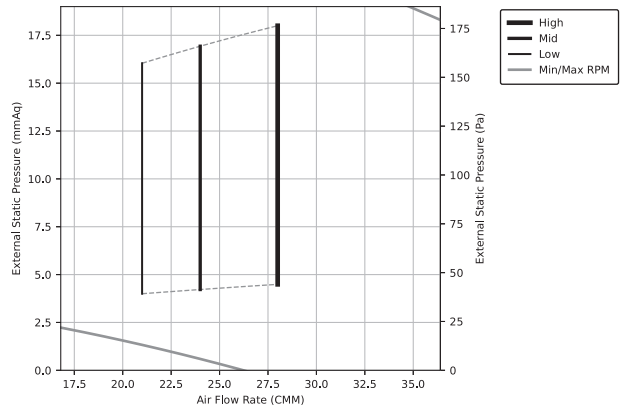

◆ ARNU36GM2A4

PQ Curve

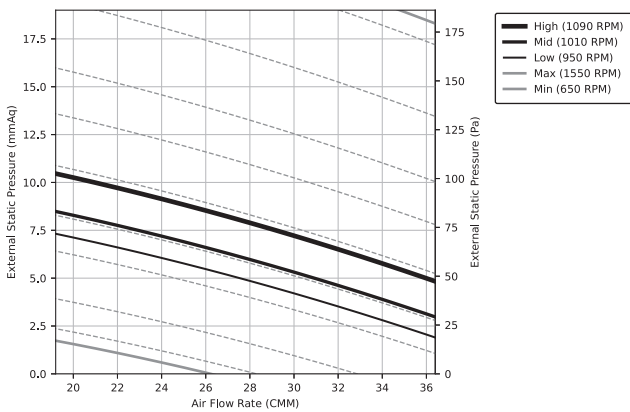

Auto E.S.P Setting Range

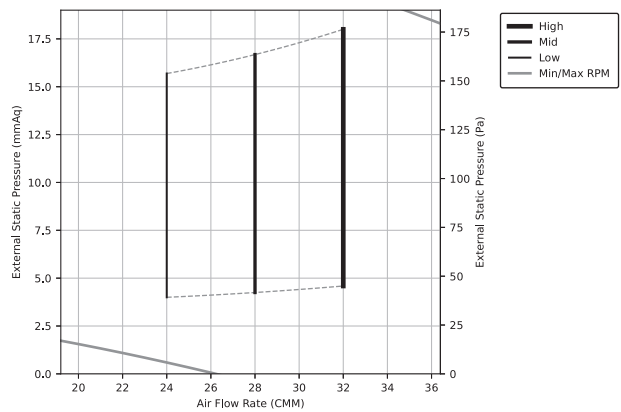

Note

1. Each dash line represents for each 100 RPM step
2. If operation range is out of auto E.S.P setting range, air flow rate should be adjusted manually by wired remotecontroller. (ESP Set Value = RPM / 10)
For more information, please see the installation manual.
3. The above P-Q Curve shows available E.S.P. range. If the E.S.P value is out of min/max RPM at desired air flow, indoor components could be failed and performance would be decreased.
4. Automatic constant air volume is a function that controls air volume automatically when installation, and the air volume is not set automatically during operation.

7. External Static Pressure(E.S.P) & Air Flow

◆ ARNU42GM2A4

PQ Curve

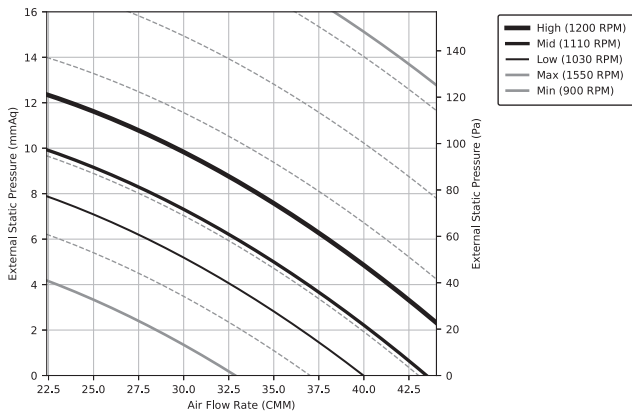

Auto E.S.P Setting Range

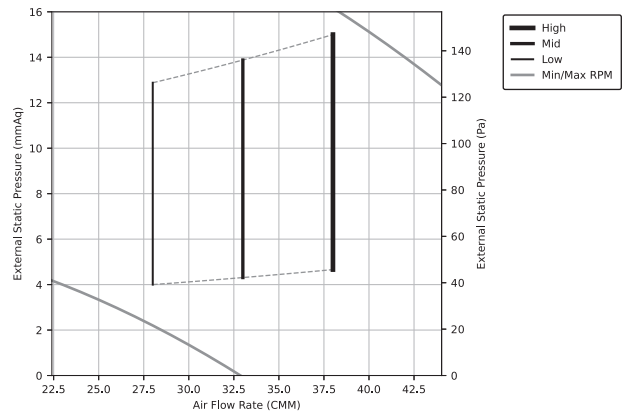

◆ ARNU48GM3B4

PQ Curve

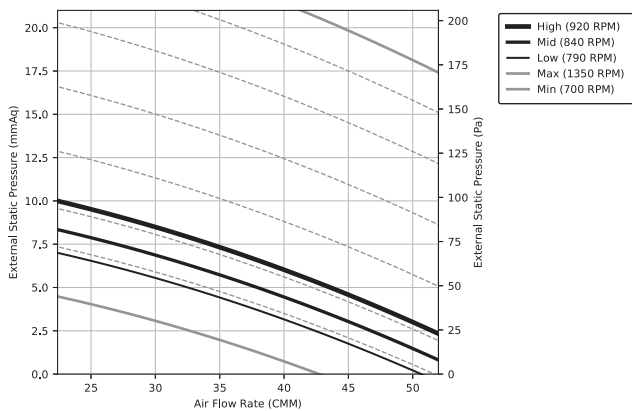

Auto E.S.P Setting Range

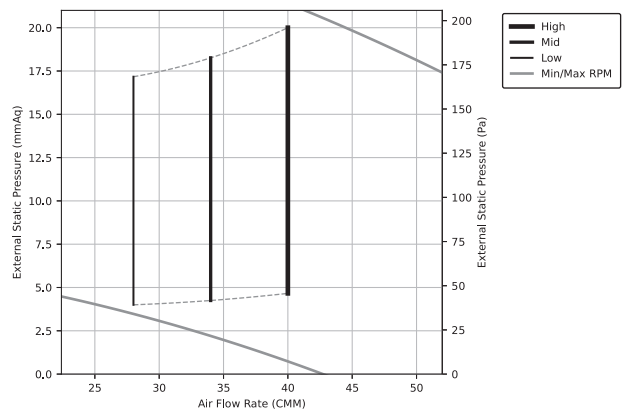

Note

1. Each dash line represents for each 100 RPM step
2. If operation range is out of auto E.S.P setting range, air flow rate should be adjusted manually by wired remotecontroller. (ESP Set Value = RPM / 10)
For more information, please see the installation manual.
3. The above P-Q Curve shows available E.S.P. range. If the E.S.P value is out of min/max RPM at desired air flow, indoor components could be failed and performance would be decreased.
4. Automatic constant air volume is a function that controls air volume automatically when installation, and the air volume is not set automatically during operation.

7. External Static Pressure(E.S.P) & Air Flow

◆ ARNU54GM3B4

PQ Curve

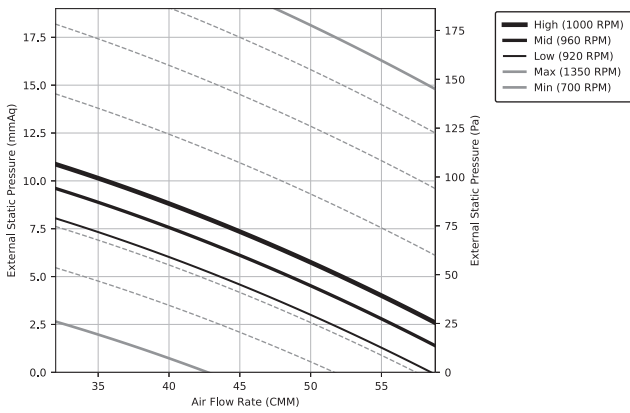

Auto E.S.P Setting Range

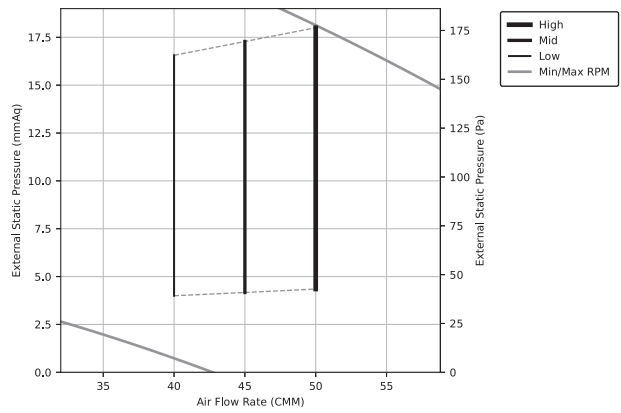

Note

1. Each dash line represents for each 100 RPM step
2. If operation range is out of auto E.S.P setting range, air flow rate should be adjusted manually by wired remotecontroller. (ESP Set Value = RPM / 10)
For more information, please see the installation manual.
3. The above P-Q Curve shows available E.S.P. range. If the E.S.P value is out of min/max RPM at desired air flow, indoor components could be failed and performance would be decreased.
4. Automatic constant air volume is a function that controls air volume automatically when installation, and the air volume is not set automatically during operation.

7. External Static Pressure(E.S.P) & Air Flow

◆ ARNU76GB8A4, ARNU96GB8A4

Setting Value	Static Pressure [mmAq(Pa)]											
	3(29)	4(39)	5(49)	6(59)	9(88)	12(118)	15(147)	18(177)	20(196)	22(216)	23(226)	25(245)
	Air Flow Rate [m³/min]											
50	40.3	36.2	-	-	-	-	-	-	-	-	-	-
55	48.8	44.2	36.4	-	-	-	-	-	-	-	-	-
60	54.9	50.2	49.7	45.0	-	-	-	-	-	-	-	-
65	62.6	60.4	55.1	52.9	-	-	-	-	-	-	-	-
70	67.9	64.5	62.1	60.7	47.1	-	-	-	-	-	-	-
75	75.5	72.2	69.0	68.5	56.9	44.7	-	-	-	-	-	-
80	82.6	80.9	76.6	75.4	69.7	55.2	-	-	-	-	-	-
85	88.8	85.9	82.0	81.6	78.6	67.4	55.9	-	-	-	-	-
91	94.7	93.0	90.4	90.2	87.1	78.9	67.6	54.2	-	-	-	-
95	-	-	-	-	-	86.1	77.0	66.4	50.6	30.0	-	-
100	-	-	-	-	-	-	84.9	75.9	69.5	60.8	43.1	-
105	-	-	-	-	-	-	-	81.1	77.4	72.0	67.9	51.3

Note

1. The above table shows the correlation between the air rates and E.S.P.
2. The set value of the remote controller is proportional to the RPM of the blower and can be changed by the wired remote controller operation. For more information on how to change it, refer to the manual included with the remote controller or product.
3. : is shown as reference. Please refer to the above table for the actual static pressure range.
4. Refer to the installation manual included with the how to set E.S.P.

◆ Fan Performance (ARNU76GB8A4, ARNU96GB8A4)

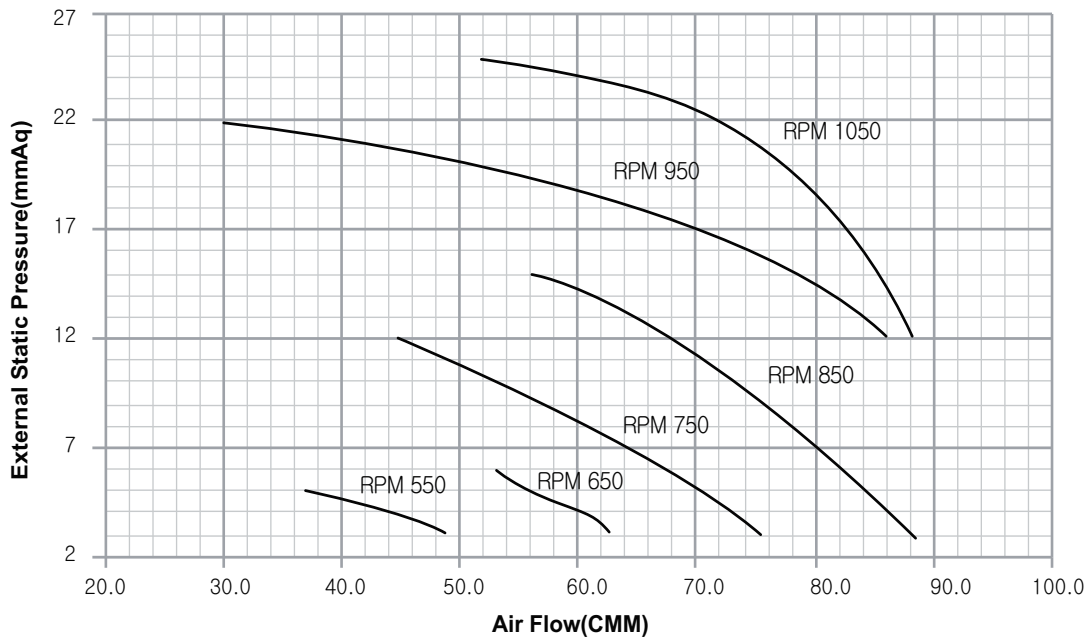

7. External Static Pressure(E.S.P) & Air Flow

Lower and Upper Limit of External Static Pressure

◆ ARUN07GM1A4, ARUN09GM1A4, ARNU12GM1A4, ARUN15GM1A4, ARUN18GM1A4, ARNU24GM1A4, ARNU28GM2A4, ARNU36GM2A4, ARNU42GM2A4, ARNU48GM3B4, ARNU54GM3B4

Capacity	Mode		SV (Setting Value)	Standard ESP (mmAq(Pa))	CMM	Lower Limit of External Static Pressure(mmAq(Pa))	Upper Limit of External Static Pressure(mmAq(Pa))
7k	High (factory set)	Hi	84	6(59)	9.0	2(20)	15(147)
		Mid	79		7.5		
		Low	75		6.0		
	Standard	Hi	69	2.5(25)	9.0	2(20)	15(147)
		Mid	65		7.5		
		Low	61		6.0		
9k	High (factory set)	Hi	85	6(59)	9.5	2(20)	15(147)
		Mid	80		7.5		
		Low	76		6.0		
	Standard	Hi	70	2.5(25)	9.5	2(20)	15(147)
		Mid	66		7.5		
		Low	62		6.0		
12k	High (factory set)	Hi	86	6(59)	11.0	2(20)	15(147)
		Mid	82		9.0		
		Low	78		7.0		
	Standard	Hi	71	2.5(25)	11.0	2(20)	15(147)
		Mid	67		9.0		
		Low	63		7.0		
15k	High (factory set)	Hi	98	6(59)	16.0	2(20)	15(147)
		Mid	86		12.0		
		Low	82		9.0		
	Standard	Hi	86	2.5(25)	16.0	2(20)	15(147)
		Mid	72		12.0		
		Low	67		9.0		
18k	High (factory set)	Hi	103	6(59)	17.0	2(20)	15(147)
		Mid	97		14.5		
		Low	86		12.0		
	Standard	Hi	87	2.5(25)	17.0	2(20)	15(147)
		Mid	78		14.5		
		Low	72		12.0		
24k	High (factory set)	Hi	108	6(59)	19.0	2(20)	15(147)
		Mid	103		16.0		
		Low	97		14.0		
	Standard	Hi	92	2.5(25)	19.0	2(20)	15(147)
		Mid	87		16.0		
		Low	77		14.0		
28k	High (factory set)	Hi	101	6(59)	28.0	4(39)	18(176)
		Mid	95		24.0		
		Low	90		21.0		
	Standard	Hi	99	5(49)	28.0	4(39)	18(176)
		Mid	94		24.0		
		Low	89		21.0		
36k	High (factory set)	Hi	109	6(59)	32.0	4(39)	18(176)
		Mid	101		28.0		
		Low	95		24.0		
	Standard	Hi	105	5(49)	32.0	4(39)	18(176)
		Mid	97		28.0		
		Low	91		24.0		

Note

1. The above table shows the available E.S.P range. If the E.S.P values of the installed indoor system is less or more than mentioned in the table, indoor components could be failed and performance would be decreased.

7. External Static Pressure(E.S.P) & Air Flow

Capacity	Mode		SV (Setting Value)	Standard ESP (mmAq(Pa))	CMM	Lower Limit of External Static Pressure(mmAq(Pa))	Upper Limit of External Static Pressure(mmAq(Pa))
42k	High (factory set)	Hi	120	6(59)	38.0	4(39)	18(176)
		Mid	111		33.0		
		Low	103		28.0		
	Standard	Hi	117	5(49)	38.0	4(39)	18(176)
		Mid	108		33.0		
		Low	100		28.0		
48k	High (factory set)	Hi	92	6(59)	40.0	4(39)	20(196)
		Mid	84		34.0		
		Low	79		28.0		
	Standard	Hi	89	5(49)	40.0	4(39)	20(196)
		Mid	82		34.0		
		Low	76		28.0		
54k	High (factory set)	Hi	100	6(59)	50.0	4(39)	20(196)
		Mid	96		45.0		
		Low	92		40.0		
	Standard	Hi	97	5(49)	50.0	4(39)	20(196)
		Mid	92		45.0		
		Low	88		40.0		

Note

1. The above table shows the available E.S.P range. If the E.S.P values of the installed indoor system is less or more than mentioned in the table, indoor components could be failed and performance would be decreased.

◆ ARNU76GB8A4, ARNU96GB8A4

Capacity	Mode		Set value	ESP (mmAq(Pa))	CMM	Lower Limit of External Static Pressure(mmAq(Pa))	Upper Limit of External Static Pressure(mmAq(Pa))
76k	factory set	HI	77	10(98)	60.0	10(98)	25(245)
		Mid	74		50.0		
		Low	74		50.0		
	Standard	HI	86	15(147)	64.0	10(98)	25(245)
		Mid	83		50.0		
		Low	83		50.0		
96k	factory set	HI	86	10(98)	72.0	10(98)	25(245)
		Mid	81		64.0		
		Low	81		64.0		
	Standard	HI	94	15(147)	76.0	10(98)	25(245)
		Mid	89		64.0		
		Low	89		64.0		

Note

1. The above table shows the available E.S.P range. If the E.S.P values of the installed indoor system is less or more than mentioned in the table, indoor components could be failed and performance would be decreased.

8. Electric Characteristics

Units					Power Supply	IFM		PI	
Model	Type	Hz	Volts	Voltage Range	MCA	kW	FLA	Cooling	Heating
ARNU07GM1A4	M1	50	220-240	Max:264 Min:198	2.00	0.136	1.60	190	190
ARNU09GM1A4	M1				2.00	0.136	1.60	190	190
ARNU12GM1A4	M1				2.00	0.136	1.60	190	190
ARNU15GM1A4	M1				2.00	0.136	1.60	190	190
ARNU18GM1A4	M1				2.00	0.136	1.60	190	190
ARNU24GM1A4	M1				2.00	0.136	1.60	190	190
ARNU28GM2A4	M2				2.90	0.350	2.30	430	430
ARNU36GM2A4	M2				2.90	0.350	2.30	430	430
ARNU42GM2A4	M2				2.90	0.350	2.30	430	430
ARNU48GM3B4	M3				3.10	0.500	2.50	650	650
ARNU54GM3B4	M3				3.10	0.500	2.50	650	650
ARNU76GB8A4	B8				6.50	0.750	5.20	800	800
ARNU96GB8A4	B8				6.50	0.750	5.20	800	800
ARNU07GM1A4	M1				60	220	Max:242 Min:198	2.00	0.136
ARNU09GM1A4	M1	2.00	0.136	1.60				190	190
ARNU12GM1A4	M1	2.00	0.136	1.60				190	190
ARNU15GM1A4	M1	2.00	0.136	1.60				190	190
ARNU18GM1A4	M1	2.00	0.136	1.60				190	190
ARNU24GM1A4	M1	2.00	0.136	1.60				190	190
ARNU28GM2A4	M2	2.90	0.350	2.30				430	430
ARNU36GM2A4	M2	2.90	0.350	2.30				430	430
ARNU42GM2A4	M2	2.90	0.350	2.30				430	430
ARNU48GM3B4	M3	3.10	0.500	2.50				650	650
ARNU54GM3B4	M3	3.10	0.500	2.50				650	650
ARNU76GB8A4	B8	6.50	0.750	5.20				800	800
ARNU96GB8A4	B8	6.50	0.750	5.20				800	800

Symbols

MCA : Minimum Circuit Amperes (A)

kW : Fan Motor Rated Output (kW)

FLA : Full Load Amperes (A)

IFM : Indoor Fan Motor

PI : Maximum Power Input (W)

Note

- Voltage range
Units are suitable for use on electrical systems where voltage supplied to unit terminals is not below or above the listed range limits.
- Maximum allowable voltage unbalance between phases is 2%.
- MCA/MFA
MCA=1.25 x FLA
MFA = 1.1 x MCA, MFA ≤ 4 x FLA
(If MFA is smaller than minimum standard value, Use minimum standard value in region for selecting circuit breaker.)
- Select wire size based on the MCA
- Instead of fuse, use Circuit Breaker.

9. Sound Levels

9.1 Sound Pressure Levels

Overall

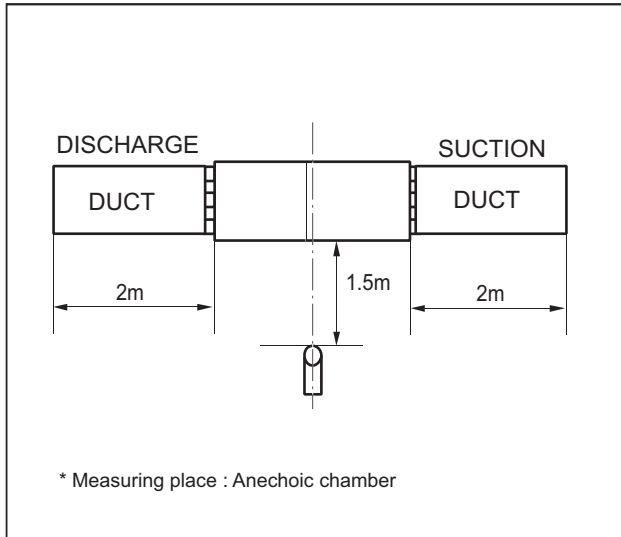

Note

1. Sound measured at some distance away from the center of the unit.
2. Data is valid at free field condition.
3. Reference acoustic pressure 0dB = 20μPa.
4. Data is valid at nominal operation condition. Refer to the Model Specifications for nominal conditions (Power source and Ambient temperature, etc)
5. Sound levels can be increased in accordance with installation and operating conditions. (Static pressure mode, used air guide, Room target temperature setting, etc)
6. Sound level will vary depending on a range of factors such as the construction (acoustic absorption coefficient) of particular room in which the equipment is installed.
7. Sound pressure level is measured on the rated condition in the anechoic rooms by ISO 3745 standard. Therefore, these values can be increased owing to ambient conditions during operation.

Model	Sound Pressure Levels [dB(A),H-M-L]			
	External Static Pressure [Pa]			
	20	25	59	147
ARNU07GM1A4	26-24-23	26-24-23	26-24-23	30-28-27
ARNU09GM1A4	27-25-23	27-25-23	27-25-23	31-29-27
ARNU12GM1A4	27-25-23	27-25-23	27-25-23	32-30-27
ARNU15GM1A4	30-27-23	30-27-23	30-27-23	36-32-30
ARNU18GM1A4	31-28-25	31-28-25	31-28-25	37-34-32
ARNU24GM1A4	32-29-26	32-29-26	32-29-26	38-35-32

Sound Pressure Level (20Pa)

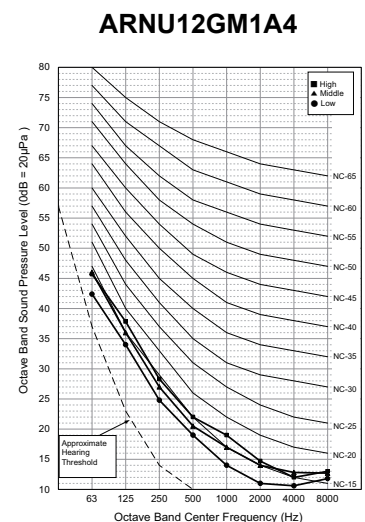
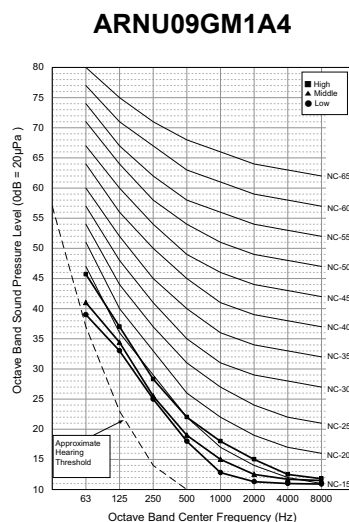
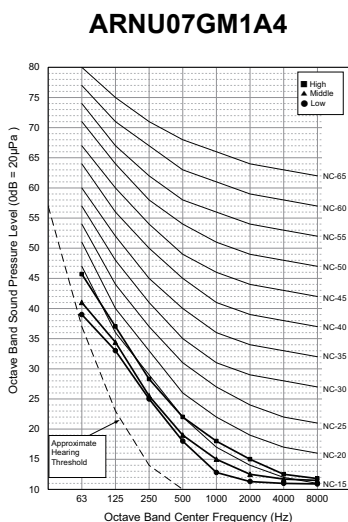

9. Sound Levels

ARNU15GM1A4

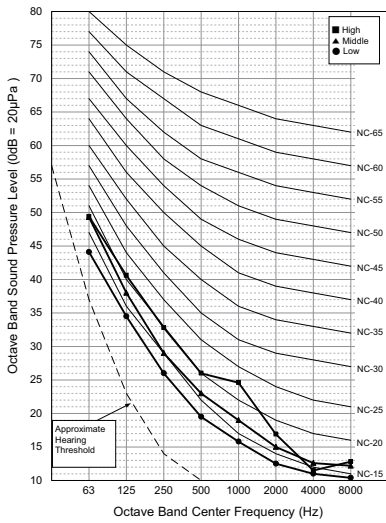

ARNU18GM1A4

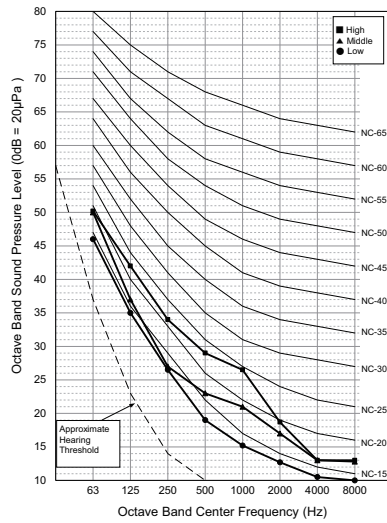

ARNU24GM1A4

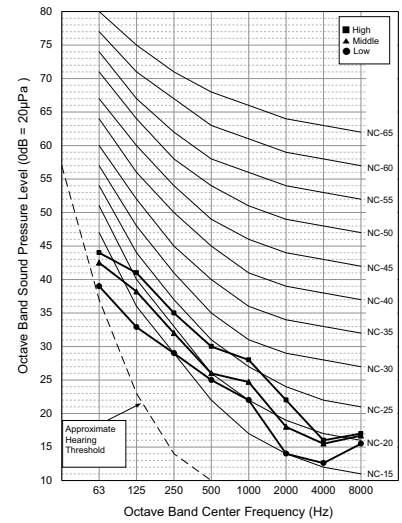

■ Sound Pressure Level (25Pa)

ARNU07GM1A4

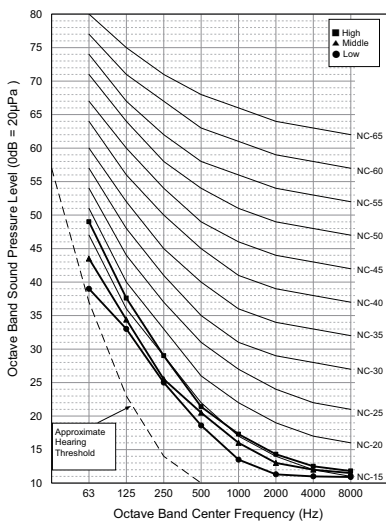

ARNU09GM1A4

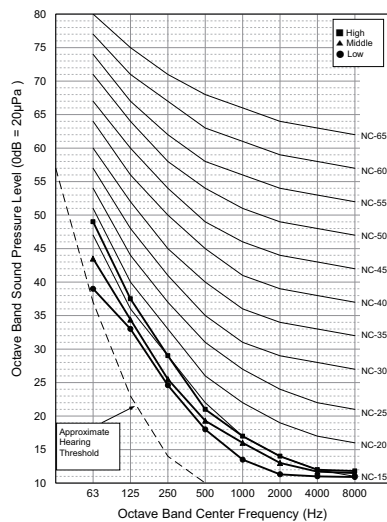

ARNU12GM1A4

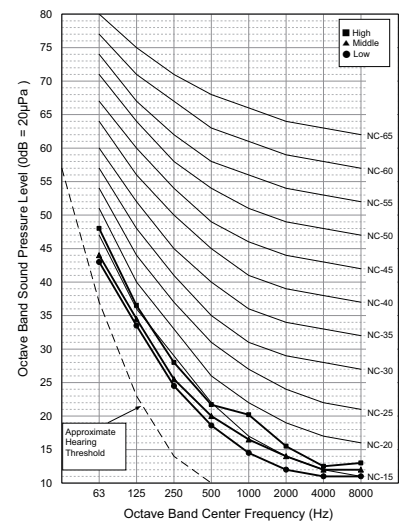

ARNU15GM1A4

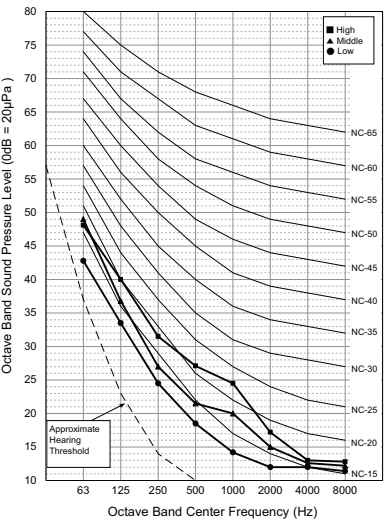

ARNU18GM1A4

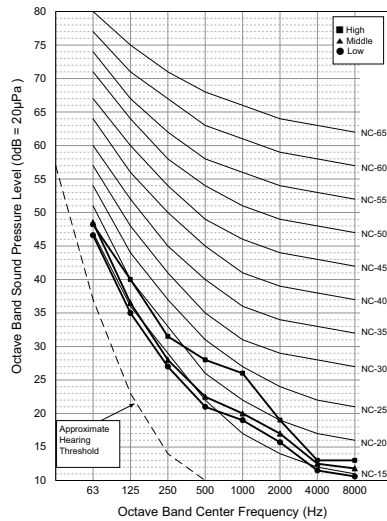

ARNU24GM1A4

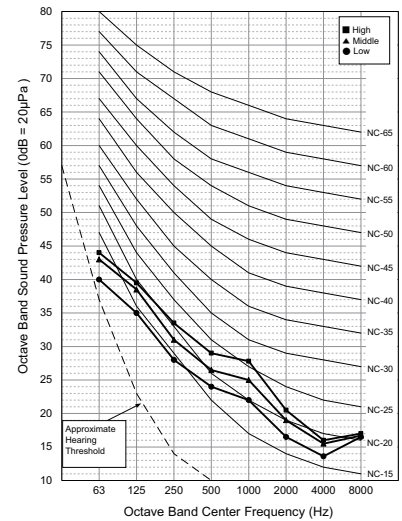

9. Sound Levels

■ Sound Pressure Level (59Pa)

ARNU07GM1A4

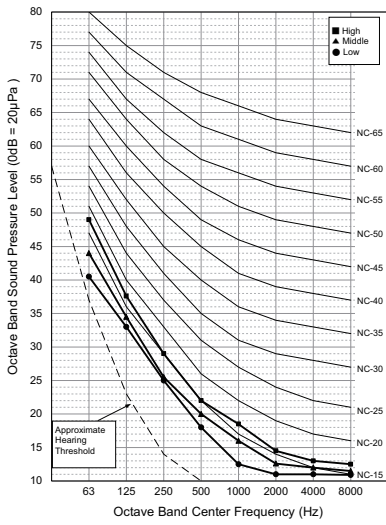

ARNU09GM1A4

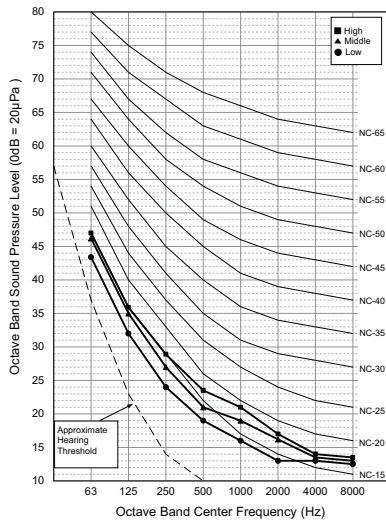

ARNU12GM1A4

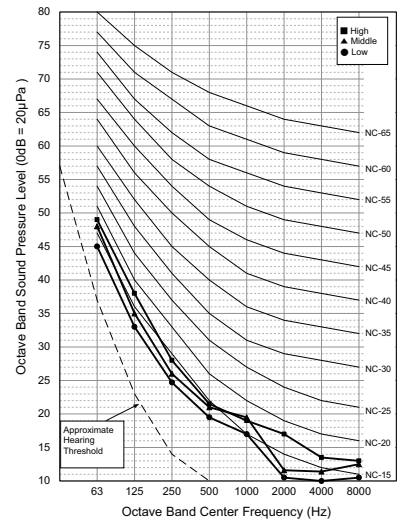

ARNU15GM1A4

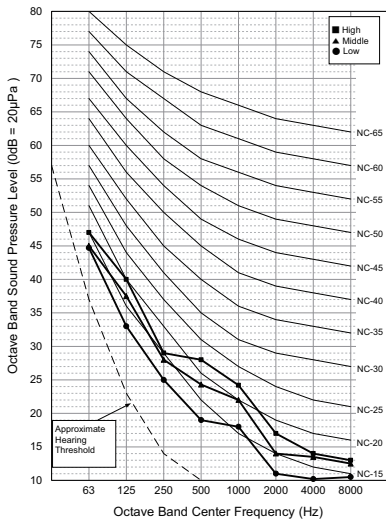

ARNU18GM1A4

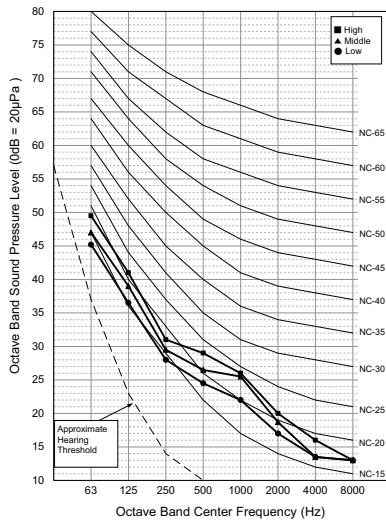

ARNU24GM1A4

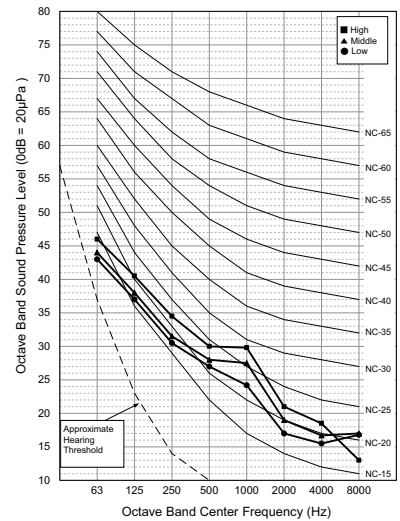

9. Sound Levels

■ Sound Pressure Level (147Pa)

ARNU07GM1A4

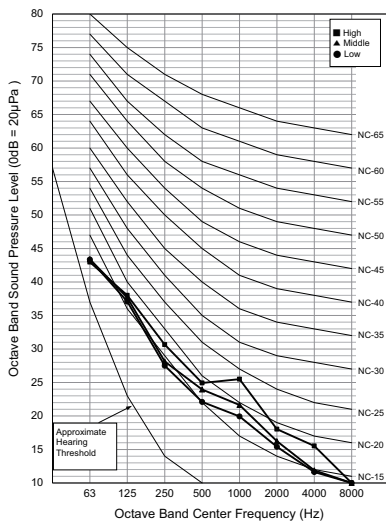

ARNU09GM1A4

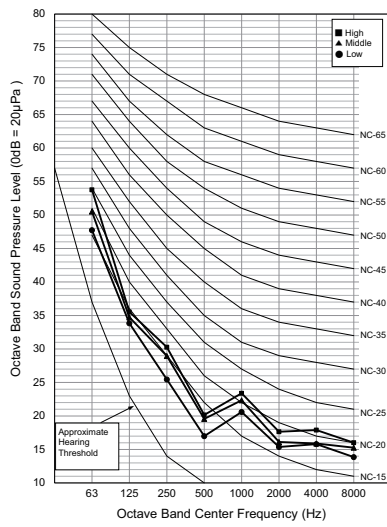

ARNU12GM1A4

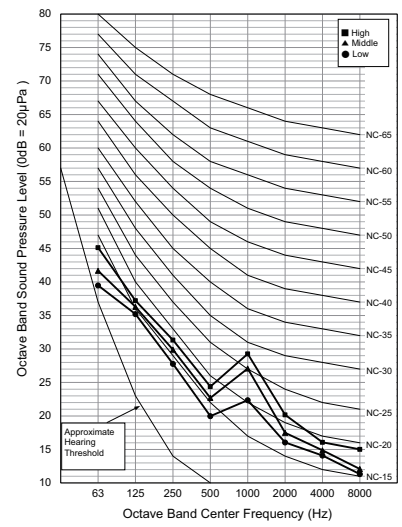

ARNU15GM1A4

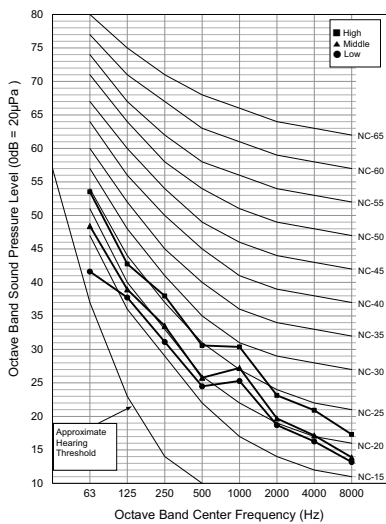

ARNU18GM1A4

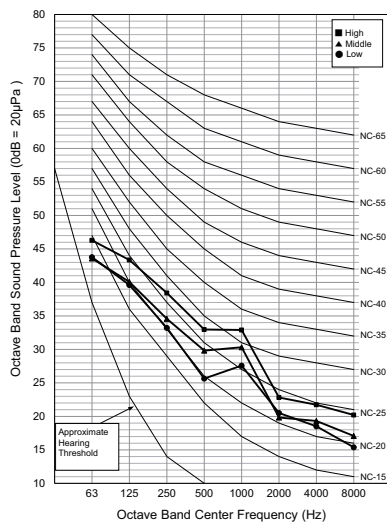

ARNU24GM1A4

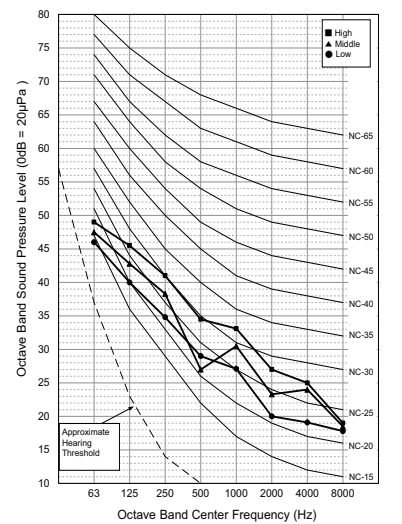

9. Sound Levels

Model	Sound Pressure Levels [dB(A),H-M-L]				
	External Static Pressure [Pa]				
	39	49	59	147	176
ARNU28GM2A4	36-34-33	37-35-34	38-36-35	43-41-40	46-43-42
ARNU36GM2A4	38-36-34	39-37-35	40-38-36	45-43-41	47-46-43
ARNU42GM2A4	-	43-42-40	42-41-39	45-44-43	50-49-48

■ Sound Pressure Level (39Pa)

ARNU28GM2A4

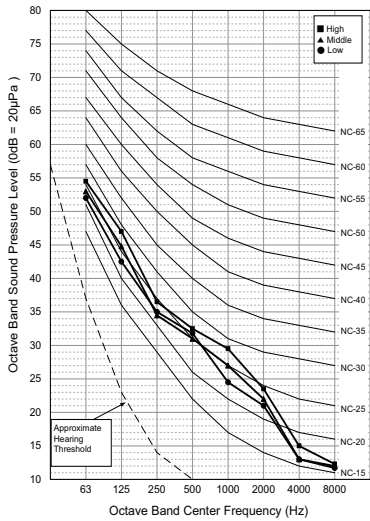

ARNU36GM2A4

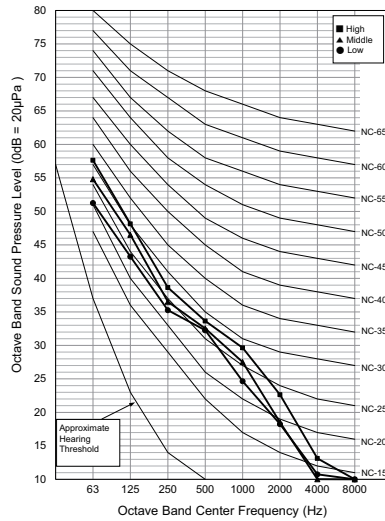

■ Sound Pressure Level (49Pa)

ARNU28GM2A4

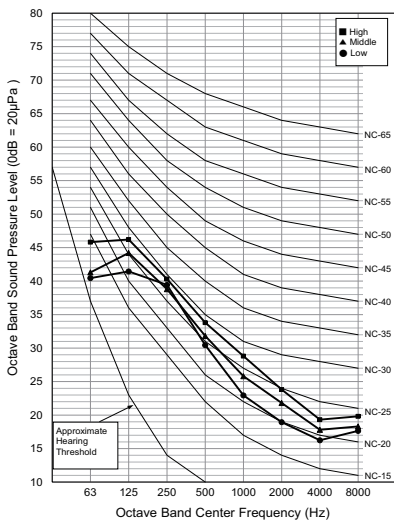

ARNU36GM2A4

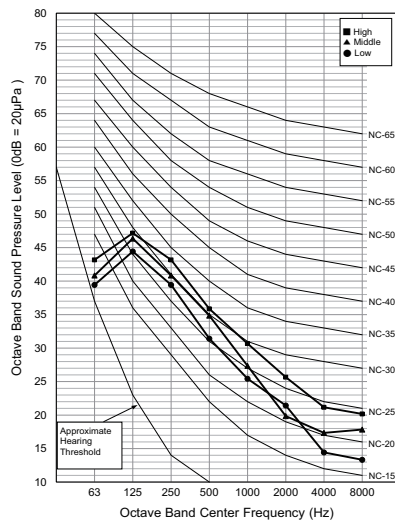

ARNU42GM2A4

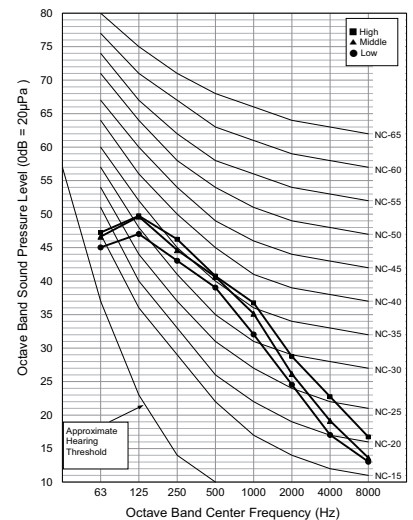

9. Sound Levels

■ Sound Pressure Level (59Pa)

ARNU28GM2A4

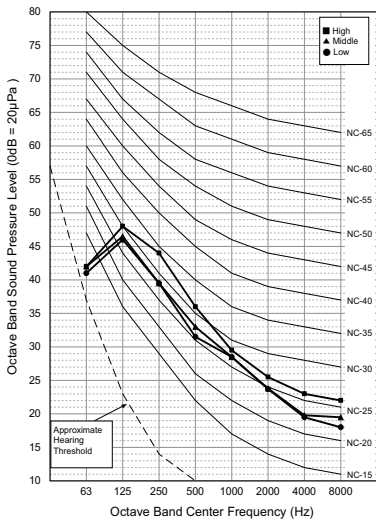

ARNU36GM2A4

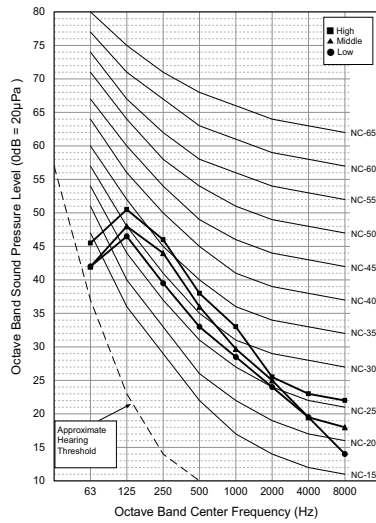

ARNU42GM2A4

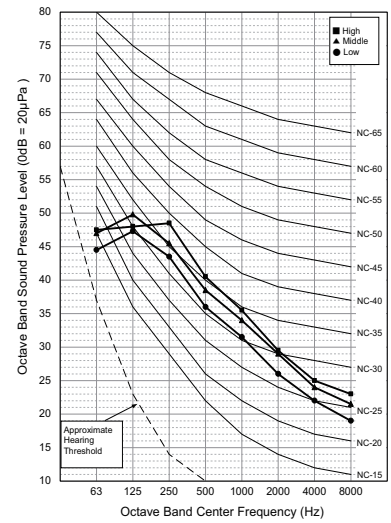

■ Sound Pressure Level (147Pa)

ARNU28GM2A4

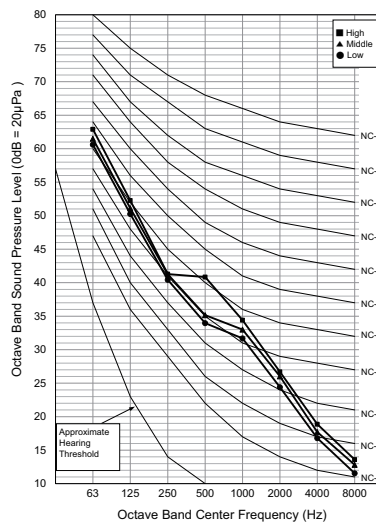

ARNU36GM2A4

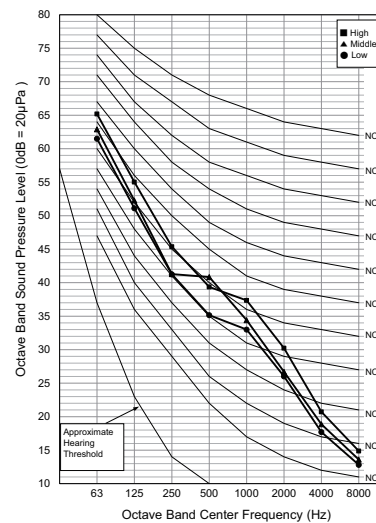

ARNU42GM2A4

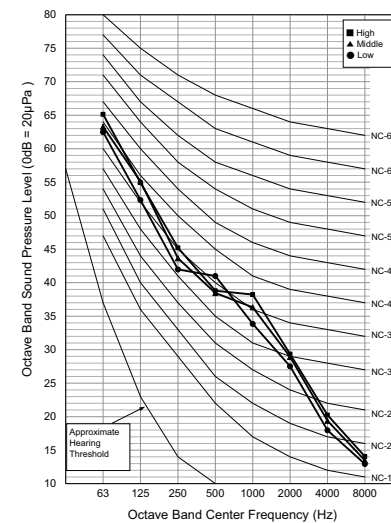

9. Sound Levels

■ Sound Pressure Level (176Pa)

ARNU28GM2A4

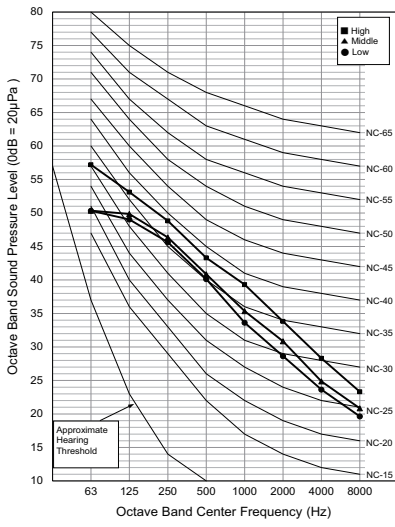

ARNU36GM2A4

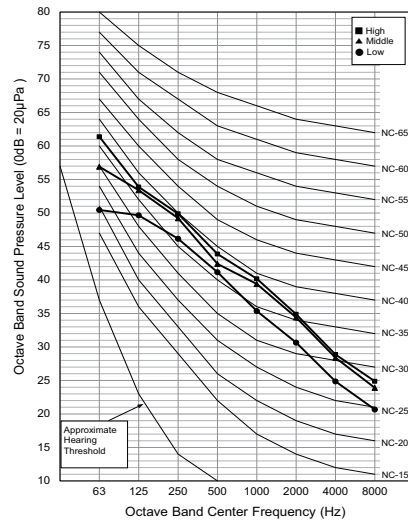

ARNU42GM2A4

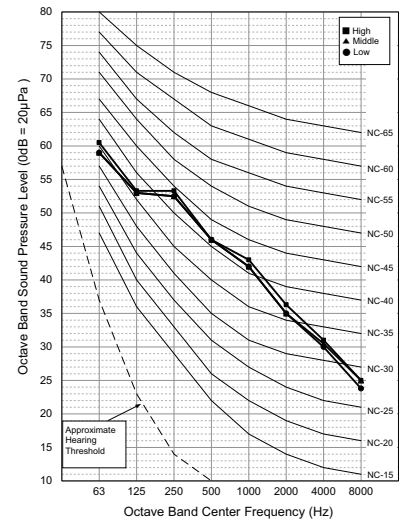

9. Sound Levels

Model	Sound Pressure Levels [dB(A),H-M-L]				
	External Static Pressure [Pa]				
	39	49	59	147	196
ARNU48GM3B4	39-37-35	39-37-35	40-38-36	43-42-41	47-46-46
ARNU54GM3B4	42-40-39	42-40-39	41-41-40	45-44-43	49-48-47

■ Sound Pressure Level (39Pa)

ARNU48GM3B4

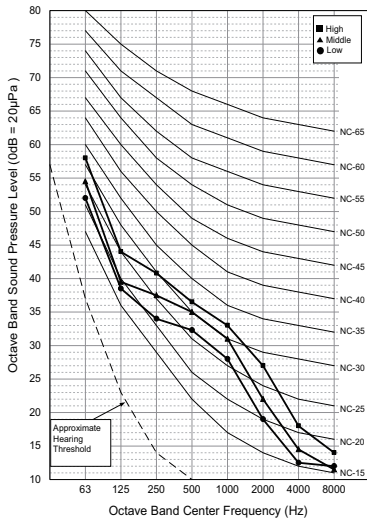

ARNU54GM3B4

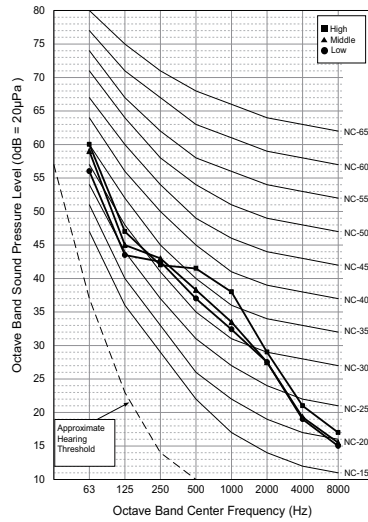

■ Sound Pressure Level (49Pa)

ARNU48GM3B4

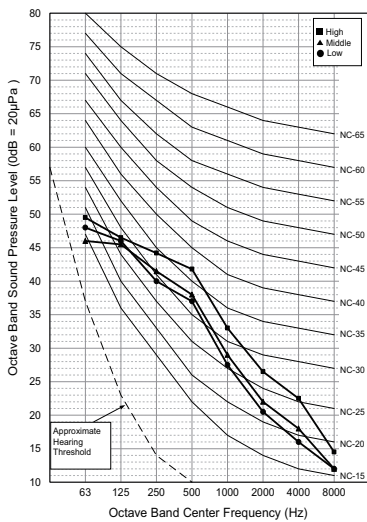

ARNU54GM3B4

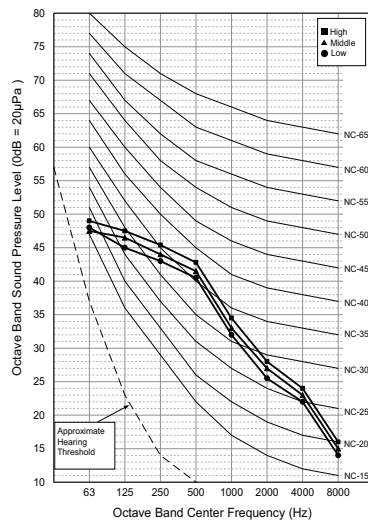

9. Sound Levels

■ Sound Pressure Level (59Pa)

ARNU48GM3B4

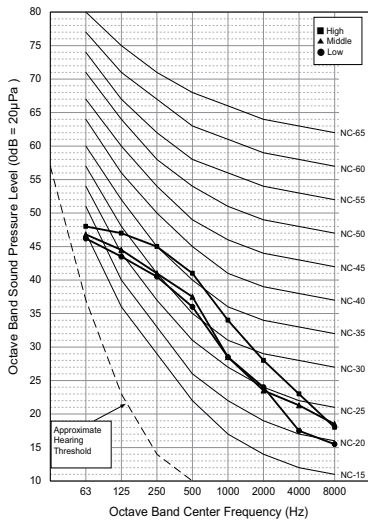

ARNU54GM3B4

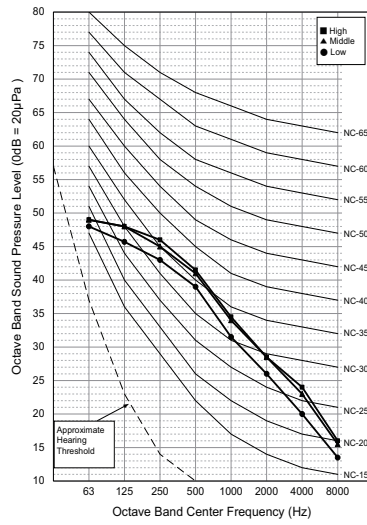

■ Sound Pressure Level (147Pa)

ARNU48GM3B4

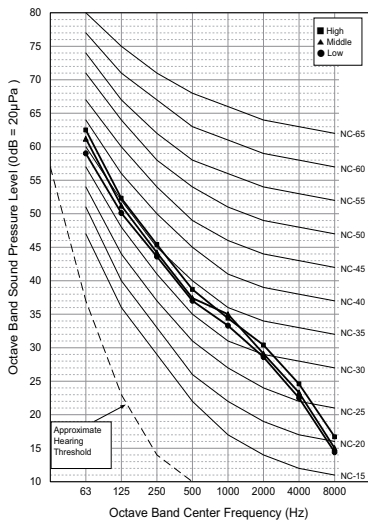

ARNU54GM3B4

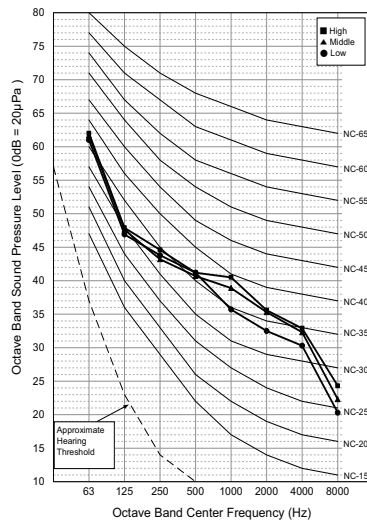

9. Sound Levels

■ Sound Pressure Level (196Pa)

ARNU48GM3B4

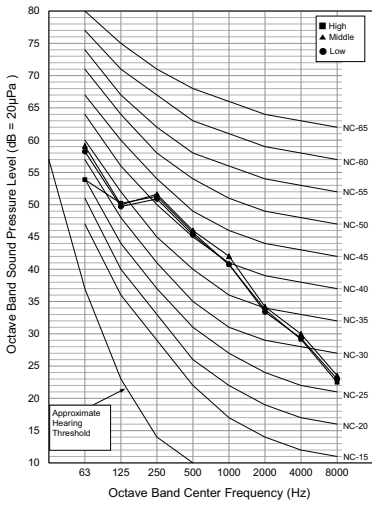

ARNU54GM3B4

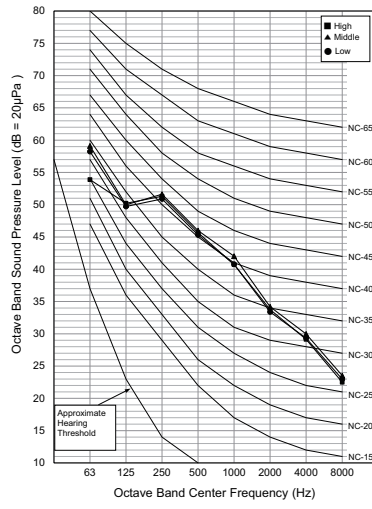

9. Sound Levels

Model	Sound Pressure Levels (dB(A),H-M-L)		
	External Static Pressure (Pa)		
	120	150	220
ARNU76GB8A4	41-40-40	42-41-41	45-43-43
ARNU96GB8A4	43-41-41	44-42-42	47-45-45

■ Sound Pressure Level (120Pa)

ARNU76GB8A4

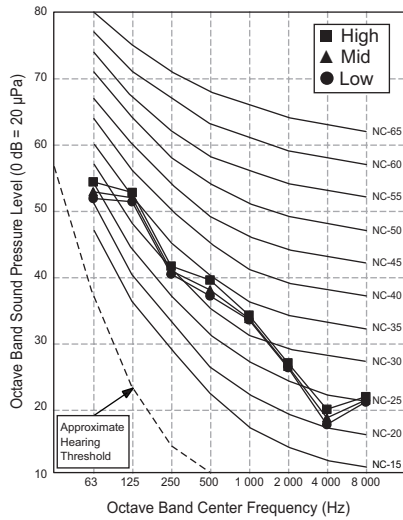

ARNU96GB8A4

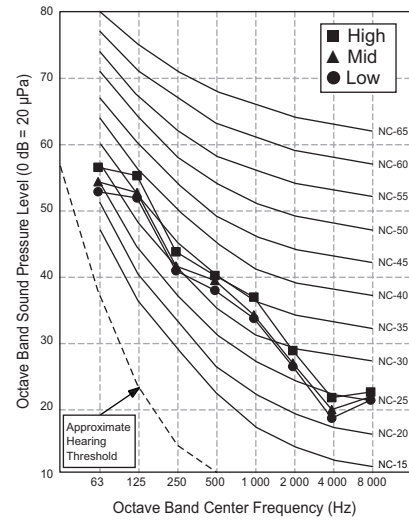

■ Sound Pressure Level (150Pa)

ARNU76GB8A4

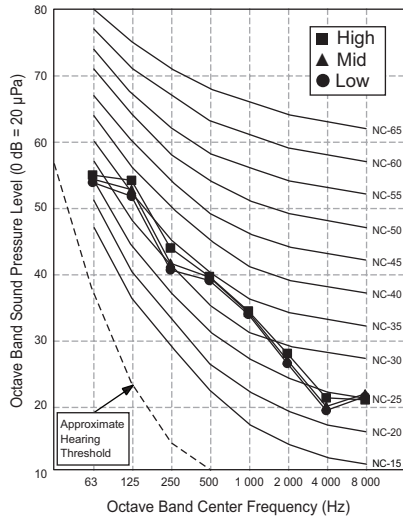

ARNU96GB8A4

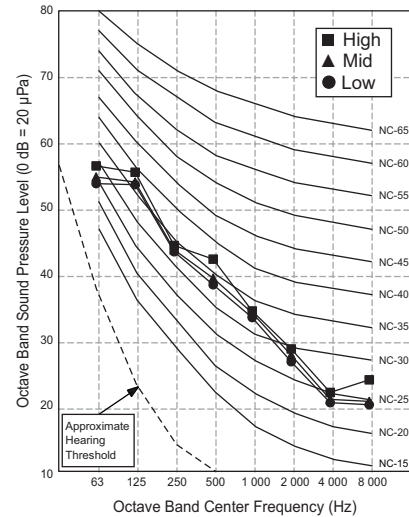

9. Sound Levels

■ Sound Pressure Level (220Pa)

ARNU76GB8A4

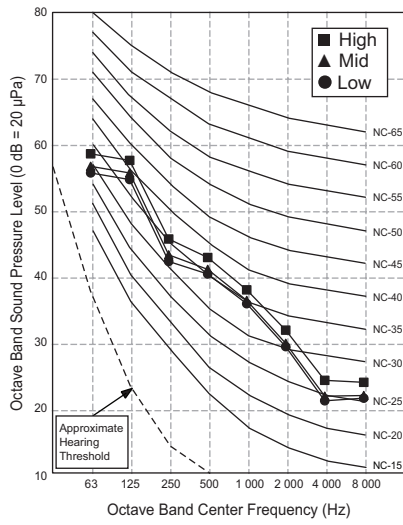

ARNU96GB8A4

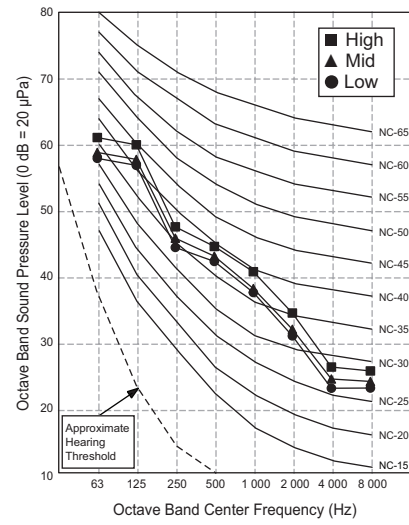

9. Sound Levels

9.2 Sound Power Levels

Note

- Data is valid at diffuse field condition
- Data is valid at nominal operating condition
- Sound level can be increased in static pressure mode or used air guide.
- Sound level will vary depending on a range of factors such as the construction (acoustic absorption coefficient) of particular room in which the equipment is installed.
- Reference acoustic intensity 0dB = 10E-6μW/m²
- Sound power level is measured on the rated condition in the semi-anechoic rooms by ISO 9614 standard. Therefore, these values can be increased owing to ambient conditions during operation.

9.2.1 Sound Power Levels (Inlet)

Model	Sound Power Levels [dB(A), Inlet(H-M-L)]			
	External Static Pressure [Pa]			
	20	39	59	147
ARNU07GM1A4	46 - 44 - 42	47 - 44 - 42	49 - 46 - 44	57 - 56 - 55
ARNU09GM1A4	48 - 44 - 42	48 - 44 - 42	49 - 47 - 45	57 - 56 - 55
ARNU12GM1A4	48 - 46 - 43	49 - 47 - 43	50 - 48 - 46	58 - 57 - 56
ARNU15GM1A4	53 - 48 - 46	56 - 51 - 47	55 - 50 - 48	60 - 58 - 57
ARNU18GM1A4	56 - 49 - 48	56 - 54 - 51	57 - 54 - 50	60 - 59 - 58
ARNU24GM1A4	57 - 54 - 51	59 - 55 - 51	59 - 57 - 54	61 - 59 - 58

■ Sound Power Level (20Pa)

ARNU07GM1A4

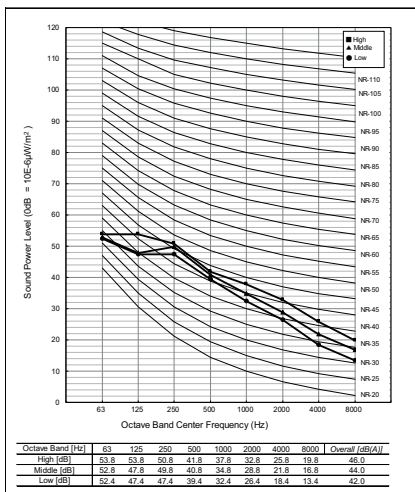

ARNU09GM1A4

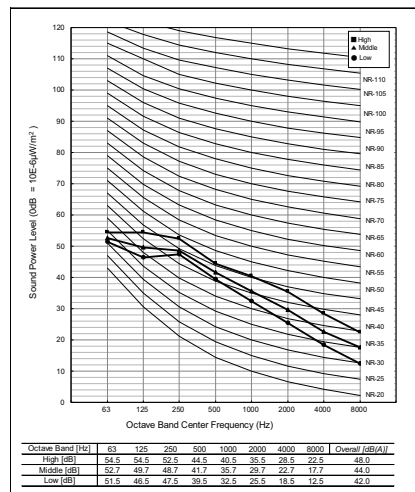

ARNU12GM1A4

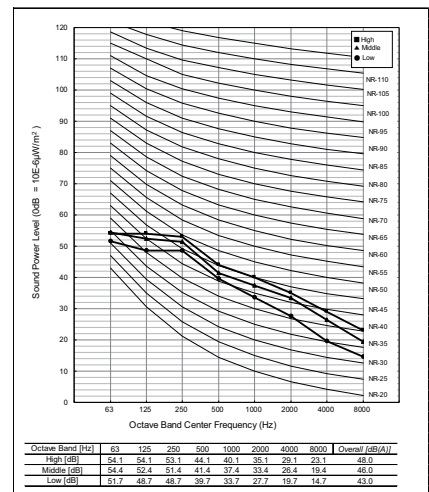

9. Sound Levels

ARNU15GM1A4

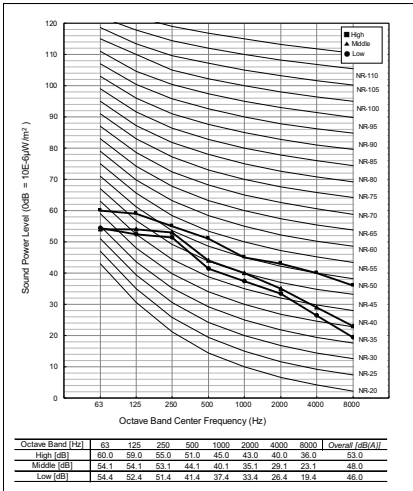

ARNU18GM1A4

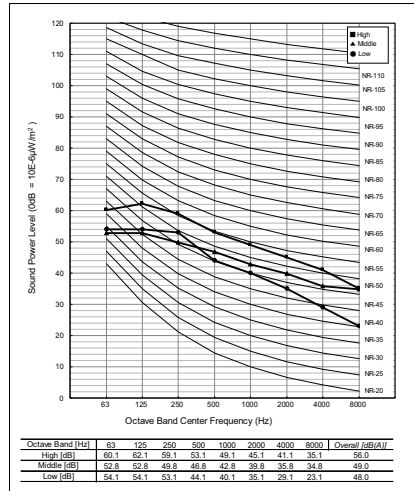

ARNU24GM1A4

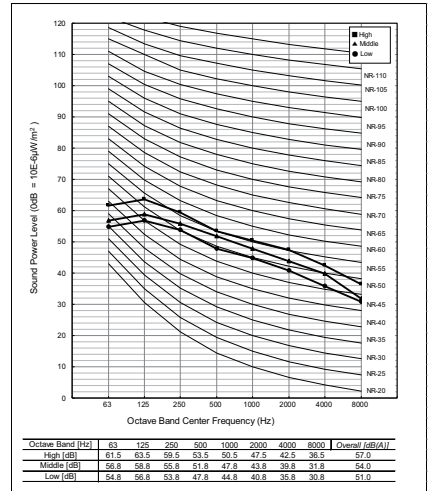

■ Sound Power Level (39Pa)

ARNU07GM1A4

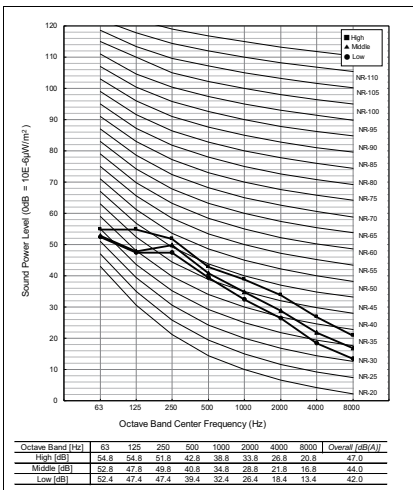

ARNU09GM1A4

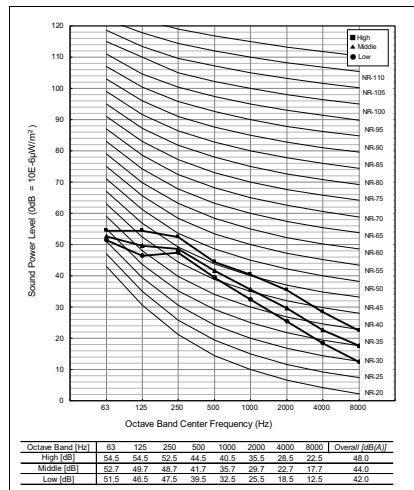

ARNU12GM1A4

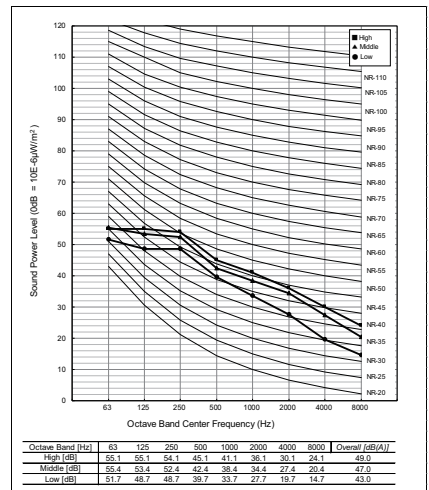

ARNU15GM1A4

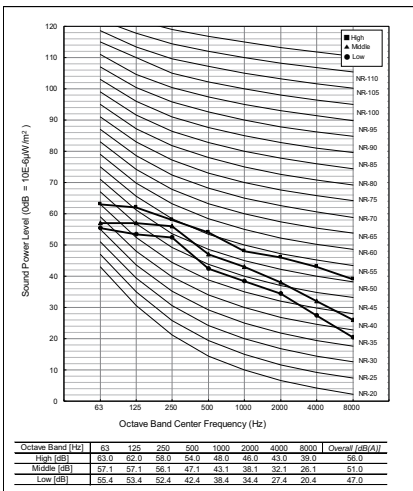

ARNU18GM1A4

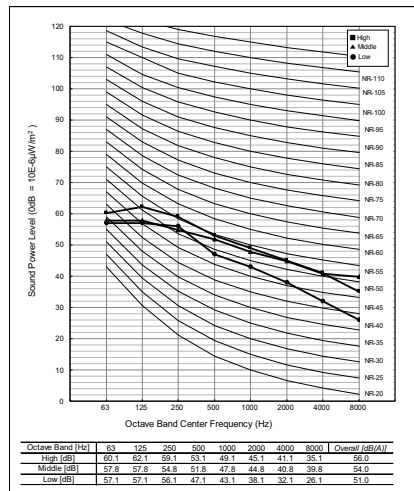

ARNU24GM1A4

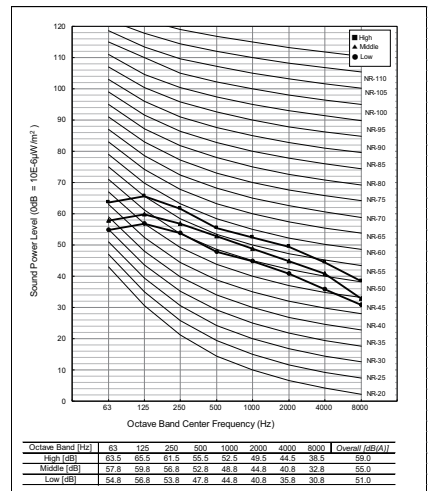

9. Sound Levels

■ Sound Power Level (59Pa)

ARNU07GM1A4

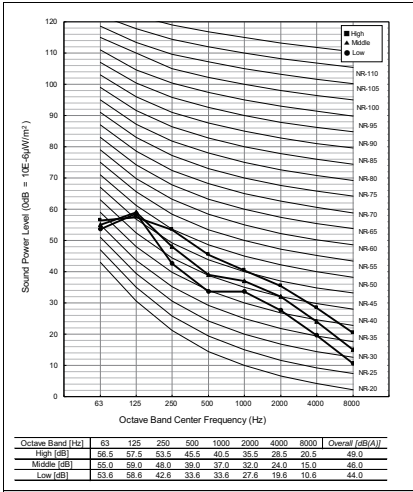

ARNU09GM1A4

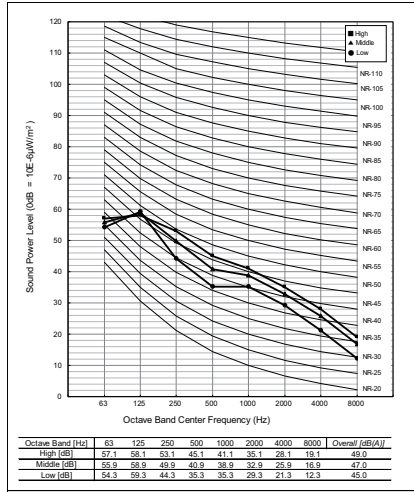

ARNU12GM1A4

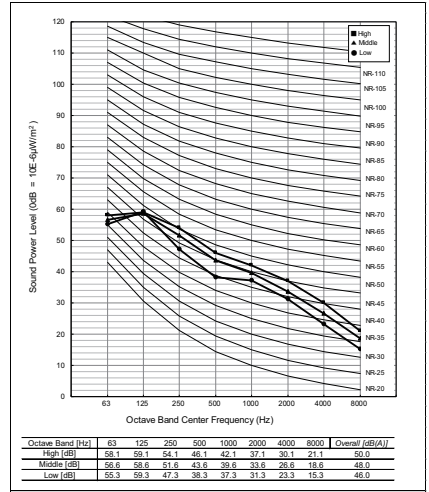

ARNU15GM1A4

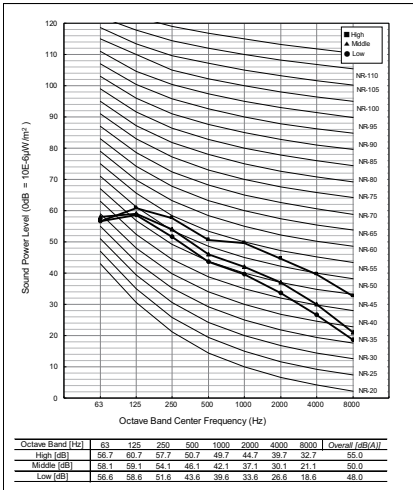

ARNU18GM1A4

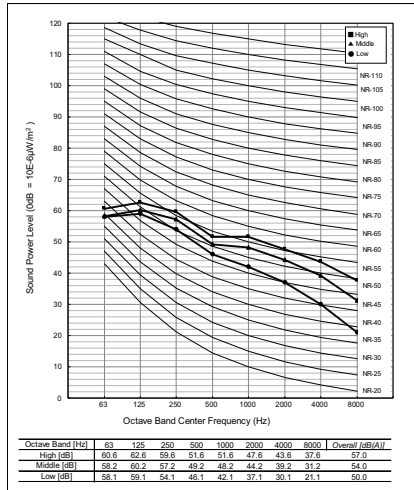

ARNU24GM1A4

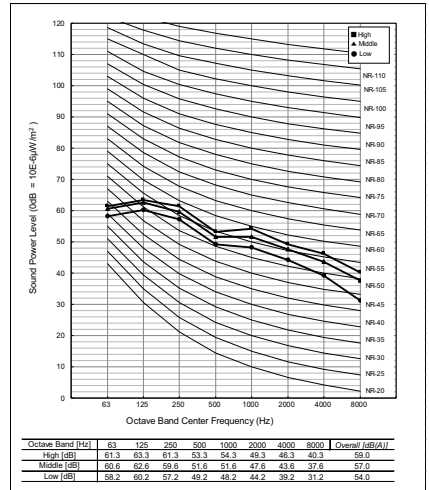

9. Sound Levels

■ Sound Power Level (147Pa)

ARNU07GM1A4

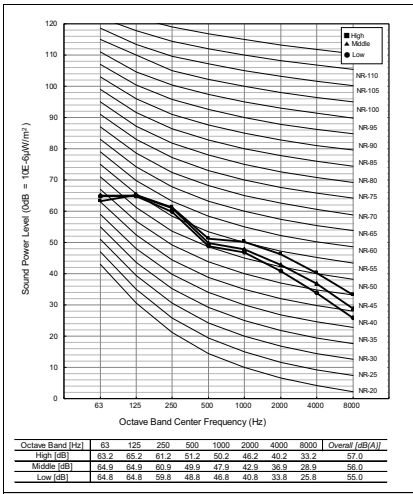

ARNU09GM1A4

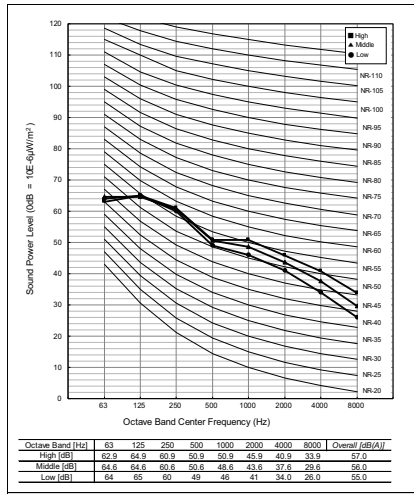

ARNU12GM1A4

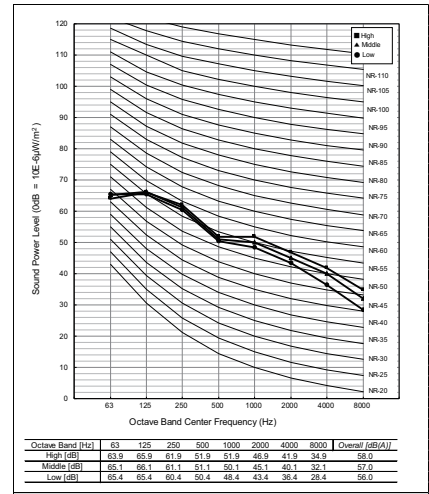

ARNU15GM1A4

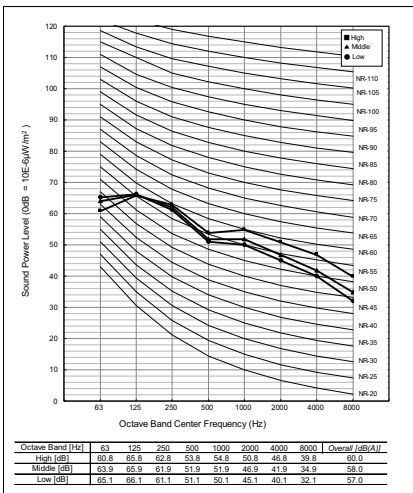

ARNU18GM1A4

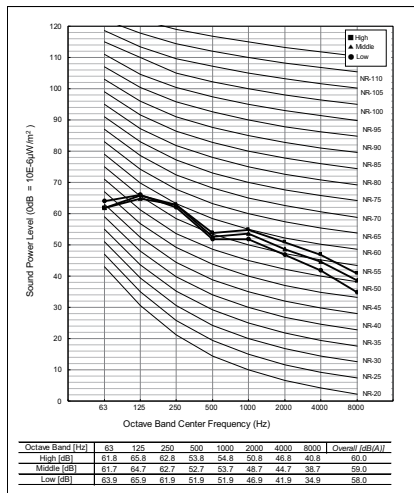

ARNU24GM1A4

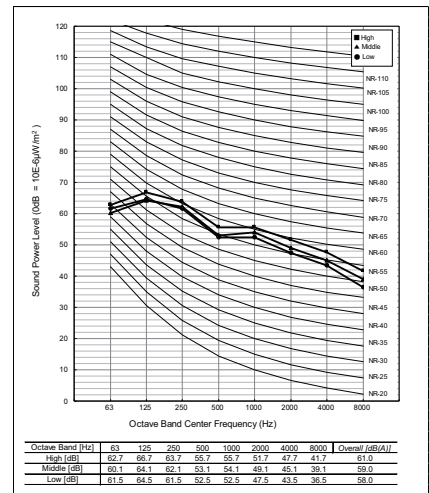

9. Sound Levels

Model	Sound Power Levels [dB(A), Inlet(H-M-L)]				
	External Static Pressure [Pa]				
	39	49	59	147	176
ARNU28GM2A4	57 - 55 - 54	57 - 56 - 54	57 - 55 - 53	63 - 62 - 61	67 - 66 - 65
ARNU36GM2A4	59 - 57 - 55	59 - 57 - 55	60 - 57 - 55	64 - 63 - 62	68 - 67 - 66
ARNU42GM2A4	64 - 61 - 58	63 - 60 - 58	63 - 60 - 58	66 - 65 - 64	69 - 68 - 67

■ Sound Power Level (39Pa)

ARNU28GM2A4

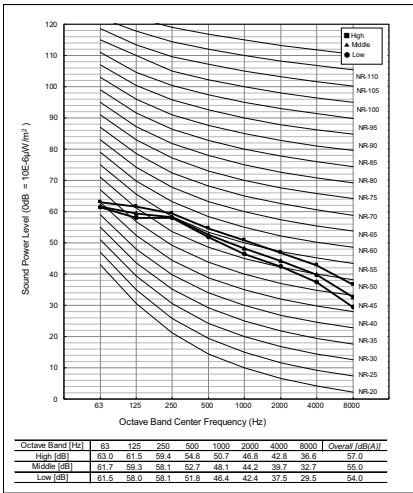

ARNU36GM2A4

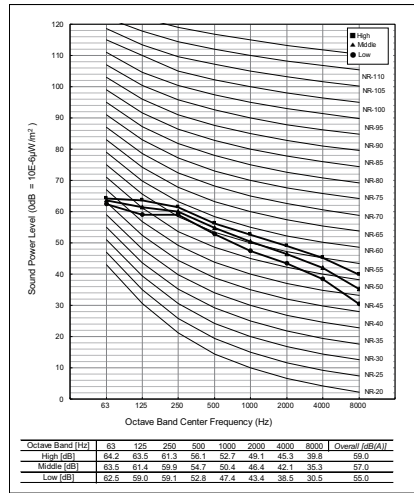

ARNU42GM2A4

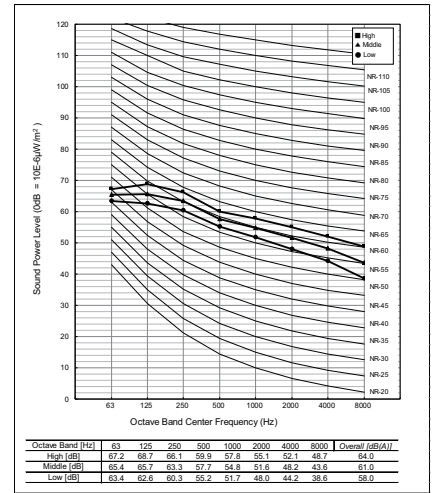

■ Sound Power Level (49Pa)

ARNU28GM2A4

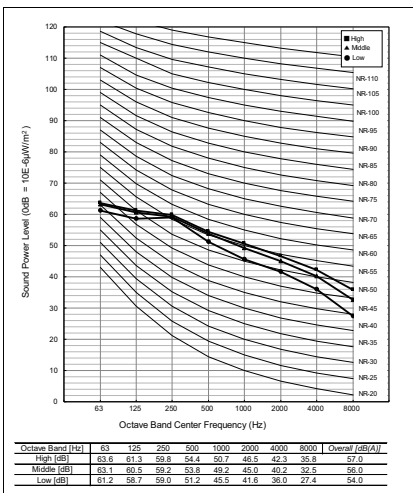

ARNU36GM2A4

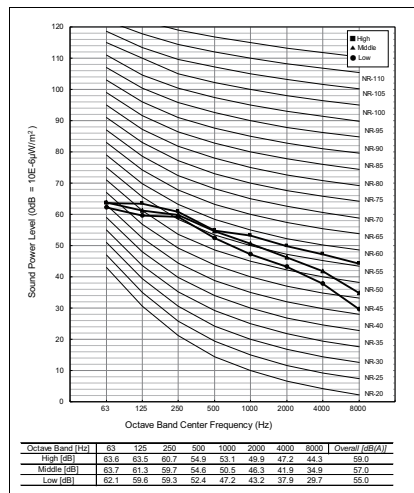

ARNU42GM2A4

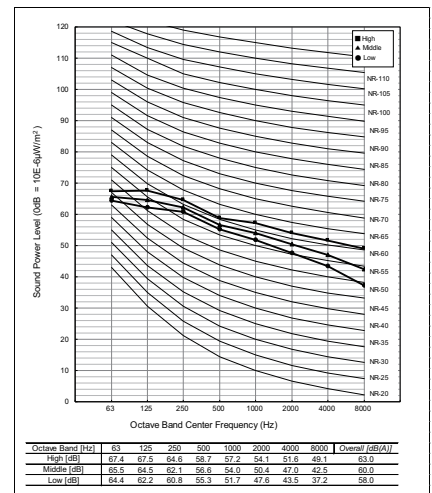

9. Sound Levels

■ Sound Power Level (59Pa)

ARNU28GM2A4

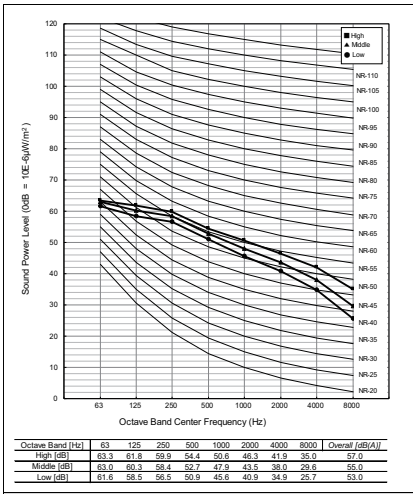

ARNU36GM2A4

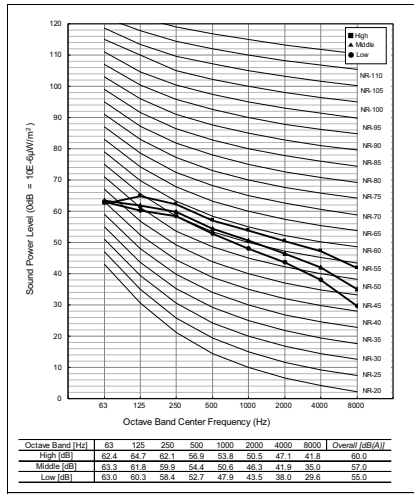

ARNU42GM2A4

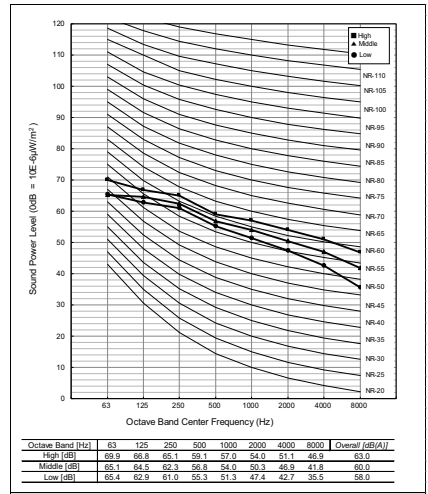

■ Sound Power Level (147Pa)

ARNU28GM2A4

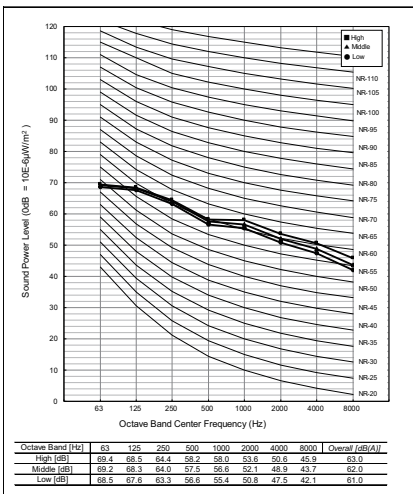

ARNU36GM2A4

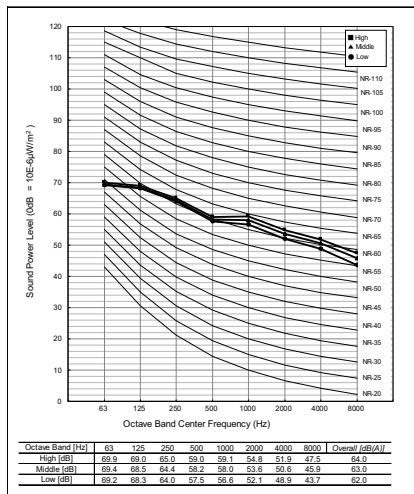

ARNU42GM2A4

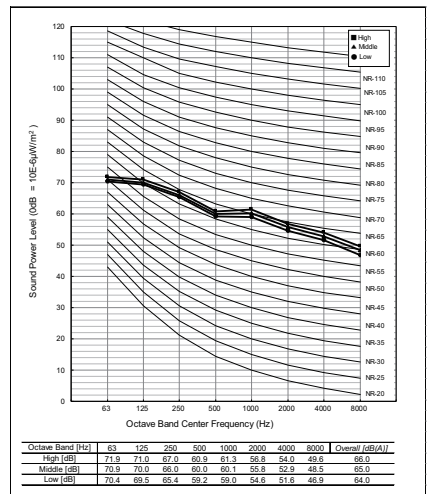

9. Sound Levels

■ Sound Power Level (176Pa)

ARNU28GM2A4

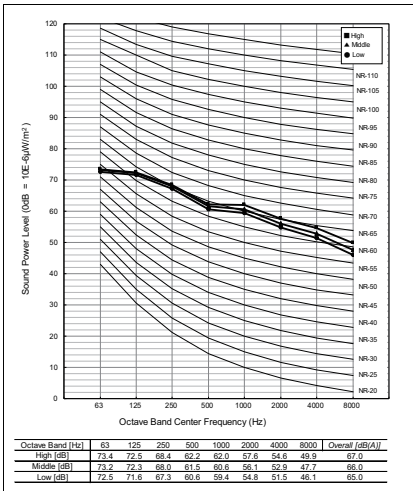

ARNU36GM2A4

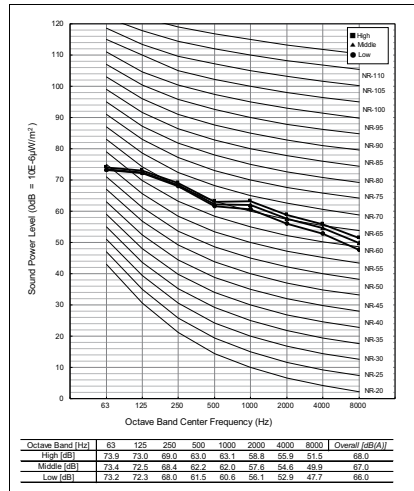

ARNU42GM2A4

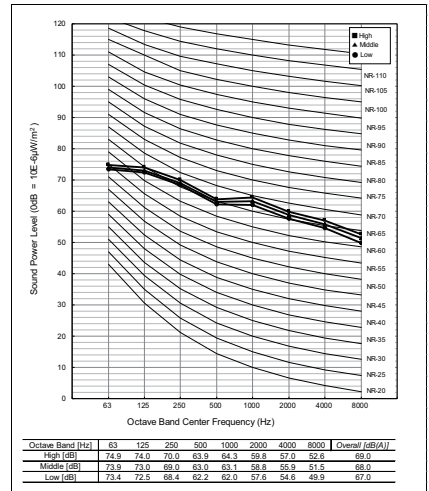

9. Sound Levels

9.2.2 Sound Power Levels (Body)

Model	Sound Power Levels [dB(A), Body(H-M-L)]			
	External Static Pressure [Pa]			
	20	39	59	147
ARNU07GM1A4	40 - 39 - 38	42 - 40 - 39	43 - 41 - 40	50 - 49 - 48
ARNU09GM1A4	41 - 39 - 39	43 - 40 - 39	43 - 42 - 40	50 - 49 - 48
ARNU12GM1A4	42 - 40 - 39	44 - 42 - 40	44 - 42 - 41	50 - 50 - 48
ARNU15GM1A4	46 - 42 - 40	48 - 45 - 42	48 - 44 - 42	52 - 51 - 50
ARNU18GM1A4	47 - 45 - 42	49 - 47 - 45	49 - 48 - 44	53 - 52 - 51
ARNU24GM1A4	48 - 47 - 45	50 - 48 - 45	51 - 49 - 48	53 - 52 - 51

■ Sound Power Level (20Pa)

ARNU07GM1A4

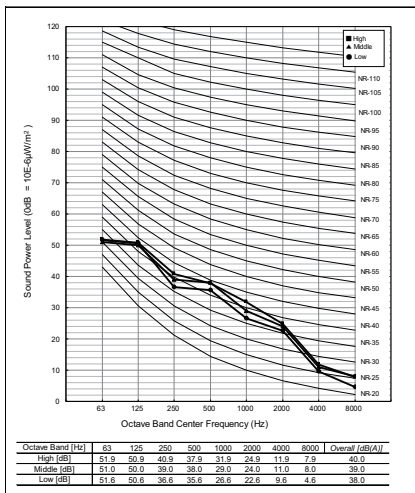

ARNU09GM1A4

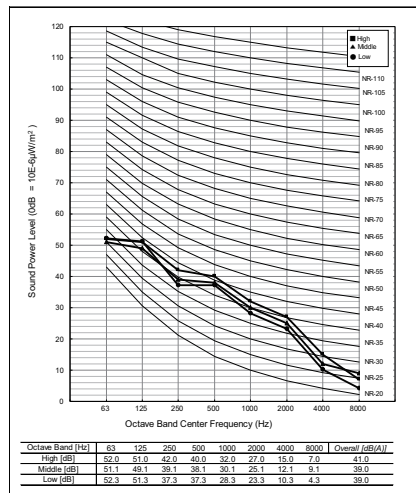

ARNU12GM1A4

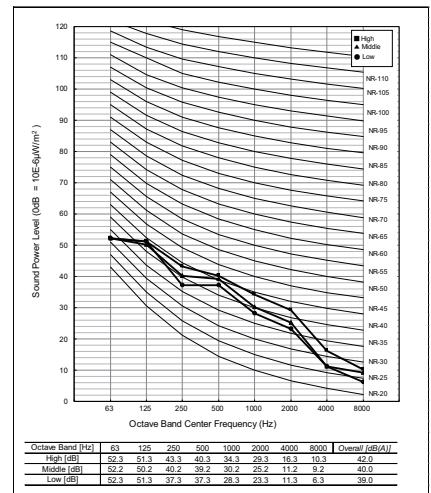

ARNU15GM1A4

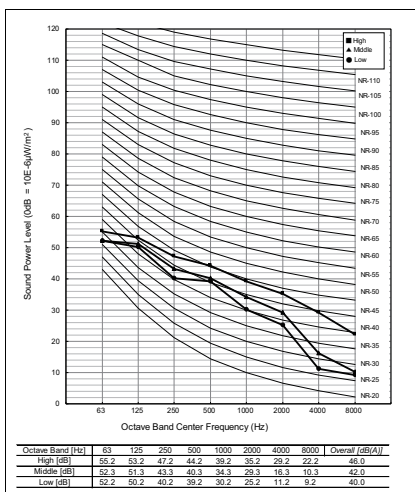

ARNU18GM1A4

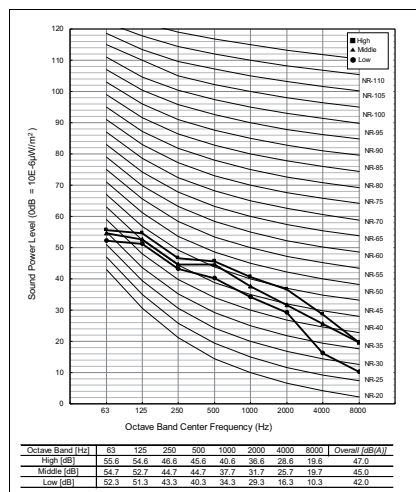

ARNU24GM1A4

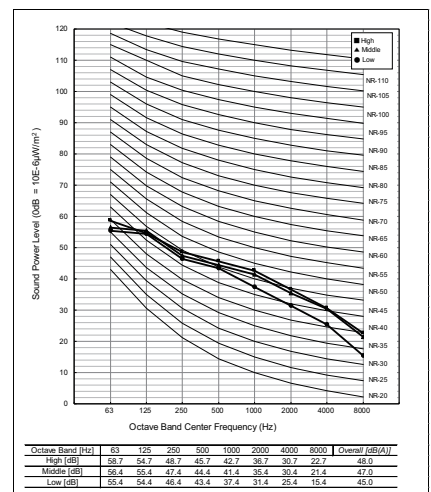

9. Sound Levels

■ Sound Power Level (39Pa)

ARNU07GM1A4

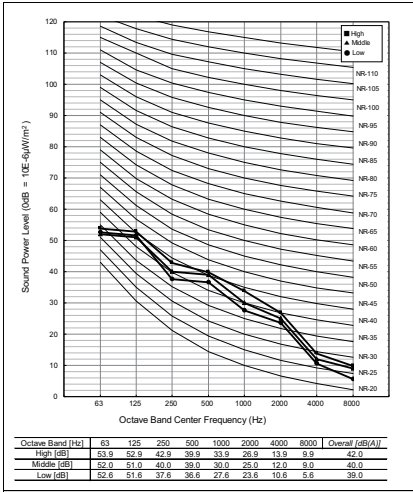

ARNU09GM1A4

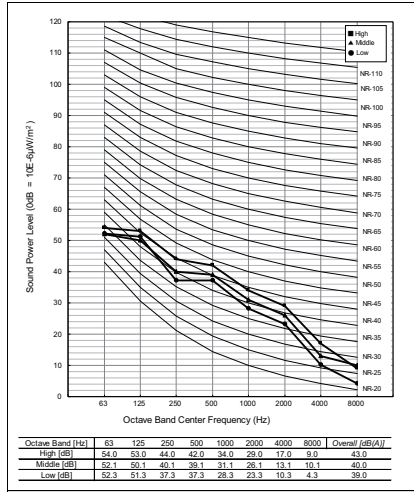

ARNU12GM1A4

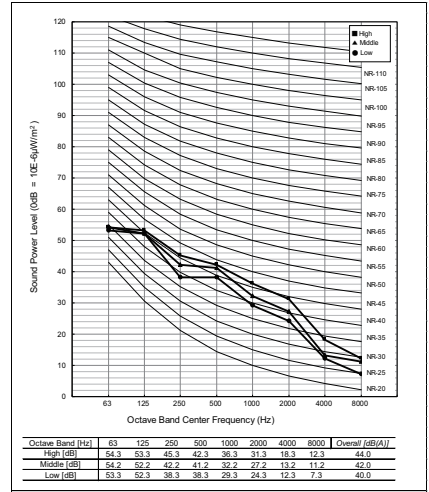

ARNU15GM1A4

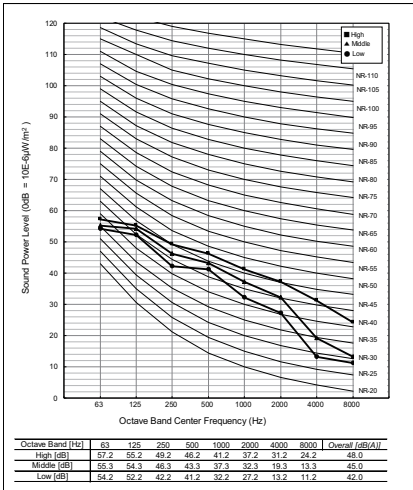

ARNU18GM1A4

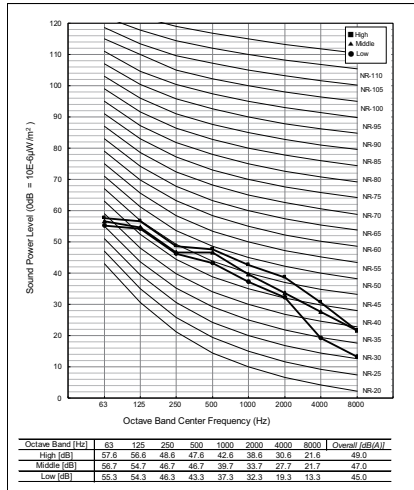

ARNU24GM1A4

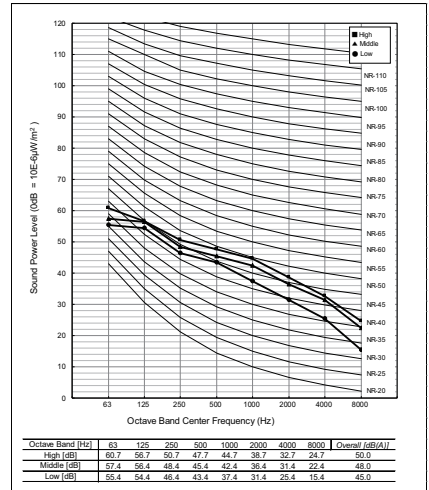

9. Sound Levels

■ Sound Power Level (59Pa)

ARNU07GM1A4

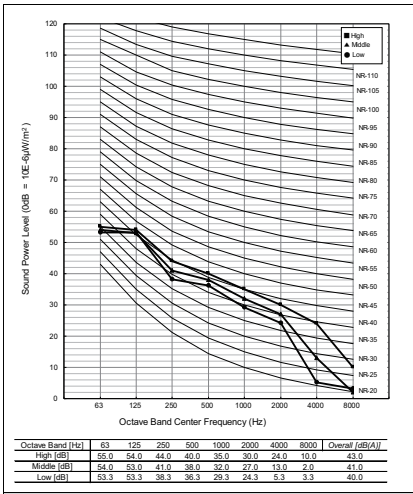

ARNU09GM1A4

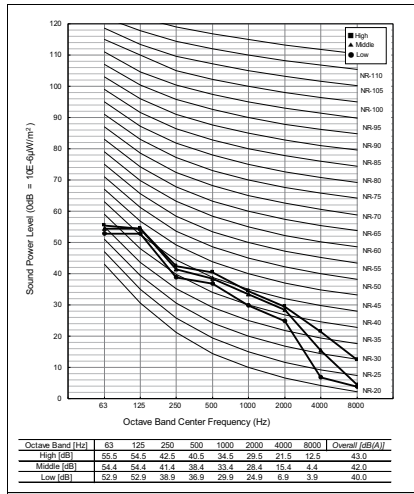

ARNU12GM1A4

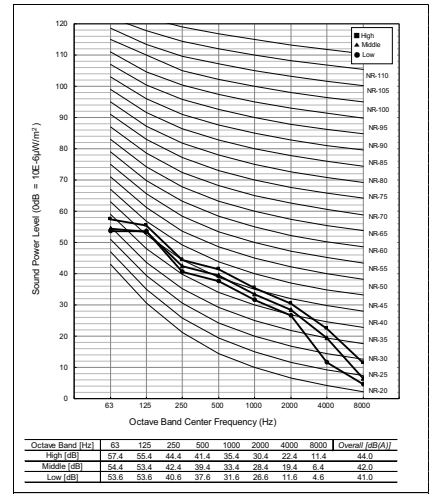

ARNU15GM1A4

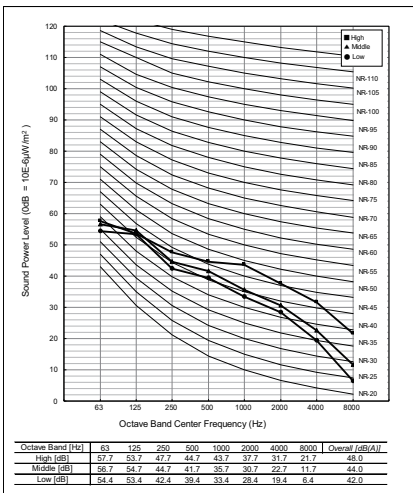

ARNU18GM1A4

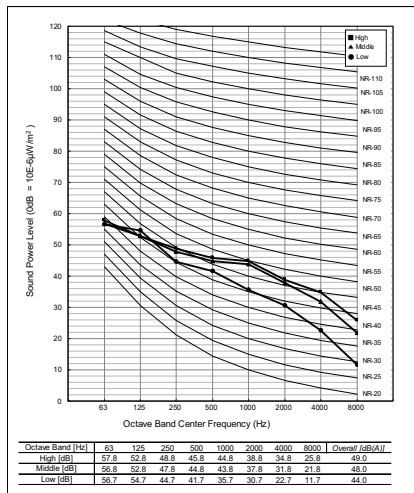

ARNU24GM1A4

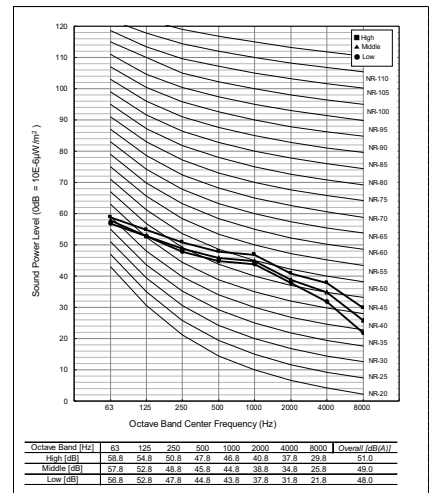

9. Sound Levels

■ Sound Power Level (147Pa)

ARNU07GM1A4

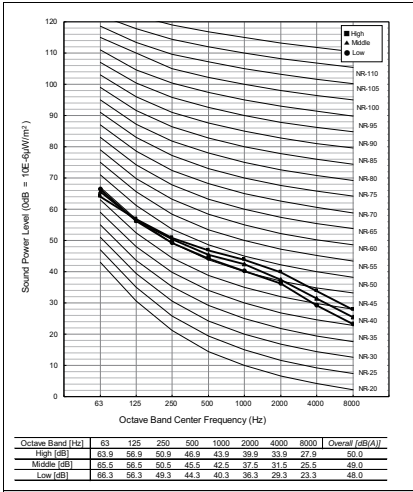

ARNU09GM1A4

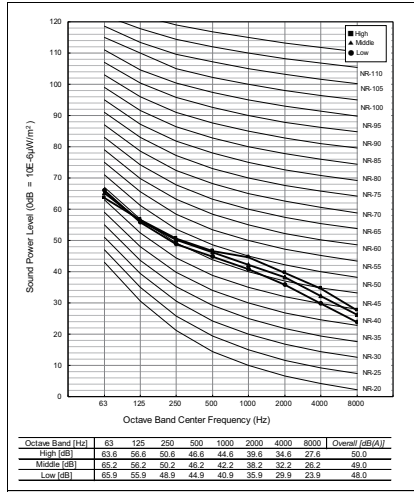

ARNU12GM1A4

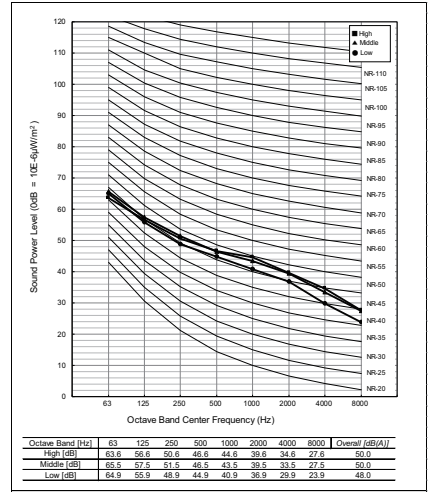

ARNU15GM1A4

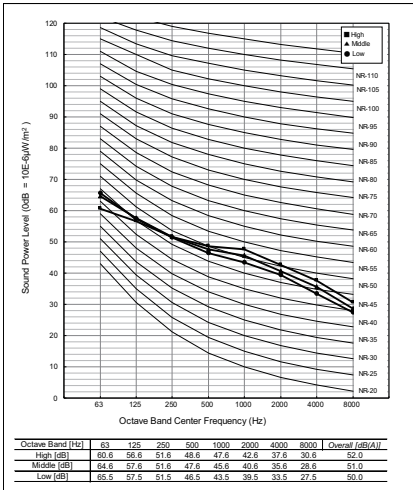

ARNU18GM1A4

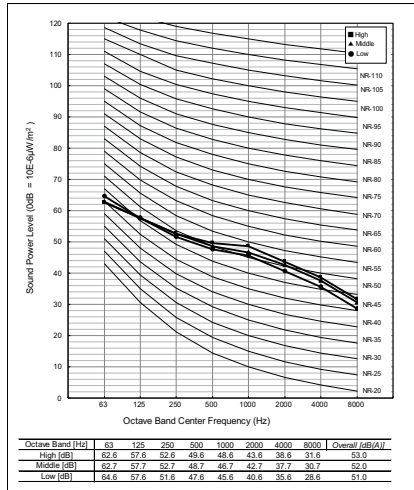

ARNU24GM1A4

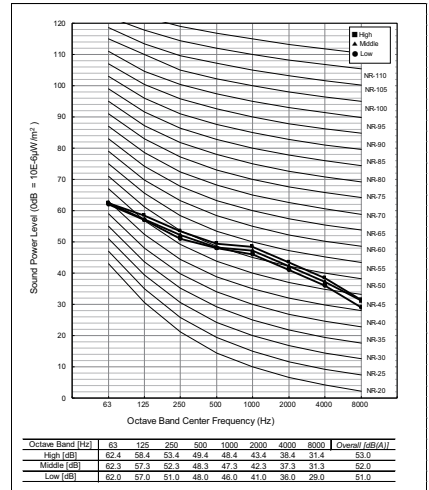

9. Sound Levels

Model	Sound Power Levels [dB(A), Body(H-M-L)]				
	External Static Pressure [Pa]				
	39	49	59	147	176
ARNU28GM2A4	48 - 47 - 45	49 - 47 - 45	48 - 46 - 44	55 - 54 - 53	64 - 63 - 62
ARNU36GM2A4	50 - 48 - 47	51 - 48 - 46	51 - 48 - 46	56 - 55 - 54	65 - 64 - 63
ARNU42GM2A4	55 - 52 - 50	54 - 52 - 49	54 - 52 - 49	59 - 58 - 56	66 - 65 - 64

■ Sound Power Level (39Pa)

ARNU28GM2A4

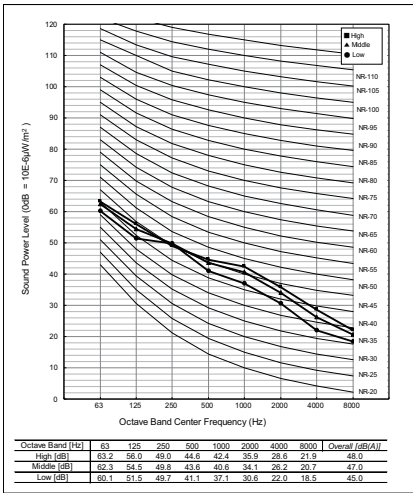

ARNU36GM2A4

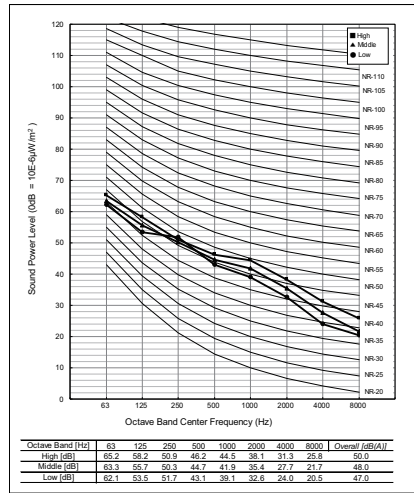

ARNU42GM2A4

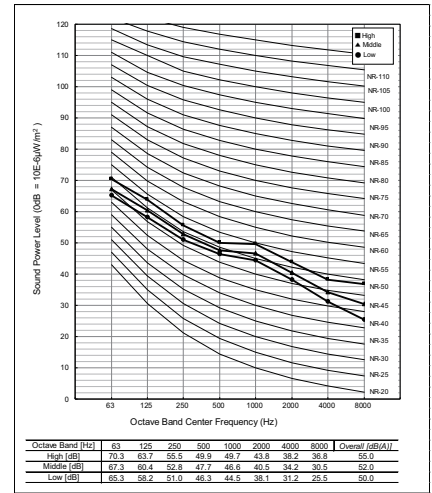

■ Sound Power Level (49Pa)

ARNU28GM2A4

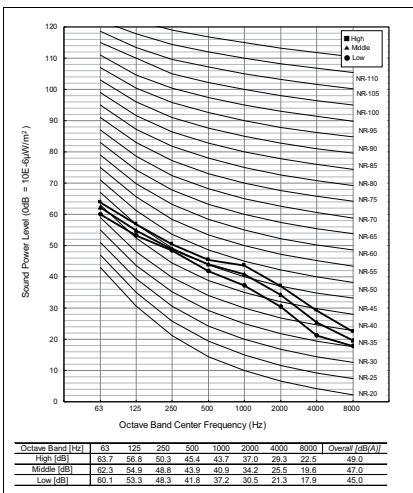

ARNU36GM2A4

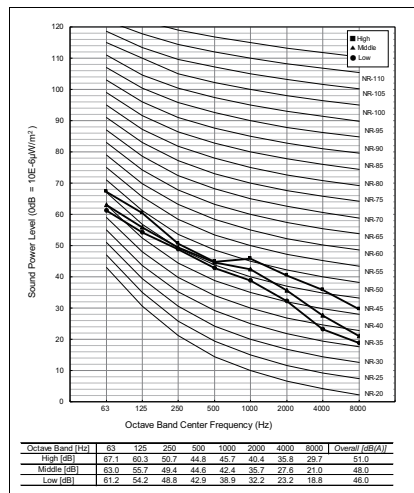

ARNU42GM2A4

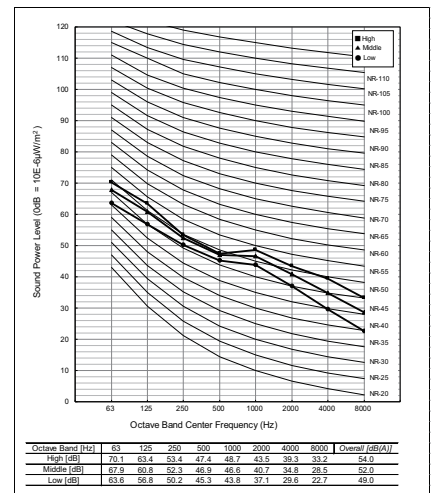

9. Sound Levels

■ Sound Power Level (59Pa)

ARNU28GM2A4

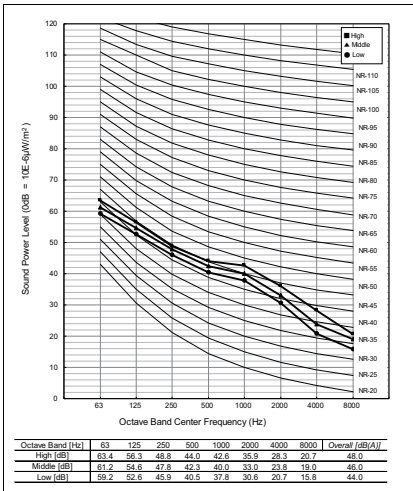

ARNU36GM2A4

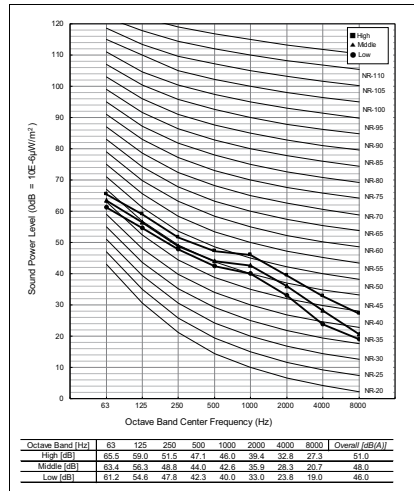

ARNU42GM2A4

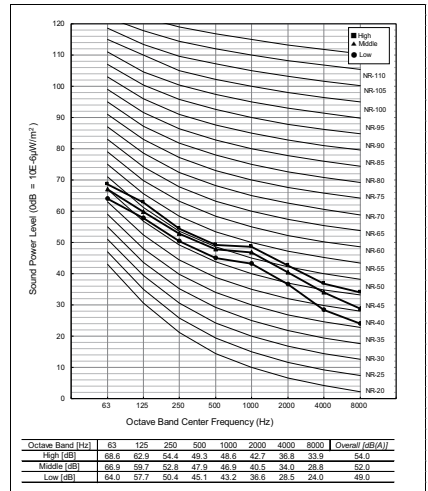

■ Sound Power Level (147Pa)

ARNU28GM2A4

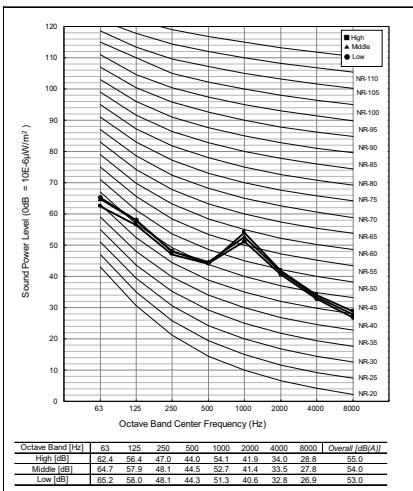

ARNU36GM2A4

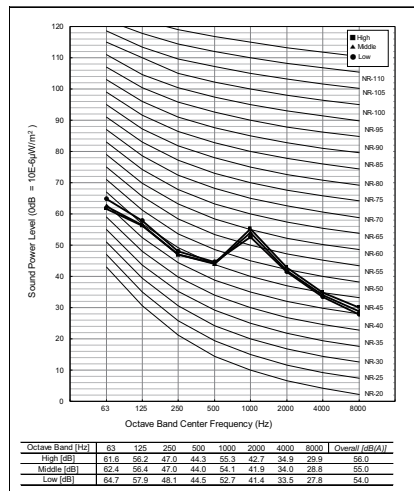

ARNU42GM2A4

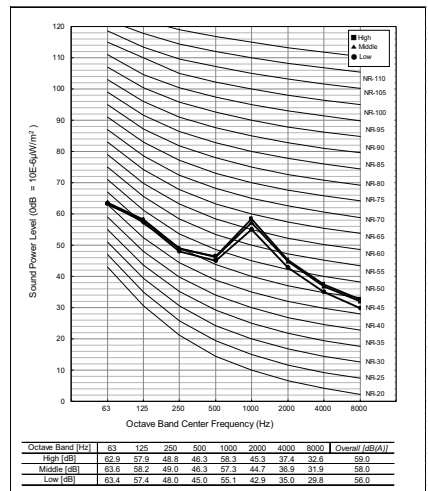

9. Sound Levels

■ Sound Power Level (176Pa)

ARNU28GM2A4

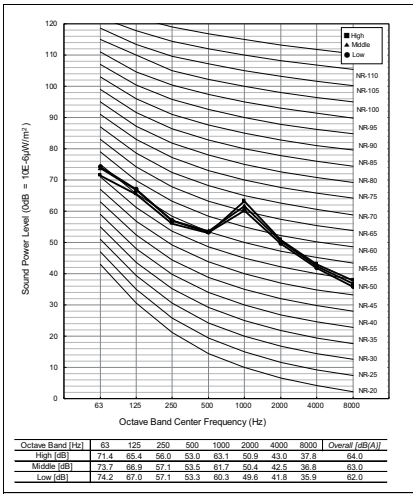

ARNU36GM2A4

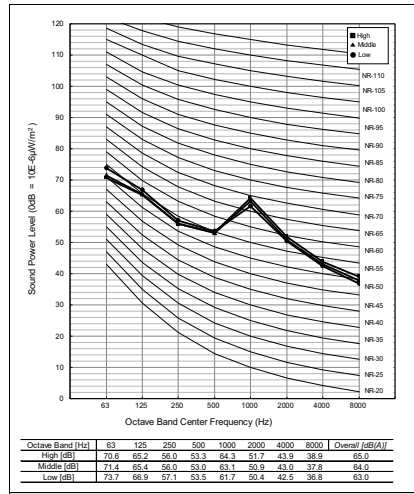

ARNU42GM2A4

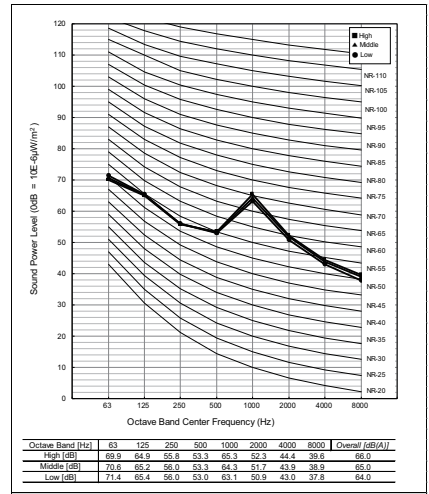

9. Sound Levels

Model	Sound Power Levels [dB(A), Body(H-M-L)]				
	External Static Pressure [Pa]				
	39	49	59	147	196
ARNU48GM3B4	61-60-59	63-60-59	63-61-59	66-66-64	71-70-70
ARNU54GM3B4	64-62-61	65-64-62	65-64-64	66-66-65	71-71-71

■ Sound Power Level (39Pa)

ARNU48GM3B4

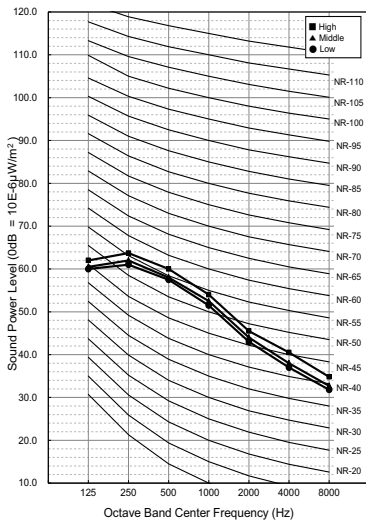

ARNU54GM3B4

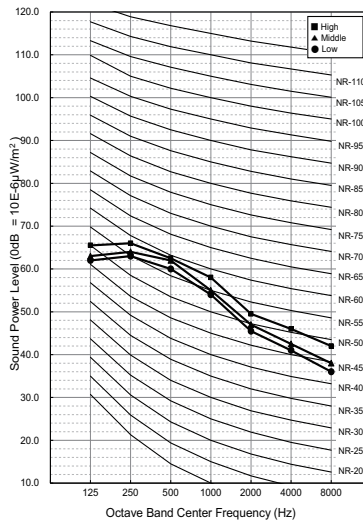

■ Sound Power Level (49Pa)

ARNU48GM3B4

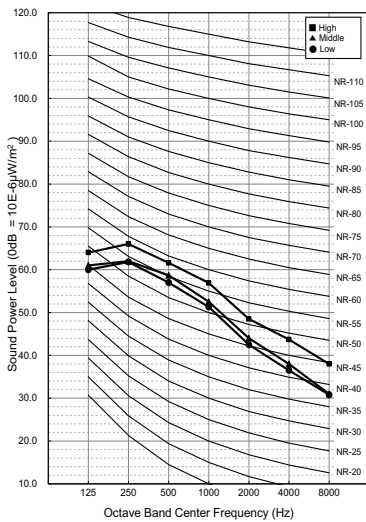

ARNU54GM3B4

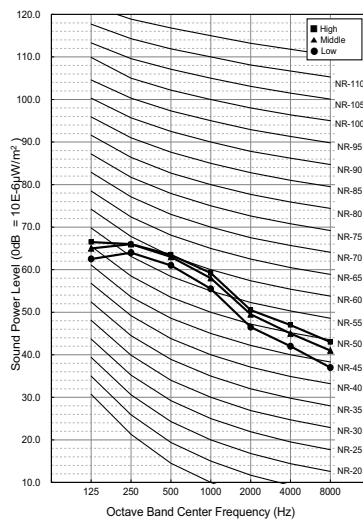

9. Sound Levels

■ Sound Power Level (59Pa)

ARNU48GM3B4

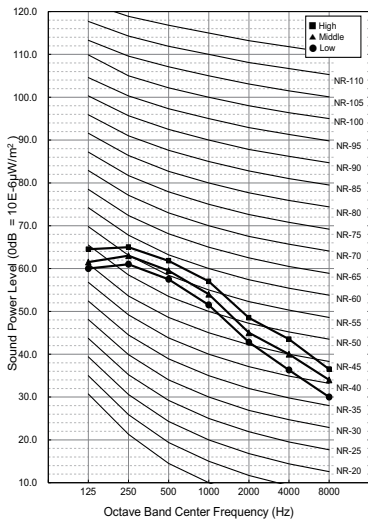

ARNU54GM3B4

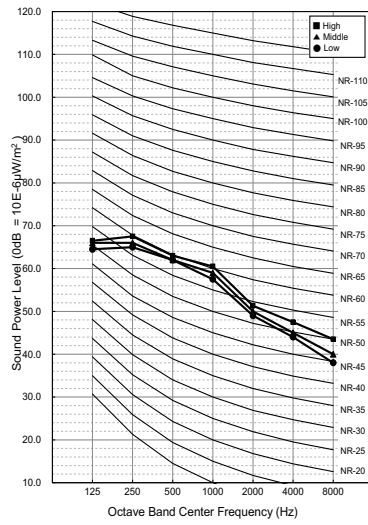

■ Sound Power Level (147Pa)

ARNU48GM3B4

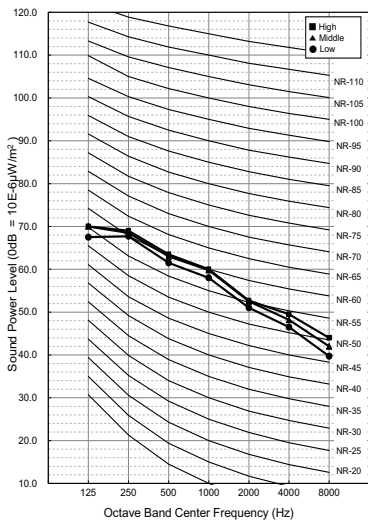

ARNU54GM3B4

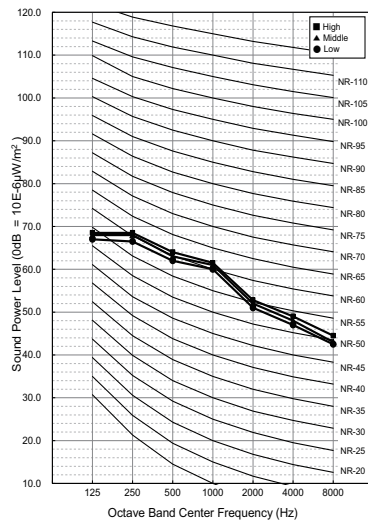

9. Sound Levels

■ Sound Power Level (196Pa)

ARNU48GM3B4

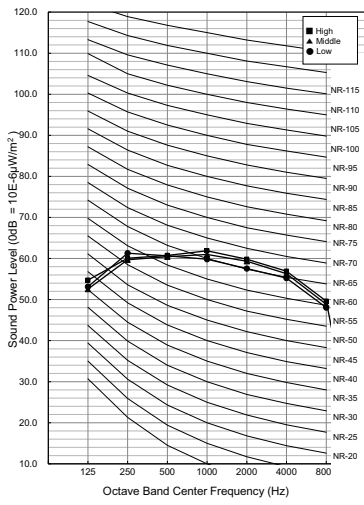

ARNU54GM3B4

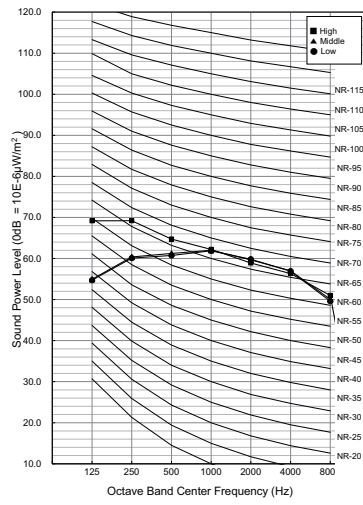

9. Sound Levels

Model	Sound Power Levels [dB(A), Body(H-M-L)]		
	External Static Pressure (Pa)		
	120	150	220
ARNU76GB8A4	61-60-60	63-62-62	67-66-66
ARNU96GB8A4	63-62-62	65-64-64	68-67-67

■ Sound Power Level (120Pa)

ARNU76GB8A4

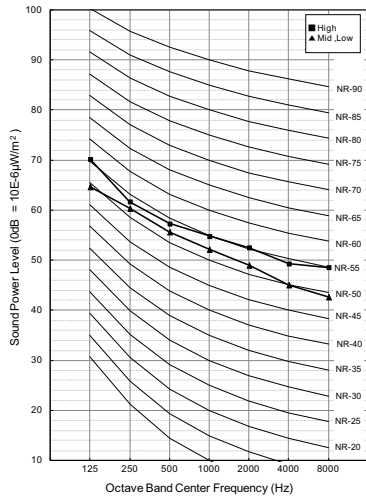

ARNU96GB8A4

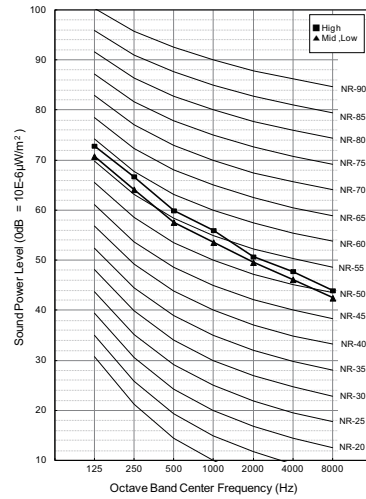

■ Sound Power Level (150Pa)

ARNU76GB8A4

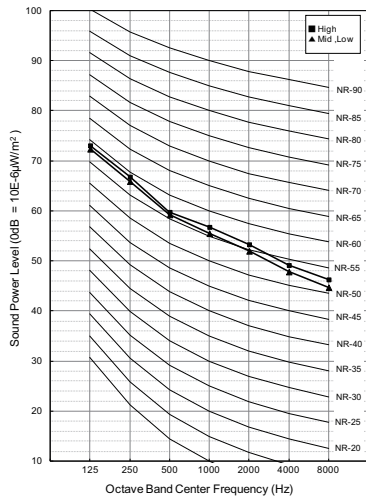

ARNU96GB8A4

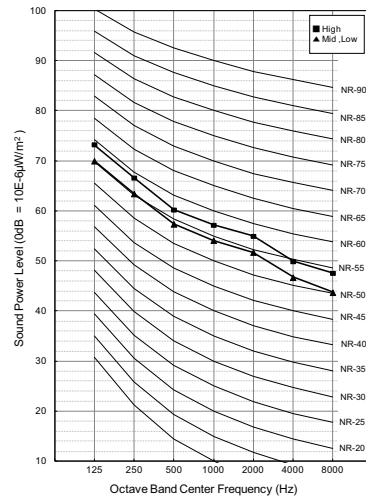

9. Sound Levels

■ Sound Power Level (220Pa)

ARNU76GB8A4

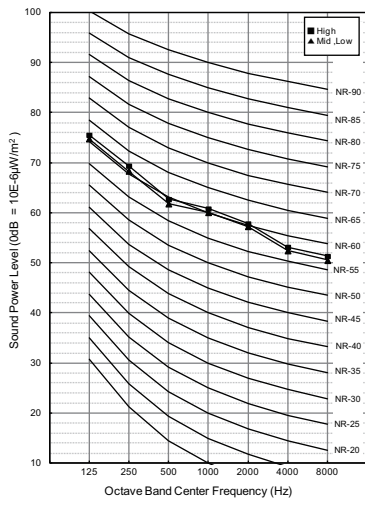

ARNU96GB8A4

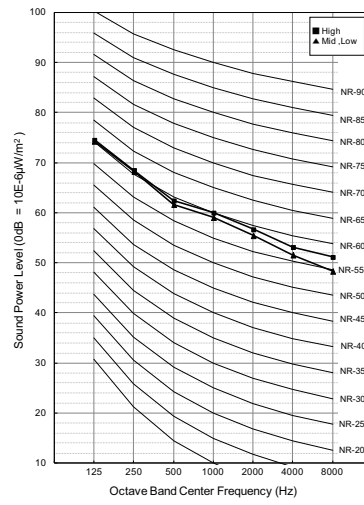

9. Sound Levels

9.2.3 Sound Power Levels (Outlet)

Model	Sound Power Levels [dB(A), Outlet(H-M-L)]			
	External Static Pressure [Pa]			
	20	39	59	147
ARNU07GM1A4	47 - 46 - 43	50 - 47 - 45	52 - 49 - 47	59 - 57 - 56
ARNU09GM1A4	48 - 46 - 43	51 - 47 - 45	52 - 50 - 48	59 - 57 - 56
ARNU12GM1A4	50 - 47 - 45	53 - 50 - 46	53 - 51 - 49	60 - 59 - 57
ARNU15GM1A4	58 - 50 - 47	59 - 54 - 50	59 - 53 - 51	64 - 61 - 59
ARNU18GM1A4	59 - 57 - 50	60 - 57 - 54	61 - 58 - 53	65 - 63 - 61
ARNU24GM1A4	60 - 57 - 54	62 - 58 - 54	63 - 61 - 58	65 - 63 - 61

■ Sound Power Level (20Pa)

ARNU07GM1A4

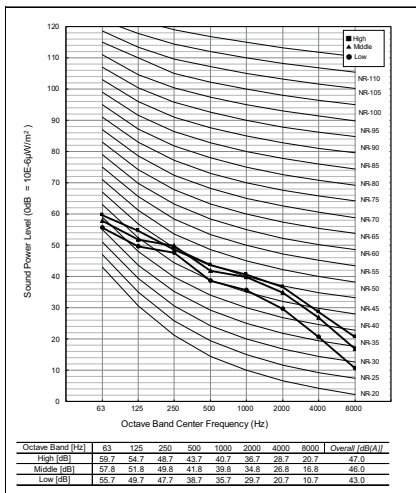

ARNU09GM1A4

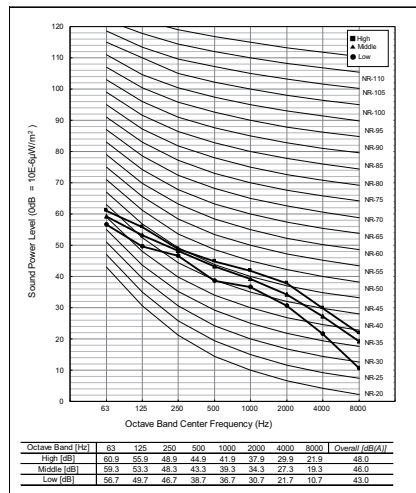

ARNU12GM1A4

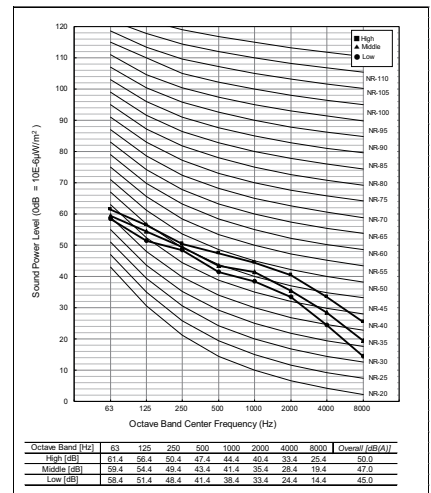

ARNU15GM1A4

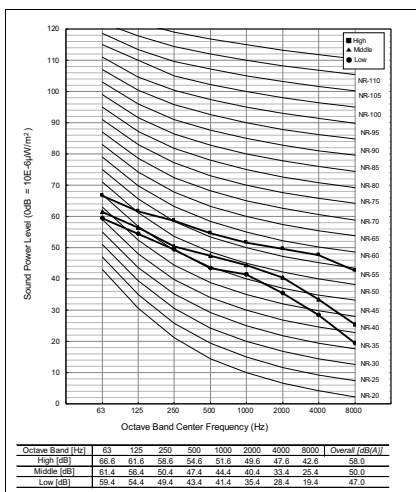

ARNU18GM1A4

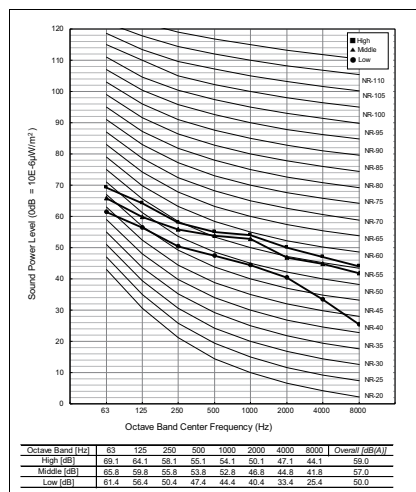

ARNU24GM1A4

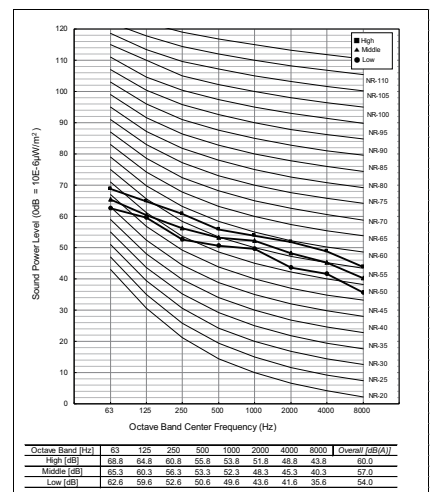

9. Sound Levels

■ Sound Power Level (39Pa)

ARNU07GM1A4

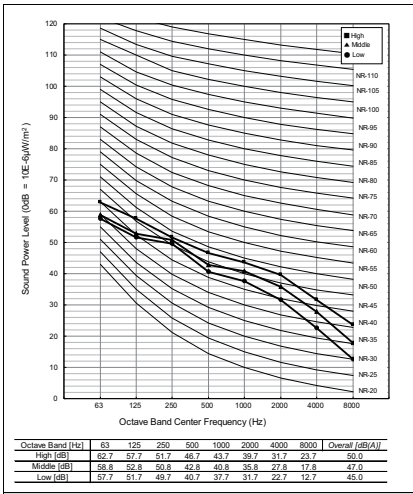

ARNU09GM1A4

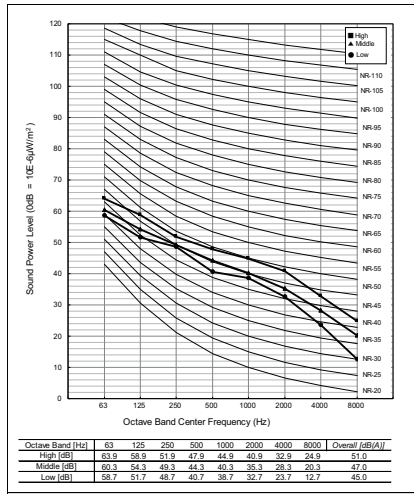

ARNU12GM1A4

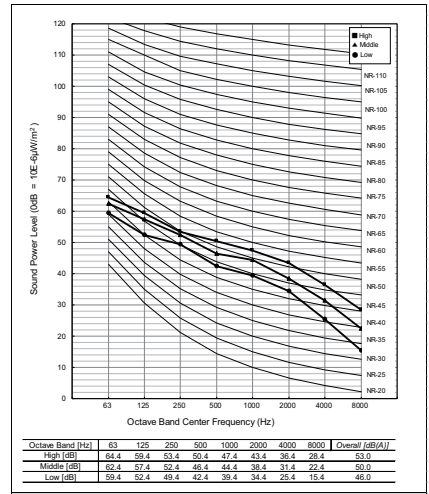

ARNU15GM1A4

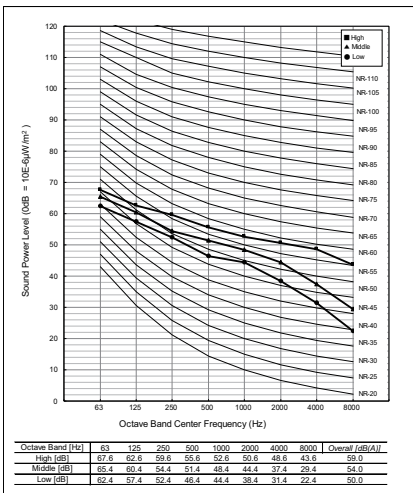

ARNU18GM1A4

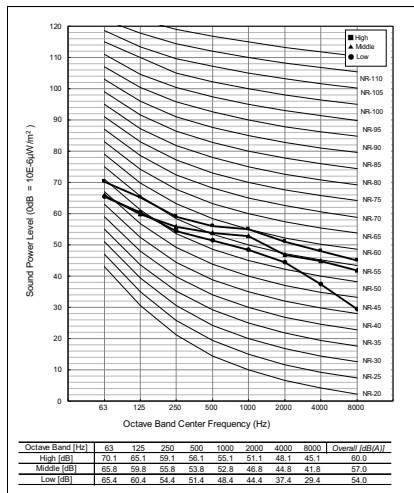

ARNU24GM1A4

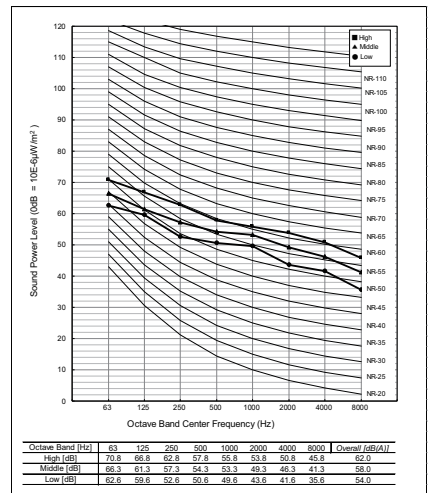

9. Sound Levels

■ Sound Power Level (59Pa)

ARNU07GM1A4

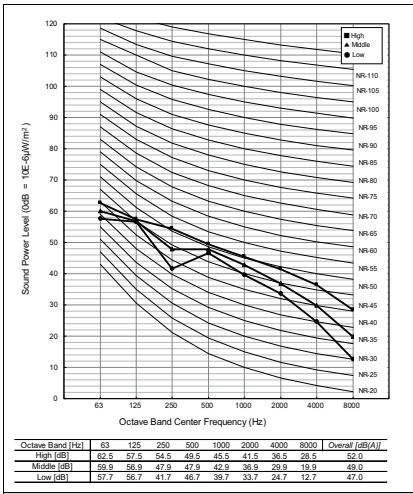

ARNU09GM1A4

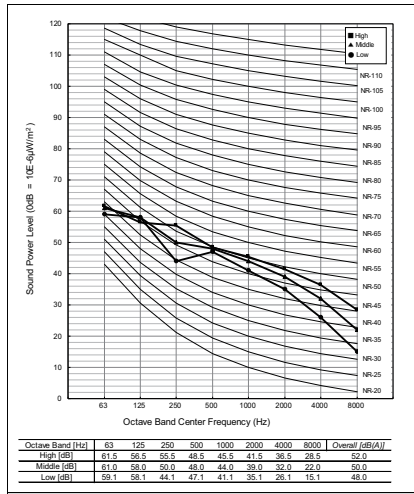

ARNU12GM1A4

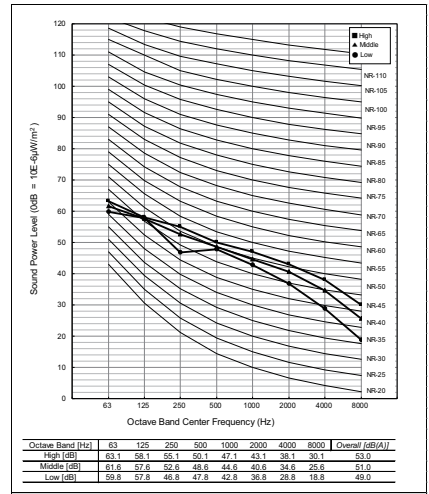

ARNU15GM1A4

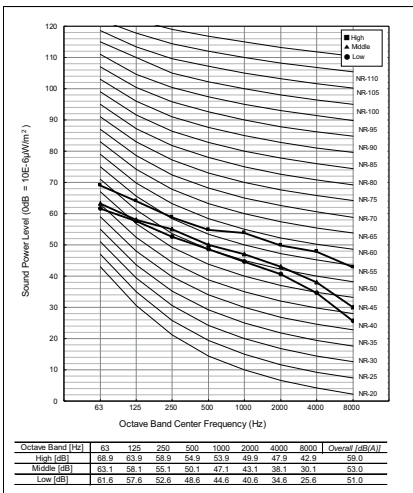

ARNU18GM1A4

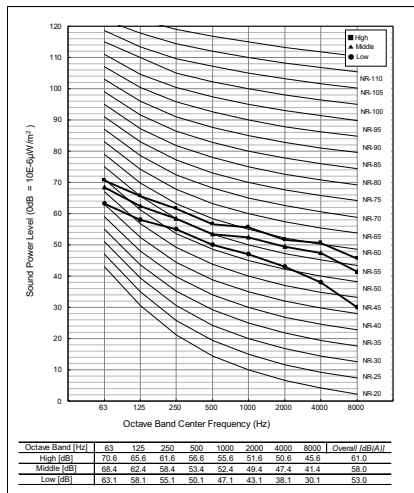

ARNU24GM1A4

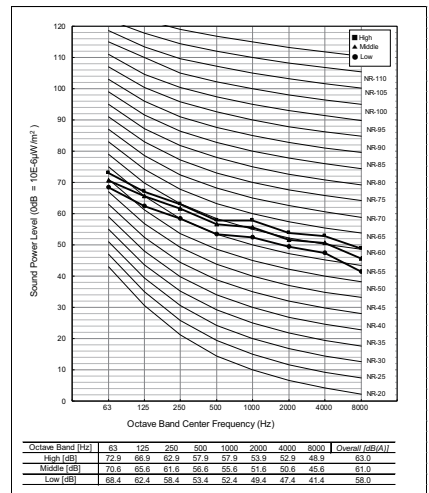

9. Sound Levels

■ Sound Power Level (147Pa)

ARNU07GM1A4

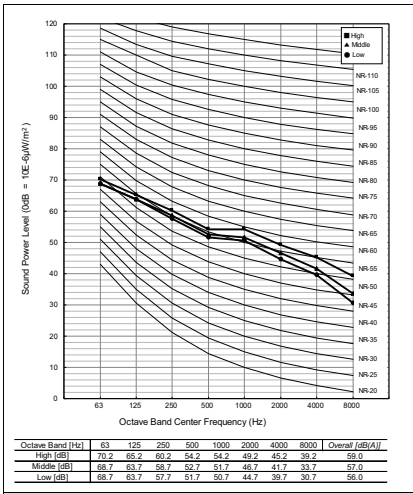

ARNU09GM1A4

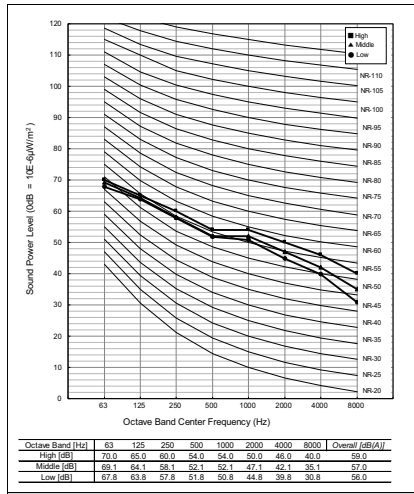

ARNU12GM1A4

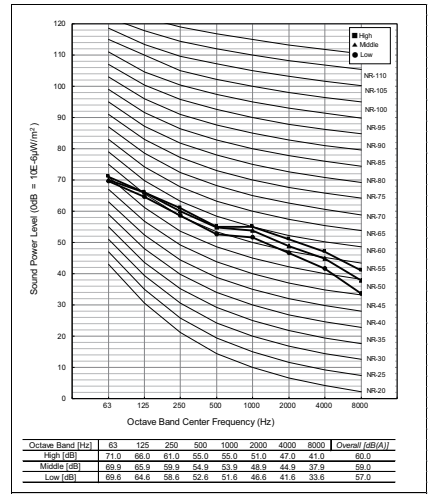

ARNU15GM1A4

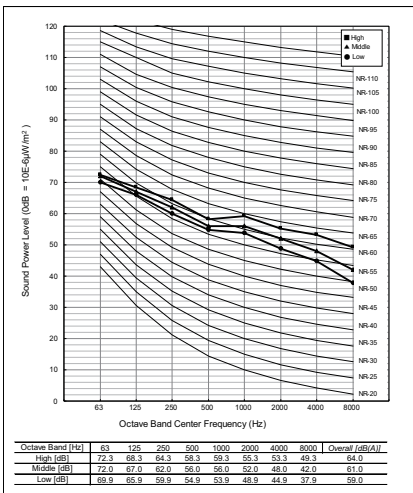

ARNU18GM1A4

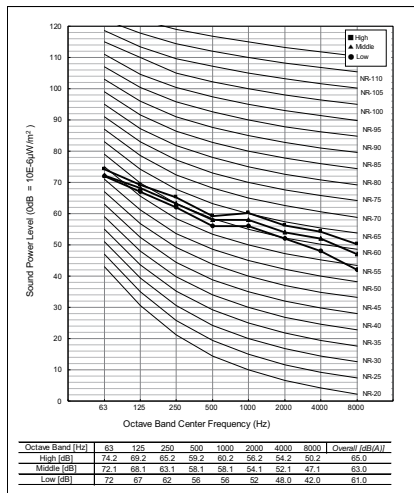

ARNU24GM1A4

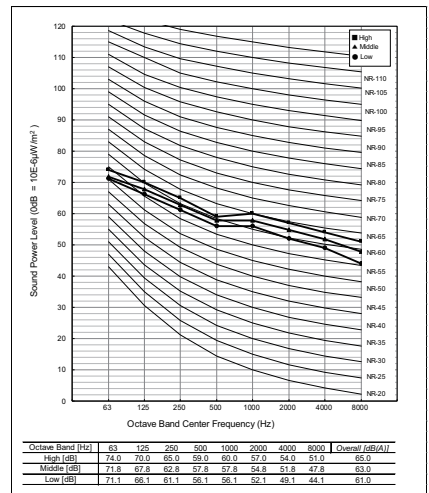

9. Sound Levels

Model	Sound Power Levels [dB(A), Outlet(H-M-L)]				
	External Static Pressure [Pa]				
	39	49	59	147	176
ARNU28GM2A4	62 - 59 - 58	63 - 61 - 59	63 - 60 - 58	70 - 68 - 67	72 - 71 - 70
ARNU36GM2A4	64 - 62 - 59	65 - 62 - 60	66 - 63 - 60	71 - 70 - 68	73 - 72 - 71
ARNU42GM2A4	69 - 66 - 63	69 - 66 - 63	69 - 66 - 63	76 - 74 - 71	76 - 74 - 73

■ Sound Power Level (39Pa)

ARNU28GM2A4

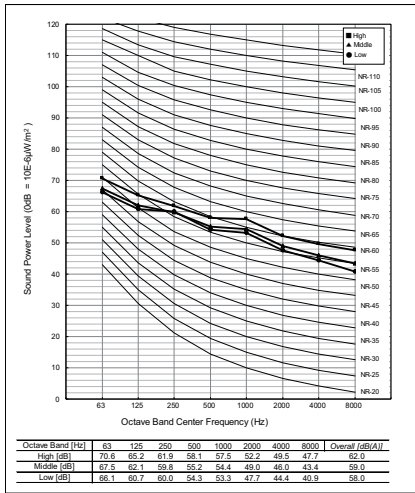

ARNU36GM2A4

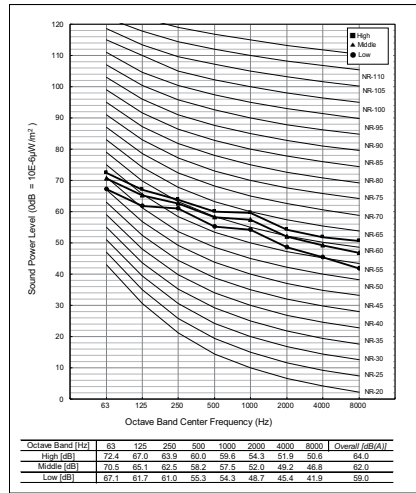

ARNU42GM2A4

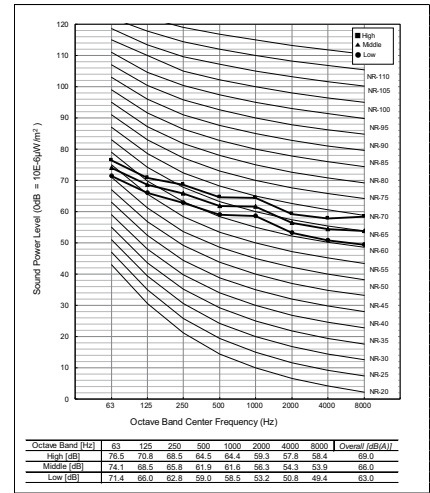

■ Sound Power Level (49Pa)

ARNU28GM2A4

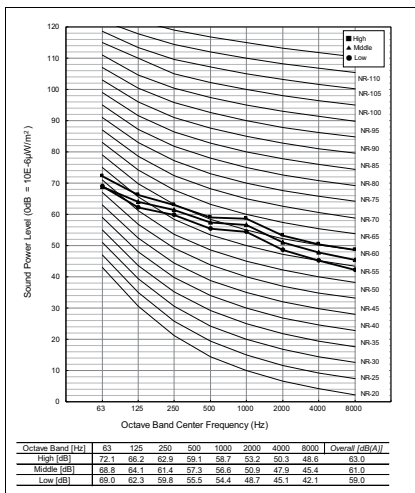

ARNU36GM2A4

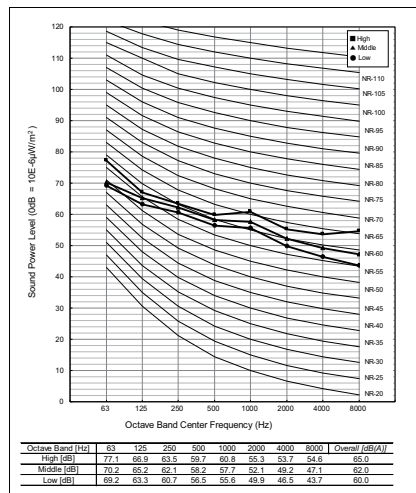

ARNU42GM2A4

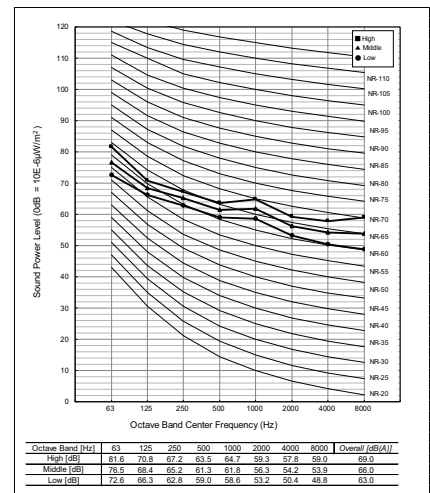

9. Sound Levels

■ Sound Power Level (59Pa)

ARNU28GM2A4

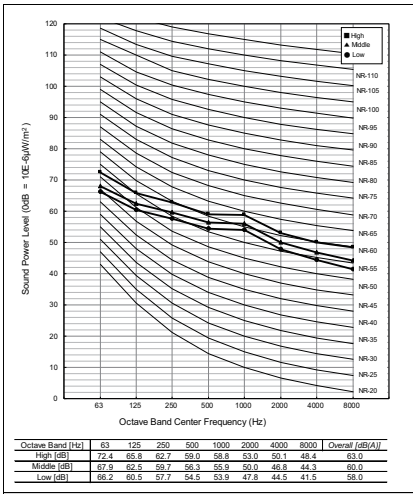

ARNU36GM2A4

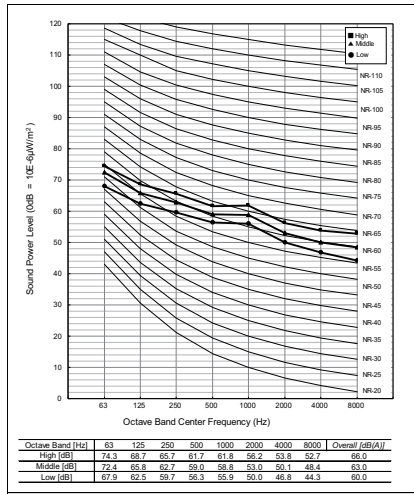

ARNU42GM2A4

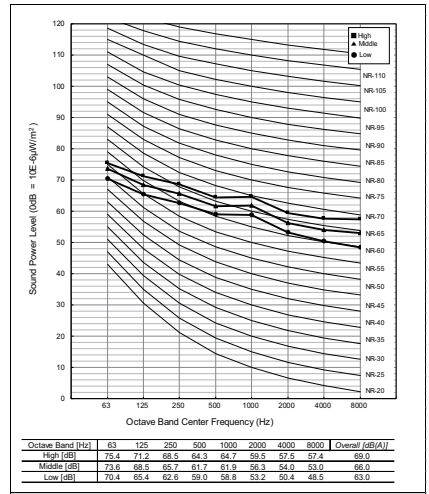

■ Sound Power Level (147Pa)

ARNU28GM2A4

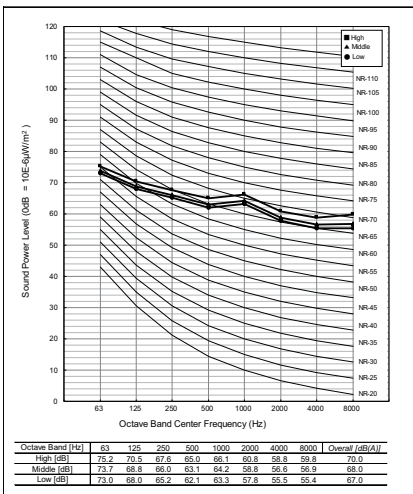

ARNU36GM2A4

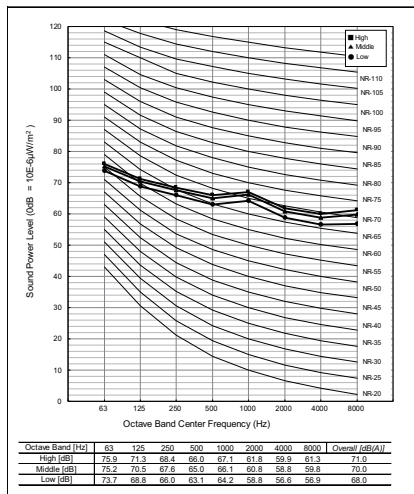

ARNU42GM2A4

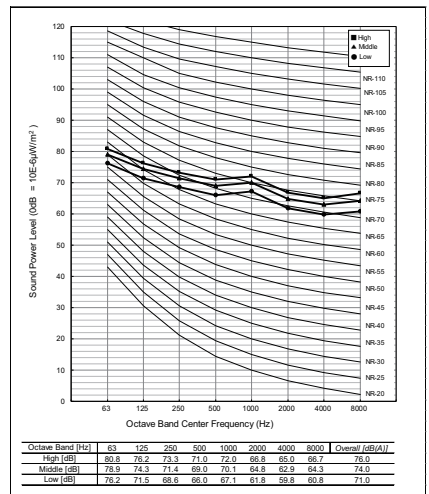

9. Sound Levels

■ Sound Power Level (176Pa)

ARNU28GM2A4

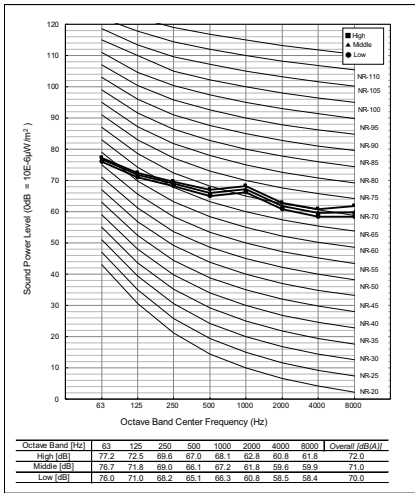

ARNU36GM2A4

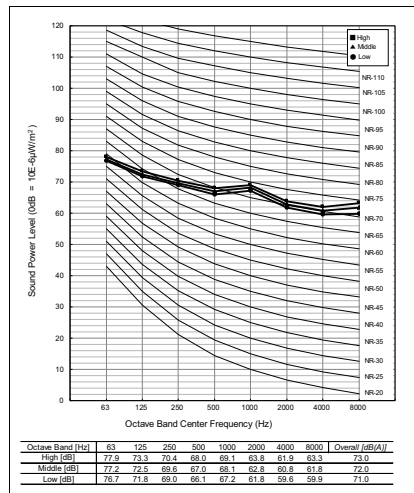

ARNU42GM2A4

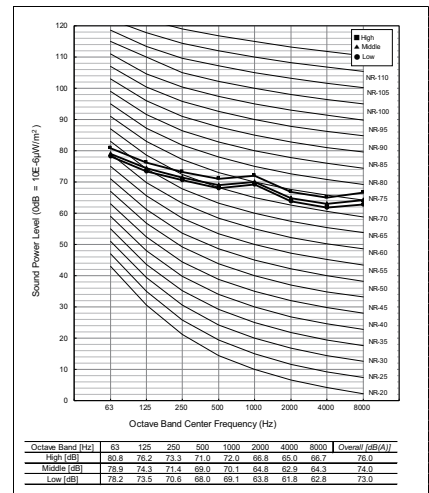

Ceiling Concealed Duct (High Static(2))

- 1.List of functions**
- 2.Specifications**
- 3.Dimensions & Gravity Point**
- 4.Piping Diagrams**
- 5.Wiring Diagrams**
- 6.Capacity Tables**
- 7.External Static Pressrue(E.S.P) & Air Flow**
- 8.Electric Characteristics**
- 9.Sound Levels**

1. List of functions

◆ List of functions

Category	Function	ARNU48GM3A4, ARNU54GM3A4
Air Flow	Air Supply Outlet	1
	Airflow Steps (fan/cool/heat)	3 / 3 / 3
	Fan Speed Auto*	X
	Power Cool/Heat	X / X
	Dry Operation	O
Air Purification	Air Purify	Accessory
	UV-C	Accessory
	Pre-Filter	O
Reliability	Hot Start	O
	Self Diagnosis	O
Convenience	Auto Mode	O
	Auto Dry Operation	O
	Auto Restart	O
	Child Lock*	O
	Group Control*	O
	Sleep Timer	O
	Turn On/Off Reservation	O
	Schedule*	O
	Two Thermistor Control*	O
External On/Off	O	
Installation	Drain Pump	O
	E.S.P. Setting*	O
	Auto E.S.P. Control*	O
Special Functions	Wi-Fi	Accessory

Note

- O : Applied, X : Not Applied, - : Unconfirmed or irrelevant
Embedded : A kit is provided by default for using this function when the product is manufactured.
Accessory : Ordered and purchased separately the accessory package referring to the model name provided and install at field. Accessory line-ups varies by region, so check your local catalogue or local sales material.
- Some functions can be limited by remote controller.
- Selecting a wireless remote controller in case of ducted type indoor units requires either a connection to the wired remote controller (Standard II) or an IR receiver accessory to be connected to the duct in order to receive the signal.
- 'Auto Mode' varies depending on the outdoor unit type.
 - Auto Change Over(Heat Recovery Outdoor Unit)
 - Auto Mode Select(Heat Pump Outdoor Unit)
 - Auto Intensity Control(Cooling Only Outdoor Unit)
- * : These functions need to connect the wired remote controller.

1. List of functions

◆ Accessory Compatibility List

Category	Accessory Name	Model Name	Description	ARNU**M3A4
Remote Controller	Wired - Premium	PREMTA000	-	○
		PREMTA000A	-	○
		PREMTA000B	-	○
	Wired - RS3 (Standard III)	PREMTB100/PREMTB101	White	○
		PREMTBB10/PREMTBB11	Black	○
	Wired - RS2 (Standard II)	PREMTB001	White	○
		PREMTBB01	Black	○
	Wired - Simple	PQRCVCL0QW	White	○
		PQRCVCL0Q	Black	○
	Wired - Simple for Hotel	PQRCHCA0QW	White	○
		PQRCHCA0Q	Black	○
	Wireless	PQWRCQ0FDB	For Cooling only	○
		PQWRHQ0FDB	For Heat pump	○
		PWLSSB21C	For Cooling only	○
PWLSSB21H		For Heat pump	○	
Dry Contact	Simple	PDRYCB000	1 input port, AC 220 - 240V	○
		PDRYCB100	1 input port, AC 24V	○
	Communication	PDRYCB400	2 input port	○
		PDRYCB300	8 input port, For 3rd party Thermostat	○
		PDRYCB320	8 input port, For 3rd Party Thermostat (Analog Input)	○
		PDRYCB500	For 3rd Party Controller (Modbus RTU)	○
Integration Device	Remote Temperature sensor	PQRSTA0	-	○
	Zone Controller	ABZCA	For Duct, 4zone, 220-240V	○
	Group Control wire	PZCWRCG3	Cable Assembly For group control (Y-type cable : 0.25m, cable : 9.6m)	○
ETC	Extension wire	PZCWRC1	Extension wire For IDU-wired remote controller (9.6m)	X
	2-Remo Control Wire	PZCWRC2	-	X
	Wi-Fi Modem	PWFMDD200	-	○
	Wi-Fi Extension cable	PWYREW000	USB Extension cable : 10 m	○
	IR Receiver	PWLRVN000	For wireless remote controller with Duct	○
	Independent Power Module	PRIP0	-	○
	Multi-tenant Power module	PINPMB001	-	○
	Refrigerant Leakage Detector	PRLDNVS0	For R410A only	○
	UVnano Filter Box	PBM13M1UA0	For M1 Chassis	X
		PBM13M2UA0	For M2 Chassis	X
		PBM13M3UA0	For M3 Chassis	○
	High Efficiency Filter (Main Filter of Filter Box)	FBM13M1UA0	For M1 UVnano Filter Box	X
		FBM13M2UA0	For M2 UVnano Filter Box	X
		FBM13M3UA0	For M3 UVnano Filter Box	○
EEV Kit	PRGK024A0	For Multi V Indoor Unit	X	
Auxiliary Heater Relay Kit	PRARH1	For Cassette and Duct Indoor Units	○	

Note

1. O: Possible, X: Impossible, -: Not applicable, Embedded: Included with product.
2. If there is a difference in development time between the product and the remote controller, some functions cannot be operated.
3. If using Wi-Fi controller, Some advanced functions controlled by remote controller cannot be operated.
4. Selecting a wireless remote controller in case of ducted type indoor units requires either a connection to the wired remote controller (Standard II) or an IR receiver accessory to be connected to the duct in order to receive the signal.
5. If you need more detail, please refer to the **BECON** PDB or the manual of product. (<http://partner.lge.com> > Select Your Region : Home > Doc.Library > Product > Control(BECON))

2. Specifications

Type		Ceiling Concealed Duct (High Static(2))			
Model	Unit	ARNU48GM3A4	ARNU54GM3A4		
Cooling Capacity	kW	14.1	15.8		
	kcal/h	12,100	13,600		
	Btu/h	48,100	54,000		
Heating Capacity	kW	15.9	18.0		
	kcal/h	13,600	15,500		
	Btu/h	54,200	61,400		
Power Input (H / M / L)		W	172 / 105 / 65	260 / 215 / 172	
Casing		Galvanized Steel Plate			
Dimensions (WxHxD)	Body	mm	1,250 × 360 × 700	1,250 × 360 × 700	
		inch	49-7/32 x 14-3/16 x 27-9/16	49-7/32 x 14-3/16 x 27-9/16	
Coil	Rows x Columns x FPI		3 x 16 x 18	3 x 16 x 18	
	Face Area	m ²	0.32	0.32	
Fan	Type		Sirocco Fan	Sirocco Fan	
	Motor Output x Number		W	400 x 1	400 x 1
	Air Flow Rate (H / M / L) (Factory set)	m ³ /min	40.0 / 34.0 / 28.0	50.0 / 45.0 / 40.0	
		ft ³ /min	1,413 / 1,201 / 989	1,766 / 1,589 / 1,413	
	External Static Pressure		mmAq(Pa)	6(59)	6(59)
	External Static Pressure (Min ~ Max)		mmAq (Pa)	4(39) ~ 15(147)	4(39) ~ 15(147)
	Drive		Direct		
Motor type		BLDC			
Temperature Control		Microprocessor, Thermostat for cooling and heating	Microprocessor, Thermostat for cooling and heating		
Sound Absorbing Thermal Insulation Material		Foamed polystyrene			
Air Filter		-			
Safety Device		Fuse			
Pipe Connections	Liquid Side	mm(inch)	Ø9.52(3/8)	Ø9.52(3/8)	
	Gas Side	mm(inch)	Ø15.88(5/8)	Ø19.05(3/4)	
	Drain Pipe(Internal Dia.)	mm(inch)	25(1)	25(1)	
Net Weight	Body	kg(lbs)	42.2(93)	42.2(93)	
Sound Pressure Levels (H / M / L)		dB(A)	41 / 38 / 37	42 / 41 / 40	
Sound Power Levels (H / M / L, Body)		dB(A)	54 / 52 / 51	56 / 55 / 54	
Power Supply		Ø, V, Hz	1, 220 - 230 - 240, 50/60	1, 220 - 230 - 240, 50/60	
Running Current by voltage	Rated	A	0.85 - 0.81 - 0.78	1.28 - 1.23 - 1.18	
Maximum Running Current		A	2.50	2.50	
Refrigerant	Type		-	R410A / R32	
	Additional Charging Amount (CF Value of IDU)		kg(each)	0.61 / 0.50	
	Control		-	EEV	
Transmission cable		mm ²	1.0~1.5 x 2C	1.0~1.5 x 2C	

Note

- Due to our policy of innovation some specifications may be changed without notification.
- Wiring cable size must comply with the applicable local and national code. And "Electric characteristics" chapter should be considered for electrical work and design. Especially the power cable and circuit breaker should be selected in accordance with that.
- Sound pressure level is measured on the rated condition in the anechoic rooms by ISO 3745 standard.
Sound power level is measured on the rated condition in the semi-anechoic rooms by ISO 9614 standard.
Therefore, these values can be increased owing to ambient conditions during operation.
- Capacities are net capacities and based on the following conditions. Refer to the Outdoor Unit Specifications for calculating the real capacity.
 - Cooling : Indoor Ambient Temp. 27°CDB / 19°CWB, Outdoor Ambient Temp. 35°CDB / 24°CWB
 - Heating : Indoor Ambient Temp. 20°CDB / 15°CWB, Outdoor Ambient Temp. 7°CDB / 6°CWB
 - Interconnected Pipe is standard length and difference of Elevation (Outdoor ~ Indoor Unit) is 0m.
- Refrigerant information (type, additional charging amount, etc.) must be applied by refrigerant type of the combined outdoor unit.
Adapt after checking the specifications of outdoor unit.

3. Dimensions & Gravity point

3.1 Dimensional Drawing

ARNU48GM3A4 / ARNU54GM3A4

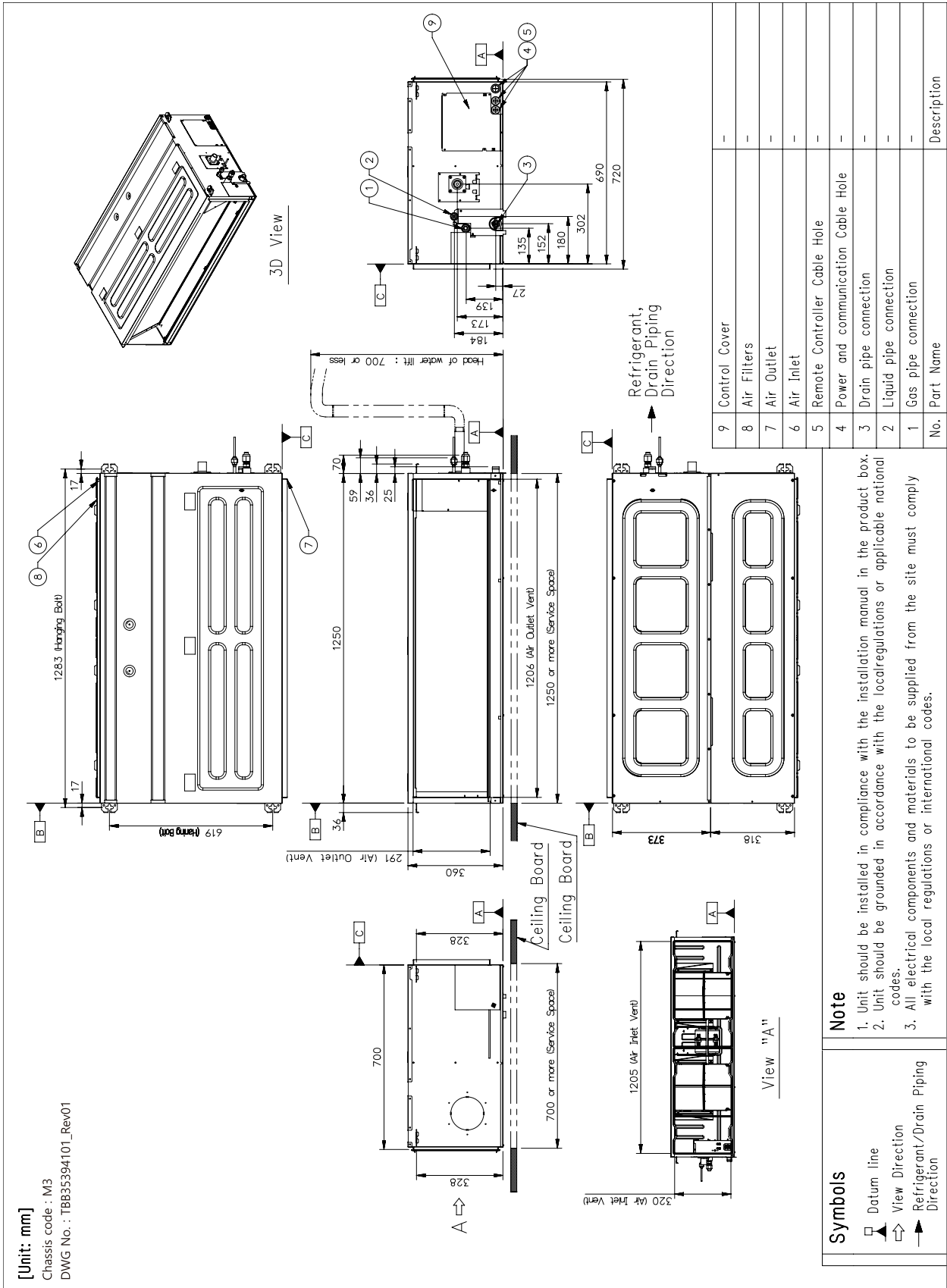

3. Dimensions & Gravity point

3.2 Installation Space

Top view

[Unit: mm(inch)]

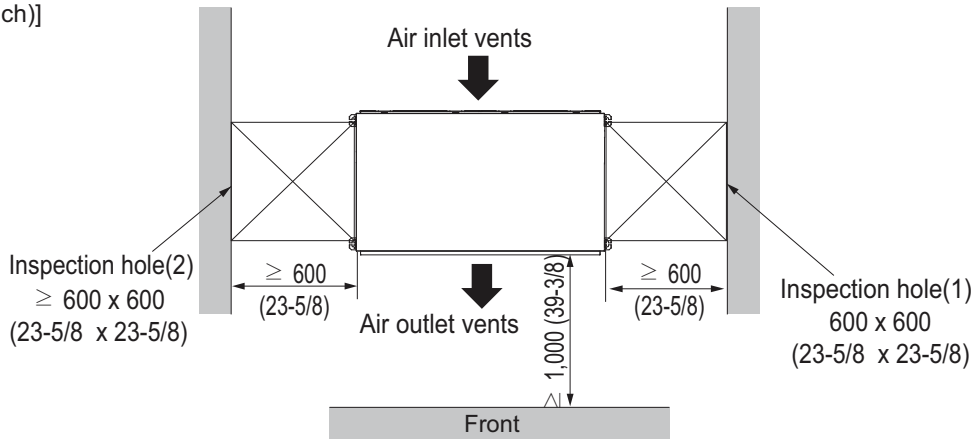

* If distance between false ceiling and actual ceiling is more than 100cm (39-3/8 inch), the number of inspection hole could be decreased to 1. But if that is less than 20cm (7-7/8 inch), the hole size should be more than size of Indoor Unit.

Front view

[Unit: mm(inch)]

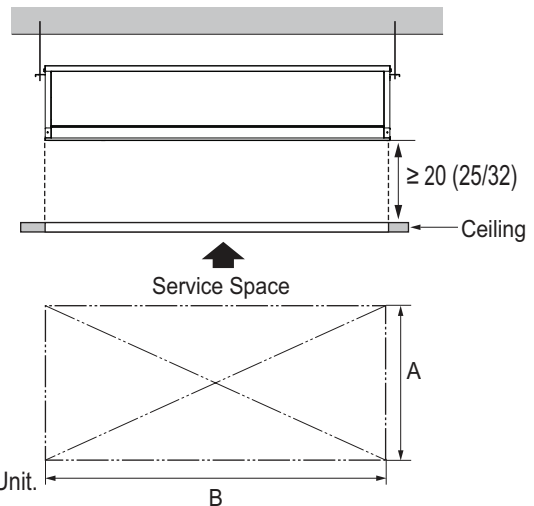
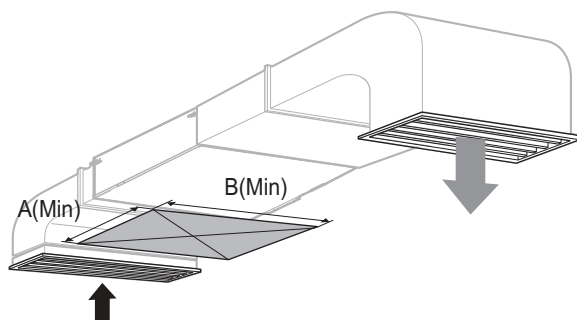

* If distance between false ceiling and actual ceiling is less than 20cm (7-7/8 inch), the hole size should be more than size of Indoor Unit.

* These figures are representative. Actual appearance of indoor unit may be different but clearances will stay the same.

Note

- Places where products are installed should not be any obstacles to the air circulation or installation. Ensure the spaces from the wall, ceiling, or other obstacles.
- According to type of indoor unit, external appearance or installed structure could be different.
- According to product type, model line up, sales region..etc, applicability of each chassis could be different.
- Install certainly the decoration panel. Cool air leakage causes sweating or falling of water-drops.

4. Piping Diagrams

■ M3 Chassis

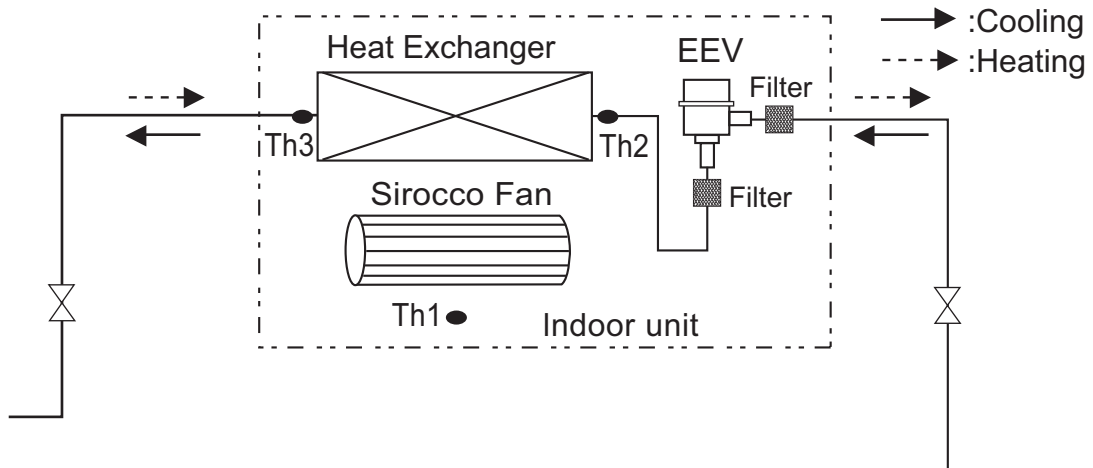

◆ Refrigerant pipe connection port diameter

Model	Gas [mm(inch)]	Liquid [mm(inch)]
ARNU48GM3A4	Ø15.88(5/8)	Ø9.52(3/8)
ARNU54GM3A4	Ø19.05(3/4)	Ø9.52(3/8)

LOC.	Description
Th1	Thermistor for room air temperature
Th2	Thermistor for pipe in temperature
Th3	Thermistor for pipe out temperature

5. Wiring Diagrams

CAUTION

For Multi V Models, DIP switch 1, 2, 6, 8 must be set OFF

6. Capacity Table

■ Cooling Capacity

◆ M3 Chassis

Nominal Capacity (kBtu/h) [Capacity Index (kW)]	Indoor air temp. (DB/WB, °C)													
	20		23		26		27		28		30		32	
	14		16		18		19		20		22		24	
	TC	SHC	TC	SHC	TC	SHC	TC	SHC	TC	SHC	TC	SHC	TC	SHC
48 [14.1]	9.5	8.7	11.3	9.6	13.2	10.4	14.1	10.6	15.0	10.9	15.2	10.3	15.5	9.4
54 [15.8]	10.7	10.1	12.7	11.1	14.7	12.1	15.8	12.3	16.9	12.8	17.1	12.1	17.4	11.1

Note

1. TC: Total Capacity(kW), SHC: Sensible Heat Capacity(kW)
2. Capacity tables show the average value of conditions which may occur.
3. Refer to Capacity tables and correction factor in the outdoor unit PDB for the actual performance data of each indoor unit and outdoor unit combination.

■ Heating Capacity

◆ M3 Chassis

Nominal Capacity (kBtu/h) [Capacity Index (kW)]	Indoor air temp. (DB, °C)											
	16		18		20		21		22		24	
	TC		TC		TC		TC		TC		TC	
48 [14.1]	17.9		16.9		15.9		15.4		14.9		13.9	
54 [15.8]	20.3		19.2		18.0		17.4		16.8		15.7	

Note

1. TC: Total Capacity(kW)
2. Capacity tables show the average value of conditions which may occur.
3. Refer to Capacity tables and correction factor in the outdoor unit PDB for the actual performance data of each indoor unit and outdoor unit combination.

7. External Static Pressure(E.S.P) & Air Flow

◆ ARNU48GM3A4

PQ Curve

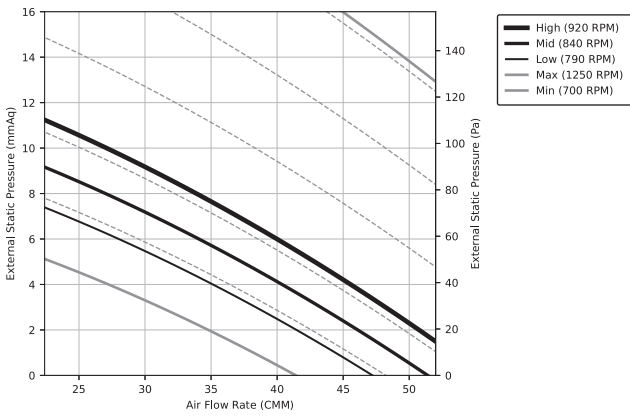

Auto E.S.P Setting Range

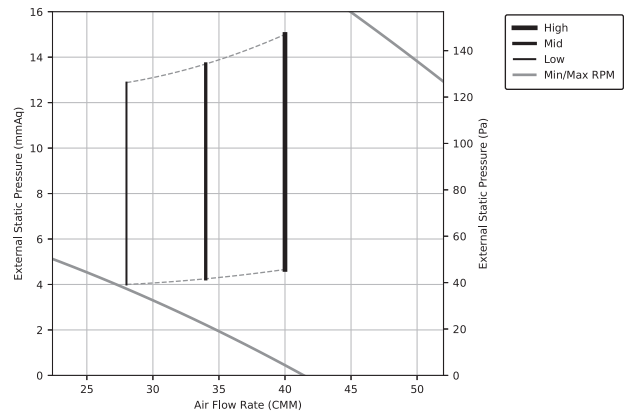

◆ ARNU54GM3A4

PQ Curve

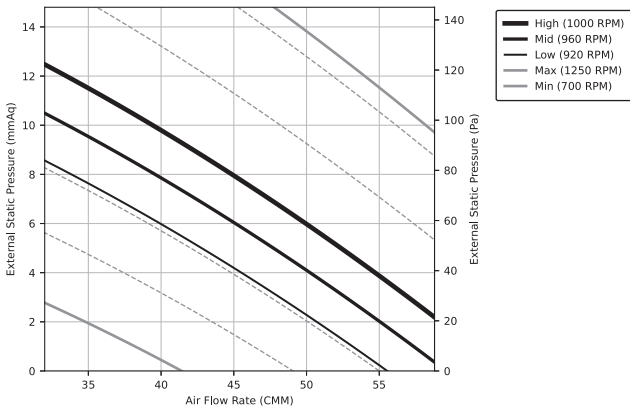

Auto E.S.P Setting Range

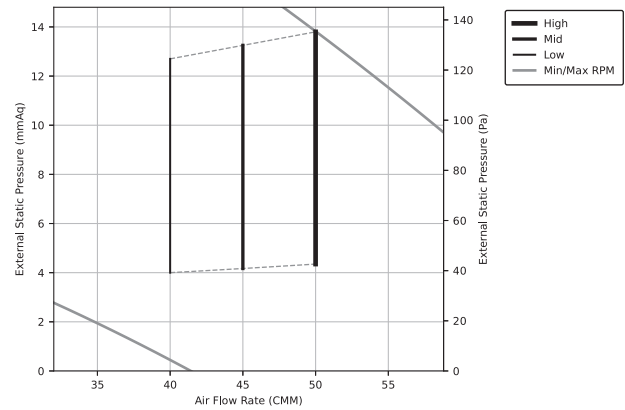

Note

1. Each dash line represents for each 100 RPM step
2. If operation range is out of auto E.S.P setting range, air flow rate should be adjusted manually by wired remotecontroller. (ESP Set Value = RPM / 10)
For more information, please see the installation manual.
3. The above P-Q Curve shows available E.S.P. range. If the E.S.P value is out of min/max RPM at desired air flow, indoor components could be failed and performance would be decreased.
4. Automatic constant air volume is a function that controls air volume automatically when installation, and the air volume is not set automatically during operation.

7. External Static Pressure(E.S.P) & Air Flow

■ Lower and Upper Limit of External Static Pressure

◆ ARNU48GM3A4, ARNU54GM3A4

Capacity	Mode		SV (Setting Value)	Standard ESP (mmAq(Pa))	CMM	Lower Limit of External Static Pressure(mmAq(Pa))	Upper Limit of External Static Pressure(mmAq(Pa))
48k	High (factory set)	Hi	92	6(59)	40.0	4(39)	15(147)
		Mid	84		34.0		
		Low	79		28.0		
	Standard	Hi	89	5(49)	40.0	4(39)	15(147)
		Mid	82		34.0		
		Low	76		28.0		
54k	High (factory set)	Hi	100	6(59)	50.0	4(39)	15(147)
		Mid	96		45.0		
		Low	92		40.0		
	Standard	Hi	97	5(49)	50.0	4(39)	15(147)
		Mid	92		45.0		
		Low	88		40.0		

Note

1. The above table shows the available E.S.P range. If the E.S.P values of the installed indoor system is less or more than mentioned in the table, indoor components could be failed and performance would be decreased.

8. Electric Characteristics

Units					Power Supply	IFM		PI	
Model	Type	Hz	Volts	Voltage Range	MCA	kW	FLA	Cooling	Heating
ARNU48GM3A4	M3	50	220-240	Max:264	3.10	0.400	2.50	530	530
ARNU54GM3A4	M3			Min:198					
ARNU48GM3A4	M3	60	220	Max:242	3.10	0.400	2.50	530	530
ARNU54GM3A4	M3			Min:198					

Symbols

MCA : Minimum Circuit Amperes (A)

kW : Fan Motor Rated Output (kW)

FLA : Full Load Amperes (A)

IFM : Indoor Fan Motor

PI : Maximum Power Input (W)

Note

- Voltage range
Units are suitable for use on electrical systems where voltage supplied to unit terminals is not below or above the listed range limits.
- Maximum allowable voltage unbalance between phases is 2%.
- MCA/MFA
 $MCA = 1.25 \times FLA$
 $MFA = 1.1 \times MCA, MFA \leq 4 \times FLA$
 (If MFA is smaller than minimum standard value, Use minimum standard value in region for selecting circuit breaker.)
- Select wire size based on the MCA
- Instead of fuse, use Circuit Breaker.

9. Sound Levels

9.1 Sound Pressure Levels

Overall

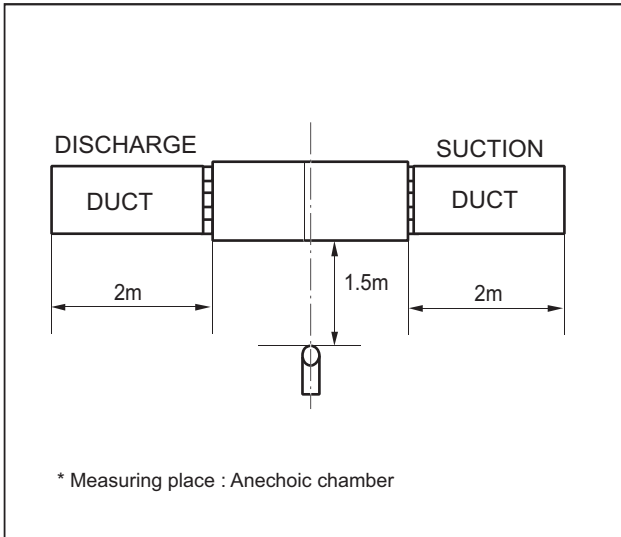

Note

1. Sound measured at some distance away from the center of the unit.
2. Data is valid at free field condition.
3. Reference acoustic pressure 0dB = 20µPa.
4. Data is valid at nominal operation condition. Refer to the Model Specifications for nominal conditions (Power source and Ambient temperature, etc)
5. Sound levels can be increased in accordance with installation and operating conditions. (Static pressure mode, used air guide, Room target temperature setting, etc)
6. Sound level will vary depending on a range of factors such as the construction (acoustic absorption coefficient) of particular room in which the equipment is installed.
7. Sound pressure level is measured on the rated condition in the anechoic rooms by ISO 3745 standard. Therefore, these values can be increased owing to ambient conditions during operation.

Model	Sound Pressure Levels [dB(A),H-M-L]			
	External Static Pressure [Pa]			
	39	49	59	147
ARNU48GM3A4	39-37-36	40-38-36	41-38-37	43-42-41
ARNU54GM3A4	41-40-39	42-41-40	42-41-40	45-44-43

Sound Pressure Level (39Pa)

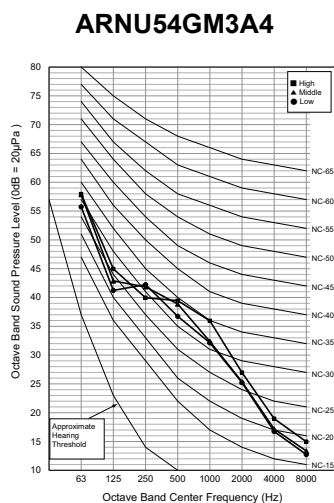
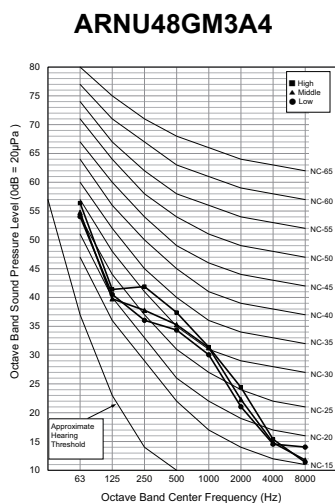

9. Sound Levels

■ Sound Pressure Level (49Pa)

ARNU48GM3A4

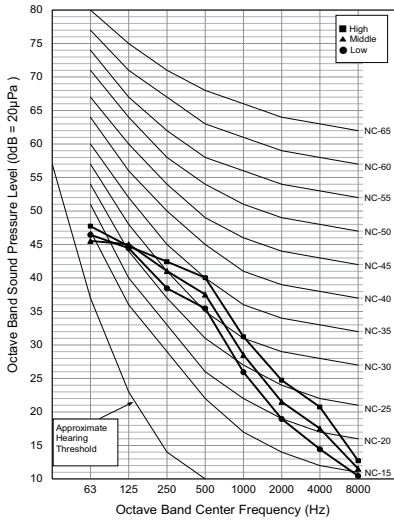

ARNU54GM3A4

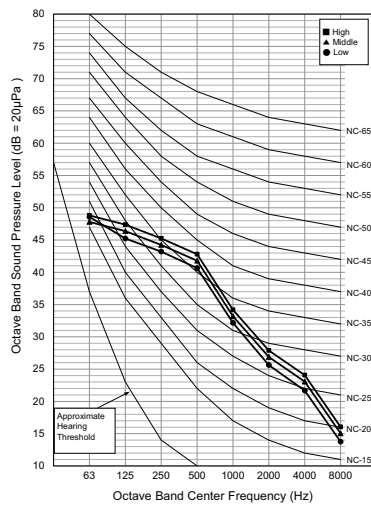

■ Sound Pressure Level (59Pa)

ARNU48GM3A4

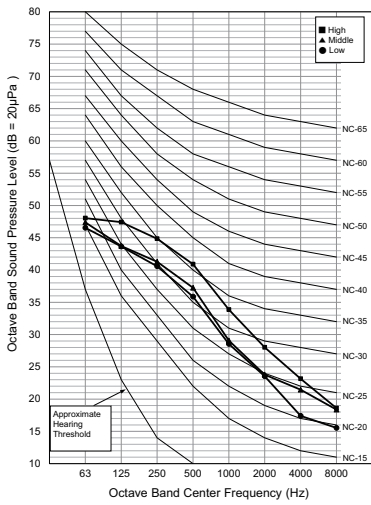

ARNU54GM3A4

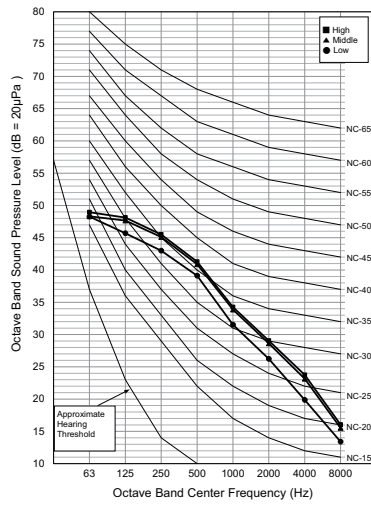

9. Sound Levels

■ Sound Pressure Level (147Pa)

ARNU48GM3A4

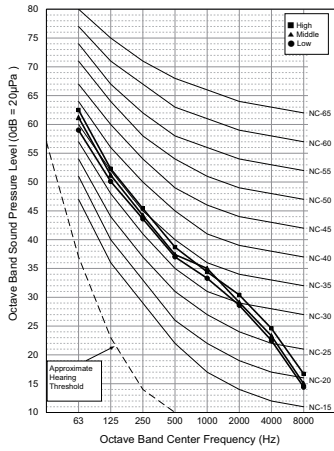

ARNU54GM3A4

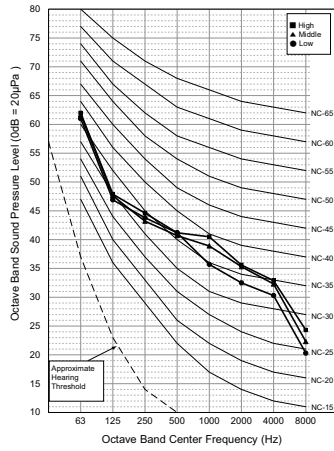

9. Sound Levels

9.2 Sound Power Levels

Note

- Data is valid at diffuse field condition
- Data is valid at nominal operating condition
- Sound level can be increased in static pressure mode or used air guide.
- Sound level will vary depending on a range of factors such as the construction (acoustic absorption coefficient) of particular room in which the equipment is installed.
- Reference acoustic intensity 0dB = 10E-6μW/m²
- Sound power level is measured on the rated condition in the semi-anechoic rooms by ISO 9614 standard. Therefore, these values can be increased owing to ambient conditions during operation.

9.2.1 Sound Power Levels (Inlet)

Model	Sound Power Levels [dB(A), Inlet(H-M-L)]			
	External Static Pressure [Pa]			
	39	49	59	147
ARNU48GM3A4	64 - 61 - 57	64 - 61 - 59	65 - 62 - 59	68 - 67 - 65
ARNU54GM3A4	68 - 66 - 64	68 - 66 - 64	68 - 66 - 65	70 - 69 - 68

■ Sound Power Level (39Pa)

ARNU48GM3A4

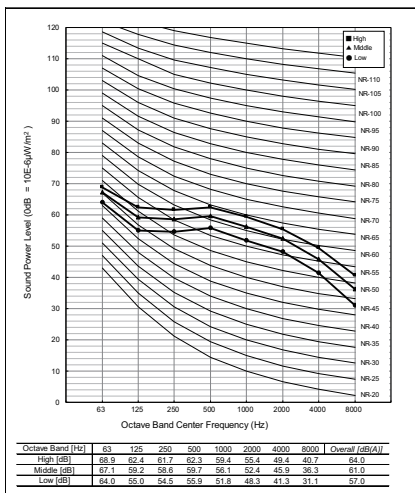

ARNU54GM3A4

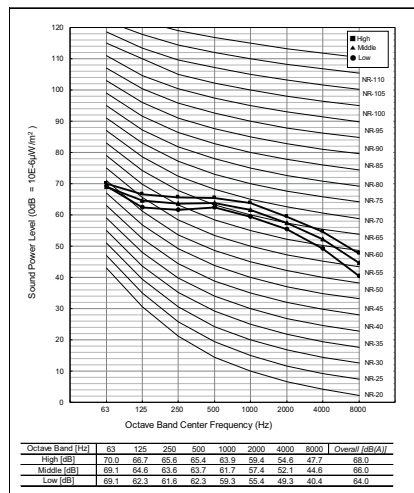

9. Sound Levels

■ Sound Power Level (49Pa)

ARNU48GM3A4

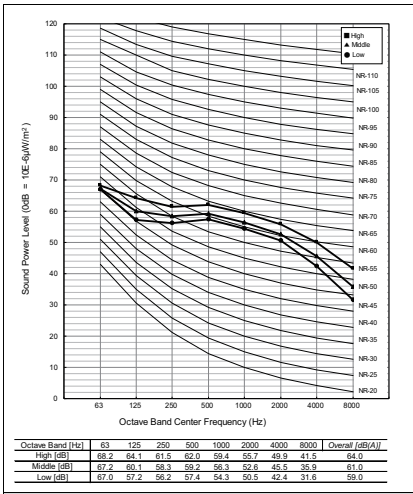

ARNU54GM3A4

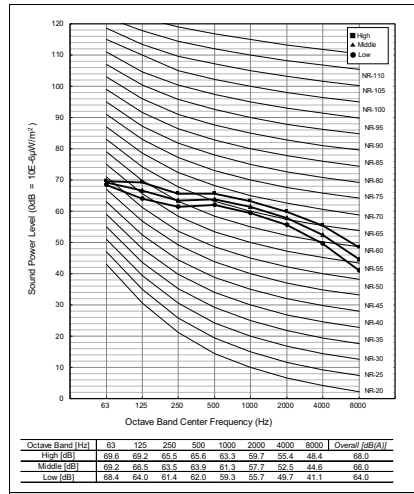

■ Sound Power Level (59Pa)

ARNU48GM3A4

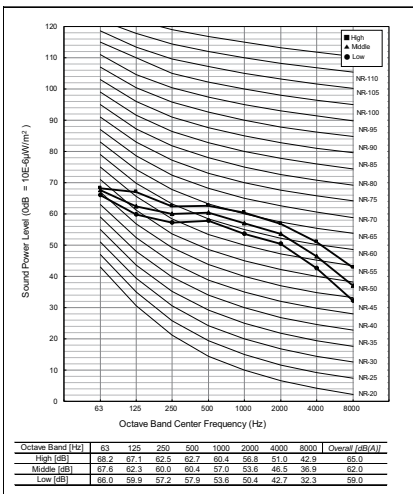

ARNU54GM3A4

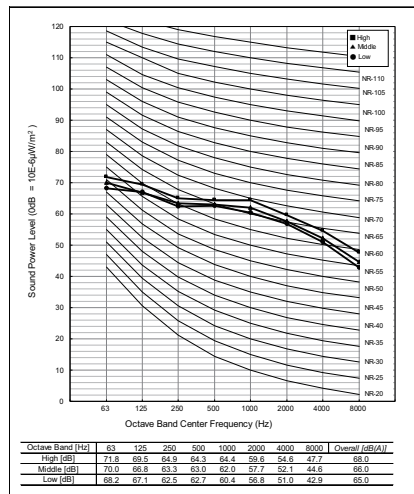

9. Sound Levels

■ Sound Power Level (147Pa)

ARNU48GM3A4

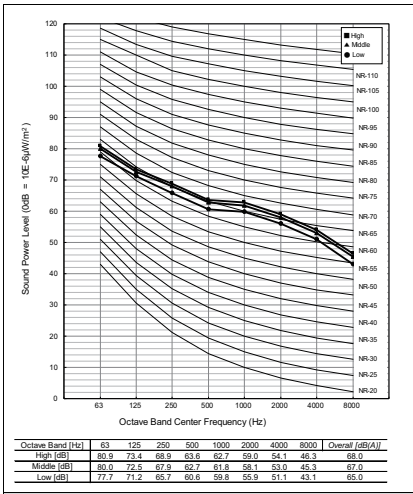

ARNU54GM3A4

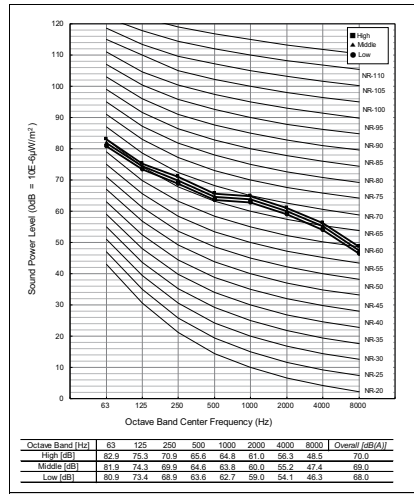

9. Sound Levels

9.2.2 Sound Power Levels (Body)

Model	Sound Power Levels [dB(A), Body(H-M-L)]			
	External Static Pressure [Pa]			
	39	49	59	147
ARNU48GM3A4	53 - 51 - 48	54 - 52 - 50	54 - 52 - 51	56 - 55 - 55
ARNU54GM3A4	56 - 54 - 53	56 - 54 - 53	56 - 55 - 54	57 - 56 - 56

■ Sound Power Level (39Pa)

ARNU48GM3A4

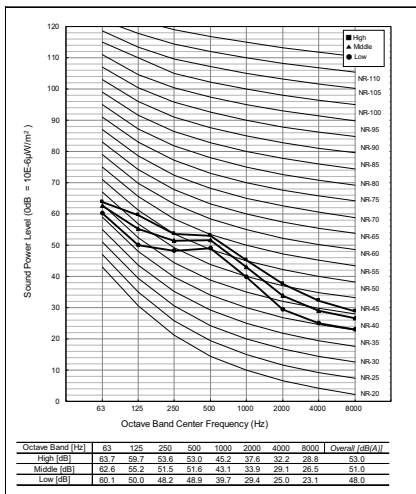

ARNU54GM3A4

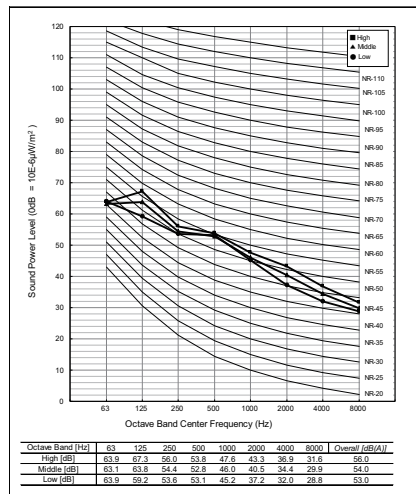

■ Sound Power Level (49Pa)

ARNU48GM3A4

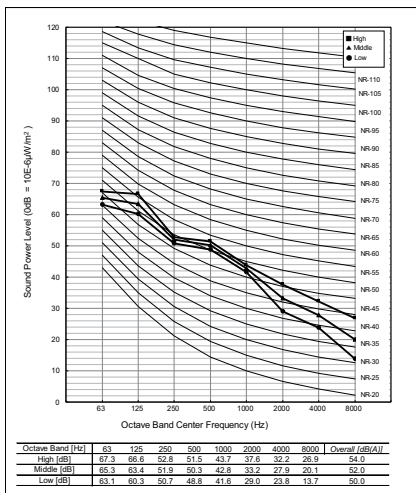

ARNU54GM3A4

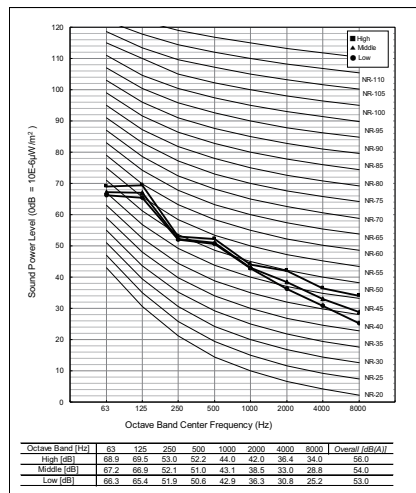

9. Sound Levels

■ Sound Power Level (59Pa)

ARNU48GM3A4

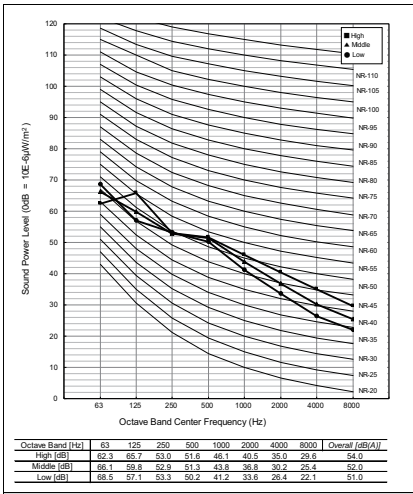

ARNU54GM3A4

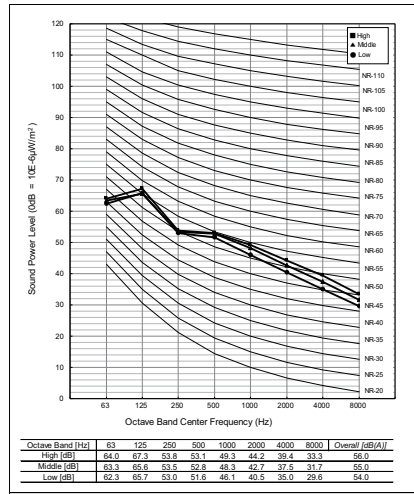

■ Sound Power Level (147Pa)

ARNU48GM3A4

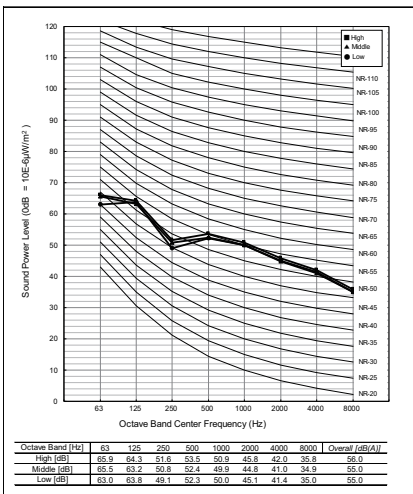

ARNU54GM3A4

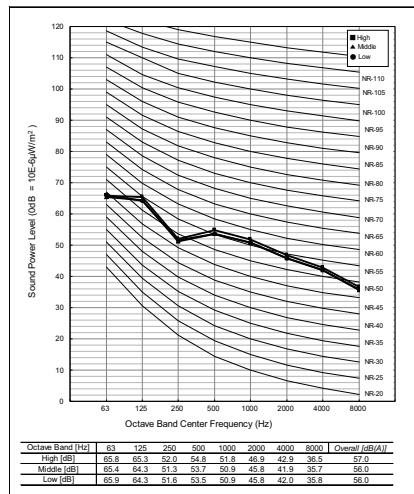

9. Sound Levels

9.2.3 Sound Power Levels (Outlet)

Model	Sound Power Levels [dB(A), Outlet(H-M-L)]			
	External Static Pressure [Pa]			
	39	49	59	147
ARNU48GM3A4	67 - 64 - 61	68 - 65 - 63	68 - 65 - 64	72 - 72 - 71
ARNU54GM3A4	71 - 68 - 67	71 - 69 - 67	71 - 69 - 68	74 - 73 - 72

■ Sound Power Level (39Pa)

ARNU48GM3A4

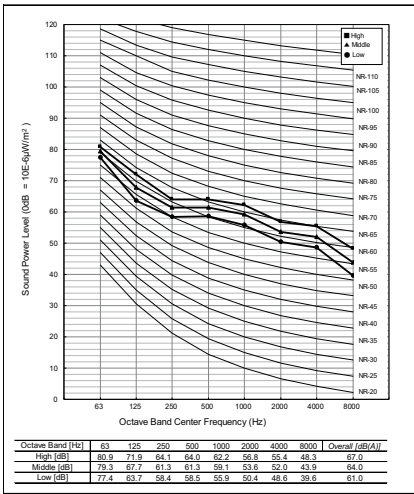

ARNU54GM3A4

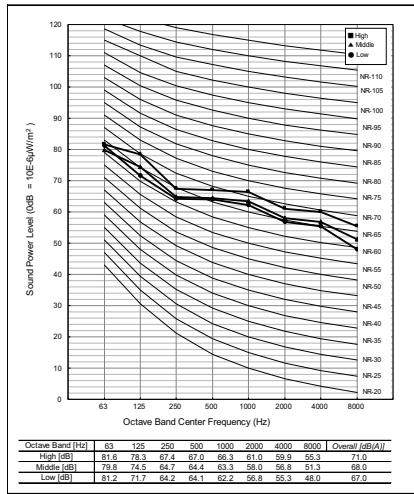

■ Sound Power Level (49Pa)

ARNU48GM3A4

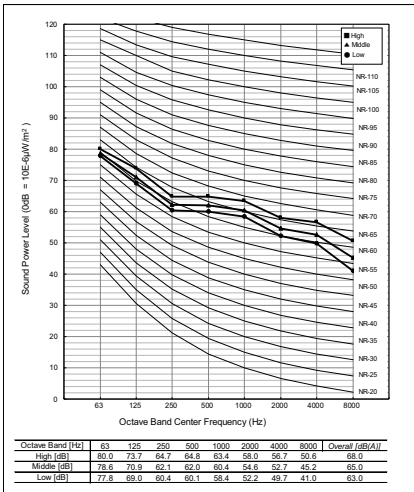

ARNU54GM3A4

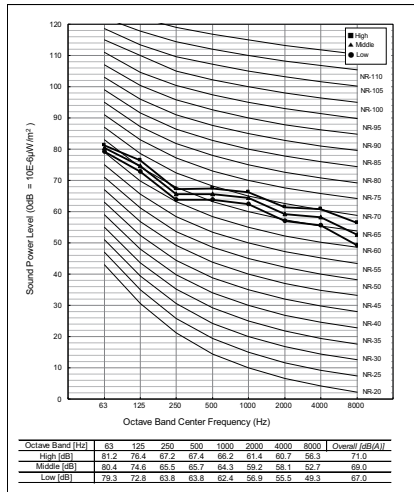

9. Sound Levels

■ Sound Power Level (59Pa)

ARNU48GM3A4

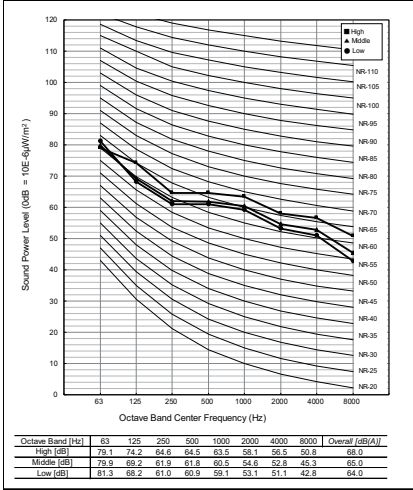

ARNU54GM3A4

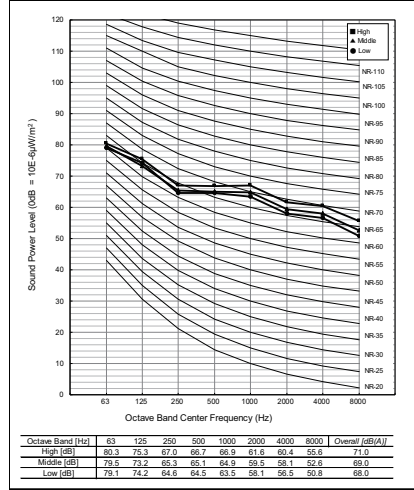

■ Sound Power Level (147Pa)

ARNU48GM3A4

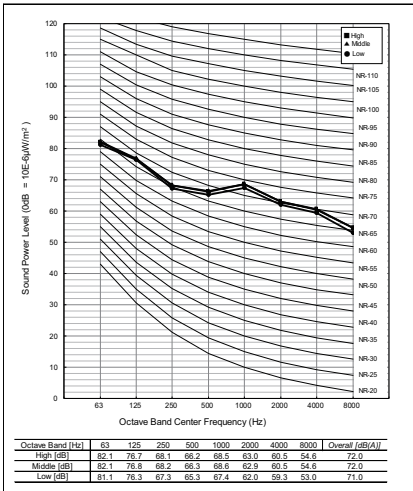

ARNU54GM3A4

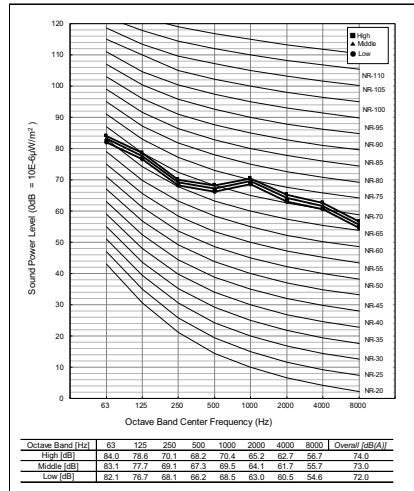

Ceiling Concealed Duct (Low Static)

- 1. List of functions**
- 2. Specifications**
- 3. Dimensions & Gravity points**
- 4. Piping Diagrams**
- 5. Wiring Diagrams**
- 6. Capacity Tables**
- 7. External Static Pressure(E.S.P) & Air Flow**
- 8. Electric Characteristics**
- 9. Sound Levels**

1. List of functions

◆ List of functions

Category	Function	ARNU05GL1G4, ARNU07GL1G4, ARNU09GL1G4, ARNU12GL2G4, ARNU15GL2G4, ARNU18GL2G4, ARNU21GL3G4, ARNU24GL3G4
Air Flow	Air Supply Outlet	1
	Airflow Steps (fan/cool/heat)	3 / 3 / 3
	Fan Speed Auto*	X
	Power Cool/Heat	X / X
	Dry Operation	O
Air Purification	Air Purify	X
	Pre-Filter	O
Reliability	Hot Start	O
	Self Diagnosis	O
Convenience	Auto Mode	O
	Auto Dry Operation	O
	Auto Restart	O
	Child Lock*	O
	Group Control*	O
	Sleep Timer	O
	Turn On/Off Reservation	O
	Schedule*	O
	Two Thermistor Control*	O
	External On/Off	O
Installation	Drain Pump	O
	E.S.P. Control*	O
Special Functions	Wi-Fi	Accessory

Note

- O : Applied, X : Not Applied, - : Unconfirmed or irrelevant
Embedded : A kit is provided by default for using this function when the product is manufactured.
Accessory : Ordered and purchased separately the accessory package referring to the model name provided and install at field. Accessory line-ups varies by region, so check your local catalogue or local sales material.
- Some functions can be limited by remote controller.
- Selecting a wireless remote controller in case of ducted type indoor units requires either a connection to the wired remote controller (Standard II) or an IR receiver accessory to be connected to the duct in order to receive the signal.
- 'Auto Mode' varies depending on the outdoor unit type.
 - Auto Change Over(Heat Recovery Outdoor Unit)
 - Auto Mode Select(Heat Pump Outdoor Unit)
 - Auto Intensity Control(Cooling Only Outdoor Unit)
- * : These functions need to connect the wired remote controller.

1. List of functions

◆ Accessory Compatibility List

Category	Accessory Name	Model Name	Description	ARNU**GL1G4 ARNU**GL2G4 ARNU**GL3G4
Remote Controller	Wired - Premium	PREMTA000	-	○
		PREMTA000A	-	○
		PREMTA000B	-	○
	Wired - RS3 (Standard III)	PREMTB100/PREMTB101	White	○
		PREMTBB10/PREMTBB11	Black	○
	Wired - RS2 (Standard II)	PREMTB001	White	○
		PREMTBB01	Black	○
	Wired - Simple	PQRCVCL0QW	White	○
		PQRCVCL0Q	Black	○
	Wired - Simple for Hotel	PQRCHCA0QW	White	○
		PQRCHCA0Q	Black	○
	Wireless	PQWRQC0FDB	For Cooling only	○
		PQWRHQ0FDB	For Heat pump	○
PWLSSB21C		For Cooling only	○	
PWLSSB21H		For Heat pump	○	
Dry Contact	Simple	PDRYCB000	1 input port, AC 220 - 240V	○
		PDRYCB100	1 input port, AC 24V	○
	Communication	PDRYCB400	2 input port	○
		PDRYCB300	8 input port, For 3rd party Thermostat	○
		PDRYCB320	8 input port, For 3rd Party Thermostat (Analog Input)	○
PDRYCB500	For 3rd Party Controller (Modbus RTU)	○		
Integration Device	Remote Temperature sensor	PQRSTA0	-	○
	Zone Controller	ABZCA	For Duct, 4zone, 220-240V	X
	Group Control wire	PZCWRCG3	Cable Assembly For group control (Y-type cable : 0.25m, cable : 9.6m)	○
ETC	Extension wire	PZCWRC1	Extension wire For IDU-wired remote controller (9.6m)	X
	2-Remo Control Wire	PZCWRC2	-	X
	Wi-Fi Modem	PWFMDD200	-	○
	Wi-Fi Extension cable	PWYREW000	USB Extension cable : 10 m	○
	IR Receiver	PWLRVN000	For wireless remote controller with Duct	○
	Independent Power Module	PRIP0	-	○
	Multi-tenant Power module	PINPMB001	-	○
	Refrigerant Leakage Detector	PRLDNVS0	For R410A only	○
	UVnano Filter Box	PBM13M1UA0	For M1 Chassis	X
		PBM13M2UA0	For M2 Chassis	X
		PBM13M3UA0	For M3 Chassis	X
	High Efficiency Filter (Main Filter of Filter Box)	FBM13M1UA0	For M1 UVnano Filter Box	X
		FBM13M2UA0	For M2 UVnano Filter Box	X
		FBM13M3UA0	For M3 UVnano Filter Box	X
	EEV Kit	PRGK024A0	For Multi V Indoor Unit	○(L1)
Auxiliary Heater Relay Kit	PRARH1	For Cassette and Duct Indoor Units	○	

Note

1. ○: Possible, X: Impossible, -: Not applicable, Embedded : Included with product.
2. If there is a difference in development time between the product and the remote controller, some functions cannot be operated.
3. If using Wi-Fi controller, Some advanced functions controlled by remote controller cannot be operated.
4. Selecting a wireless remote controller in case of ducted type indoor units requires either a connection to the wired remote controller (Standard II) or an IR receiver accessory to be connected to the duct in order to receive the signal.
5. If you need more detail, please refer to the **BECON** PDB or the manual of product. (<http://partner.lge.com/global> : Home> Doc.Library> Product > Control(BECON))

2. Specifications

Type			Ceiling Concealed Duct (Low Static)		
Model		Unit	ARNU05GL1G4	ARNU07GL1G4	
Cooling Capacity		kW	1.7	2.2	
		kcal/h	1,500	1,900	
		Btu/h	5,800	7,500	
Heating Capacity		kW	1.9	2.5	
		kcal/h	1,600	2,200	
		Btu/h	6,500	8,500	
Power Input (H / M / L)		W	29 / 26 / 24	31 / 28 / 24	
Casing			Galvanized Steel Plate	Galvanized Steel Plate	
Dimensions(WxHxD)	Body	mm	700 x 190 x 700	700 x 190 x 700	
		inch	27-9/16 x 7-15/32 x 27-9/16	27-9/16 x 7-15/32 x 27-9/16	
Coil	Rows x Columns x FPI		2 x 11 x 14	2 x 11 x 14	
	Face Area	m ²	0.12	0.12	
Fan	Type		Sirocco Fan	Sirocco Fan	
	Motor Output x Number		W	19 x 1	
	Air Flow Rate (H / M / L) (Factory set)	m ³ /min		6.7 / 6.2 / 5.5	7.5 / 6.5 / 5.5
		ft ³ /min		240 / 220 / 200	270 / 230 / 200
	External Static Pressure		mmAq(Pa)	2.54 (25)	2.54 (25)
	External Static Pressure (Min ~ Max)		mmAq (Pa)	0(0) ~ 5(49)	0(0) ~ 5(49)
	Drive			Direct	Direct
Motor type			BLDC	BLDC	
Temperature Control			Microprocessor, Thermostat for cooling and heating		
Sound Absorbing Thermal Insulation Material			Foamed polystyrene	Foamed polystyrene	
Air Filter			-	-	
Safety Device			Fuse	Fuse	
Pipe Connections	Liquid Side	mm(inch)	Ø6.35(1/4)	Ø6.35(1/4)	
	Gas Side	mm(inch)	Ø12.7(1/2)	Ø12.7(1/2)	
	Drain Pipe(Internal Dia.)	mm(inch)	25.4(1)	25.4(1)	
Net Weight		kg(lbs)	16.3 (35.9)	16.3 (35.9)	
Sound Pressure Levels (H / M / L)		dB(A)	25 / 24 / 22	26 / 24 / 22	
Sound Power Levels (H / M / L)		dB(A)	48 / 46 / 45	50 / 47 / 45	
Power Supply		Ø, V, Hz	1, 220 - 230 - 240, 50/60	1, 220 - 230 - 240, 50/60	
Running Current by voltage	Rated	A	0.24 - 0.23 - 0.22	0.26 - 0.25 - 0.23	
Maximum Running Current		A	0.40	0.40	
Refrigerant	Type		R410A / R32	R410A / R32	
	Additional Charging Amount (CF Value of IDU)		kg(each)	0.14 / 0.12	
	Control		-	EEV	
Transmission cable		mm ²	1.0~1.5 x 2C	1.0~1.5 x 2C	

Note

- Due to our policy of innovation some specifications may be changed without notification.
- Wiring cable size must comply with the applicable local and national code. And "Electric characteristics" chapter should be considered for electrical work and design. Especially the power cable and circuit breaker should be selected in accordance with that.
- Sound pressure level is measured on the rated condition in the anechoic rooms by ISO 3745 standard.
Sound power level is measured on the rated condition in the semi-anechoic rooms by ISO 9614 standard.
Therefore, these values can be increased owing to ambient conditions during operation.
- Capacities are net capacities and based on the following conditions. Refer to the Outdoor Unit Specifications for calculating the real capacity.
 - Cooling : Indoor Ambient Temp. 27°CDB / 19°CWB, Outdoor Ambient Temp. 35°CDB / 24°CWB
 - Heating : Indoor Ambient Temp. 20°CDB / 15°CWB, Outdoor Ambient Temp. 7°CDB / 6°CWB
 - Interconnected Pipe is standard length and difference of Elevation (Outdoor ~ Indoor Unit) is 0m.
- Refrigerant information (type, additional charging amount, etc.) must be applied by refrigerant type of the combined outdoor unit.
Adapt after checking the specifications of outdoor unit.
- Sound levels are measured at 20Pa External Static Pressure condition.

2. Specifications

Type			Ceiling Concealed Duct (Low Static)	
Model		Unit	ARNU09GL1G4	ARNU12GL2G4
Cooling Capacity		kW	2.8	3.6
		kcal/h	2,400	3,100
		Btu/h	9,600	12,300
Heating Capacity		kW	3.2	4.0
		kcal/h	2,800	3,400
		Btu/h	10,900	13,600
Power Input (H / M / L)		W	39 / 29 / 24	41 / 34 / 29
Casing			Galvanized Steel Plate	Galvanized Steel Plate
Dimensions(WxHxD)	Body	mm	700 x 190 x 700	900 x 190 x 700
		inch	27-9/16 × 7-15/32 × 27-9/16	35-7/16 × 7-15/32 × 27-9/16
Coil	Rows x Columns x FPI		2 x 11 x 14	2 x 11 x 18
	Face Area	m ²	0.12	0.17
Fan	Type		Sirocco Fan	Sirocco Fan
	Motor Output x Number	W	19 x 1	19 x 1, 5 x 1
	Air Flow Rate (H / M / L) (Factory set)	m ³ /min	9.0 / 7.0 / 5.5	10.0 / 8.5 / 7.0
		ft ³ /min	320 / 250 / 200	360 / 310 / 250
	External Static Pressure	mmAq(Pa)	2.54 (25)	2.54 (25)
	External Static Pressure (Min ~ Max)	mmAq (Pa)	0(0) ~ 5(49)	0(0) ~ 5(49)
	Drive		Direct	Direct
Motor type		BLDC	BLDC	
Temperature Control			Microprocessor, Thermostat for cooling and heating	
Sound Absorbing Thermal Insulation Material			Foamed polystyrene	Foamed polystyrene
Air Filter			-	-
Safety Device			Fuse	Fuse
Pipe Connections	Liquid Side	mm(inch)	Ø6.35(1/4)	Ø6.35(1/4)
	Gas Side	mm(inch)	Ø12.7(1/2)	Ø12.7(1/2)
	Drain Pipe(Internal Dia.)	mm(inch)	25.4(1)	25.4(1)
Net Weight		kg(lbs)	16.3 (35.9)	20.9 (46.1)
Sound Pressure Levels (H / M / L)		dB(A)	28 / 25 / 22	30 / 27 / 25
Sound Power Levels (H / M / L)		dB(A)	53 / 49 / 45	50 / 47 / 46
Power Supply		Ø, V, Hz	1, 220 - 230 - 240, 50/60	1, 220 - 230 - 240, 50/60
Running Current by voltage	Rated	A	0.32 - 0.31 - 0.30	0.38 - 0.37 - 0.35
Maximum Running Current		A	0.40	0.76
Refrigerant	Type		R410A / R32	R410A / R32
	Additional Charging Amount (CF Value of IDU)	kg(each)	0.14 / 0.12	0.19 / 0.16
	Control		-	EEV
Transmission cable		mm ²	1.0~1.5 x 2C	1.0~1.5 x 2C

Note

- Due to our policy of innovation some specifications may be changed without notification.
- Wiring cable size must comply with the applicable local and national code. And "Electric characteristics" chapter should be considered for electrical work and design. Especially the power cable and circuit breaker should be selected in accordance with that.
- Sound pressure level is measured on the rated condition in the anechoic rooms by ISO 3745 standard.
Sound power level is measured on the rated condition in the semi-anechoic rooms by ISO 9614 standard.
Therefore, these values can be increased owing to ambient conditions during operation.
- Capacities are net capacities and based on the following conditions. Refer to the Outdoor Unit Specifications for calculating the real capacity.
 - Cooling : Indoor Ambient Temp. 27°CDB / 19°CWB, Outdoor Ambient Temp. 35°CDB / 24°CWB
 - Heating : Indoor Ambient Temp. 20°CDB / 15°CWB, Outdoor Ambient Temp. 7°CDB / 6°CWB
 - Interconnected Pipe is standard length and difference of Elevation (Outdoor ~ Indoor Unit) is 0m.
- Refrigerant information (type, additional charging amount, etc.) must be applied by refrigerant type of the combined outdoor unit.
Adapt after checking the specifications of outdoor unit.
- Sound levels are measured at 20Pa External Static Pressure condition.

2. Specifications

Type		Ceiling Concealed Duct (Low Static)			
Model	Unit	ARNU15GL2G4	ARNU18GL2G4		
Cooling Capacity	kW	4.5	5.6		
	kcal/h	3,900	4,800		
	Btu/h	15,400	19,100		
Heating Capacity	kW	5.0	6.3		
	kcal/h	4,300	5,400		
	Btu/h	17,100	21,500		
Power Input (H / M / L)		W	56 / 41 / 34	71 / 56 / 41	
Casing		Galvanized Steel Plate			
Dimensions(WxHxD)	Body	mm	900 x 190 x 700	900 x 190 x 700	
		inch	35-7/16 x 7-15/32 x 27-9/16	35-7/16 x 7-15/32 x 27-9/16	
Coil	Rows x Columns x FPI		2 x 11 x 18	2 x 11 x 18	
	Face Area	m ²	0.17	0.17	
Fan	Type		Sirocco Fan	Sirocco Fan	
	Motor Output x Number		W	19 x 1, 5 x 1	19 x 1, 5 x 1
	Air Flow Rate (H / M / L) (Factory set)	m ³ /min	12.5 / 10.0 / 8.5	15.0 / 12.5 / 10.0	
		ft ³ /min	450 / 360 / 310	530 / 450 / 360	
	External Static Pressure		mmAq(Pa)	2.54 (25)	2.54 (25)
	External Static Pressure (Min ~ Max)		mmAq (Pa)	0(0) ~ 5(49)	0(0) ~ 5(49)
	Drive		Direct		
Motor type		BLDC			
Temperature Control		Microprocessor, Thermostat for cooling and heating			
Sound Absorbing Thermal Insulation Material		Foamed polystyrene			
Air Filter		-			
Safety Device		Fuse			
Pipe Connections	Liquid Side	mm(inch)	Ø6.35(1/4)	Ø6.35(1/4)	
	Gas Side	mm(inch)	Ø12.7(1/2)	Ø12.7(1/2)	
	Drain Pipe(Internal Dia.)	mm(inch)	25.4(1)	25.4(1)	
Net Weight		kg(lbs)	20.9 (46.1)	20.9 (46.1)	
Sound Pressure Levels (H / M / L)		dB(A)	33 / 30 / 28	35 / 32 / 29	
Sound Power Levels (H / M / L)		dB(A)	54 / 51 / 47	56 / 54 / 51	
Power Supply		Ø, V, Hz	1, 220 - 230 - 240, 50/60	1, 220 - 230 - 240, 50/60	
Running Current by voltage	Rated	A	0.52 - 0.50 - 0.48	0.66 - 0.63 - 0.61	
Maximum Running Current		A	0.76	0.76	
Refrigerant	Type		-	R410A / R32	
	Additional Charging Amount (CF Value of IDU)		kg(each)	0.19 / 0.16	0.19 / 0.16
	Control		-	EEV	EEV
Transmission cable		mm ²	1.0~1.5 x 2C	1.0~1.5 x 2C	

Note

- Due to our policy of innovation some specifications may be changed without notification.
- Wiring cable size must comply with the applicable local and national code. And "Electric characteristics" chapter should be considered for electrical work and design. Especially the power cable and circuit breaker should be selected in accordance with that.
- Sound pressure level is measured on the rated condition in the anechoic rooms by ISO 3745 standard.
Sound power level is measured on the rated condition in the semi-anechoic rooms by ISO 9614 standard.
Therefore, these values can be increased owing to ambient conditions during operation.
- Capacities are net capacities and based on the following conditions. Refer to the Outdoor Unit Specifications for calculating the real capacity.
 - Cooling : Indoor Ambient Temp. 27°CDB / 19°CWB, Outdoor Ambient Temp. 35°CDB / 24°CWB
 - Heating : Indoor Ambient Temp. 20°CDB / 15°CWB, Outdoor Ambient Temp. 7°CDB / 6°CWB
 - Interconnected Pipe is standard length and difference of Elevation (Outdoor ~ Indoor Unit) is 0m.
- Refrigerant information (type, additional charging amount, etc.) must be applied by refrigerant type of the combined outdoor unit.
Adapt after checking the specifications of outdoor unit.
- Sound levels are measured at 20Pa External Static Pressure condition.

2. Specifications

Type			Ceiling Concealed Duct (Low Static)	
Model		Unit	ARNU21GL3G4	ARNU24GL3G4
Cooling Capacity		kW	6.2	7.1
		kcal/h	5,300	6,100
		Btu/h	21,000	24,200
Heating Capacity		kW	7.0	8.0
		kcal/h	6,000	6,900
		Btu/h	23,900	27,300
Power Input (H / M / L)		W	72 / 53 / 48	103 / 63 / 48
Casing			Galvanized Steel Plate	Galvanized Steel Plate
Dimensions(WxHxD)	Body	mm	1,100 × 190 × 700	1,100 × 190 × 700
		inch	43-5/16 × 7-15/32 × 27-9/16	43-5/16 × 7-15/32 × 27-9/16
Coil	Rows x Columns x FPI		2 x 11 x 18	2 x 11 x 18
	Face Area	m ²	0.21	0.21
Fan	Type		Sirocco Fan	Sirocco Fan
	Motor Output x Number		W	19 x 2
	Air Flow Rate (H / M / L) (Factory set)	m ³ /min	17.5 / 14.0 / 12.0	20.0 / 16.0 / 12.0
		ft ³ /min	620 / 500 / 430	710 / 570 / 430
	External Static Pressure		mmAq(Pa)	2.54 (25)
	External Static Pressure (Min ~ Max)		mmAq (Pa)	0(0) ~ 5(49)
	Drive			Direct
Motor type			BLDC	
Temperature Control			Microprocessor, Thermostat for cooling and heating	
Sound Absorbing Thermal Insulation Material			Foamed polystyrene	Foamed polystyrene
Air Filter			-	-
Safety Device			Fuse	Fuse
Pipe Connections	Liquid Side	mm(inch)	Ø9.52(3/8)	Ø9.52(3/8)
	Gas Side	mm(inch)	Ø15.88(5/8)	Ø15.88(5/8)
	Drain Pipe(Internal Dia.)	mm(inch)	25.4(1)	25.4(1)
Net Weight		kg(lbs)	24.2 (53.4)	24.2 (53.4)
Sound Pressure Levels (H / M / L)		dB(A)	35 / 29 / 28	36 / 33 / 28
Sound Power Levels (H / M / L)		dB(A)	59 / 55 / 54	63 / 59 / 55
Power Supply		Ø, V, Hz	1, 220 - 230 - 240, 50/60	1, 220 - 230 - 240, 50/60
Running Current by voltage	Rated	A	0.63 - 0.61 - 0.58	0.91 - 0.87 - 0.83
Maximum Running Current		A	0.97	0.97
Refrigerant	Type		-	R410A / R32
	Additional Charging Amount (CF Value of IDU)		kg(each)	0.25 / 0.21
	Control		-	EEV
Transmission cable		mm ²	1.0~1.5 x 2C	1.0~1.5 x 2C

Note

- Due to our policy of innovation some specifications may be changed without notification.
- Wiring cable size must comply with the applicable local and national code. And "Electric characteristics" chapter should be considered for electrical work and design. Especially the power cable and circuit breaker should be selected in accordance with that.
- Sound pressure level is measured on the rated condition in the anechoic rooms by ISO 3745 standard.
Sound power level is measured on the rated condition in the semi-anechoic rooms by ISO 9614 standard.
Therefore, these values can be increased owing to ambient conditions during operation.
- Capacities are net capacities and based on the following conditions. Refer to the Outdoor Unit Specifications for calculating the real capacity.
 - Cooling : Indoor Ambient Temp. 27°CDB / 19°CWB, Outdoor Ambient Temp. 35°CDB / 24°CWB
 - Heating : Indoor Ambient Temp. 20°CDB / 15°CWB, Outdoor Ambient Temp. 7°CDB / 6°CWB
 - Interconnected Pipe is standard length and difference of Elevation (Outdoor ~ Indoor Unit) is 0m.
- Refrigerant information (type, additional charging amount, etc.) must be applied by refrigerant type of the combined outdoor unit.
Adapt after checking the specifications of outdoor unit.
- Sound levels are measured at 20Pa External Static Pressure condition.

3. Dimensions & Gravity point

3.1 Dimensional Drawings

ARNU05GL1G4 / ARNU07GL1G4 / ARNU09GL1G4 / ARNU12GL2G4

ARNU15GL2G4 / ARNU18GL2G4 / ARNU21GL3G4/ ARNU24GL3G4

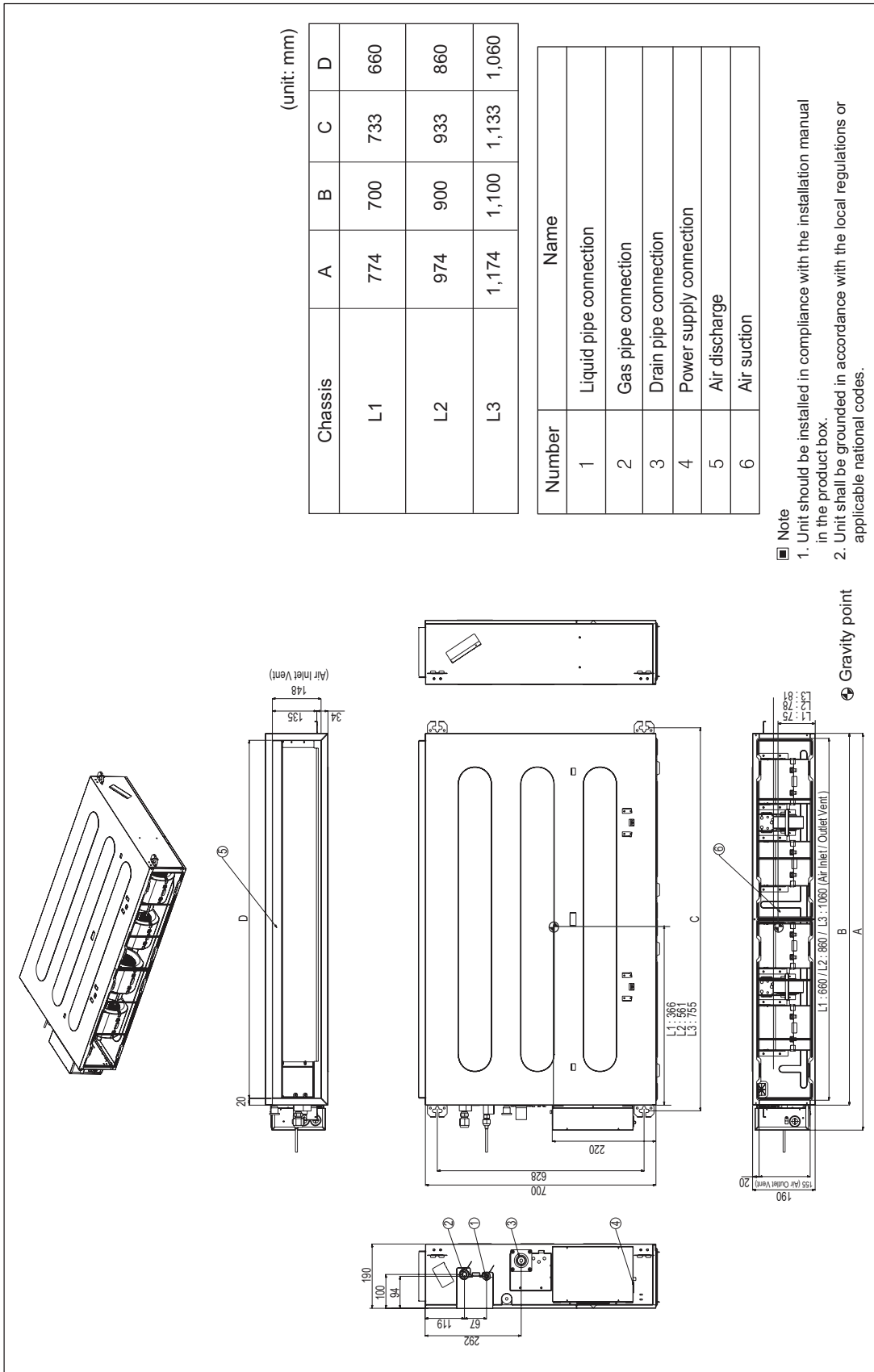

3. Dimensions & Gravity point

3.2 Installation Space

Top view

[Unit: mm(inch)]

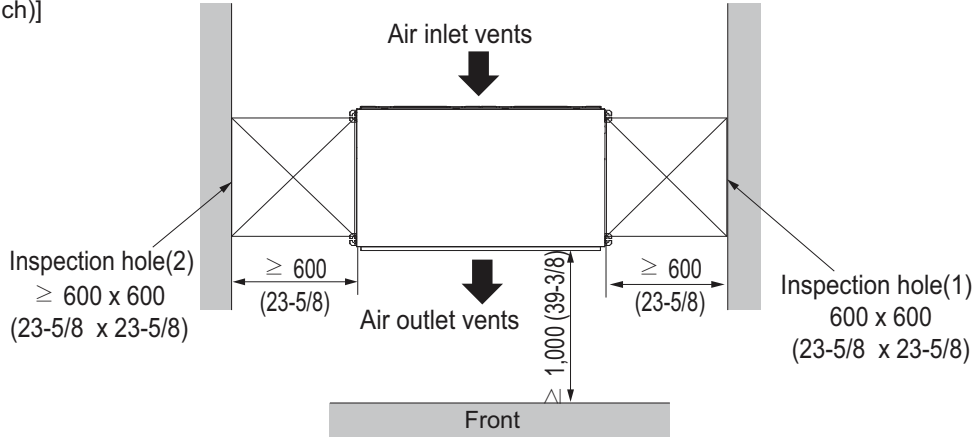

* If distance between false ceiling and actual ceiling is more than 100cm (39-3/8 inch), the number of inspection hole could be decreased to 1. But if that is less than 20cm (7-7/8 inch), the hole size should be more than size of Indoor Unit.

Front view

[Unit: mm(inch)]

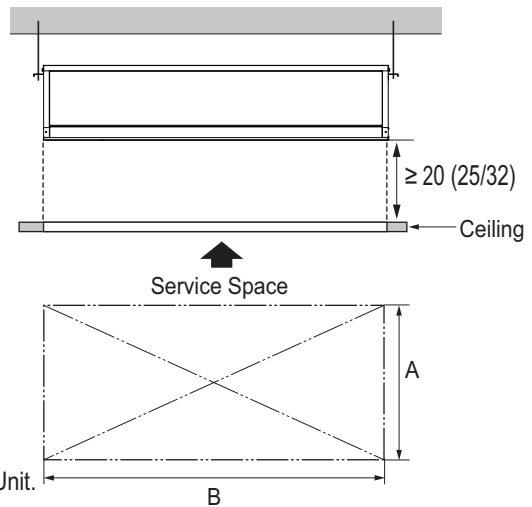
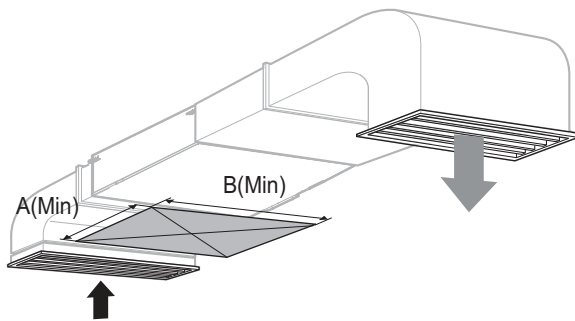

* If distance between false ceiling and actual ceiling is less than 20cm (7-7/8 inch), the hole size should be more than size of Indoor Unit.

* These figures are representative. Actual appearance of indoor unit may be different but clearances will stay the same.

Note

- Places where products are installed should not be any obstacles to the air circulation or installation. Ensure the spaces from the wall, ceiling, or other obstacles.
- According to type of indoor unit, external appearance or installed structure could be different.
- According to product type, model line up, sales region..etc, applicability of each chassis could be different.

4. Piping Diagrams

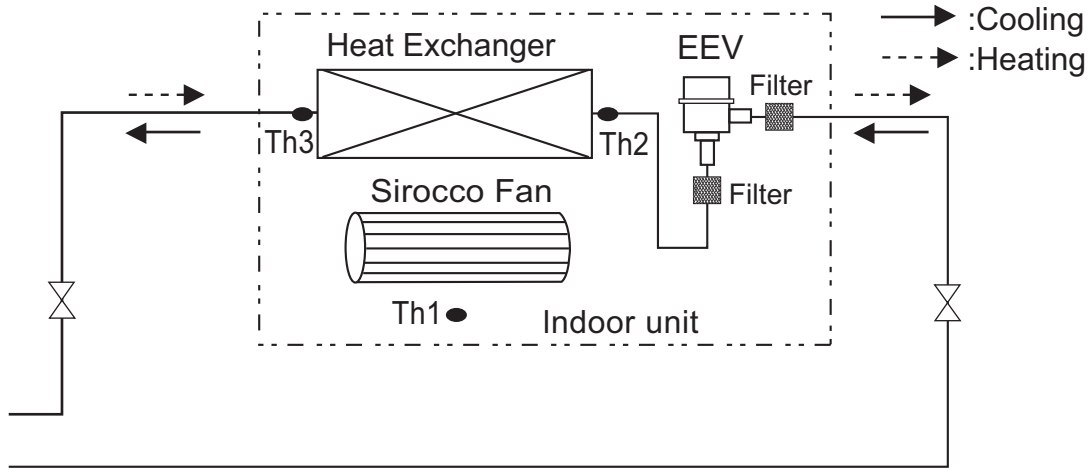

◆ Refrigerant pipe connection port diameter

Model	Gas [mm(inch)]	Liquid [mm(inch)]
ARNU05GL1G4	Ø12.7(1/2)	Ø6.35(1/4)
ARNU07GL1G4	Ø12.7(1/2)	Ø6.35(1/4)
ARNU09GL1G4	Ø12.7(1/2)	Ø6.35(1/4)
ARNU12GL2G4	Ø12.7(1/2)	Ø6.35(1/4)
ARNU15GL2G4	Ø12.7(1/2)	Ø6.35(1/4)
ARNU18GL2G4	Ø12.7(1/2)	Ø6.35(1/4)
ARNU21GL3G4	Ø15.88(5/8)	Ø9.52(3/8)
ARNU24GL3G4	Ø15.88(5/8)	Ø9.52(3/8)

LOC.	Description
Th1	Thermistor for room air temperature
Th2	Thermistor for pipe in temperature
Th3	Thermistor for pipe out temperature

5. Wiring Diagrams

L1 Chassis

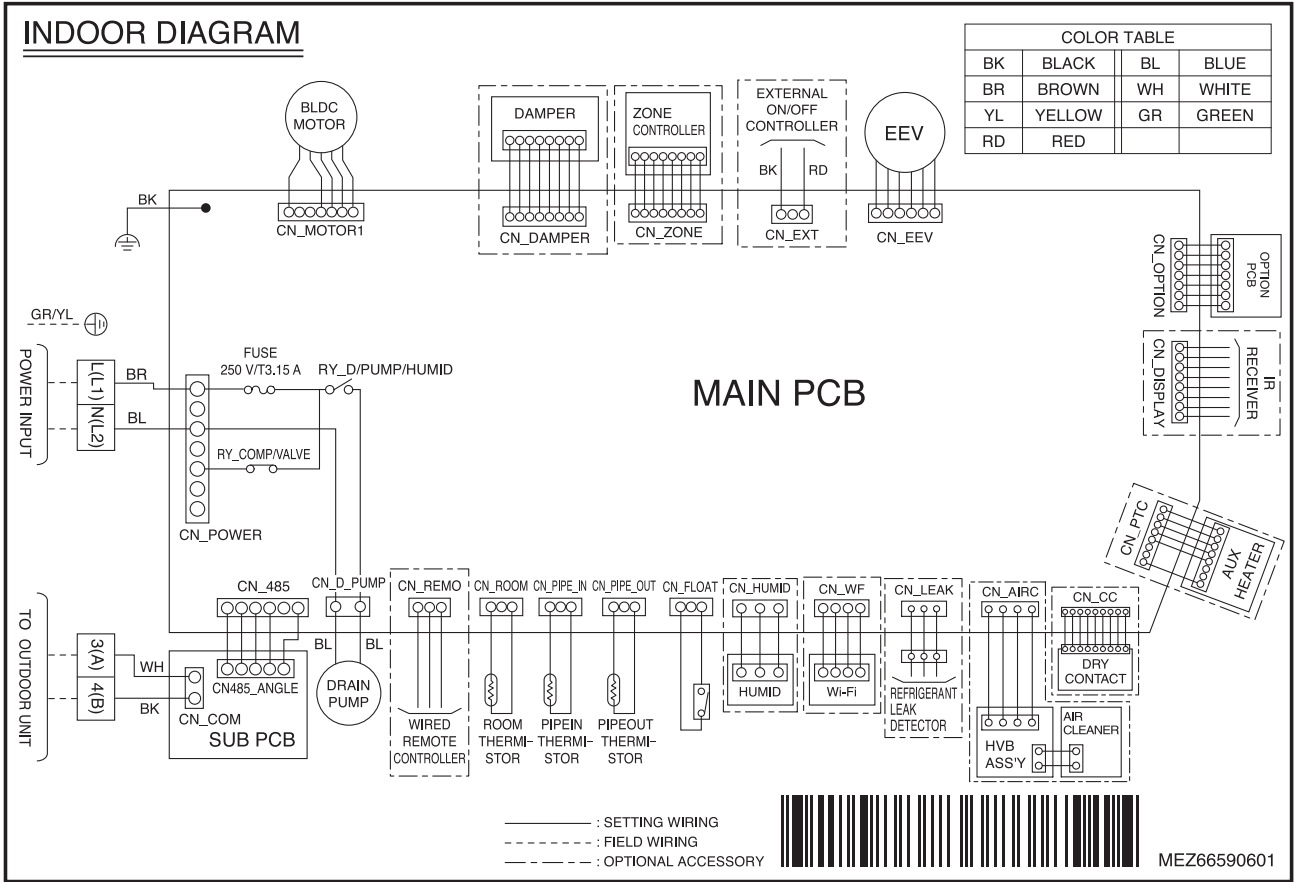

CONNECTOR NUMBER	SPEC.	DESCRIPTION
CN-MOTOR1	Fan motor output	Motor output of BLDC
CN-MOTOR2	Fan motor output	Motor output of BLDC
CN-PIPE_OUT	Discharge pipe sensor	Pipe out thermistor
CN-PIPE_IN	Suction pipe sensor	Pipe in thermistor
CN-ROOM	Room sensor	Room thermistor
CN-REMO	Remote controller	Remote control line
CN-FLOAT	Float switch input	Float switch sensing
CN-EEV	EEV Output	EEV Control output : connect to EEV directly or through IPM(Independent Power Module)
CN-LEAK	Refrigerant leak detector	Refrigerant leak detector line
CN-D_PUMP	Drain pump output	AC output for drain pump
CN-OPTION	Option PWB.	Communication between main and option
CN-COM	Communication	Communication between indoor and outdoor
CN-POWER	AC power supply	AC power line input for indoor controller
CN-ZONE	Zone Controller	Zone control line
CN-DISPLAY	RF Remote controller	RF remote control line
CN-CC	Dry contact	Dry contact line
CN-EXT	External On/Off	External On/Off signal input
CN_WF	Wi-Fi Controller	Wifi control line
CN_HUMID	Humidity sensor	Humid sensing

5. Wiring Diagrams

	Function	Description	Setting Off	Setting On	Default
SW1	Communication	N/A (Default)	-	-	Off
SW2	Cycle	N/A (Default)	-	-	Off
SW3	Group Control	Selection of Master or Slave	Master	Slave	Off
SW4	Dry Contact Mode	Selection of Dry Contact Mode	Wired/Wireless remote controller selection of Manual or Auto operation Mode	Auto	Off
SW5	Installation	Fan continuous operation	Continuous operation Removal	-	Off
SW6	Heater linkage	N/A	-	-	Off
SW7	Ventilator linkage	Selection of Ventilator linkage	Linkage Removal	Working	Off
	Vane selection (Console)	Selection of up/down side Vane	Up side + Down side Vane	Up side Vane Only	
	Region selection	Selection tropical region	General model	Tropical model	
SW8	Etc.	Spare	-	-	Off

CAUTION

For Multi V Models, DIP switch 1, 2, 6, 8 must be set OFF.

5. Wiring Diagrams

L2/L3 Chassis

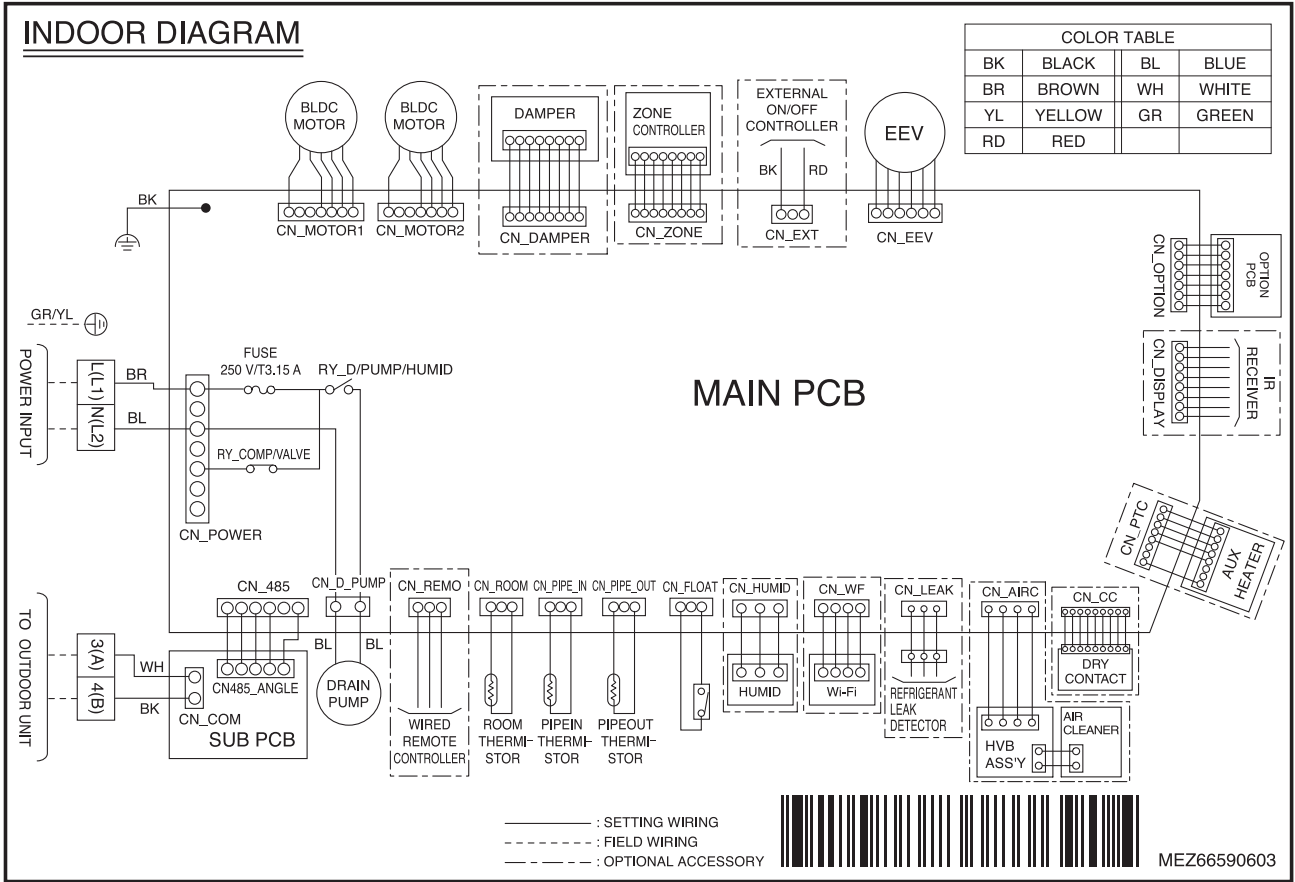

CONNECTOR NUMBER	SPEC.	DESCRIPTION
CN-MOTOR1	Fan motor output	Motor output of BLDC
CN-MOTOR2	Fan motor output	Motor output of BLDC
CN-PIPE_OUT	Discharge pipe sensor	Pipe out thermistor
CN-PIPE_IN	Suction pipe sensor	Pipe in thermistor
CN-ROOM	Room sensor	Room thermistor
CN-REMO	Remote controller	Remote control line
CN-FLOAT	Float switch input	Float switch sensing
CN-EEV	EEV Output	EEV Control output : connect to EEV directly or through IPM(Independent Power Module)
CN-LEAK	Refrigerant leak detector	Refrigerant leak detector line
CN-D_PUMP	Drain pump output	AC output for drain pump
CN-OPTION	Option PWB.	Communication between main and option
CN-COM	Communication	Communication between indoor and outdoor
CN-POWER	AC power supply	AC power line input for indoor controller
CN-ZONE	Zone Controller	Zone control line
CN-DISPLAY	RF Remote controller	RF remote control line
CN-CC	Dry contact	Dry contact line
CN-EXT	External On/Off	External On/Off signal input
CN_WF	Wi-Fi Controller	Wifi control line
CN_HUMID	Humidity sensor	Humid sensing

5. Wiring Diagrams

	Function	Description	Setting Off	Setting On	Default
SW1	Communication	N/A (Default)	-	-	Off
SW2	Cycle	N/A (Default)	-	-	Off
SW3	Group Control	Selection of Master or Slave	Master	Slave	Off
SW4	Dry Contact Mode	Selection of Dry Contact Mode	Wired/Wireless remote controller selection of Manual or Auto operation Mode	Auto	Off
SW5	Installation	Fan continuous operation	Continuous operation Removal	-	Off
SW6	Heater linkage	N/A	-	-	Off
SW7	Ventilator linkage	Selection of Ventilator linkage	Linkage Removal	Working	Off
	Vane selection (Console)	Selection of up/down side Vane	Up side + Down side Vane	Up side Vane Only	
	Region selection	Selection tropical region	General model	Tropical model	
SW8	Etc.	Spare	-	-	Off

CAUTION

For Multi V Models, DIP switch 1, 2, 6, 8 must be set OFF.

6. Capacity Tables

■ Cooling Capacity

Nominal Capacity (kBtu/h) [Capacity Index (kW)]	Indoor air temp. (DB/WB, °C)													
	20		23		26		27		28		30		32	
	14		16		18		19		20		22		24	
	TC	SHC	TC	SHC	TC	SHC	TC	SHC	TC	SHC	TC	SHC	TC	SHC
5 [1.6]	1.1	1.1	1.4	1.3	1.6	1.4	1.7	1.4	1.8	1.5	1.8	1.4	1.9	1.3
7 [2.2]	1.5	1.4	1.8	1.5	2.0	1.6	2.2	1.7	2.4	1.7	2.4	1.6	2.4	1.5
9 [2.8]	1.9	1.8	2.2	1.9	2.6	2.1	2.8	2.1	3.0	2.2	3.0	2.1	3.1	1.9
12 [3.6]	2.4	2.2	2.9	2.4	3.3	2.6	3.6	2.6	3.9	2.7	3.9	2.6	4.0	2.4
15 [4.5]	3.0	2.7	3.6	3.0	4.2	3.2	4.5	3.3	4.8	3.4	4.9	3.2	4.9	3.0
18 [5.6]	3.8	3.4	4.5	3.7	5.2	4.0	5.6	4.1	6.0	4.2	6.1	4.0	6.2	3.7
21 [6.2]	4.2	3.9	5.0	4.3	5.8	4.6	6.2	4.7	6.6	4.9	6.7	4.6	6.8	4.3
24 [7.1]	4.8	4.4	5.7	4.9	6.6	5.3	7.1	5.4	7.6	5.6	7.7	5.3	7.8	4.9

Note

1. TC: Total Capacity(kW), SHC: Sensible Heat Capacity(kW)
2. Capacity tables show the average value of conditions which may occur.
3. Refer to Capacity tables and correction factor in the outdoor unit PDB for the actual performance data of each indoor unit and outdoor unit combination.

■ Heating Capacity

Nominal Capacity (kBtu/h) [Capacity Index (kW)]	Indoor air temp. (DB, °C)					
	16	18	20	21	22	24
	TC	TC	TC	TC	TC	TC
5 [1.6]	2.1	2.0	1.9	1.8	1.8	1.7
7 [2.2]	2.8	2.7	2.5	2.4	2.3	2.2
9 [2.8]	3.6	3.4	3.2	3.1	3.0	2.8
12 [3.6]	4.5	4.3	4.0	3.9	3.7	3.5
15 [4.5]	5.6	5.3	5.0	4.8	4.7	4.4
18 [5.6]	7.1	6.7	6.3	6.1	5.9	5.5
21 [6.2]	7.9	7.4	7.0	6.8	6.6	6.1
24 [7.1]	9.0	8.5	8.0	7.7	7.5	7.0

Note

1. TC: Total Capacity(kW)
2. Capacity tables show the average value of conditions which may occur.
3. Refer to Capacity tables and correction factor in the outdoor unit PDB for the actual performance data of each indoor unit and outdoor unit combination.

7. External Static Pressure (E.S.P) & Air Flow

◆ ARNU05GL1G4, ARNU07GL1G4, ARNU09GL1G4

Setting Value	Static Pressure(mmAq(Pa))					
	0 (0)	1 (10)	2 (20)	3 (29)	4 (39)	5 (49)
	Air Flow Rate (m³/min)					
60	-	-	-	-	-	-
65	5.03	-	-	-	-	-
70	5.60	4.85	-	-	-	-
75	6.19	5.44	4.57	-	-	-
80	6.79	6.05	5.17	-	-	-
85	7.41	6.67	5.80	4.80	-	-
90	8.05	7.31	6.43	5.44	-	-
95	8.71	7.96	7.09	6.09	4.97	-
100	9.38	8.63	7.76	6.76	5.64	-
105	10.07	9.32	8.45	7.45	6.33	5.08
110	-	10.03	9.16	8.16	7.04	5.79
115	-	-	9.88	8.88	7.76	6.51
120	-	-	-	9.62	8.50	7.25
125	-	-	-	10.38	9.26	8.01
130	-	-	-	-	10.03	8.78

Note

1. The above table shows the correlation between the air rates and E.S.P.
2. The above table shows the available E.S.P. range.
3. If the E.S.P. of the installed indoor is less than the lowest value(as mention in the table), indoor components can be failed.

◆ Fan Performance (ARNU05GL1G4, ARNU07GL1G4, ARNU09GL1G4)

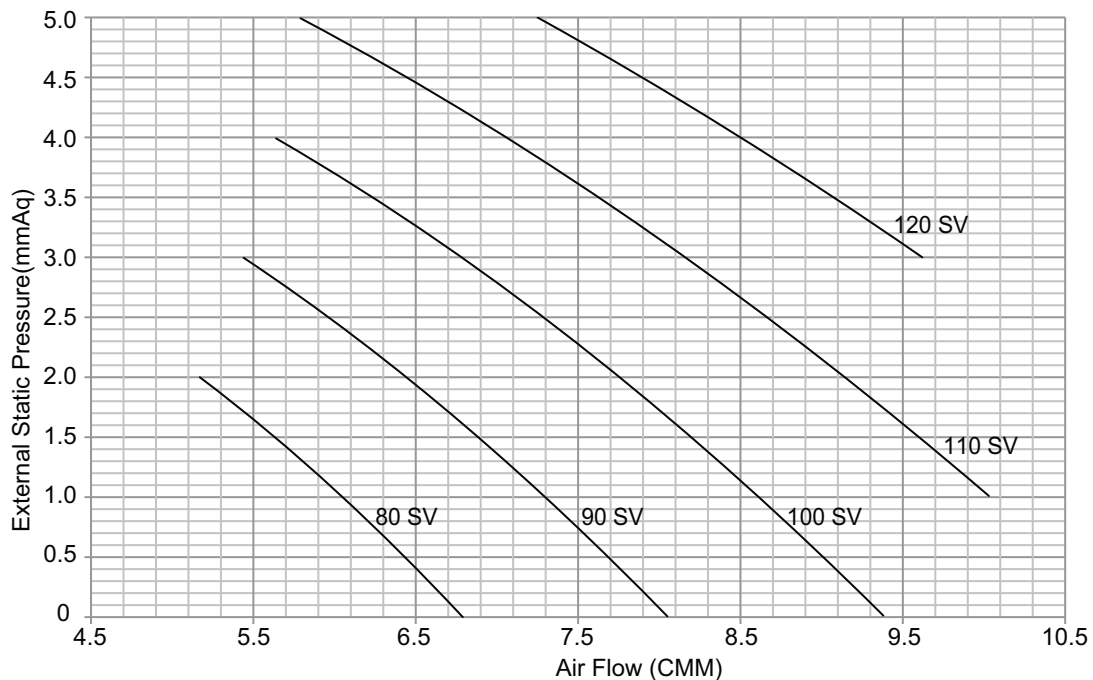

7. External Static Pressure (E.S.P) & Air Flow

◆ ARNU12GL2G4, ARNU15GL2G4, ARNU18GL2G4

Setting Value	Static Pressure(mmAq(Pa))					
	0 (0)	1 (10)	2 (20)	3 (29)	4 (39)	5 (49)
	Air Flow Rate (m³/min)					
75	6.50	-	-	-	-	-
80	7.34	6.70	-	-	-	-
85	8.20	7.55	6.69	-	-	-
90	9.07	8.43	7.56	6.47	-	-
95	9.96	9.32	8.45	7.36	-	-
100	10.87	10.22	9.36	8.27	6.96	-
105	11.79	11.15	10.28	9.19	7.89	6.35
110	12.73	12.09	11.22	10.14	8.83	7.30
115	13.69	13.05	12.18	11.09	9.78	8.25
120	14.67	14.02	13.16	12.07	10.76	9.23
125	15.66	15.01	14.15	13.06	11.75	10.22
130	16.67	16.02	15.16	14.07	12.76	11.23
135	-	-	16.18	15.10	13.79	12.26

Note

1. The above table shows the correlation between the air rates and E.S.P.
2. The above table shows the available E.S.P. range.
3. If the E.S.P. of the installed indoor is less than the lowest value(as mention in the table), indoor components can be failed.

◆ Fan Performance (ARNU12GL2G4, ARNU15GL2G4, ARNU18GL2G4)

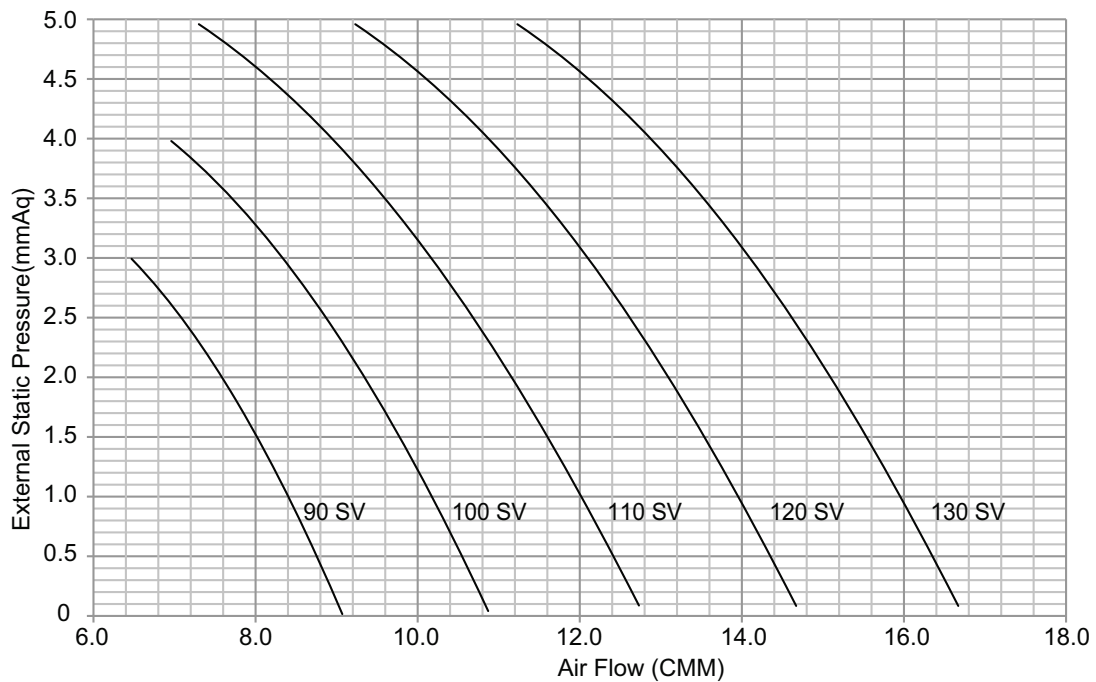

7. External Static Pressure (E.S.P) & Air Flow

◆ ARNU21GL3G4, ARNU24GL3G4

Setting Value	Static Pressure(mmAq(Pa))					
	0 (0)	1 (10)	2 (20)	3 (29)	4 (39)	5 (49)
	Air Flow Rate (m³/min)					
85	10.19	-	-	-	-	-
90	12.18	10.71	11.09	-	-	-
95	13.81	12.34	12.19	-	-	-
100	15.16	13.69	13.38	10.71	-	-
105	16.30	14.83	14.36	11.85	-	-
110	17.31	15.85	15.23	12.86	10.97	-
115	18.27	16.80	16.07	13.82	11.93	-
120	19.26	17.79	16.93	14.80	12.91	10.49
125	20.34	18.87	17.89	15.88	13.99	11.57
130	21.60	20.13	19.01	17.14	15.25	12.83
135	-	21.64	20.36	18.66	16.76	14.35
139	-	-	21.08	20.00	17.34	15.29

Note

1. The above table shows the correlation between the air rates and E.S.P.
2. The above table shows the available E.S.P. range.
3. If the E.S.P. of the installed indoor is less than the lowest value(as mention in the table), indoor components can be failed.

◆ Fan Performance (ARNU21GL3G4, ARNU24GL3G4)

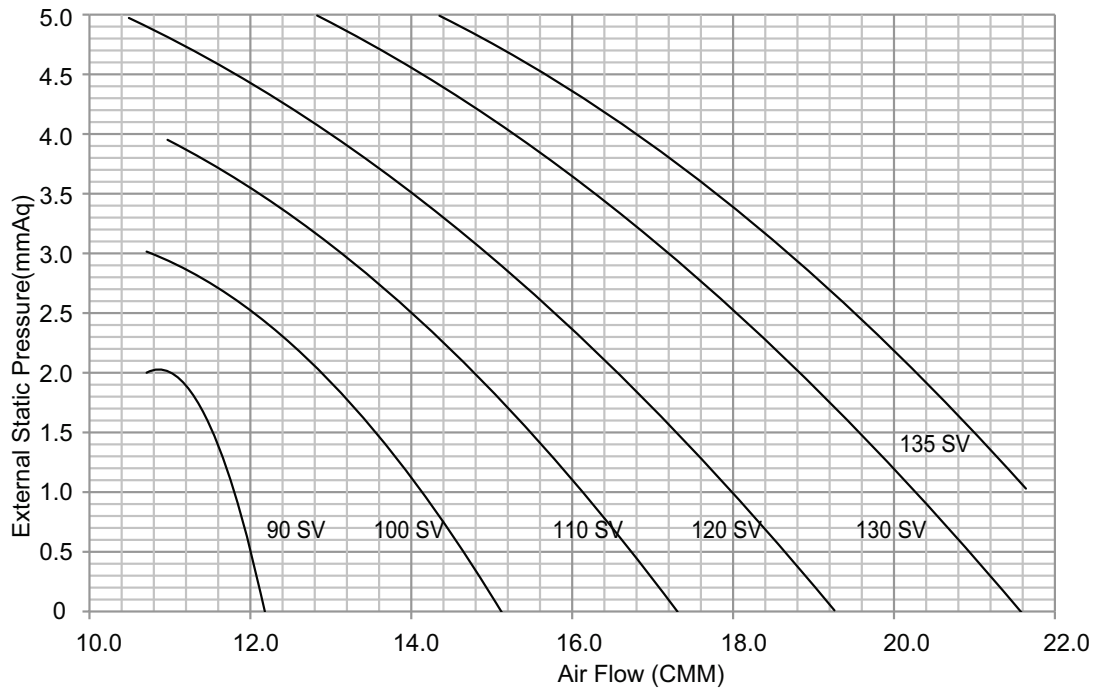

7. External Static Pressure (E.S.P) & Air Flow

◆ ARNU05GL1G4, ARNU07GL1G4, ARNU09GL1G4

Capacity	Mode		Set value	Standard ESP (mmAq(Pa))	CMM	Lower Limit of External Static Pressure(mmAq(Pa))	Upper Limit of External Static Pressure(mmAq(Pa))
5k	High (factory set)	HI	96	2.54 (25)	6.7	-	5(49)
		Mid	91		6.2		
		Low	86		5.5		
	Standard	HI	79	0 (0)	6.7	-	5(49)
		Mid	74		6.2		
		Low	69		5.5		
7k	High (factory set)	HI	100	2.54 (25)	7.5	-	5(49)
		Mid	93		6.5		
		Low	86		5.5		
	Standard	HI	86	0 (0)	7.5	-	5(49)
		Mid	78		6.5		
		Low	69		5.5		
9k	High (factory set)	HI	113	2.54 (25)	9.0	-	5(49)
		Mid	97		7.0		
		Low	86		5.5		
	Standard	HI	97	0 (0)	9.0	-	5(49)
		Mid	81		7.0		
		Low	69		5.5		

Note

1. The above table shows the available E.S.P. range.

◆ ARNU12GL2G4, ARNU15GL2G4, ARNU18GL2G4

Capacity	Mode		Set value	Standard ESP (mmAq(Pa))	CMM	Lower Limit of External Static Pressure(mmAq(Pa))	Upper Limit of External Static Pressure(mmAq(Pa))
12k	High (factory set)	HI	105	2.54 (25)	10.0	-	5(49)
		Mid	96		8.5		
		Low	89		7.0		
	Standard	HI	96	0 (0)	10.0	-	5(49)
		Mid	87		8.5		
		Low	78		7.0		
15k	High (factory set)	HI	119	2.54 (25)	12.5	-	5(49)
		Mid	105		10.0		
		Low	96		8.5		
	Standard	HI	109	0 (0)	12.5	-	5(49)
		Mid	96		10.0		
		Low	87		8.5		
18k	High (factory set)	HI	131	2.54 (25)	15.0	-	5(49)
		Mid	119		12.5		
		Low	105		10.0		
	Standard	HI	120	0 (0)	15.0	-	5(49)
		Mid	109		12.5		
		Low	96		10.0		

Note

1. The above table shows the available E.S.P. range.

7. External Static Pressure (E.S.P) & Air Flow

◆ ARNU21GL3G4, ARNU24GL3G4

Capacity	Mode		Set value	Standard ESP (mmAq(Pa))	CMM	Lower Limit of External Static Pressure(mmAq(Pa))	Upper Limit of External Static Pressure(mmAq(Pa))
21k	High (factory set)	HI	125	2.54 (25)	17.5	-	5(49)
		Mid	110		14.0		
		Low	105		12.0		
	Standard	HI	113	0 (0)	17.5	-	5(49)
		Mid	95		14.0		
		Low	89		12.0		
24k	High (factory set)	HI	139	2.54 (25)	20.0	-	5(49)
		Mid	118		16.0		
		Low	105		12.0		
	Standard	HI	125	0 (0)	20.0	-	5(49)
		Mid	102		16.0		
		Low	89		12.0		

Note

1. The above table shows the available E.S.P. range.

8. Electric Characteristics

Units					Power Supply	IFM		PI	
Model	Type	Hz	Volts	Voltage Range	MCA	kW	FLA	Cooling	Heating
ARNU05GL1G4	L1	50	220-240	Max:264 Min:198	0.50	0.019	0.40	40	40
ARNU07GL1G4	L1				0.50	0.019	0.40	40	40
ARNU09GL1G4	L1				0.50	0.019	0.40	40	40
ARNU12GL2G4	L2				1.00	0.024	0.76	85	85
ARNU15GL2G4	L2				1.00	0.024	0.76	85	85
ARNU18GL2G4	L2				1.00	0.024	0.76	85	85
ARNU21GL3G4	L3				1.20	0.038	0.97	115	115
ARNU24GL3G4	L3				1.20	0.038	0.97	115	115
ARNU05GL1G4	L1	60	220	Max:242 Min:198	0.50	0.019	0.40	40	40
ARNU07GL1G4	L1				0.50	0.019	0.40	40	40
ARNU09GL1G4	L1				0.50	0.019	0.40	40	40
ARNU12GL2G4	L2				1.00	0.024	0.76	85	85
ARNU15GL2G4	L2				1.00	0.024	0.76	85	85
ARNU18GL2G4	L2				1.00	0.024	0.76	85	85
ARNU21GL3G4	L3				1.20	0.038	0.97	115	115
ARNU24GL3G4	L3				1.20	0.038	0.97	115	115

Symbols

MCA : Minimum Circuit Amperes (A)

MFA : Maximum Fuse Amperes (A)

kW : Fan Motor Rated Output (kW)

FLA : Full Load Amperes (A)

IFM : Indoor Fan Motor

PI : Maximum Power Input (W)

Note

- Voltage range
Units are suitable for use on electrical systems where voltage supplied to unit terminals is not below or above the listed range limits.
- Maximum allowable voltage unbalance between phases is 2%.
- MCA/MFA
 $MCA = 1.25 \times FLA$
 $MFA = 1.1 \times MCA, MFA \leq 4 \times FLA$
 (If MFA is smaller than minimum standard value, Use minimum standard value in region for selecting circuit breaker.)
- Select wire size based on the MCA
- Instead of fuse, use Circuit Breaker.

9. Sound Levels

9.1 Sound Pressure Levels

Overall

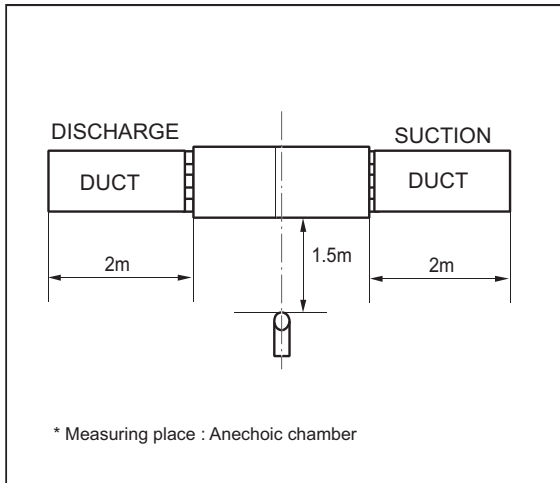

Note

1. Sound measured at some distance away from the center of the unit.
2. Data is valid at free field condition.
3. Reference acoustic pressure 0dB = 20μPa.
4. Data is valid at nominal operation condition. Refer to the Model Specifications for nominal conditions (Power source and Ambient temperature, etc)
5. Sound levels can be increased in accordance with installation and operating conditions. (Static pressure mode, used air guide, Room target temperature setting, etc)
6. Sound level will vary depending on a range of factors such as the construction (acoustic absorption coefficient) of particular room in which the equipment is installed.
7. Sound pressure level is measured on the rated condition in the anechoic rooms by ISO 3745 standard. Therefore, these values can be increased owing to ambient conditions during operation.

Model	Sound Pressure Levels (dB(A),H-M-L)		
	External Static Pressure (Pa)		
	10	20	50
ARNU05GL1G4	24-22-21	25-24-22	29-28-27
ARNU07GL1G4	25-22-21	26-24-22	31-29-27
ARNU09GL1G4	27-24-21	28-25-22	32-30-27
ARNU12GL2G4	28-26-24	30-27-25	34-32-30
ARNU15GL2G4	32-28-26	33-30-28	36-34-32
ARNU18GL2G4	34-31-28	35-32-29	38-36-34
ARNU21GL3G4	33-28-27	35-29-28	38-36-34
ARNU24GL3G4	35-32-27	36-33-28	39-36-34

9.1.1 Sound Pressure Levels(10pa)

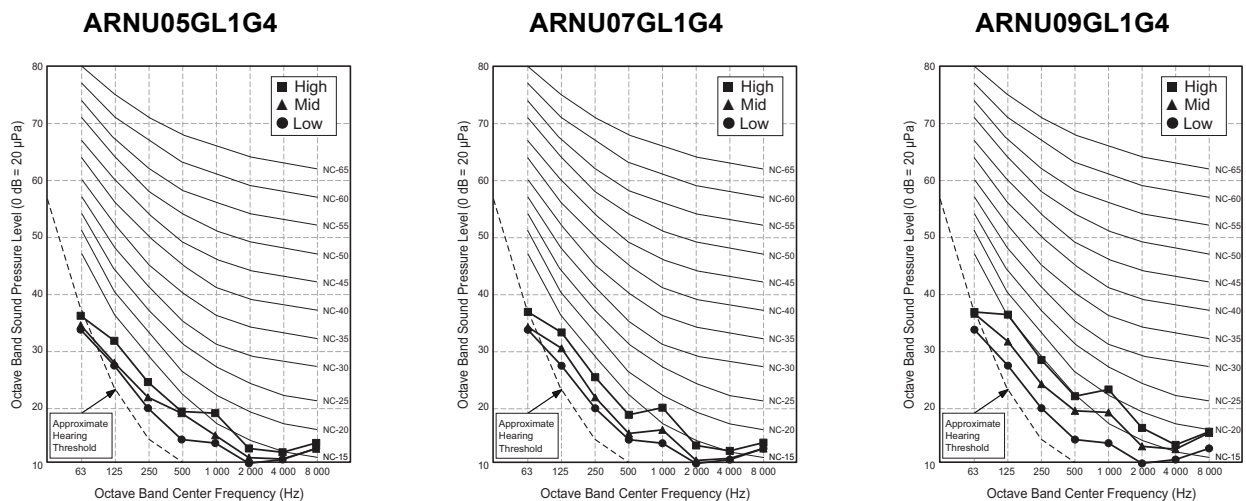

9. Sound Levels

ARNU12GL2G4

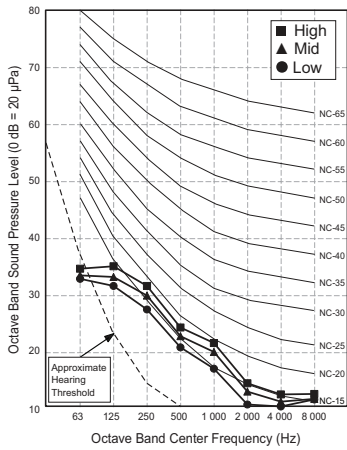

ARNU15GL2G4

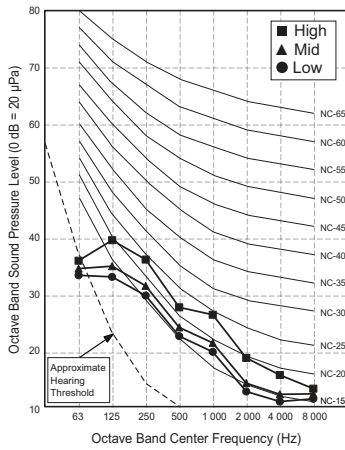

ARNU18GL2G4

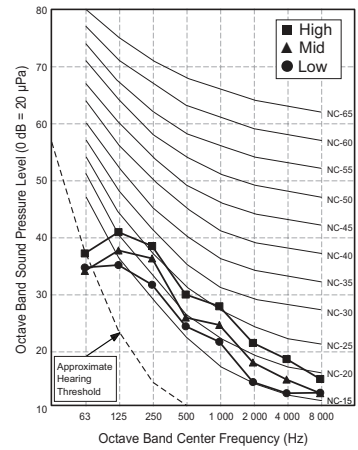

ARNU21GL3G4

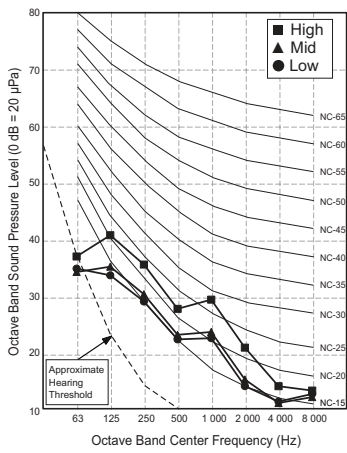

ARNU24GL3G4

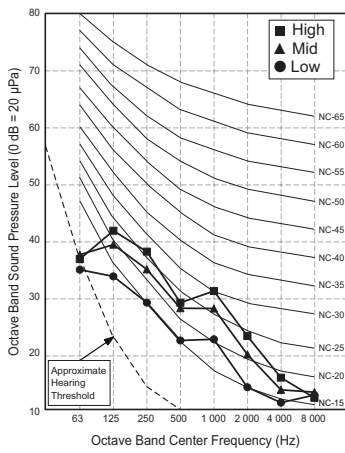

9.1.2 Sound Pressure Levels(20pa)

ARNU05GL1G4

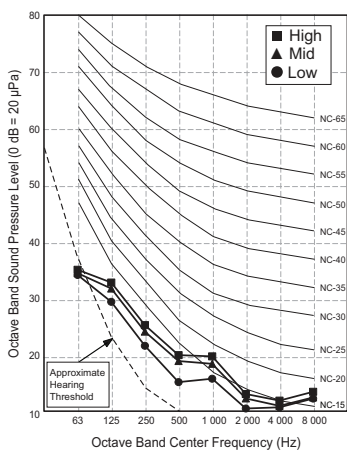

ARNU07GL1G4

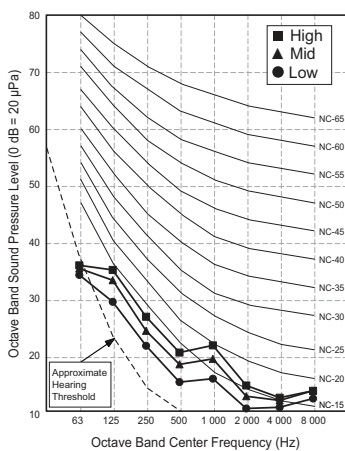

ARNU09GL1G4

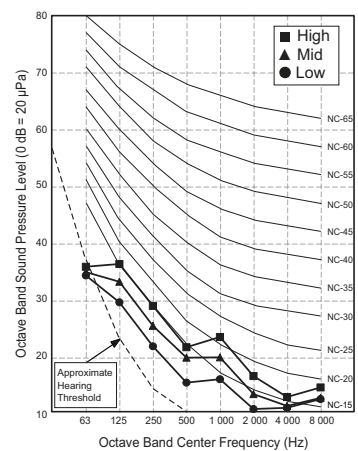

9. Sound Levels

ARNU12GL2G4

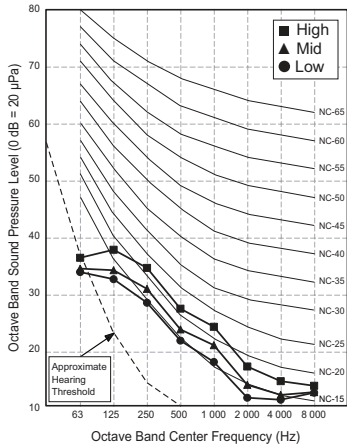

ARNU15GL2G4

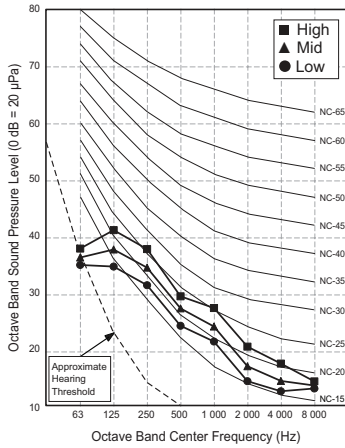

ARNU18GL2G4

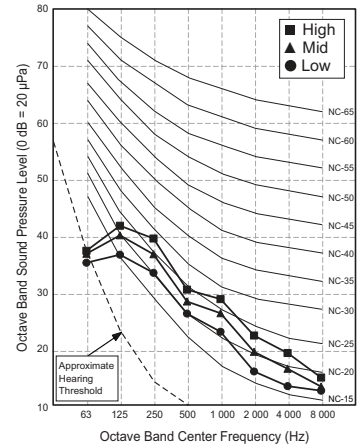

ARNU21GL3G4

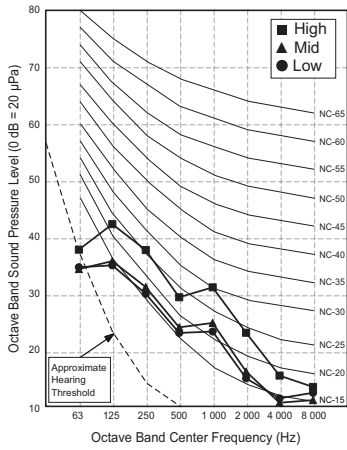

ARNU24GL3G4

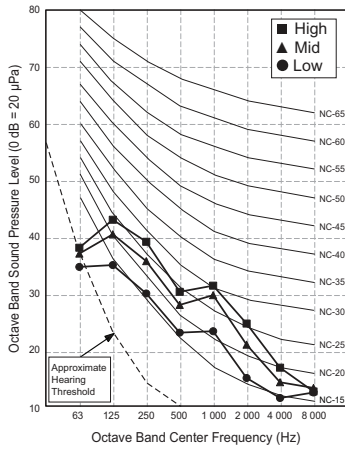

9.1.3 Sound Pressure Levels(50pa)

ARNU05GL1G4

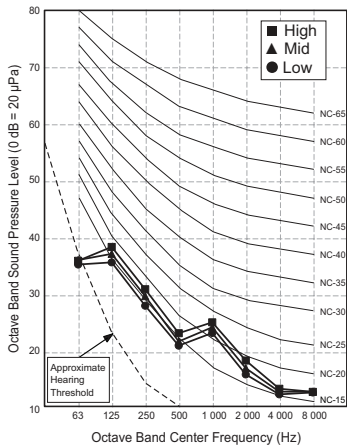

ARNU07GL1G4

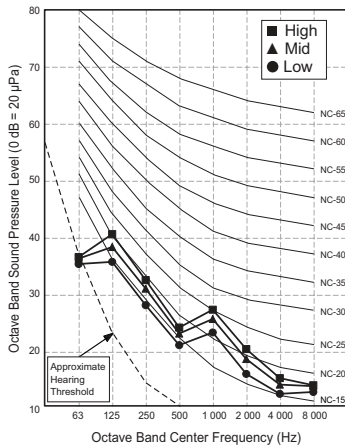

ARNU09GL1G4

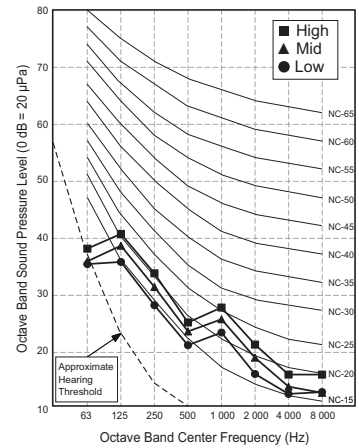

9. Sound Levels

ARNU12GL2G4

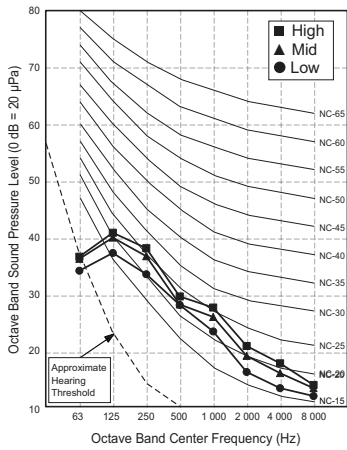

ARNU15GL2G4

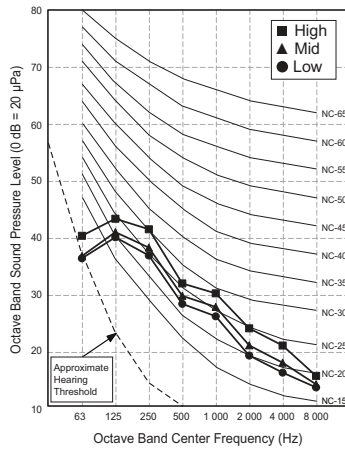

ARNU18GL2G4

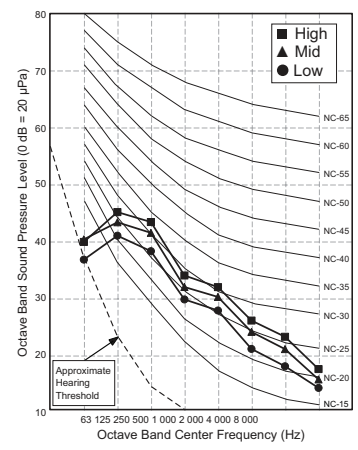

ARNU21GL3G4

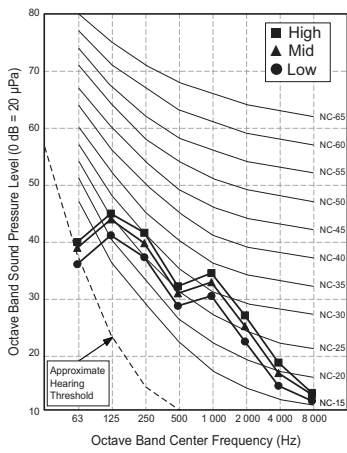

ARNU24GL3G4

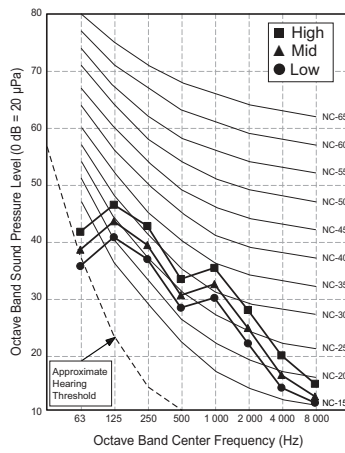

9. Sound Levels

9.2 Sound Power Levels

Note

- Data is valid at diffuse field condition
- Data is valid at nominal operating condition
- Sound level can be increased in static pressure mode or used air guide.
- Sound level will vary depending on a range of factors such as the construction (acoustic absorption coefficient) of particular room in which the equipment is installed.
- Reference acoustic intensity 0dB = $10E-6\mu W/m^2$
- Sound power level is measured on the rated condition in the semi-anechoic rooms by ISO 9614 standard. Therefore, these values can be increased owing to ambient conditions during operation.

Model	Sound Power Levels [dB(A)]		
	External Static Pressure (Pa)		
	10	20	50
ARNU05GL1G4	47-45-43	48-46-45	53-51-50
ARNU07GL1G4	49-47-42	50-47-45	53-52-50
ARNU09GL1G4	52-48-43	53-49-45	55-53-50
ARNU12GL2G4	50-48-46	50-47-46	54-52-50
ARNU15GL2G4	55-52-48	54-51-47	56-54-52
ARNU18GL2G4	57-55-52	56-54-51	57-56-54
ARNU21GL3G4	59-55-53	59-55-54	62-59-58
ARNU24GL3G4	63-58-55	63-59-55	63-60-58

9.2.1 Sound Power Levels (10Pa)

ARNU05GL1G4

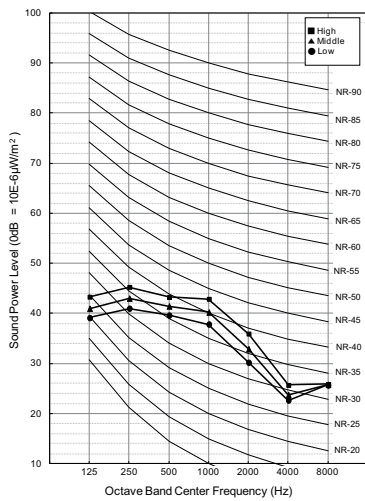

ARNU07GL1G4

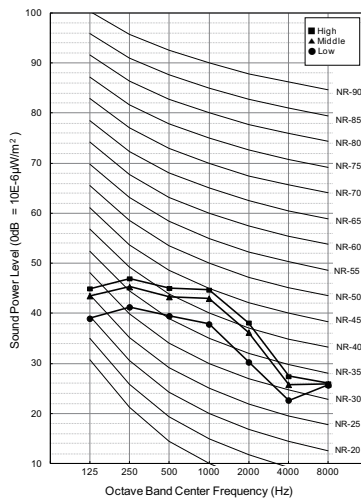

ARNU09GL1G4

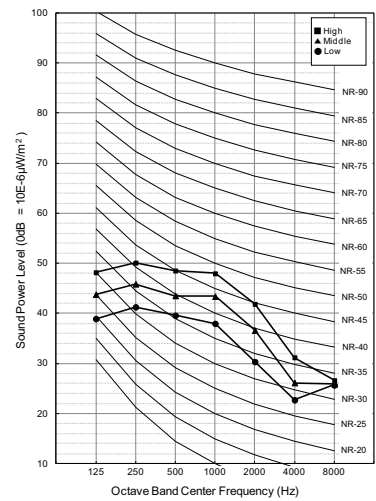

9. Sound Levels

ARNU12GL2G4

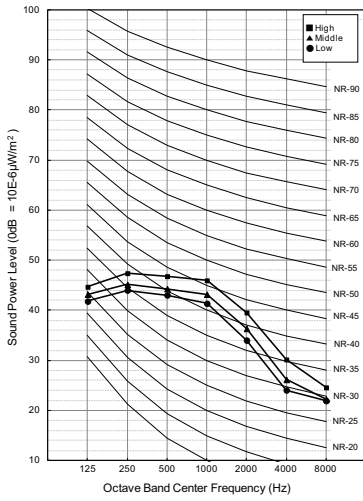

ARNU15GL2G4

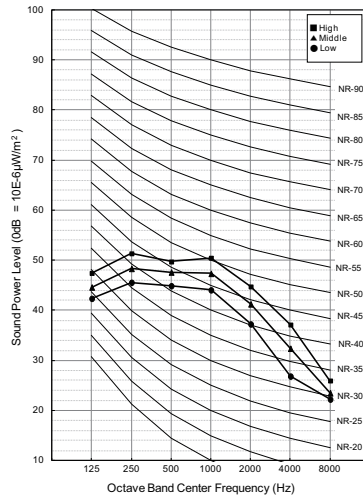

ARNU18GL2G4

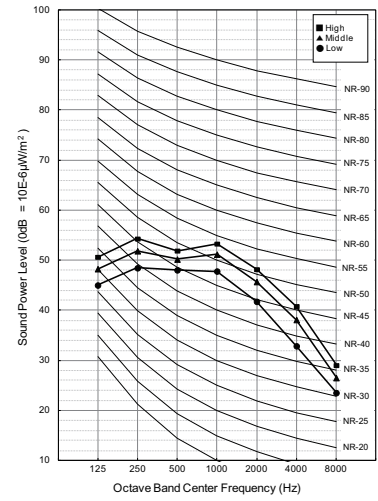

ARNU21GL3G4

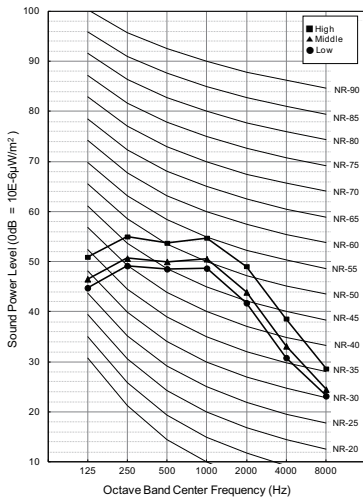

ARNU24GL3G4

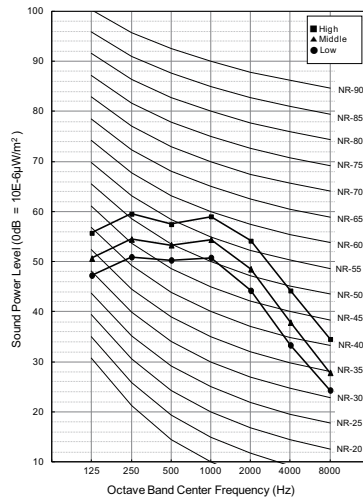

9.2.2 Sound Power Levels (20Pa)

ARNU05GL1G4

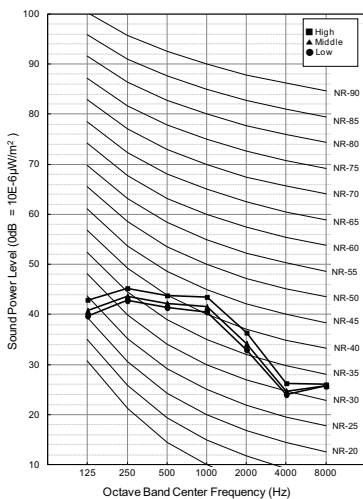

ARNU07GL1G4

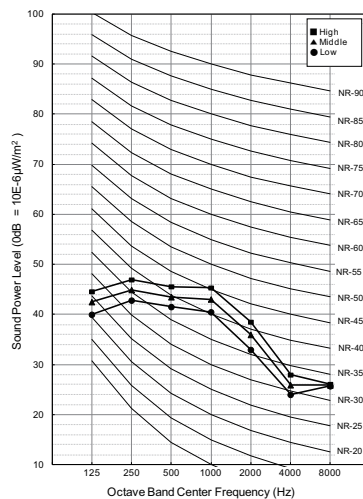

ARNU09GL1G4

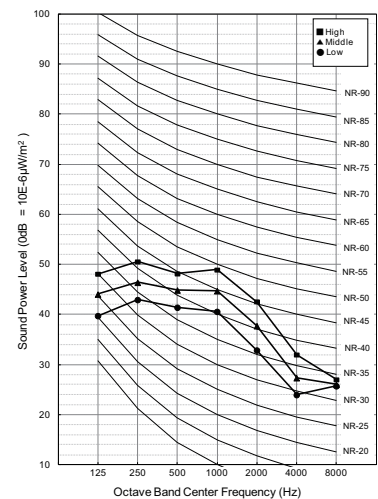

9. Sound Levels

ARNU12GL2G4

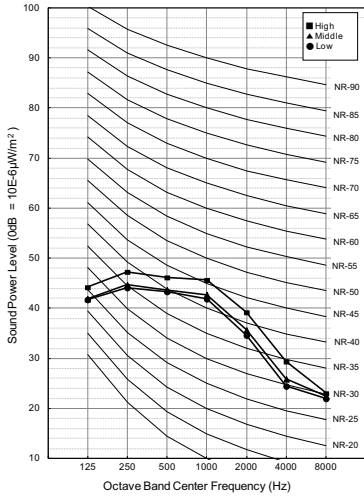

ARNU15GL2G4

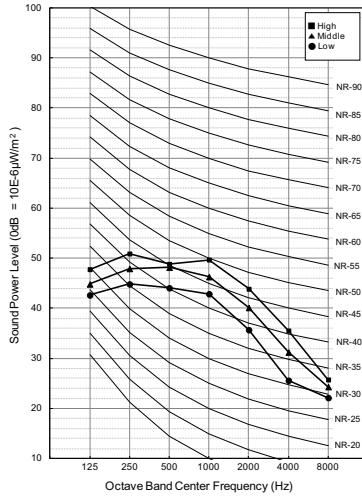

ARNU18GL2G4

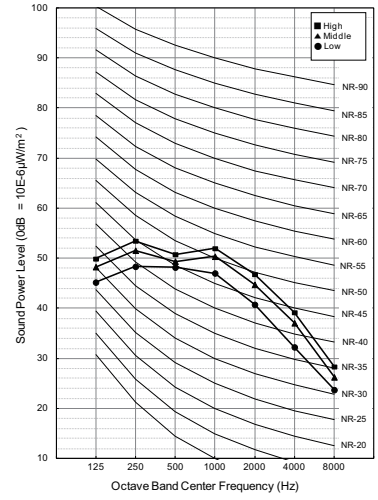

ARNU21GL3G4

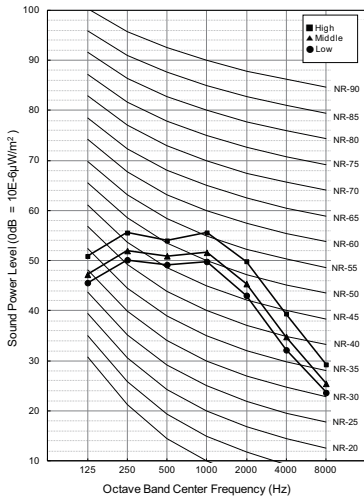

ARNU24GL3G4

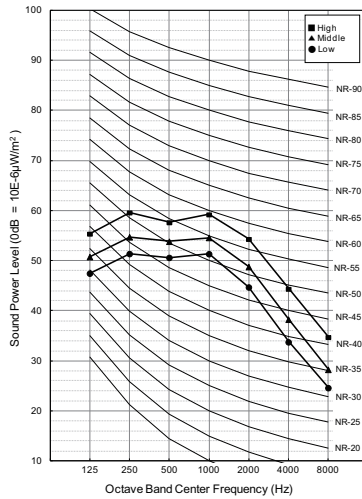

9.2.3 Sound Power Levels (50Pa)

ARNU05GL1G4

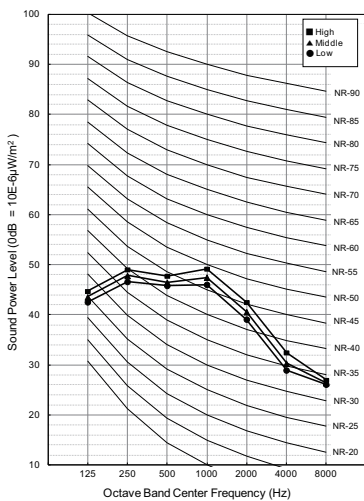

ARNU07GL1G4

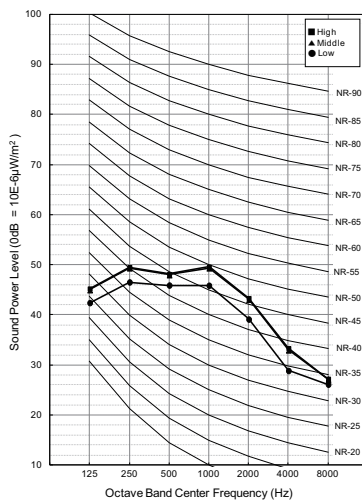

ARNU09GL1G4

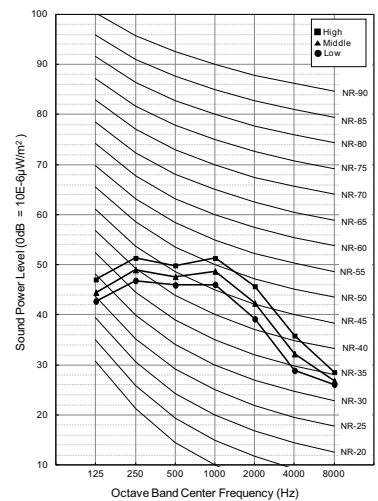

9. Sound Levels

ARNU12GL2G4

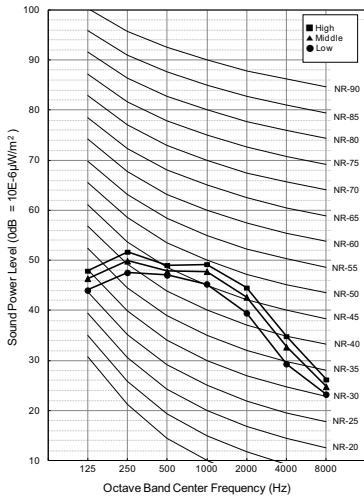

ARNU15GL2G4

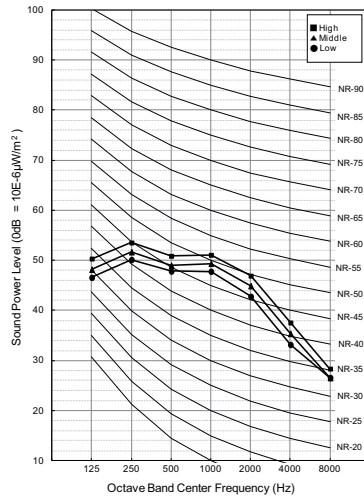

ARNU18GL2G4

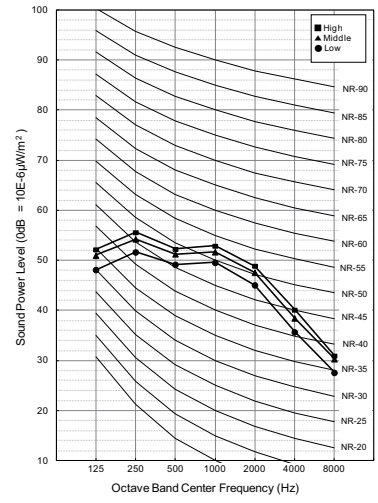

ARNU21GL3G4

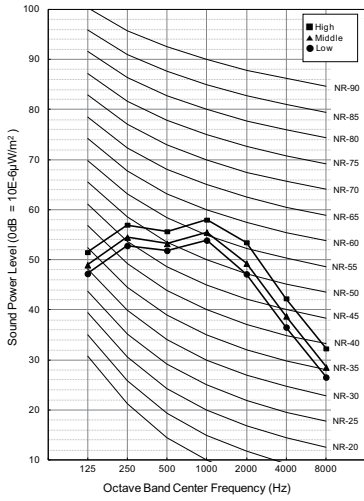

ARNU24GL3G4

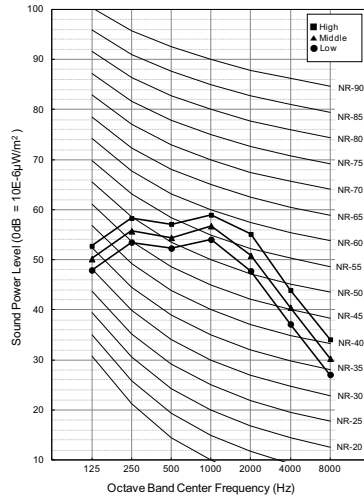

Ceiling Concealed Duct (Low Static(Slim))

- 1.List of functions**
- 2.Specifications**
- 3.Dimensions & Gravity points**
- 4.Piping Diagrams**
- 5.Wiring Diagrams**
- 6.Capacity Tables**
- 7.External Static Pressure(E.S.P) & Air Flow**
- 8.Electric Characteristics**
- 9.Sound Levels**

1. List of functions

◆ List of functions

Category	Function	ARNU05GL4G4, ARNU07GL4G4, ARNU09GL4G4, ARNU12GL5G4, ARNU15GL5G4, ARNU18GL5G4, ARNU21GL6G4, ARNU24GL6G4
Air Flow	Air Supply Outlet	1
	Airflow Steps (fan/cool/heat)	3 / 3 / 3
	Fan Speed Auto*	X
	Power Cool/Heat	X / X
	Dry Operation	O
Air Purification	Air Purify	X
	Pre-Filter	O
Reliability	Hot Start	O
	Self Diagnosis	O
Convenience	Auto Mode	O
	Auto Dry Operation	O
	Auto Restart	O
	Child Lock*	O
	Group Control*	O
	Sleep Timer	O
	Turn On/Off Reservation	O
	Schedule*	O
	Two Thermistor Control*	O
	External On/Off	O
Installation	Drain Pump	O
	E.S.P. Control*	O
Special Functions	Wi-Fi	Accessory

Note

- O : Applied, X : Not Applied, - : Unconfirmed or irrelevant
Embedded : A kit is provided by default for using this function when the product is manufactured.
Accessory : Ordered and purchased separately the accessory package referring to the model name provided and install at field. Accessory line-ups varies by region, so check your local catalogue or local sales material.
- Some functions can be limited by remote controller.
- Selecting a wireless remote controller in case of ducted type indoor units requires either a connection to the wired remote controller (Standard II) or an IR receiver accessory to be connected to the duct in order to receive the signal.
- 'Auto Mode' varies depending on the outdoor unit type.
 - Auto Change Over(Heat Recovery Outdoor Unit)
 - Auto Mode Select(Heat Pump Outdoor Unit)
 - Auto Intensity Control(Cooling Only Outdoor Unit)
- * : These functions need to connect the wired remote controller.

1. List of functions

◆ Accessory Compatibility List

Category	Accessory Name	Model Name	Description	ARNU**GL4G4 ARNU**GL5G4 ARNU**GL6G4
Remote Controller	Wired - Premium	PREMTA000	-	○
		PREMTA000A	-	○
		PREMTA000B	-	○
	Wired - RS3 (Standard III)	PREMTB100/PREMTB101	White	○
		PREMTBB10/PREMTBB11	Black	○
	Wired - RS2 (Standard II)	PREMTB001	White	○
		PREMTBB01	Black	○
	Wired - Simple	PQRCVCL0QW	White	○
		PQRCVCL0Q	Black	○
	Wired - Simple for Hotel	PQRCHCA0QW	White	○
		PQRCHCA0Q	Black	○
	Wireless	PQWRCQ0FDB	For Cooling only	○
PQWRHQ0FDB		For Heat pump	○	
PWLSSB21C		For Cooling only	○	
PWLSSB21H		For Heat pump	○	
Dry Contact	Simple	PDRYCB000	1 input port, AC 220 - 240V	○
		PDRYCB100	1 input port, AC 24V	○
	Communication	PDRYCB400	2 input port	○
		PDRYCB300	8 input port, For 3rd party Thermostat	○
		PDRYCB320	8 input port, For 3rd Party Thermostat (Analog Input)	○
PDRYCB500	For 3rd Party Controller (Modbus RTU)	○		
Integration Device	Remote Temperature sensor	PQRSTA0	-	○
	Zone Controller	ABZCA	For Duct, 4zone, 220-240V	X
	Group Control wire	PZCWRCG3	Cable Assembly For group control (Y-type cable : 0.25m, cable : 9.6m)	○
ETC	Extension wire	PZCWRC1	Extension wire For IDU-wired remote controller (9.6m)	X
	2-Remo Control Wire	PZCWRC2	-	X
	Wi-Fi Modem	PWFMDD200	-	○
	Wi-Fi Extension cable	PWYREW000	USB Extension cable : 10 m	○
	IR Receiver	PWLRVN000	For wireless remote controller with Duct	○
	Independent Power Module	PRIP0	-	○
	Multi-tenant Power module	PINPMB001	-	○
	Refrigerant Leakage Detector	PRLDNVS0	For R410A only	○
	UVnano Filter Box	PBM13M1UA0	For M1 Chassis	X
		PBM13M2UA0	For M2 Chassis	X
		PBM13M3UA0	For M3 Chassis	X
	High Efficiency Filter (Main Filter of Filter Box)	FBM13M1UA0	For M1 UVnano Filter Box	X
		FBM13M2UA0	For M2 UVnano Filter Box	X
		FBM13M3UA0	For M3 UVnano Filter Box	X
EEV Kit	PRGK024A0	For Multi V Indoor Unit	○(L4)	
Auxiliary Heater Relay Kit	PRARH1	For Cassette and Duct Indoor Units	○	

Note

1. ○: Possible, X: Impossible, - : Not applicable, Embedded : Included with product.
2. If there is a difference in development time between the product and the remote controller, some functions cannot be operated.
3. If using Wi-Fi controller, Some advanced functions controlled by remote controller cannot be operated.
4. Selecting a wireless remote controller in case of ducted type indoor units requires either a connection to the wired remote controller (Standard II) or an IR receiver accessory to be connected to the duct in order to receive the signal.
5. If you need more detail, please refer to the **BECON** PDB or the manual of product. (<http://partner.lge.com/global> : Home> Doc.Library> Product > Control(BECON))

2. Specifications

Model Name		Unit	ARNU05GL4G4	ARNU07GL4G4
Cooling Capacity	Rated	kW	1.8	2.2
		kcal/h	1,600	1,900
		Btu/h	6,100	7,500
Heating Capacity	Rated	kW	2.2	2.5
		kcal/h	1,900	2,200
		Btu/h	7,500	8,500
Power Input	H/M/L	W	15 / 13 / 11	28 / 24 / 21
Running Current	H/M/L	A	0.12 / 0.10 / 0.09	0.23 / 0.19 / 0.17
Indoor Fan	Type	-	Sirocco Fan	Sirocco Fan
	Air Flow Rate(H/M/L)	m ³ /min	7.0 / 6.5 / 5.5	7.5 / 6.5 / 5.5
	External Static Pressure (Factory Set)	mmAq(Pa)	1 (10)	1 (10)
	External Static Pressure (Min ~ Max)	mmAq (Pa)	0(0) ~ 5(49)	0(0) ~ 5(49)
Indoor Fan Motor	Type	-	BLDC	BLDC
	Drive	-	Direct	Direct
	Output	W x No.	19 x 1	19 x 1
	FLA(Full Load Ampere)	A	0.40	0.40
Heat Exchanger	(Rows x Columns x FPI) x No.	-	(2 x 6 x 14) x 2	(2 x 6 x 14) x 2
	Face Area	m ²	0.12	0.12
Dimensions	Net(W x H x D)	mm	700 x 190 x 460	700 x 190 x 460
	Shipping(W x H x D)	mm	925 x 255 x 561	925 x 255 x 561
Weight	Net	kg(lbs)	14.0(30.9)	14.0(30.9)
	Shipping	kg(lbs)	17.6(38.8)	17.6(38.8)
Exterior	Color(RAL Code)	-	-	-
Air Filter	Type	-	Pre Filter	Pre Filter
Temperature Control		-	Microprocessor Thermostat for cooling and heating	
Sound Absorbing / Thermal Insulation Material		-	Foamed polystyrene	
Safety Device		-	Fuse	Fuse
Refrigerant	Type	-	R410A/R32	R410A/R32
	Additional Charging Amount (CF Value of IDU)	kg(each)	0.14/0.12	0.14/0.12
	Control Type	-	EEV	EEV
Drain Pipe	O.D / I.D	mm(inch)	-/25.4(1)	-/25.4(1)
Piping Connection	Liquid	mm(inch)	6.35(1/4)	6.35(1/4)
	Gas	mm(inch)	12.7(1/2)	12.7(1/2)
	Connection Type(Liquid)	-	Flare	Flare
	Connection Type(Gas)	-	Flare	Flare
Sound Pressure Level (H / M / L)		dB(A)	25.0 / 24.0 / 22.0	26.0 / 24.0 / 22.0
Sound Power Level (H / M / L, Body)		dB(A)	32.5 / 31.4 / 29.6	34.0 / 31.4 / 29.6
Power Supply	-	V, Φ, Hz	220 - 230 - 240, 1,50/60	220 - 230 - 240, 1,50/60
	Running Current by voltage	A	0.12 - 0.12 - 0.11	0.23 - 0.23 - 0.22
Transmission Cable		mm ² x cores	1.0~1.5 x 2C	1.0~1.5 x 2C

Note

1. Due to our policy of innovation some specifications may be changed without notification.
2. Wiring cable size must comply with the applicable local and national code. And "Electric characteristics" chapter should be considered for electrical work and design. Especially the power cable and circuit breaker should be selected in accordance with that.
3. Sound pressure level is measured on the rated condition in the anechoic rooms by ISO 3745 standard.
Sound power level is measured on the rated condition in the semi-anechoic rooms by ISO 9614 standard.
Therefore, these values can be increased owing to ambient conditions during operation.
4. Capacities are net capacities and based on the following conditions. Refer to the Outdoor Unit Specifications for calculating the real capacity.
 - Cooling : Indoor Ambient Temp. 27°CDB / 19°CWB, Outdoor Ambient Temp. 35°CDB / 24°CWB
 - Heating : Indoor Ambient Temp. 20°CDB / 15°CWB, Outdoor Ambient Temp. 7°CDB / 6°CWB
 - Interconnected Pipe is standard length and difference of Elevation (Outdoor ~ Indoor Unit) is 0m.
5. Refrigerant information (type, additional charging amount, etc.) must be applied by refrigerant type of the combined outdoor unit.
Adapt after checking the specifications of outdoor unit.

2. Specifications

Model Name		Unit	ARNU09GL4G4	ARNU12GL5G4
Cooling Capacity	Rated	kW	2.8	3.6
		kcal/h	2,400	3,100
		Btu/h	9,600	12,300
Heating Capacity	Rated	kW	3.2	4
		kcal/h	2,800	3,400
		Btu/h	10,900	13,600
Power Input	H/M/L	W	28 / 24 / 21	43 / 38 / 35
Running Current	H/M/L	A	0.22 / 0.19 / 0.17	0.39 / 0.34 / 0.32
Indoor Fan	Type	-	Sirocco Fan	Sirocco Fan
	Air Flow Rate(H/M/L)	m ³ /min	9.0 / 7.0 / 5.5	10.0 / 8.5 / 7.0
	External Static Pressure (Factory Set)	mmAq(Pa)	1 (10)	1 (10)
	External Static Pressure (Min ~ Max)	mmAq (Pa)	0(0) ~ 5(49)	0(0) ~ 5(49)
Indoor Fan Motor	Type	-	BLDC	BLDC
	Drive	-	Direct	Direct
	Output	W x No.	19 x 1	19 x 1 + 5 x 1
	FLA(Full Load Ampere)	A	0.40	0.76
Heat Exchanger	(Rows x Columns x FPI) x No.	-	(2 x 6 x 14) x 2	(2 x 6 x 18) x 2
	Face Area	m ²	0.12	0.17
Dimensions	Net(W x H x D)	mm	700 x 190 x 460	900 x 190 x 460
	Shipping(W x H x D)	mm	925 x 255 x 561	1,125 x 255 x 561
Weight	Net	kg(lbs)	14.0(30.9)	17.9(39.5)
	Shipping	kg(lbs)	17.6(38.8)	21.8(48.1)
Exterior	Color(RAL Code)	-	-	-
Air Filter	Type	-	Pre Filter	Pre Filter
Temperature Control	-	-	Microprocessor Thermostat for cooling and heating	
Sound Absorbing / Thermal Insulation Material	-	-	Foamed polystrene	
Safety Device	-	-	Fuse	Fuse
Refrigerant	Type	-	R410A/R32	R410A/R32
	Additional Charging Amount (CF Value of IDU)	kg(each)	0.14/0.12	0.19/0.17
	Control Type	-	EEV	EEV
Drain Pipe	O.D / I.D	mm(inch)	-/25.4(1)	-/25.4(1)
Piping Connection	Liquid	mm(inch)	6.35(1/4)	6.35(1/4)
	Gas	mm(inch)	12.7(1/2)	12.7(1/2)
	Connection Type(Liquid)	-	Flare	Flare
	Connection Type(Gas)	-	Flare	Flare
Sound Pressure Level (H / M / L)	-	dB(A)	28.0 / 25.0 / 22.0	29.0 / 27.0 / 25.0
Sound Power Level (H / M / L, Body)	-	dB(A)	36.1 / 32.5 / 29.6	35.1 / 32.7 / 30.7
Power Supply	-	V, Φ , Hz	220 - 230 - 240, 1,50/60	220 - 230 - 240, 1,50/60
	Running Current by voltage	A	0.23 - 0.22 - 0.21	0.40 - 0.39 - 0.37
Transmission Cable	-	mm ² x cores	1.0~1.5 x 2C	1.0~1.5 x 2C

Note

- Due to our policy of innovation some specifications may be changed without notification.
- Wiring cable size must comply with the applicable local and national code. And "Electric characteristics" chapter should be considered for electrical work and design. Especially the power cable and circuit breaker should be selected in accordance with that.
- Sound pressure level is measured on the rated condition in the anechoic rooms by ISO 3745 standard.
Sound power level is measured on the rated condition in the semi-anechoic rooms by ISO 9614 standard.
Therefore, these values can be increased owing to ambient conditions during operation.
- Capacities are net capacities and based on the following conditions. Refer to the Outdoor Unit Specifications for calculating the real capacity.
 - Cooling : Indoor Ambient Temp. 27°CDB / 19°CWB, Outdoor Ambient Temp. 35°CDB / 24°CWB
 - Heating : Indoor Ambient Temp. 20°CDB / 15°CWB, Outdoor Ambient Temp. 7°CDB / 6°CWB
 - Interconnected Pipe is standard length and difference of Elevation (Outdoor ~ Indoor Unit) is 0m.
- Refrigerant information (type, additional charging amount, etc.) must be applied by refrigerant type of the combined outdoor unit.
Adapt after checking the specifications of outdoor unit.

2. Specifications

Model Name		Unit	ARNU15GL5G4	ARNU18GL5G4
Cooling Capacity	Rated	kW	4.5	5.6
		kcal/h	3,900	4,800
		Btu/h	15,400	19,100
Heating Capacity	Rated	kW	5	6.3
		kcal/h	4,300	5,400
		Btu/h	17,100	21,500
Power Input	H/M/L	W	54 / 45 / 38	57 / 39 / 30
Running Current	H/M/L	A	0.48 / 0.40 / 0.34	0.51 / 0.35 / 0.30
Indoor Fan	Type	-	Sirocco Fan	Sirocco Fan
	Air Flow Rate(H/M/L)	m ³ /min	12.5 / 10.0 / 8.5	15.0 / 12.5 / 10.0
	External Static Pressure (Factory Set)	mmAq(Pa)	1 (10)	1 (10)
	External Static Pressure (Min ~ Max)	mmAq (Pa)	0(0) ~ 5(49)	0(0) ~ 5(49)
Indoor Fan Motor	Type	-	BLDC	BLDC
	Drive	-	Direct	Direct
	Output	W x No.	19 x 1 + 5 x 1	19 x 1 + 5 x 1
	FLA(Full Load Ampere)	A	0.76	0.76
Heat Exchanger	(Rows x Columns x FPI) x No.	-	(2 x 6 x 18) x 2	(2 x 6 x 18) x 2
	Face Area	m ²	0.17	0.17
Dimensions	Net(W x H x D)	mm	900 x 190 x 460	900 x 190 x 460
	Shipping(W x H x D)	mm	1,125 x 255 x 561	1,125 x 255 x 561
Weight	Net	kg(lbs)	17.9(39.5)	17.9(39.5)
	Shipping	kg(lbs)	21.8(48.1)	21.8(48.1)
Exterior	Color(RAL Code)	-	-	-
Air Filter	Type	-	Pre Filter	Pre Filter
Temperature Control	-	-	Microprocessor Thermostat for cooling and heating	
Sound Absorbing / Thermal Insulation Material	-	-	Foamed polystyrene	
Safety Device	-	-	Fuse	Fuse
Refrigerant	Type	-	R410A/R32	R410A/R32
	Additional Charging Amount (CF Value of IDU)	kg(each)	0.19/0.17	0.19/0.17
	Control Type	-	EEV	EEV
Drain Pipe	O.D / I.D	mm(inch)	-/25.4(1)	-/25.4(1)
Piping Connection	Liquid	mm(inch)	6.35(1/4)	6.35(1/4)
	Gas	mm(inch)	12.7(1/2)	12.7(1/2)
	Connection Type(Liquid)	-	Flare	Flare
	Connection Type(Gas)	-	Flare	Flare
Sound Pressure Level (H / M / L)	-	dB(A)	32.0 / 29.0 / 27.0	35.0 / 32.0 / 29.0
Sound Power Level (H / M / L, Body)	-	dB(A)	38.4 / 35.1 / 32.7	42.1 / 38.4 / 35.1
Power Supply	-	V, Φ , Hz	220 - 230 - 240, 1,50/60	220 - 230 - 240, 1,50/60
	Running Current by voltage	A	0.50 - 0.48 - 0.46	0.53 - 0.51 - 0.49
Transmission Cable	-	mm ² x cores	1.0~1.5 x 2C	1.0~1.5 x 2C

Note

- Due to our policy of innovation some specifications may be changed without notification.
- Wiring cable size must comply with the applicable local and national code. And "Electric characteristics" chapter should be considered for electrical work and design. Especially the power cable and circuit breaker should be selected in accordance with that.
- Sound pressure level is measured on the rated condition in the anechoic rooms by ISO 3745 standard.
Sound power level is measured on the rated condition in the semi-anechoic rooms by ISO 9614 standard.
Therefore, these values can be increased owing to ambient conditions during operation.
- Capacities are net capacities and based on the following conditions. Refer to the Outdoor Unit Specifications for calculating the real capacity.
 - Cooling : Indoor Ambient Temp. 27°CDB / 19°CWB, Outdoor Ambient Temp. 35°CDB / 24°CWB
 - Heating : Indoor Ambient Temp. 20°CDB / 15°CWB, Outdoor Ambient Temp. 7°CDB / 6°CWB
 - Interconnected Pipe is standard length and difference of Elevation (Outdoor ~ Indoor Unit) is 0m.
- Refrigerant information (type, additional charging amount, etc.) must be applied by refrigerant type of the combined outdoor unit.
Adapt after checking the specifications of outdoor unit.

2. Specifications

Model Name		Unit	ARNU21GL6G4	ARNU24GL6G4
Cooling Capacity	Rated	kW	6.3	7.1
		kcal/h	5,400	6,100
		Btu/h	21,500	24,200
Heating Capacity	Rated	kW	7.1	8
		kcal/h	6,100	6,900
		Btu/h	24,200	27,300
Power Input	H/M/L	W	65 / 50 / 42	81 / 59 / 43
Running Current	H/M/L	A	0.55 / 0.42 / 0.36	0.68 / 0.50 / 0.35
Indoor Fan	Type	-	Sirocco Fan	Sirocco Fan
	Air Flow Rate(H/M/L)	m ³ /min	17.5 / 14.0 / 12.0	20.0 / 16.0 / 12.0
	External Static Pressure (Factory Set)	mmAq(Pa)	1 (10)	1 (10)
	External Static Pressure (Min ~ Max)	mmAq (Pa)	0(0) ~ 5(49)	0(0) ~ 5(49)
Indoor Fan Motor	Type	-	BLDC	BLDC
	Drive	-	Direct	Direct
	Output	W x No.	19 x 2	19 x 2
	FLA(Full Load Ampere)	A	0.97	0.97
Heat Exchanger	(Rows x Columns x FPI) x No.	-	(2 x 6 x 18) x 2	(2 x 6 x 18) x 2
	Face Area	m ²	0.22	0.22
Dimensions	Net(W x H x D)	mm	1,100 x 190 x 460	1,100 x 190 x 460
	Shipping(W x H x D)	mm	1,325 x 255 x 561	1,325 x 255 x 561
Weight	Net	kg(lbs)	21.2(46.7)	21.2(46.7)
	Shipping	kg(lbs)	25.4(56.0)	25.4(56.0)
Exterior	Color(RAL Code)	-	-	-
Air Filter	Type	-	Pre Filter	Pre Filter
Temperature Control	-	-	Microprocessor Thermostat for cooling and heating	
Sound Absorbing / Thermal Insulation Material	-	-	Foamed polystyrene	
Safety Device	-	-	Fuse	Fuse
Refrigerant	Type	-	R410A/R32	R410A/R32
	Additional Charging Amount (CF Value of IDU)	kg(each)	0.25/0.22	0.25/0.22
	Control Type	-	EEV	EEV
Drain Pipe	O.D / I.D	mm(inch)	-/25.4(1)	-/25.4(1)
Piping Connection	Liquid	mm(inch)	9.52(3/8)	9.52(3/8)
	Gas	mm(inch)	15.88(5/8)	15.88(5/8)
	Connection Type(Liquid)	-	Flare	Flare
	Connection Type(Gas)	-	Flare	Flare
Sound Pressure Level (H / M / L)	-	dB(A)	35.0 / 30.0 / 29.0	36.0 / 33.0 / 29.0
Sound Power Level (H / M / L, Body)	-	dB(A)	42.5 / 38.3 / 36.0	45.0 / 40.7 / 36.0
Power Supply	-	V, Φ , Hz	220 - 230 - 240, 1,50/60	220 - 230 - 240, 1,50/60
	Running Current by voltage	A	0.57 - 0.55 - 0.52	0.71 - 0.68 - 0.66
Transmission Cable	-	mm ² x cores	1.0~1.5 x 2C	1.0~1.5 x 2C

Note

- Due to our policy of innovation some specifications may be changed without notification.
- Wiring cable size must comply with the applicable local and national code. And "Electric characteristics" chapter should be considered for electrical work and design. Especially the power cable and circuit breaker should be selected in accordance with that.
- Sound pressure level is measured on the rated condition in the anechoic rooms by ISO 3745 standard.
Sound power level is measured on the rated condition in the semi-anechoic rooms by ISO 9614 standard.
Therefore, these values can be increased owing to ambient conditions during operation.
- Capacities are net capacities and based on the following conditions. Refer to the Outdoor Unit Specifications for calculating the real capacity.
 - Cooling : Indoor Ambient Temp. 27°CDB / 19°CWB, Outdoor Ambient Temp. 35°CDB / 24°CWB
 - Heating : Indoor Ambient Temp. 20°CDB / 15°CWB, Outdoor Ambient Temp. 7°CDB / 6°CWB
 - Interconnected Pipe is standard length and difference of Elevation (Outdoor ~ Indoor Unit) is 0m.
- Refrigerant information (type, additional charging amount, etc.) must be applied by refrigerant type of the combined outdoor unit.
Adapt after checking the specifications of outdoor unit.

3. Dimensions & Gravity point

3.1 Dimensional Drawings

ARNU05GL4G4 / ARNU07GL4G4 / ARNU09GL4G4

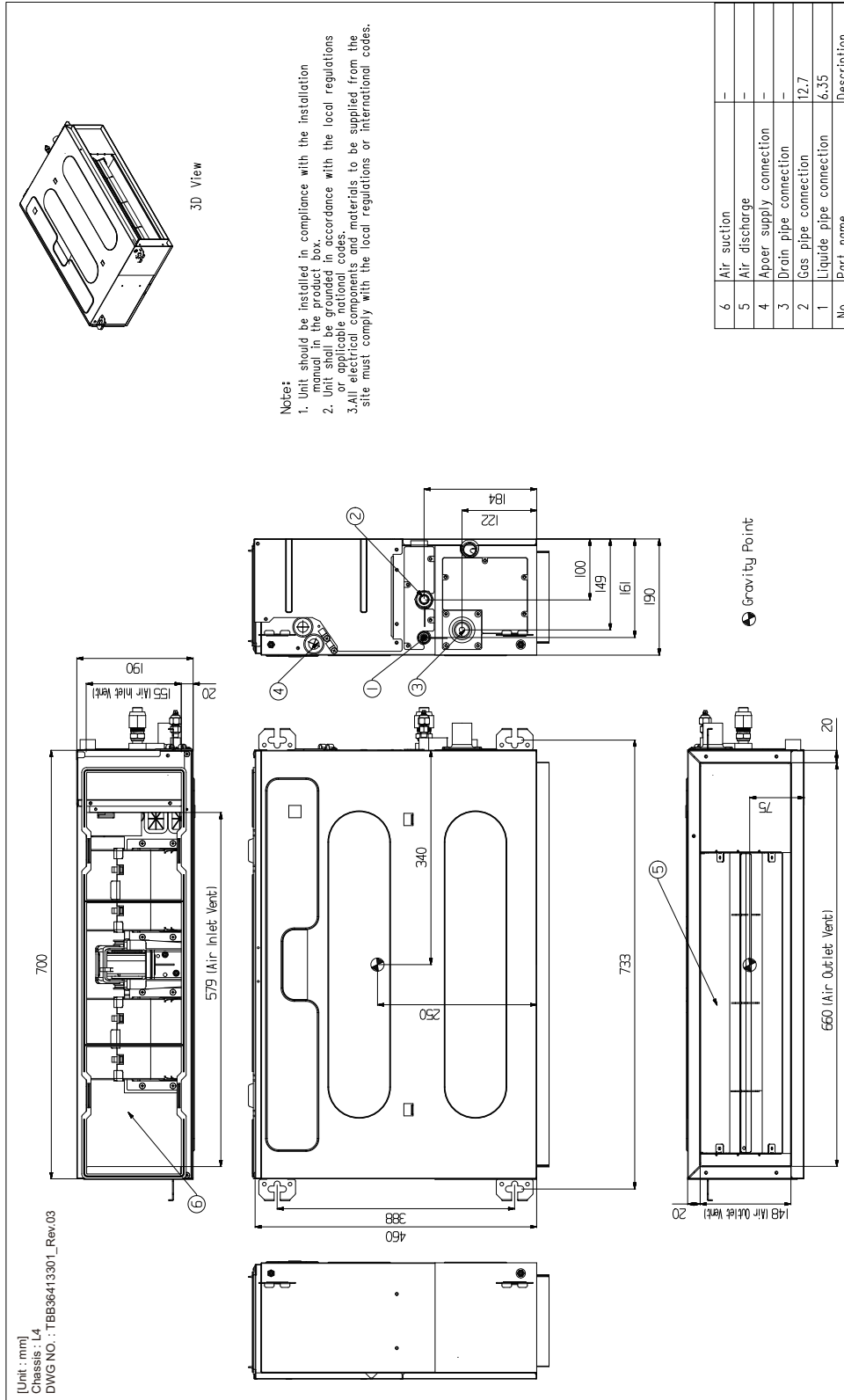

3. Dimensions & Gravity point

ARNU12GL5G4 / ARNU15GL5G4 / ARNU18GL5G4

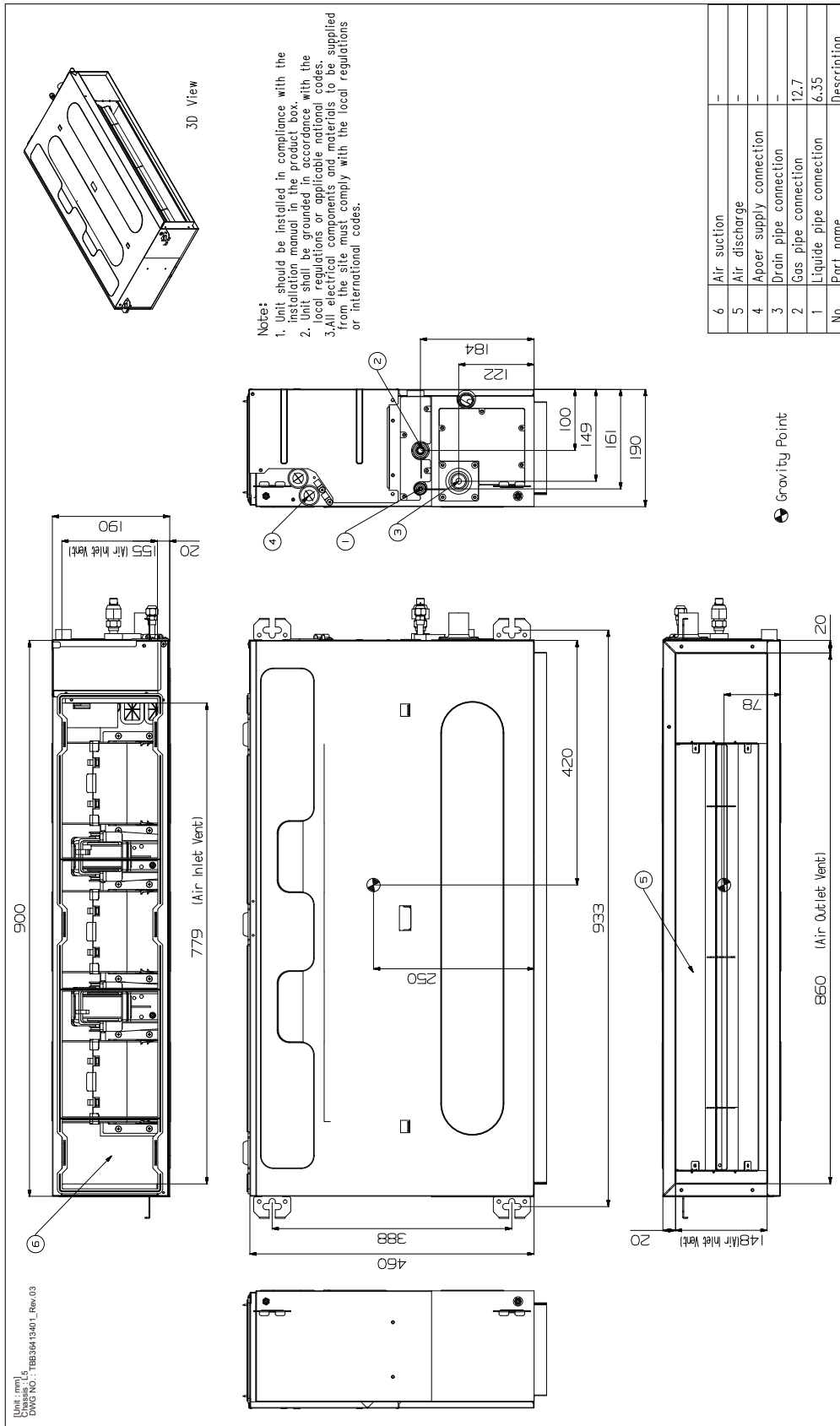

Unit : mm)
 Chassis : L5
 DWG NO. : TBS56413401_Rev.03

3. Dimensions & Gravity point

ARNU21GL6G4 / ARNU24GL6G4

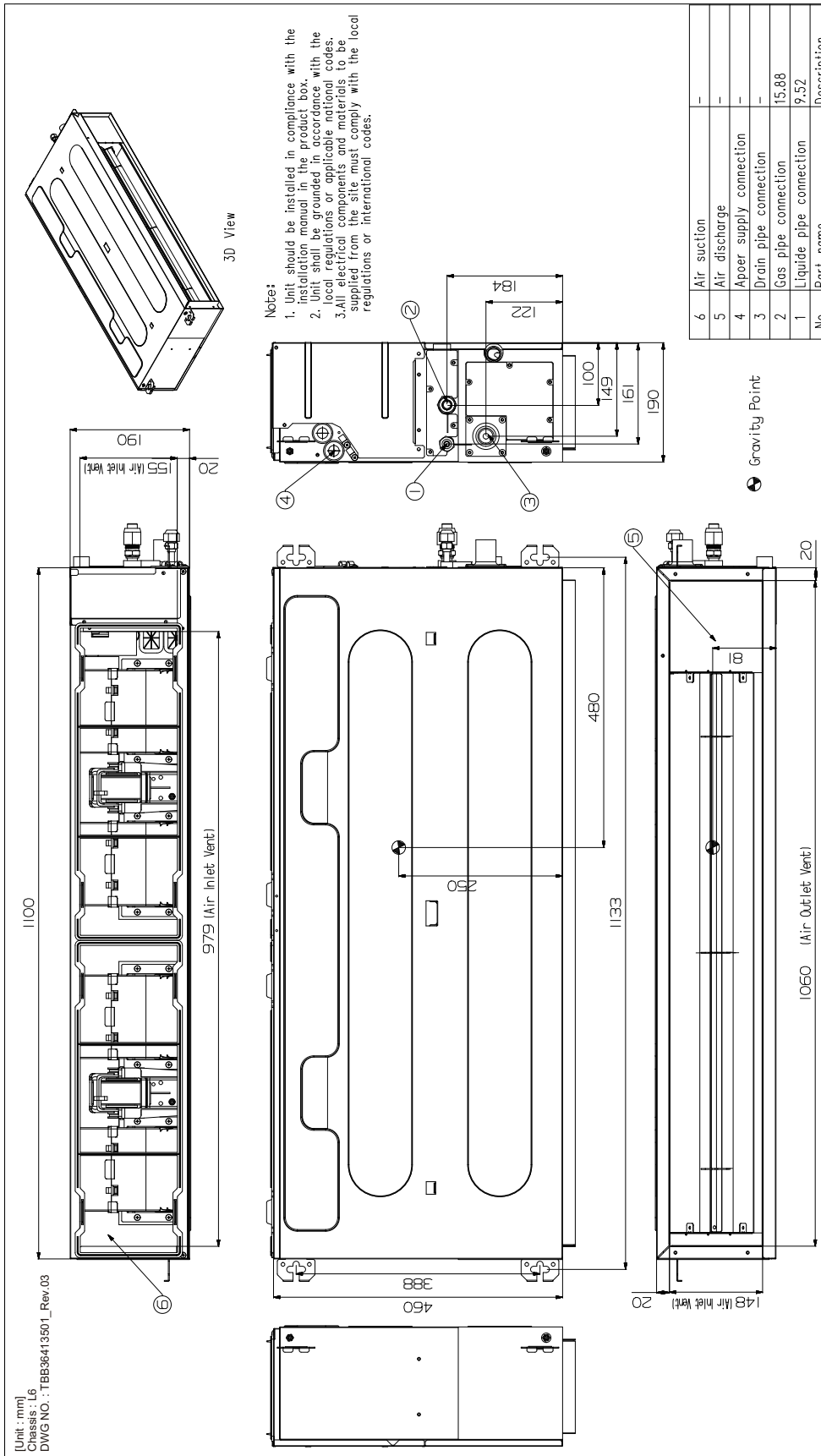

3. Dimensions & Gravity point

3.2 Installation Space

Top view

[Unit: mm(inch)]

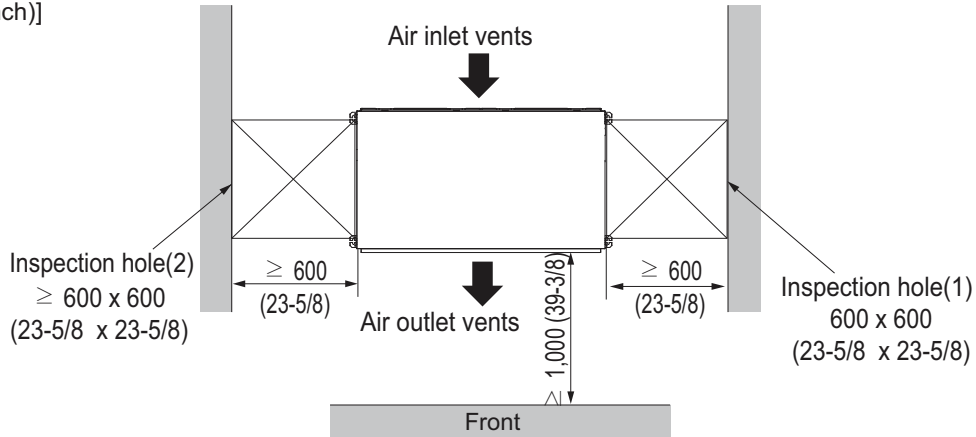

* If distance between false ceiling and actual ceiling is more than 100cm (39-3/8 inch), the number of inspection hole could be decreased to 1. But if that is less than 20cm (7-7/8 inch), the hole size should be more than size of Indoor Unit.

Front view

[Unit: mm(inch)]

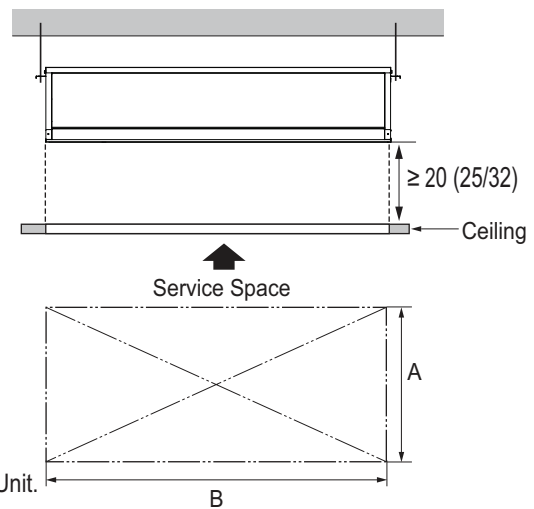
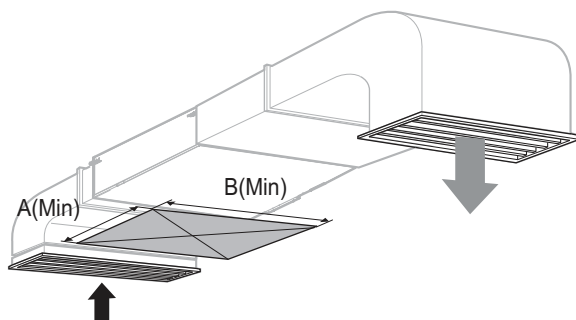

* If distance between false ceiling and actual ceiling is less than 20cm (7-7/8 inch), the hole size should be more than size of Indoor Unit.

* These figures are representative. Actual appearance of indoor unit may be different but clearances will stay the same.

Note

- Places where products are installed should not be any obstacles to the air circulation or installation. Ensure the spaces from the wall, ceiling, or other obstacles.
- According to type of indoor unit, external appearance or installed structure could be different.
- According to product type, model line up, sales region..etc, applicability of each chassis could be different.

4. Piping Diagrams

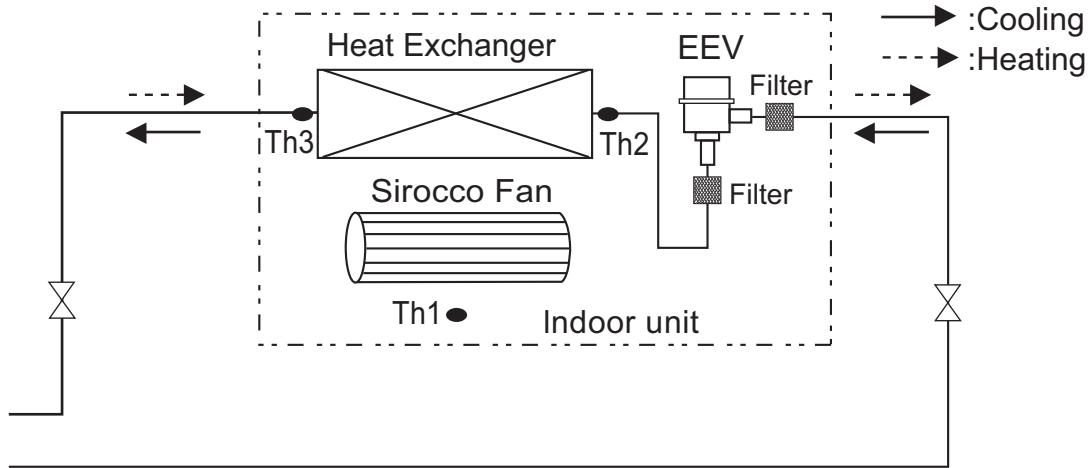

◆ Refrigerant pipe connection port diameter

Model	Gas [mm(inch)]	Liquid [mm(inch)]
ARNU05GL4G4	Ø12.7(1/2)	Ø6.35(1/4)
ARNU07GL4G4	Ø12.7(1/2)	Ø6.35(1/4)
ARNU09GL4G4	Ø12.7(1/2)	Ø6.35(1/4)
ARNU12GL5G4	Ø12.7(1/2)	Ø6.35(1/4)
ARNU15GL5G4	Ø12.7(1/2)	Ø6.35(1/4)
ARNU18GL5G4	Ø12.7(1/2)	Ø6.35(1/4)
ARNU21GL6G4	Ø15.88(5/8)	Ø9.52(3/8)
ARNU24GL6G4	Ø15.88(5/8)	Ø9.52(3/8)

LOC.	Description
Th1	Thermistor for room air temperature
Th2	Thermistor for pipe in temperature
Th3	Thermistor for pipe out temperature

5. Wiring Diagrams

L4 Chassis

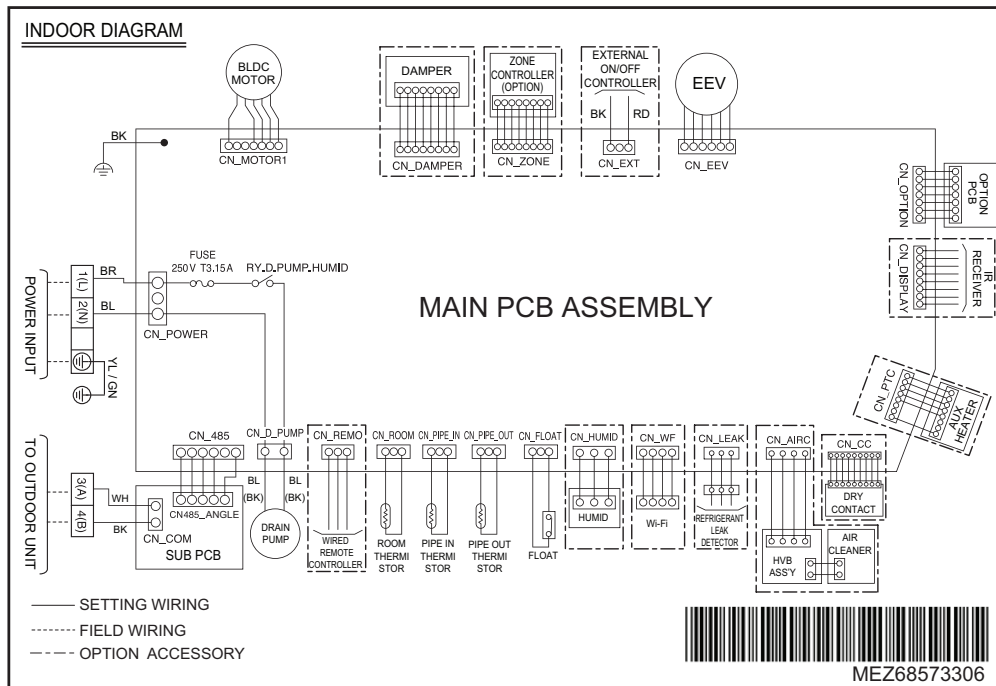

CONNECTOR NUMBER	SPEC.	DESCRIPTION
CN-MOTOR1	Fan motor output	Motor output of BLDC
CN-MOTOR2	Fan motor output	Motor output of BLDC
CN-PIPE_OUT	Discharge pipe sensor	Pipe out thermistor
CN-PIPE_IN	Suction pipe sensor	Pipe in thermistor
CN-ROOM	Room sensor	Room thermistor
CN-REMO	Remote controller	Remote control line
CN-FLOAT	Float switch input	Float switch sensing
CN-EEV	EEV Output	EEV Control output : connect to EEV directly or through IPM(Independent Power Module)
CN-LEAK	Refrigerant leak detector	Refrigerant leak detector line
CN-D_PUMP	Drain pump output	AC output for drain pump
CN-OPTION	Option PWB.	Communication between main and option
CN-COM	Communication	Communication between indoor and outdoor
CN-POWER	AC power supply	AC power line input for indoor controller
CN-ZONE	Zone Controller	Zone control line
CN-DISPLAY	RF Remote controller	RF remote control line
CN-CC	Dry contact	Dry contact line
CN-EXT	External On/Off	External On/Off signal input
CN_WF	Wi-Fi Controller	Wifi control line
CN_HUMID	Humidity sensor	Humid sensing

5. Wiring Diagrams

	Function	Description	Setting Off	Setting On	Default
SW1	Communication	N/A (Default)	-	-	Off
SW2	Cycle	N/A (Default)	-	-	Off
SW3	Group Control	Selection of Master or Slave	Master	Slave	Off
SW4	Dry Contact Mode	Selection of Dry Contact Mode	Wired/Wireless remote controller selection of Manual or Auto operation Mode	Auto	Off
SW5	Installation	Fan continuous operation	Continuous operation Removal	-	Off
SW6	Heater linkage	N/A	-	-	Off
SW7	Ventilator linkage	Selection of Ventilator linkage	Linkage Removal	Working	Off
	Vane selection (Console)	Selection of up/down side Vane	Up side + Down side Vane	Up side Vane Only	
	Region selection	Selection tropical region	General model	Tropical model	
SW8	Etc.	Spare	-	-	Off

CAUTION

For Multi V Models, DIP switch 1, 2, 6, 8 must be set OFF.

5. Wiring Diagrams

L5/6 Chassis

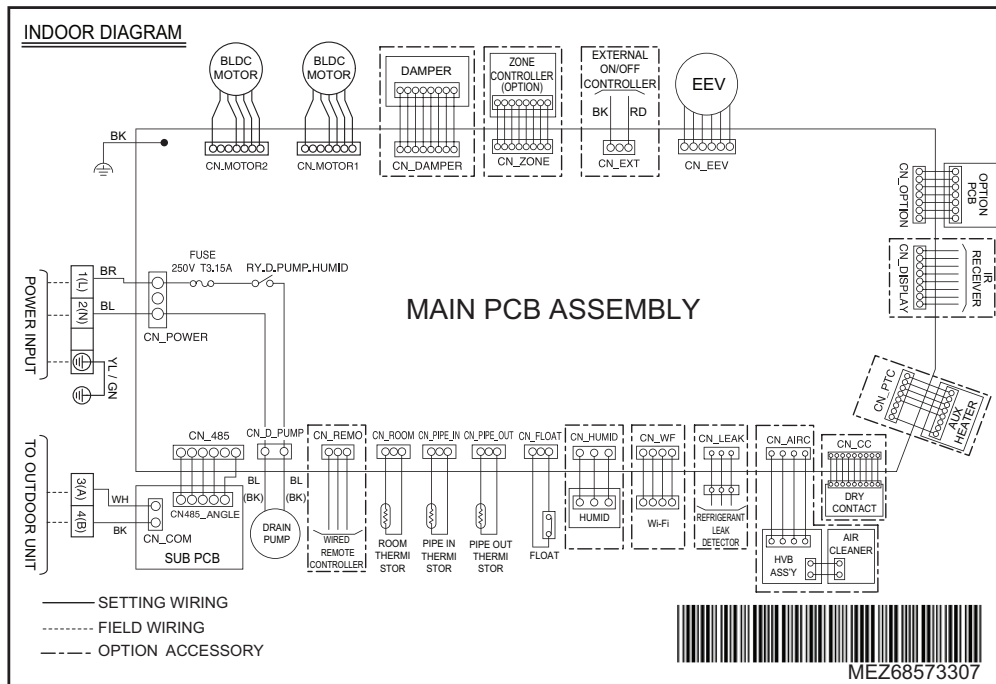

CONNECTOR NUMBER	SPEC.	DESCRIPTION
CN-MOTOR1	Fan motor output	Motor output of BLDC
CN-MOTOR2	Fan motor output	Motor output of BLDC
CN-PIPE_OUT	Discharge pipe sensor	Pipe out thermistor
CN-PIPE_IN	Suction pipe sensor	Pipe in thermistor
CN-ROOM	Room sensor	Room thermistor
CN-REMO	Remote controller	Remote control line
CN-FLOAT	Float switch input	Float switch sensing
CN-EEV	EEV Output	EEV Control output : connect to EEV directly or through IPM(Independent Power Module)
CN-LEAK	Refrigerant leak detector	Refrigerant leak detector line
CN-D_PUMP	Drain pump output	AC output for drain pump
CN-OPTION	Option PWB.	Communication between main and option
CN-COM	Communication	Communication between indoor and outdoor
CN-POWER	AC power supply	AC power line input for indoor controller
CN-ZONE	Zone Controller	Zone control line
CN-DISPLAY	RF Remote controller	RF remote control line
CN-CC	Dry contact	Dry contact line
CN-EXT	External On/Off	External On/Off signal input
CN_WF	Wi-Fi Controller	Wifi control line
CN_HUMID	Humidity sensor	Humid sensing

5. Wiring Diagrams

	Function	Description	Setting Off	Setting On	Default
SW1	Communication	N/A (Default)	-	-	Off
SW2	Cycle	N/A (Default)	-	-	Off
SW3	Group Control	Selection of Master or Slave	Master	Slave	Off
SW4	Dry Contact Mode	Selection of Dry Contact Mode	Wired/Wireless remote controller selection of Manual or Auto operation Mode	Auto	Off
SW5	Installation	Fan continuous operation	Continuous operation Removal	-	Off
SW6	Heater linkage	N/A	-	-	Off
SW7	Ventilator linkage	Selection of Ventilator linkage	Linkage Removal	Working	Off
	Vane selection (Console)	Selection of up/down side Vane	Up side + Down side Vane	Up side Vane Only	
	Region selection	Selection tropical region	General model	Tropical model	
SW8	Etc.	Spare	-	-	Off

CAUTION

For Multi V Models, DIP switch 1, 2, 6, 8 must be set OFF.

6. Capacity Tables

■ Cooling Capacity

Capacity Index	Indoor air temp. (DB/WB, °C)													
	20		23		26		27		28		30		32	
	14		16		18		19		20		22		24	
	TC	SHC	TC	SHC	TC	SHC	TC	SHC	TC	SHC	TC	SHC	TC	SHC
1.6	1.2	1.2	1.4	1.3	1.7	1.4	1.8	1.5	1.9	1.5	2.0	1.4	2.0	1.3
2.2	1.5	1.4	1.8	1.5	2.0	1.6	2.2	1.7	2.4	1.7	2.4	1.6	2.4	1.5
2.8	1.9	1.8	2.2	1.9	2.6	2.1	2.8	2.1	3.0	2.2	3.0	2.1	3.1	1.9
3.6	2.4	2.2	2.9	2.4	3.3	2.6	3.6	2.6	3.9	2.7	3.9	2.6	4.0	2.4
4.5	3.0	2.7	3.6	3.0	4.2	3.2	4.5	3.3	4.8	3.4	4.9	3.2	4.9	3.0
5.6	3.8	3.4	4.5	3.7	5.2	4.0	5.6	4.1	6.0	4.2	6.1	4.0	6.2	3.7
6.2	4.3	3.9	5.1	4.3	5.9	4.7	6.3	4.8	6.7	5.0	6.8	4.7	6.9	4.3
7.1	4.8	4.4	5.7	4.9	6.6	5.3	7.1	5.4	7.6	5.6	7.7	5.3	7.8	4.9

Note

1. TC: Total Capacity(kW), SHC: Sensible Heat Capacity(kW)
2. Capacity tables show the average value of conditions which may occur.
3. Refer to Capacity tables and correction factor in the outdoor unit PDB for the actual performance data of each indoor unit and outdoor unit combination.

■ Heating Capacity

Capacity Index	Indoor air temp. (DB, °C)					
	16	18	20	21	22	24
	TC	TC	TC	TC	TC	TC
1.6	2.5	2.3	2.2	2.1	2.1	1.9
2.2	2.8	2.7	2.5	2.4	2.3	2.2
2.8	3.6	3.4	3.2	3.1	3.0	2.8
3.6	4.5	4.3	4.0	3.9	3.7	3.5
4.5	5.6	5.3	5.0	4.8	4.7	4.4
5.6	7.1	6.7	6.3	6.1	5.9	5.5
6.2	8.0	7.6	7.1	6.9	6.6	6.2
7.1	9.0	8.5	8.0	7.7	7.5	7.0

Note

1. TC: Total Capacity(kW)
2. Capacity tables show the average value of conditions which may occur.
3. Refer to Capacity tables and correction factor in the outdoor unit PDB for the actual performance data of each indoor unit and outdoor unit combination.

7. External Static Pressure (E.S.P) & Air Flow

◆ ARNU05GL4G4, ARNU07GL4G4, ARNU09GL4G4

Setting Value	Static Pressure(mmAq(Pa))					
	0 (0)	1 (10)	2 (20)	3 (29)	4 (39)	5 (49)
	Air Flow Rate (m³/min)					
60	-	-	-	-	-	-
65	5.03	-	-	-	-	-
70	5.60	4.85	-	-	-	-
75	6.19	5.44	4.57	-	-	-
80	6.79	6.05	5.17	-	-	-
85	7.41	6.67	5.80	4.80	-	-
90	8.05	7.31	6.43	5.44	-	-
95	8.71	7.96	7.09	6.09	4.97	-
100	9.38	8.63	7.76	6.76	5.64	-
105	10.07	9.32	8.45	7.45	6.33	5.08
110	-	10.03	9.16	8.16	7.04	5.79
115	-	-	9.88	8.88	7.76	6.51
120	-	-	-	9.62	8.50	7.25
125	-	-	-	10.38	9.26	8.01
130	-	-	-	-	10.03	8.78

Note

1. The above table shows the correlation between the air rates and E.S.P.
2. The above table shows the available E.S.P. range.
3. If the E.S.P. of the installed indoor is less than the lowest value(as mention in the table), indoor components can be failed.

◆ Fan Performance (ARNU05GL4G4, ARNU07GL4G4, ARNU09GL4G4)

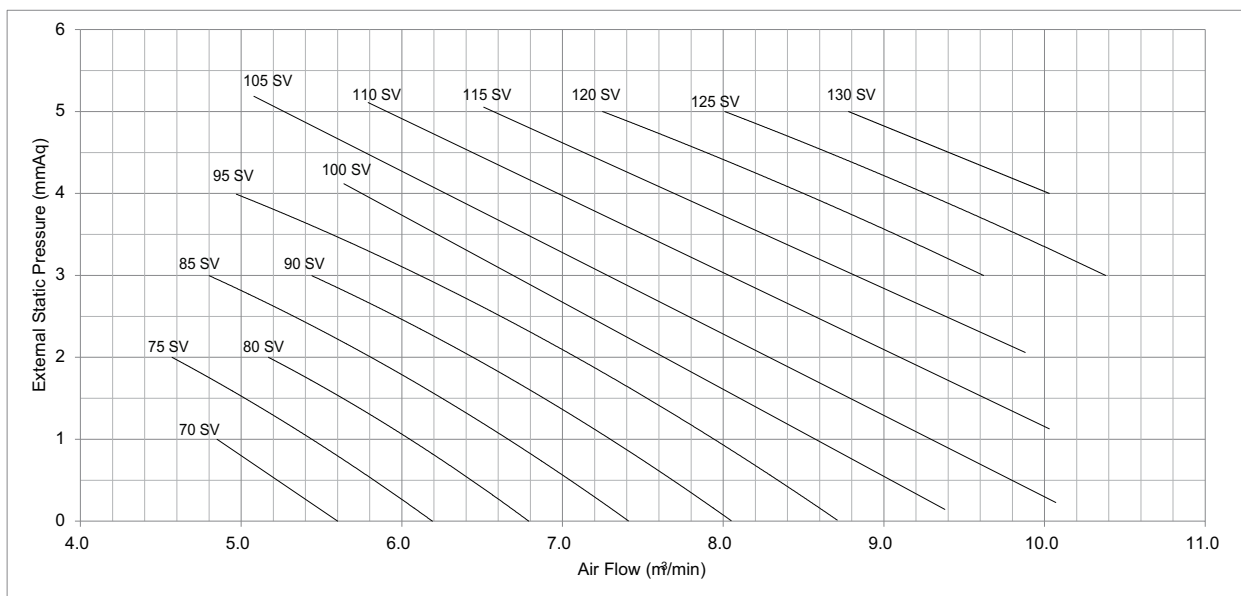

7. External Static Pressure (E.S.P) & Air Flow

◆ ARNU12GL5G4, ARNU15GL5G4, ARNU18GL5G4

Setting Value	Static Pressure(mmAq(Pa))					
	0 (0)	1 (10)	2 (20)	3 (29)	4 (39)	5 (49)
	Air Flow Rate (m³/min)					
75	6.50	-	-	-	-	-
80	7.34	6.70	-	-	-	-
85	8.20	7.55	6.69	-	-	-
90	9.07	8.43	7.56	6.47	-	-
95	9.96	9.32	8.45	7.36	-	-
100	10.87	10.22	9.36	8.27	6.96	-
105	11.79	11.15	10.28	9.19	7.89	6.35
110	12.73	12.09	11.22	10.14	8.83	7.30
115	13.69	13.05	12.18	11.09	9.78	8.25
120	14.67	14.02	13.16	12.07	10.76	9.23
125	15.66	15.01	14.15	13.06	11.75	10.22
130	16.67	16.02	15.16	14.07	12.76	11.23
135	-	-	16.18	15.10	13.79	12.26
140	-	-	-	16.14	14.83	13.30
145	-	-	-	-	15.89	14.36

Note

1. The above table shows the correlation between the air rates and E.S.P.
2. The above table shows the available E.S.P. range.
3. If the E.S.P. of the installed indoor is less than the lowest value(as mention in the table), indoor components can be failed.

◆ Fan Performance (ARNU12GL5G4, ARNU15GL5G4, ARNU18GL5G4)

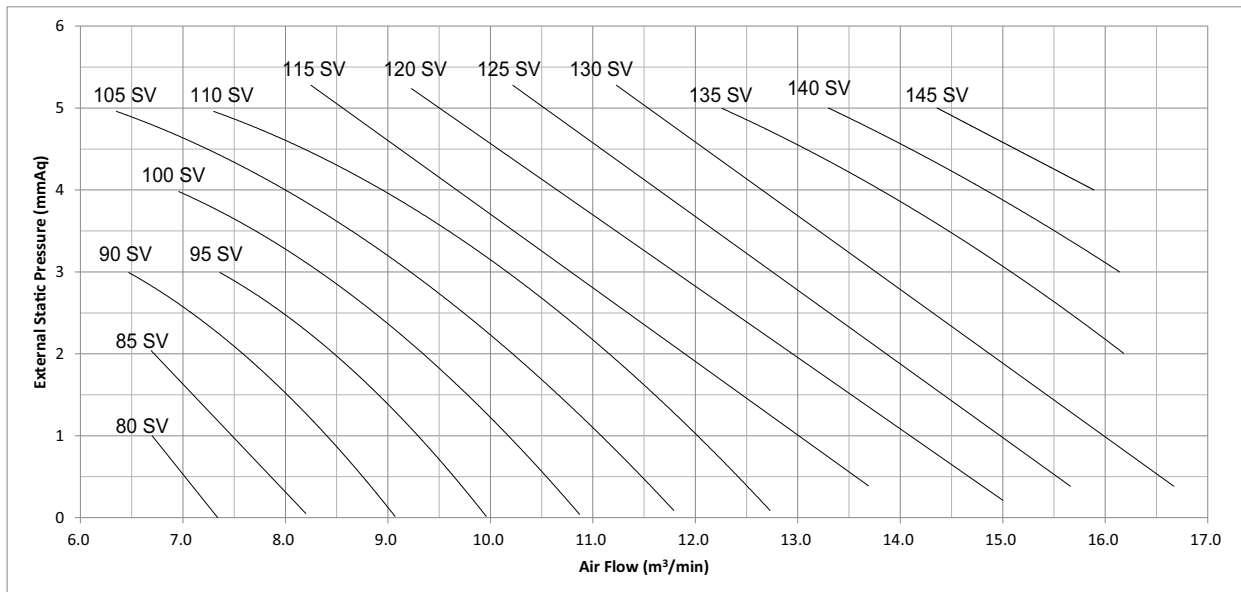

7. External Static Pressure (E.S.P) & Air Flow

◆ ARNU21GL6G4, ARNU24GL6G4

Setting Value	Static Pressure(mmAq(Pa))					
	0 (0)	1 (10)	2 (20)	3 (29)	4 (39)	5 (49)
	Air Flow Rate (m ³ /min)					
85	10.19	-	-	-	-	-
90	12.18	10.97	10.70	-	-	-
95	13.81	12.34	12.19	-	-	-
100	15.16	13.69	13.38	10.71	-	-
105	16.30	14.83	14.36	11.85	-	-
110	17.31	15.85	15.23	12.86	10.97	-
115	18.27	16.80	16.07	13.82	11.93	-
120	19.26	17.79	16.93	14.80	12.91	10.49
125	20.34	18.87	17.89	15.88	13.99	11.57
130	21.60	20.13	19.01	17.14	15.25	12.83
135	-	21.64	20.36	18.66	16.76	14.35
140	-	-	22.01	20.50	18.61	16.19

Note

1. The above table shows the correlation between the air rates and E.S.P.
2. The above table shows the available E.S.P. range.
3. If the E.S.P. of the installed indoor is less than the lowest value(as mention in the table), indoor components can be failed.

◆ Fan Performance (ARNU21GL6G4, ARNU24GL6G4)

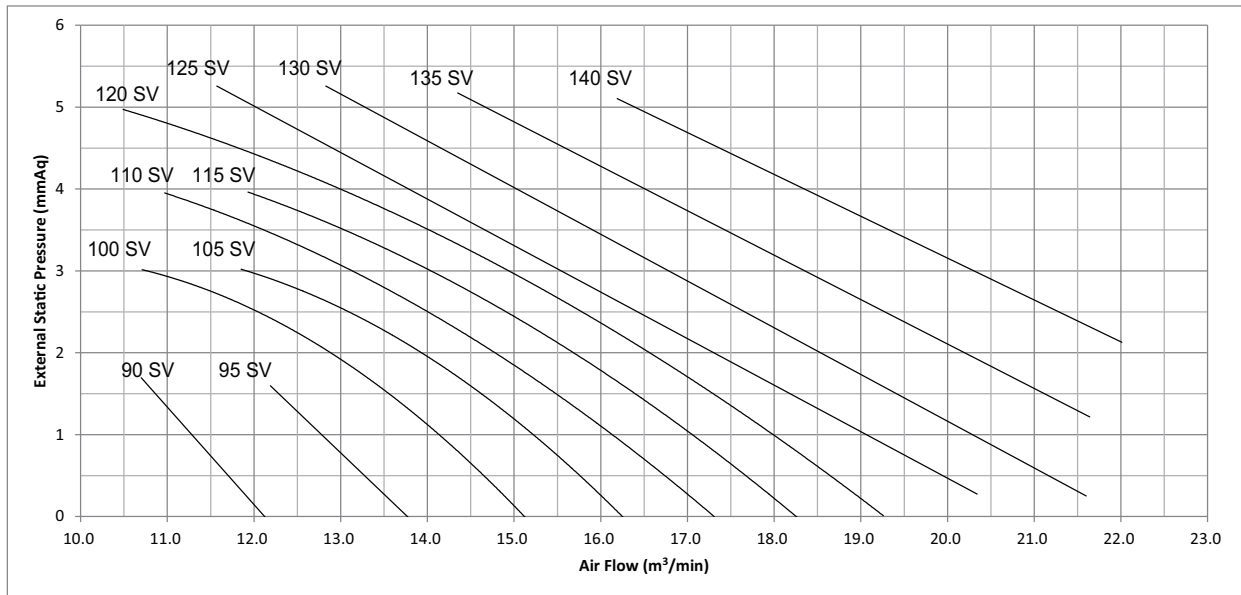

7. External Static Pressure (E.S.P) & Air Flow

◆ ARNU05GL4G4, ARNU07GL4G4, ARNU09GL4G4

Capacity	Mode		Set value	Standard ESP (mmAq(Pa))	CMM	Lower Limit of External Static Pressure(mmAq(Pa))	Upper Limit of External Static Pressure(mmAq(Pa))
5k	High (factory set)	HI	86	1 (10)	7.0	-	5(49)
		Mid	82		6.5		
		Low	76		5.5		
	Standard	HI	82	0 (0)	7.0	-	5(49)
		Mid	78		6.5		
		Low	69		5.5		
7k	High (factory set)	HI	92	1 (10)	7.5	-	5(49)
		Mid	82		6.5		
		Low	76		5.5		
	Standard	HI	86	0 (0)	7.5	-	5(49)
		Mid	78		6.5		
		Low	69		5.5		
9k	High (factory set)	HI	101	1 (10)	9.0	-	5(49)
		Mid	86		7.0		
		Low	76		5.5		
	Standard	HI	97	0 (0)	9.0	-	5(49)
		Mid	81		7.0		
		Low	69		5.5		

Note

1. The above table shows the available E.S.P. range.

◆ ARNU12GL5G4, ARNU15GL5G4, ARNU18GL5G4

Capacity	Mode		Set value	Standard ESP (mmAq(Pa))	CMM	Lower Limit of External Static Pressure(mmAq(Pa))	Upper Limit of External Static Pressure(mmAq(Pa))
12k	High (factory set)	HI	98	1 (10)	10.0	-	5(49)
		Mid	90		8.5		
		Low	84		7.0		
	Standard	HI	96	0 (0)	10.0	-	5(49)
		Mid	85		8.5		
		Low	78		7.0		
15k	High (factory set)	HI	110	1 (10)	12.5	-	5(49)
		Mid	98		10.0		
		Low	90		8.5		
	Standard	HI	109	0 (0)	12.5	-	5(49)
		Mid	96		10.0		
		Low	87		8.5		
18k	High (factory set)	HI	125	1 (10)	15.0	-	5(49)
		Mid	110		12.5		
		Low	98		10.0		
	Standard	HI	120	0 (0)	15.0	-	5(49)
		Mid	109		12.5		
		Low	96		10.0		

Note

1. The above table shows the available E.S.P. range.

7. External Static Pressure (E.S.P) & Air Flow

◆ ARNU21GL6G4, ARNU24GL6G4

Capacity	Mode		Set value	Standard ESP (mmAq(Pa))	CMM	Lower Limit of External Static Pressure(mmAq(Pa))	Upper Limit of External Static Pressure(mmAq(Pa))
21k	High (factory set)	HI	118	1 (10)	17.5	-	5(49)
		Mid	102		14.0		
		Low	94		12.0		
	Standard	HI	113	0 (0)	17.5	-	5(49)
		Mid	95		14.0		
		Low	89		12.0		
24k	High (factory set)	HI	129	1 (10)	20.0	-	5(49)
		Mid	111		16.0		
		Low	94		12.0		
	Standard	HI	125	0 (0)	20.0	-	5(49)
		Mid	102		16.0		
		Low	89		12.0		

Note

1. The above table shows the available E.S.P. range.

8. Electric Characteristics

Model	Units				Power Supply		IFM		PI	
	Type	Hz	Volts	Voltage Range	MCA	MFA	kW	FLA	Cooling	Heating
ARNU05GL4G4	L4	50	220-240	Max:264 Min:198	0.50	15	0.019	0.40	40	40
ARNU07GL4G4	L4				0.50	15	0.019	0.40	40	40
ARNU09GL4G4	L4				0.50	15	0.019	0.40	40	40
ARNU12GL5G4	L5				0.95	15	0.024	0.76	85	85
ARNU15GL5G4	L5				0.95	15	0.024	0.76	85	85
ARNU18GL5G4	L5				0.95	15	0.024	0.76	85	85
ARNU21GL6G4	L6				1.21	15	0.038	0.97	115	115
ARNU24GL6G4	L6				1.21	15	0.038	0.97	115	115
ARNU05GL4G4	L4	60	220	Max:242 Min:198	0.50	15	0.019	0.40	40	40
ARNU07GL4G4	L4				0.50	15	0.019	0.40	40	40
ARNU09GL4G4	L4				0.50	15	0.019	0.40	40	40
ARNU12GL5G4	L5				0.95	15	0.024	0.76	85	85
ARNU15GL5G4	L5				0.95	15	0.024	0.76	85	85
ARNU18GL5G4	L5				0.95	15	0.024	0.76	85	85
ARNU21GL6G4	L6				1.21	15	0.038	0.97	115	115
ARNU24GL6G4	L6				1.21	15	0.038	0.97	115	115

Symbols

MCA : Minimum Circuit Amperes (A)

MFA : Maximum Fuse Amperes (A)

kW : Fan Motor Rated Output (kW)

FLA : Full Load Amperes (A)

IFM : Indoor Fan Motor

PI : Maximum Power Input (W)

Note

1. Voltage range

Units are suitable for use on electrical systems where voltage supplied to unit terminals is not below or above the listed range limits.

2. Maximum allowable voltage unbalance between phases is 2%.

3. MCA/MFA

$$MCA = 1.25 \times FLA$$

$$MFA = 1.1 \times MCA, MFA \leq 4 \times FLA$$

(If MFA is smaller than minimum standard value, Use minimum standard value in region for selecting circuit breaker.)

4. Select wire size based on the MCA

5. Instead of fuse, use Circuit Breaker.

9. Sound Levels

9.1 Sound Pressure Levels

Overall

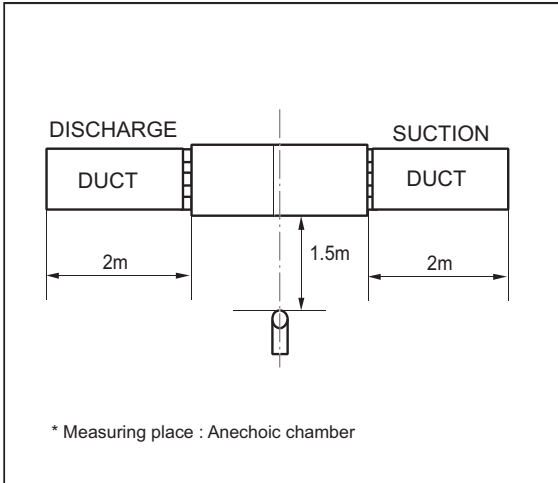

Note

1. Sound measured at some distance away from the center of the unit.
2. Data is valid at free field condition.
3. Reference acoustic pressure 0dB = 20μPa.
4. Data is valid at nominal operation condition.
Refer to the Model Specifications for nominal conditions(Power source and Ambient temperature, etc)
5. Sound levels can be increased in accordance with installation and operating conditions. (Static pressure mode, used air guide, Room target temperature setting, etc)
6. Sound level will vary depending on a range of factors such as the construction(acoustic absorption coefficient) of particular room in which the equipment is installed.
7. Sound pressure level is measured on the rated condition in the anechoic rooms by ISO 3745 standard.
Therefore, these values can be increased owing to ambient conditions during operation.

Model	Sound Pressure Levels (dB(A),H-M-L)		
	External Static Pressure (Pa)		
	10	20	50
ARNU05GL4G4	25-24-22	26-25-22	30-29-27
ARNU07GL4G4	26-24-22	26-25-22	30-29-27
ARNU09GL4G4	28-25-22	29-25-22	33-30-27
ARNU12GL5G4	29-27-25	30-28-25	34-33-30
ARNU15GL5G4	32-29-27	33-30-28	36-34-32
ARNU18GL5G4	35-32-29	35-33-30	38-37-35
ARNU21GL6G4	35-30-29	36-33-31	39-38-37
ARNU24GL6G4	36-33-29	38-34-31	41-38-37

Sound Pressure Level (10Pa)

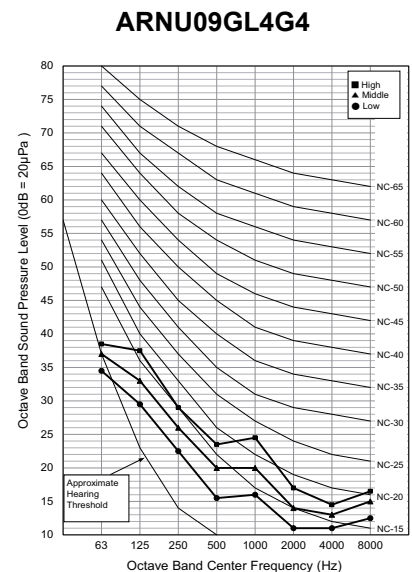
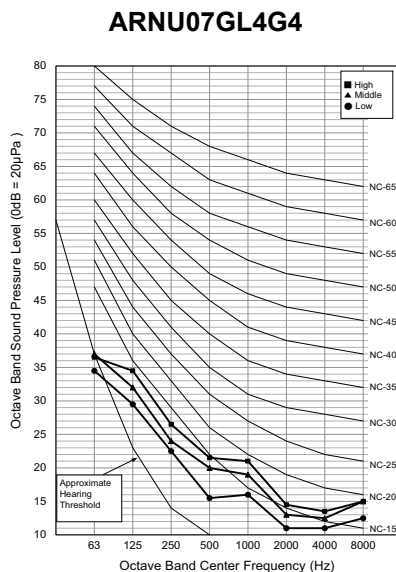
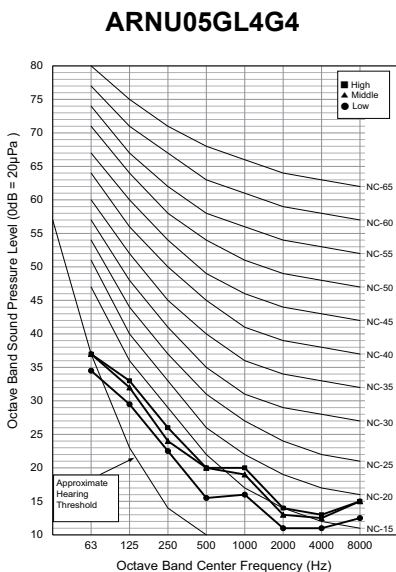

9. Sound Levels

ARNU12GL5G4

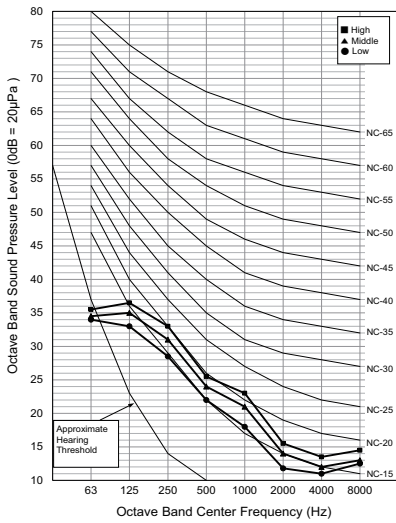

ARNU15GL5G4

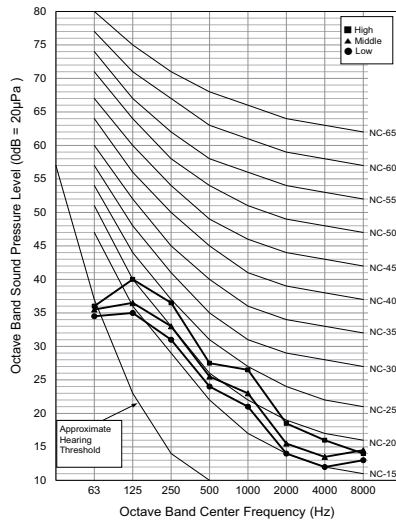

ARNU18GL5G4

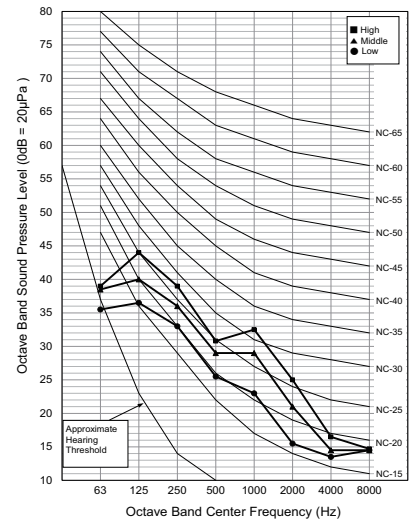

ARNU21GL6G4

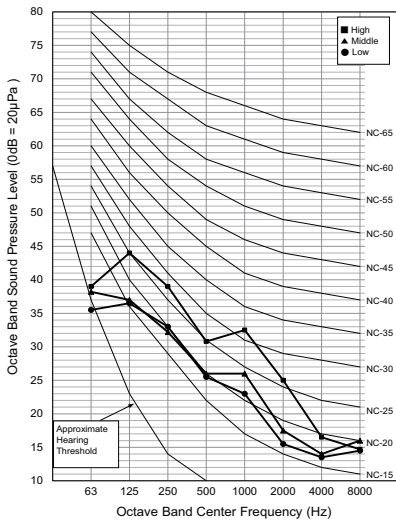

ARNU24GL6G4

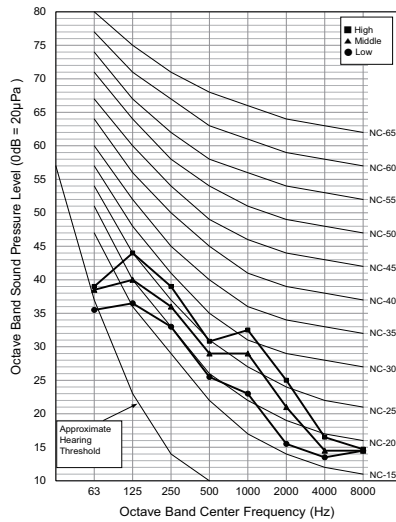

■ Sound Pressure Level (20Pa)

ARNU05GL4G4

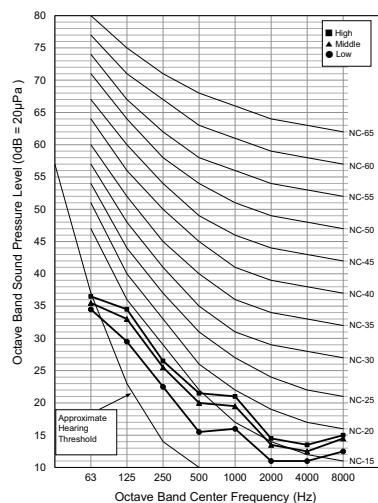

ARNU07GL4G4

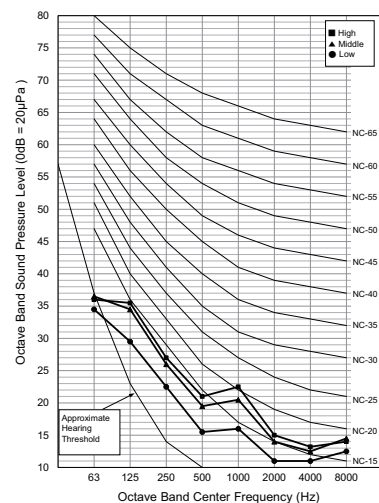

ARNU09GL4G4

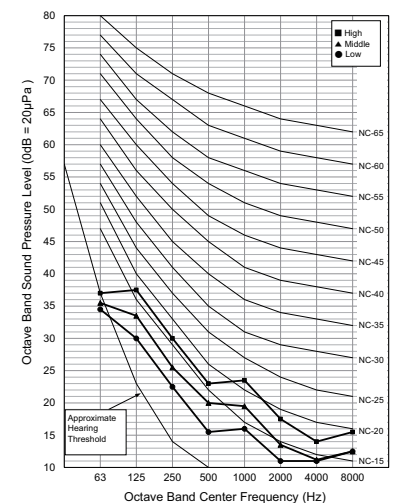

9. Sound Levels

ARNU12GL5G4

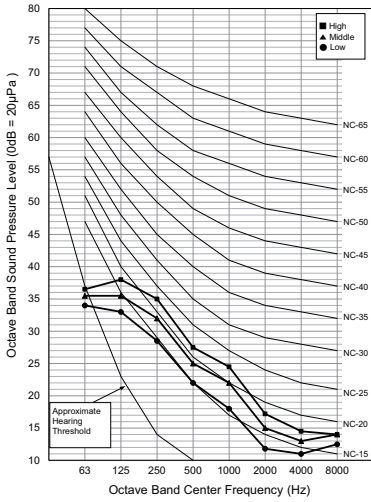

ARNU15GL5G4

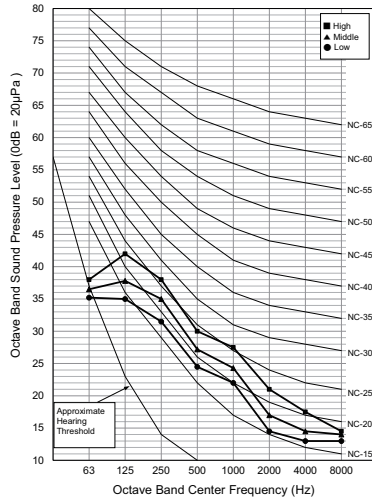

ARNU18GL5G4

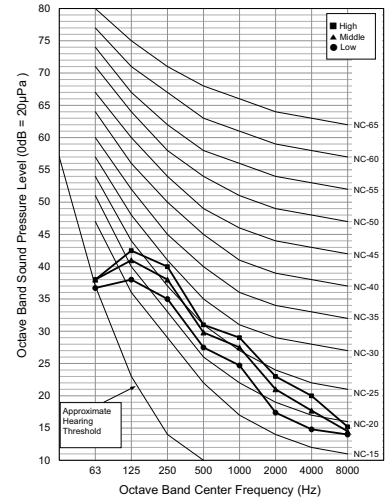

ARNU21GL6G4

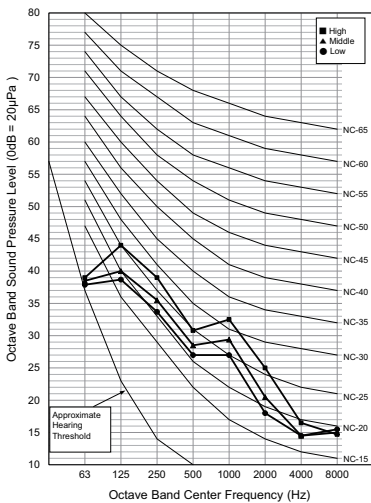

ARNU24GL6G4

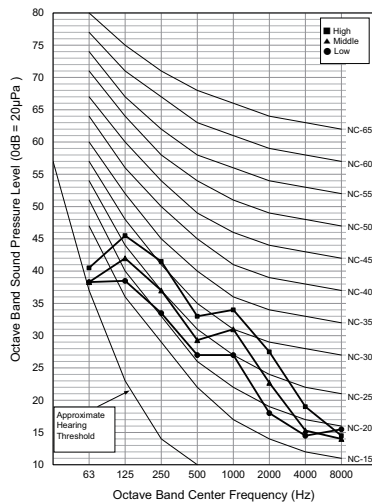

■ Sound Pressure Level (50Pa)

ARNU05GL4G4

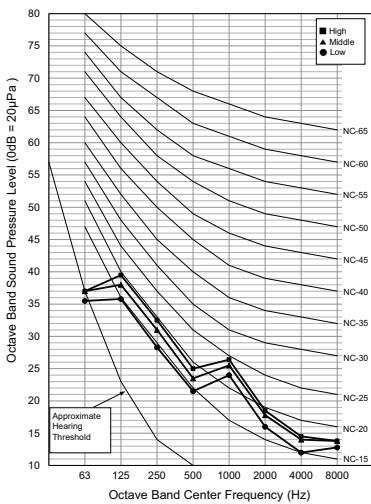

ARNU07GL4G4

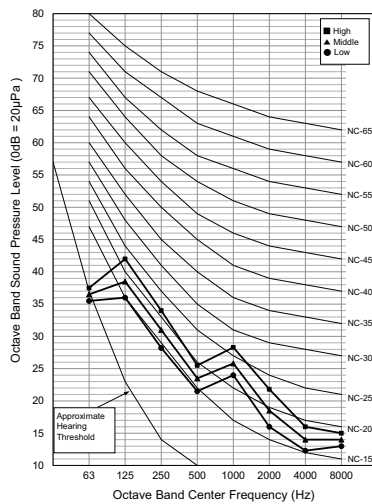

ARNU09GL4G4

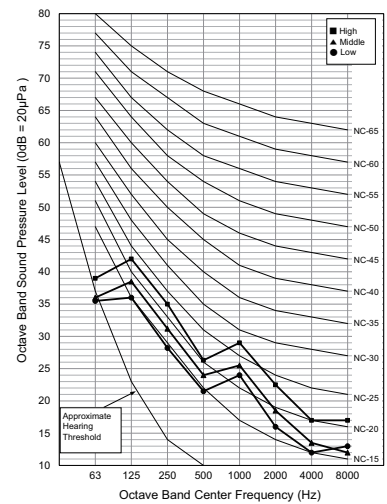

9. Sound Levels

ARNU12GL5G4

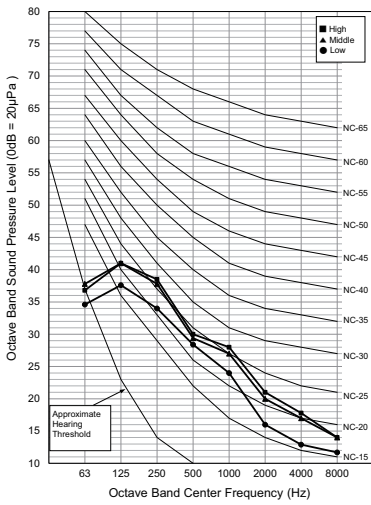

ARNU15GL5G4

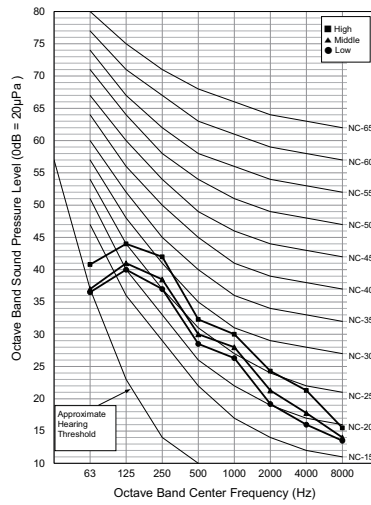

ARNU18GL5G4

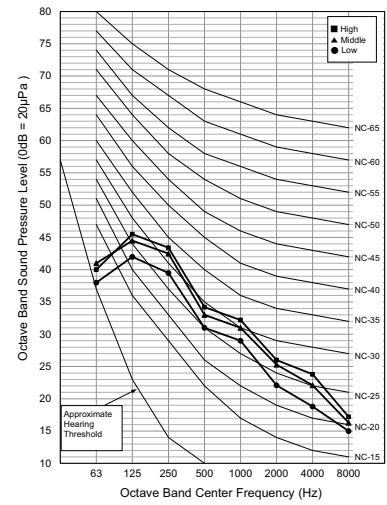

ARNU21GL6G4

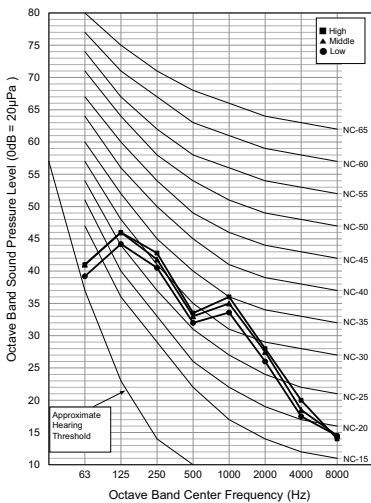

ARNU24GL6G4

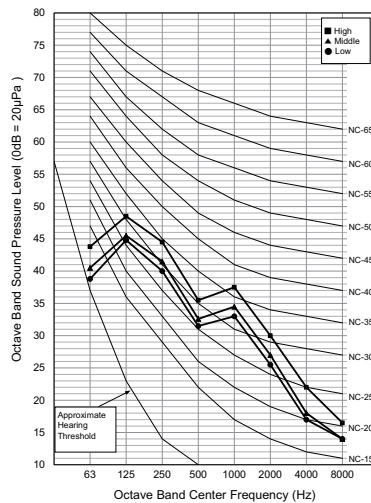

9. Sound Levels

9.2 Sound Power Levels

Note

- Data is valid at diffuse field condition
- Data is valid at nominal operating condition
- Sound level can be increased in static pressure mode or used air guide.
- Sound level will vary depending on a range of factors such as the construction (acoustic absorption coefficient) of particular room in which the equipment is installed.
- Reference acoustic intensity 0dB = $10E-6\mu W/m^2$
- Sound power level is measured on the rated condition in the semi-anechoic rooms by ISO 9614 standard. Therefore, these values can be increased owing to ambient conditions during operation.

9.2.1 Sound Power Levels (Inlet)

Model	Sound Power Levels [dB(A), Inlet(H-M-L)]			
	External Static Pressure (Pa)			
	0	10	30	50
ARNU05GL4G4	41.3-39.9-36.6	42.1-40.8-38.7	44.3-43.0-40.0	46.7-45.6-43.0
ARNU07GL4G4	42.6-39.9-36.6	44.0-40.8-38.7	45.4-43.0-40.0	48.1-45.6-43.0
ARNU09GL4G4	45.8-41.0-36.6	46.5-42.1-38.7	48.8-44.3-40.0	50.7-46.7-43.0
ARNU12GL5G4	45.4-42.1-39.8	44.3-41.7-39.6	44.9-42.2-39.2	47.9-45.3-42.6
ARNU15GL5G4	48.8-45.4-42.7	47.8-44.3-41.7	49.0-44.9-42.2	51.4-47.9-45.3
ARNU18GL5G4	51.4-48.8-45.4	51.7-47.8-44.3	52.6-49.0-44.9	53.8-51.4-47.9
ARNU21GL6G4	52.9-48.4-46.7	53.1-48.8-46.4	53.9-49.4-46.0	54.5-52.8-50.6
ARNU24GL6G4	55.5-50.2-46.7	55.7-51.3-46.4	56.1-52.2-46.0	54.5-53.7-50.6

■ Sound Power Levels (0Pa)

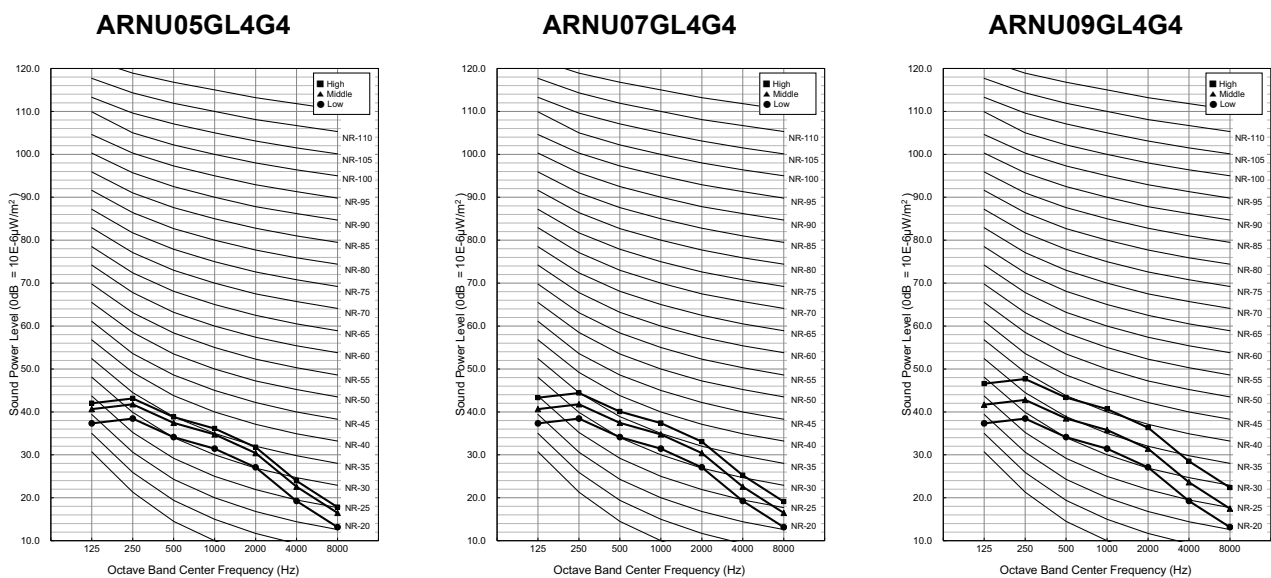

9. Sound Levels

ARNU12GL5G4

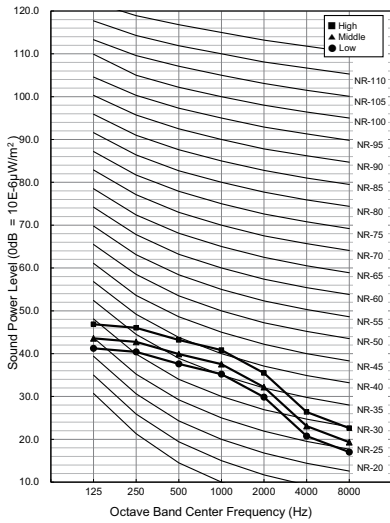

ARNU15GL5G4

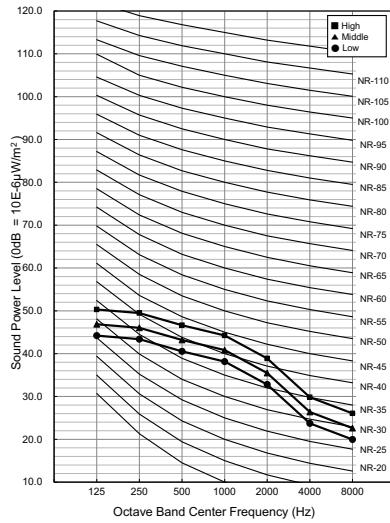

ARNU18GL5G4

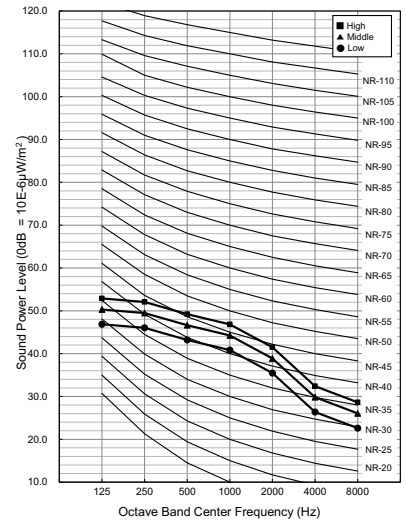

ARNU21GL6G4

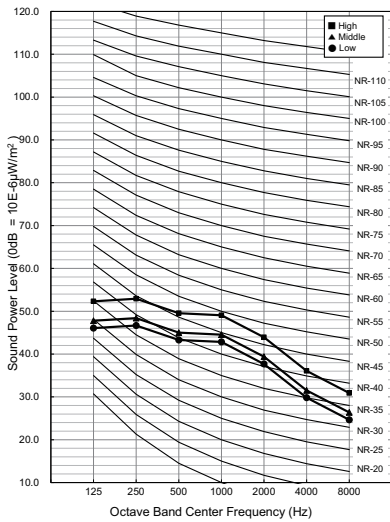

ARNU24GL6G4

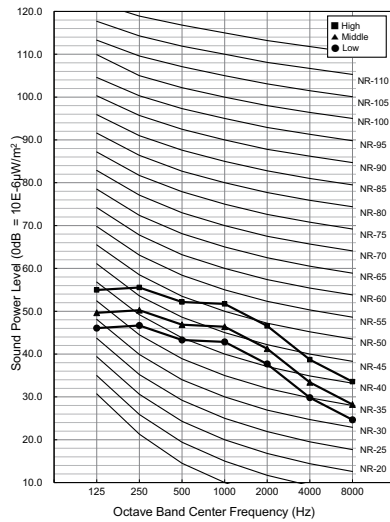

■ Sound Power Levels (10Pa)

ARNU05GL4G4

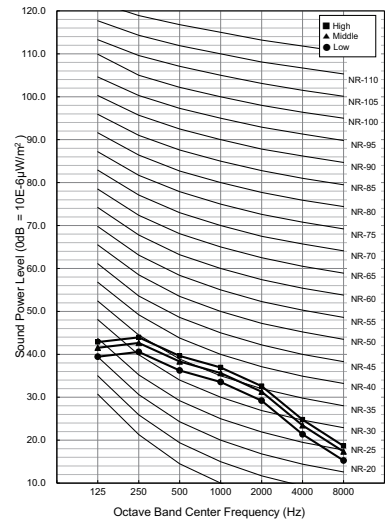

ARNU07GL4G4

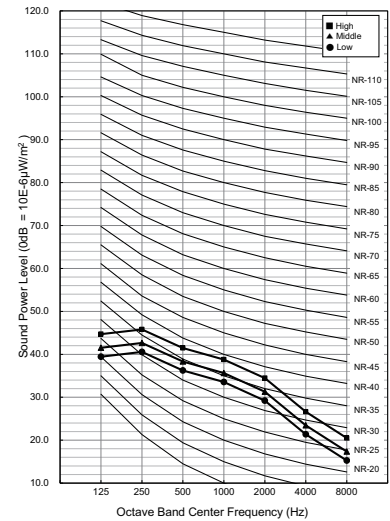

ARNU09GL4G4

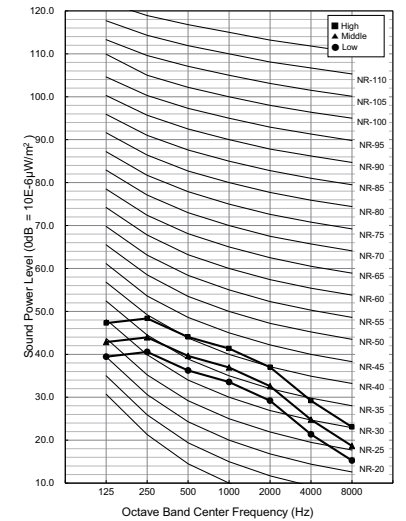

9. Sound Levels

ARNU12GL5G4

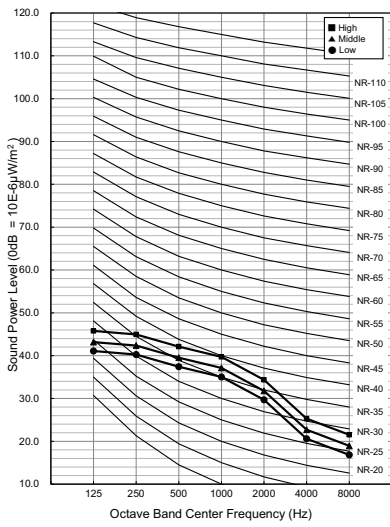

ARNU15GL5G4

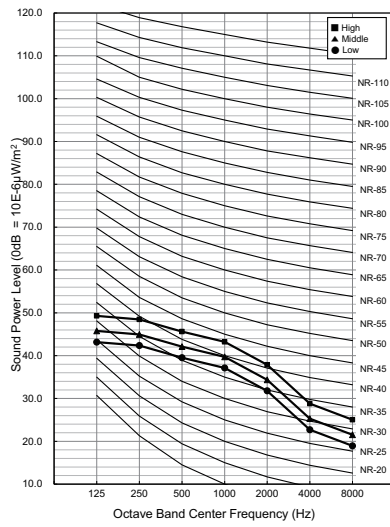

ARNU18GL5G4

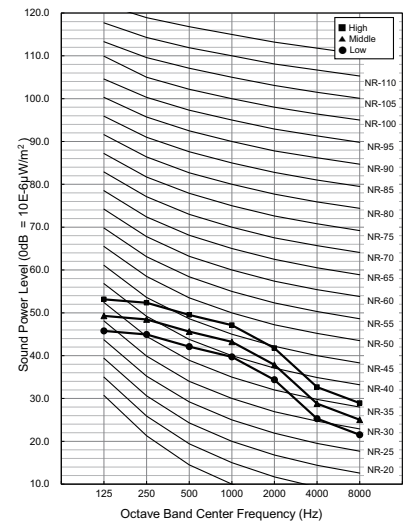

ARNU21GL6G4

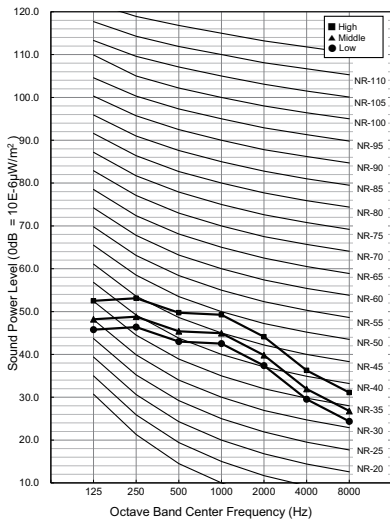

ARNU24GL6G4

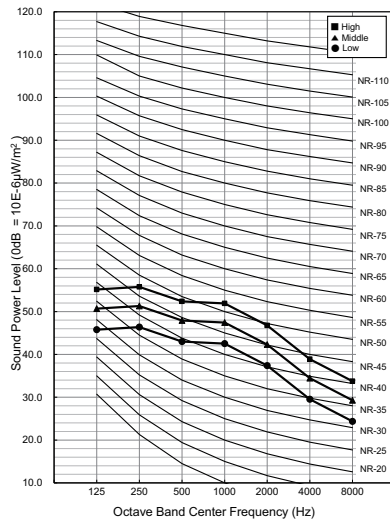

■ Sound Power Levels (30Pa)

ARNU05GL4G4

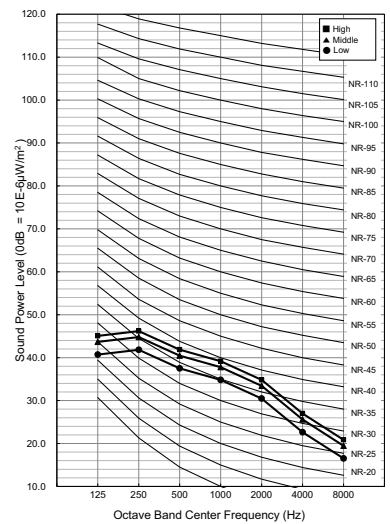

ARNU07GL4G4

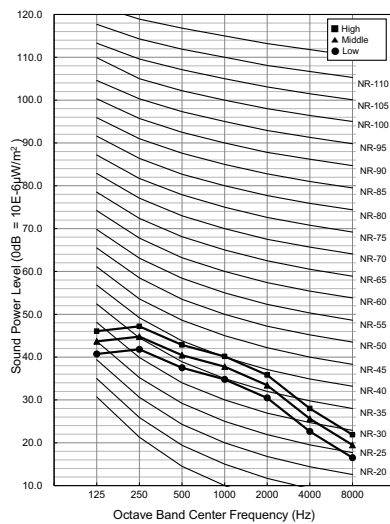

ARNU09GL4G4

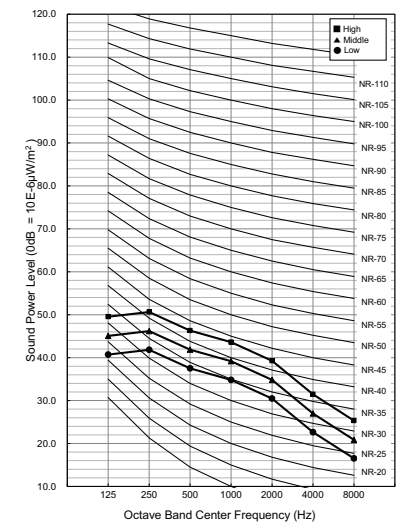

9. Sound Levels

ARNU12GL5G4

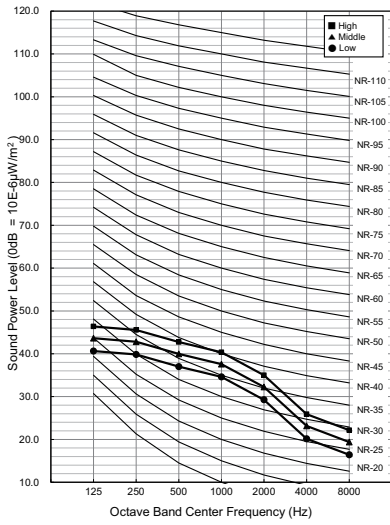

ARNU15GL5G4

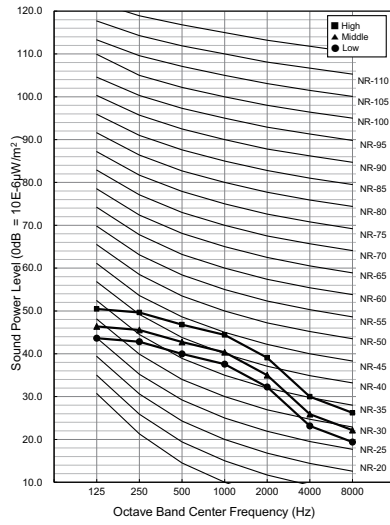

ARNU18GL5G4

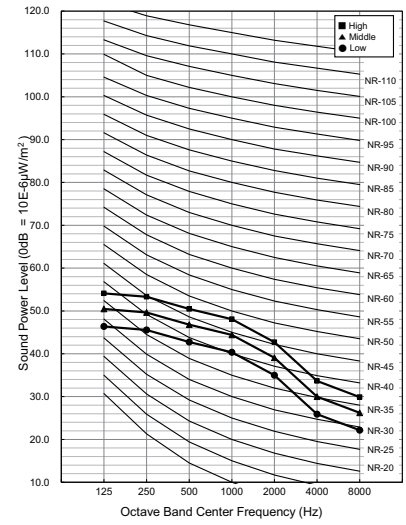

ARNU21GL6G4

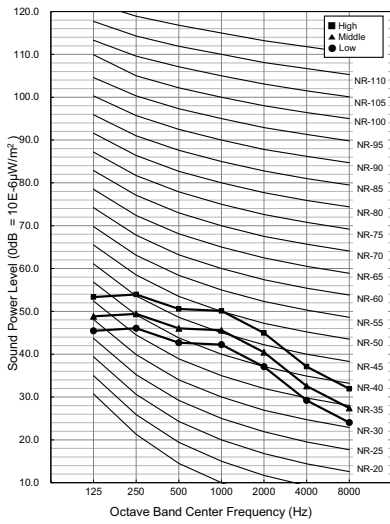

ARNU24GL6G4

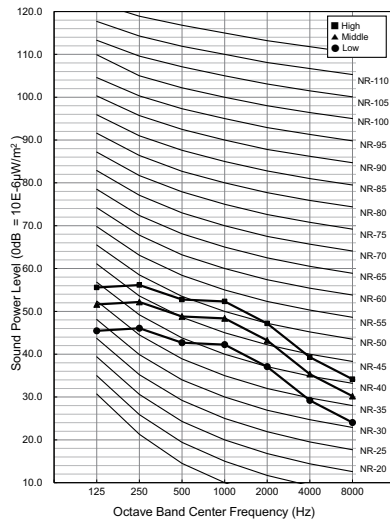

9. Sound Levels

■ Sound Power Levels (50Pa)

ARNU05GL4G4

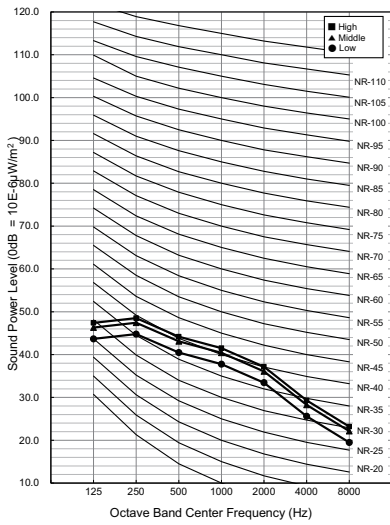

ARNU07GL4G4

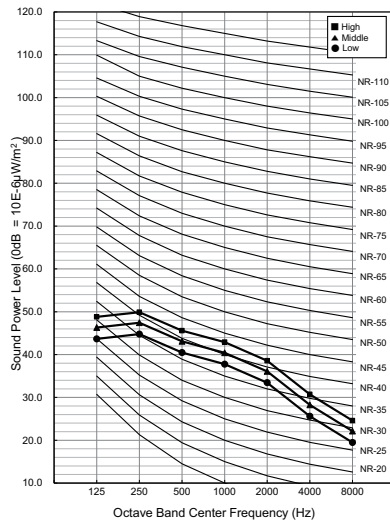

ARNU09GL4G4

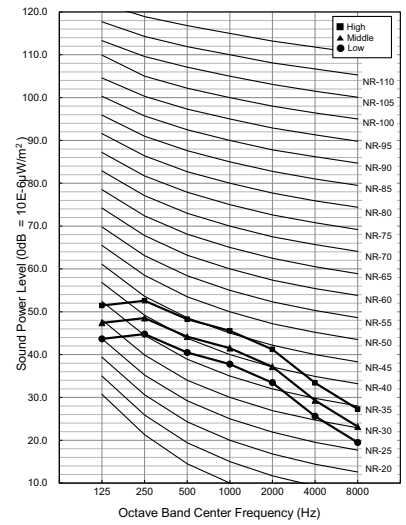

ARNU12GL5G4

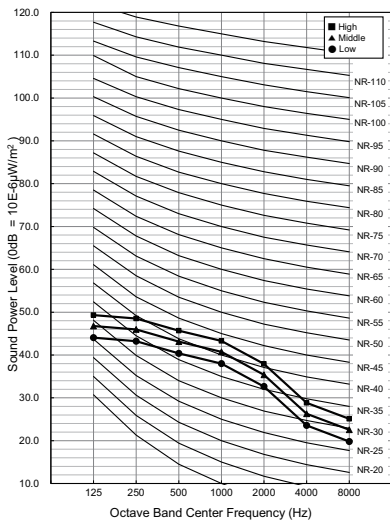

ARNU15GL5G4

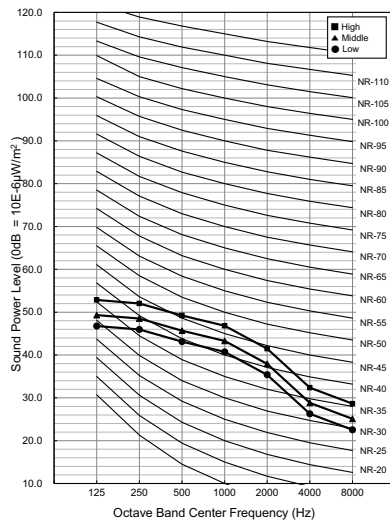

ARNU18GL5G4

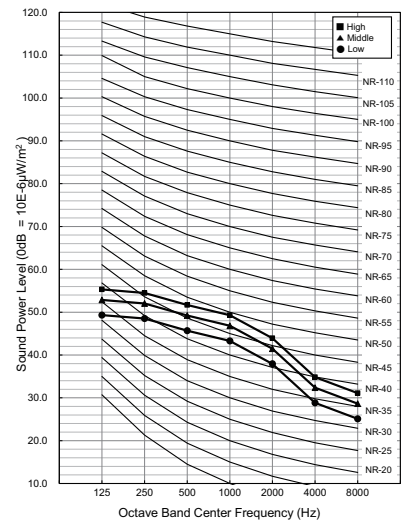

ARNU21GL6G4

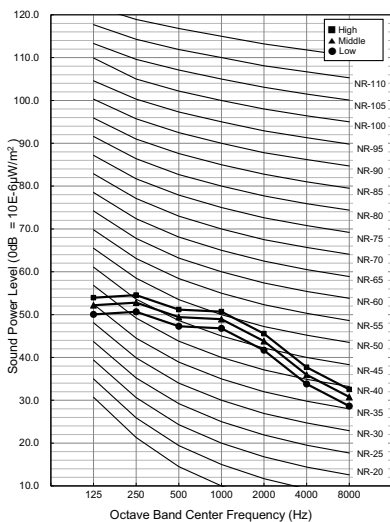

ARNU24GL6G4

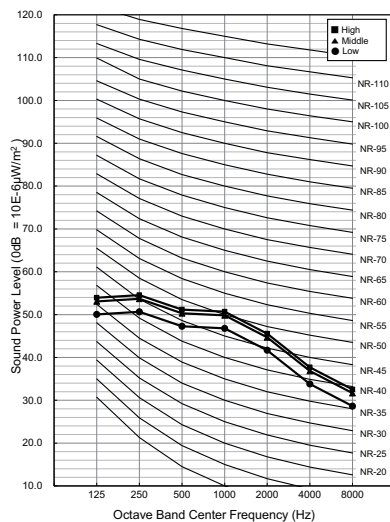

9. Sound Levels

9.2.2 Sound Power Levels (Body)

Model	Sound Power Levels [dB(A), Body(H-M-L)]			
	External Static Pressure (Pa)			
	0	10	30	50
ARNU05GL4G4	31.8-30.7-27.9	32.5-31.4-29.6	34.4-33.2-30.6	35.9-34.8-32.4
ARNU07GL4G4	32.9-30.7-27.9	34.0-31.4-29.6	35.3-33.2-30.6	37.2-34.8-32.4
ARNU09GL4G4	35.6-31.5-27.9	36.1-32.5-29.6	38.3-34.4-30.6	39.7-35.9-32.4
ARNU12GL5G4	35.8-32.6-30.4	35.1-32.7-30.7	34.2-31.6-28.8	36.8-34.1-31.2
ARNU15GL5G4	39.0-35.8-33.2	38.4-35.1-32.7	38.1-34.2-31.6	40.5-36.8-34.1
ARNU18GL5G4	41.5-39.0-35.8	42.1-38.4-35.1	41.6-38.1-34.2	43.0-40.5-36.8
ARNU21GL6G4	41.7-37.1-35.3	42.5-38.3-36.0	43.9-39.2-35.8	44.2-42.4-40.1
ARNU24GL6G4	44.4-39.0-35.3	45.0-40.7-36.0	46.2-42.1-35.8	44.2-43.3-40.1

■ Sound Power Levels (0Pa)

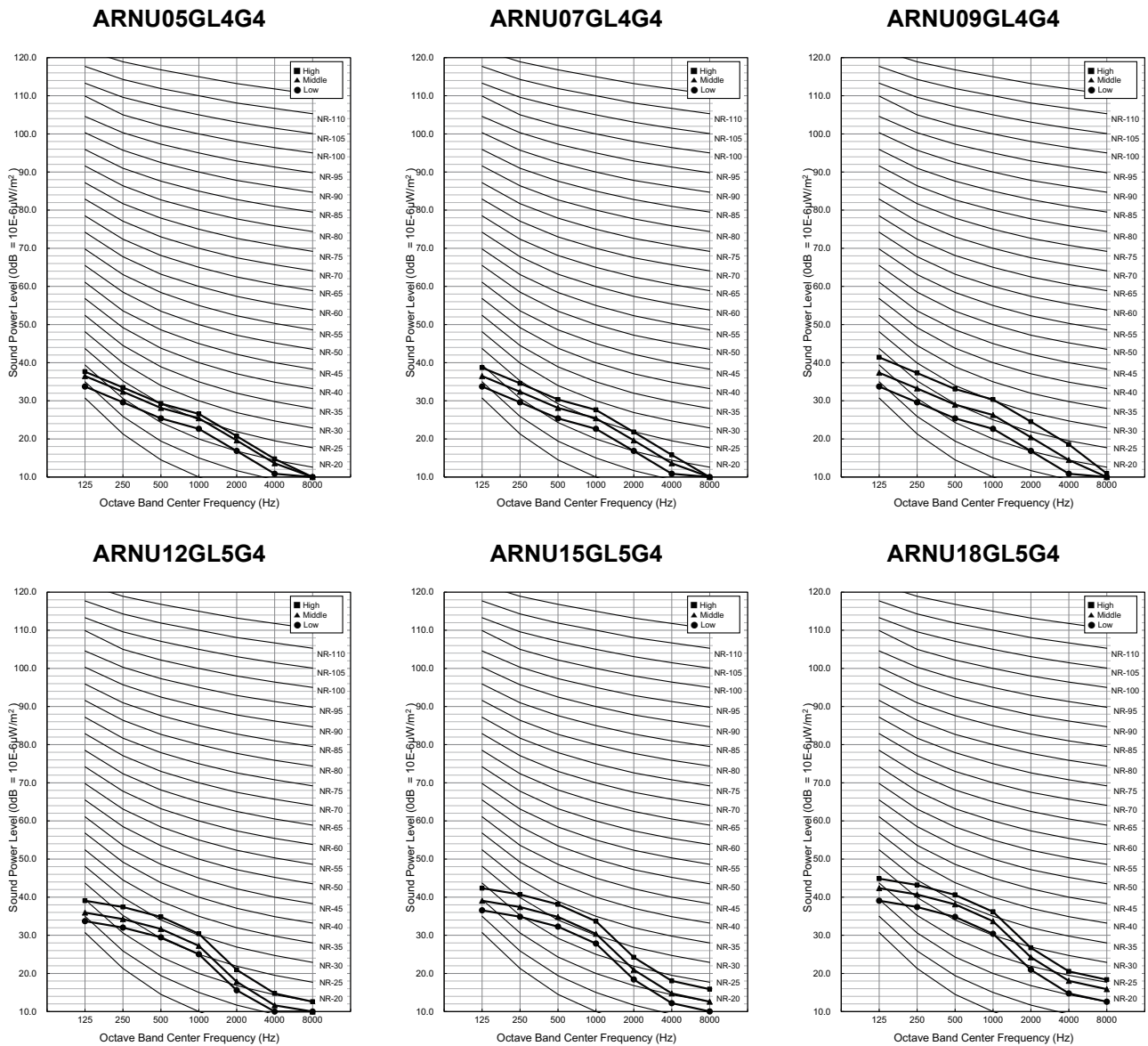

9. Sound Levels

ARNU21GL6G4

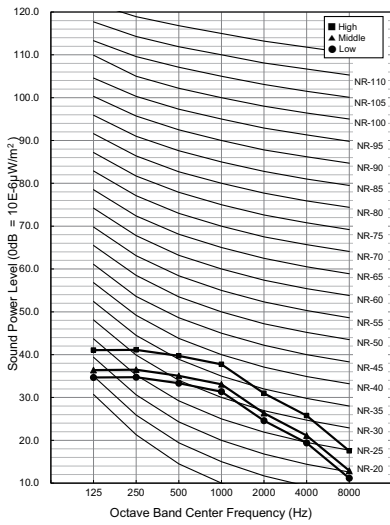

ARNU24GL6G4

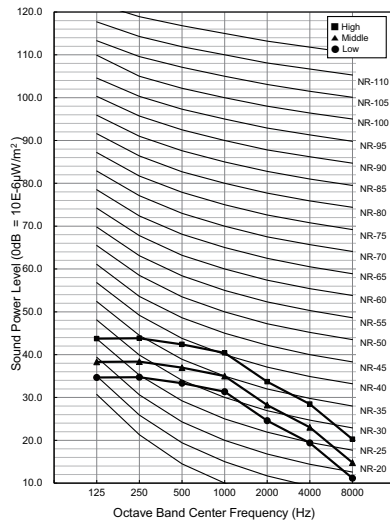

■ Sound Power Levels (10Pa)

ARNU05GL4G4

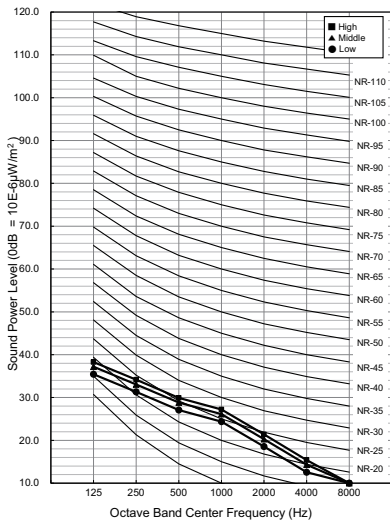

ARNU07GL4G4

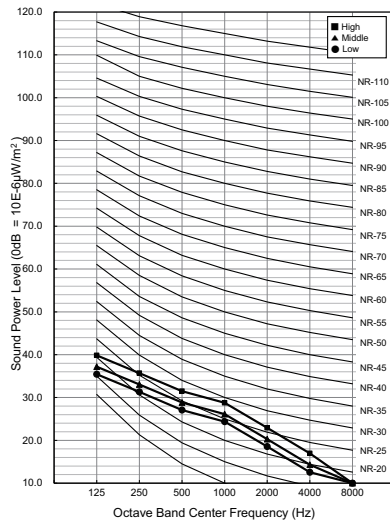

ARNU09GL4G4

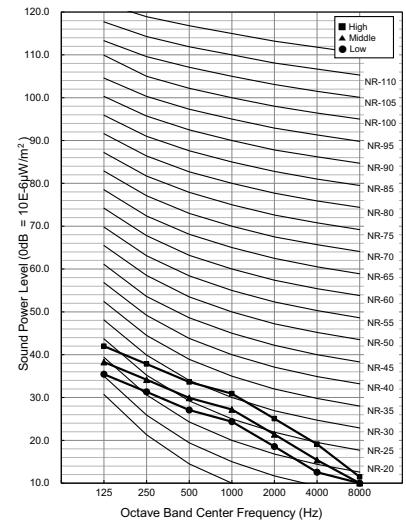

ARNU12GL5G4

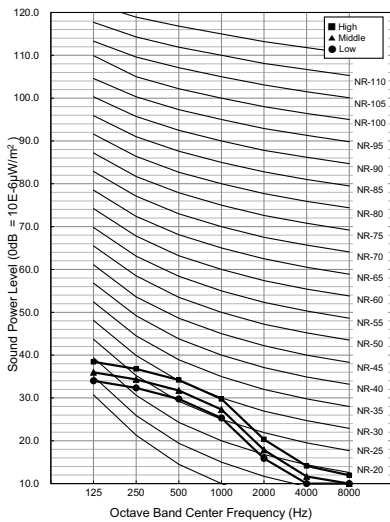

ARNU15GL5G4

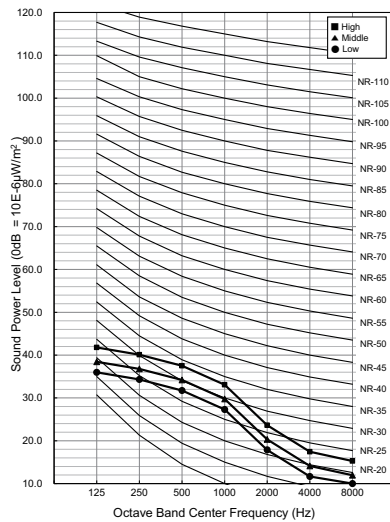

ARNU18GL5G4

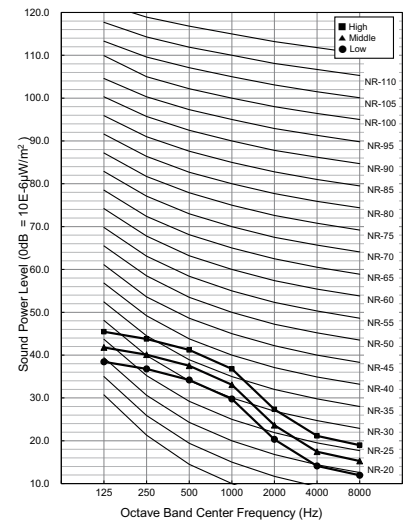

9. Sound Levels

ARNU21GL6G4

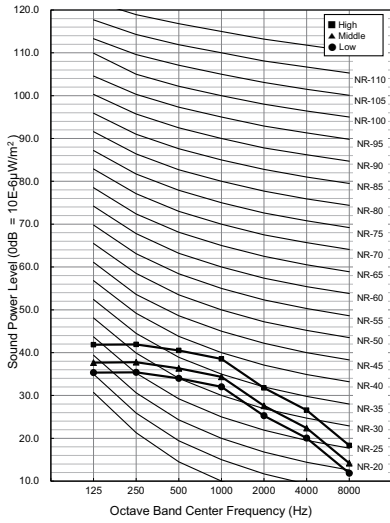

ARNU24GL6G4

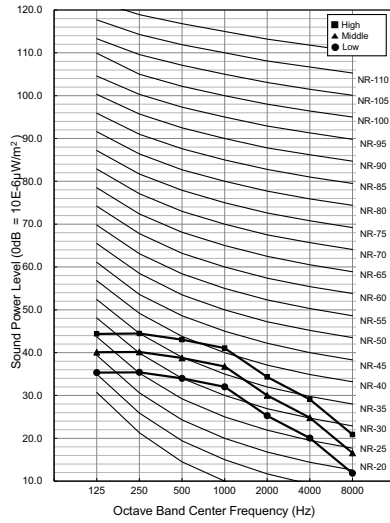

■ Sound Power Levels (30Pa)

ARNU05GL4G4

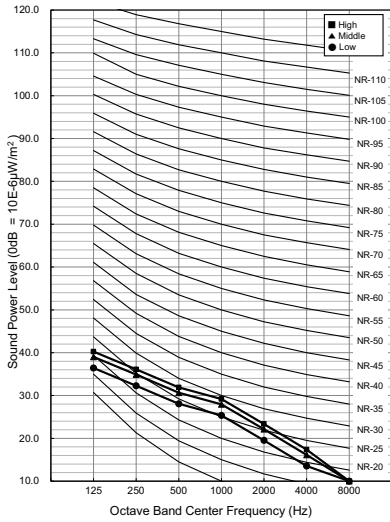

ARNU07GL4G4

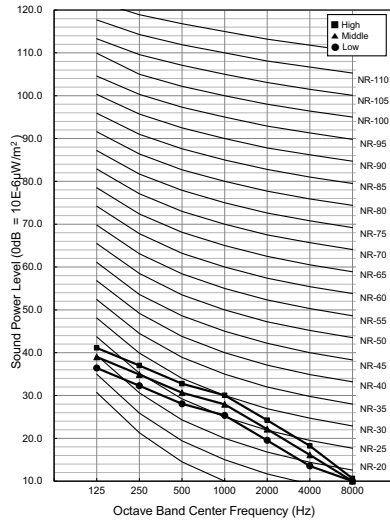

ARNU09GL4G4

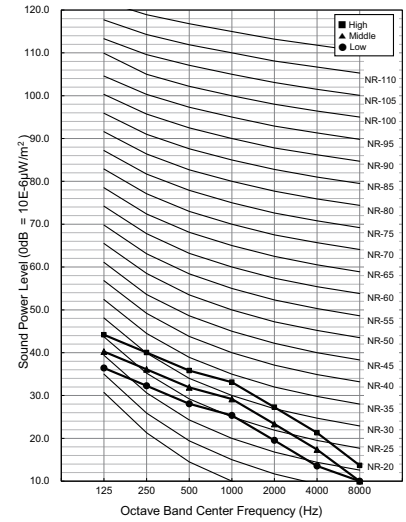

ARNU12GL5G4

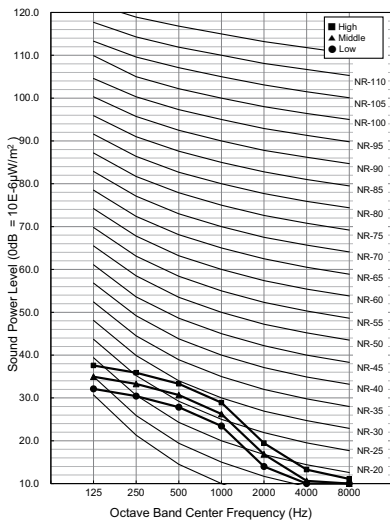

ARNU15GL5G4

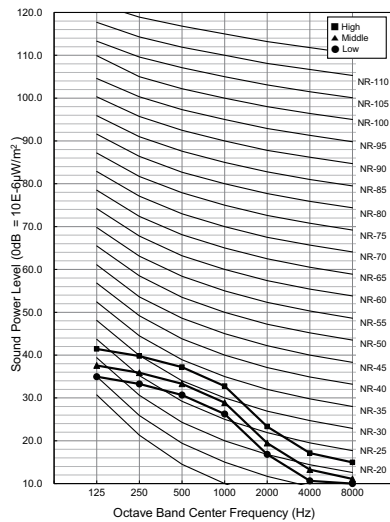

ARNU18GL5G4

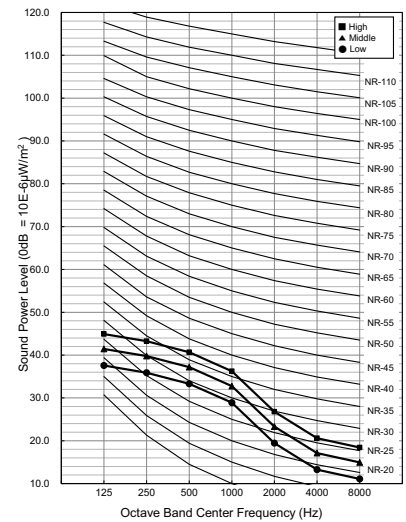

9. Sound Levels

ARNU21GL6G4

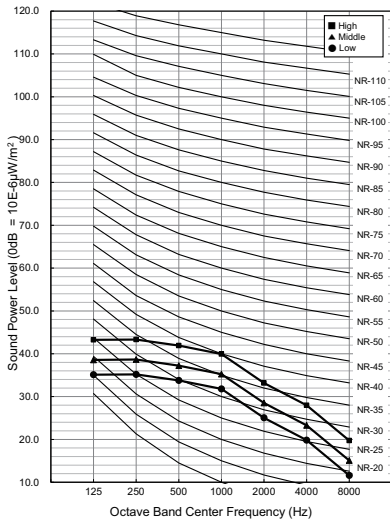

ARNU24GL6G4

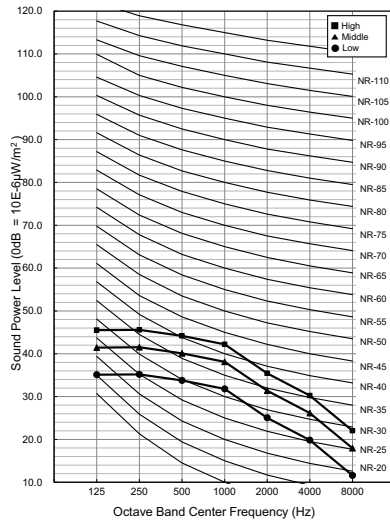

9. Sound Levels

■ Sound Power Levels (50Pa)

ARNU05GL4G4

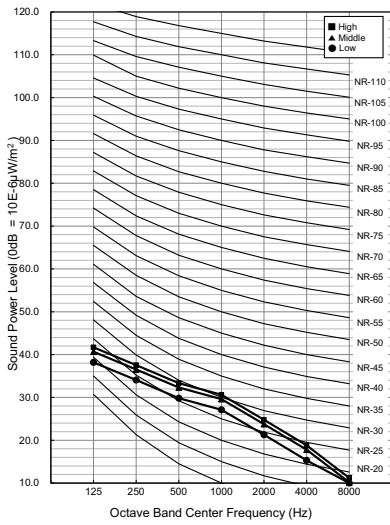

ARNU07GL4G4

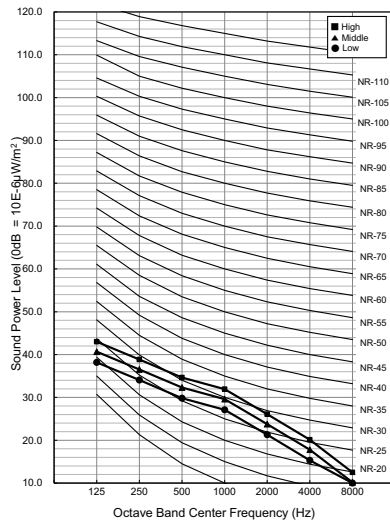

ARNU09GL4G4

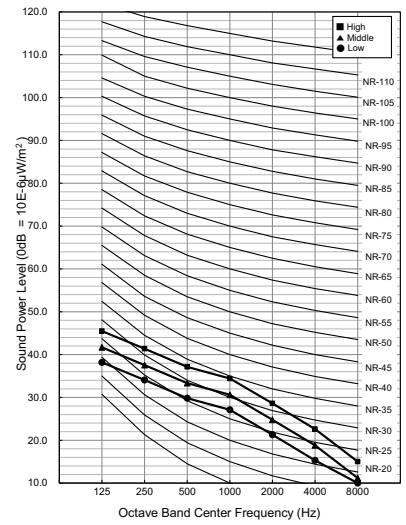

ARNU12GL5G4

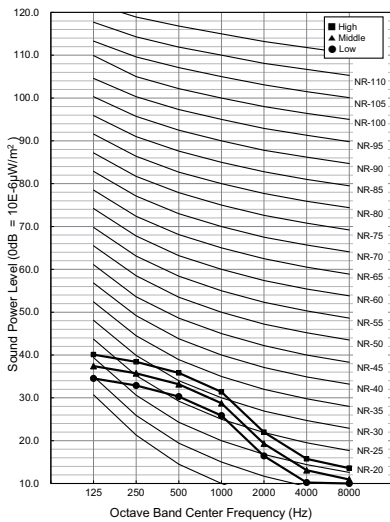

ARNU15GL5G4

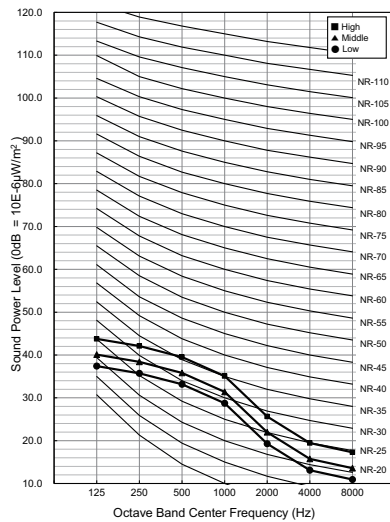

ARNU18GL5G4

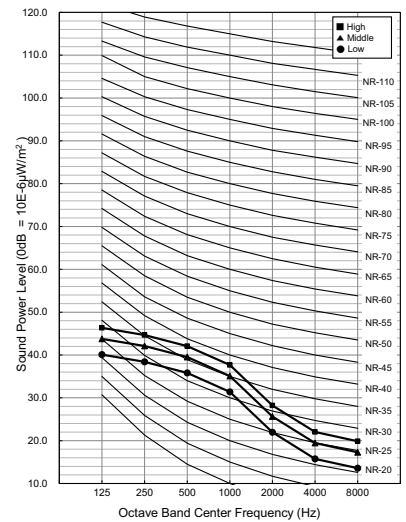

ARNU21GL6G4

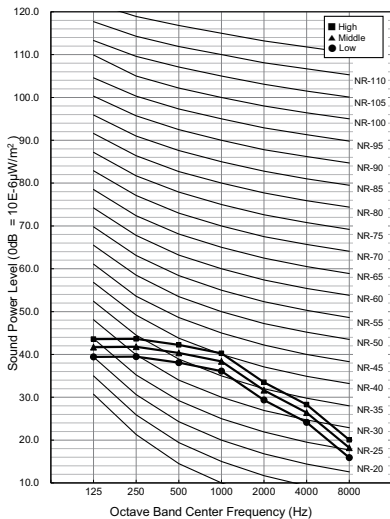

ARNU24GL6G4

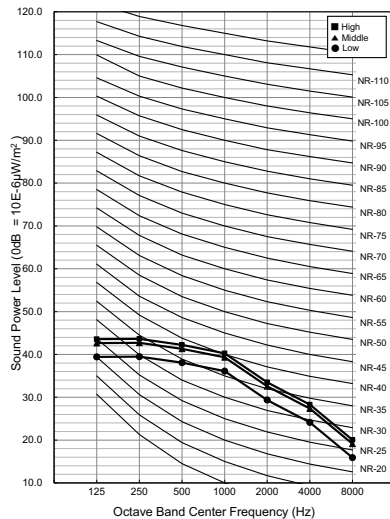

9. Sound Levels

9.2.3 Sound Power Levels (Outlet)

Model	Sound Power Levels [dB(A), Outlet(H-M-L)]			
	External Static Pressure (Pa)			
	0	10	30	50
ARNU05GL4G4	42.1-40.8-37.7	42.2-40.9-38.9	44.4-43.0-40.1	46.8-45.7-43.1
ARNU07GL4G4	43.3-40.8-37.7	44.1-40.9-38.9	45.4-43.0-40.1	48.1-45.7-43.1
ARNU09GL4G4	46.3-41.8-37.7	46.6-42.2-38.9	48.9-44.4-40.1	50.8-46.8-43.1
ARNU12GL5G4	47.1-43.9-41.7	46.4-44.0-42.0	45.4-42.8-39.9	48.1-45.4-42.5
ARNU15GL5G4	50.3-47.1-44.5	49.7-46.4-44.0	49.4-45.4-42.8	51.8-48.1-45.4
ARNU18GL5G4	52.8-50.3-47.1	53.4-49.7-46.4	52.9-49.4-45.4	54.3-51.8-48.1
ARNU21GL6G4	53.6-49.0-47.2	54.3-50.2-47.9	55.8-51.1-47.7	56.1-54.3-52.0
ARNU24GL6G4	56.3-50.9-47.2	56.9-52.6-47.9	58.1-54.0-47.7	56.1-55.2-52.0

■ Sound Power Levels (0Pa)

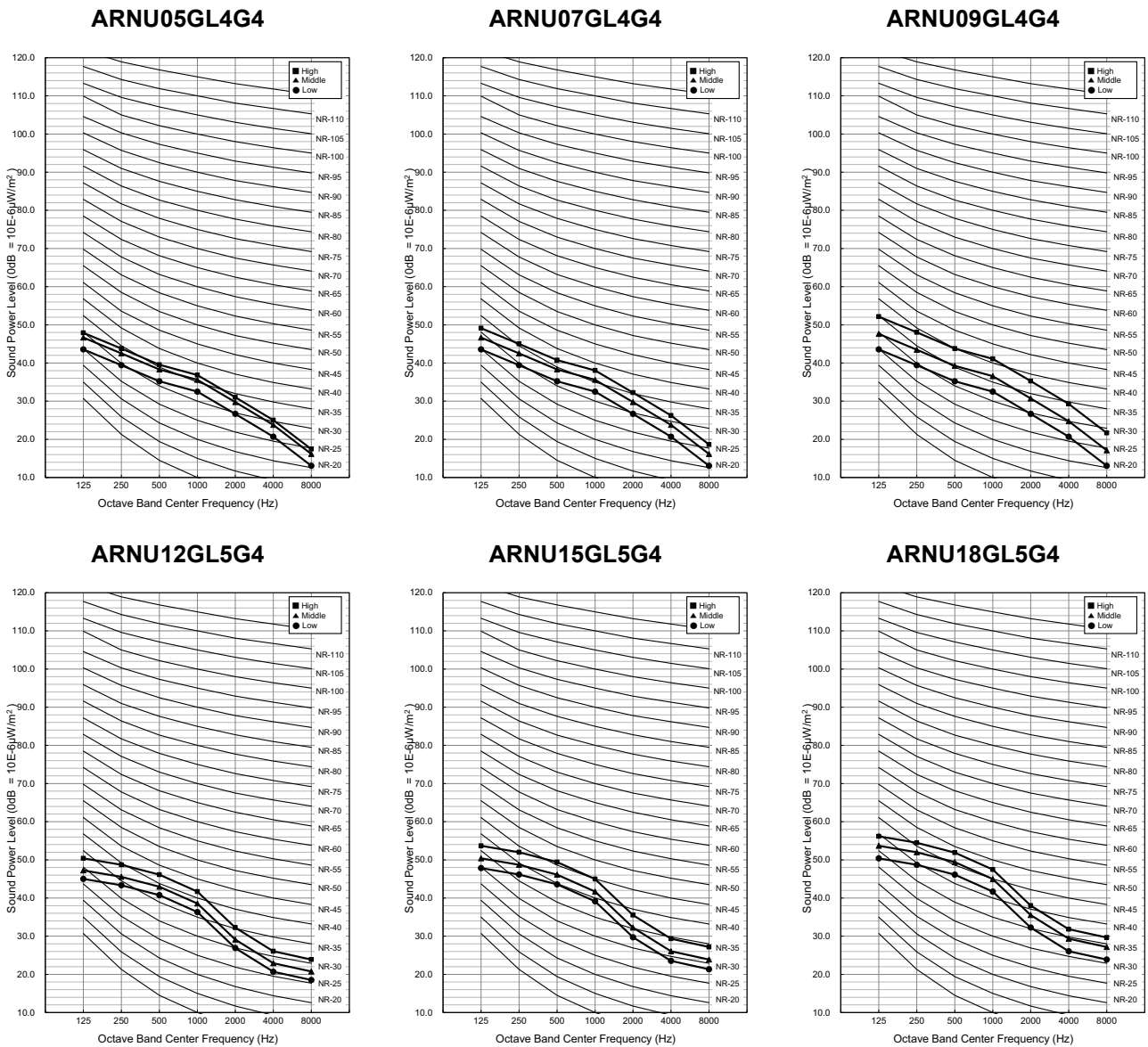

9. Sound Levels

ARNU21GL6G4

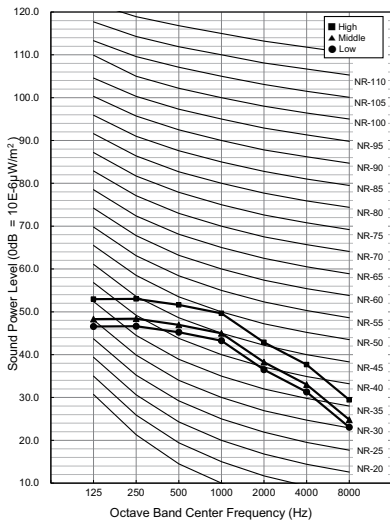

ARNU24GL6G4

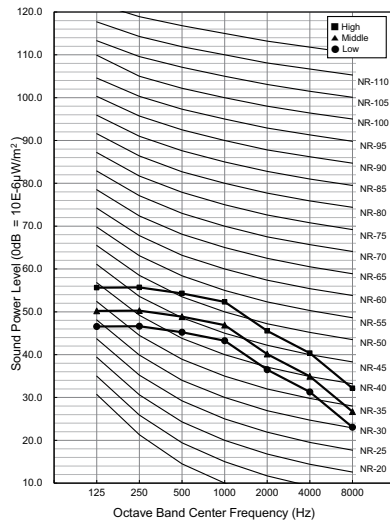

■ Sound Power Levels (10Pa)

ARNU05GL4G4

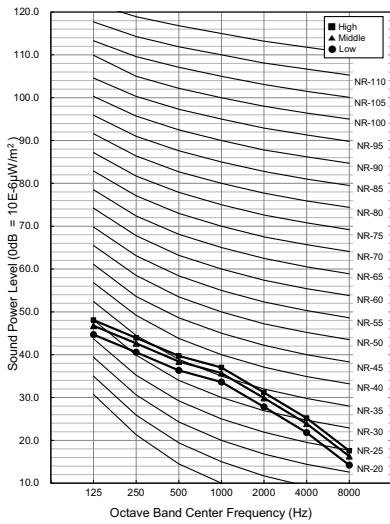

ARNU07GL4G4

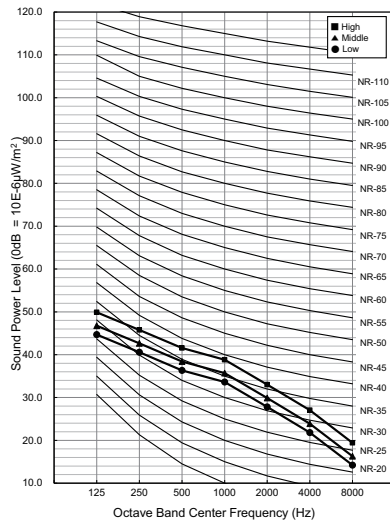

ARNU09GL4G4

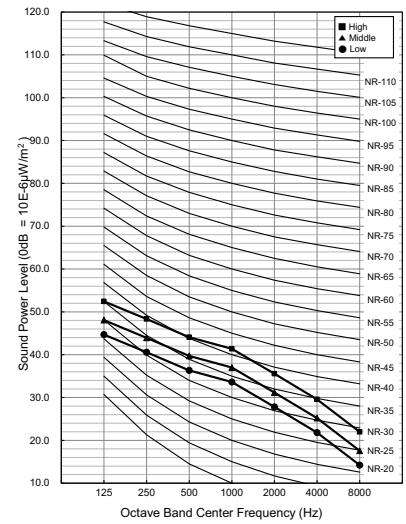

ARNU12GL5G4

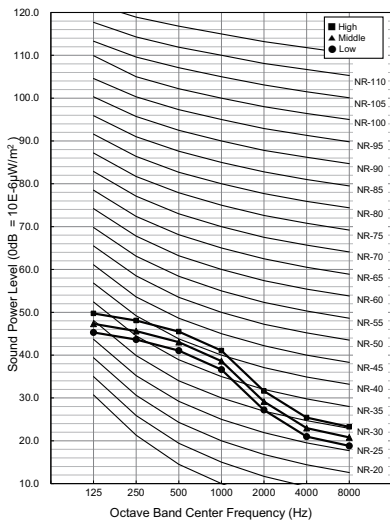

ARNU15GL5G4

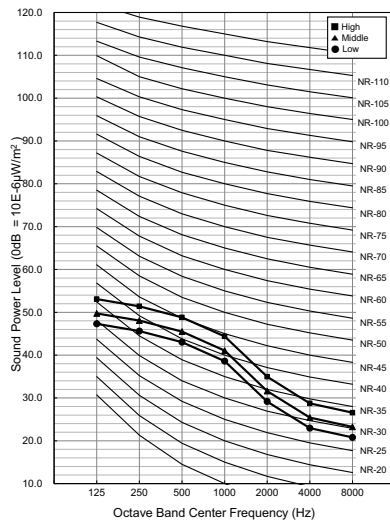

ARNU18GL5G4

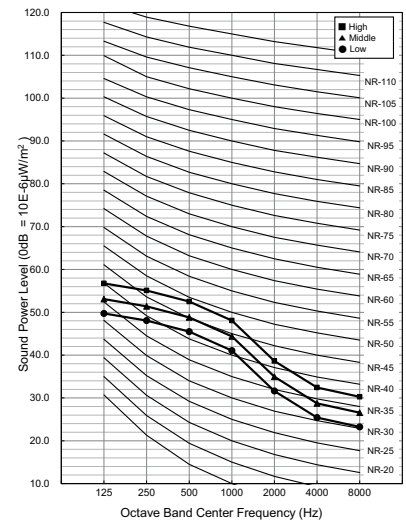

9. Sound Levels

ARNU21GL6G4

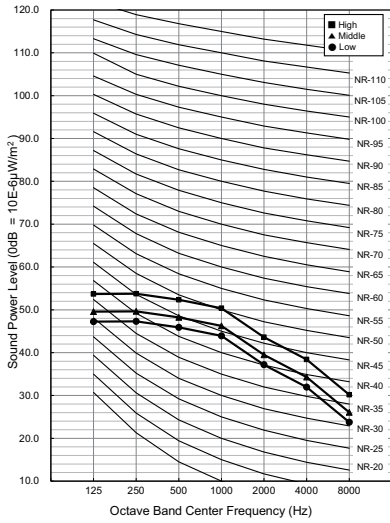

ARNU24GL6G4

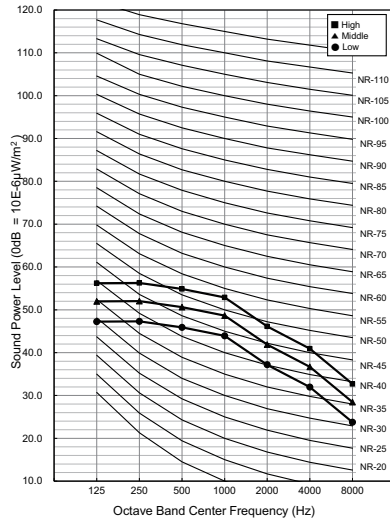

■ Sound Power Levels (30Pa)

ARNU05GL4G4

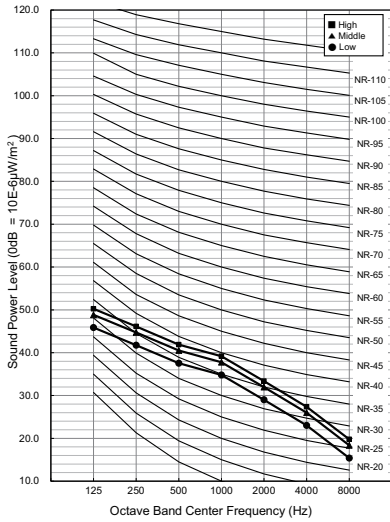

ARNU07GL4G4

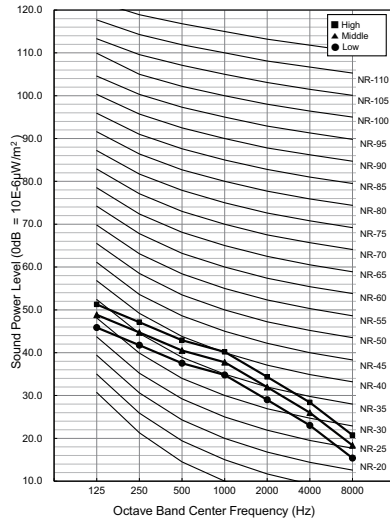

ARNU09GL4G4

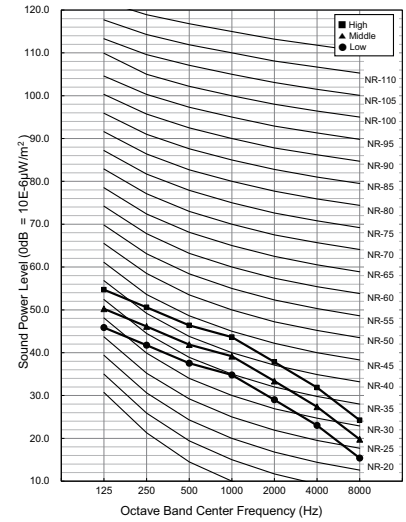

ARNU12GL5G4

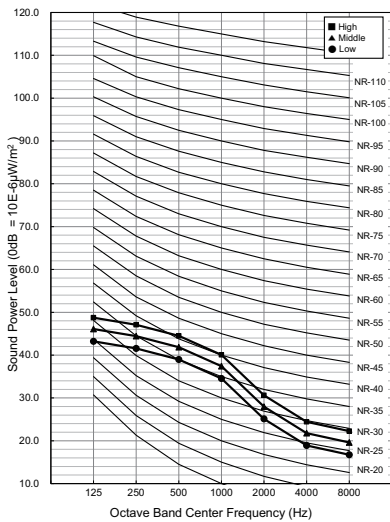

ARNU15GL5G4

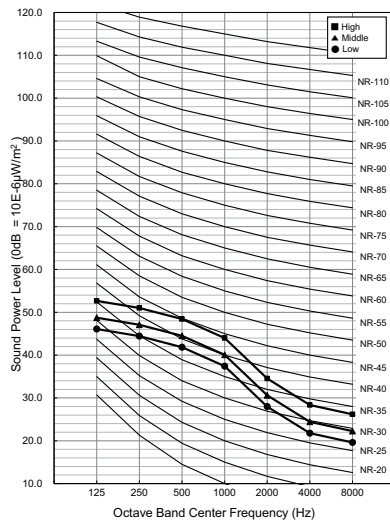

ARNU18GL5G4

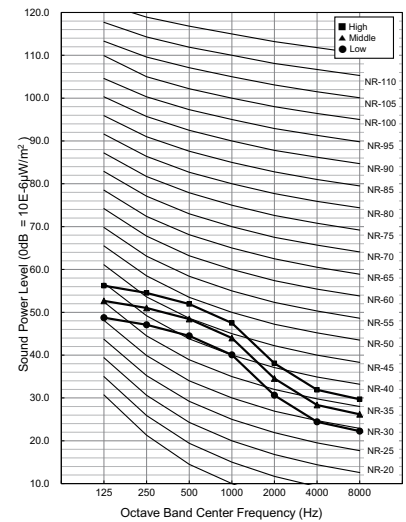

9. Sound Levels

ARNU21GL6G4

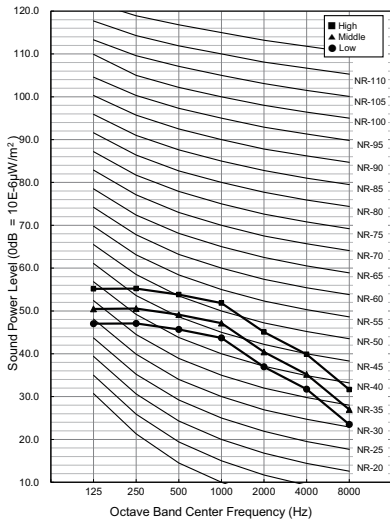

ARNU24GL6G4

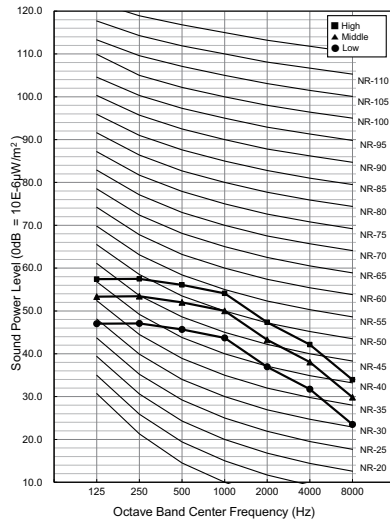

9. Sound Levels

■ Sound Power Levels (50Pa)

ARNU05GL4G4

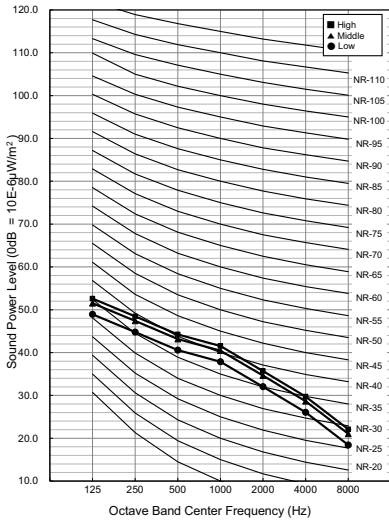

ARNU07GL4G4

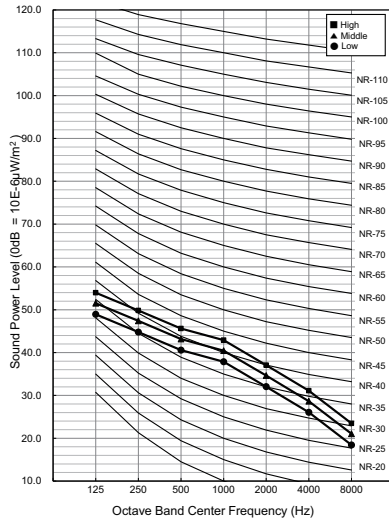

ARNU09GL4G4

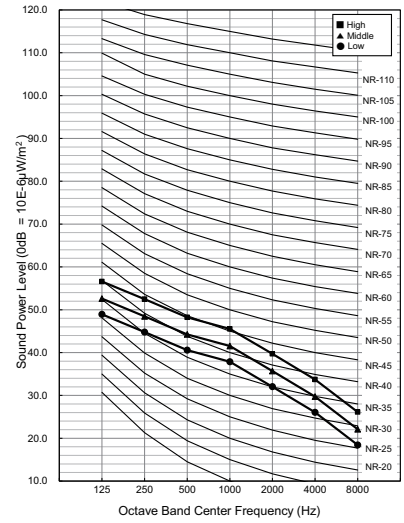

ARNU12GL5G4

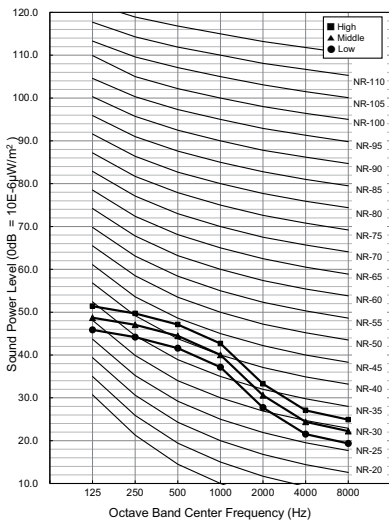

ARNU15GL5G4

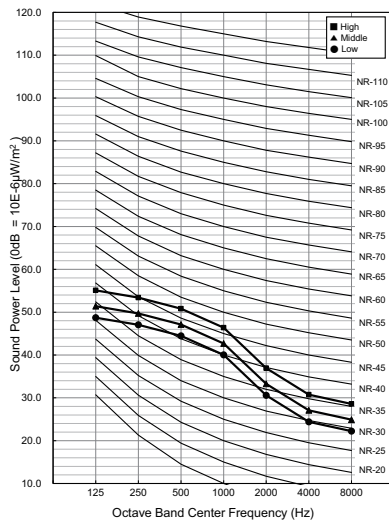

ARNU18GL5G4

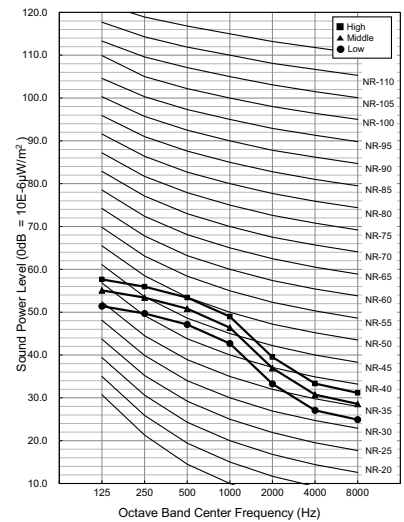

ARNU21GL6G4

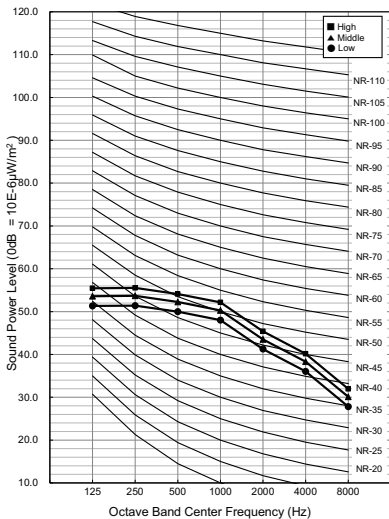

ARNU24GL6G4

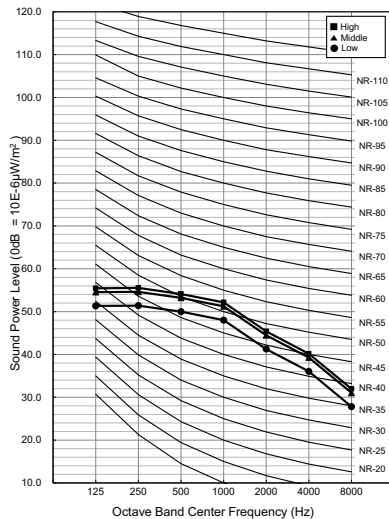

Ceiling & Floor Convertible Unit

- 1. List of functions**
- 2. Specifications**
- 3. Dimensions**
- 4. Piping Diagrams**
- 5. Wiring Diagrams**
- 6. Capacity Tables**
- 7. Air Velocity and Temperature Distribution**
- 8. Electric Characteristics**
- 9. Sound Levels**

1. List of functions

Category	Function	ARNU09GVEA4, ARNU12GVEA4
Air Flow	Air Supply Outlet	1
	Airflow Direction Control (left & right)	Manual
	Airflow Direction Control (up & down)	Auto
	Auto Swing (left & right)	X
	Auto Swing (up & down)	O
	Airflow Steps (fan/cool/heat)	3 / 4 / 4
	Fan Speed Auto*	Advanced
	Power Cool/Heat	O / O
	Swirl Wind*	X
	Refresh Mode**	X
	Smart Mode**	X
	Indirect Wind*	X
	Direct Wind*	X
	Dry Operation	O
Air Purification	Air Purify	X
	Ionizer	X
	UV-C	X
	Pre-Filter	O
Reliability	Hot Start	O
	Self Diagnosis	O
Convenience	Auto Mode	O
	Auto Dry Operation	O
	Auto Restart	O
	Child Lock*	O
	Forced Operation	O
	Group Control*	O
	Sleep Timer	O
	Turn On/Off Reservation	O
	Schedule*	O
	Two Thermistor Control*	O
	External On/Off	O
Installation	Drain Pump	X
	E.S.P. Control*	X
	High Ceiling Operation*	O
Special Functions	Wi-Fi	Accessory
	Auto Elevation Grille	X
	Human Detection Function**	X
	Floor Detection Function**	X

Note

- O : Applied, X : Not Applied, - : Unconfirmed or irrelevant
 Embedded : A kit is provided by default for using this function when the product is manufactured.
 Accessory : Ordered and purchased separately the accessory package referring to the model name provided and install at field. Accessory line-ups varies by region, so check your local catalogue or local sales material.
- Some functions can be limited by remote controller.
- In case of cassette type indoor units, Air Purification Kit and Auto Elevation Grille functions are not applicable at the same time.
- 'Auto Mode' varies depending on the outdoor unit type.
 - Auto Change Over(Heat Recovery Outdoor Unit)
 - Auto Mode Select(Heat Pump Outdoor Unit)
 - Auto Intensity Control(Cooling Only Outdoor Unit)
- * : These functions need to connect the wired remote controller.
- ** : This functions need to connect to the Standard III wired remote controller.

1. List of functions

■ Accessory Compatibility List

Category	Accessory Name	Model Name	Description	ARNU09GVEA4 ARNU12GVEA4
Remote Controller	Wired - Premium	PREMTA000	-	○
		PREMTA000A	-	○
		PREMTA000B	-	○
	Wired - RS3 (Standard III)	PREMTB100/PREMTB101	White	○
		PREMTBB10/PREMTBB11	Black	○
	Wired - RS2 (Standard II)	PREMTB001	White	○
		PREMTBB01	Black	○
	Wired - Simple	PQRCVCL0QW	White	○
		PQRCVCL0Q	Black	○
	Wired - Simple for Hotel	PQRCHCA0QW	White	○
		PQRCHCA0Q	Black	○
	Wireless	PQWRCQ0FDB	For Cooling only	○
		PQWRHQ0FDB	For Heat pump	○
PWLSSB21C		For Cooling only	○	
PWLSSB21H		For Heat pump	○	
Dry Contact	Simple	PDRYCB000	1 input port, AC 220 - 240V	○
		PDRYCB100	1 input port, AC 24V	○
	Communication	PDRYCB400	2 input port	○
		PDRYCB300	8 input port, For 3rd party Thermostat	○
		PDRYCB320	8 input port, For 3rd Party Thermostat (Analog Input)	○
PDRYCB500	For 3rd Party Controller (Modbus RTU)	○		
Integration Device	Remote Temperature sensor	PQRSTA0	-	X
	Group Control wire	PZCWRCG3	Cable Assembly for group control (Y-type cable : 0.25m, cable : 9.6m)	○
ETC	Extension wire	PZCWRC1	Extension wire for IDU-wired remote controller (9.6m)	X
	2-Remo Control Wire	PZCWRC2	-	X
	Wi-Fi Modem	PWFMDD200	-	○
	Wi-Fi Extension cable	PWYREW000	USB Extension cable : 10 m	○
	Independent Power Module	PRIP0	-	○
	Multi-tenant Power Module	PINPMB001	-	○
	Refrigerant Leakage Detector	PRLDNVS0	For R410A only	○
	Human Detection Sensor	PTVSMA0	For Cassette 4-way	X
		PTVSA0	For Cassette Dual Vane 4-way	X
	Floor Detection Sensor	PTFSMA0	-	X
	Auto Elevation Grille	PTEGM0	For TP/TN/TM	X
	Air Purification Kit	PTAHTP0	For Cassette 1-way	X
		PTAHMP0	For Cassette 4-way	X
		PTAHYP0	For Cassette Round	X
	EEV Kit	PRGK024A0	For Multi V Indoor Unit	○
	Auxiliary Heater Relay Kit	PRARS1	For Wall Mounted and Art Cool Indoor Units	X
		PRARH1	For Cassette and Duct Indoor Units	X
	Ventilation Kit	PTVK430	For TR/TQ/TP/TN/TM	X
		PTVK410 + PTVK420	For TP/TN/TM	X
	Cassette Cover	PTDCQ	For TR/TQ	X
PTDCM		For TP/TN/TM	X	
PTDCA		For TM-A/TP-B	X	

Note

1. ○: Possible, X: Impossible, -: Not applicable, Embedded : Included with product.
2. If there is a difference in development time between the product and the remote controller, some functions cannot be operated.
3. If using Wi-Fi controller, Some advanced functions controlled by remote controller cannot be operated.
4. If you need more detail, please refer to the **BECON** PDB or the manual of product. (<http://partner.lge.com/global> : Home> Doc.Library> Product > Control(BECON))

2. Specifications

Type			Ceiling & Floor Convertible Unit	
Model		Unit	ARNU09GVEA4	ARNU12GVEA4
Cooling Capacity		kW	2.8	3.6
		kcal/h	2,400	3,100
		Btu/h	9,600	12,300
Heating Capacity		kW	3.2	4.0
		kcal/h	2,800	3,400
		Btu/h	10,900	13,600
Power Input (H / M / L)		W	19 / 15 / 11	28 / 19 / 15
Casing			-	-
Dimensions (W × H × D)	Body	mm	900 × 490 × 200	900 × 490 × 200
		inch	35-7/16 × 19-9/32 × 7-7/8	35-7/16 × 19-9/32 × 7-7/8
Coil	Rows × Columns × FPI		2 × 12 × 20	2 × 12 × 20
	Face Area	m ²	0.10	0.10
Fan	Type		Cross Flow Fan	Cross Flow Fan
	Motor Output	W × No.	27 × 1	27 × 1
	Air Flow Rate (H / M / L)	m ³ /min	7.6 / 6.9 / 6.2	9.2 / 7.6 / 6.9
		ft ³ /min	268 / 244 / 219	325 / 268 / 244
	Drive		Direct	Direct
Motor type		BLDC	BLDC	
Temperature Control			Microprocessor, Thermostat for cooling and heating	
Sound Absorbing Thermal Insulation Material			Foamed polystyrene	
Safety Device			Fuse	
Pipe Connections	Liquid Side	mm(inch)	Ø6.35 (1/4)	Ø6.35 (1/4)
	Gas Side	mm(inch)	Ø12.7 (1/2)	Ø12.7 (1/2)
	Drain (I.D.)	mm	16 (5/8)	16 (5/8)
Net Weight		kg(lbs)	13.3	13.3
Shipping Weight		kg(lbs)	17.8	17.8
Sound Pressure Levels (H / M / L)		dB(A)	36 / 32 / 28	38 / 36 / 30
Sound Power Levels (H / M / L)		dB(A)	55 / 51 / 45	56 / 55 / 49
Power Supply		Ø, V, Hz	1, 220 - 230 - 240, 50/60	1, 220 - 230 - 240, 50/60
Running Current by voltage	Rated	A	0.17 - 0.16 - 0.15	0.24 - 0.23 - 0.22
Maximum Running Current		A	0.25	0.25
Refrigerant	Type		R410A / R32	R410A / R32
	Additional Charging Amount (CF Value of IDU)		kg(each)	0.10 / 0.08
	Control		-	EEV
Transmission Cable		mm ² × Cores	1.0 ~ 1.5 × 2C	1.0 ~ 1.5 × 2C

Note

1. Due to our policy of innovation some specifications may be changed without notification.
2. Wiring cable size must comply with the applicable local and national code. And "Electric characteristics" chapter should be considered for electrical work and design. Especially the power cable and circuit breaker should be selected in accordance with that.
3. Sound pressure level is measured on the rated condition in the anechoic rooms by ISO 3745 standard.
Sound power level is measured on the rated condition in the semi-anechoic rooms by ISO 9614 standard.
Therefore, these values can be increased owing to ambient conditions during operation.
4. Capacities are net capacities and based on the following conditions. Refer to the Outdoor Unit Specifications for calculating the real capacity.
 - Cooling : Indoor Ambient Temp. 27°CDB / 19°CWB, Outdoor Ambient Temp. 35°CDB / 24°CWB
 - Heating : Indoor Ambient Temp. 20°CDB / 15°CWB, Outdoor Ambient Temp. 7°CDB / 6°CWB
 - Interconnected Pipe is standard length and difference of Elevation (Outdoor ~ Indoor Unit) is 0m.
5. Refrigerant information (type, additional charging amount, etc.) must be applied by refrigerant type of the combined outdoor unit.
Adapt after checking the specifications of outdoor unit.

3. Dimensions

3.1 Dimensional Drawings

ARNU09GVEA4 / ARNU12GVEA4

The drawings include:

- Top View:** Shows overall dimensions of 900mm width and 490mm depth. Callouts 1, 2, and 3 point to the front grille, display, and suction grille respectively.
- Front View:** Shows a height of 200mm. Callout 4 points to the knockout hole.
- Side View:** Shows a depth of 99mm and a mounting bracket height of 80mm.
- Bottom View:** Shows a total height of 900mm and mounting hole positions at 860mm and 879mm from the bottom edge.
- Internal View:** Shows a total width of 583mm and a depth of 225mm. It details the internal components and wiring.

No.	Part Name	Remark
1	Front air discharge grille	
2	Display & Signal Receiver	
3	Air Suction Grille	
4	Knockout hole	
5	Installation Plate	

■ Note

- Unit should be installed in compliance with the installation manual in the product box.
- Unit shall be grounded in accordance with the local regulations or applicable national codes.
- The Unit is powered from the outdoor unit. Therefore power cable should be connected with the outdoor unit.

[Unit : mm]

3. Dimensions

3.2 Installation Space

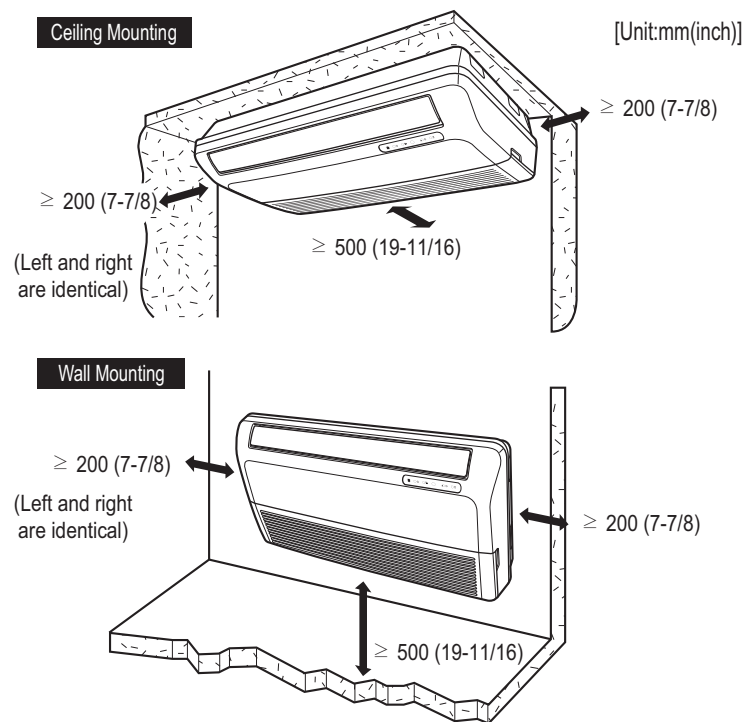

Note

- Places where products are installed should not be any obstacles to the air circulation or installation. Ensure the spaces from the wall, ceiling, or other obstacles.
- According to type of indoor unit, external appearance or installed structure could be different.
- According to product type, model line up, sales region..etc, applicability of each chassis could be different.

4. Piping Diagrams

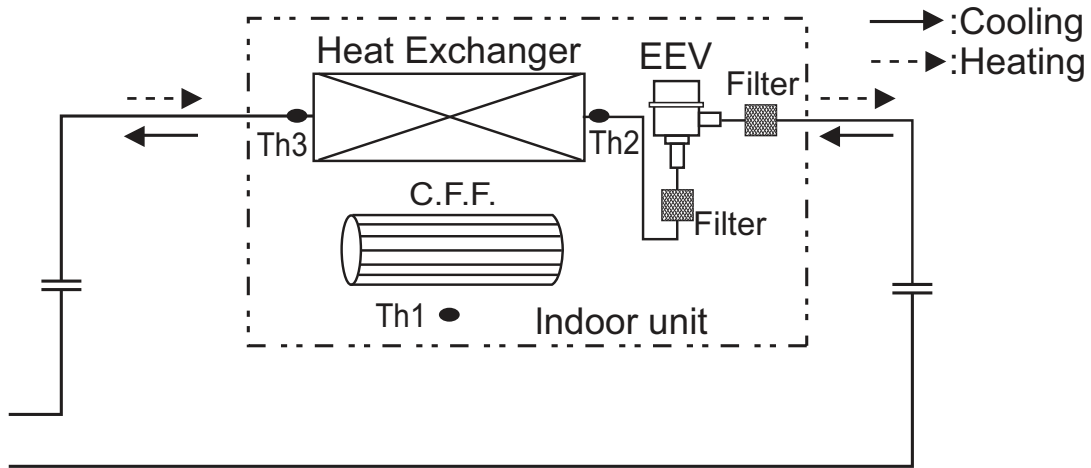

◆ Refrigerant pipe connection port diameter

Model	Gas [mm(inch)]	Liquid [mm(inch)]
ARNU09GVEA4	Ø12.7(1/2)	Ø6.35(1/4)
ARNU12GVEA4	Ø12.7(1/2)	Ø6.35(1/4)

LOC.	Description
Th1	Room thermistor
Th2	Pipe in thermistor
Th3	Pipe out thermistor

5. Wiring Diagrams

VE Chassis

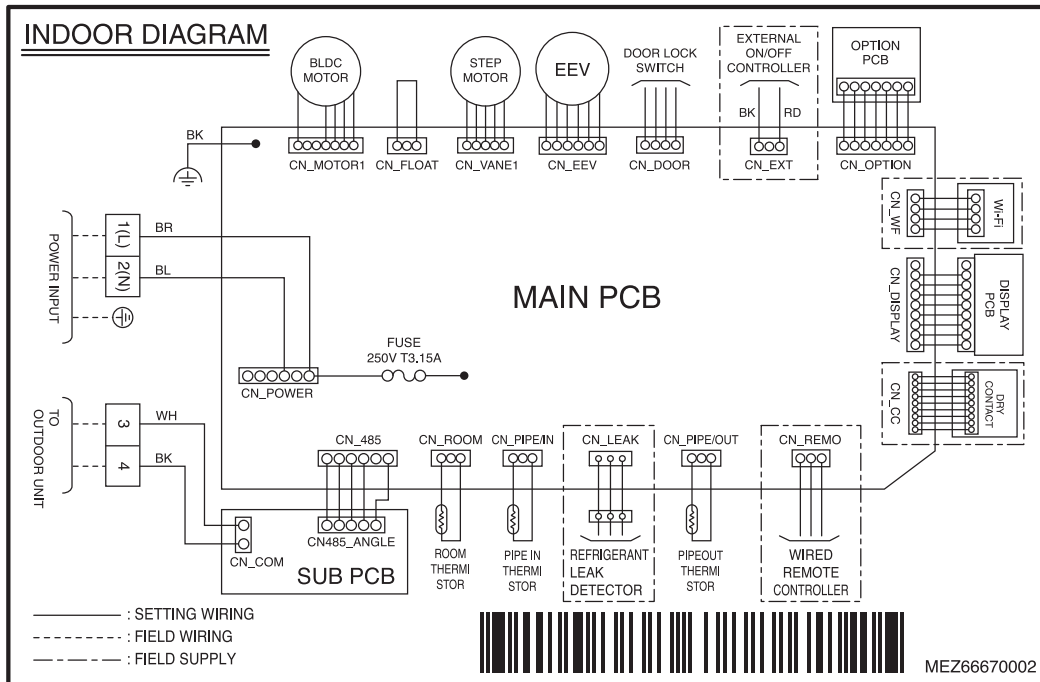

CONNECTOR NUMBER	LOCATION POINT	FUNCTION
CN-POWER	AC Power supply	AC Power line input for indoor controller
CN-MOTOR1	Fan motor output	Motor output of BLDC
CN-485	Communication	Connection between indoor and outdoor
CN-DISPLAY	Display	Display of indoor status
CN-EEV	EEV Output	EEV Control output : connect to EEV directly or through IPM(Independent Power Module)
CN-LEAK	Refrigerant leak detector	Refrigerant leak detector line
CN-VANE1	Step motor	Step motor output
CN-FLOAT	Float switch input (not used)	Float switch sensing (not used)
CN-PIPE_IN	Suction pipe sensor	Pipe in thermistor
CN-PIPE_OUT	Discharge pipe sensor	Pipe out thermistor
CN-ROOM	Room sensor	Room air thermistor
CN-REMO	Remote controller	Remote control line
CN-CC	Dry contact	Dry contact line
CN-OPTION	Option pwb.	Communication between main and option
CN-EXT	External On/Off	External On/Off signal input
CN-DOOR	Door lock switch	Door lock switch line
CN_WF	Wi-Fi Controller	Wifi control line

Dip Switch Setting		Off	On	Remarks
SW3	GROUP	Master	Slave	Group Control setting using Wired Remote Controller
SW4	DRY CONTACT	Variable	Auto	Old Dry Contact Mode Setting 1. Variable : Auto/Manual Mode can be chosen by Wide wired remote controller or Wireless remote controller (When shipped from Factory → Manual Mode) 2. Auto : For Dry Contact, it is always Auto mode.
SW5	EXTRA 1	Off	On	1. Duct model -. OFF : Default(not operate continuously) -. ON : Fan operate continuously 2. Cassette Model : No Function 3. Ceiling Suspended Model -. OFF : Ceiling(default) -. ON : Floor

⚠ CAUTION

For Multi V Model, Dip Switch 1,2,6,7,8 must be set OFF
That dip switch is used for the other model.

6. Capacity Tables

■ Cooling Capacity

Nominal Capacity (kBtu/h) [Capacity Index (kW)]	Indoor air temp. (DB/WB, °C)													
	20		23		26		27		28		30		32	
	14		16		18		19		20		22		24	
	TC	SHC	TC	SHC	TC	SHC	TC	SHC	TC	SHC	TC	SHC	TC	SHC
9 [2.8]	1.9	1.6	2.3	1.8	2.6	2.0	2.8	2.0	3.0	2.0	3.0	1.9	3.1	1.8
12 [3.6]	2.4	2.1	2.9	2.3	3.4	2.5	3.6	2.6	3.8	2.6	3.9	2.5	4.0	2.3

Note

1. TC: Total Capacity(kW), SHC: Sensible Heat Capacity(kW)
2. Capacity tables show the average value of conditions which may occur.
3. Refer to Capacity tables and correction factor in the outdoor unit PDB for the actual performance data of each indoor unit and outdoor unit combination.

■ Heating Capacity

Nominal Capacity (kBtu/h) [Capacity Index (kW)]	Indoor air temp. (DB, °C)					
	16	18	20	21	22	24
	TC	TC	TC	TC	TC	TC
9 [2.8]	3.6	3.4	3.2	3.1	3.0	2.8
12 [3.6]	4.5	4.3	4.0	3.9	3.7	3.5

Note

1. TC: Total Capacity(kW)
2. Capacity tables show the average value of conditions which may occur.
3. Refer to Capacity tables and correction factor in the outdoor unit PDB for the actual performance data of each indoor unit and outdoor unit combination.

7. Air Velocity and Temperature Distribution

■ ARUN09GVEA4

◆ Ceiling Installation

Cooling

Heating

Discharge angle:50°

Discharge angle:60°

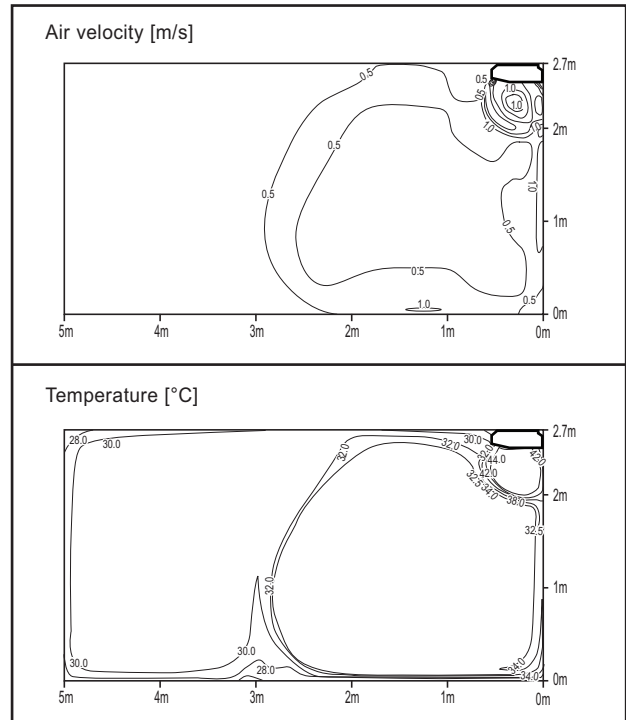
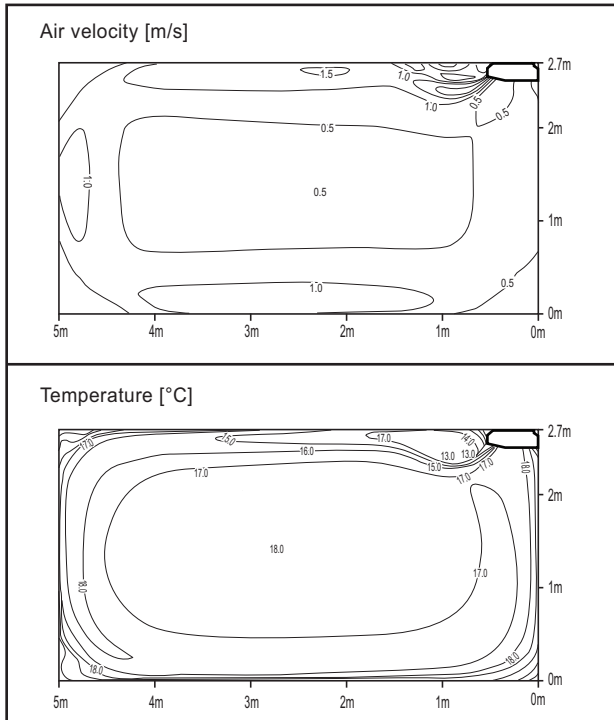

Note

- These figures are accordance with normal certain condition and environment.
(Airflow step is 'High', Air discharge angle is fixed as indicated angle.)
- Indoor airflow distribution under actual installation or operating conditions depends on ambient temperature, ceiling height, product installation direction / location, indoor / Heating load, and other obstacles, etc.

7. Air Velocity and Temperature Distribution

◆ Floor Installation

Cooling

Discharge angle:45°

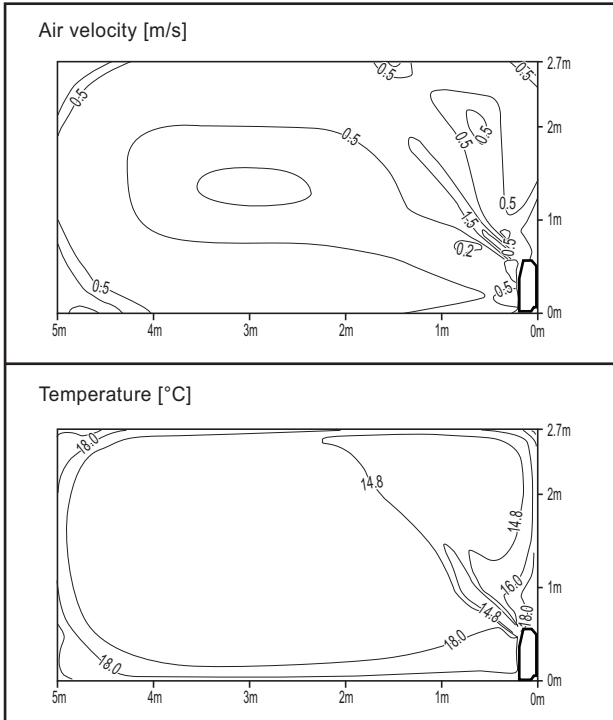

Heating

Discharge angle:50°

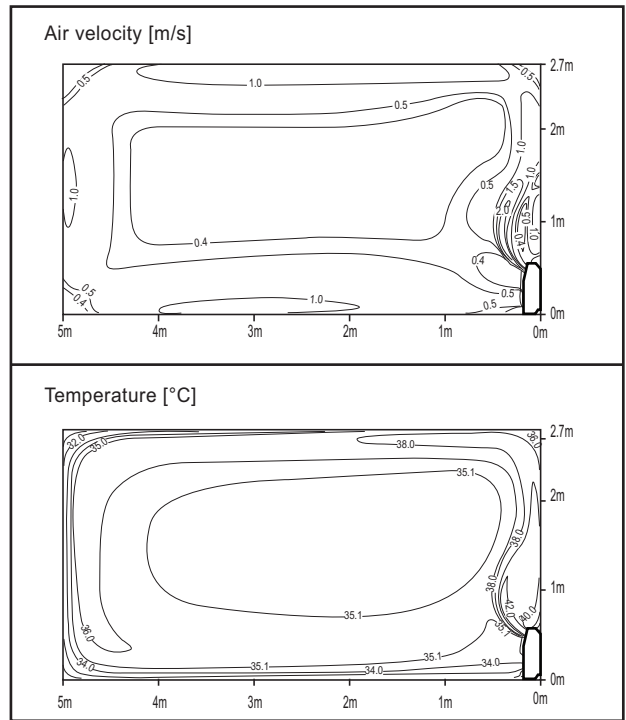

Note

- These figures are accordance with normal certain condition and environment. (Airflow step is 'High', Air discharge angle is fixed as indicated angle.)
- Indoor airflow distribution under actual installation or operating conditions depends on ambient temperature, ceiling height, product installation direction / location, indoor / Heating load, and other obstacles, etc.

7. Air Velocity and Temperature Distribution

■ ARUN12GVEA4

◆ Ceiling Installation

Cooling

Discharge angle:50°

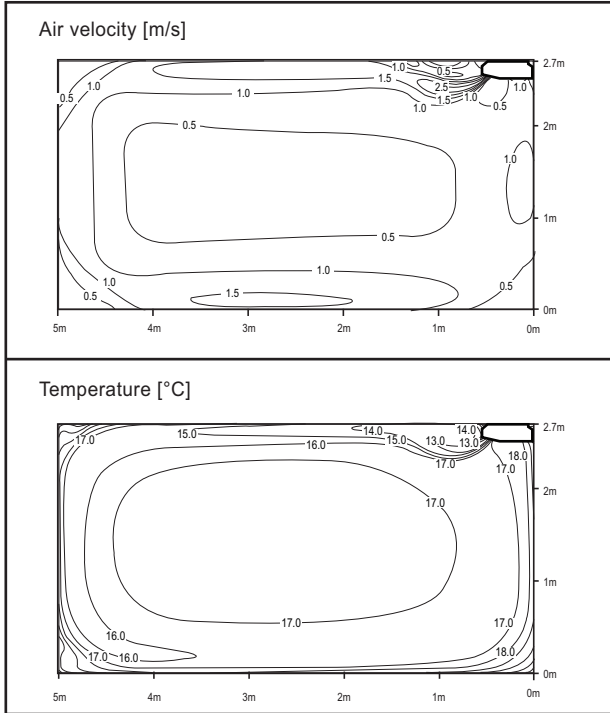

Heating

Discharge angle:60°

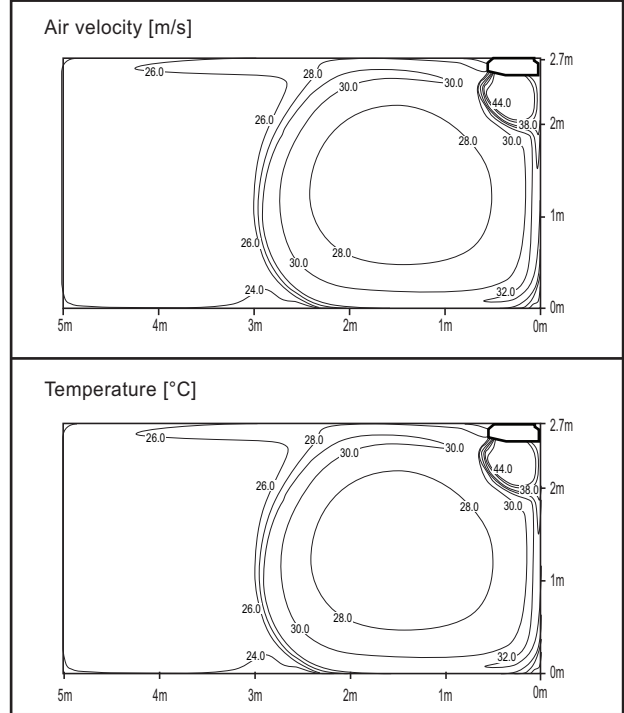

Note

- These figures are accordance with normal certain condition and environment. (Airflow step is 'High', Air discharge angle is fixed as indicated angle.)
- Indoor airflow distribution under actual installation or operating conditions depends on ambient temperature, ceiling height, product installation direction / location, indoor / Heating load, and other obstacles, etc.

7. Air Velocity and Temperature Distribution

◆ Floor Installation

Cooling

Discharge angle:50°

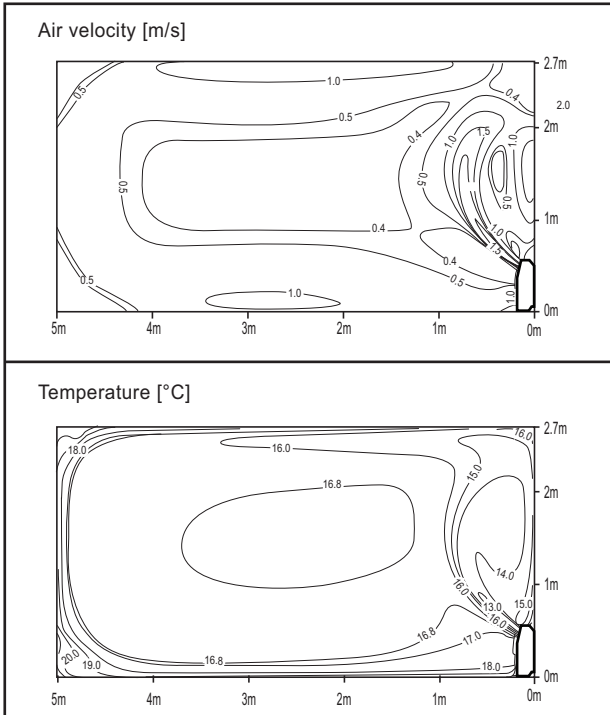

Heating

Discharge angle:60°

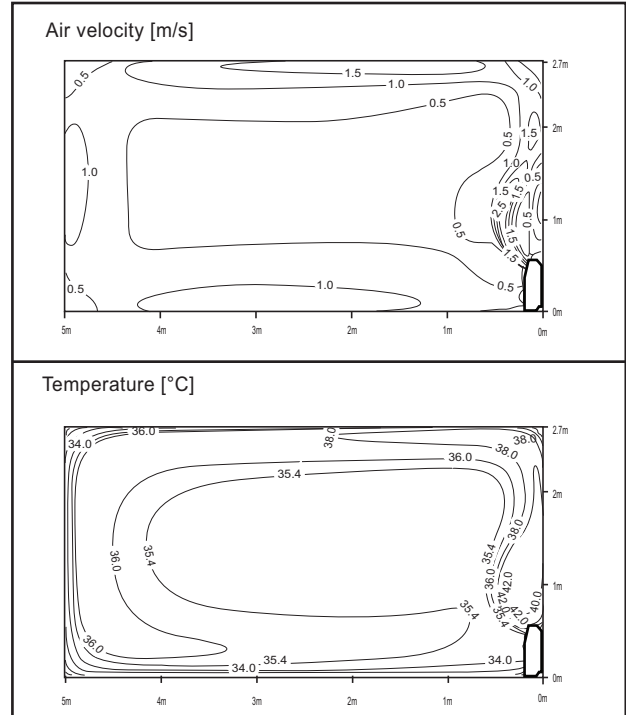

Note

- These figures are accordance with normal certain condition and environment. (Airflow step is 'High', Air discharge angle is fixed as indicated angle.)
- Indoor airflow distribution under actual installation or operating conditions depends on ambient temperature, ceiling height, product installation direction / location, indoor / Heating load, and other obstacles, etc.

8. Electric Characteristics

Units					Power Supply	IFM		PI	
Model	Type	Hz	Volts	Voltage Range	MCA	kW	FLA	Cooling	Heating
ARNU09GVEA4	VE	50	220-240	Min.:198, Max.:264	0.31	0.027	0.25	30	30
ARNU12GVEA4	VE				0.31	0.027	0.25	30	30
ARNU09GVEA4	VE	60	220	Min.:198, Max.:242	0.31	0.027	0.25	30	30
ARNU12GVEA4	VE				0.31	0.027	0.25	30	30

Symbols

MCA : Minimum Circuit Amperes (A)

MFA : Maximum Fuse Amperes (A)

kW : Fan Motor Rated Output (kW)

FLA : Full Load Amperes (A)

IFM : Indoor Fan Motor

PI : Maximum Power Input (W)

Note

- Voltage range
Units are suitable for use on electrical systems where voltage supplied to unit terminals is not below or above the listed range limits.
- Maximum allowable voltage unbalance between phases is 2%.
- MCA/MFA
 $MCA = 1.25 \times FLA$
 $MFA = 1.1 \times MCA, MFA \leq 4 \times FLA$
 (If MFA is smaller than minimum standard value, Use minimum standard value in region for selecting circuit breaker.)
- Select wire size based on the MCA
- Instead of fuse, use Circuit Breaker.

9. Sound Levels

9.1 Sound Pressure Levels

Overall

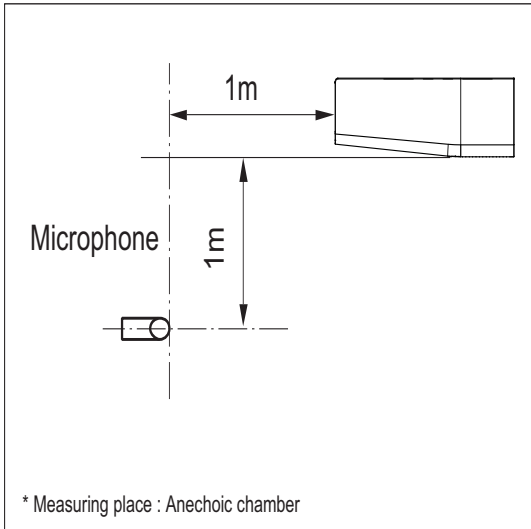

Note

1. Sound measured at some distance away from the center of the unit.
2. Data is valid at free field condition.
3. Reference acoustic pressure 0dB = 20μPa.
4. Data is valid at nominal operation condition.
Refer to the Model Specifications for nominal conditions(Power source and Ambient temperature, etc)
5. Sound levels can be increased in accordance with installation and operating conditions. (Static pressure mode, used air guide, Room target temperature setting, etc)
6. Sound level will vary depending on a range of factors such as the construction(acoustic absorption coefficient) of particular room in which the equipment is installed.
7. Sound pressure level is measured on the rated condition in the anechoic rooms by ISO 3745 standard.
Therefore, these values can be increased owing to ambient conditions during operation.

Model	Sound Pressure Levels [dB(A)]		
	H	M	L
ARNU09GVEA4	36	32	28
ARNU12GVEA4	38	36	30

ARNU09GVEA4

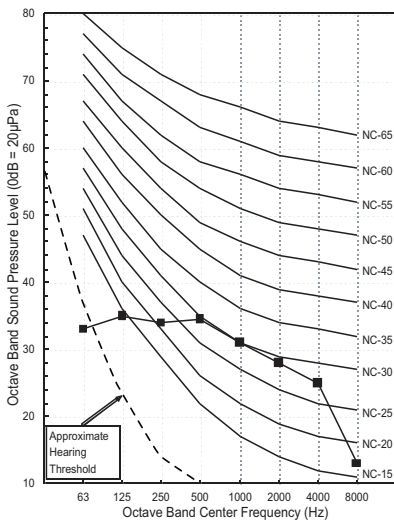

ARNU12GVEA4

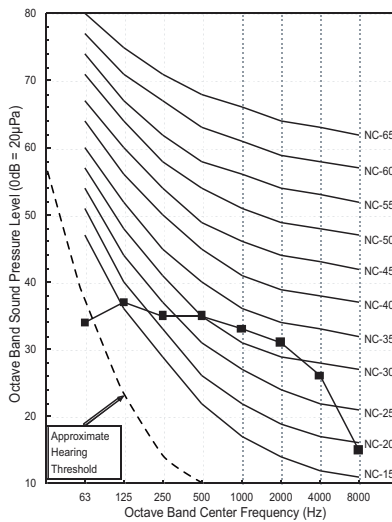

Ceiling Suspended Unit

- 1. List of functions**
- 2. Specifications**
- 3. Dimensions**
- 4. Piping Diagrams**
- 5. Wiring Diagrams**
- 6. Capacity Tables**
- 7. Air Velocity and Temperature Distribution**
- 8. Electric Characteristics**
- 9. Sound Levels**

1. List of functions

Category	Function	ARNU18GV1A4, ARNU24GV1A4, ARNU36GV2A4, ARNU48GV2A4
Air Flow	Air Supply Outlet	1
	Airflow Direction Control (left & right)	Auto
	Airflow Direction Control (up & down)	Auto
	Auto Swing (left & right)	O
	Auto Swing (up & down)	O
	Airflow Steps (fan/cool/heat)	3 / 4 / 4
	Fan Speed Auto*	Advanced
	Power Cool/Heat	O / O
	Swirl Wind*	X
	Refresh Mode**	X
	Smart Mode**	X
	Indirect Wind*	X
	Direct Wind*	X
Dry Operation	O	
Air Purification	Air Purify	X
	Ionizer	X
	UV-C	X
	Pre-Filter	O
Reliability	Hot Start	O
	Self Diagnosis	O
Convenience	Auto Mode	O
	Auto Dry Operation	O
	Auto Restart	O
	Child Lock*	O
	Forced Operation	O
	Group Control*	O
	Sleep Timer	O
	Turn On/Off Reservation	O
	Schedule*	O
	Two Thermistor Control*	O
External On/Off	O	
Installation	Drain Pump	X
	E.S.P. Control*	X
	High Ceiling Operation*	O
Special Functions	Wi-Fi	Accessory
	Auto Elevation Grille	X
	Human Detection Function**	X
	Floor Detection Function**	X

Note

- O : Applied, X : Not Applied, - : Unconfirmed or irrelevant
Embedded : A kit is provided by default for using this function when the product is manufactured.
Accessory : Ordered and purchased separately the accessory package referring to the model name provided and install at field. Accessory line-ups varies by region, so check your local catalogue or local sales material.
- Some functions can be limited by remote controller.
- In case of cassette type indoor units, Air Purification Kit and Auto Elevation Grille functions are not applicable at the same time.
- 'Auto Mode' varies depending on the outdoor unit type.
 - Auto Change Over(Heat Recovery Outdoor Unit)
 - Auto Mode Select(Heat Pump Outdoor Unit)
 - Auto Intensity Control(Cooling Only Outdoor Unit)
- * : These functions need to connect the wired remote controller.
- ** : This functions need to connect to the Standard III wired remote controller.

1. List of functions

■ Accessory Compatibility List

Category	Accessory Name	Model Name	Description	ARNU18GV1A4 ARNU24GV1A4 ARNU36GV2A4 ARNU48GV2A4
Remote Controller	Wired - Premium	PREMTA000	-	○
		PREMTA000A	-	○
		PREMTA000B	-	○
	Wired - RS3 (Standard III)	PREMTB100/PREMTB101	White	○
		PREMTBB10/PREMTBB11	Black	○
	Wired - RS2 (Standard II)	PREMTB001	White	○
		PREMTBB01	Black	○
	Wired - Simple	PQRCVCL0QW	White	○
		PQRCVCL0Q	Black	○
	Wired - Simple for Hotel	PQRCHCA0QW	White	○
		PQRCHCA0Q	Black	○
	Wireless	PQWRCQ0FDB	For Cooling only	○
PQWRHQ0FDB		For Heat pump	○	
PWLSSB21C		For Cooling only	○	
PWLSSB21H		For Heat pump	○	
Dry Contact	Simple	PDRYCB000	1 input port, AC 220 - 240V	○
		PDRYCB100	1 input port, AC 24V	○
	Communication	PDRYCB400	2 input port	○
		PDRYCB300	8 input port, For 3rd party Thermostat	○
		PDRYCB320	8 input port, For 3rd Party Thermostat (Analog Input)	○
PDRYCB500	For 3rd Party Controller (Modbus RTU)	○		
Integration Device	Remote Temperature sensor	PQRSTA0	-	X
	Group Control wire	PZCWRCG3	Cable Assembly for group control (Y-type cable : 0.25m, cable : 9.6m)	○
ETC	Extension wire	PZCWRC1	Extension wire for IDU-wired remote controller (9.6m)	X
	2-Remo Control Wire	PZCWRC2	-	X
	Wi-Fi Modem	PWFMDD200	-	○
	Wi-Fi Extension cable	PWYREW000	USB Extension cable : 10 m	○
	Independent Power Module	PRIP0	-	○
	Multi-tenant Power Module	PINPMB001	-	○
	Refrigerant Leakage Detector	PRLDNVS0	For R410A only	○
	Human Detection Sensor	PTVSMA0	For Cassette 4-way	X
		PTVSAA0	For Cassette Dual Vane 4-way	X
	Floor Detection Sensor	PTFSMA0	-	X
	Auto Elevation Grille	PTEGM0	For TP/TN/TM	X
	Air Purification Kit	PTAHTP0	For Cassette 1-way	X
		PTAHMP0	For Cassette 4-way	X
		PTAHYP0	For Cassette Round	X
	EEV Kit	PRGK024A0	For Multi V Indoor Unit	X
	Auxiliary Heater Relay Kit	PRARS1	For Wall Mounted and Art Cool Indoor Units	X
		PRARH1	For Cassette and Duct Indoor Units	○
	Ventilation Kit	PTVK430	For TR/TQ/TP/TN/TM	X
		PTVK410 + PTVK420	For TP/TN/TM	X
	Cassette Cover	PTDCQ	For TR/TQ	X
PTDCM		For TP/TN/TM	X	
PTDCA		For TM-A/TP-B	X	
Note				
1. ○: Possible, X: Impossible, - : Not applicable, Embedded : Included with product.				
2. If there is a difference in development time between the product and the remote controller, some functions cannot be operated.				
3. If using Wi-Fi controller, Some advanced functions controlled by remote controller cannot be operated.				
4. If you need more detail, please refer to the BECON PDB or the manual of product. (http://partner.lge.com/global : Home> Doc.Library> Product > Control(BECON))				

2. Specifications

Type			Ceiling Suspended Unit	
Model		Unit	ARNU18GV1A4	ARNU24GV1A4
Cooling Capacity		kW	5.6	7.1
		kcal/h	4,800	6,100
		Btu/h	19,100	24,200
Heating Capacity		kW	6.3	8
		kcal/h	5,400	6,900
		Btu/h	21,500	27,300
Power Input (H / M / L)		W	23 / 20 / 17	25 / 21 / 17
Casing			Galvanized Steel Plate + Painting	
Dimensions (W × H × D)	Body	mm	1,200 × 235 × 690	1,200 × 235 × 690
		inch	47-1/4 × 9-1/4 × 27-3/16	47-1/4 × 9-1/4 × 27-3/16
Coil	Rows × Columns × FPI		3 × 18 × 18	3 × 18 × 18
	Face Area	m ²	0.32	0.32
Fan	Type		Cross Flow Fan	Cross Flow Fan
	Motor Output × Number	W × No.	85.9 × 1	85.9 × 1
	Air Flow Rate (H / M / L)	m ³ /min	13.5 / 12.5 / 12.0	14.0 / 13.0 / 12.0
		ft ³ /min	477 / 441 / 424	495 / 459 / 424
	Drive		Direct	Direct
Motor type		BLDC	BLDC	
Temperature Control			Microprocessor, Thermostat for cooling and heating	
Sound Absorbing Thermal Insulation Material			Foamed polystyrene	Foamed polystyrene
Safety Device			Fuse	Fuse
Pipe Connections	Liquid Side	mm(inch)	Ø6.35(1/4)	Ø9.52(3/8)
	Gas Side	mm(inch)	Ø12.7(1/2)	Ø15.88(5/8)
	Drain (O.D. / I.D.)	mm	Ø 25.0 / 16.0	Ø 25.0 / 16.0
Net Weight		kg(lbs)	29.0 (63.9)	29.0 (63.9)
Shipping Weight		kg(lbs)	36.0 (79.4)	36.0 (79.4)
Sound Pressure Levels (H / M / L)		dB(A)	36 / 34 / 33	37 / 35 / 33
Sound Power Levels (H / M / L)		dB(A)	61 / 59 / 56	62 / 59 / 56
Power Supply		Ø, V, Hz	1, 220 - 230 - 240, 50/60	1, 220 - 230 - 240, 50/60
Running Current by voltage	Rated	A	0.18 - 0.17 - 0.16	0.20 - 0.19 - 0.18
Maximum Running Current		A	0.97	0.97
Refrigerant	Type		R410A / R32	R410A / R32
	Additional Charging Amount (CF Value of IDU)		kg(each)	0.53 / 0.44
	Control		-	EEV
Transmission Cable		mm ² × Cores	1.0 ~ 1.5 × 2C	1.0 ~ 1.5 × 2C

Note

1. Due to our policy of innovation some specifications may be changed without notification.
2. Wiring cable size must comply with the applicable local and national code. And "Electric characteristics" chapter should be considered for electrical work and design. Especially the power cable and circuit breaker should be selected in accordance with that.
3. Sound pressure level is measured on the rated condition in the anechoic rooms by ISO 3745 standard.
Sound power level is measured on the rated condition in the semi-anechoic rooms by ISO 9614 standard.
Therefore, these values can be increased owing to ambient conditions during operation.
4. Capacities are net capacities and based on the following conditions. Refer to the Outdoor Unit Specifications for calculating the real capacity.
 - Cooling : Indoor Ambient Temp. 27°CDB / 19°CWB, Outdoor Ambient Temp. 35°CDB / 24°CWB
 - Heating : Indoor Ambient Temp. 20°CDB / 15°CWB, Outdoor Ambient Temp. 7°CDB / 6°CWB
 - Interconnected Pipe is standard length and difference of Elevation (Outdoor ~ Indoor Unit) is 0m.
5. Refrigerant information (type, additional charging amount, etc.) must be applied by refrigerant type of the combined outdoor unit.
Adapt after checking the specifications of outdoor unit.

2. Specifications

Type			Ceiling Suspended Unit	
Model		Unit	ARNU36GV2A4	ARNU48GV2A4
Cooling Capacity		kW	10.6	14.1
		kcal/h	9,100	12,100
		Btu/h	36,200	48,100
Heating Capacity		kW	11.9	15.9
		kcal/h	10,200	13,200
		Btu/h	40,600	51,200
Power Input (H / M / L)		W	84 / 77 / 66	91 / 79 / 66
Casing			Galvanized Steel Plate + Painting	
Dimensions (W × H × D)	Body	mm	1,600 × 235 × 690	1,600 × 235 × 690
		inch	63 × 9-1/4 × 27-5/32	63 × 9-1/4 × 27-5/32
Coil	Rows × Columns × FPI		3 × 18 × 18	3 × 18 × 18
	Face Area	m ²	0.46	0.46
Fan	Type		Cross Flow Fan	Cross Flow Fan
	Motor Output × Number	W × No.	125 × 1	125 × 1
	Air Flow Rate (H / M / L)	m ³ /min	27.0 / 24.0 / 20.0	29.0 / 24.0 / 20.0
		ft ³ /min	954 / 848 / 706	1,024 / 848 / 706
	Drive		Direct	Direct
Motor type		BLDC	BLDC	
Temperature Control			Microprocessor, Thermostat for cooling and heating	
Sound Absorbing Thermal Insulation Material			Foamed polystyrene	Foamed polystyrene
Safety Device			Fuse	Fuse
Pipe Connections	Liquid Side	mm(inch)	Ø9.52(3/8)	Ø9.52(3/8)
	Gas Side	mm(inch)	Ø15.88(5/8)	Ø15.88(5/8)
	Drain (O.D. / I.D.)	mm	Ø 25.0 / 16.0	Ø 25.0 / 16.0
Net Weight	Body	kg(lbs)	37.0 (81.6)	37.0 (81.6)
Shipping Weight		kg(lbs)	45.5 (100.3)	45.5 (100.3)
Sound Pressure Levels (H / M / L)		dB(A)	45 / 44 / 40.5	47 / 44 / 40.5
Sound Power Levels (H / M / L)		dB(A)	68 / 66 / 64	68 / 67 / 66
Power Supply		Ø, V, Hz	1, 220 - 230 - 240, 50/60	1, 220 - 230 - 240, 50/60
Running Current by voltage	Rated	A	0.46 - 0.44 - 0.42	0.50 - 0.48 - 0.46
Maximum Running Current		A	0.97	0.97
Refrigerant	Type		R410A / R32	R410A / R32
	Additional Charging Amount (CF Value of IDU)		kg(each)	0.79 / 0.66
	Control		-	EEV
Transmission Cable		mm ² × Cores	1.0 ~ 1.5 × 2C	1.0 ~ 1.5 × 2C

Note

1. Due to our policy of innovation some specifications may be changed without notification.
2. Wiring cable size must comply with the applicable local and national code. And "Electric characteristics" chapter should be considered for electrical work and design. Especially the power cable and circuit breaker should be selected in accordance with that.
3. Sound pressure level is measured on the rated condition in the anechoic rooms by ISO 3745 standard.
Sound power level is measured on the rated condition in the semi-anechoic rooms by ISO 9614 standard.
Therefore, these values can be increased owing to ambient conditions during operation.
4. Capacities are net capacities and based on the following conditions. Refer to the Outdoor Unit Specifications for calculating the real capacity.
 - Cooling : Indoor Ambient Temp. 27°CDB / 19°CWB, Outdoor Ambient Temp. 35°CDB / 24°CWB
 - Heating : Indoor Ambient Temp. 20°CDB / 15°CWB, Outdoor Ambient Temp. 7°CDB / 6°CWB
 - Interconnected Pipe is standard length and difference of Elevation (Outdoor ~ Indoor Unit) is 0m.
5. Refrigerant information (type, additional charging amount, etc.) must be applied by refrigerant type of the combined outdoor unit.
Adapt after checking the specifications of outdoor unit.

3. Dimensions

3.1 Dimensional Drawings

ARNU18GV1A4 / ARNU24GV1A4

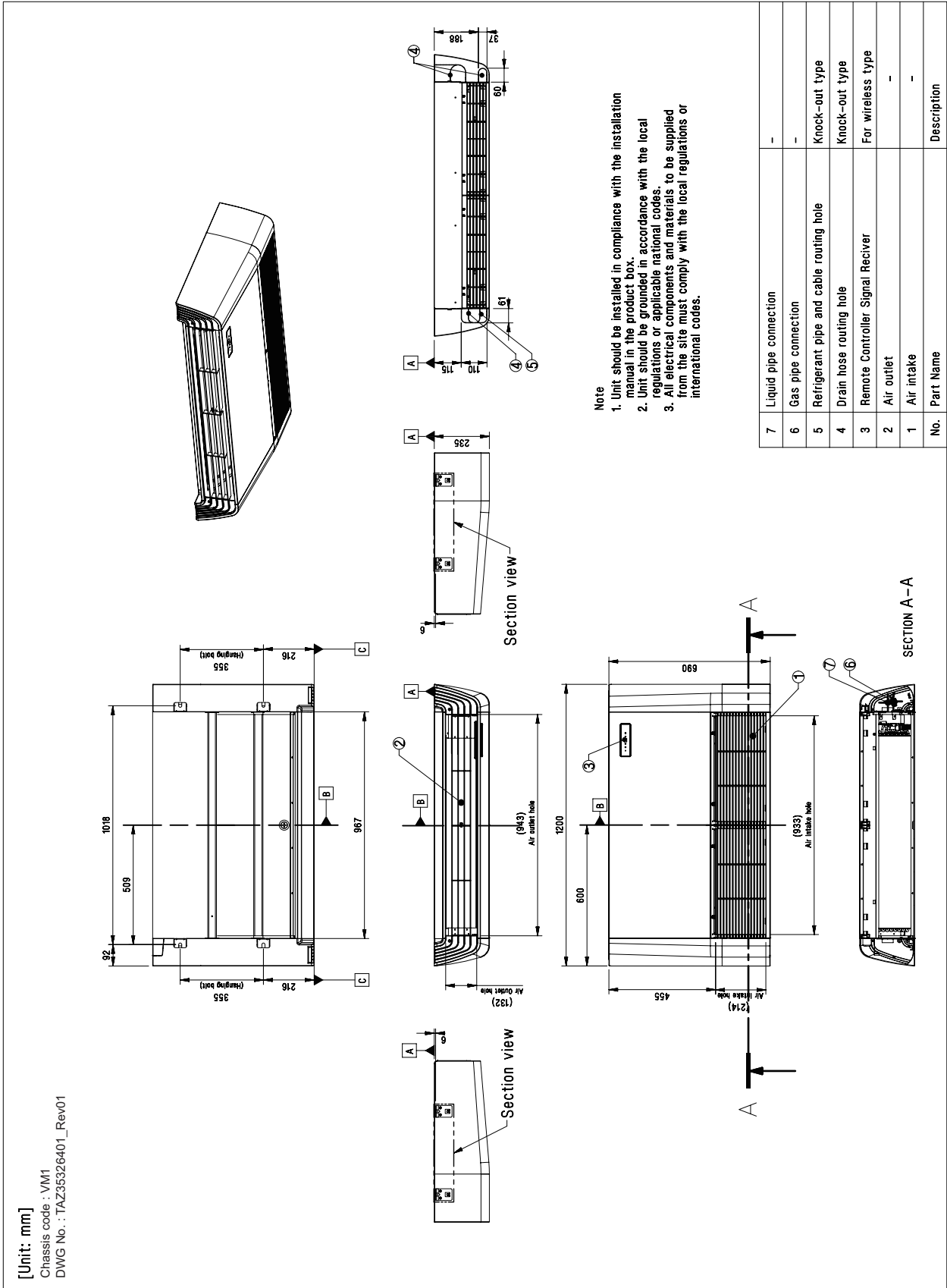

[Unit: mm]
 Chassis code : VM1
 DWG No. : TAZ35326401_Rev01

Note
 1. Unit should be installed in compliance with the installation manual in the product box.
 2. Unit should be grounded in accordance with the local regulations or applicable national codes.
 3. All electrical components and materials to be supplied from the site must comply with the local regulations or international codes.

No.	Part Name	Description
7	Liquid pipe connection	-
6	Gas pipe connection	-
5	Refrigerant pipe and cable routing hole	Knock-out type
4	Drain hose routing hole	Knock-out type
3	Remote Controller Signal Receiver	For wireless type
2	Air outlet	-
1	Air intake	-

3. Dimensions

ARNU36GV2A4 / ARNU48GV2A4

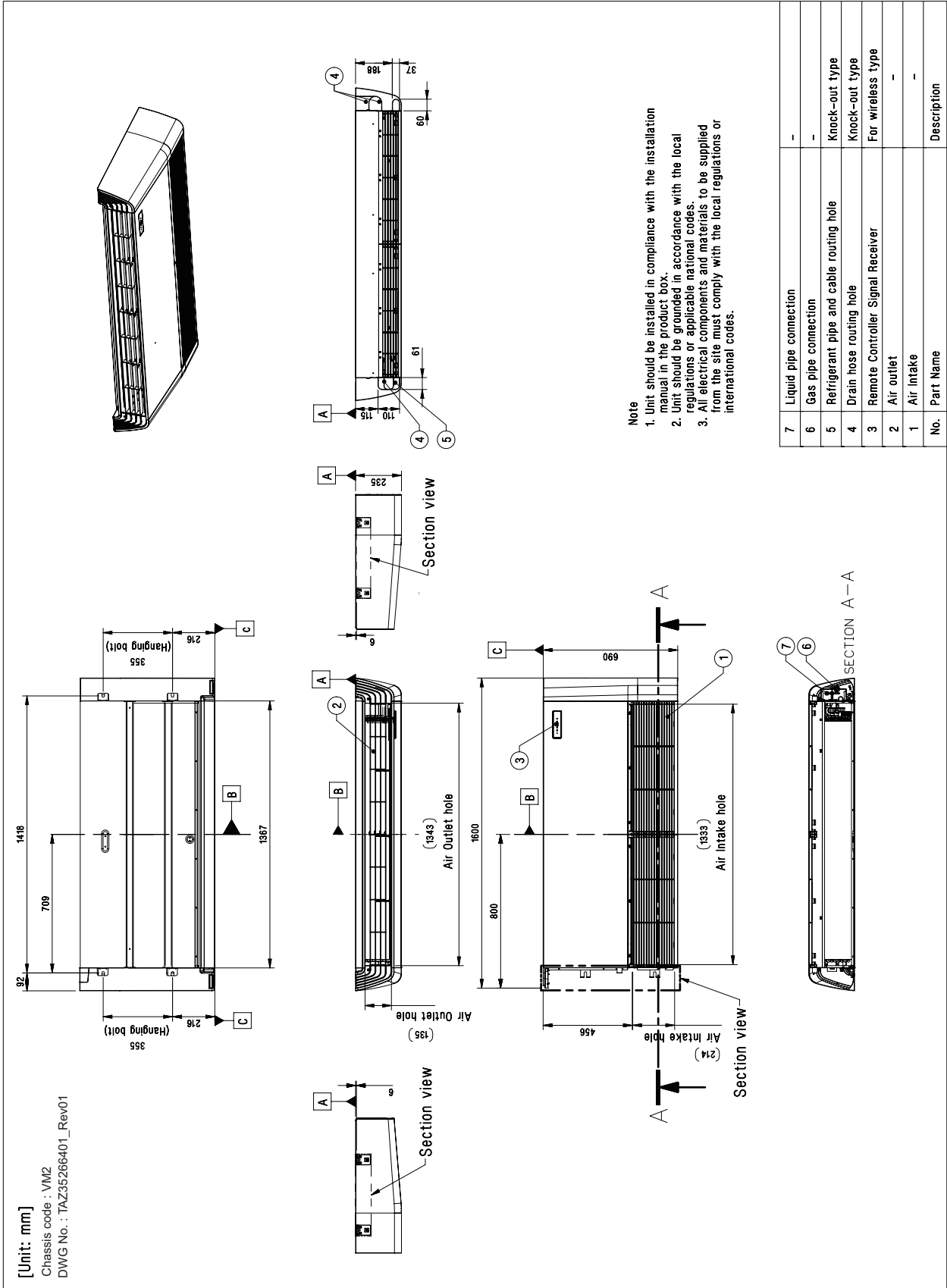

3. Dimensions

3.2 Installation Space

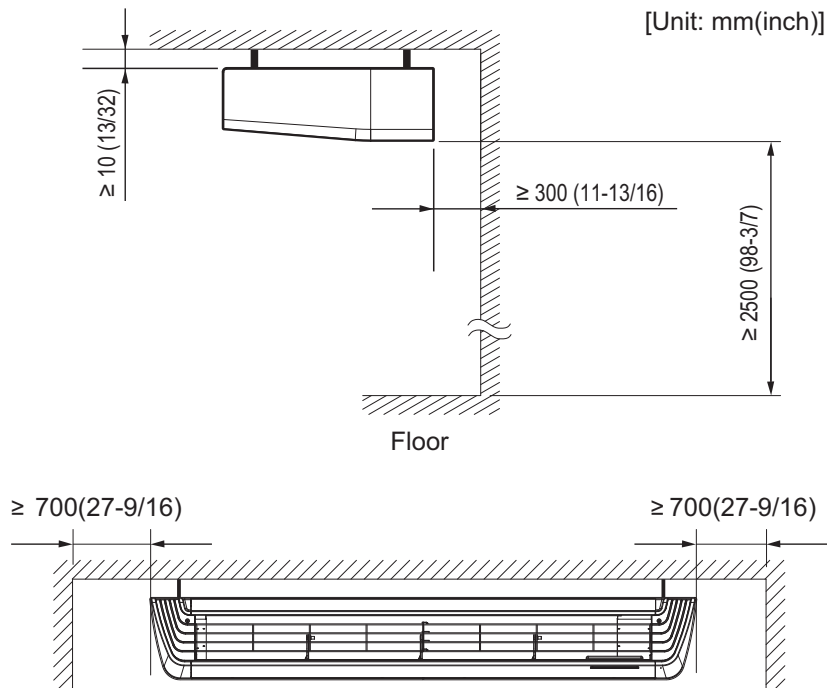

Note

- Places where products are installed should not be any obstacles to the air circulation or installation. Ensure the spaces from the wall, ceiling, or other obstacles.
- According to type of indoor unit, external appearance or installed structure could be different.
- According to product type, model line up, sales region..etc, applicability of each chassis could be different.

4. Piping Diagrams

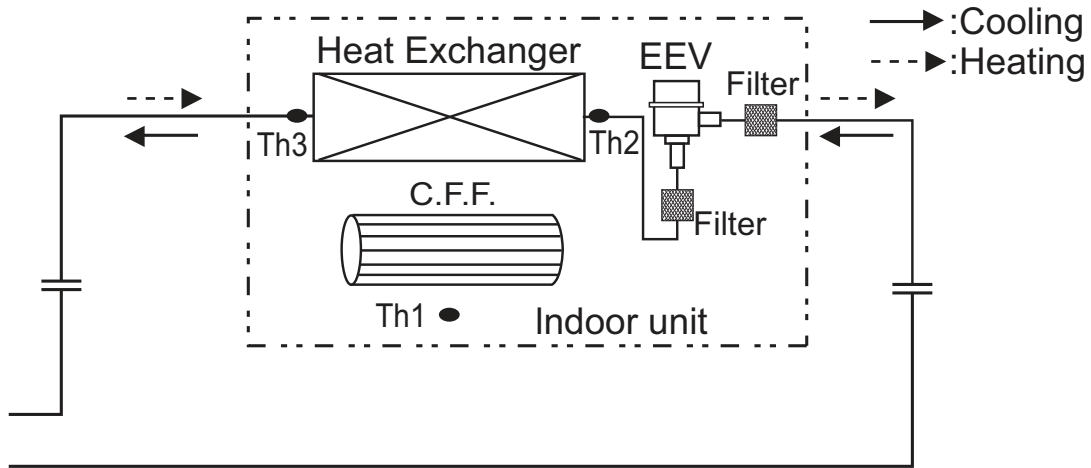

◆ Refrigerant pipe connection port diameter

Model	Gas [mm(inch)]	Liquid [mm(inch)]
ARNU18GV1A4	Ø12.7(1/2)	Ø6.35(1/4)
ARNU24GV1A4	Ø15.88(5/8)	Ø9.52(3/8)
ARNU36GV2A4	Ø15.88(5/8)	Ø9.52(3/8)
ARNU48GV2A4	Ø15.88(5/8)	Ø9.52(3/8)

LOC.	Description
Th1	Room thermistor
Th2	Pipe in thermistor
Th3	Pipe out thermistor

5. Wiring Diagrams

VM1,VM2 Chassis

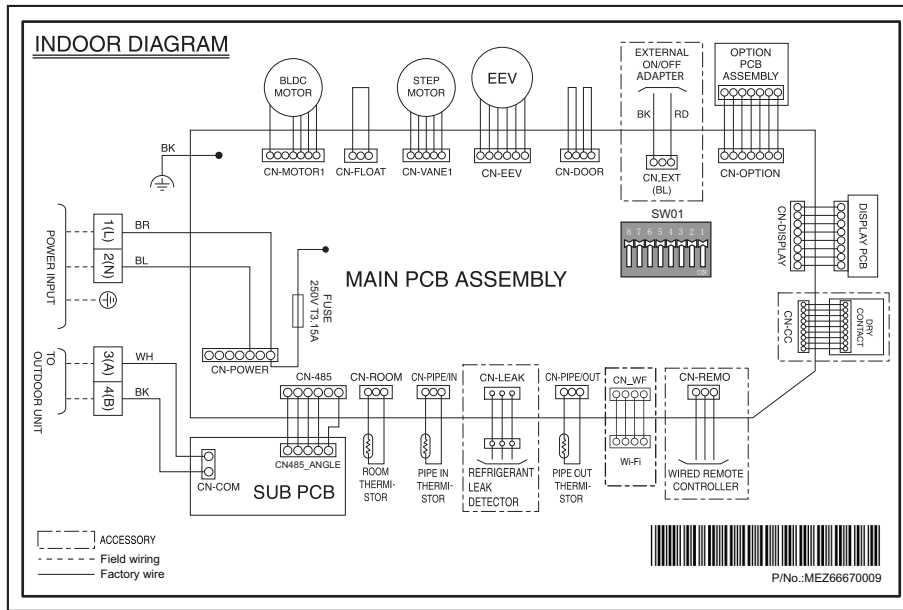

CONNECTOR NUMBER	LOCATION POINT	FUNCTION
CN-POWER	AC Power supply	AC Power line input for indoor controller
CN-MOTOR1	Fan motor output	Motor output of BLDC
CN-485	Communication	Connection between indoor and outdoor
CN-DISPLAY	Display	Display of indoor status
CN-EEV	EEV Output	EEV Control output : connect to EEV directly or through IPM(Independent Power Module)
CN-LEAK	Refrigerant leak detector	Refrigerant leak detector line
CN-VANE1	Step motor	Step motor output
CN-FLOAT	Float switch input	Float switch sensing
CN-PIPE_IN	Suction pipe sensor	Pipe in thermistor
CN-PIPE_OUT	Discharge pipe sensor	Pipe out thermistor
CN-ROOM	Room sensor	Room air thermistor
CN-REMO	Remote controller	Remote control line
CN-CC	Dry contact	Dry contact line
CN-OPTION	Option pwb.	Communication between main and option
CN-EXT	External On/Off	External On/Off signal input
CN-DOOR	- (not used)	-

Dip Switch Setting		Off	On	Remarks
SW3	GROUP	Master	Slave	Group Control setting using Wired Remote Controller
SW4	DRY CONTACT	Variable	Auto	Old Dry Contact Mode Setting 1. Variable : Auto/Manual Mode can be chosen by Wide wired remote controller or Wireless remote controller (When shipped from Factory → Manual Mode) 2. Auto : For Dry Contact, it is always Auto mode.
SW5	EXTRA 1	Off	On	1. Duct model -. OFF : Default(not operate continuously) -. ON : Fan operate continuously 2. Cassette Model : No Function 3. Ceiling Suspended Model -. OFF : Ceiling(default) -. ON : Floor

CAUTION

For Multi V Model, Dip Switch 1,2,6,7,8 must be set OFF

That dip switch is used for the other model.

6. Capacity Tables

■ Cooling Capacity

Nominal Capacity (kBtu/h) [Capacity Index (kW)]	Indoor air temp. (DB/WB, °C)													
	20		23		26		27		28		30		32	
	14		16		18		19		20		22		24	
	TC	SHC	TC	SHC	TC	SHC	TC	SHC	TC	SHC	TC	SHC	TC	SHC
18 [5.6]	3.8	3.2	4.5	3.7	5.2	4.1	5.6	4.2	6.0	4.3	6.1	4.2	6.2	4.0
24 [7.1]	4.8	3.8	5.7	4.3	6.6	4.8	7.1	4.9	7.6	5.0	7.7	4.8	7.8	4.7
36 [10.6]	7.2	6.3	8.5	7.2	9.9	8.1	10.6	8.3	11.3	8.4	11.5	8.1	11.6	7.9
48 [14.1]	9.5	7.6	11.3	8.7	13.1	9.8	14.1	10.0	15.1	10.2	15.3	9.8	15.5	9.5

Note

1. TC: Total Capacity(kW), SHC: Sensible Heat Capacity(kW)
2. Capacity tables show the average value of conditions which may occur.
3. Refer to Capacity tables and correction factor in the outdoor unit PDB for the actual performance data of each indoor unit and outdoor unit combination.

■ Heating Capacity

Nominal Capacity (kBtu/h) [Capacity Index (kW)]	Indoor air temp. (DB, °C)					
	16	18	20	21	22	24
	TC	TC	TC	TC	TC	TC
18 [5.6]	7.1	6.7	6.3	6.1	5.9	5.5
24 [7.1]	9.0	8.5	8.0	7.7	7.5	7.0
36 [10.6]	13.4	12.7	11.9	11.5	11.1	10.4
48 [14.1]	17.9	16.9	15.9	15.4	14.9	13.9

Note

1. TC: Total Capacity(kW)
2. Capacity tables show the average value of conditions which may occur.
3. Refer to Capacity tables and correction factor in the outdoor unit PDB for the actual performance data of each indoor unit and outdoor unit combination.

7. Air Velocity and Temperature Distribution

◆ ARNU18GV1A4, ARNU24GV1A4

Cooling

Discharge angle: 0°

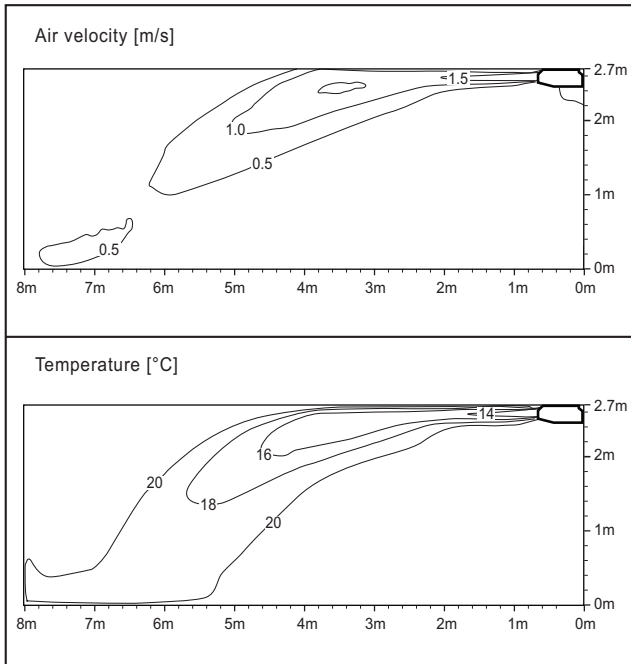

Heating

Discharge angle: 0°

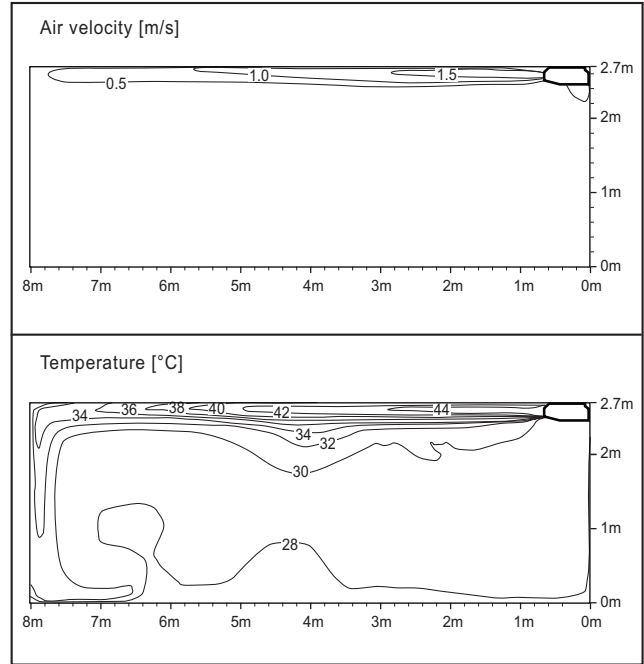

◆ ARNU36GV2A4

Cooling

Discharge angle: 0°

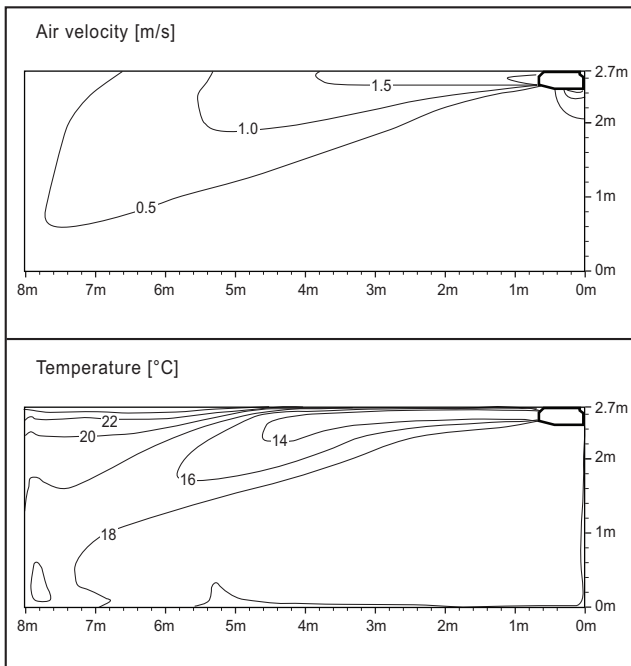

Heating

Discharge angle: 0°

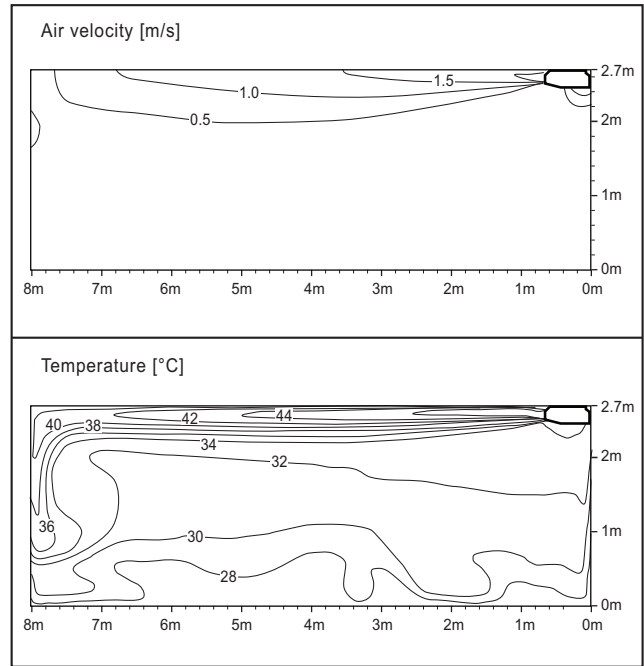

Note

- These figures are accordance with normal certain condition and environment. (Airflow step is 'High', Air discharge angle is fixed as indicated angle.)
- Indoor airflow distribution under actual installation or operating conditions depends on ambient temperature, ceiling height, product installation direction / location, indoor / Heating load, and other obstacles, etc.

7. Air Velocity and Temperature Distribution

◆ ARNU48GV2A4

Cooling

Discharge angle: 0°

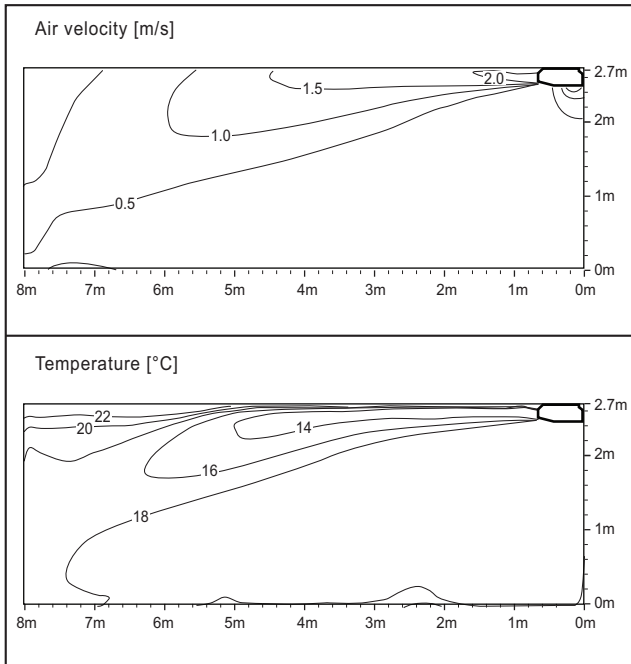

Heating

Discharge angle: 0°

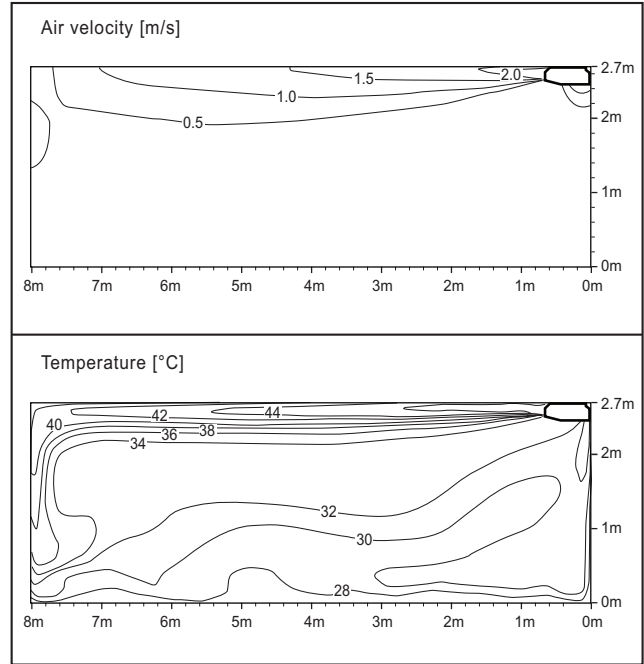

Note

- These figures are accordance with normal certain condition and environment. (Airflow step is 'High', Air discharge angle is fixed as indicated angle.)
- Indoor airflow distribution under actual installation or operating conditions depends on ambient temperature, ceiling height, product installation direction / location, indoor / Heating load, and other obstacles, etc.

8. Electric Characteristics

Units					Power Supply	IFM		PI	
Model	Type	Hz	Volts	Voltage Range	MCA	kW	FLA	Cooling	Heating
ARNU18GV1A4	VM1	50	220-240	Min.:198, Max.:264	1.21	0.086	0.97	130	130
ARNU24GV1A4	VM1				1.21	0.086	0.97	130	130
ARNU36GV2A4	VM2				1.21	0.125	0.97	184	184
ARNU48GV2A4	VM2				1.21	0.125	0.97	184	184
ARNU18GV1A4	VM1	60	220	Min.:198, Max.:242	1.21	0.086	0.97	130	130
ARNU24GV1A4	VM1				1.21	0.086	0.97	130	130
ARNU36GV2A4	VM2				1.21	0.125	0.97	184	184
ARNU48GV2A4	VM2				1.21	0.125	0.97	184	184

Symbols

MCA : Minimum Circuit Amperes (A)

MFA : Maximum Fuse Amperes (A)

kW : Fan Motor Rated Output (kW)

FLA : Full Load Amperes (A)

IFM : Indoor Fan Motor

PI : Maximum Power Input (W)

Note

1. Voltage range

Units are suitable for use on electrical systems where voltage supplied to unit terminals is not below or above the listed range limits.

2. Maximum allowable voltage unbalance between phases is 2%.

3. MCA/MFA

$$\text{MCA} = 1.25 \times \text{FLA}$$

$$\text{MFA} = 1.1 \times \text{MCA}, \text{MFA} \leq 4 \times \text{FLA}$$

(If MFA is smaller than minimum standard value, Use minimum standard value in region for selecting circuit breaker.)

4. Select wire size based on the MCA

5. Instead of fuse, use Circuit Breaker.

9. Sound Levels

9.1 Sound Pressure Levels

Overall

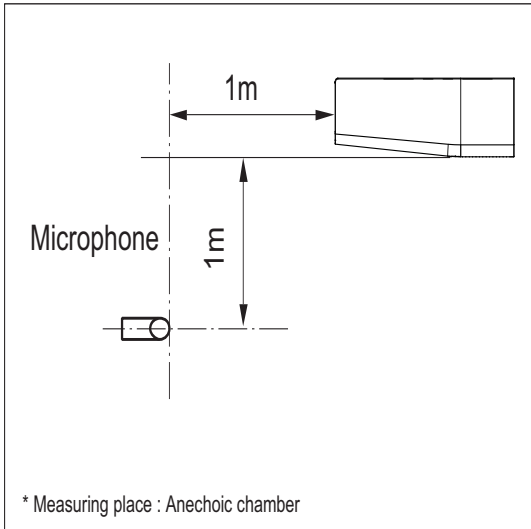

Note

1. Sound measured at some distance away from the center of the unit.
2. Data is valid at free field condition.
3. Reference acoustic pressure 0dB = 20μPa.
4. Data is valid at nominal operation condition.
Refer to the Model Specifications for nominal conditions(Power source and Ambient temperature, etc)
5. Sound levels can be increased in accordance with installation and operating conditions. (Static pressure mode, used air guide, Room target temperature setting, etc)
6. Sound level will vary depending on a range of factors such as the construction(acoustic absorption coefficient) of particular room in which the equipment is installed.
7. Sound pressure level is measured on the rated condition in the anechoic rooms by ISO 3745 standard.
Therefore, these values can be increased owing to ambient conditions during operation.

Model	Sound Levels [dB(A)]		
	H	M	L
ARNU18GV1A4	36	34	33
ARNU24GV1A4	37	35	33
ARNU36GV2A4	45	44	40.5
ARNU48GV2A4	47	44	40.5

ARNU18GV1A4

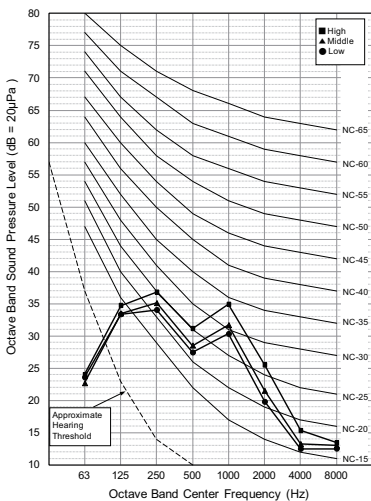

ARNU24GV1A4

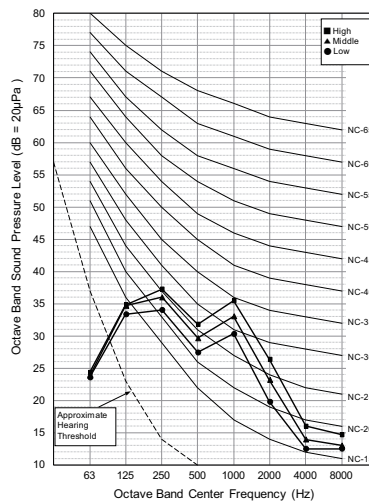

ARNU36GV2A4

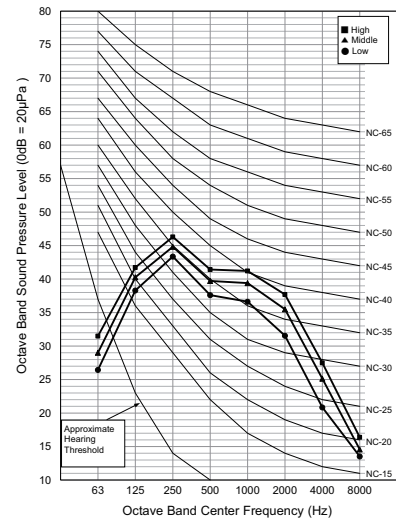

9. Sound Levels

ARNU48GV2A4

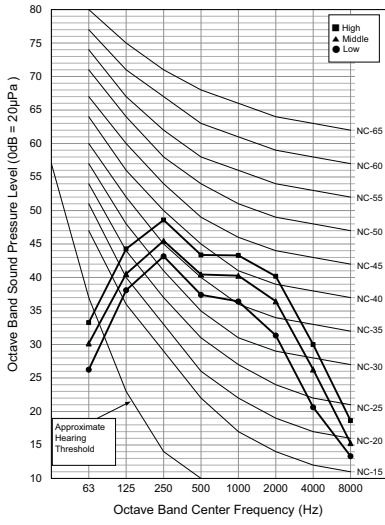

9. Sound Levels

9.2 Sound Power Levels

Note

1. Data is valid at diffuse field condition.
2. Data is valid at nominal operation condition.
Refer to the Model Specifications for nominal conditions(Power source and Ambient temperature, etc)
3. Sound level can be increased in static pressure mode or used air guide.
4. Sound level will vary depending on a range of factors such as the construction (acoustic absorption coefficient).
5. Reference acoustic intensity 0dB = $10E-6\mu W/m^2$
6. Sound power level is measured on the rated condition in the semi-anechoic rooms by ISO 9614 standard.
Therefore, these values can be increased owing to ambient conditions during operation.

Model	Sound Levels [dB(A)]		
	H	M	L
ARNU18GV1A4	61	59	56
ARNU24GV1A4	62	59	56
ARNU36GV2A4	68	66	64
ARNU48GV2A4	68	67	66

ARNU18GV1A4

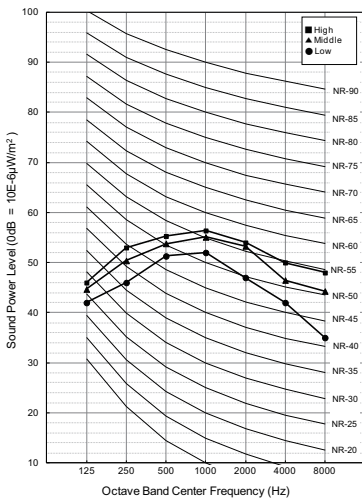

ARNU24GV1A4

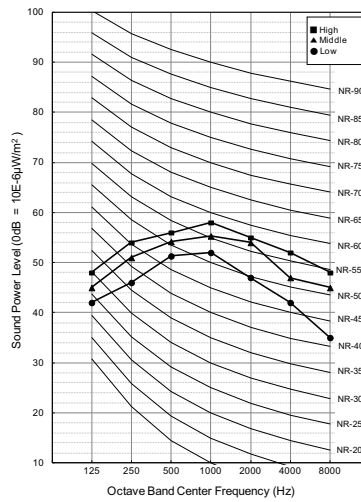

ARNU36GV2A4

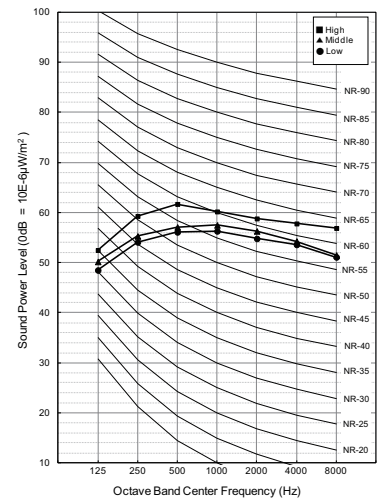

ARNU48GV2A4

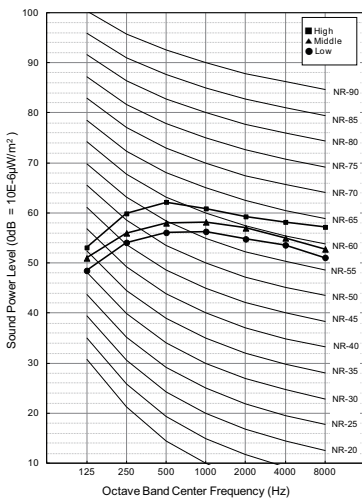

Floor Standing Unit(1)

- 1.List of functions**
- 2.Specifications**
- 3.Dimensions**
- 4.Piping Diagrams**
- 5.Wiring Diagrams**
- 6.Capacity Tables**
- 7.Air Velocity and Temperature Distribution**
- 8.External Static Pressure (E.S.P) & Air Flow**
- 9.Electric Characteristics**
- 10.Sound Levels**

1. List of functions

◆ List of functions

Category	Function	ARNU07GCEA4, ARNU09GCEA4, ARNU12GCEA4, ARNU15GCEA4, ARNU18GCFA4, ARNU24GCFA4, ARNU07GCEU4, ARNU09GCEU4, ARNU12GCEU4, ARNU15GCEU4, ARNU18GCFU4, ARNU24GCFU4
Air Flow	Air Supply Outlet	1
	Airflow Steps (fan/cool/heat)	3 / 3 / 3
	Fan Speed Auto*	X
	Power Cool/Heat	X / X
	Dry Operation	O
Air Purification	Air Purify	X
	Pre-Filter	O
Reliability	Hot Start	O
	Self Diagnosis	O
Convenience	Auto Mode	O
	Auto Dry Operation	O
	Auto Restart	O
	Child Lock*	O
	Group Control*	O
	Sleep Timer	O
	Turn On/Off Reservation	O
	Schedule*	O
	Two Thermistor Control*	O
External On/Off	O	
Installation	Drain Pump	X
	E.S.P. Control*	O
Special Functions	Wi-Fi	Accessory

Note

- O : Applied, X : Not Applied, - : Unconfirmed or irrelevant
Embedded : A kit is provided by default for using this function when the product is manufactured.
Accessory : Ordered and purchased separately the accessory package referring to the model name provided and install at field. Accessory line-ups varies by region, so check your local catalogue or local sales material.
- Some functions can be limited by remote controller.
- Selecting a wireless remote controller in case of ducted type indoor units requires either a connection to the wired remote controller (Standard II) or an IR receiver accessory to be connected to the duct in order to receive the signal.
- 'Auto Mode' varies depending on the outdoor unit type.
 - Auto Change Over(Heat Recovery Outdoor Unit)
 - Auto Mode Select(Heat Pump Outdoor Unit)
 - Auto Intensity Control(Cooling Only Outdoor Unit)
- * : These functions need to connect the wired remote controller.

1. List of functions

◆ Accessory Compatibility List

Category	Accessory Name	Model Name	Description	ARNU**GCEA4 ARNU**GCEU4
Remote Controller	Wired - Premium	PREMTA000	-	○
		PREMTA000A	-	○
		PREMTA000B	-	○
	Wired - RS3 (Standard III)	PREMTB100/PREMTB101	White	○
		PREMTBB10/PREMTBB11	Black	○
	Wired - RS2 (Standard II)	PREMTB001	White	○
		PREMTBB01	Black	○
	Wired - Simple	PQRCVCL0QW	White	○
		PQRCVCL0Q	Black	○
	Wired - Simple for Hotel	PQRCHCA0QW	White	○
		PQRCHCA0Q	Black	○
	Wireless	PQWRCQ0FDB	For Cooling only	○
PQWRHQ0FDB		For Heat pump	○	
PWLSSB21C		For Cooling only	○	
PWLSSB21H		For Heat pump	○	
Dry Contact	Simple	PDRYCB000	1 input port, AC 220 - 240V	○
		PDRYCB100	1 input port, AC 24V	○
	Communication	PDRYCB400	2 input port	○
		PDRYCB300	8 input port, For 3rd party Thermostat	○
		PDRYCB320	8 input port, For 3rd Party Thermostat (Analog Input)	○
		PDRYCB500	For 3rd Party Controller (Modbus RTU)	○
Integration Device	Remote Temperature sensor	PQRSTA0	-	X
	Zone Controller	ABZCA	For Duct, 4zone, 220-240V	X
	Group Control wire	PZCWRCG3	Cable Assembly For group control (Y-type cable : 0.25m, cable : 9.6m)	○
ETC	Extension wire	PZCWRC1	Extension wire For IDU-wired remote controller (9.6m)	X
	2-Remo Control Wire	PZCWRC2	-	X
	Wi-Fi Modem	PWFMDD200	-	○
	Wi-Fi Extension cable	PWYREW000	USB Extension cable : 10 m	○
	IR Receiver	PWLRVN000	For wireless remote controller with Duct	○
	Independent Power Module	PRIP0	-	○
	Multi-tenant Power module	PINPMB001	-	○
	Refrigerant Leakage Detector	PRLDNVS0	For R410A only	○
	UVnano Filter Box	PBM13M1UA0	For M1 Chassis	X
		PBM13M2UA0	For M2 Chassis	X
		PBM13M3UA0	For M3 Chassis	X
	High Efficiency Filter (Main Filter of Filter Box)	FBM13M1UA0	For M1 UVnano Filter Box	X
		FBM13M2UA0	For M2 UVnano Filter Box	X
		FBM13M3UA0	For M3 UVnano Filter Box	X
	EEV Kit	PRGK024A0	For Multi V Indoor Unit	○
Auxiliary Heater Relay Kit	PRARH1	For Cassette and Duct Indoor Units	X	

Note

1. ○: Possible, X: Impossible, -: Not applicable, Embedded : Included with product.
2. If there is a difference in development time between the product and the remote controller, some functions cannot be operated.
3. If using Wi-Fi controller, Some advanced functions controlled by remote controller cannot be operated.
4. Selecting a wireless remote controller in case of ducted type indoor units requires either a connection to the wired remote controller (Standard II) or an IR receiver accessory to be connected to the duct in order to receive the signal.
5. If you need more detail, please refer to the **BECON** PDB or the manual of product. (<http://partner.lge.com> > Select Your Region : Home> Doc.Library> Product > Control(BECON))

1. List of functions

◆ Accessory Compatibility List

Category	Accessory Name	Model Name	Description	ARNU**GCFA4 ARNU**GCFU4
Remote Controller	Wired - Premium	PREMTA000	-	○
		PREMTA000A	-	○
		PREMTA000B	-	○
	Wired - RS3 (Standard III)	PREMTB100/PREMTB101	White	○
		PREMTBB10/PREMTBB11	Black	○
	Wired - RS2 (Standard II)	PREMTB001	White	○
		PREMTBB01	Black	○
	Wired - Simple	PQRCVCL0QW	White	○
		PQRCVCL0Q	Black	○
	Wired - Simple for Hotel	PQRCHCA0QW	White	○
		PQRCHCA0Q	Black	○
	Wireless	PQWRCQ0FDB	For Cooling only	○
PQWRHQ0FDB		For Heat pump	○	
PWLSSB21C		For Cooling only	○	
PWLSSB21H		For Heat pump	○	
Dry Contact	Simple	PDRYCB000	1 input port, AC 220 - 240V	○
		PDRYCB100	1 input port, AC 24V	○
	Communication	PDRYCB400	2 input port	○
		PDRYCB300	8 input port, For 3rd party Thermostat	○
		PDRYCB320	8 input port, For 3rd Party Thermostat (Analog Input)	○
		PDRYCB500	For 3rd Party Controller (Modbus RTU)	○
Integration Device	Remote Temperature sensor	PQRSTA0	-	X
	Zone Controller	ABZCA	For Duct, 4zone, 220-240V	X
	Group Control wire	PZCWRCG3	Cable Assembly For group control (Y-type cable : 0.25m, cable : 9.6m)	○
ETC	Extension wire	PZCWRC1	Extension wire For IDU-wired remote controller (9.6m)	X
	2-Remo Control Wire	PZCWRC2	-	X
	Wi-Fi Modem	PWFMDD200	-	○
	Wi-Fi Extension cable	PWYREW000	USB Extension cable : 10 m	○
	IR Receiver	PWLRVN000	For wireless remote controller with Duct	○
	Independent Power Module	PRIP0	-	○
	Multi-tenant Power module	PINPMB001	-	○
	Refrigerant Leakage Detector	PRLDNVS0	For R410A only	○
	UVnano Filter Box	PBM13M1UA0	For M1 Chassis	X
		PBM13M2UA0	For M2 Chassis	X
		PBM13M3UA0	For M3 Chassis	X
	High Efficiency Filter (Main Filter of Filter Box)	FBM13M1UA0	For M1 UVnano Filter Box	X
		FBM13M2UA0	For M2 UVnano Filter Box	X
		FBM13M3UA0	For M3 UVnano Filter Box	X
	EEV Kit	PRGK024A0	For Multi V Indoor Unit	X
Auxiliary Heater Relay Kit	PRARH1	For Cassette and Duct Indoor Units	X	

Note

1. ○: Possible, X: Impossible, -: Not applicable, Embedded : Included with product.
2. If there is a difference in development time between the product and the remote controller, some functions cannot be operated.
3. If using Wi-Fi controller, Some advanced functions controlled by remote controller cannot be operated.
4. Selecting a wireless remote controller in case of ducted type indoor units requires either a connection to the wired remote controller (Standard II) or an IR receiver accessory to be connected to the duct in order to receive the signal.
5. If you need more detail, please refer to the **BECON** PDB or the manual of product. (<http://partner.lge.com> > Select Your Region : Home> Doc.Library> Product > Control(BECON))

2. Specifications

Type			Floor Standing	
Model		Unit	ARNU07GCEA4	ARNU09GCEA4
Cooling Capacity		kW	2.2	2.8
		kcal/h	1,900	2,400
		Btu/h	7,500	9,600
Heating Capacity		kW	2.5	3.2
		kcal/h	2,200	2,800
		Btu/h	8,500	10,900
Power Input (H / M / L)		W	24 / 17 / 14	30 / 24 / 17
Casing			Galvanized Steel Plate	Galvanized Steel Plate
Dimensions (WxHxD)	Body	mm	1,067 x 635 x 203	1,067 x 635 x 203
		inch	42 x 25 x 8	42 x 25 x 8
Coil	Rows x Columns x FPI		2 x 12 x 19	2 x 12 x 19
	Face Area	m ²	0.16	0.16
Fan	Type		Sirocco Fan	Sirocco Fan
	Motor Output x Number		W	19 x 1, 5 x 1
	Air Flow Rate (H / M / L)	m ³ /min	8.5 / 7.5 / 6.5	9.5 / 8.5 / 7.5
		ft ³ /min	300 / 265 / 229	335 / 300 / 265
	Drive		Direct	Direct
Motor type		BLDC	BLDC	
Temperature Control			Microprocessor, Thermostat for cooling and heating	
Sound Absorbing Thermal Insulation Material			Foamed polystyrene	Foamed polystyrene
Air Filter			Resin Net(washable)	Resin Net(washable)
Safety Device			Fuse	Fuse
Pipe Connections	Liquid Side	mm(inch)	Ø6.35(1/4)	Ø6.35(1/4)
	Gas Side	mm(inch)	Ø12.7(1/2)	Ø12.7(1/2)
	Drain Pipe(Internal Dia.)	mm(inch)	12(15/32)	12(15/32)
Net Weight		kg(lbs)	27(59.5)	27(59.5)
Sound Pressure Levels (H / M / L)		dB(A)	35 / 33 / 31	36 / 34 / 32
Sound Power Levels (H / M / L)		dB(A)	52 / 47 / 43	54 / 51 / 47
Power Supply		Ø, V, Hz	1, 220 - 230 - 240, 50/60	1, 220 - 230 - 240, 50/60
Running Current by voltage	Rated	A	0.22 - 0.21 - 0.21	0.28 - 0.27 - 0.26
Maximum Running Current		A	0.76	0.76
Refrigerant	Type		R410A / R32	R410A / R32
	Additional Charging Amount (CF Value of IDU)		kg(each)	0.17 / 0.14
	Control		-	EEV
Transmission cable		mm ²	1.0~1.5 x 2C	1.0~1.5 x 2C

Note

- Due to our policy of innovation some specifications may be changed without notification.
- Wiring cable size must comply with the applicable local and national code. And "Electric characteristics" chapter should be considered for electrical work and design. Especially the power cable and circuit breaker should be selected in accordance with that.
- Sound pressure level is measured on the rated condition in the anechoic rooms by ISO 3745 standard.
Sound power level is measured on the rated condition in the semi-anechoic rooms by ISO 9614 standard.
Therefore, these values can be increased owing to ambient conditions during operation.
- Capacities are net capacities and based on the following conditions. Refer to the Outdoor Unit Specifications for calculating the real capacity.
 - Cooling : Indoor Ambient Temp. 27°CDB / 19°CWB, Outdoor Ambient Temp. 35°CDB / 24°CWB
 - Heating : Indoor Ambient Temp. 20°CDB / 15°CWB, Outdoor Ambient Temp. 7°CDB / 6°CWB
 - Interconnected Pipe is standard length and difference of Elevation (Outdoor ~ Indoor Unit) is 0m.
- Refrigerant information (type, additional charging amount, etc.) must be applied by refrigerant type of the combined outdoor unit.
Adapt after checking the specifications of outdoor unit.

2. Specifications

Type			Floor Standing	
Model	Unit		ARNU12GCEA4	ARNU15GCEA4
Cooling Capacity	kW		3.6	4.5
	kcal/h		3,100	3,900
	Btu/h		12,300	15,400
Heating Capacity	kW		4.0	5.0
	kcal/h		3,400	4,300
	Btu/h		13,600	17,100
Power Input (H / M / L)	W		36 / 30 / 24	44 / 35 / 28
Casing			Galvanized Steel Plate	Galvanized Steel Plate
Dimensions (WxHxD)	Body	mm	1,067 x 635 x 203	1,067 x 635 x 203
		inch	42 x 25 x 8	42 x 25 x 8
Coil	Rows x Columns x FPI		2 x 12 x 19	2 x 12 x 19
	Face Area	m ²	0.16	0.16
Fan	Type		Sirocco Fan	Sirocco Fan
	Motor Output x Number	W	19 x 1, 5 x 1	19 x 1, 5 x 1
	Air Flow Rate (H / M / L)	m ³ /min	10.5 / 9.5 / 8.5	11.5 / 10.0 / 9.5
		ft ³ /min	371 / 335 / 300	406 / 353 / 335
	Drive		Direct	Direct
Motor type		BLDC	BLDC	
Temperature Control			Microprocessor, Thermostat for cooling and heating	
Sound Absorbing Thermal Insulation Material			Foamed polystyrene	Foamed polystyrene
Air Filter			Resin Net(washable)	Resin Net(washable)
Safety Device			Fuse	Fuse
Pipe Connections	Liquid Side	mm(inch)	Ø6.35(1/4)	Ø6.35(1/4)
	Gas Side	mm(inch)	Ø12.7(1/2)	Ø12.7(1/2)
	Drain Pipe(Internal Dia.)	mm(inch)	12(15/32)	12(15/32)
Net Weight		kg(lbs)	27(59.5)	27(59.5)
Sound Pressure Levels (H / M / L)		dB(A)	37 / 35 / 33	38 / 37 / 35
Sound Power Levels (H / M / L)		dB(A)	54 / 51 / 50	55 / 54 / 51
Power Supply		Ø, V, Hz	1, 220 - 230 - 240, 50/60	1, 220 - 230 - 240, 50/60
Running Current by voltage	Rated	A	0.34 - 0.32 - 0.31	0.41 - 0.39 - 0.38
Maximum Running Current		A	0.76	0.76
Refrigerant	Type		R410A / R32	R410A / R32
	Additional Charging Amount (CF Value of IDU)	kg(each)	0.17 / 0.14	0.17 / 0.14
	Control		EEV	EEV
Transmission cable		mm ²	1.0~1.5 x 2C	1.0~1.5 x 2C

Note

- Due to our policy of innovation some specifications may be changed without notification.
- Wiring cable size must comply with the applicable local and national code. And "Electric characteristics" chapter should be considered for electrical work and design. Especially the power cable and circuit breaker should be selected in accordance with that.
- Sound pressure level is measured on the rated condition in the anechoic rooms by ISO 3745 standard.
Sound power level is measured on the rated condition in the semi-anechoic rooms by ISO 9614 standard.
Therefore, these values can be increased owing to ambient conditions during operation.
- Capacities are net capacities and based on the following conditions. Refer to the Outdoor Unit Specifications for calculating the real capacity.
 - Cooling : Indoor Ambient Temp. 27°CDB / 19°CWB, Outdoor Ambient Temp. 35°CDB / 24°CWB
 - Heating : Indoor Ambient Temp. 20°CDB / 15°CWB, Outdoor Ambient Temp. 7°CDB / 6°CWB
 - Interconnected Pipe is standard length and difference of Elevation (Outdoor ~ Indoor Unit) is 0m.
- Refrigerant information (type, additional charging amount, etc.) must be applied by refrigerant type of the combined outdoor unit.
Adapt after checking the specifications of outdoor unit.

2. Specifications

Type			Floor Standing	
Model		Unit	ARNU18GCFA4	ARNU24GCFA4
Cooling Capacity		kW	5.6	7.1
		kcal/h	4,800	6,100
		Btu/h	19,100	24,200
Heating Capacity		kW	6.3	8.0
		kcal/h	5,400	6,900
		Btu/h	21,500	27,300
Power Input (H / M / L)		W	54 / 41 / 29	84 / 54 / 41
Casing			Galvanized Steel Plate	Galvanized Steel Plate
Dimensions (WxHxD)	Body	mm	1,345 x 635 x 203	1,345 x 635 x 203
		inch	52-15/16 x 25 x 8	52-15/16 x 25 x 8
Coil	Rows x Columns x FPI		3 x 11 x 19	3 x 11 x 19
	Face Area	m ²	0.23	0.23
Fan	Type		Sirocco Fan	Sirocco Fan
	Motor Output x Number		W	19 x 2
	Air Flow Rate (H / M / L)	m ³ /min	16.0 / 14.0 / 12.0	18.0 / 16.0 / 14.0
		ft ³ /min	565 / 494 / 424	635 / 565 / 494
	Drive		Direct	Direct
Motor type		BLDC	BLDC	
Temperature Control			Microprocessor, Thermostat for cooling and heating	
Sound Absorbing Thermal Insulation Material			Foamed polystyrene	Foamed polystyrene
Air Filter			Resin Net(washable)	Resin Net(washable)
Safety Device			Fuse	Fuse
Pipe Connections	Liquid Side	mm(inch)	Ø6.35(1/4)	Ø9.52(3/8)
	Gas Side	mm(inch)	Ø12.7(1/2)	Ø15.88(5/8)
	Drain Pipe(Internal Dia.)	mm(inch)	12(15/32)	12(15/32)
Net Weight		kg(lbs)	34(75.0)	34(75.0)
Sound Pressure Levels (H / M / L)		dB(A)	40 / 37 / 34	43 / 40 / 37
Sound Power Levels (H / M / L)		dB(A)	57 / 54 / 50	61 / 57 / 54
Power Supply		Ø, V, Hz	1, 220 - 230 - 240, 50/60	1, 220 - 230 - 240, 50/60
Running Current by voltage	Rated	A	0.48 - 0.46 - 0.44	0.74 - 0.71 - 0.68
Maximum Running Current		A	0.97	0.97
Refrigerant	Type		R410A / R32	R410A / R32
	Additional Charging Amount (CF Value of IDU)		kg(each)	0.37 / 0.31
	Control		-	EEV
Transmission cable		mm ²	1.0~1.5 x 2C	1.0~1.5 x 2C

Note

1. Due to our policy of innovation some specifications may be changed without notification.
2. Wiring cable size must comply with the applicable local and national code. And "Electric characteristics" chapter should be considered for electrical work and design. Especially the power cable and circuit breaker should be selected in accordance with that.
3. Sound pressure level is measured on the rated condition in the anechoic rooms by ISO 3745 standard.
Sound power level is measured on the rated condition in the semi-anechoic rooms by ISO 9614 standard.
Therefore, these values can be increased owing to ambient conditions during operation.
4. Capacities are net capacities and based on the following conditions. Refer to the Outdoor Unit Specifications for calculating the real capacity.
 - Cooling : Indoor Ambient Temp. 27°CDB / 19°CWB, Outdoor Ambient Temp. 35°CDB / 24°CWB
 - Heating : Indoor Ambient Temp. 20°CDB / 15°CWB, Outdoor Ambient Temp. 7°CDB / 6°CWB
 - Interconnected Pipe is standard length and difference of Elevation (Outdoor ~ Indoor Unit) is 0m.
5. Refrigerant information (type, additional charging amount, etc.) must be applied by refrigerant type of the combined outdoor unit.
Adapt after checking the specifications of outdoor unit.

2. Specifications

Type			Floor Standing	
Model		Unit	ARNU07GCEU4	ARNU09GCEU4
Cooling Capacity		kW	2.2	2.8
		kcal/h	1,900	2,400
		Btu/h	7,500	9,600
Heating Capacity		kW	2.5	3.2
		kcal/h	2,200	2,800
		Btu/h	8,500	10,900
Power Input (H / M / L)		W	24 / 17 / 14	30 / 24 / 17
Casing			Galvanized Steel Plate	Galvanized Steel Plate
Dimensions (WxHxD)	Body	mm	978 x 639 x 190	978 x 639 x 190
		inch	38-1/2 x 25-5/32 x 7-15/32	38-1/2 x 25-5/32 x 7-15/32
Coil	Rows x Columns x FPI		2 x 12 x 19	2 x 12 x 19
	Face Area	m ²	0.16	0.16
Fan	Type		Sirocco Fan	Sirocco Fan
	Motor Output x Number		W	19 x 1, 5 x 1
	Air Flow Rate (H / M / L)	m ³ /min	8.5 / 7.5 / 6.5	9.5 / 8.5 / 7.5
		ft ³ /min	300 / 265 / 229	335 / 300 / 265
	Drive		Direct	Direct
Motor type		BLDC	BLDC	
Temperature Control			Microprocessor, Thermostat for cooling and heating	
Sound Absorbing Thermal Insulation Material			Foamed polystyrene	Foamed polystyrene
Air Filter			Resin Net(washable)	Resin Net(washable)
Safety Device			Fuse	Fuse
Pipe Connections	Liquid Side	mm(inch)	Ø6.35(1/4)	Ø6.35(1/4)
	Gas Side	mm(inch)	Ø12.7(1/2)	Ø12.7(1/2)
	Drain Pipe(Internal Dia.)	mm(inch)	12(15/32)	12(15/32)
Net Weight		kg(lbs)	21(46.3)	21(46.3)
Sound Pressure Levels (H / M / L)		dB(A)	35 / 33 / 31	36 / 34 / 32
Sound Power Levels (H / M / L)		dB(A)	52 / 47 / 43	54 / 51 / 47
Power Supply		Ø, V, Hz	1, 220 - 230 - 240, 50/60	1, 220 - 230 - 240, 50/60
Running Current by voltage	Rated	A	0.22 - 0.21 - 0.21	0.28 - 0.27 - 0.26
Maximum Running Current		A	0.76	0.76
Refrigerant	Type		R410A / R32	R410A / R32
	Additional Charging Amount (CF Value of IDU)		kg(each)	0.17 / 0.14
	Control		-	EEV
Transmission cable		mm ²	1.0~1.5 x 2C	1.0~1.5 x 2C

Note

1. Due to our policy of innovation some specifications may be changed without notification.
2. Wiring cable size must comply with the applicable local and national code. And "Electric characteristics" chapter should be considered for electrical work and design. Especially the power cable and circuit breaker should be selected in accordance with that.
3. Sound pressure level is measured on the rated condition in the anechoic rooms by ISO 3745 standard.
Sound power level is measured on the rated condition in the semi-anechoic rooms by ISO 9614 standard.
Therefore, these values can be increased owing to ambient conditions during operation.
4. Capacities are net capacities and based on the following conditions. Refer to the Outdoor Unit Specifications for calculating the real capacity.
 - Cooling : Indoor Ambient Temp. 27°CDB / 19°CWB, Outdoor Ambient Temp. 35°CDB / 24°CWB
 - Heating : Indoor Ambient Temp. 20°CDB / 15°CWB, Outdoor Ambient Temp. 7°CDB / 6°CWB
 - Interconnected Pipe is standard length and difference of Elevation (Outdoor ~ Indoor Unit) is 0m.
5. Refrigerant information (type, additional charging amount, etc.) must be applied by refrigerant type of the combined outdoor unit.
Adapt after checking the specifications of outdoor unit.

2. Specifications

Type			Floor Standing	
Model		Unit	ARNU12GCEU4	ARNU15GCEU4
Cooling Capacity		kW	3.6	4.5
		kcal/h	3,100	3,900
		Btu/h	12,300	15,400
Heating Capacity		kW	4.0	5.0
		kcal/h	3,400	4,300
		Btu/h	13,600	17,100
Power Input (H / M / L)		W	36 / 30 / 24	44 / 35 / 28
Casing			Galvanized Steel Plate	Galvanized Steel Plate
Dimensions (WxHxD)	Body	mm	978 x 639 x 190	978 x 639 x 190
		inch	38-1/2 x 25-5/32 x 7-15/32	38-1/2 x 25-5/32 x 7-15/32
Coil	Rows x Columns x FPI		2 x 12 x 19	2 x 12 x 19
	Face Area	m ²	0.16	0.16
Fan	Type		Sirocco Fan	Sirocco Fan
	Motor Output x Number		W	19 x 1, 5 x 1
	Air Flow Rate (H / M / L)	m ³ /min	10.5 / 9.5 / 8.5	11.5 / 10.0 / 9.5
		ft ³ /min	371 / 335 / 300	406 / 353 / 335
	Drive		Direct	Direct
Motor type		BLDC	BLDC	
Temperature Control			Microprocessor, Thermostat for cooling and heating	
Sound Absorbing Thermal Insulation Material			Foamed polystyrene	Foamed polystyrene
Air Filter			Resin Net(washable)	Resin Net(washable)
Safety Device			Fuse	Fuse
Pipe Connections	Liquid Side	mm(inch)	Ø6.35(1/4)	Ø6.35(1/4)
	Gas Side	mm(inch)	Ø12.7(1/2)	Ø12.7(1/2)
	Drain Pipe(Internal Dia.)	mm(inch)	12(15/32)	12(15/32)
Net Weight		kg(lbs)	21(46.3)	21(46.3)
Sound Pressure Levels (H / M / L)		dB(A)	37 / 35 / 33	38 / 37 / 35
Sound Power Levels (H / M / L)		dB(A)	54 / 51 / 50	55 / 54 / 51
Power Supply		Ø, V, Hz	1, 220 - 230 - 240, 50/60	1, 220 - 230 - 240, 50/60
Running Current by voltage	Rated	A	0.34 - 0.32 - 0.31	0.41 - 0.39 - 0.38
Maximum Running Current		A	0.76	0.76
Refrigerant	Type		R410A / R32	R410A / R32
	Additional Charging Amount (CF Value of IDU)		kg(each)	0.17 / 0.14
	Control		-	EEV
Transmission cable		mm ²	1.0~1.5 x 2C	1.0~1.5 x 2C

Note

1. Due to our policy of innovation some specifications may be changed without notification.
2. Wiring cable size must comply with the applicable local and national code. And "Electric characteristics" chapter should be considered for electrical work and design. Especially the power cable and circuit breaker should be selected in accordance with that.
3. Sound pressure level is measured on the rated condition in the anechoic rooms by ISO 3745 standard.
Sound power level is measured on the rated condition in the semi-anechoic rooms by ISO 9614 standard.
Therefore, these values can be increased owing to ambient conditions during operation.
4. Capacities are net capacities and based on the following conditions. Refer to the Outdoor Unit Specifications for calculating the real capacity.
 - Cooling : Indoor Ambient Temp. 27°CDB / 19°CWB, Outdoor Ambient Temp. 35°CDB / 24°CWB
 - Heating : Indoor Ambient Temp. 20°CDB / 15°CWB, Outdoor Ambient Temp. 7°CDB / 6°CWB
 - Interconnected Pipe is standard length and difference of Elevation (Outdoor ~ Indoor Unit) is 0m.
5. Refrigerant information (type, additional charging amount, etc.) must be applied by refrigerant type of the combined outdoor unit.
Adapt after checking the specifications of outdoor unit.

2. Specifications

Type			Floor Standing	
Model		Unit	ARNU18GCFU4	ARNU24GCFU4
Cooling Capacity		kW	5.6	7.1
		kcal/h	4,800	6,100
		Btu/h	19,100	24,200
Heating Capacity		kW	6.3	8.0
		kcal/h	5,400	6,900
		Btu/h	21,500	27,300
Power Input (H / M / L)		W	54 / 41 / 29	84 / 54 / 41
Casing			Galvanized Steel Plate	Galvanized Steel Plate
Dimensions (WxHxD)	Body	mm	1,256 x 639 x 190	1,256 x 639 x 190
		inch	49-7/16 x 25-5/32 x 7-15/32	49-7/16 x 25-5/32 x 7-15/32
Coil	Rows x Columns x FPI		3 x 11 x 19	3 x 11 x 19
	Face Area	m ²	0.23	0.23
Fan	Type		Sirocco Fan	Sirocco Fan
	Motor Output x Number		W	19 x 2
	Air Flow Rate (H / M / L)	m ³ /min	16.0 / 14.0 / 12.0	18.0 / 16.0 / 14.0
		ft ³ /min	565 / 494 / 424	635 / 565 / 494
	Drive		Direct	Direct
Motor type		BLDC	BLDC	
Temperature Control			Microprocessor, Thermostat for cooling and heating	
Sound Absorbing Thermal Insulation Material			Foamed polystyrene	Foamed polystyrene
Air Filter			Resin Net(washable)	Resin Net(washable)
Safety Device			Fuse	Fuse
Pipe Connections	Liquid Side	mm(inch)	Ø6.35(1/4)	Ø9.52(3/8)
	Gas Side	mm(inch)	Ø12.7(1/2)	Ø15.88(5/8)
	Drain Pipe(Internal Dia.)	mm(inch)	12(15/32)	12(15/32)
Net Weight		kg(lbs)	25(55.1)	25(55.1)
Sound Pressure Levels (H / M / L)		dB(A)	40 / 37 / 34	43 / 40 / 37
Sound Power Levels (H / M / L)		dB(A)	59 / 57 / 53	63 / 59 / 57
Power Supply		Ø, V, Hz	1, 220 - 230 - 240, 50/60	1, 220 - 230 - 240, 50/60
Running Current by voltage	Rated	A	0.48 - 0.46 - 0.44	0.74 - 0.71 - 0.68
Maximum Running Current		A	0.97	0.97
Refrigerant	Type		R410A / R32	R410A / R32
	Additional Charging Amount (CF Value of IDU)		kg(each)	0.37 / 0.31
	Control		-	EEV
Transmission cable		mm ²	1.0~1.5 x 2C	1.0~1.5 x 2C

Note

1. Due to our policy of innovation some specifications may be changed without notification.
2. Wiring cable size must comply with the applicable local and national code. And "Electric characteristics" chapter should be considered for electrical work and design. Especially the power cable and circuit breaker should be selected in accordance with that.
3. Sound pressure level is measured on the rated condition in the anechoic rooms by ISO 3745 standard.
Sound power level is measured on the rated condition in the semi-anechoic rooms by ISO 9614 standard.
Therefore, these values can be increased owing to ambient conditions during operation.
4. Capacities are net capacities and based on the following conditions. Refer to the Outdoor Unit Specifications for calculating the real capacity.
 - Cooling : Indoor Ambient Temp. 27°CDB / 19°CWB, Outdoor Ambient Temp. 35°CDB / 24°CWB
 - Heating : Indoor Ambient Temp. 20°CDB / 15°CWB, Outdoor Ambient Temp. 7°CDB / 6°CWB
 - Interconnected Pipe is standard length and difference of Elevation (Outdoor ~ Indoor Unit) is 0m.
5. Refrigerant information (type, additional charging amount, etc.) must be applied by refrigerant type of the combined outdoor unit.
Adapt after checking the specifications of outdoor unit.

3. Dimensions

3.1 Dimensional Drawings

ARNU07GCEA4 / ARNU09GCEA4 / ARNU12GCEA4 / ARNU15GCEA4

ARNU07GCEU4 / ARNU09GCEU4 / ARNU12GCEU4 / ARNU15GCEU4

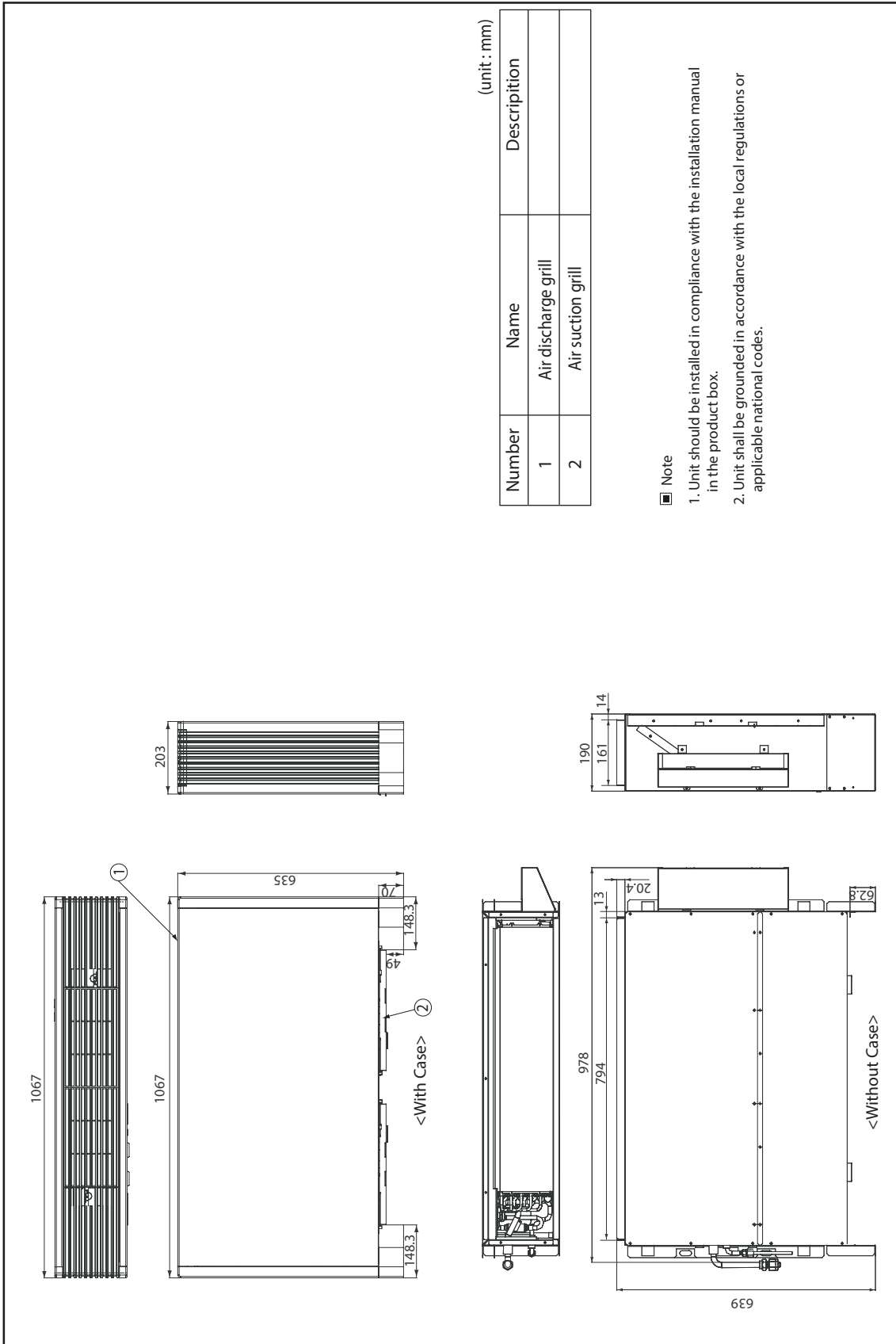

3. Dimensions

ARNU18GCFA4 / ARNU24GCFA4 / ARNU18GCFU4 / ARNU24GCFU4

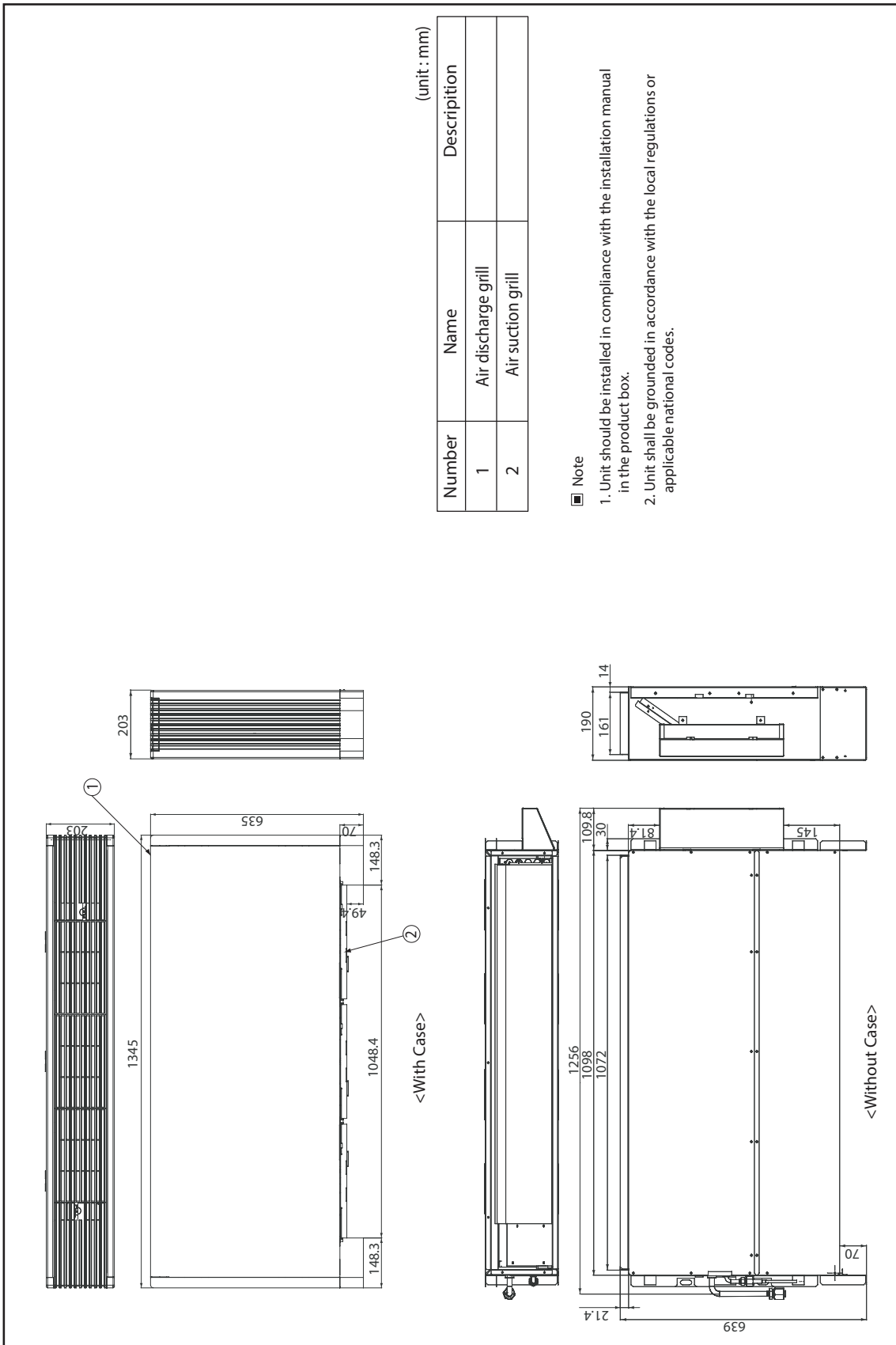

3. Dimensions

3.2 Installation Space

With Case

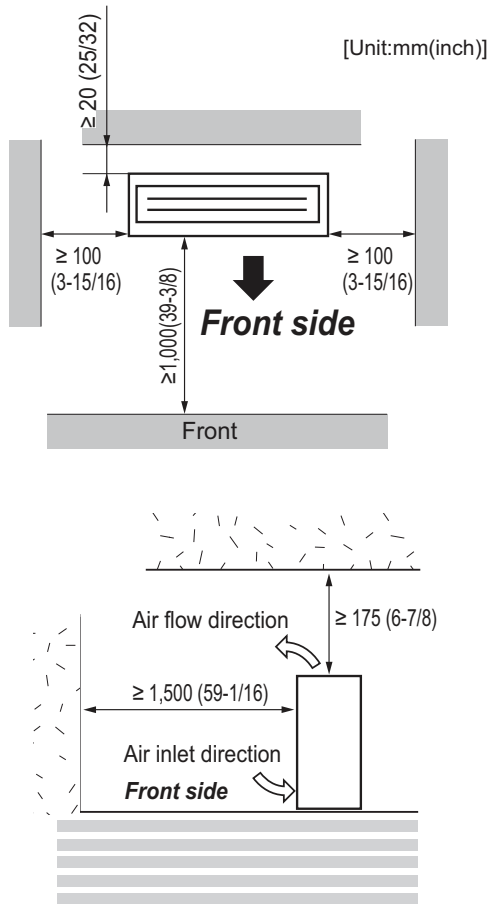

Without Case

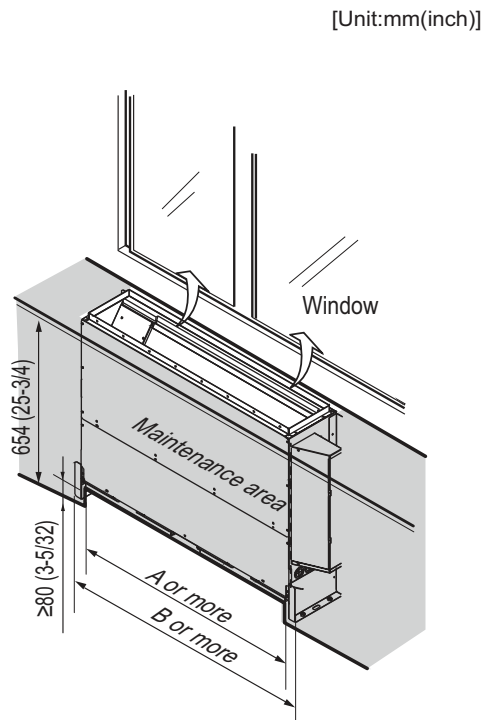

CEU Type: A = 788(32-1/32), B = 1,830(72-1/16)

CFU Type: A=1,066(41-31/32), B=1,358(53-15/32)

Note

- Places where products are installed should not be any obstacles to the air circulation or installation. Ensure the spaces from the wall, ceiling, or other obstacles.
- According to type of indoor unit, external appearance or installed structure could be different.
- According to product type, model line up, sales region..etc, applicability of each chassis could be different.

4. Piping Diagrams

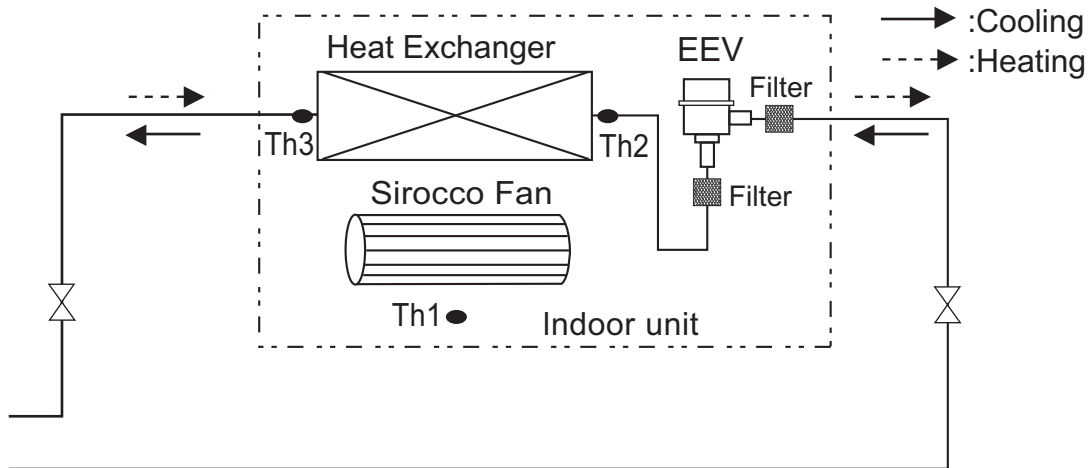

◆ Refrigerant pipe connection port diameter

Model	Gas [mm(inch)]	Liquid [mm(inch)]
ARNU07GCEA4	Ø12.7(1/2)	Ø6.35(1/4)
ARNU07GCEU4		
ARNU09GCEA4	Ø12.7(1/2)	Ø6.35(1/4)
ARNU09GCEU4		
ARNU12GCEA4	Ø12.7(1/2)	Ø6.35(1/4)
ARNU12GCEU4		
ARNU15GCEA4	Ø12.7(1/2)	Ø6.35(1/4)
ARNU15GCEU4		
ARNU18GCFA4	Ø12.7(1/2)	Ø6.35(1/4)
ARNU18GCFU4		
ARNU24GCFA4	Ø15.88(5/8)	Ø9.52(3/8)
ARNU24GCFU4		

LOC.	Description
Th1	Thermistor for room air temperature
Th2	Thermistor for pipe in temperature
Th3	Thermistor for pipe out temperature

5. Wiring Diagrams

CE/CF Chassis

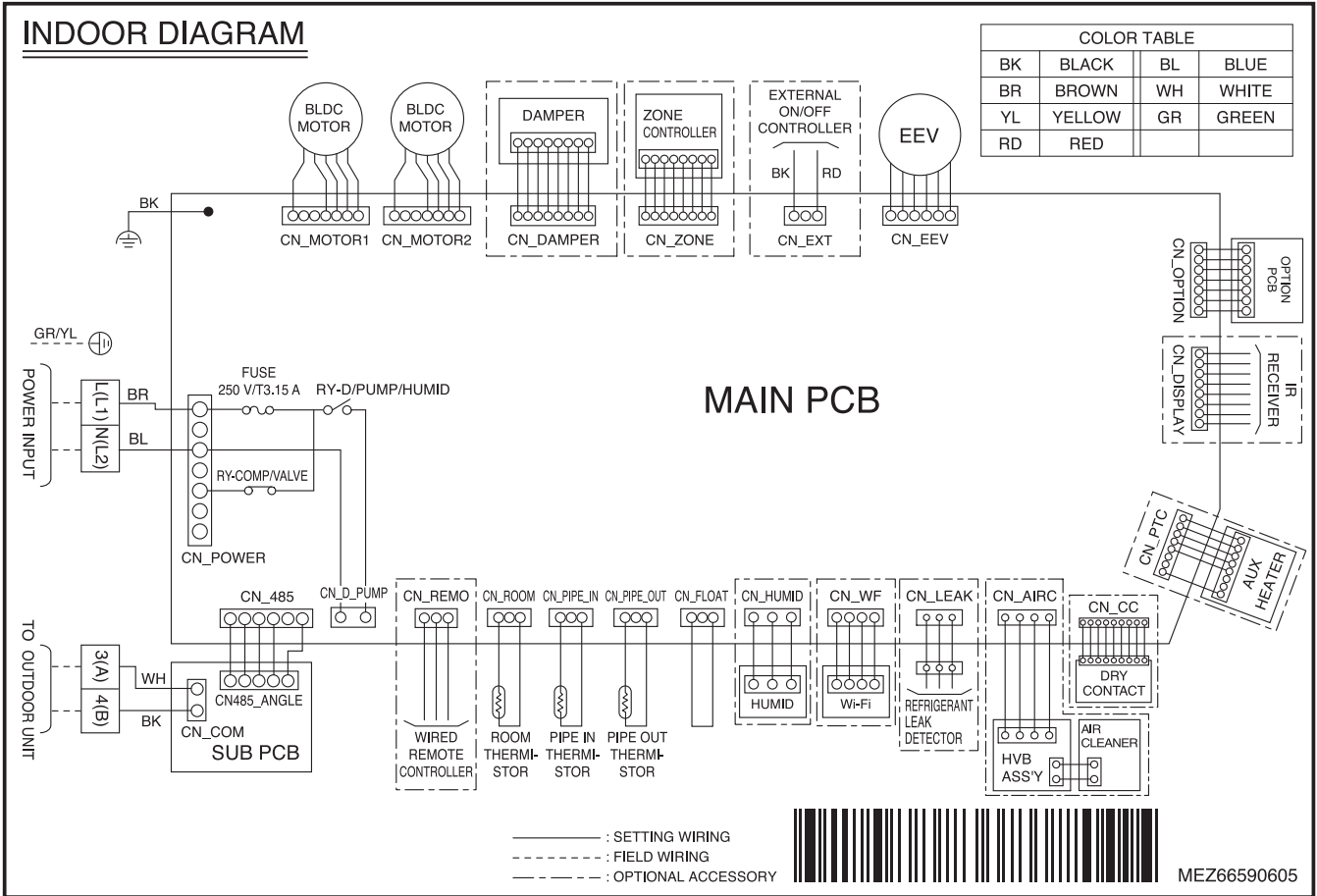

CONNECTOR NUMBER	SPEC.	DESCRIPTION
CN_POWER	AC power supply	AC Power line input for indoor controller
CN_MOTOR1	Fan motor output	Motor output of BLDC
CN_MOTOR2	Fan motor output	Motor output of BLDC
CN_COMM	Communication	Communication between indoor and outdoor
CN-EEV	Float switch input	EEV Control output : connect to EEV directly or through IPM(Independent Power Module)
CN-LEAK	Refrigerant leak detector	Refrigerant leak detector line
CN_PIPE_IN	Suction pipe sensor	Pipe in thermistor
CN_PIPE_OUT	Discharge pipe sensor	Pipe out thermistor
CN_ROOM	Room sensor	Room thermistor
CN_REMO	Remote controller	Remote control line
CN_OPTION	Option PCB	Communication between main and option
CN_ZONE	Zone controller	Zone control line
CN_DISPLAY	RF Remote controller	RF Remote control line
CN_CC	Dry contact	Dry contact line
CN_EXT	External On/Off	External On/Off signal input
CN_WF	Wi-Fi Controller	Wifi control line
CN_HUMID	Humidity sensor	Humid sensing

5. Wiring Diagrams

	Function	Description	Setting Off	Setting On	Default
SW1	Communication	N/A (Default)	-	-	Off
SW2	Cycle	N/A (Default)	-	-	Off
SW3	Group Control	Selection of Master or Slave	Master	Slave	Off
SW4	Dry Contact Mode	Selection of Dry Contact Mode	Wired/Wireless remote controller selection of Manual or Auto operation Mode	Auto	Off
SW5	Installation	Fan continuous operation	Continuous operation Removal	-	Off
SW6	Heater linkage	N/A	-	-	Off
SW7	Ventilator linkage	Selection of Ventilator linkage	Linkage Removal	Working	Off
	Vane selection (Console)	Selection of up/down side Vane	Up side + Down side Vane	Up side Vane Only	
	Region selection	Selection tropical region	General model	Tropical model	
SW8	Etc.	Spare	-	-	Off

CAUTION

For Multi V Model, Dip Switch 1,2,6,8 must be set OFF.

6. Capacity Tables

■ Cooling Capacity

Nominal Capacity (kBtu/h) [Capacity Index (kW)]	Indoor air temp. (DB/WB, °C)													
	20		23		26		27		28		30		32	
	14		16		18		19		20		22		24	
	TC	SHC	TC	SHC	TC	SHC	TC	SHC	TC	SHC	TC	SHC	TC	SHC
7 [2.2]	1.5	1.3	1.8	1.4	2.1	1.5	2.2	1.6	2.3	1.6	2.4	1.5	2.4	1.4
9 [2.8]	1.9	1.7	2.3	1.9	2.6	2.0	2.8	2.0	3.0	2.1	3.0	2.0	3.1	1.8
12 [3.6]	2.4	2.2	2.9	2.4	3.4	2.6	3.6	2.7	3.8	2.7	3.9	2.6	4.0	2.4
15 [4.5]	3.0	2.7	3.6	3.0	4.2	3.2	4.5	3.3	4.8	3.4	4.9	3.2	4.9	3.0
18 [5.6]	3.8	3.3	4.5	3.7	5.2	4.0	5.6	4.0	6.0	4.2	6.0	3.9	6.2	3.6
24 [7.1]	4.8	4.1	5.7	4.6	6.6	5.0	7.1	5.0	7.6	5.2	7.7	4.9	7.8	4.5

Note

1. TC: Total Capacity(kW), SHC: Sensible Heat Capacity(kW)
2. Capacity tables show the average value of conditions which may occur.
3. Refer to Capacity tables and correction factor in the outdoor unit PDB for the actual performance data of each indoor unit and outdoor unit combination.

■ Heating Capacity

Nominal Capacity (kBtu/h) [Capacity Index (kW)]	Indoor air temp. (DB, °C)					
	16	18	20	21	22	24
	TC	TC	TC	TC	TC	TC
7 [2.2]	2.8	2.7	2.5	2.4	2.3	2.2
9 [2.8]	3.6	3.4	3.2	3.1	3.0	2.8
12 [3.6]	4.5	4.3	4.0	3.9	3.7	3.5
15 [4.5]	5.6	5.3	5.0	4.8	4.7	4.4
18 [5.6]	7.1	6.7	6.3	6.1	5.9	5.5
24 [7.1]	9.0	8.5	8.0	7.7	7.5	7.0

Note

1. TC: Total Capacity(kW)
2. Capacity tables show the average value of conditions which may occur.
3. Refer to Capacity tables and correction factor in the outdoor unit PDB for the actual performance data of each indoor unit and outdoor unit combination.

7. Air Velocity and Temperature Distribution

◆ ARNU07GCEA4 / ARNU07GCEU4

Cooling

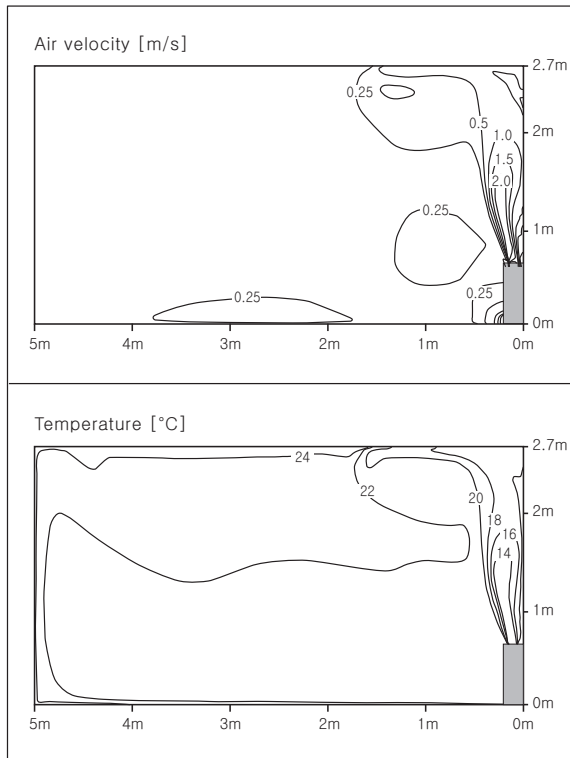

Heating

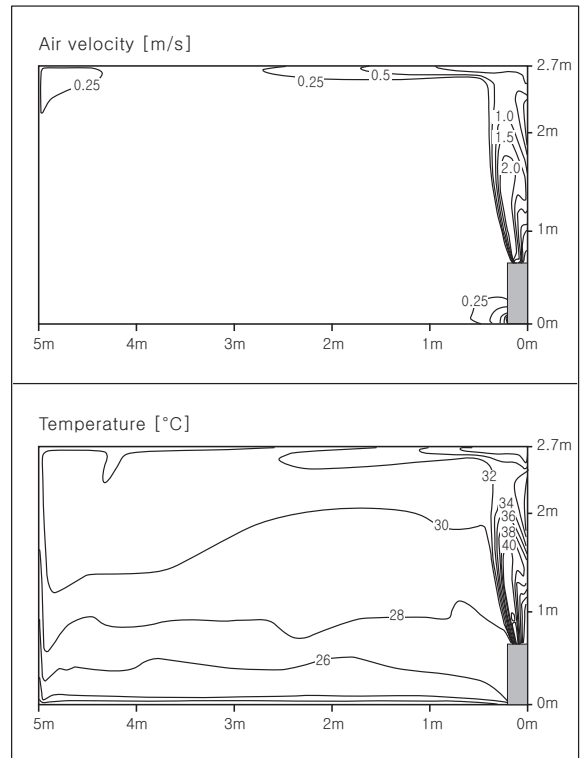

◆ ARNU09GCEA4 / ARNU09GCEU4

Cooling

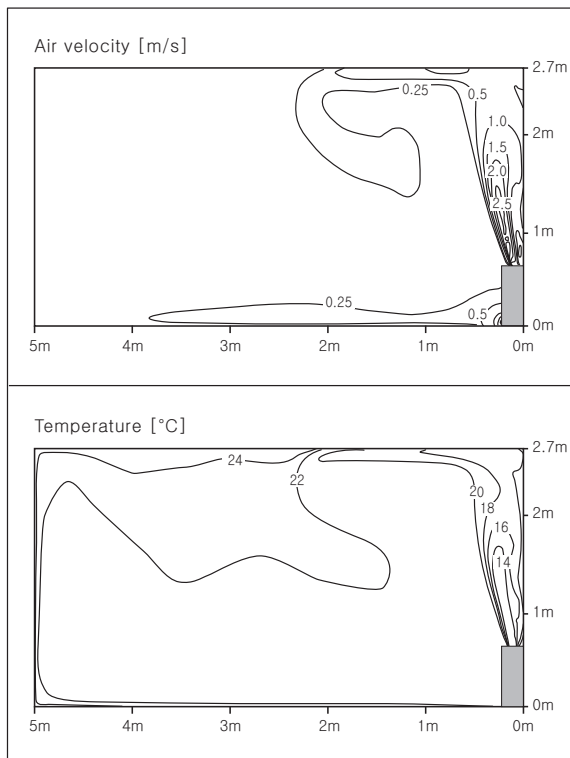

Heating

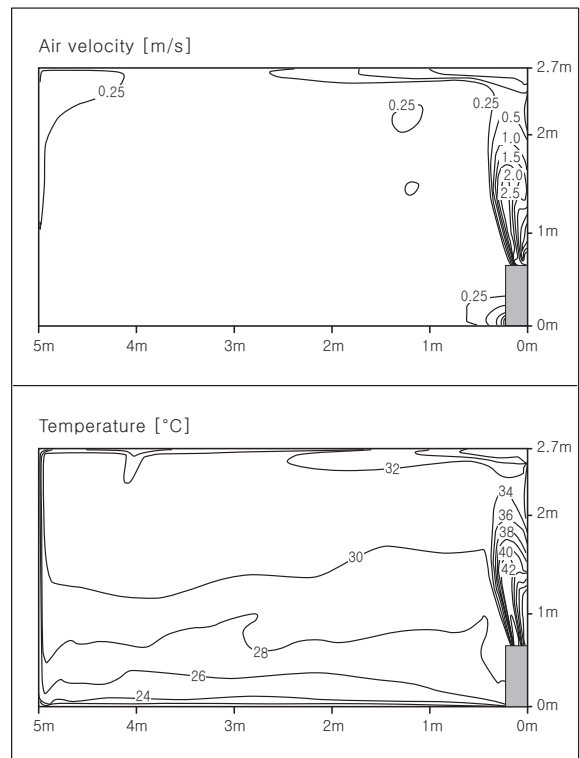

Note

- These figures are accordance with normal certain condition and environment. (Airflow step is 'High', Air discharge angle is fixed as indicated angle.)
- Indoor airflow distribution under actual installation or operating conditions depends on ambient temperature, ceiling height, product installation direction / location, indoor / Heating load, and other obstacles, etc.

7. Air Velocity and Temperature Distribution

◆ ARNU12GCEA4 / ARNU12GCEU4

Cooling

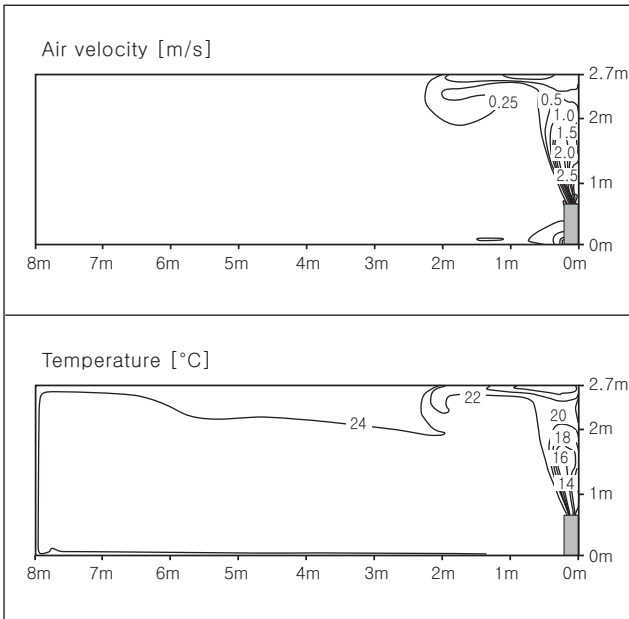

Heating

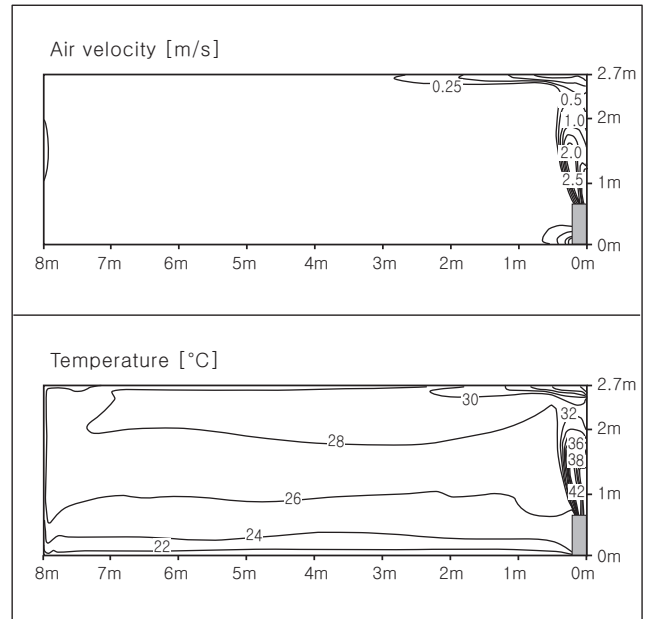

◆ ARNU15GCEA4 / ARNU15GCEU4

Cooling

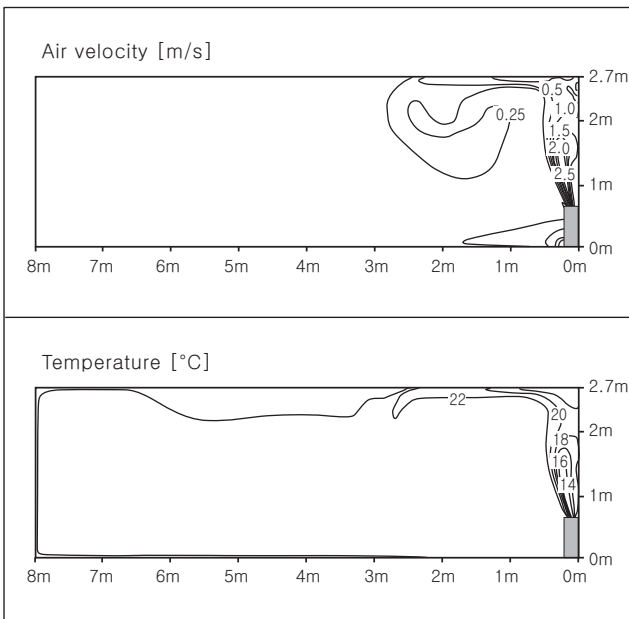

Heating

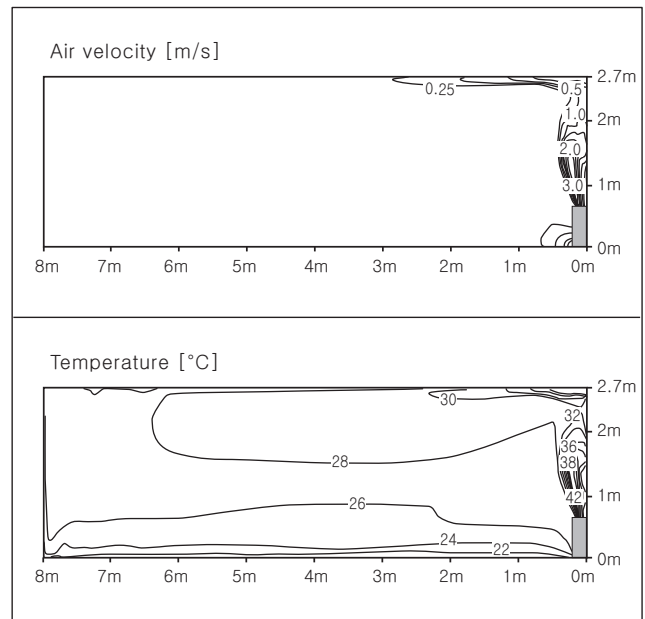

Note

- These figures are accordance with normal certain condition and environment. (Airflow step is 'High', Air discharge angle is fixed as indicated angle.)
- Indoor airflow distribution under actual installation or operating conditions depends on ambient temperature, ceiling height, product installation direction / location, indoor / Heating load, and other obstacles, etc.

7. Air Velocity and Temperature Distribution

◆ ARNU18GCFA4 / ARNU18GCFU4

Cooling

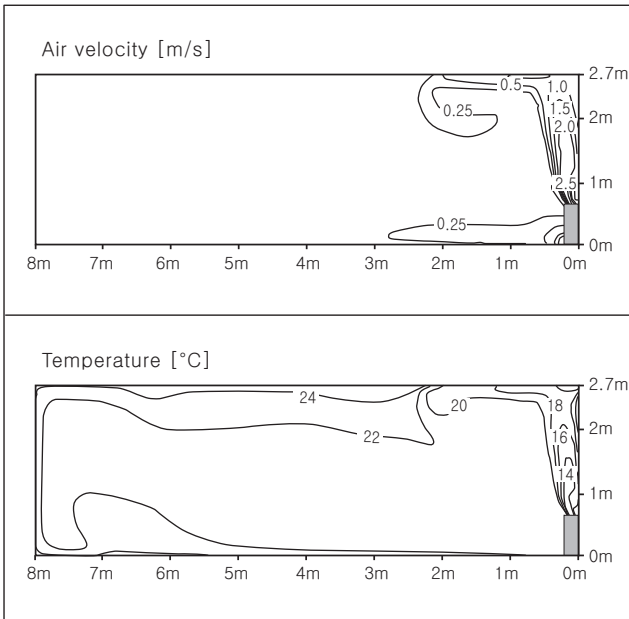

Heating

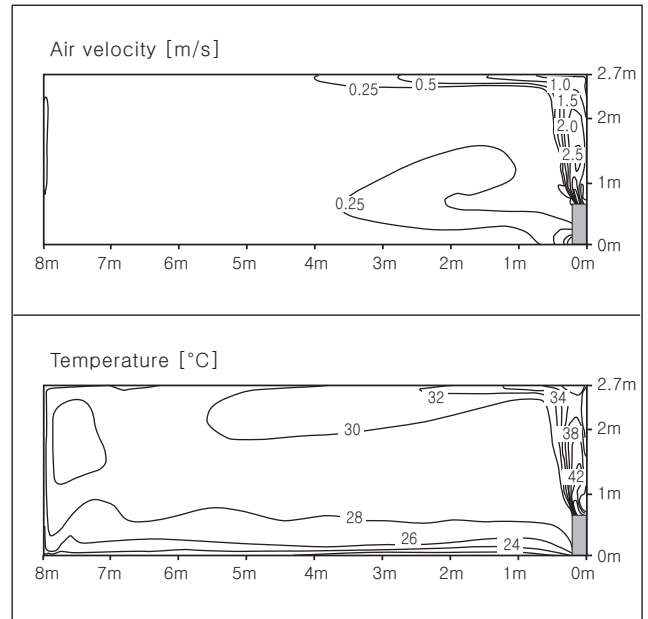

◆ ARNU24GCFA4 / ARNU24GCFU4

Cooling

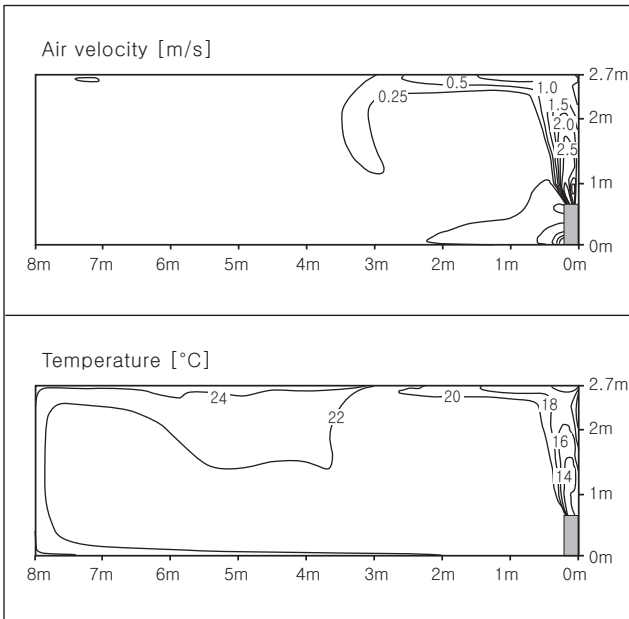

Heating

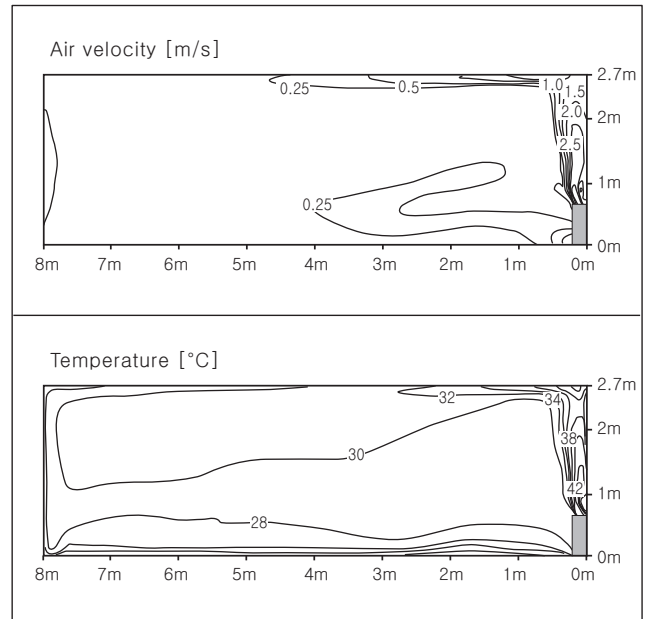

Note

- These figures are accordance with normal certain condition and environment. (Airflow step is 'High', Air discharge angle is fixed as indicated angle.)
- Indoor airflow distribution under actual installation or operating conditions depends on ambient temperature, ceiling height, product installation direction / location, indoor / Heating load, and other obstacles, etc.

8. External Static Pressure (E.S.P) & Air Flow

◆ ARNU07/09/12/15GCEA4, ARNU07/09/12/15GCEU4

Setting Value	Static Pressure(mmAq(Pa))				
	0 (0)	1 (10)	2 (20)	3 (29)	4 (39)
	Air Flow Rate (m³/min)				
60	5.19	2.53	0.83	-	-
65	5.75	3.74	1.44	-	-
70	6.32	4.54	2.24	0.71	-
75	6.88	5.18	2.88	0.82	-
80	7.45	6.33	4.03	1.28	-
85	8.01	7.04	5.74	1.45	0.84
90	8.57	7.66	6.36	2.38	1.36
95	9.14	8.52	7.22	4.56	2.61
100	9.70	9.35	8.05	5.96	3.91
105	10.27	9.99	8.69	7.12	5.12
110	10.83	10.68	9.38	8.03	6.35
115	11.50	11.02	10.02	9.14	7.23

Note

1. The above table shows the correlation between the air rates and E.S.P.
2. The above table shows the available E.S.P. range.
3. If the E.S.P. of the installed indoor is less than the lowest value(as mention in the table), indoor components can be failed.

◆ Fan Performance (ARNU07/09/12/15GCEA4, ARNU07/09/12/15GCEU4)

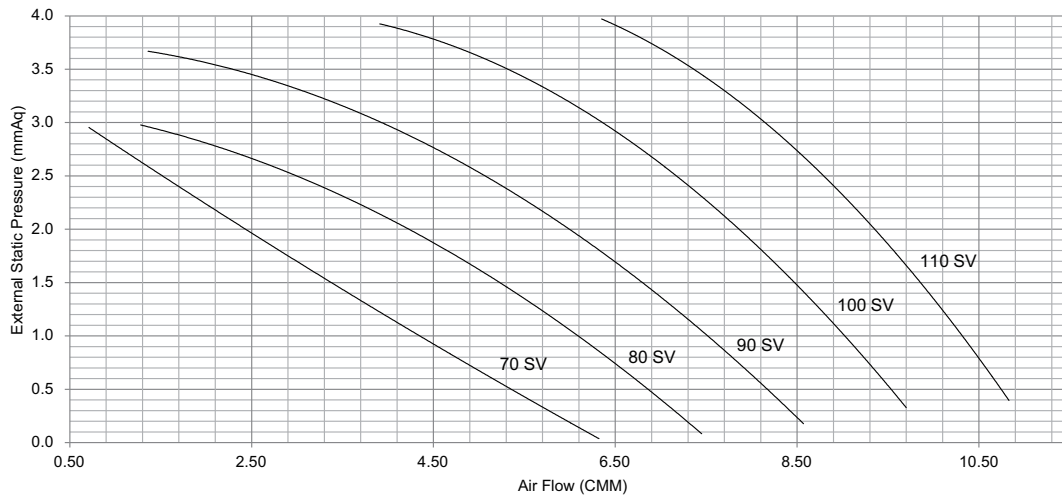

8. External Static Pressure (E.S.P) & Air Flow

◆ ARNU18/24GCFA4, ARNU18/24GCFU4

Setting Value	Static Pressure(mmAq(Pa))				
	0 (0)	1 (10)	2 (20)	3 (29)	4 (39)
Air Flow Rate (m³/min)					
75	9.83	7.51	3.35	-	-
80	10.59	8.48	4.51	1.18	-
85	11.35	9.44	6.75	1.96	-
90	12.11	10.41	8.06	4.53	1.05
95	12.87	11.38	9.73	6.54	2.53
100	13.63	12.35	10.31	8.21	3.45
105	14.39	13.32	12.11	9.63	6.01
110	15.15	14.29	13.29	10.19	8.12
115	15.91	15.26	14.28	12.57	9.72
120	16.67	16.22	14.95	13.78	10.65
125	17.44	17.19	15.92	14.93	12.77
130	18.20	17.96	17.21	16.08	14.39

Note

1. The above table shows the correlation between the air rates and E.S.P.
2. The above table shows the available E.S.P. range.
3. If the E.S.P. of the installed indoor is less than the lowest value(as mention in the table), indoor components can be failed.

◆ Fan Performance (ARNU18/24GCFA4, ARNU18/24GCFU4)

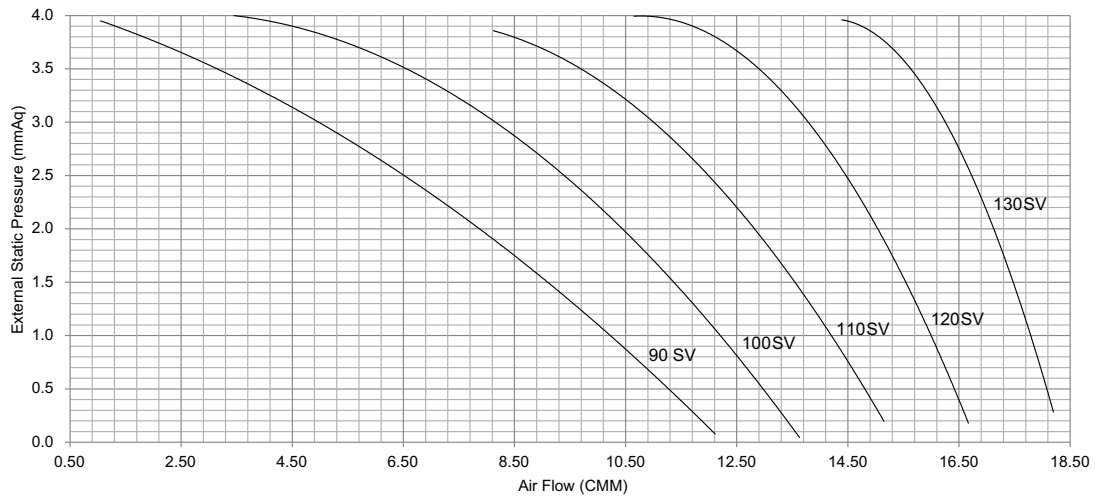

8. External Static Pressure (E.S.P) & Air Flow

◆ ARNU07/09/12/15GCEA4, ARNU07/09/12/15GCEU4

Capacity	Mode		Set value	Standard ESP (mmAq(Pa))	CMM	Lower Limit of External Static Pressure(mmAq(Pa))	Upper Limit of External Static Pressure(mmAq(Pa))
7k	Standard (factory set)	HI	92	0 (0)	8.5	-	4(39)
		Mid	80		7.5		
		Low	70		6.5		
9k	Standard (factory set)	HI	100	0 (0)	9.5	-	4(39)
		Mid	92		8.5		
		Low	80		7.5		
12k	Standard (factory set)	HI	107	0 (0)	10.5	-	4(39)
		Mid	100		9.5		
		Low	92		8.5		
15k	Standard (factory set)	HI	115	0 (0)	11.5	-	4(39)
		Mid	106		10.0		
		Low	98		9.5		

Note

1. The above table shows the available E.S.P. range.

◆ ARNU18/24GCFA4, ARNU18/24GCFU4

Capacity	Mode		Set value	Standard ESP (mmAq(Pa))	CMM	Lower Limit of External Static Pressure(mmAq(Pa))	Upper Limit of External Static Pressure(mmAq(Pa))
18k	Standard (factory set)	HI	113	0 (0)	16.0	-	4(39)
		Mid	103		14.0		
		Low	90		12.0		
24k	Standard (factory set)	HI	130	0 (0)	18.0	-	4(39)
		Mid	113		16.0		
		Low	103		14.0		

Note

1. The above table shows the available E.S.P. range.

9. Electric Characteristics

Units					Power Supply	IFM		PI	
Model	Type	Hz	Volts	Voltage Range	MCA	kW	FLA	Cooling	Heating
ARNU07GCEA4	CE	50	220-240	MAX.264 MIN.198	1.00	0.024	0.76	85	85
ARNU07GCEU4					1.00	0.024	0.76	85	85
ARNU09GCEA4	CE				1.00	0.024	0.76	85	85
ARNU09GCEU4					1.00	0.024	0.76	85	85
ARNU12GCEA4	CE				1.00	0.024	0.76	85	85
ARNU12GCEU4					1.00	0.024	0.76	85	85
ARNU15GCEA4	CE				1.00	0.024	0.76	85	85
ARNU15GCEU4					1.00	0.024	0.76	85	85
ARNU18GCFA4	CF				1.20	0.038	0.97	115	115
ARNU18GCFU4					1.20	0.038	0.97	115	115
ARNU24GCFA4	CF				1.20	0.038	0.97	115	115
ARNU24GCFU4					1.20	0.038	0.97	115	115
ARNU07GCEA4	CE	60	220	MAX.242 MIN.198	1.00	0.024	0.76	85	85
ARNU07GCEU4					1.00	0.024	0.76	85	85
ARNU09GCEA4	CE				1.00	0.024	0.76	85	85
ARNU09GCEU4					1.00	0.024	0.76	85	85
ARNU12GCEA4	CE				1.00	0.024	0.76	85	85
ARNU12GCEU4					1.00	0.024	0.76	85	85
ARNU15GCEA4	CE				1.00	0.024	0.76	85	85
ARNU15GCEU4					1.00	0.024	0.76	85	85
ARNU18GCFA4	CF				1.20	0.038	0.97	115	115
ARNU18GCFU4					1.20	0.038	0.97	115	115
ARNU24GCFA4	CF				1.20	0.038	0.97	115	115
ARNU24GCFU4					1.20	0.038	0.97	115	115

Symbols

MCA : Minimum Circuit Amperes (A)

kW : Fan Motor Rated Output (kW)

FLA : Full Load Amperes (A)

IFM : Indoor Fan Motor

PI : Maximum Power Input (W)

Note

1. Voltage range

Units are suitable for use on electrical systems where voltage supplied to unit terminals is not below or above the listed range limits.

2. Maximum allowable voltage unbalance between phases is 2%.

3. MCA/MFA

$$MCA = 1.25 \times FLA$$

$$MFA = 1.1 \times MCA, MFA \leq 4 \times FLA$$

(If MFA is smaller than minimum standard value, Use minimum standard value in region for selecting circuit breaker.)

4. Select wire size based on the MCA

5. Instead of fuse, use Circuit Breaker.

10. Sound Levels

10.1 Sound Pressure Levels

Overall

Note

- 1.Sound measured at some distance away from the center of the unit.
- 2.Data is valid at free field condition.
- 3.Reference acoustic pressure 0dB = 20μPa.
- 4.Data is valid at nominal operation condition.
Refer to the Model Specifications for nominal conditions(Power source and Ambient temperature, etc)
- 5.Sound levels can be increased in accordance with installation and operating conditions. (Static pressure mode, used air guide, Room target temperature setting, etc)
- 6.Sound level will vary depending on a range of factors such as the construction(acoustic absorption coefficient) of particular room in which the equipment is installed.
- 7.Sound pressure level is measured on the rated condition in the anechoic rooms by ISO 3745 standard.
Therefore, these values can be increased owing to ambient conditions during operation.

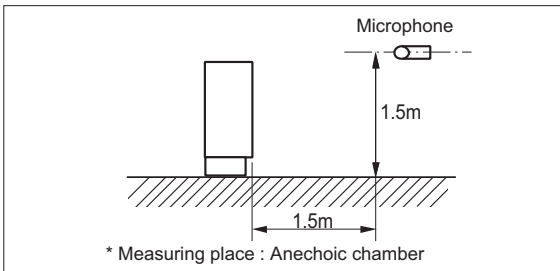

Model		Sound Pressure Levels [dB(A)]		
		H	M	L
ARNU07GCEA4	ARNU07GCEU4	35	33	31
ARNU09GCEA4	ARNU09GCEU4	36	34	32
ARNU12GCEA4	ARNU12GCEU4	37	35	33
ARNU15GCEA4	ARNU15GCEU4	38	37	35
ARNU18GCFA4	ARNU18GCFU4	40	37	34
ARNU24GCFA4	ARNU24GCFU4	43	40	37

**ARNU07GCEA4
ARNU07GCEU4**

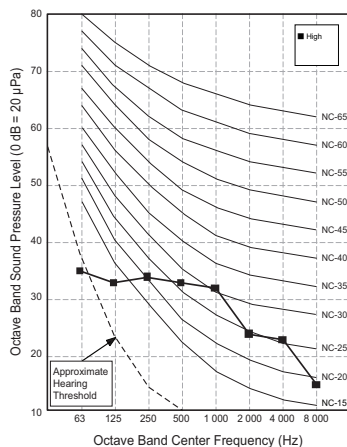

**ARNU09GCEA4
ARNU09GCEU4**

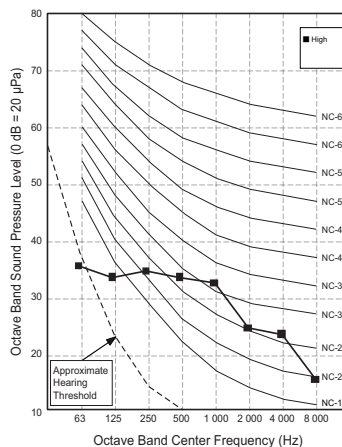

**ARNU12GCEA4
ARNU12GCEU4**

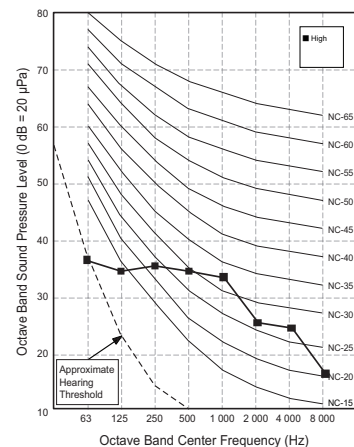

10. Sound Levels

**ARNU15GCEA4
ARNU15GCEU4**

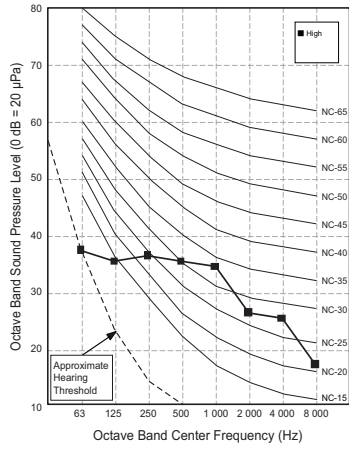

**ARNU18GCFA4
ARNU18GCFU4**

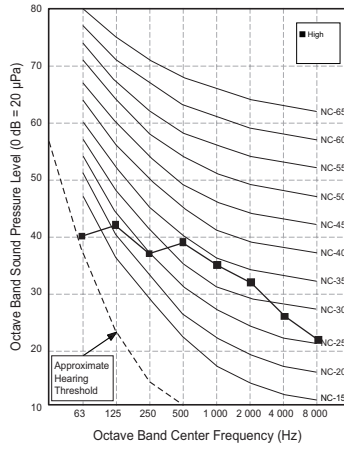

**ARNU24GCFA4
ARNU24GCFU4**

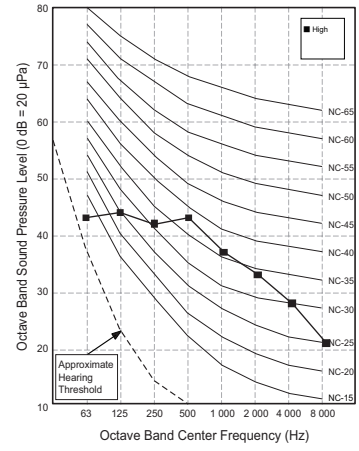

10. Sound Levels

10.2 Sound Power Levels

Note

- Data is valid at diffuse field condition
- Data is valid at nominal operating condition
- Sound level can be increased in static pressure mode or used air guide.
- Sound level will vary depending on a range of factors such as the construction (acoustic absorption coefficient) of particular room in which the equipment is installed.
- Reference acoustic intensity 0dB = $10E-6\mu W/m^2$
- Sound power level is measured on the rated condition in the semi-anechoic rooms by ISO 9614 standard. Therefore, these values can be increased owing to ambient conditions during operation.

Model	Sound Power Levels [dB(A)]		
	H	M	L
ARNU07GCEA4 / ARNU07GCEU4	52	47	43
ARNU09GCEA4 / ARNU09GCEU4	54	51	47
ARNU12GCEA4 / ARNU12GCEU4	54	51	50
ARNU15GCEA4 / ARNU15GCEU4	55	54	51
ARNU18GCFA4	57	54	50
ARNU24GCFA4	61	57	54
ARNU18GCFU4	59	57	53
ARNU24GCFU4	63	59	57

**ARNU07GCEA4
ARNU07GCEU4**

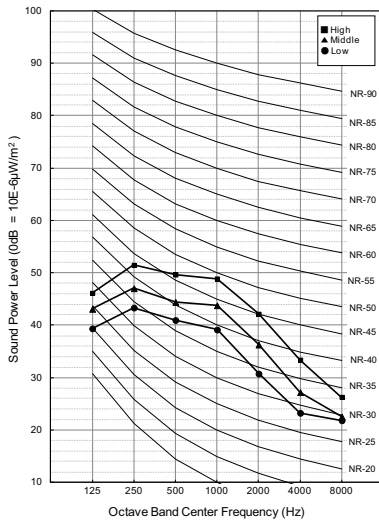

**ARNU09GCEA4
ARNU09GCEU4**

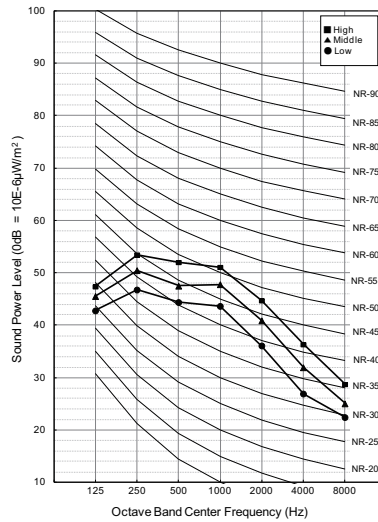

**ARNU12GCEA4
ARNU12GCEU4**

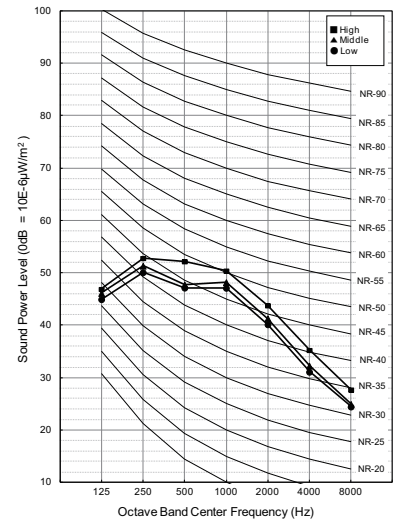

10. Sound Levels

**ARNU15GCEA4
ARNU15GCEU4**

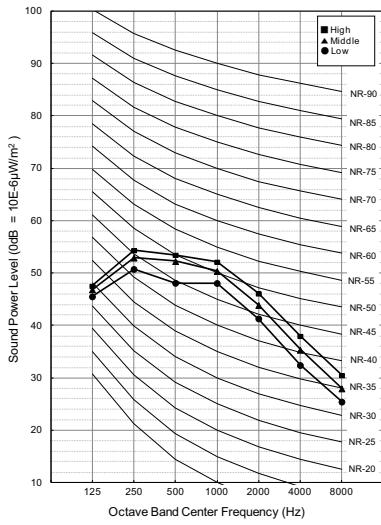

ARNU18GCFA4

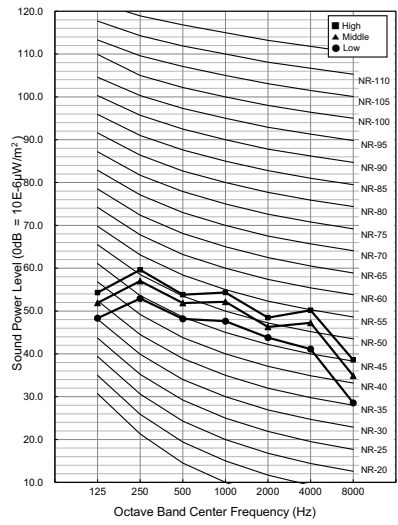

ARNU18GCFU4

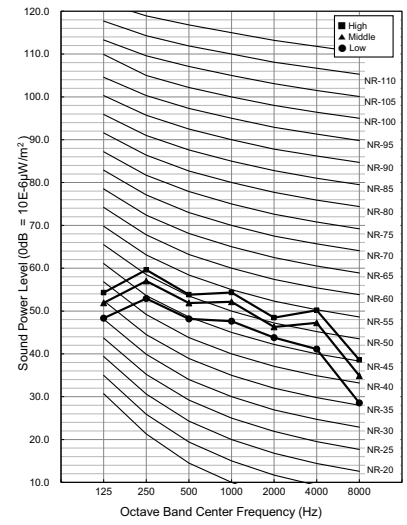

ARNU24GCFA4

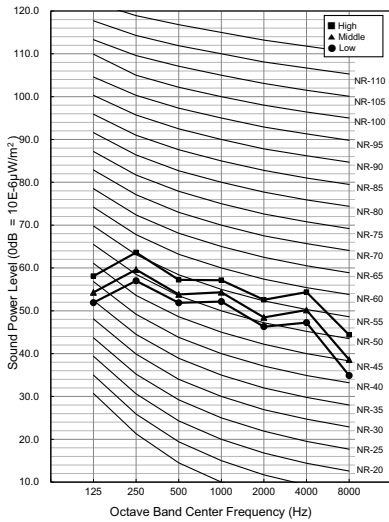

ARNU24GCFU4

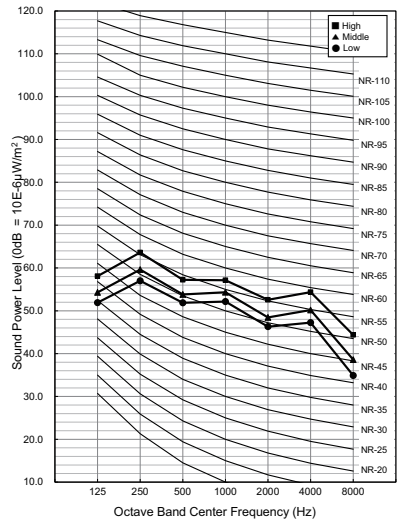

Floor Standing Unit(2)

- 1.List of functions**
- 2.Specifications**
- 3.Dimensions**
- 4.Piping Diagrams**
- 5.Wiring Diagrams**
- 6.Capacity Tables**
- 7.Air Velocity and Temperature Distribution**
- 8.Electric Characteristics**
- 9.Sound Levels**

1. List of functions

◆ List of functions

Category	Function	ARNU48GPTA4	ARNU96GPFA4
Air Flow	Air Supply Outlet	1	1
	Airflow Direction Control (left & right)	Auto	X
	Airflow Direction Control (up & down)	Auto	Manual
	Auto Swing (left & right)	O	X
	Auto Swing (up & down)	O	X
	Airflow Steps (fan/cool/heat)	4 / 4 / 4	3 / 3 / 3
	Fan Speed Auto*	X	X
	Power Cool/Heat	O / O	O / O
	Swirl Wind*	X	X
	Refresh Mode**	X	X
	Smart Mode**	X	X
	Indirect Wind*	X	X
	Direct Wind*	X	X
Dry Operation	O	O	
Air Purification	Air Purify	X	X
	Ionizer	X	X
	UV-C	X	X
	Pre-Filter	O	O
Reliability	Hot Start	O	O
	Self Diagnosis	O	O
Convenience	Auto Mode	X	O
	Auto Dry Operation	O	X
	Auto Restart	O	O
	Child Lock*	O	O
	Forced Operation	O	O
	Group Control*	O	O
	Sleep Timer	O	O
	Turn On/Off Reservation	O	O
	Schedule*	X	X
	Two Thermistor Control*	O	O
External On/Off	X	X	
Installation	Drain Pump	X	X
	E.S.P. Control*	X	X
	High Ceiling Operation*	X	X
Special Functions	Wi-Fi	Accessory	Accessory
	Auto Elevation Grille	X	X
	Human Detection Function**	X	X
	Floor Detection Function**	X	X

Note

- O : Applied, X : Not Applied, - : Unconfirmed or irrelevant
Embedded : A kit is provided by default for using this function when the product is manufactured.
Accessory : Ordered and purchased separately the accessory package referring to the model name provided and install at field. Accessory line-ups varies by region, so check your local catalogue or local sales material.
- Some functions can be limited by remote controller.
- In case of cassette type indoor units, Air Purification Kit and Auto Elevation Grille functions are not applicable at the same time.
- 'Auto Mode' varies depending on the outdoor unit type.
- Auto Change Over(Heat Recovery Outdoor Unit)
- Auto Mode Select(Heat Pump Outdoor Unit)
- Auto Intensity Control(Cooling Only Outdoor Unit)
- * : These functions need to connect the wired remote controller.
- ** : This functions need to connect to the Standard III wired remote controller.

1. List of functions

◆ Accessory Compatibility List

Category		Product	Remark	ARNU48GP4A4, ARNU96GPFA4
Wireless Remote Controller		PQWRHQ0FDB / PQWRCQ0FDB	Heat Pump / Cooling only	○
		PWLSSB21H / PWLSSB21C	Heat Pump / Cooling only	○
Wired Remote Controller	Simple	PQRCVCL0Q(W)	Simple	○
		PQRCHCA0Q(W)	for Hotel	○
	Standard	PREMTB001	Standard II (White)	○
		PREMTBB01	Standard II (Black)	○
		PREMTB100** PREMTB101**	Standard III (White)	○
		PREMTBB10** PREMTBB11**	Standard III (Black)	○
Premium	PREMTA000(A/B)*	Premium	○	
Dry contact	Simple Contact	PDRYCB000	Simple Dry Contact	○
	Communication type	PDRYCB400	2 Points Dry Contact (For Setback)	○
		PDRYCB300	Dry Contact For 3rd Party Thermostat	○
		PDRYCB320	For 3rd Party Thermostat (Analog Input)	○
		PDRYCB500	Dry Contact For Modbus	○
Gateway	IDU PI485	PHNFP14A0	Without case	-
		PSNFP14A0	With case	-
ETC	Remote temperature sensor	PQRSTA0	-	○
	Group control wire	PZCWRCG3	0.25m	○
	2-Remo Control Wire	PZCWRC2	0.25m	-
	Extension Wire	PZCWRC1	10m	-
	Wi-Fi Controller*	PWFMD200	-	○
	Human Detecting Controller	PHD-TM0	-	-

Note

1. ○: Possible, X: Impossible, - : Not applicable, Embedded : Included with product.
2. * : Some advanced functions controlled by individual controller cannot be operated.
3. ** : It could not be operated some functions.
4. If you need more detail, please refer to the **BECON** PDB or the manual of product. (<http://partner.lge.com> > Select Your Region : Home> Doc.Library> Product > Control(BECON))

2. Specifications

Type		Floor Standing		
Model		Unit	ARNU48GPTA4	ARNU96GPFA4
Cooling Capacity		kW	14.1	28.0
		kcal/h	12,100	24,100
		Btu/h	48,100	95,900
Heating Capacity		kW	15.9	31.5
		kcal/h	13,600	27,100
		Btu/h	54,200	107,500
Power Input	Cooling (SH / H / M / L)	W	260 / 190 / 140 / 110	400 / 280 / - / 180
	Heating (SH / H / M / L)	W	260 / 190 / 140 / 110	400 / 280 / - / 180
FLA (Full Load Ampere)		A	1.3	2.3
Casing		Galvanized Steel Plate		
Dimensions (W×H×D)	Body	mm	590 × 1,840 × 440	1,050 × 1,880 × 495
		inch	23-7/32×72-7/16×17-5/16	41-11/32×74-1/32×19-1/2
Coil	Rows × Columns ×FPI		3 ×38 ×19	3 ×40 ×19
	Face Area	m ²	0.39	0.77
Fan	Type		Blower Fan	Blower Fan
	Motor Output x Number	W	224 × 1	700 × 1
	Air Flow Rate(SH/H/M/L) (Standard Mode)	m ³ /min	37 / 33 / 28 / 24	68 / 61 / - / 50
		ft ³ /min	1,307 / 1,165 / 988 / 848	2,402 / 2,154 / - / 1,766
	Drive		Direct	
Motor type		BLDC		
Temperature Control		Microprocessor, Thermostat for cooling and heating		
Sound Absorbing Thermal Insulation Material		Foamed polystyrene		
Air Filter		-		
Safety Device		Fuse		
Pipe Connections	Liquid Side	mm(inch)	9.52 (3/8)	9.52 (3/8)
	Gas Side	mm(inch)	15.88 (5/8)	22.2 (7/8)
	Drain(ID)	mm	19	22
Net Weight		kg(lbs)	49 (108.0)	104 (227.0)
Sound Pressure Level (SH/ H/M/L)		dB(A)	54 / 51 / 49 / 45	60 / 57 / - / 53
Power Supply		∅, V, Hz	1, 220, 60	1, 220, 60
		∅, V, Hz	1, 220-240, 50	1, 220-240, 50
Refrigerant	Type	-	R410A / R32	R410A / R32
	Additional Charging Amount(CF value of IDU)	kg(each)	0.59 / 0.49	1.32 / 1.10
	Control	-	EEV	EEV
Communication Cable		mm ² (VCTF-SB)	1.0~1.5 x 2C	1.0~1.5 x 2C

Note

- Due to our policy of innovation some specifications may be changed without notification.
- Wiring cable size must comply with the applicable local and national code. And "Electric characteristics" chapter should be considered for electrical work and design. Especially the power cable and circuit breaker should be selected in accordance with that.
- Sound Level Values are measured at Noise Measuring chamber accordance with standard. Therefore, these values depend on the ambient conditions and values are normally higher in actual operation(Sound Pressure : LG Internal standard, Sound Power : EN 12102 (ISO 3741)).
- Capacities are net capacities and based on the following conditions. Refer to the Outdoor Unit Specifications for calculating the real capacity.
 - Cooling : Indoor Ambient Temp. 27°CDB / 19°CWB, Outdoor Ambient Temp. 35°CDB / 24°CWB
 - Heating : Indoor Ambient Temp. 20°CDB / 15°CWB, Outdoor Ambient Temp. 7°CDB / 6°CWB
 - Interconnected Pipe is standard length and difference of Elevation (Outdoor ~ Indoor Unit) is 0m.

3. Dimensions

3.1 Product

◆ ARNU48GPTA4

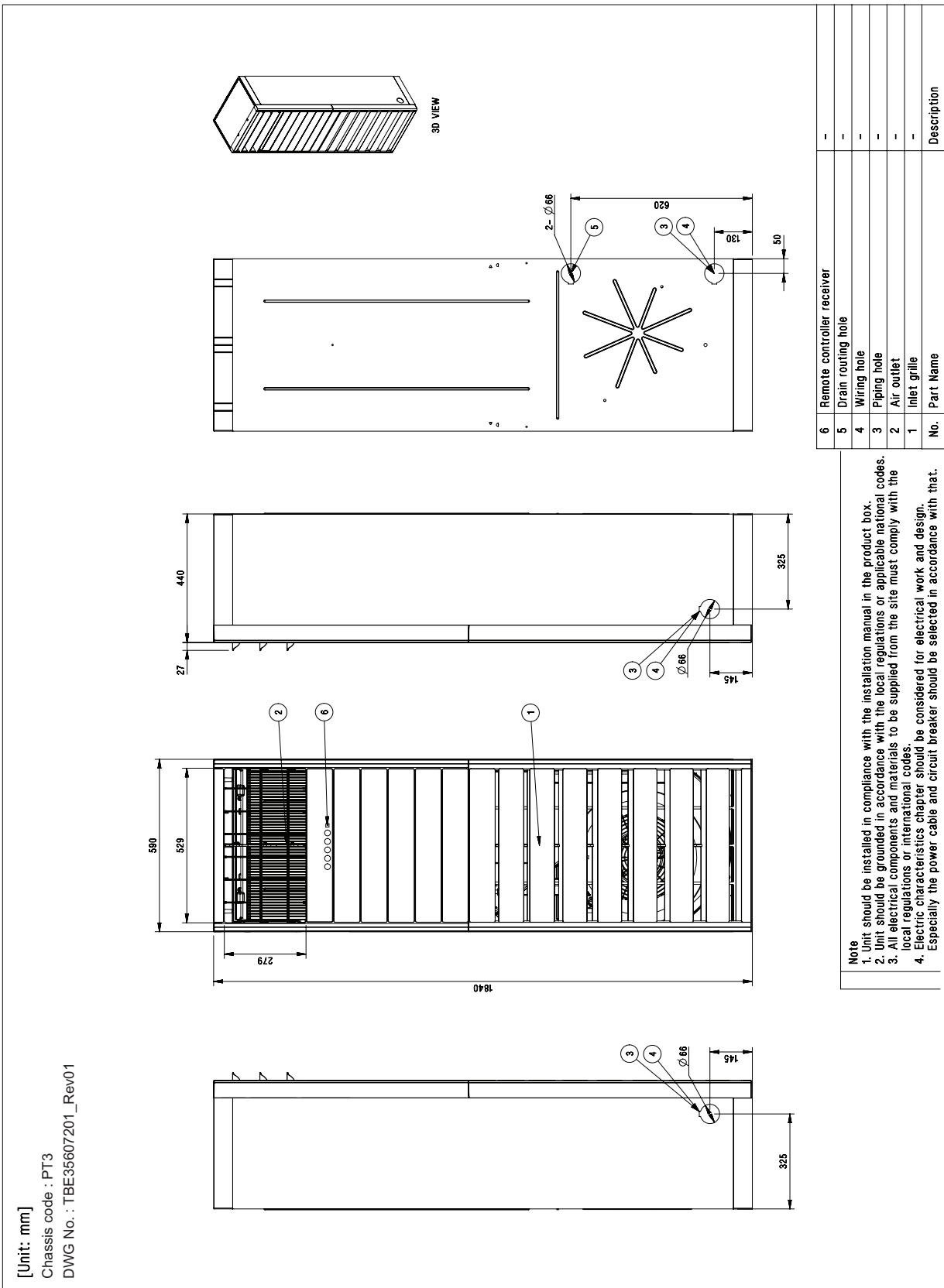

3. Dimensions

◆ ARNU96GPF4

[Unit : mm]
 Chassis : PF2
 DWG No. : AJT75795501_Rev.00

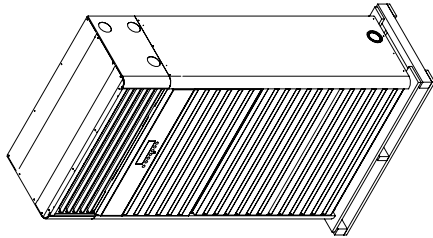

3D View

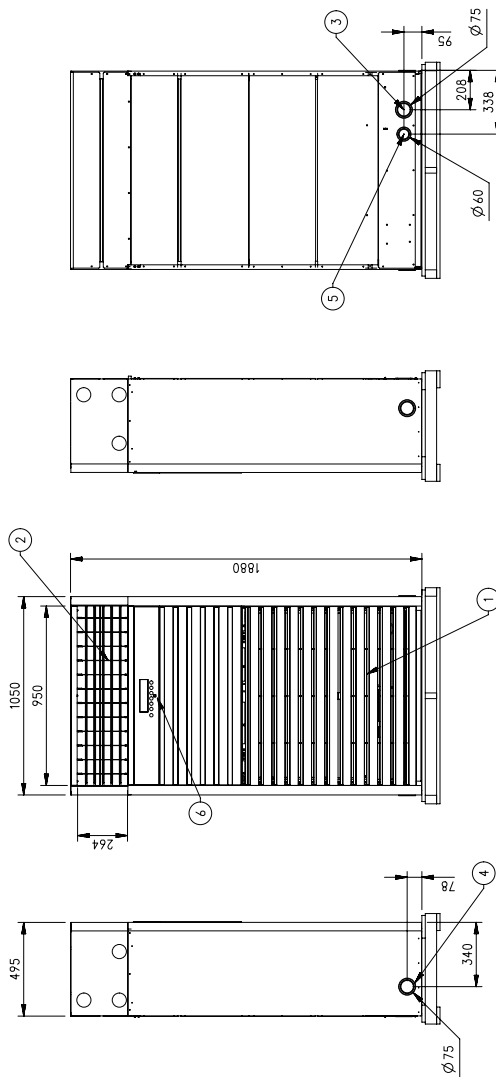

No.	Part Name	Description
6.	Remote controller receiver	-
5.	Drain routing hole	-
4.	Wiring hole	-
3.	Piping hole	-
2.	Air outlet	-
1.	Inlet grille	-
No.	Part Name	Description

Notice

1. Unit should be installed in compliance with the installation manual in the product box.
2. Unit should be grounded in accordance with the local regulations or applicable national codes.
3. All electrical components and materials to be supplied from the site must comply with the local regulations or international codes.
4. Electrical characteristics chapter should be considered for electrical work and design. Especially the power cable and circuit breaker should be selected in accordance with that.

3. Dimensions

3.2 Installation Space

3.2.1 Installation Space : Floor Standing _ PT3

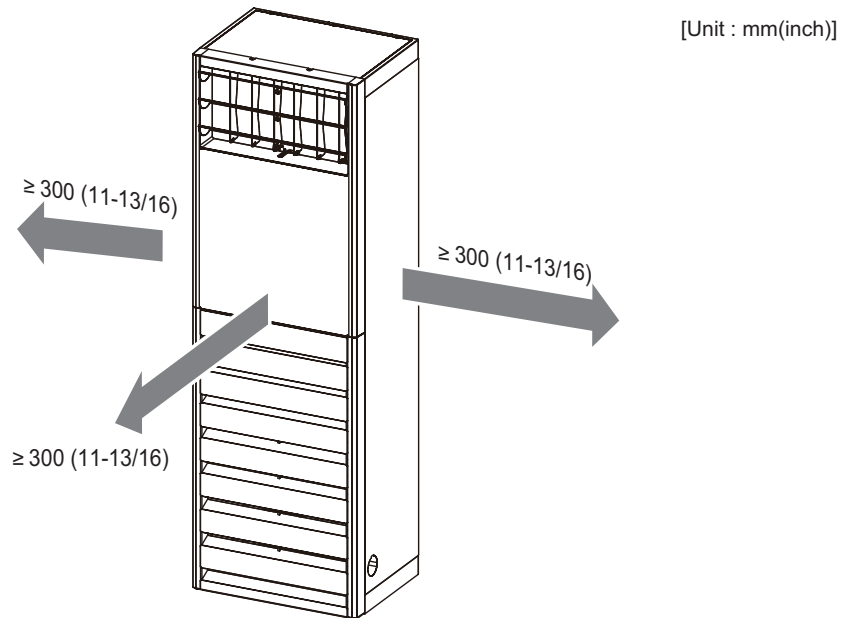

Note

- These values are the least space for installation. If any service area is needed for service according to field circumstance, obtain enough service space.
- Places where products are installed should not be any obstacles to the air circulation or installation. Ensure the spaces from the wall, ceiling, or other obstacles.
- According to type of indoor unit, external appearance or installed structure could be different.
- According to product type, model line up, sales region..etc, applicability of each chassis could be different.

3. Dimensions

3.2.2 Installation Space : Floor Standing - PF2

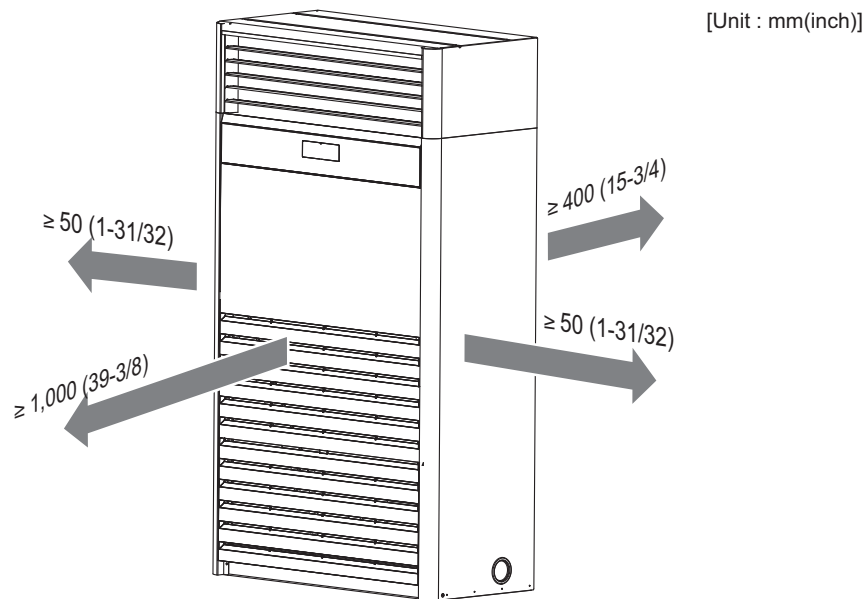

Note

- These values are the least space for installation. If any service area is needed for service according to field circumstance, obtain enough service space.
- Places where products are installed should not be any obstacles to the air circulation or installation. Ensure the spaces from the wall, ceiling, or other obstacles.
- According to type of indoor unit, external appearance or installed structure could be different.
- According to product type, model line up, sales region..etc, applicability of each chassis could be different.

4. Piping Diagrams

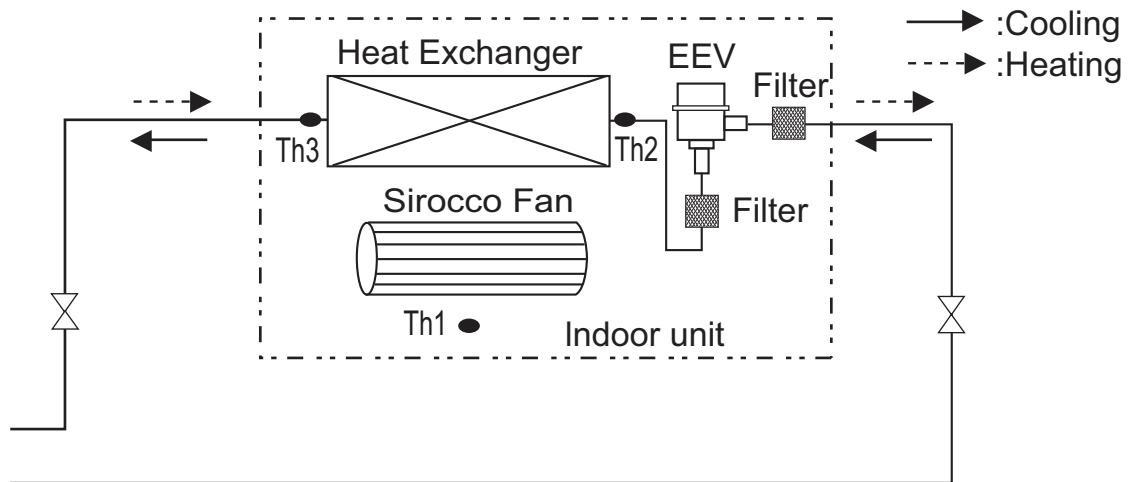

LOC.	Description	PCB Connector
Th1	Room thermistor	CN-ROOM/TH
Th2	Pipe in thermistor	CN-EVA/TH
Th3	Pipe out thermistor	CN-EVA/TH2

5. Wiring Diagrams

ARNU48GPTA4

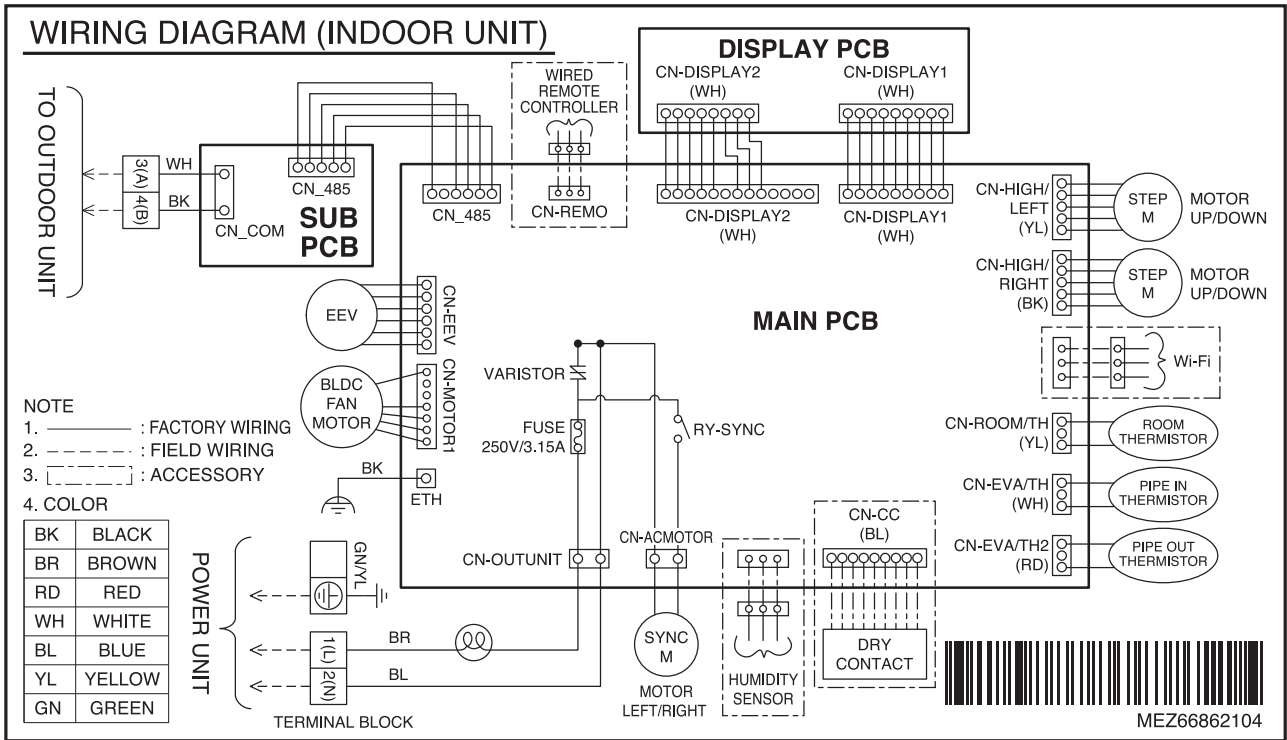

ARNU96GPFA4

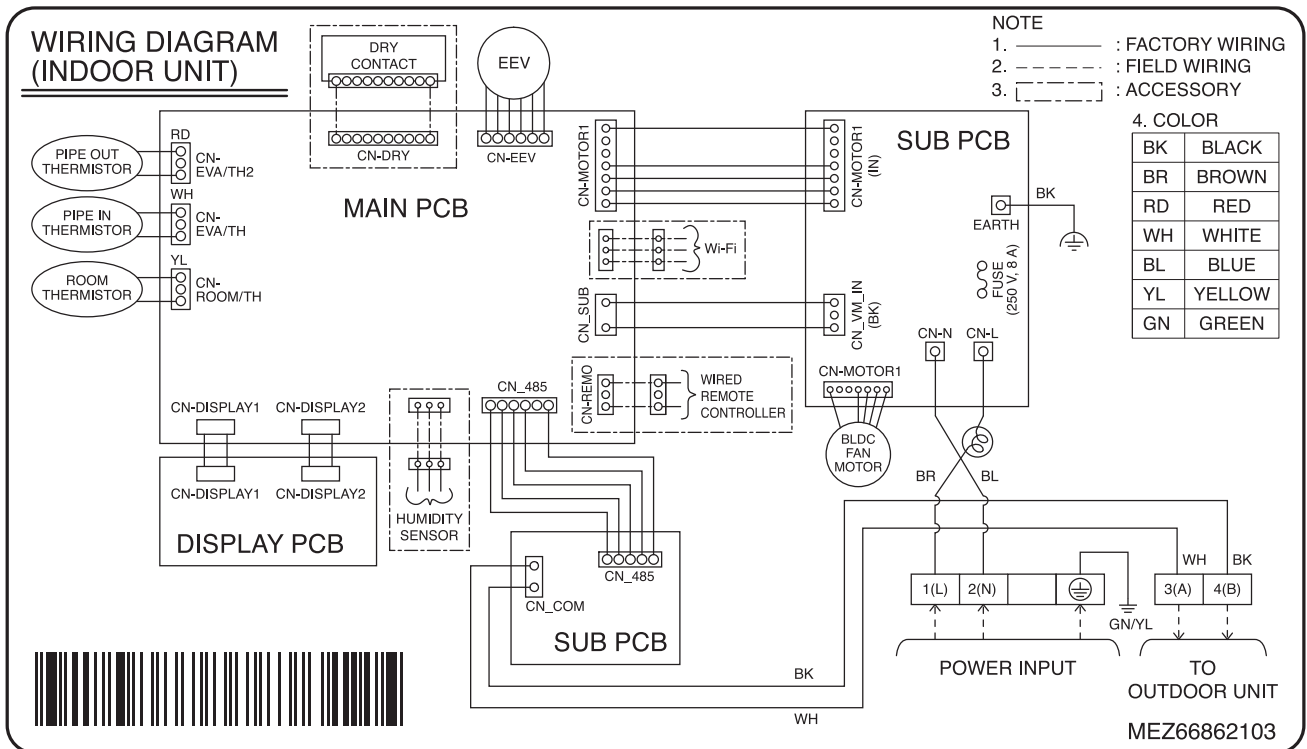

6. Capacity Tables

6.1 Cooling Capacity

Capacity Index (kW)	Indoor air temp.(°C)(DB/WB)													
	20		22		26		27		28		30		32	
	14		16		18		19		20		22		24	
	TC	SHC	TC	SHC	TC	SHC	TC	SHC	TC	SHC	TC	SHC	TC	SHC
14.1	9.5	7.7	11.3	8.4	13.1	9.1	14.1	9.3	15.1	9.7	15.3	9.1	15.5	8.4
28.0	18.9	14.5	22.5	15.9	26.0	17.3	28.0	17.6	30.0	18.3	30.4	17.3	30.8	15.9

Note

1. TC: Total Capacity(kW), SHC: Sensible Heat Capacity(kW)
2. Capacity tables show the average value of conditions which may occur.
3. Refer to Capacity tables and correction factor in the outdoor unit PDB for the actual performance data of each indoor unit and outdoor unit combination.

6.2 Heating Capacity

Capacity Index	Indoor air temp.(°C)(DB)					
	16	18	20	21	22	24
	TC	TC	TC	TC	TC	TC
14.1	17.9	16.9	15.9	15.4	14.9	13.9
28.0	35.5	33.5	31.5	30.5	29.5	27.5

Note

1. TC: Total Capacity(kW)
2. Capacity tables show the average value of conditions which may occur.
3. Refer to Capacity tables and correction factor in the outdoor unit PDB for the actual performance data of each indoor unit and outdoor unit combination.

7. Air Velocity and Temperature Distribution(Reference Data)

◆ ARNU48GPTA4

Cooling

Discharge angle: 90°

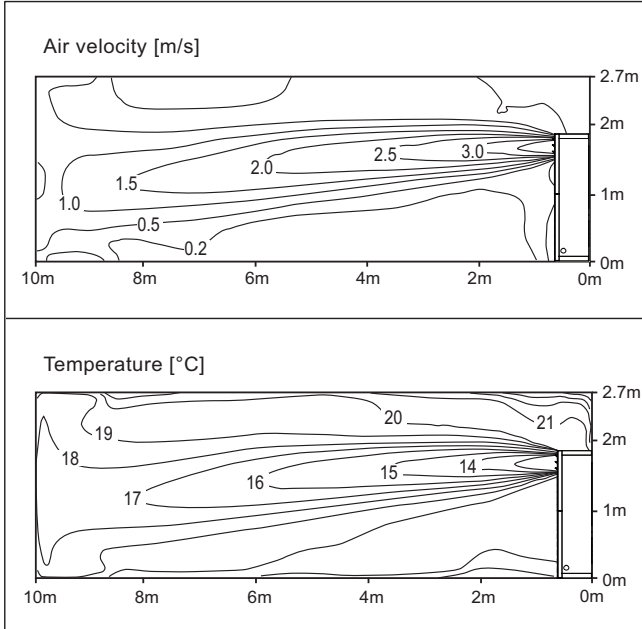

Heating

Discharge angle: 90°

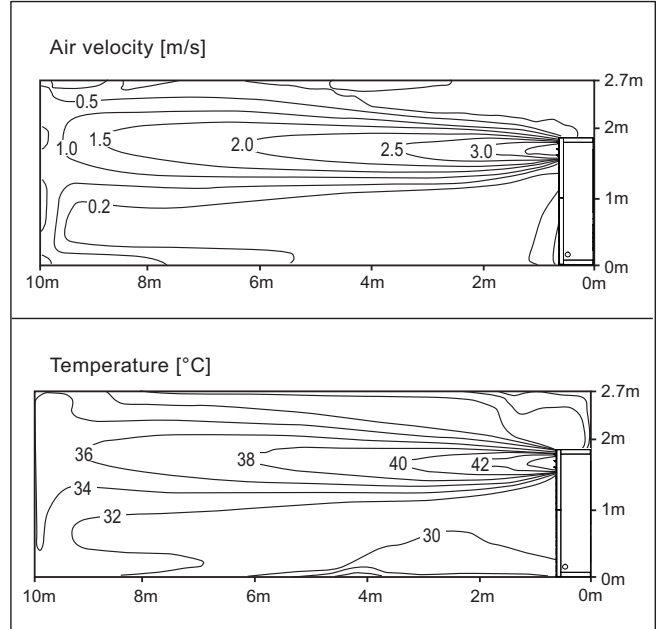

◆ ARNU96GPFA4

Cooling

Discharge angle: 90°

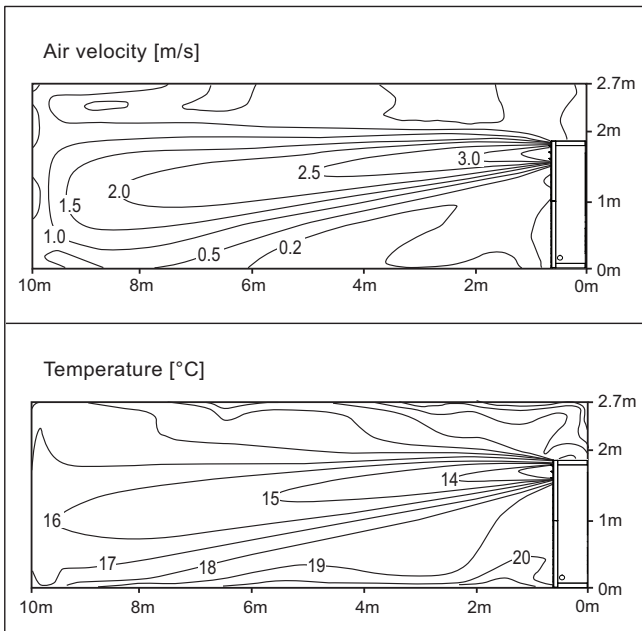

Heating

Discharge angle: 90°

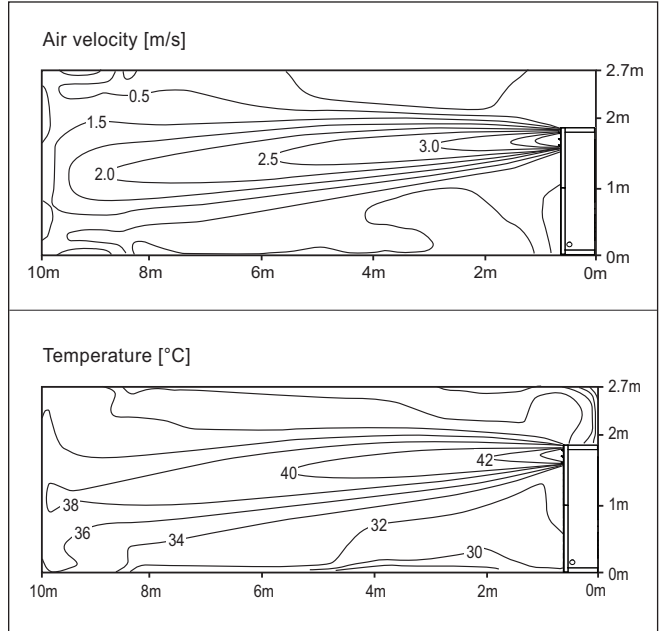

8. Electric Characteristics

Units					Power Supply		IFM		Power Input(W)	
Model	Type	Hz	Volts	Voltage Range	MCA	MFA	kW	FLA	Cooling	Heating
ARNU48GPTA4	PT3	50	220-240	Max. : 264 Min. : 198	1.63	15	0.224	1.3	260	260
ARNU96GPFA4	PF2				2.88	15	0.700	2.3	400	400
ARNU48GPTA4	PT3	60	220	Max. : 242 Min. : 198	1.63	15	0.224	1.3	260	260
ARNU96GPFA4	PF2				2.88	15	0.700	2.3	400	400

Symbols

MCA : Minimum Circuit Amperes (A)

kW : Fan Motor Rated Output (kW)

FLA : Full Load Amperes (A)

IFM : Indoor Fan Motor

PI : Maximum Power Input (W)

Note

- Voltage range
Units are suitable for use on electrical systems where voltage supplied to unit terminals is not below or above the listed range limits.
- Maximum allowable voltage unbalance between phases is 2%.
- MCA/MFA
 $MCA = 1.25 \times FLA$
 $MFA = 1.1 \times MCA, MFA \leq 4 \times FLA$
 (If MFA is smaller than minimum standard value, Use minimum standard value in region for selecting circuit breaker.)
- Select wire size based on the MCA
- Instead of fuse, use Circuit Breaker.

9. Sound Levels

9.1 Sound Pressure Levels

Overall

Note

- 1.Sound measured at some distance away from the center of the unit.
- 2.Data is valid at free field condition.
- 3.Reference acoustic pressure 0dB = 20μPa.
- 4.Data is valid at nominal operation condition.
Refer to the Model Specifications for nominal conditions(Power source and Ambient temperature, etc)
- 5.Sound levels can be increased in accordance with installation and operating conditions. (Static pressure mode, used air guide, Room target temperature setting, etc)
- 6.Sound level will vary depending on a range of factors such as the construction(acoustic absorption coefficient) of particular room in which the equipment is installed.
- 7.Sound pressure level is measured on the rated condition in the anechoic rooms by ISO 3745 standard.
Therefore, these values can be increased owing to ambient conditions during operation.

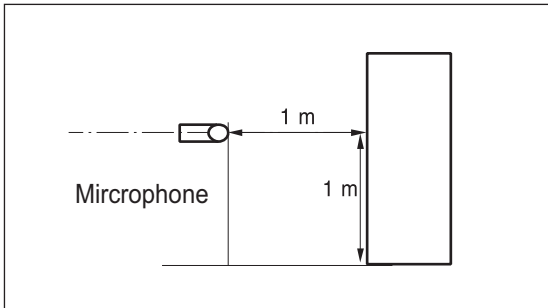

Model	Sound Pressure Levels [dB(A)]			
	SH	H	M	L
ARNU48GPTA4	54	51	49	45
ARNU96GPFA4	60	57	-	53

ARNU48GPTA4

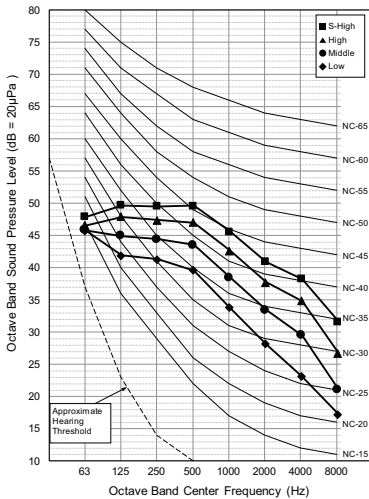

ARNU96GPFA4

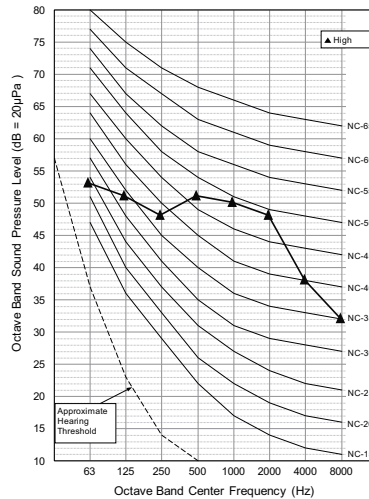

MULTI V™
Indoor Unit

Fresh Air Intake Unit

- 1. List of functions**
- 2. Specifications**
- 3. Dimensions & Gravity Point**
- 4. Piping Diagrams**
- 5. Wiring Diagrams**
- 6. Capacity Tables**
- 7. Fan Characteristics**
- 8. Electric Characteristics**
- 9. Sound Levels**

1. List of functions

◆ List of functions

Category	Function	ARNU76GB8Z4, ARNU96GB8Z4
Air Flow	Air Supply Outlet	1
	Airflow Steps (fan/cool/heat)	3 / 3 / 3
	Fan Speed Auto*	X
	Power Cool/Heat	X / X
	Dry Operation	O
Air Purification	Air Purify	X
	Pre-Filter	O
Reliability	Hot Start	O
	Self Diagnosis	O
Convenience	Auto Mode	O
	Auto Dry Operation	O
	Auto Restart	O
	Child Lock*	O
	Group Control*	O
	Sleep Timer	O
	Turn On/Off Reservation	O
	Schedule*	O
	Two Thermistor Control*	O
External On/Off	O	
Installation	Drain Pump	O
	E.S.P. Control*	O
Special Functions	Wi-Fi	Accessory

Note

- O : Applied, X : Not Applied, - : Unconfirmed or irrelevant
 Embedded : A kit is provided by default for using this function when the product is manufactured.
 Accessory : Ordered and purchased separately the accessory package referring to the model name provided and install at field. Accessory line-ups varies by region, so check your local catalogue or local sales material.
- Some functions can be limited by remote controller.
- Selecting a wireless remote controller in case of ducted type indoor units requires either a connection to the wired remote controller (Standard II) or an IR receiver accessory to be connected to the duct in order to receive the signal.
- 'Auto Mode' varies depending on the outdoor unit type.
 - Auto Change Over(Heat Recovery Outdoor Unit)
 - Auto Mode Select(Heat Pump Outdoor Unit)
 - Auto Intensity Control(Cooling Only Outdoor Unit)
- * : These functions need to connect the wired remote controller.

1. List of functions

◆ Accessory Compatibility List

Category	Accessory Name	Model Name	Description	ARNU**GB8Z4
Remote Controller	Wired - Premium	PREMTA000	-	○
		PREMTA000A	-	○
		PREMTA000B	-	○
	Wired - RS3 (Standard III)	PREMTB100/PREMTB101	White	○
		PREMTBB10/PREMTBB11	Black	○
	Wired - RS2 (Standard II)	PREMTB001	White	○
		PREMTBB01	Black	○
	Wired - Simple	PQRCVCL0QW	White	○
		PQRCVCL0Q	Black	○
	Wired - Simple for Hotel	PQRCHCA0QW	White	○
		PQRCHCA0Q	Black	○
	Wireless	PQWRCQ0FDB	For Cooling only	○
		PQWRHQ0FDB	For Heat pump	○
PWLSSB21C		For Cooling only	○	
PWLSSB21H		For Heat pump	○	
Dry Contact	Simple	PDRYCB000	1 input port, AC 220 - 240V	○
		PDRYCB100	1 input port, AC 24V	○
	Communication	PDRYCB400	2 input port	○
		PDRYCB300	8 input port, For 3rd party Thermostat	○
		PDRYCB320	8 input port, For 3rd Party Thermostat (Analog Input)	○
PDRYCB500	For 3rd Party Controller (Modbus RTU)	○		
Integration Device	Remote Temperature sensor	PQRSTA0	-	○
	Zone Controller	ABZCA	For Duct, 4zone, 220-240V	X
	Group Control wire	PZCWRCG3	Cable Assembly For group control (Y-type cable : 0.25m, cable : 9.6m)	○
ETC	Extension wire	PZCWRC1	Extension wire For IDU-wired remote controller (9.6m)	X
	2-Remo Control Wire	PZCWRC2	-	X
	Wi-Fi Modem	PWFMDD200	-	○
	Wi-Fi Extension cable	PWYREW000	USB Extension cable : 10 m	○
	IR Receiver	PWLRVN000	For wireless remote controller with Duct	○
	Independent Power Module	PRIP0	-	○
	Multi-tenant Power module	PINPMB001	-	○
	Refrigerant Leakage Detector	PRLDNVS0	For R410A only	○
	UVnano Filter Box	PBM13M1UA0	For M1 Chassis	X
		PBM13M2UA0	For M2 Chassis	X
		PBM13M3UA0	For M3 Chassis	X
	High Efficiency Filter (Main Filter of Filter Box)	FBM13M1UA0	For M1 UVnano Filter Box	X
		FBM13M2UA0	For M2 UVnano Filter Box	X
		FBM13M3UA0	For M3 UVnano Filter Box	X
EEV Kit	PRGK024A0	For Multi V Indoor Unit	X	
Auxiliary Heater Relay Kit	PRARH1	For Cassette and Duct Indoor Units	X	

Note

1. ○: Possible, X: Impossible, - : Not applicable, Embedded : Included with product.
2. If there is a difference in development time between the product and the remote controller, some functions cannot be operated.
3. If using Wi-Fi controller, Some advanced functions controlled by remote controller cannot be operated.
4. Selecting a wireless remote controller in case of ducted type indoor units requires either a connection to the wired remote controller (Standard II) or an IR receiver accessory to be connected to the duct in order to receive the signal.
5. If you need more detail, please refer to the **BECON** PDB or the manual of product. (<http://partner.lge.com/global> : Home> Doc.Library> Product > Control(BECON))

2. Specifications

Type		Fresh Air Intake Unit	
Model		Unit	Model
			ARNU76GB8Z4
			ARNU96GB8Z4
Cooling Capacity		kW	22.4
		kcal/h	19,300
		Btu/h	76,400
Heating Capacity		kW	21.4
		kcal/h	18,410
		Btu/h	73,080
Power Input (H / M / L)		W	230 / 200 / 200
Casing			Galvanized Steel Plate
Dimensions (WxHxD)	Body	mm	1,562 x 460 x 688
		inch	61-1/2 x 18-1/8 x 27-3/32
Coil	Rows x Columns x FPI		3 x 20 x 19
	Face Area	m ²	0.59
Fan	Type		Sirocco Fan
	Motor Output x Number	W	375 x 1
	Air Flow Rate(H/M/L) (High static Mode-factory set)	m ³ /min	23.7 / 13.2 / 13.2
		ft ³ /min	837 / 446 / 446
	External Static Pressure	mmAq(Pa)	22
	External Static Pressure (Min ~ Max)	mmAq(Pa)	7 ~ 25
	Drive		Direct
Motor type		BLDC	
Temperature Control			Microprocessor, Thermostat for cooling and heating
Sound Absorbing Thermal Insulation Material			Foamed polystyrene
Air Filter			Long Life Filter
Safety Device			Fuse
Pipe Connections	Liquid Side	mm(inch)	Ø9.52(3/8)
	Gas Side	mm(inch)	Ø19.05(3/4)
	Drain Pipe(Internal Dia.)	mm	25
Net Weight		kg(lbs)	73(161)
Sound Pressure Levels (H / M / L)		dB(A)	45 / 43 / 43
Sound Power Levels (H / M / L, Body)		dB(A)	56 / 54 / 54
Power Supply		Ø, V, Hz	1, 220 - 230 - 240, 50/60
Running Current by voltage	Rated	A	1.31 - 1.25 - 1.20
Maximum Running Current		A	2.15
Refrigerant	Type	-	R410A / R32
	Additional Charging Amount (CF Value of IDU)	kg(each)	1.00 / 0.83
	Control	-	EEV
Transmission cable		mm ²	1.0 ~ 1.5 x 2C

Note

- Capacities are based on the following conditions :
 - Cooling
 - Outdoor temp. 33°C[91.4°F]DB/ 28°C[82.4°F]WB
 - Interconnecting Piping Length 7.5m / Level Difference of Zero
 - Heating
 - Outdoor temp. 0°C[32°F]DB/ -2.9°C[26.78°F]WB
 - Interconnecting Piping Length 7.5m / Level Difference of Zero
- Capacities are Net Capacities
- Due to our policy of innovation some specifications may be changed without prior notification .
- To be added for more available Models
- Sound Level is Standard Mode (for actual High Mode(factory set) condition, Sound Level may exceed the standard level by 1.5dB(A)
- Sound pressure level is measured on the rated condition in the anechoic rooms by ISO 3745 standard.
Sound power level is measured on the rated condition in the semi-anechoic rooms by ISO 9614 standard.
Therefore, these values can be increased owing to ambient conditions during operation.
- Refrigerant information (type, additional charging amount, etc.) must be applied by refrigerant type of the combined outdoor unit.
Adapt after checking the specifications of outdoor unit.

3. Dimensions & Gravity point

3.1 Dimensional Drawings

ARNU76GB8Z4 / ARNU96GB8Z4

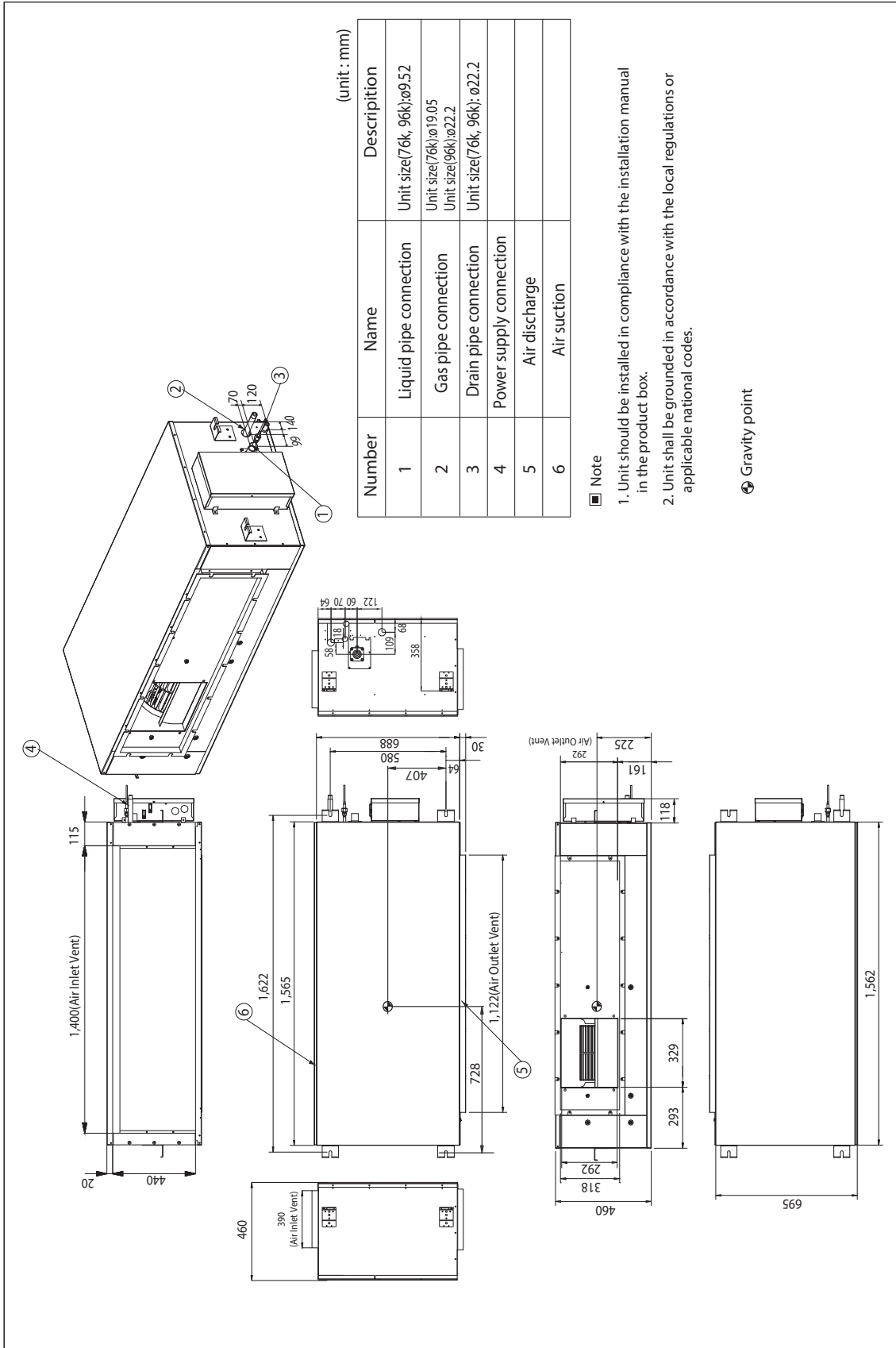

3. Dimensions & Gravity point

3.2 Installation Space

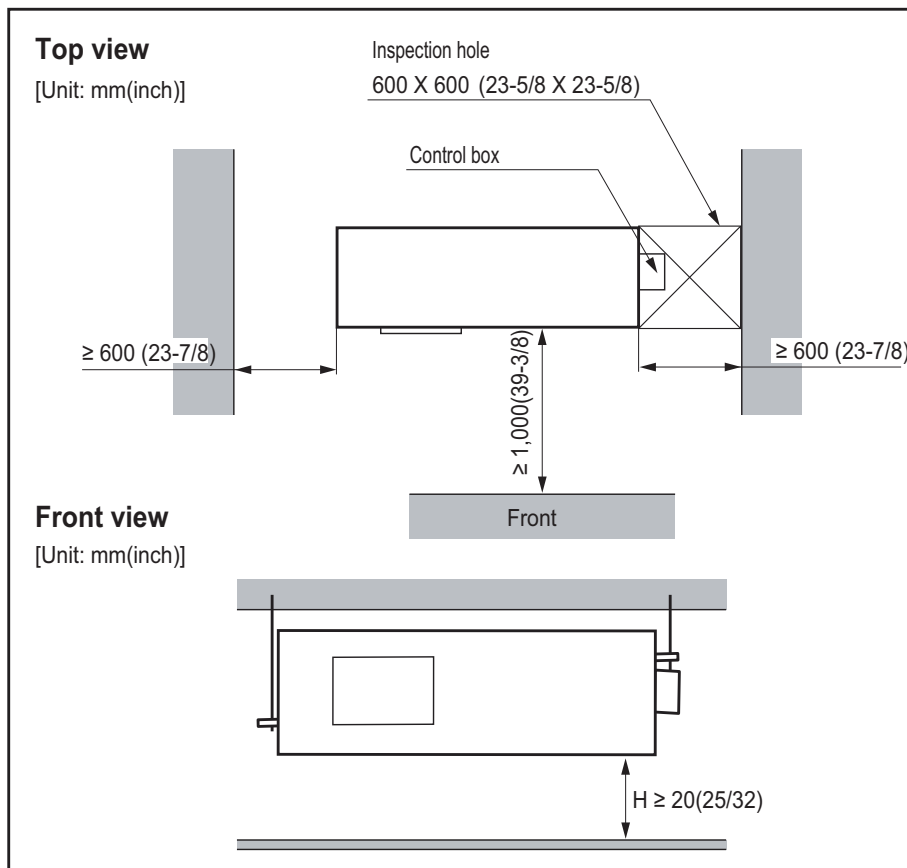

Note

In case that the unit is installed near the sea, the installation parts may be corroded by salt. The installation parts (and the unit) should be taken appropriate anti-corrosion measures.

Note

- Places where products are installed should not be any obstacles to the air circulation or installation. Ensure the spaces from the wall, ceiling, or other obstacles.
- According to type of indoor unit, external appearance or installed structure could be different.
- According to product type, model line up, sales region..etc, applicability of each chassis could be different.

4. Piping Diagrams

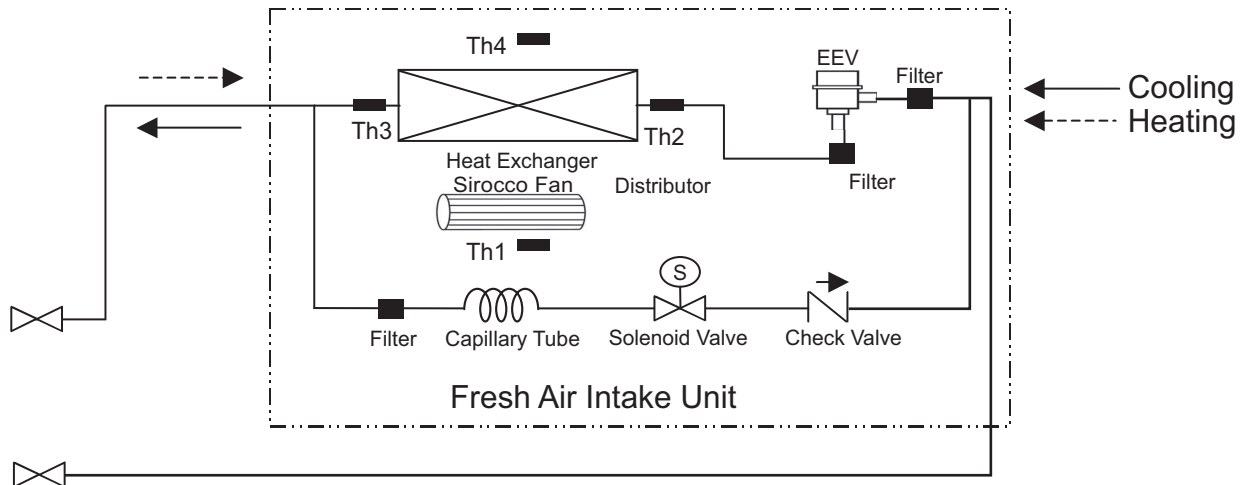

◆ Refrigerant pipe connection port diameter

Model	Gas [mm(inch)]	Liquid [mm(inch)]
ARNU76GB8Z4	Ø19.05(6/8)	Ø9.52(3/8)
ARNU96GB8Z4	Ø22.2(7/8)	Ø9.52(3/8)

LOC.	Description
Th1	Inlet Air Thermistor
Th2	Pipe In Thermistor
Th3	Pipe Out Thermistor
Th4	Outlet Air Thermistor

5. Wiring Diagrams

B8 Chassis

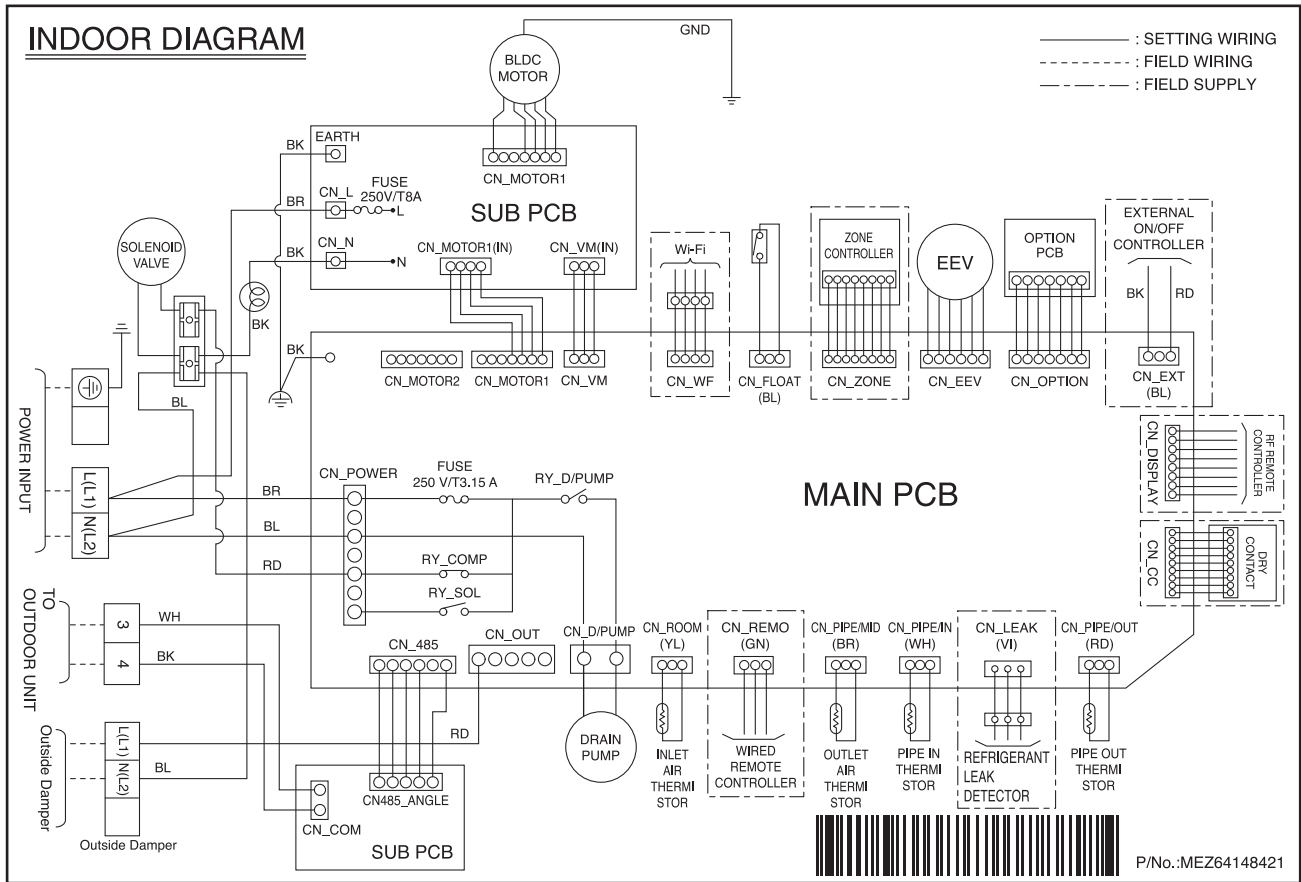

CONNECTOR NUMBER	LOCATION POINT	FUNCTION
CN-POWER	AC Power supply	AC Power line input for indoor controller
CN-MOTOR1	Fan motor output	Motor output of BLDC
CN-MOTOR2	Fan motor output	Motor output of BLDC
CN-D_PUMP	Drain pump output	AC output for drain pump
CN-COM	Communication	Connection between indoor and outdoor
CN-EEV	EEV Output	EEV Control output : connect to EEV directly or through IPM(Independent Power Module)
CN-LEAK	Refrigerant leak detector	Refrigerant leak detector line
CN-FLOAT	Float switch input	Float switch sensing
CN-PIPE/IN	Suction pipe sensor	Pipe in thermistor
CN-PIPE/OUT	Discharge pipe sensor	Pipe out thermistor
CN-ROOM	Room sensor	Room air thermistor
CN-REMO	Remote controller	Remote control line
CN-ZONE	Zontroller	Zone control line
CN-DISPLAY	RF Remote controller	RF Remote control line
CN-CC	Dry contact	Dry contact line
CN-EXT	External On/Off	External On/Off signal input
CN_WF	Wi-Fi Controller	Wifi control line

	Function	Description	Setting Off	Setting On	Default
SW1	Communication	N/A (Default)	-	-	Off
SW2	Cycle	N/A (Default)	-	-	Off
SW3	Group Control	Selection of Master or Slave	Master	Slave	Off
SW4	Dry Contact Mode	Selection of Dry Contact Mode	Wired/Wireless remote controller selection of Manual or Auto operation Mode	Auto	Off
SW5	Installation	Fan continuous operation	Continuous operation Removal	-	Off
SW6	Heater linkage	N/A	-	-	Off
SW7	Ventilator linkage	Selection of Ventilator linkage	Linkage Removal	Working	Off
	Vane selection (Console)	Selection of up/down side Vane	Up side + Down side Vane	Up side Vane Only	
	Region selection	Selection tropical region	General model	Tropical model	
SW8	Etc.	Spare	-	-	Off

5. Wiring Diagrams

 **CAUTION**

For Multi V Models, DIP switch 1, 2, 6, 8 must be set OFF.

6. Capacity tables

■ ARNU76GB8Z4

◆ Cooling

Outdoor Air	19 °CDB		21 °CDB		23 °CDB		25 °CDB		27 °CDB		29 °CDB		31 °CDB	
	TC	SHC	TC	SHC	TC	SHC	TC	SHC	TC	SHC	TC	SHC	TC	SHC
32 °CWB	-	-	-	-	-	-	-	-	-	-	-	-	-	-
31 °CWB	-	-	-	-	-	-	-	-	-	-	-	-	-	-
30 °CWB	-	-	-	-	-	-	-	-	-	-	-	-	-	-
29 °CWB	-	-	-	-	-	-	-	-	-	-	-	-	23.6	7.1
28 °CWB	-	-	-	-	-	-	-	-	-	-	-	-	23.0	7.8
27 °CWB	-	-	-	-	-	-	-	-	-	-	21.5	7.1	21.1	7.9
26 °CWB	-	-	-	-	-	-	-	-	-	-	19.4	7.1	19.2	8.0
25 °CWB	-	-	-	-	-	-	-	-	18.3	6.5	18.0	7.4	17.8	8.0
24 °CWB	-	-	-	-	-	-	-	-	17.0	6.8	16.7	7.5	16.4	8.0
23 °CWB	-	-	-	-	-	-	16.0	6.1	15.7	6.9	15.3	7.5	15.0	8.0
22 °CWB	-	-	-	-	-	-	14.7	6.3	14.4	7.0	14.0	7.5	13.8	8.1
21 °CWB	-	-	-	-	13.5	5.6	13.3	6.3	13.1	7.0	12.8	7.5	12.6	8.1
20 °CWB	-	-	-	-	12.4	5.8	12.0	6.3	11.8	6.9	11.5	7.5	11.4	8.1
19 °CWB	-	-	11.6	5.2	11.3	5.8	10.9	6.3	10.8	7.0	10.5	7.6	10.4	8.3
18 °CWB	-	-	10.5	5.3	10.1	5.8	9.8	6.4	9.8	7.1	9.5	7.7	-	-
17 °CWB	10.0	4.8	9.5	5.3	9.0	5.8	8.7	6.4	8.8	7.2	-	-	-	-
16 °CWB	9.1	5.0	8.8	5.6	8.5	6.3	8.3	6.9	8.5	8.0	-	-	-	-
15 °CWB	8.1	5.1	8.0	5.9	7.9	6.7	7.8	7.5	-	-	-	-	-	-
14 °CWB	6.9	5.0	7.0	6.0	7.1	7.1	-	-	-	-	-	-	-	-
13 °CWB	5.7	4.9	6.0	6.0	6.3	6.3	-	-	-	-	-	-	-	-
12 °CWB	4.5	4.5	5.0	5.0	-	-	-	-	-	-	-	-	-	-
11 °CWB	3.3	3.3	-	-	-	-	-	-	-	-	-	-	-	-

Outdoor Air	33 °CDB		35 °CDB		37 °CDB		40 °CDB		43 °CDB		45 °CDB		48 °CDB	
	TC	SHC	TC	SHC	TC	SHC	TC	SHC	TC	SHC	TC	SHC	TC	SHC
32 °CWB	-	-	26.7	7.6	26.4	8.5	26.2	9.9	25.2	10.4	24.3	10.6	23.6	11.2
31 °CWB	25.4	7.0	24.9	7.9	24.7	8.8	24.4	9.8	23.8	10.5	23.0	10.8	22.2	11.3
30 °CWB	23.8	7.4	23.1	8.2	22.9	9.0	22.5	9.7	22.4	10.6	21.6	10.9	-	-
29 °CWB	23.1	8.0	22.3	8.7	21.9	9.2	21.7	10.1	21.3	10.9	20.5	11.1	-	-
28 °CWB	22.4	8.6	21.5	9.0	20.9	9.5	20.8	10.4	20.1	11.1	-	-	-	-
27 °CWB	20.7	8.7	20.1	9.1	19.7	9.6	19.2	10.4	-	-	-	-	-	-
26 °CWB	18.9	8.6	18.7	9.2	18.4	9.7	17.6	10.3	-	-	-	-	-	-
25 °CWB	17.5	8.6	17.3	9.2	16.9	9.7	-	-	-	-	-	-	-	-
24 °CWB	16.1	8.6	15.8	9.1	15.5	9.7	-	-	-	-	-	-	-	-
23 °CWB	14.7	8.6	14.4	9.1	14.0	9.5	-	-	-	-	-	-	-	-
22 °CWB	13.5	8.6	13.0	9.0	-	-	-	-	-	-	-	-	-	-
21 °CWB	12.3	8.7	-	-	-	-	-	-	-	-	-	-	-	-
20 °CWB	-	-	-	-	-	-	-	-	-	-	-	-	-	-
19 °CWB	-	-	-	-	-	-	-	-	-	-	-	-	-	-
18 °CWB	-	-	-	-	-	-	-	-	-	-	-	-	-	-
17 °CWB	-	-	-	-	-	-	-	-	-	-	-	-	-	-
16 °CWB	-	-	-	-	-	-	-	-	-	-	-	-	-	-
15 °CWB	-	-	-	-	-	-	-	-	-	-	-	-	-	-
14 °CWB	-	-	-	-	-	-	-	-	-	-	-	-	-	-
13 °CWB	-	-	-	-	-	-	-	-	-	-	-	-	-	-
12 °CWB	-	-	-	-	-	-	-	-	-	-	-	-	-	-
11 °CWB	-	-	-	-	-	-	-	-	-	-	-	-	-	-

Note

1. TC: Total Capacity (kW), SHC: Sensible Heat Capacity (kW), WB: Wet Bulb, DB: Dry Bulb
2. The data shown in the table illustrates the supported operating ranges under the following conditions:
 - Indoor and Outdoor Unit
 - Effective piping length: 7.5 m
 - Height differential: 0 m
3. The actual temperature may not match the temperature setting under some circumstances due to the outdoor air processing load or mechanical protection controls.
4. Shaded areas are data for Tropical use only.

6. Capacity tables

◆ Heating

Outdoor Air	-5℃ DB	-3℃ DB	-1℃ DB	0℃ DB	1℃ DB	3℃ DB	5℃ DB	7℃ DB	9℃ DB	11℃ DB	13℃ DB	15℃ DB
	TC	TC	TC	TC	TC	TC	TC	TC	TC	TC	TC	TC
14℃ WB	-	-	-	-	-	-	-	-	-	-	-	12.8
13℃ WB	-	-	-	-	-	-	-	-	-	-	-	12.8
12℃ WB	-	-	-	-	-	-	-	-	-	-	13.7	12.8
11℃ WB	-	-	-	-	-	-	-	-	-	-	13.7	12.8
10℃ WB	-	-	-	-	-	-	-	-	-	14.5	13.7	12.8
9℃ WB	-	-	-	-	-	-	-	-	-	14.5	13.7	12.8
8℃ WB	-	-	-	-	-	-	-	-	15.4	14.5	13.7	12.8
7℃ WB	-	-	-	-	-	-	-	-	15.4	14.5	13.7	12.8
6℃ WB	-	-	-	-	-	-	-	16.3	15.4	14.5	13.7	12.8
5℃ WB	-	-	-	-	-	-	-	16.3	15.4	14.5	13.7	-
4℃ WB	-	-	-	-	-	-	18.1	16.3	15.4	14.5	-	-
3℃ WB	-	-	-	-	-	-	18.1	16.3	15.4	-	-	-
2℃ WB	-	-	-	-	-	19.4	18.1	16.3	15.4	-	-	-
1℃ WB	-	-	-	-	-	19.4	18.1	16.3	-	-	-	-
0℃ WB	-	-	-	-	20.7	19.4	18.1	-	-	-	-	-
-1℃ WB	-	-	-	21.4	20.7	19.4	18.1	-	-	-	-	-
-2℃ WB	-	-	21.8	21.4	20.7	19.4	18.1	-	-	-	-	-
-3℃ WB	-	-	21.8	21.4	20.7	19.4	-	-	-	-	-	-
-4℃ WB	-	22.6	21.8	21.4	20.7	-	-	-	-	-	-	-
-5℃ WB	-	22.6	21.8	-	-	-	-	-	-	-	-	-
-6℃ WB	22.8	22.6	-	-	-	-	-	-	-	-	-	-
-7℃ WB	22.8	22.6	-	-	-	-	-	-	-	-	-	-
-8℃ WB	22.8	-	-	-	-	-	-	-	-	-	-	-

Note

1. TC: Total Capacity (kW), WB: Wet Bulb, DB: Dry Bulb
2. The data shown in the table illustrates the supported operating ranges under the following conditions:
 - Indoor and Outdoor Unit
 - Effective piping length: 7.5 m
 - Height differential: 0 m
3. The actual temperature may not match the temperature setting under some circumstances due to the outdoor-air processing load or mechanical protection controls.
4. The system will not operate in fan mode when the outdoor air temperature is -5℃ or below.

6. Capacity tables

■ ARNU96GB8Z4

◆ Cooling

Outdoor Air	19 °CDB		21 °CDB		23 °CDB		25 °CDB		27 °CDB		29 °CDB		31 °CDB	
	TC	SHC	TC	SHC	TC	SHC	TC	SHC	TC	SHC	TC	SHC	TC	SHC
32 °CWB	-	-	-	-	-	-	-	-	-	-	-	-	-	-
31 °CWB	-	-	-	-	-	-	-	-	-	-	-	-	-	-
30 °CWB	-	-	-	-	-	-	-	-	-	-	-	-	-	-
29 °CWB	-	-	-	-	-	-	-	-	-	-	-	-	31.8	9.5
28 °CWB	-	-	-	-	-	-	-	-	-	-	-	-	29.8	10.1
27 °CWB	-	-	-	-	-	-	-	-	-	-	28.6	9.3	28.2	10.7
26 °CWB	-	-	-	-	-	-	-	-	-	-	26.9	9.9	26.6	11.1
25 °CWB	-	-	-	-	-	-	-	-	25.4	9.0	24.9	10.3	24.5	11.1
24 °CWB	-	-	-	-	-	-	-	-	23.4	9.4	22.9	10.3	22.5	11.0
23 °CWB	-	-	-	-	-	-	22.3	8.5	21.5	9.5	20.9	10.2	20.4	10.9
22 °CWB	-	-	-	-	-	-	20.2	8.8	19.5	9.4	19.0	10.2	18.7	11.0
21 °CWB	-	-	-	-	18.0	7.5	18.2	8.7	17.6	9.3	17.1	10.0	16.9	10.9
20 °CWB	-	-	-	-	16.7	7.8	16.1	8.4	15.6	9.1	15.2	9.9	15.2	10.8
19 °CWB	-	-	15.8	7.1	15.4	7.9	14.8	8.6	14.2	9.2	13.8	10.0	13.8	11.0
18 °CWB	-	-	14.5	7.3	14.1	8.1	13.4	8.7	12.8	9.3	12.5	10.1	-	-
17 °CWB	13.6	6.5	13.2	7.4	12.8	8.3	12.1	8.9	11.4	9.4	-	-	-	-
16 °CWB	12.0	6.5	11.7	7.5	11.4	8.4	11.0	9.2	10.9	10.2	-	-	-	-
15 °CWB	10.4	6.5	10.2	7.5	10.0	8.5	9.8	9.5	-	-	-	-	-	-
14 °CWB	8.8	6.4	8.7	7.5	8.6	8.6	-	-	-	-	-	-	-	-
13 °CWB	7.1	6.2	7.2	7.2	7.2	7.2	-	-	-	-	-	-	-	-
12 °CWB	5.5	5.5	5.7	5.7	-	-	-	-	-	-	-	-	-	-
11 °CWB	3.9	3.9	-	-	-	-	-	-	-	-	-	-	-	-

Outdoor Air	33 °CDB		35 °CDB		37 °CDB		40 °CDB		43 °CDB		45 °CDB		48 °CDB	
	TC	SHC	TC	SHC	TC	SHC	TC	SHC	TC	SHC	TC	SHC	TC	SHC
32 °CWB	-	-	26.7	7.8	26.4	9.0	26.2	9.9	25.2	10.4	24.3	10.6	23.6	11.2
31 °CWB	35.6	9.8	29.4	9.6	29.1	10.6	28.7	11.6	27.5	12.2	26.6	12.5	29.4	15.0
30 °CWB	33.2	10.3	32.1	11.5	31.8	12.4	31.2	13.5	29.7	14.1	28.8	14.5	-	-
29 °CWB	30.6	10.6	29.9	11.7	29.2	12.3	28.5	13.2	27.4	14.0	26.5	14.3	-	-
28 °CWB	28.0	10.9	27.6	11.6	26.6	12.0	25.8	12.9	25.0	13.8	-	-	-	-
27 °CWB	27.1	11.4	26.7	12.1	26.0	12.7	25.0	13.5	-	-	-	-	-	-
26 °CWB	26.1	11.8	25.8	12.7	25.4	13.4	24.2	14.2	-	-	-	-	-	-
25 °CWB	24.1	11.8	23.7	12.6	23.2	13.3	-	-	-	-	-	-	-	-
24 °CWB	22.0	11.8	21.6	12.5	21.1	13.2	-	-	-	-	-	-	-	-
23 °CWB	20.0	11.7	19.5	12.3	18.9	12.9	-	-	-	-	-	-	-	-
22 °CWB	18.3	11.7	17.5	12.1	-	-	-	-	-	-	-	-	-	-
21 °CWB	16.5	11.6	-	-	-	-	-	-	-	-	-	-	-	-
20 °CWB	-	-	-	-	-	-	-	-	-	-	-	-	-	-
19 °CWB	-	-	-	-	-	-	-	-	-	-	-	-	-	-
18 °CWB	-	-	-	-	-	-	-	-	-	-	-	-	-	-
17 °CWB	-	-	-	-	-	-	-	-	-	-	-	-	-	-
16 °CWB	-	-	-	-	-	-	-	-	-	-	-	-	-	-
15 °CWB	-	-	-	-	-	-	-	-	-	-	-	-	-	-
14 °CWB	-	-	-	-	-	-	-	-	-	-	-	-	-	-
13 °CWB	-	-	-	-	-	-	-	-	-	-	-	-	-	-
12 °CWB	-	-	-	-	-	-	-	-	-	-	-	-	-	-
11 °CWB	-	-	-	-	-	-	-	-	-	-	-	-	-	-

Note

1. TC: Total Capacity (kW), SHC: Sensible Heat Capacity (kW), WB: Wet Bulb, DB: Dry Bulb
2. The data shown in the table illustrates the supported operating ranges under the following conditions:
 - Indoor and Outdoor Unit
 - Effective piping length: 7.5 m
 - Height differential: 0 m
3. The actual temperature may not match the temperature setting under some circumstances due to the outdoor air processing load or mechanical protection controls.
4. Shaded areas are data for Tropical use only.

6. Capacity tables

◆ Heating

Outdoor Air	-5°C DB	-3°C DB	-1°C DB	0°C DB	1°C DB	3°C DB	5°C DB	7°C DB	9°C DB	11°C DB	13°C DB	15°C DB
	TC	TC	TC	TC	TC	TC	TC	TC	TC	TC	TC	TC
14°C WB	-	-	-	-	-	-	-	-	-	-	-	19.6
13°C WB	-	-	-	-	-	-	-	-	-	-	-	19.6
12°C WB	-	-	-	-	-	-	-	-	-	-	20.8	19.6
11°C WB	-	-	-	-	-	-	-	-	-	-	20.8	19.6
10°C WB	-	-	-	-	-	-	-	-	-	21.9	20.8	19.6
9°C WB	-	-	-	-	-	-	-	-	-	21.9	20.8	19.6
8°C WB	-	-	-	-	-	-	-	-	23.6	21.9	20.8	19.6
7°C WB	-	-	-	-	-	-	-	-	23.6	21.9	20.8	19.6
6°C WB	-	-	-	-	-	-	-	25.3	23.6	21.9	20.8	19.6
5°C WB	-	-	-	-	-	-	-	25.3	23.6	21.9	20.8	-
4°C WB	-	-	-	-	-	-	26.0	25.3	23.6	21.9	-	-
3°C WB	-	-	-	-	-	-	26.0	25.3	23.6	-	-	-
2°C WB	-	-	-	-	-	26.3	26.0	25.3	-	-	-	-
1°C WB	-	-	-	-	-	26.3	26.0	25.3	-	-	-	-
0°C WB	-	-	-	-	26.6	26.3	26.0	-	-	-	-	-
-1°C WB	-	-	-	26.7	26.6	26.3	-	-	-	-	-	-
-2°C WB	-	-	27.3	26.7	26.6	26.3	-	-	-	-	-	-
-3°C WB	-	-	27.3	26.7	26.6	-	-	-	-	-	-	-
-4°C WB	-	28.4	27.3	26.7	-	-	-	-	-	-	-	-
-5°C WB	-	28.4	27.3	-	-	-	-	-	-	-	-	-
-6°C WB	28.6	28.4	-	-	-	-	-	-	-	-	-	-
-7°C WB	28.6	28.4	-	-	-	-	-	-	-	-	-	-
-8°C WB	28.6	-	-	-	-	-	-	-	-	-	-	-

Note

1. TC: Total Capacity (kW), WB: Wet Bulb, DB: Dry Bulb
2. The data shown in the table illustrates the supported operating ranges under the following conditions:
 - Indoor and Outdoor Unit
 - Effective piping length: 7.5 m
 - Height differential: 0 m
3. The actual temperature may not match the temperature setting under some circumstances due to the outdoor-air processing load or mechanical protection controls.
4. The system will not operate in fan mode when the outdoor air temperature is -5°C or below.

7. Fan Characteristics

■ Air Flow

Capacity (Btu/h)	Mode	Set value	Standard ESP (mmAq(Pa))	CMM	Lower Limit of External Static Pressure(mmAq)	Upper Limit of External Static Pressure(mmAq)
ARNU76GB8Z4	High (factory set)	High	95	23.7	7	25
		Mid	93	13.2		
ARNU96GB8Z4	High (factory set)	High	97	35.7	7	25
		Mid	95	23.7		

■ PQ Curve

◆ ARNU76GB8Z4

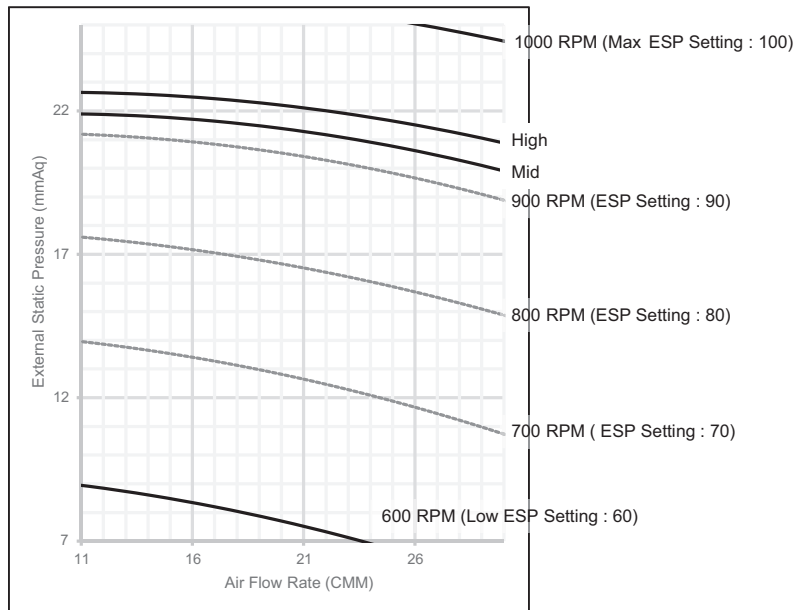

◆ ARNU96GB8Z4

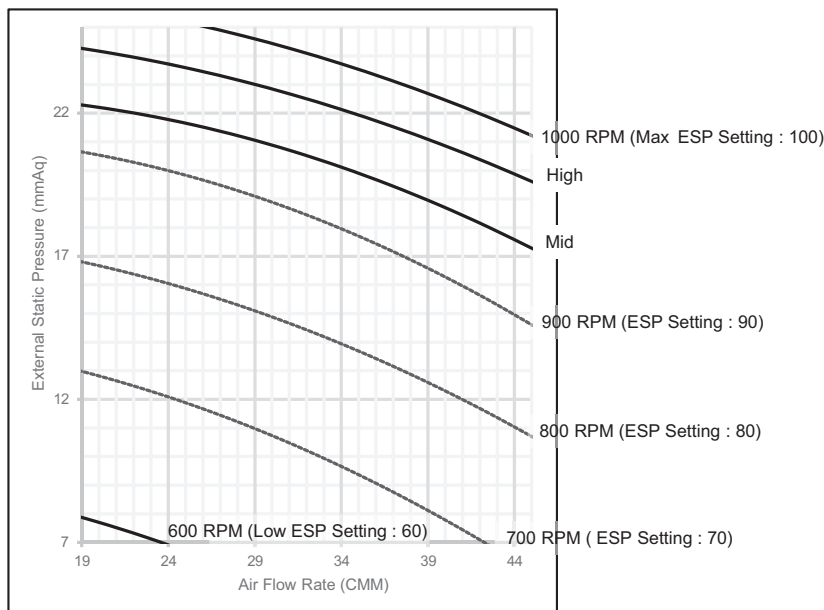

Note

ESP setting value correlates to the motor rotation speed (rpm). ESP setting value can be set in wired remote controller and according to selected value, capacity of IDU will be changed

8. Electric Characteristics

Units					PowerSupply	IFM		PI	
Model	Type	Hz	volts	VoltageRange	MCA	kW	FLA	Cooling	Heating
ARNU76GB8Z4	B8	50	220-240	Max: 264	2.69	0.38	2.15	230	230
ARNU96GB8Z4	B8			Min: 198	2.69	0.38	2.15	360	360
ARNU76GB8Z4	B8	60	220	Max: 242	2.69	0.38	2.15	230	230
ARNU96GB8Z4	B8			Min: 198	2.69	0.38	2.15	360	360

Symbols

MCA : Minimum Circuit Amperes (A)

MFA : Maximum Fuse Amperes (A)

kW : Fan Motor Rated Output (kW)

FLA : Full Load Amperes (A)

IFM : Indoor Fan Motor

PI : Maximum Power Input (W)

Note

- Voltage range
Units are suitable for use on electrical systems where voltage supplied to unit terminals is not below or above the listed range limits.
- Maximum allowable voltage unbalance between phases is 2%.
- MCA/MFA
 $MCA = 1.25 \times FLA$
 $MFA = 1.1 \times MCA, MFA \leq 4 \times FLA$
 (If MFA is smaller than minimum standard value, Use minimum standard value in region for selecting circuit breaker.)
- Select wire size based on the MCA
- Instead of fuse, use Circuit Breaker.

9. Sound Levels

9.1 Sound Pressure Levels

Overall

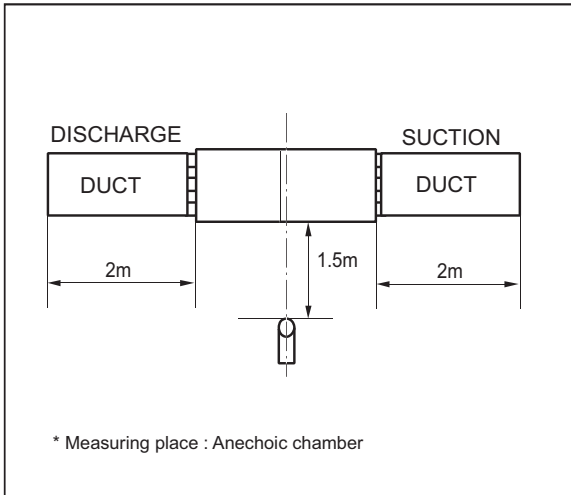

Note

1. Sound measured at some distance away from the center of the unit.
2. Data is valid at free field condition.
3. Reference acoustic pressure 0dB = 20μPa.
4. Data is valid at nominal operation condition.
Refer to the Model Specifications for nominal conditions(Power source and Ambient temperature, etc)
5. Sound levels can be increased in accordance with installation and operating conditions. (Static pressure mode, used air guide, Room target temperature setting, etc)
6. Sound level will vary depending on a range of factors such as the construction(acoustic absorption coefficient) of particular room in which the equipment is installed.
7. Sound pressure level is measured on the rated condition in the anechoic rooms by ISO 3745 standard.
Therefore, these values can be increased owing to ambient conditions during operation.

Model	Sound Pressure Levels [dB(A)]		
	H	M	L
ARNU76GB8Z4	45	43	43
ARNU96GB8Z4	47	45	45

ARNU76GB8Z4

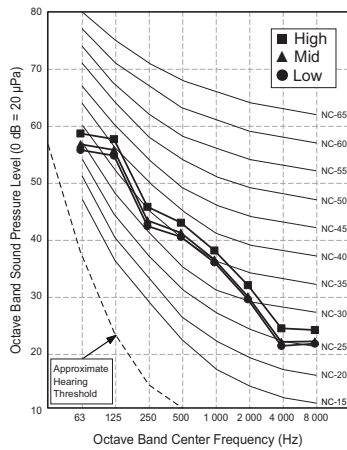

ARNU96GB8Z4

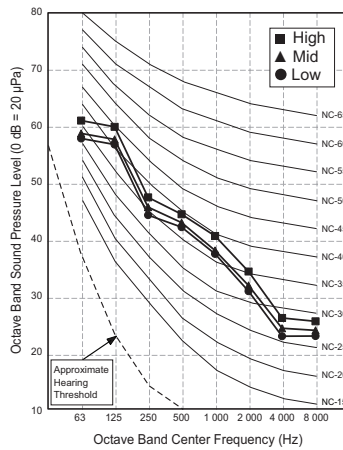

9. Sound Levels

9.2 Sound Power Levels

Note

- Data is valid at diffuse field condition
- Data is valid at nominal operating condition
- Sound level can be increased in static pressure mode or used air guide.
- Sound level will vary depending on a range of factors such as the construction (acoustic absorption coefficient) of particular room in which the equipment is installed.
- Reference acoustic intensity 0dB = 10E-6μW/m²
- Sound power level is measured on the rated condition in the semi-anechoic rooms by ISO 9614 standard. Therefore, these values can be increased owing to ambient conditions during operation.

9.2.1 Sound Power Levels (Inlet)

Model	Sound Power Levels [dB(A), Inlet(H-M-L)]			
	External Static Pressure [Pa]			
	69	127	177	216
ARNU76GB8Z4	53 - 48 - 48	58 - 55 - 55	61 - 58 - 58	63 - 62 - 62
ARNU96GB8Z4	58 - 53 - 53	61 - 58 - 58	63 - 61 - 61	64 - 63 - 63

■ Sound Power Level (69Pa)

ARNU76GB8Z4

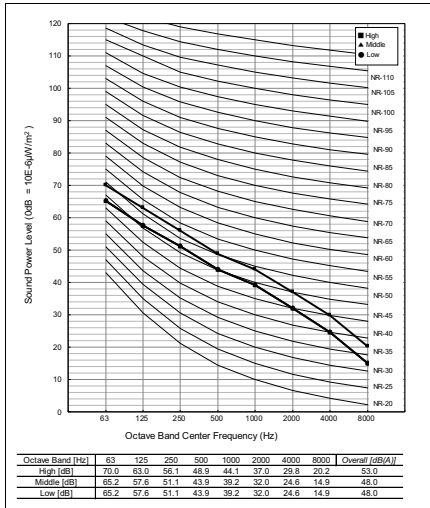

ARNU96GB8Z4

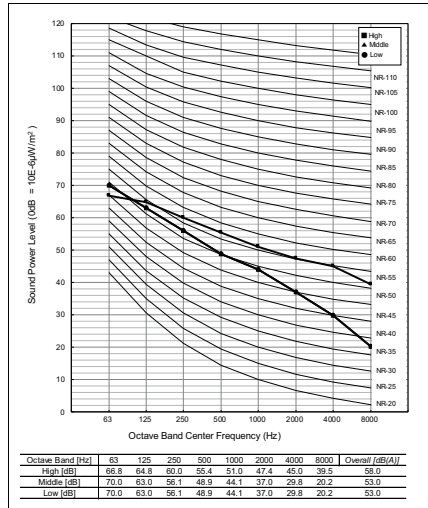

9. Sound Levels

■ Sound Power Level (127Pa)

ARNU76GB8Z4

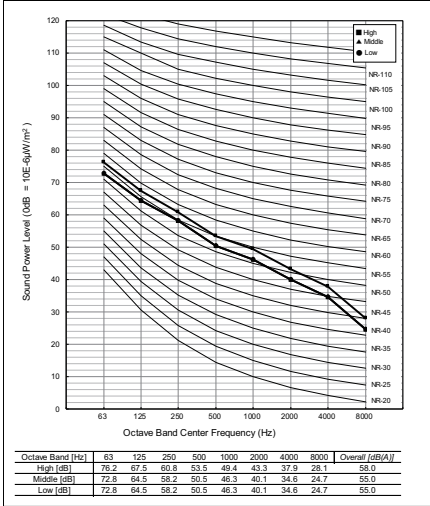

ARNU96GB8Z4

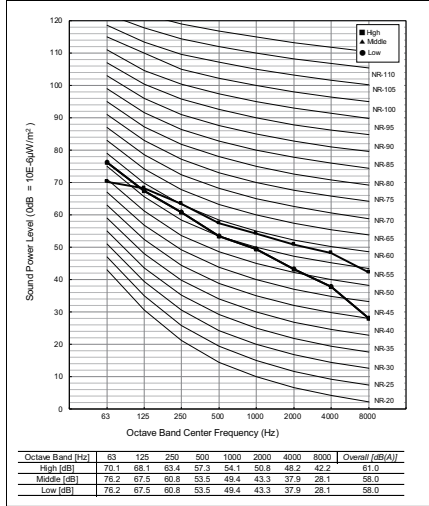

■ Sound Power Level (177Pa)

ARNU76GB8Z4

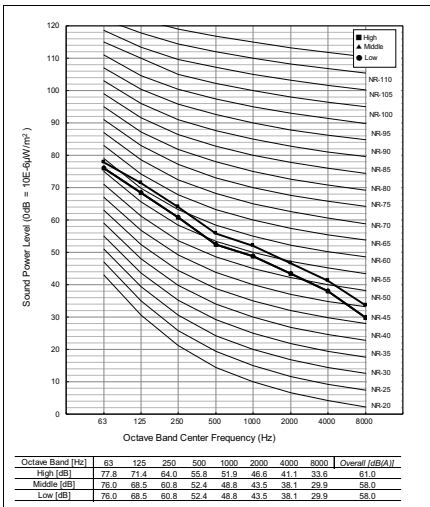

ARNU96GB8Z4

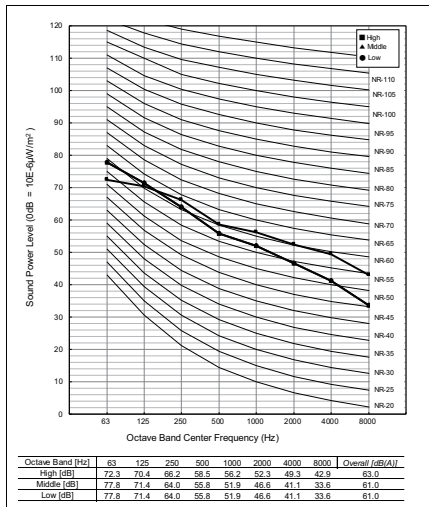

9. Sound Levels

■ Sound Power Level (216Pa)

ARNU76GB8Z4

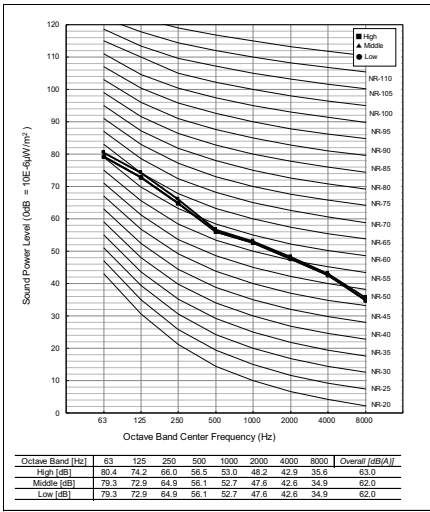

ARNU96GB8Z4

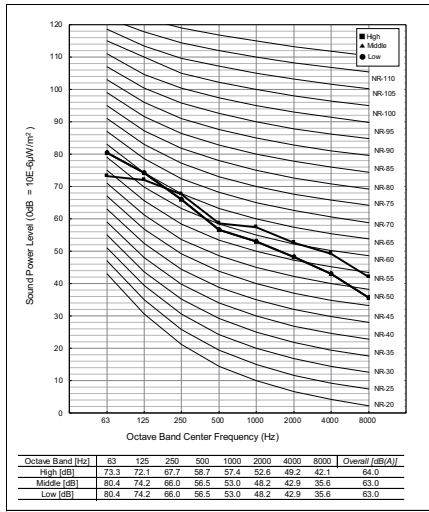

9. Sound Levels

9.2.2 Sound Power Levels (Body)

Model	Sound Power Levels [dB(A), Body(H-M-L)]			
	External Static Pressure [Pa]			
	69	127	177	216
ARNU76GB8Z4	46 - 42 - 42	51 - 49 - 49	54 - 52 - 52	56 - 54 - 54
ARNU96GB8Z4	50 - 46 - 46	55 - 51 - 51	57 - 54 - 54	58 - 56 - 56

■ Sound Power Level (69Pa)

ARNU76GB8Z4

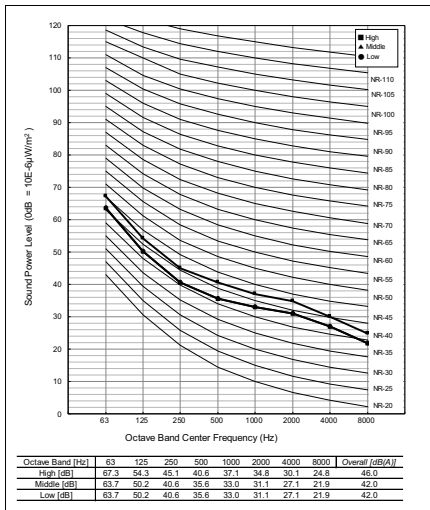

ARNU96GB8Z4

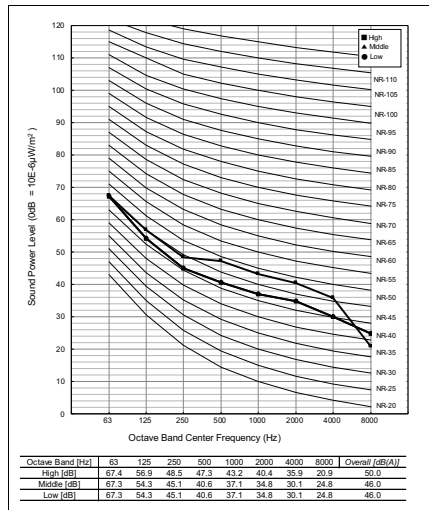

■ Sound Power Level (127Pa)

ARNU76GB8Z4

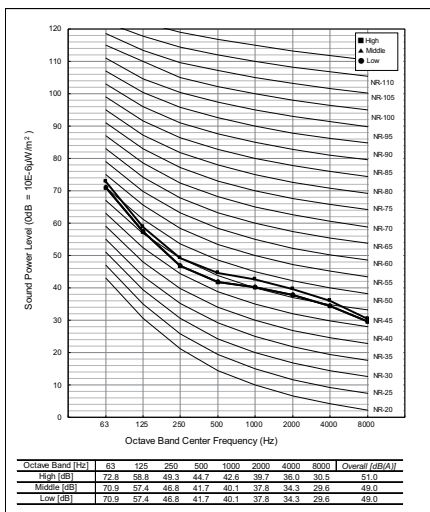

ARNU96GB8Z4

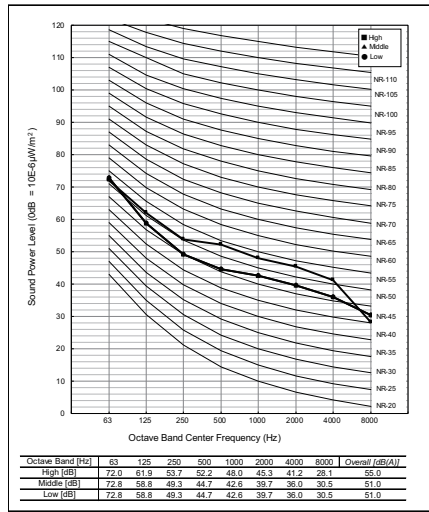

9. Sound Levels

■ Sound Power Level (177Pa)

ARNU76GB8Z4

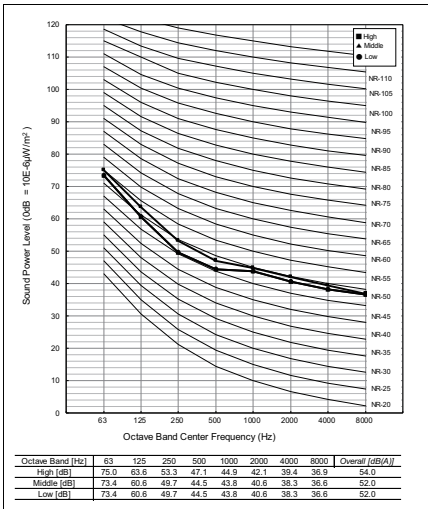

ARNU96GB8Z4

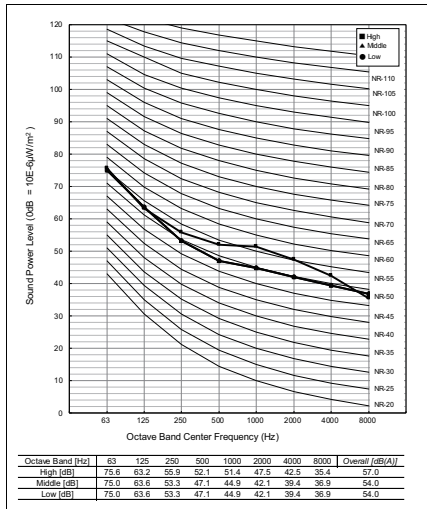

■ Sound Power Level (216Pa)

ARNU76GB8Z4

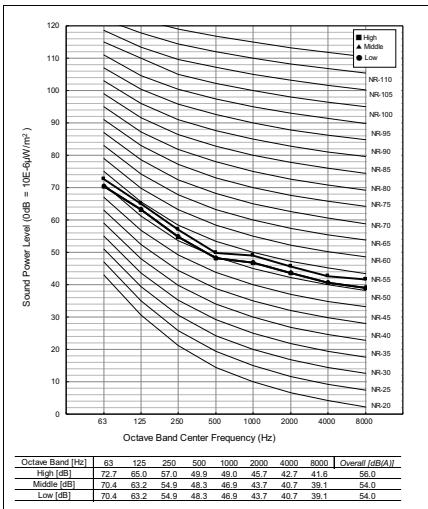

ARNU96GB8Z4

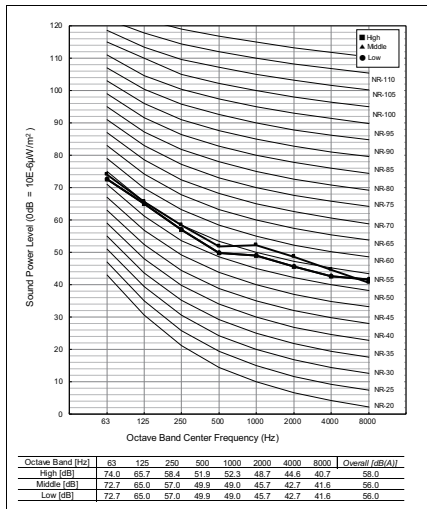

9. Sound Levels

9.2.3 Sound Power Levels (Outlet)

Model	Sound Power Levels [dB(A), Outlet(H-M-L)]			
	External Static Pressure [Pa]			
	69	127	177	216
ARNU76GB8Z4	61 - 55 - 55	66 - 62 - 62	71 - 69 - 69	72 - 71 - 71
ARNU96GB8Z4	66 - 61 - 61	71 - 66 - 66	73 - 71 - 71	74 - 72 - 72

■ Sound Power Level (69Pa)

ARNU76GB8Z4

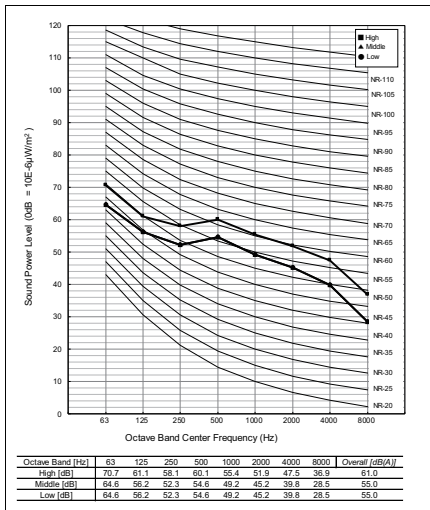

ARNU96GB8Z4

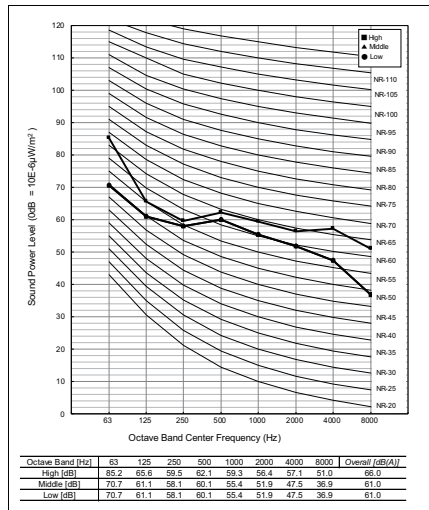

■ Sound Power Level (127Pa)

ARNU76GB8Z4

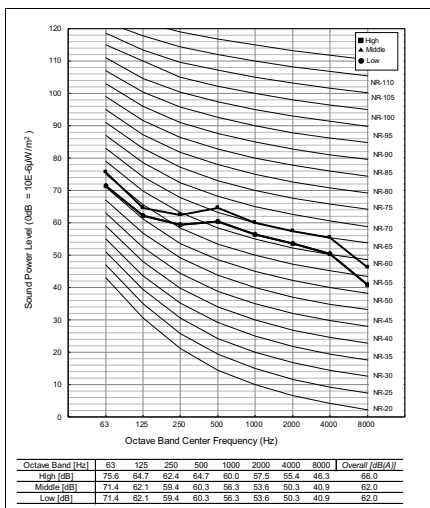

ARNU96GB8Z4

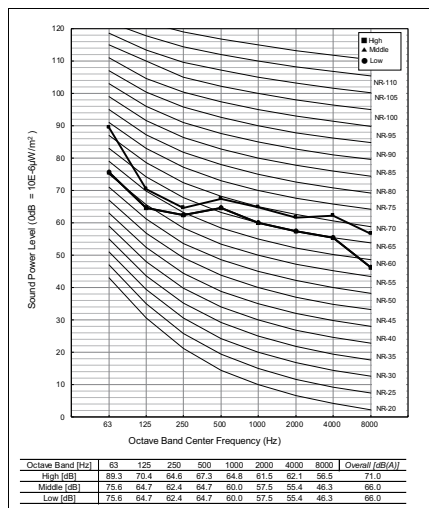

9. Sound Levels

■ Sound Power Level (177Pa)

ARNU76GB8Z4

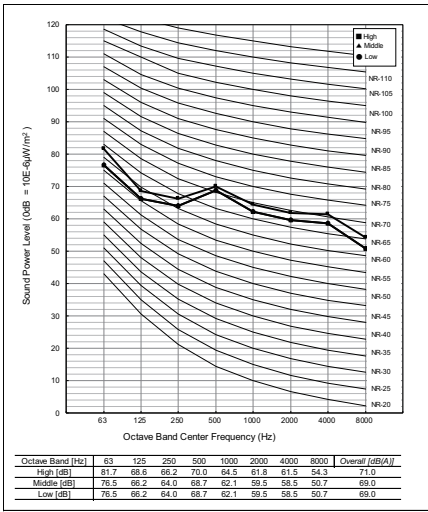

ARNU96GB8Z4

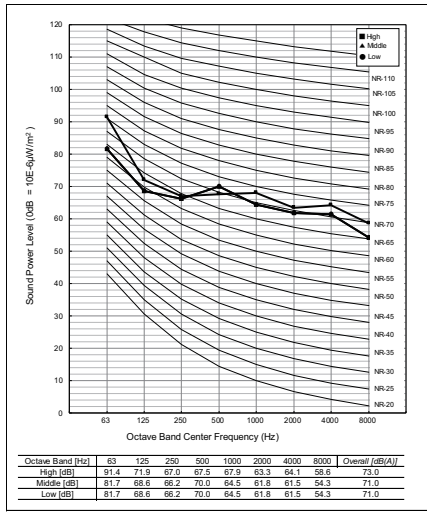

■ Sound Power Level (216Pa)

ARNU76GB8Z4

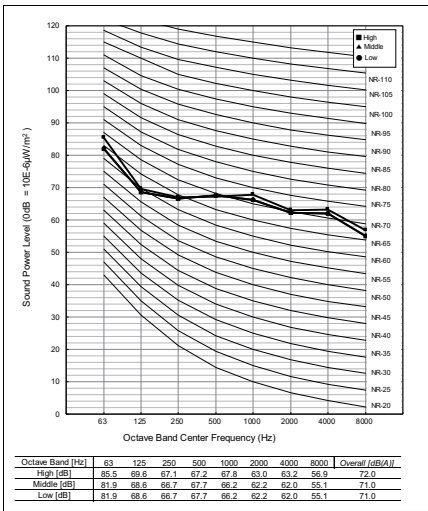

ARNU96GB8Z4

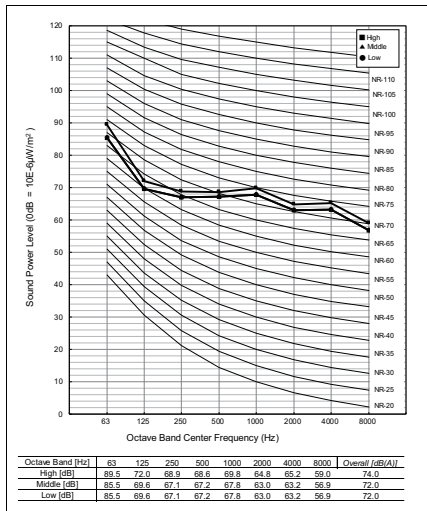

10. Operation Details

◆ Operation range

FAU will operate in the below range. Hot outdoor temperature (over 43°C) or cold outdoor temperature (under -5°C) will make customer feel uncomfortable because FAU outlet discharge temperature might be not enough controlled in that region.

* FAU : Fresh Air Intake Unit

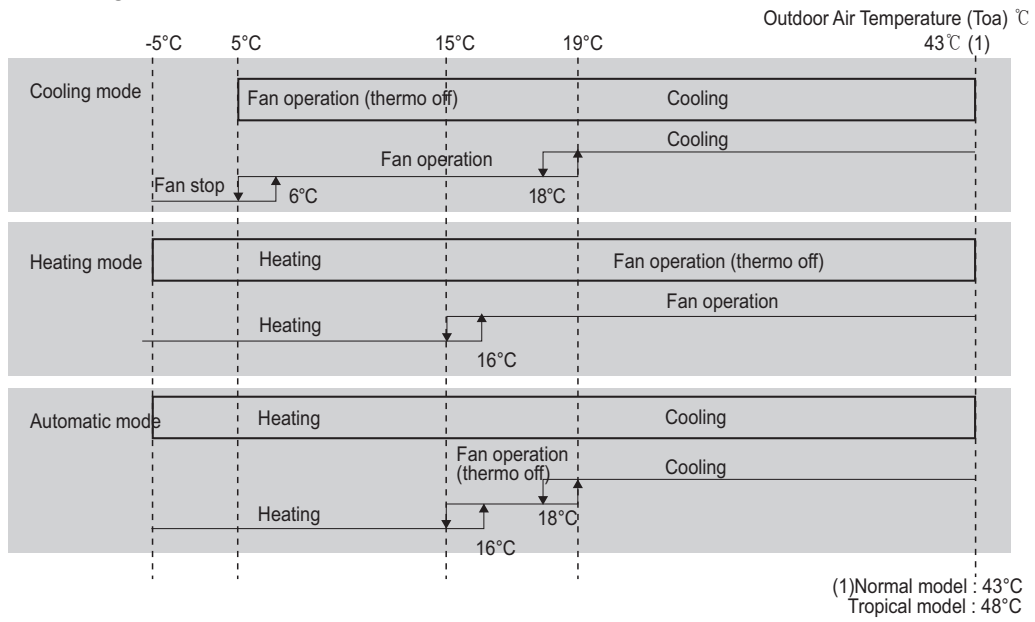

◆ Usage Limitations

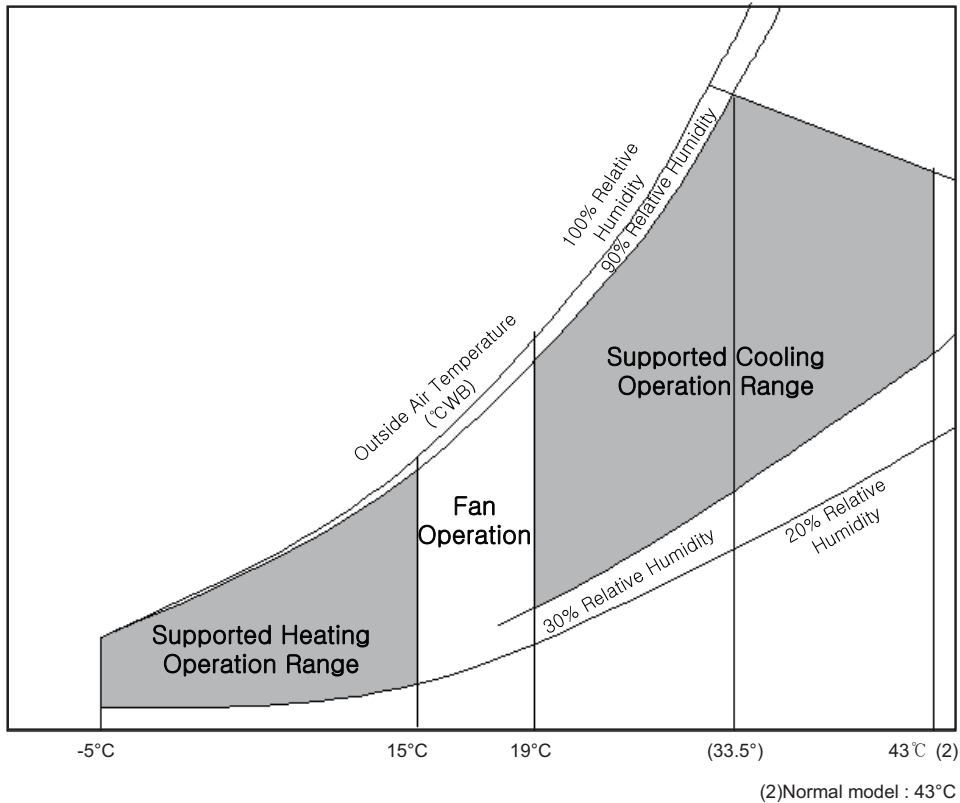

MULTI V™
Indoor Unit

Wall Mounted Unit (Standard)

- 1. List of functions**
- 2. Specifications**
- 3. Dimensions**
- 4. Piping Diagrams**
- 5. Wiring Diagrams**
- 6. Capacity Tables**
- 7. Air Velocity and Temperature Distribution**
- 8. Electric Characteristics**
- 9. Sound Levels**

1. List of functions

List of functions

* Model Name (N, C : Ionizer)

Category	Function	ARNU05GSJ*4, ARNU07GSJ*4, ARNU09GSJ*4, ARNU12GSJ*4, ARNU15GSJ*4, ARNU18GSK*4, ARNU24GSK*4
Air Flow	Air Supply Outlet	1
	Airflow Direction Control (left & right)	Manual
	Airflow Direction Control (up & down)	Auto
	Auto Swing (left & right)	X
	Auto Swing (up & down)	Auto
	Airflow Steps (fan/cool/heat)	4 / 5 / 5
	Fan Speed Auto*	Advanced
	Power Cool/Heat	O / O
	Swirl Wind*	-
	Refresh Mode**	X
	Smart Mode**	X
	Indirect Wind*	O
	Direct Wind*	O
Dry Operation	O	
Air Purification	Air Purify	X
	Ionizer	O
	UV-C	X
	Pre-Filter	O
Reliability	Hot Start	O
	Self Diagnosis	O
Convenience	Auto Mode	O
	Auto Dry Operation	O
	Auto Restart	O
	Child Lock*	O
	Forced Operation	O
	Group Control*	O
	Sleep Timer	O
	Turn On/Off Reservation	O
	Schedule*	O
Two Thermistor Control*	O	
Installation	External On/Off	O
	Drain Pump	X
	E.S.P. Control*	X
Special Functions	High Ceiling Operation*	-
	Wi-Fi	O
	Auto Elevation Grille	X
	Human Detection Function**	X
Floor Detection Function**	X	

Note

1. O : Applied, X : Not Applied, - : Unconfirmed or irrelevant

Embedded : A kit is provided by default for using this function when the product is manufactured.

Accessory : Ordered and purchased separately the accessory package referring to the model name provided and install at field. Accessory line-ups varies by region, so check your local catalogue or local sales material.

2. Some functions can be limited by remote controller.

3. In case of cassette type indoor units, Air Purification Kit and Auto Elevation Grille functions are not applicable at the same time.

4. 'Auto Mode' varies depending on the outdoor unit type.

- Auto Change Over(Heat Recovery Outdoor Unit)

- Auto Mode Select(Heat Pump Outdoor Unit)

- Auto Intensity Control(Cooling Only Outdoor Unit)

5. * : These functions need to connect the wired remote controller.

6. ** : This functions need to connect to the Standard III wired remote controller.

1. List of functions

List of functions

Category	Function	ARNU30GSVA4, ARNU36GSVA4
Air Flow	Air Supply Outlet	1
	Airflow Direction Control (left & right)	Manual
	Airflow Direction Control (up & down)	Auto
	Auto Swing (left & right)	X
	Auto Swing (up & down)	Auto
	Airflow Steps (fan/cool/heat)	4 / 5 / 5
	Fan Speed Auto*	Advanced
	Power Cool/Heat	O / O
	Swirl Wind*	-
	Refresh Mode**	X
	Smart Mode**	X
	Indirect Wind*	O
	Direct wind*	O
	Dry Operation	O
Air Purification	Air Purify	X
	Ionizer	X
	UV-C	X
	Pre-Filter	O
Reliability	Hot Start	O
	Self Diagnosis	O
Convenience	Auto Mode	O
	Auto Dry Operation	O
	Auto Restart	O
	Child Lock*	O
	Forced Operation	O
	Group Control*	O
	Sleep Timer	O
	Turn On/Off Reservation	O
	Schedule*	O
	Two Thermistor Control*	O
	External On/Off	O
Installation	Drain Pump	X
	E.S.P. Control*	X
	High Ceiling Operation*	-
Special Functions	Wi-Fi	Accessory
	Auto Elevation Grille	X
	Human Detection Function**	X
	Floor Detection Function**	X

Note

- O : Applied, X : Not Applied, - : Unconfirmed or irrelevant
Embedded : A kit is provided by default for using this function when the product is manufactured.
Accessory : Ordered and purchased separately the accessory package referring to the model name provided and install at field. Accessory line-ups varies by region, so check your local catalogue or local sales material.
- Some functions can be limited by remote controller.
- In case of cassette type indoor units, Air Purification Kit and Auto Elevation Grille functions are not applicable at the same time.
- 'Auto Mode' varies depending on the outdoor unit type.
 - Auto Change Over(Heat Recovery Outdoor Unit)
 - Auto Mode Select(Heat Pump Outdoor Unit)
 - Auto Intensity Control(Cooling Only Outdoor Unit)
- * : These functions need to connect the wired remote controller.
- ** : These functions need to connect to the Standard III wired remote controller.

1. List of functions

■ Accessory Compatibility List

Category	Accessory Name	Model Name	Description	ARNU-GSJ(K)N4 ARNU-GSJ(K)C4
Remote Controller	Wired - Premium	PREMTA000	-	○
		PREMTA000A	-	○
		PREMTA000B	-	○
	Wired - RS3 (Standard III)	PREMTB100/PREMTB101	White	○
		PREMTBB10/PREMTBB11	Black	○
	Wired - RS2 (Standard II)	PREMTB001	White	○
		PREMTBB01	Black	○
	Wired - Simple	PQRCVCL0QW	White	○
		PQRCVCL0Q	Black	○
	Wired - Simple for Hotel	PQRCHCA0QW	White	○
		PQRCHCA0Q	Black	○
Wireless	PQWRCQ0FDB	For Cooling only	○	
	PQWRHQ0FDB	For Heat pump	○	
	PWLSSB21C	For Cooling only	○	
	PWLSSB21H	For Heat pump	○	
Dry Contact	Simple	PDRYCB000	1 input port, AC 220 - 240V	○
		PDRYCB100	1 input port, AC 24V	○
	Communication	PDRYCB400	2 input port	○
		PDRYCB300	8 input port, For 3rd party Thermostat	○
		PDRYCB320	8 input port, For 3rd Party Thermostat (Analog Input)	○
PDRYCB500	For 3rd Party Controller (Modbus RTU)	○		
Integration Device	Remote Temperature sensor	PQRSTA0	-	X
	Group Control wire	PZCWRCG3	Cable Assembly for group control (Y-type cable : 0.25m, cable : 9.6m)	○
ETC	Extension wire	PZCWRC1	Extension wire for IDU-wired remote controller (9.6m)	○
	2-Remo Control Wire	PZCWRC2	-	○
	Wi-Fi Modem	PWFMDD200	-	Embedded
	Wi-Fi Extension cable	PWYREW000	USB Extension cable : 10 m	○
	Independent Power Module	PRIP0	-	○
	Multi-tenant Power Module	PINPMB001	-	○
	Refrigerant Leakage Detector	PRLDNVS0	For R410A only	○
	Human Detection Sensor	PTVSMA0	For Cassette 4-way	X
		PTVSAA0	For Cassette Dual Vane 4-way	X
	Floor Detection Sensor	PTFSMA0	-	X
	Auto Elevation Grille	PTEGM0	For TP/TN/TM	X
	Air Purification Kit	PTAHTP0	For Cassette 1-way	X
		PTAHMP0	For Cassette 4-way	X
		PTAHYP0	For Cassette Round	X
	EEV Kit	PRGK024A0	For Multi V Indoor Unit	○
	Auxiliary Heater Relay Kit	PRARS1	For Wall Mounted and Art Cool Indoor Units	○
		PRARH1	For Cassette and Duct Indoor Units	X
	Ventilation Kit	PTVK430	For TR/TQ/TP/TN/TM	X
		PTVK410 + PTVK420	For TP/TN/TM	X
	Cassette Cover	PTDCQ	For TR/TQ	X
PTDCM		For TP/TN/TM	X	
PTDCA		For TM-A/TP-B	X	

Note

1. ○: Possible, X: Impossible, -: Not applicable, Embedded : Included with product.
2. If there is a difference in development time between the product and the remote controller, some functions cannot be operated.
3. If using Wi-Fi controller, Some advanced functions controlled by remote controller cannot be operated.
4. If you need more detail, please refer to the **BECON** PDB or the manual of product. (<http://partner.lge.com/global> : Home> Doc.Library> Product > Control(BECON))

1. List of functions

■ Accessory Compatibility List

Category	Accessory Name	Model Name	Description	ARNU-GSVA4
Remote Controller	Wired - Premium	PREMTA000	-	O
		PREMTA000A	-	O
		PREMTA000B	-	O
	Wired - RS3 (Standard III)	PREMTB100/PREMTB101	White	O
		PREMTBB10/PREMTBB11	Black	O
	Wired - RS2 (Standard II)	PREMTB001	White	O
		PREMTBB01	Black	O
	Wired - Simple	PQRCVCL0QW	White	O
		PQRCVCL0Q	Black	O
	Wired - Simple for Hotel	PQRCHCA0QW	White	O
		PQRCHCA0Q	Black	O
	Wireless	PQWRCQ0FDB	For Cooling only	O
		PQWRHQ0FDB	For Heat pump	O
PWLSSB21C		For Cooling only	O	
PWLSSB21H		For Heat pump	O	
Dry Contact	Simple	PDRYCB000	1 input port, AC 220 - 240V	O
		PDRYCB100	1 input port, AC 24V	O
	Communication	PDRYCB400	2 input port	O
		PDRYCB300	8 input port, For 3rd party Thermostat	O
		PDRYCB320	8 input port, For 3rd Party Thermostat (Analog Input)	O
		PDRYCB500	For 3rd Party Controller (Modbus RTU)	O
Integration Device	Remote Temperature sensor	PQRSTA0	-	X
	Group Control wire	PZCWRCG3	Cable Assembly for group control (Y-type cable : 0.25m, cable : 9.6m)	O
ETC	Extension wire	PZCWRC1	Extension wire for IDU-wired remote controller (9.6m)	O
	2-Remo Control Wire	PZCWRC2	-	O
	Wi-Fi Modem	PWFMD200	-	O
	Wi-Fi Extension cable	PWYREW000	USB Extension cable : 10 m	O
	Independent Power Module	PRIP0	-	O
	Multi-tenant Power Module	PINPMB001	-	O
	Refrigerant Leakage Detector	PRLDNVS0	For R410A only	O
	Human Detection Sensor	PTVSMA0	For Cassette 4-way	X
		PTVSA0	For Cassette Dual Vane 4-way	X
	Floor Detection Sensor	PTFSMA0	-	X
	Auto Elevation Grille	PTEGM0	For TP/TN/TM	X
	Air Purification Kit	PTAHTP0	For Cassette 1-way	X
		PTAHMP0	For Cassette 4-way	X
		PTAHYP0	For Cassette Round	X
	EEV Kit	PRGK024A0	For Multi V Indoor Unit	X
	Auxiliary Heater Relay Kit	PRARS1	For Wall Mounted and Art Cool Indoor Units	O
		PRARH1	For Cassette and Duct Indoor Units	X
	Ventilation Kit	PTVK430	For TR/TQ/TP/TN/TM	X
		PTVK410 + PTVK420	For TP/TN/TM	X
	Cassette Cover	PTDCQ	For TR/TQ	X
		PTDCM	For TP/TN/TM	X
PTDCA		For TM-A/TP-B	X	

Note

1. O: Possible, X: Impossible, - : Not applicable, Embedded : Included with product.
2. If there is a difference in development time between the product and the remote controller, some functions cannot be operated.
3. If using Wi-Fi controller, Some advanced functions controlled by remote controller cannot be operated.
4. If you need more detail, please refer to the **BECON** PDB or the manual of product. (<http://partner.lge.com/global> : Home> Doc.Library> Product > Control(BECON))

2. Specifications

* Model Name (N, C : Ionizer)

Type			Wall Mounted Unit		
Model		Unit	ARNU05GSJ*4	ARNU07GSJ*4	
Cooling Capacity		kW	1.6	2.2	
		kcal/h	1,400	1,900	
		Btu/h	5,500	7,500	
Heating Capacity		kW	1.8	2.5	
		kcal/h	1,500	2,200	
		Btu/h	6,100	8,500	
Power Input (H / M / L)		W	11 / 10 / 9	12 / 11 / 9	
Dimensions (W×H×D)	Body	mm	818 × 316 × 189	818 × 316 × 189	
		inch	32-7/32 x 12-7/16 x 7-7/16	32-7/32 x 12-7/16 x 7-7/16	
	Shipping	mm	892 × 381 × 249	892 × 381 × 249	
		inch	35-1/8 × 15 × 9-13/16	35-1/8 × 15 × 9-13/16	
Coil	Rows × Columns × FPI		2 × 15 × 19	2 × 15 × 19	
	Face Area		m ²	0.19	
Fan	Type		Cross Flow Fan	Cross Flow Fan	
	Motor Output × Number		W	30 × 1	
	Air Flow Rate(H / M / L)	m ³ /min		6.8 / 6.5 / 5.9	7.2 / 6.8 / 5.9
		ft ³ /min		240 / 230 / 208	254 / 240 / 208
	Drive		Direct	Direct	
	Motor type		BLDC	BLDC	
Temperature Control			Microprocessor, Thermostat for cooling and heating		
Sound Absorbing Thermal Insulation Material			Foamed polystyrene	Foamed polystyrene	
Air Filter			Resin Net(washable)	Resin Net(washable)	
Safety Device			Fuse	Fuse	
Pipe Connections	Liquid Side	mm (inch)	Ø 6.35 (1/4)	Ø 6.35 (1/4)	
	Gas Side	mm (inch)	Ø 12.7 (1/2)	Ø 12.7 (1/2)	
	Drain Pipe(ID)	mm (inch)	16 (5/8)	16 (5/8)	
Weight	Body	kg (lbs)	8.4 (18.5)	8.4 (18.5)	
	Shipping	kg (lbs)	11.3 (24.9)	11.3 (24.9)	
Sound Pressure Levels (H / M / L)		dB(A)	30 / 29 / 28	32 / 30 / 28	
Sound Power Levels (H / M / L)		dB(A)	45 / 43 / 42	46 / 45 / 42	
Power Supply		Ø, V, Hz	1, 220 - 230 - 240, 50/60	1, 220 - 230 - 240, 50/60	
Running Current by voltage	Rated	A	0.10 - 0.09 - 0.09	0.10 - 0.10 - 0.10	
Maximum Running Current		A	0.25	0.25	
Refrigerant	Type		-	R410A / R32	
	Additional Charging Amount (CF Value of IDU)		kg(each)	0.24 / 0.20	
	Control		-	EEV	
Transmission cable		mm ²	1.0 ~ 1.5 × 2C	1.0 ~ 1.5 × 2C	
Color			White	White	

Note

- Due to our policy of innovation some specifications may be changed without notification.
- Wiring cable size must comply with the applicable local and national code. And "Electric characteristics" chapter should be considered for electrical work and design. Especially the power cable and circuit breaker should be selected in accordance with that.
- Sound pressure level is measured on the rated condition in the anechoic rooms by ISO 3745 standard.
Sound power level is measured on the rated condition in the semi-anechoic rooms by ISO 9614 standard.
Therefore, these values can be increased owing to ambient conditions during operation.
- Capacities are net capacities and based on the following conditions. Refer to the Outdoor Unit Specifications for calculating the real capacity.
 - Cooling : Indoor Ambient Temp. 27°CDB / 19°CWB, Outdoor Ambient Temp. 35°CDB / 24°CWB
 - Heating : Indoor Ambient Temp. 20°CDB / 15°CWB, Outdoor Ambient Temp. 7°CDB / 6°CWB
 - Interconnected Pipe is standard length and difference of Elevation (Outdoor ~ Indoor Unit) is 0m.
- Refrigerant information (type, additional charging amount, etc.) must be applied by refrigerant type of the combined outdoor unit.
Adapt after checking the specifications of outdoor unit.
- ARNU-N4 models may look different depending on the time of production.

2. Specifications

* Model Name (N, C : Ionizer)

Type			Wall Mounted Unit	
Model		Unit	ARNU09GSJ*4	ARNU12GSJ*4
Cooling Capacity		kW	2.8	3.6
		kcal/h	2,400	3,100
		Btu/h	9,600	12,300
Heating Capacity		kW	3.2	4.0
		kcal/h	2,800	3,400
		Btu/h	10,900	13,600
Power Input (H / M / L)		W	13 / 12 / 9	15 / 13 / 11
Dimensions (W×H×D)	Body	mm	818 × 316 × 189	818 × 316 × 189
		inch	32-7/32 x 12-7/16 x 7-7/16	32-7/32 x 12-7/16 x 7-7/16
	Shipping	mm	892 × 381 × 249	892 × 381 × 249
		inch	35-1/8 × 15 × 9-13/16	35-1/8 × 15 × 9-13/16
Coil	Rows × Columns × FPI		2 × 15 × 19	2 × 15 × 19
	Face Area		m ²	0.19
Fan	Type		Cross Flow Fan	Cross Flow Fan
	Motor Output × Number		W	30 × 1
	Air Flow Rate(H / M / L)	m ³ /min	7.8 / 7.2 / 5.9	8.5 / 7.8 / 6.8
		ft ³ /min	275 / 254 / 208	300 / 254 / 240
	Drive		Direct	Direct
Motor type		BLDC	BLDC	
Temperature Control			Microprocessor, Thermostat for cooling and heating	
Sound Absorbing Thermal Insulation Material			Foamed polystyrene	Foamed polystyrene
Air Filter			Resin Net(washable)	Resin Net(washable)
Safety Device			Fuse	Fuse
Pipe Connections	Liquid Side	mm (inch)	Ø 6.35 (1/4)	Ø 6.35 (1/4)
	Gas Side	mm (inch)	Ø 12.7 (1/2)	Ø 12.7 (1/2)
	Drain Pipe(ID)	mm (inch)	16 (5/8)	16 (5/8)
Weight	Body	kg (lbs)	8.4 (18.5)	8.4 (18.5)
	Shipping	kg (lbs)	11.3 (24.9)	11.3 (24.9)
Sound Pressure Levels (H / M / L)		dB(A)	34 / 32 / 28	37 / 34 / 30
Sound Power Levels (H / M / L)		dB(A)	48 / 46 / 42	51 / 48 / 45
Power Supply		Ø, V, Hz	1, 220 - 230 - 240, 50/60	1, 220 - 230 - 240, 50/60
Running Current by voltage	Rated	A	0.11 - 0.11 - 0.10	0.13 - 0.13 - 0.12
Maximum Running Current		A	0.25	0.25
Refrigerant	Type		-	R410A / R32
	Additional Charging Amount (CF Value of IDU)		kg(each)	0.24 / 0.20
	Control		-	EEV
Transmission cable		mm ²	1.0 ~ 1.5 × 2C	1.0 ~ 1.5 × 2C
Color			White	White

Note

- Due to our policy of innovation some specifications may be changed without notification.
- Wiring cable size must comply with the applicable local and national code. And "Electric characteristics" chapter should be considered for electrical work and design. Especially the power cable and circuit breaker should be selected in accordance with that.
- Sound pressure level is measured on the rated condition in the anechoic rooms by ISO 3745 standard.
Sound power level is measured on the rated condition in the semi-anechoic rooms by ISO 9614 standard.
Therefore, these values can be increased owing to ambient conditions during operation.
- Capacities are net capacities and based on the following conditions. Refer to the Outdoor Unit Specifications for calculating the real capacity.
 - Cooling : Indoor Ambient Temp. 27°CDB / 19°CWB, Outdoor Ambient Temp. 35°CDB / 24°CWB
 - Heating : Indoor Ambient Temp. 20°CDB / 15°CWB, Outdoor Ambient Temp. 7°CDB / 6°CWB
 - Interconnected Pipe is standard length and difference of Elevation (Outdoor ~ Indoor Unit) is 0m.
- Refrigerant information (type, additional charging amount, etc.) must be applied by refrigerant type of the combined outdoor unit.
Adapt after checking the specifications of outdoor unit.
- ARNU-N4 models may look different depending on the time of production.

2. Specifications

* Model Name (N, C : Ionizer)

Type		Wall Mounted Unit	
Model	Unit	ARNU15GSJ*4	
Cooling Capacity	kW	4.5	
	kcal/h	3,900	
	Btu/h	15,400	
Heating Capacity	kW	5.0	
	kcal/h	4,300	
	Btu/h	17,100	
Power Input (H / M / L)		W	23 / 18 / 11
Dimensions (W×H×D)	Body	mm	818 × 316 × 189
		inch	32-7/32 x 12-7/16 x 7-7/16
	Shipping	mm	892 × 381 × 249
		inch	35-1/8 × 15 × 9-13/16
Coil	Rows × Columns × FPI		2 × 15 × 19
	Face Area	m ²	0.19
Fan	Type		Cross Flow Fan
	Motor Output × Number	W	30 × 1
	Air Flow Rate(H / M / L)	m ³ /min	10.5 / 9.5 / 6.8
		ft ³ /min	371 / 336 / 240
	Drive	Direct	
Motor type	BLDC		
Temperature Control			Microprocessor, Thermostat for cooling and heating
Sound Absorbing Thermal Insulation Material			Foamed polystyrene
Air Filter			Resin Net(washable)
Safety Device			Fuse
Pipe Connections	Liquid Side	mm (inch)	Ø 6.35 (1/4)
	Gas Side	mm (inch)	Ø 12.7 (1/2)
	Drain Pipe(ID)	mm (inch)	16 (5/8)
Weight	Body	kg (lbs)	8.4 (18.5)
	Shipping	kg (lbs)	11.3 (24.9)
Sound Pressure Levels (H / M / L)		dB(A)	42 / 39 / 32
Sound Power Levels (H / M / L)		dB(A)	55 / 52 / 45
Power Supply		Ø, V, Hz	1, 220 - 230 - 240, 50/60
Running Current by voltage	Rated	A	0.20 - 0.19 - 0.18
Maximum Running Current		A	0.25
Refrigerant	Type		R410A / R32
	Additional Charging Amount (CF Value of IDU)	kg(each)	0.24 / 0.20
	Control	-	EEV
Transmission cable		mm ²	1.0 ~ 1.5 × 2C
Color			White

Note

- Due to our policy of innovation some specifications may be changed without notification.
- Wiring cable size must comply with the applicable local and national code. And "Electric characteristics" chapter should be considered for electrical work and design. Especially the power cable and circuit breaker should be selected in accordance with that.
- Sound pressure level is measured on the rated condition in the anechoic rooms by ISO 3745 standard.
Sound power level is measured on the rated condition in the semi-anechoic rooms by ISO 9614 standard.
Therefore, these values can be increased owing to ambient conditions during operation.
- Capacities are net capacities and based on the following conditions. Refer to the Outdoor Unit Specifications for calculating the real capacity.
 - Cooling : Indoor Ambient Temp. 27°CDB / 19°CWB, Outdoor Ambient Temp. 35°CDB / 24°CWB
 - Heating : Indoor Ambient Temp. 20°CDB / 15°CWB, Outdoor Ambient Temp. 7°CDB / 6°CWB
 - Interconnected Pipe is standard length and difference of Elevation (Outdoor ~ Indoor Unit) is 0m.
- Refrigerant information (type, additional charging amount, etc.) must be applied by refrigerant type of the combined outdoor unit.
Adapt after checking the specifications of outdoor unit.
- ARNU-N4 models may look different depending on the time of production.

2. Specifications

* Model Name (N, C : Ionizer)

Type			Wall Mounted Unit	
Model		Unit	ARNU18GSK*4	ARNU24GSK*4
Cooling Capacity		kW	5.6	7.1
		kcal/h	4,800	6,100
		Btu/h	19,100	24,200
Heating Capacity		kW	6.3	7.5
		kcal/h	5,400	6,400
		Btu/h	21,500	25,600
Power Input (H / M / L)		W	32 / 26 / 16	39 / 26 / 16
Dimensions (W×H×D)	Body	mm	975 x 354 x 209	975 x 354 x 209
		inch	38-3/8 x 13-15/16 x 8-7/32	38-3/8 x 13-15/16 x 8-7/32
	Shipping	mm	1,063 × 420 × 274	1,063 × 420 × 274
		inch	41-27/32 × 16-17/32 × 10-25/32	41-27/32 × 16-17/32 × 10-25/32
Coil	Rows × Columns × FPI		2 × 16 × 20	2 × 16 × 20
	Face Area		m ²	0.25
Fan	Type		Cross Flow Fan	Cross Flow Fan
	Motor Output × Number		W	58 × 1
	Air Flow Rate(H / M / L)	m ³ /min	14.0 / 12.0 / 10.5	15.2 / 12.7 / 10.5
		ft ³ /min	494 / 424 / 371	537 / 449 / 371
	Drive		Direct	Direct
	Motor type		BLDC	BLDC
Temperature Control			Microprocessor, Thermostat for cooling and heating	
Sound Absorbing Thermal Insulation Material			Foamed polystyrene	Foamed polystyrene
Air Filter			Resin Net(washable)	Resin Net(washable)
Safety Device			Fuse	Fuse
Pipe Connections	Liquid Side	mm (inch)	Ø6.35 (1/4)	Ø9.52(3/8)
	Gas Side	mm (inch)	Ø12.7 (1/2)	Ø15.88(5/8)
	Drain Pipe(ID)	mm (inch)	16 (5/8)	16 (5/8)
Weight	Body	kg (lbs)	12.2 (26.9)	12.2 (26.9)
	Shipping	kg (lbs)	16.0 (35.3)	16.0 (35.3)
Sound Pressure Levels (H / M / L)		dB(A)	43 / 39 / 34	46 / 41 / 34
Sound Power Levels (H / M / L)		dB(A)	59 / 56 / 52	63 / 56 / 52
Power Supply		Ø, V, Hz	1, 220 - 230 - 240, 50/60	1, 220 - 230 - 240, 50/60
Running Current by voltage	Rated	A	0.33 - 0.31 - 0.30	0.40 - 0.38 - 0.37
Maximum Running Current		A	0.52	0.52
Refrigerant	Type		-	R410A / R32
	Additional Charging Amount (CF Value of IDU)		kg(each)	0.28 / 0.23
	Control		-	EEV
Transmission cable		mm ²	1.0 ~ 1.5 × 2C	1.0 ~ 1.5 × 2C
Color			White	White

Note

- Due to our policy of innovation some specifications may be changed without notification.
- Wiring cable size must comply with the applicable local and national code. And "Electric characteristics" chapter should be considered for electrical work and design. Especially the power cable and circuit breaker should be selected in accordance with that.
- Sound pressure level is measured on the rated condition in the anechoic rooms by ISO 3745 standard.
Sound power level is measured on the rated condition in the semi-anechoic rooms by ISO 9614 standard.
Therefore, these values can be increased owing to ambient conditions during operation.
- Capacities are net capacities and based on the following conditions. Refer to the Outdoor Unit Specifications for calculating the real capacity.
 - Cooling : Indoor Ambient Temp. 27°CDB / 19°CWB, Outdoor Ambient Temp. 35°CDB / 24°CWB
 - Heating : Indoor Ambient Temp. 20°CDB / 15°CWB, Outdoor Ambient Temp. 7°CDB / 6°CWB
 - Interconnected Pipe is standard length and difference of Elevation (Outdoor ~ Indoor Unit) is 0m.
- Refrigerant information (type, additional charging amount, etc.) must be applied by refrigerant type of the combined outdoor unit.
Adapt after checking the specifications of outdoor unit.
- ARNU-N4 models may look different depending on the time of production.

2. Specifications

Type			Wall Mounted Unit	
Model		Unit	ARNU30GSVA4	ARNU36GSVA4
Cooling Capacity		kW	8.8	10.4
		kcal/h	7,500	9,000
		Btu/h	30,000	35,500
Heating Capacity		kW	9.4	10.8
		kcal/h	8,100	9,300
		Btu/h	32,000	37,000
Power Input (H / M / L)		W	54 / 43 / 31	85 / 51 / 36
Dimensions(WxHxD)	Body	mm	1,190 × 346 × 265	1,190 × 346 × 265
		inch	46-27/32 × 13-5/8 × 10-7/16	46-27/32 × 13-5/8 × 10-7/16
Coil	Rows × Columns × FPI		2 × 18 × 19 + 1 × 6 × 19	2 × 18 × 19 + 1 × 6 × 19
	Face Area	m ²	0.34	0.34
Fan	Type		Cross Flow Fan	Cross Flow Fan
	Motor Output × Number	W	113 × 1	113 × 1
	Air Flow Rate(H / M / L)	m ³ /min	23.0 / 20.0 / 17.0	26.0 / 23.0 / 19.0
		ft ³ /min	812 / 706 / 600	918 / 812 / 671
	Drive		Direct	Direct
Motor type		BLDC	BLDC	
Temperature Control			Microprocessor, Thermostat for cooling and heating	
Sound Absorbing Thermal Insulation Material			Foamed polystyrene	
Air Filter			Resin Net(washable)	
Safety Device			Fuse	
Pipe Connections	Liquid Side	mm (inch)	Ø9.52 (3/8)	Ø9.52 (3/8)
	Gas Side	mm (inch)	Ø15.88 (5/8)	Ø15.88 (5/8)
	Drain Pipe(ID)	mm (inch)	16 (5/8)	16 (5/8)
Net Weight		kg (lbs)	16.6 (35.6)	16.6 (35.6)
Sound Pressure Levels (H / M / L)		dB(A)	49 / 44 / 42	52 / 47 / 43
Sound Power Levels (H / M / L)		dB(A)	60 / 60 / 56	63 / 60 / 58
Power Supply		Ø, V, Hz	1, 220 - 230 - 240, 50/60	1, 220 - 230 - 240, 50/60
Running Current by voltage	Rated	A	0.45 - 0.43 - 0.41	0.70 - 0.67 - 0.64
Maximum Running Current		A	0.51	0.81
Refrigerant	Type		R410A / R32	R410A / R32
	Additional Charging Amount (CF Value of IDU)	kg(each)	0.46 / 0.38	0.46 / 0.38
	Control		EEV	EEV
Transmission cable		mm ²	1.0 ~ 1.5 × 2C	1.0 ~ 1.5 × 2C
Color			White	White

Note

1. Due to our policy of innovation some specifications may be changed without notification.
2. Wiring cable size must comply with the applicable local and national code. And "Electric characteristics" chapter should be considered for electrical work and design. Especially the power cable and circuit breaker should be selected in accordance with that.
3. Sound pressure level is measured on the rated condition in the anechoic rooms by ISO 3745 standard.
Sound power level is measured on the rated condition in the semi-anechoic rooms by ISO 9614 standard.
Therefore, these values can be increased owing to ambient conditions during operation.
4. Capacities are net capacities and based on the following conditions. Refer to the Outdoor Unit Specifications for calculating the real capacity.
 - Cooling : Indoor Ambient Temp. 27°CDB / 19°CWB, Outdoor Ambient Temp. 35°CDB / 24°CWB
 - Heating : Indoor Ambient Temp. 20°CDB / 15°CWB, Outdoor Ambient Temp. 7°CDB / 6°CWB
 - Interconnected Pipe is standard length and difference of Elevation (Outdoor ~ Indoor Unit) is 0m.
5. Refrigerant information (type, additional charging amount, etc.) must be applied by refrigerant type of the combined outdoor unit.
Adapt after checking the specifications of outdoor unit.
6. ARNU-N4 models may look different depending on the time of production.

3. Dimensions

3.1 Dimensional Drawings

[SJ Chassis] ARNU05GSJ*4 / ARNU07GSJ*4 / ARNU09GSJ*4 / ARNU12GSJ*4
ARNU15GSJ*4

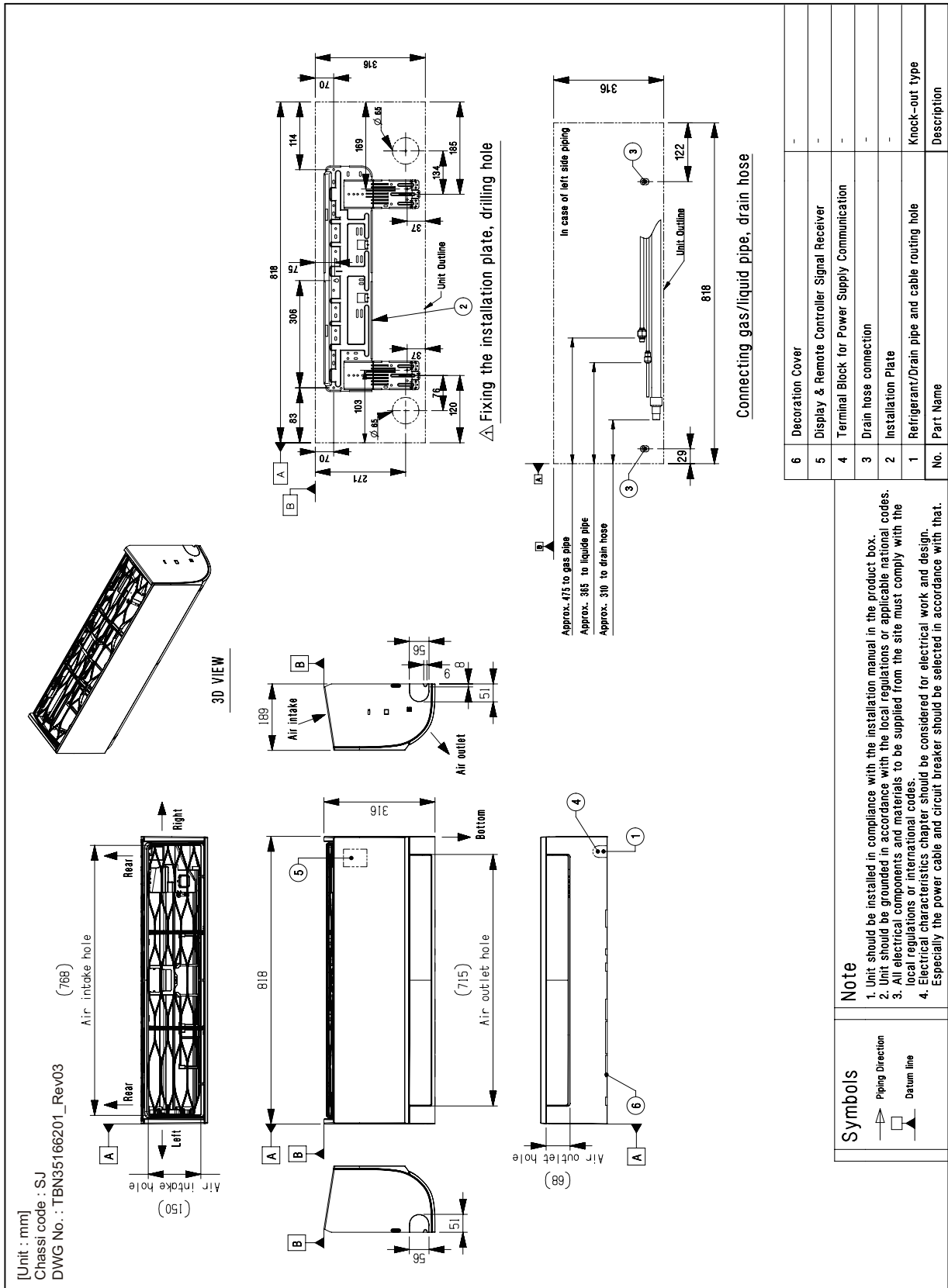

* ARNU-N4 models may look different depending on the time of production.

3. Dimensions

[SK Chassis] ARNU18GSK*4 / ARNU24GSK*4

[Unit: mm]
Chassis code : SK
DWG No. : TBN35166301_Rev02

Note

- Unit should be installed in compliance with the installation manual in the product box.
- Unit should be grounded in accordance with the local regulations or applicable national codes.
- All electrical components and materials to be supplied from the site must comply with the local regulations or international codes.
- Electric characteristics chapter should be considered for electrical work and design. Especially the power cable and circuit breaker should be selected in accordance with that.

Symbols

- Piping Direction
- Datum line

No.	Part Name	Description
6	Decoration Cover	-
5	Display & Remote Controller Signal Receiver	-
4	Terminal Block for Power Supply Communication	-
3	Drain hose connection	-
2	Installation Plate	-
1	Refrigerant/Drain pipe and cable routing hole	Knock-out type
No.	Part Name	Description

* ARNU-N4 models may look different depending on the time of production.

3. Dimensions

[SV Chassis] ARNU30GSVA4 / ARNU36GSVA4

Item No.	Part Name	Remark
1	Front Panel	
2	Display & Signal Receiver	
3	Air Suction Grille	
4	Installation Plate	

Note

- Unit should be installed in compliance with the installation manual in the product box.
- Unit shall be grounded in accordance with the local regulations or applicable national codes.
- The Unit is powered from the outdoor unit. Therefore power cable should be connected with the outdoor unit.

3. Dimensions

3.2 Installation Space

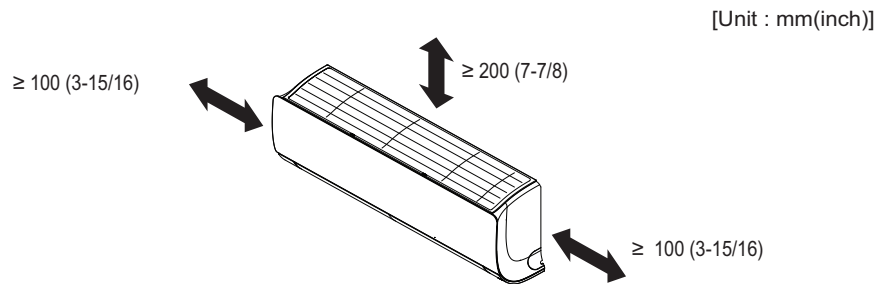

Note

- Places where products are installed should not be any obstacles to the air circulation or installation. Ensure the spaces from the wall, ceiling, or other obstacles.
- According to type of indoor unit, external appearance or installed structure could be different.
- According to product type, model line up, sales region..etc, applicability of each chassis could be different.

4. Piping Diagrams

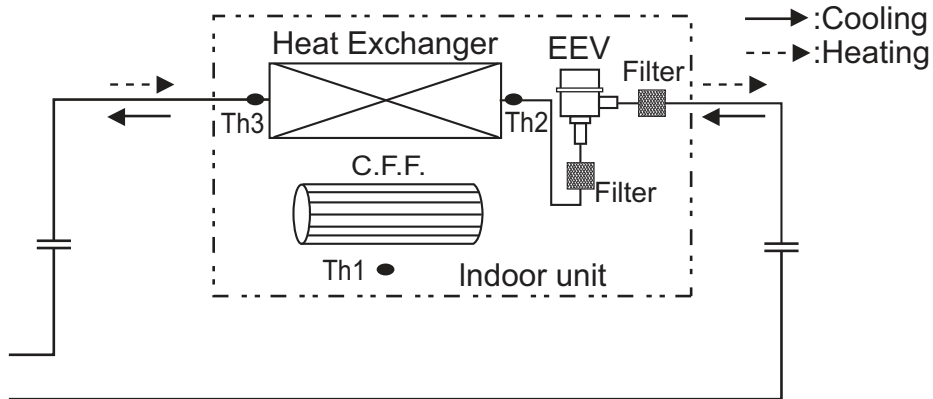

◆ Refrigerant pipe connection port diameter

Model	Gas [mm(inch)]	Liquid [mm(inch)]
ARNU05GSJ*4	Ø12.7(1/2)	Ø6.35(1/4)
ARNU07GSJ*4	Ø12.7(1/2)	Ø6.35(1/4)
ARNU09GSJ*4	Ø12.7(1/2)	Ø6.35(1/4)
ARNU12GSJ*4	Ø12.7(1/2)	Ø6.35(1/4)
ARNU15GSJ*4	Ø12.7(1/2)	Ø6.35(1/4)
ARNU18GSK*4	Ø12.7(1/2)	Ø6.35(1/4)
ARNU24GSK*4	Ø15.88(5/8)	Ø9.52(3/8)
ARNU30GSVA4	Ø15.88(5/8)	Ø9.52(3/8)
ARNU36GSVA4	Ø15.88(5/8)	Ø9.52(3/8)

LOC.	Description
Th1	Room thermistor
Th2	Pipe in thermistor
Th3	Pipe out thermistor

5. Wiring Diagrams

■ SJ/SK Chassis

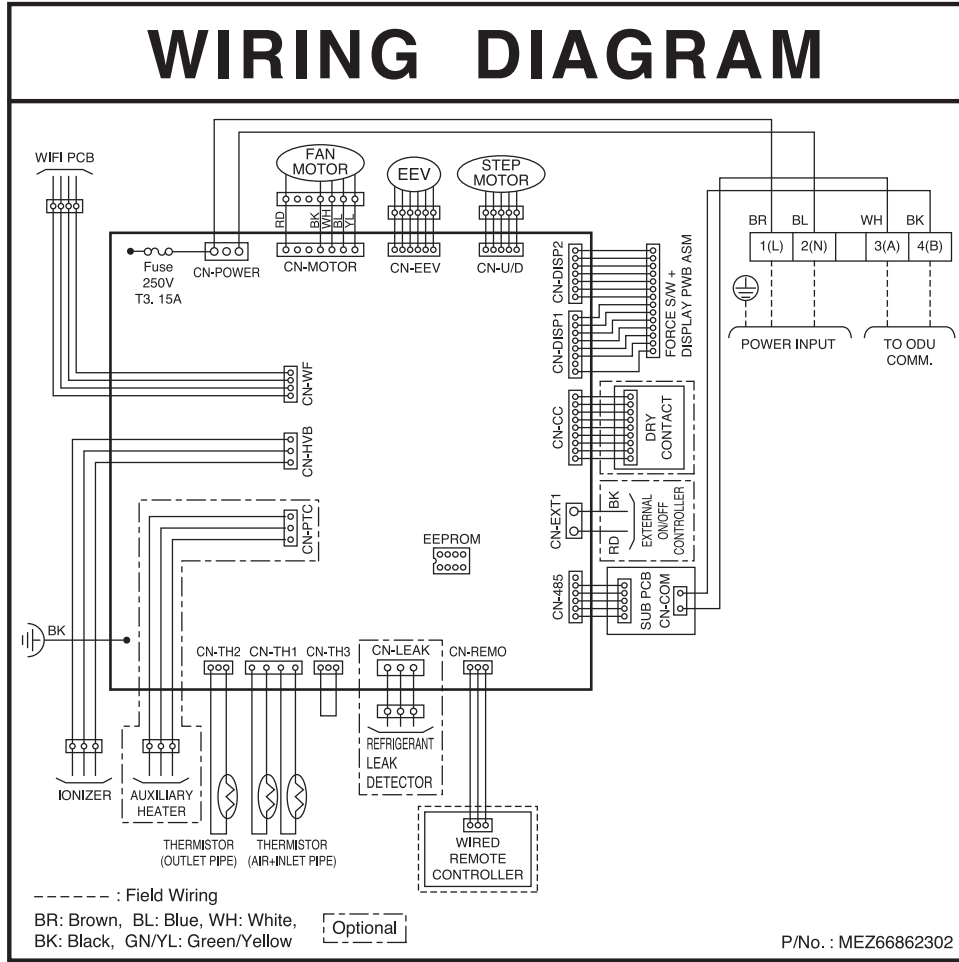

CONNECTOR NUMBER	LOCATION POINT	FUNCTION
CN-POWER	AC Power supply	AC Power line input for indoor
CN-MOTOR	Fan motor output	Motor output of BLDC
CN-485	Communication	Connection between indoor
CN-DISP1	Display	Display of indoor status
CN-DISP2	Display	Display of indoor status
CN-EEV	EEV Output	EEV Control output : connect to EEV directly or through IPM(Independent Power Module)
CN-LEAK	Refrigerant leak detector	Refrigerant leak detector line
CN-U/D	Step motor	Step motor output
CN-TH1	Room/inlet pipe sensor	Room and inlet pipe thermistor
CN-TH2	Outlet pipe sensor	Outlet pipe thermistor
CN-REMO	Remote controller	Remote control line
CN-CC	Dry contact	Dry contact line
CN-EXT1	External On/Off	External On/Off signal input
CN-PTC	Auxiliary heater	Auxiliary heater line
CN-WF	WIFI module	WIFI module connection line
CN-HVB	Ionizer module	Ionizer connection line

5. Wiring Diagrams

SV Chassis

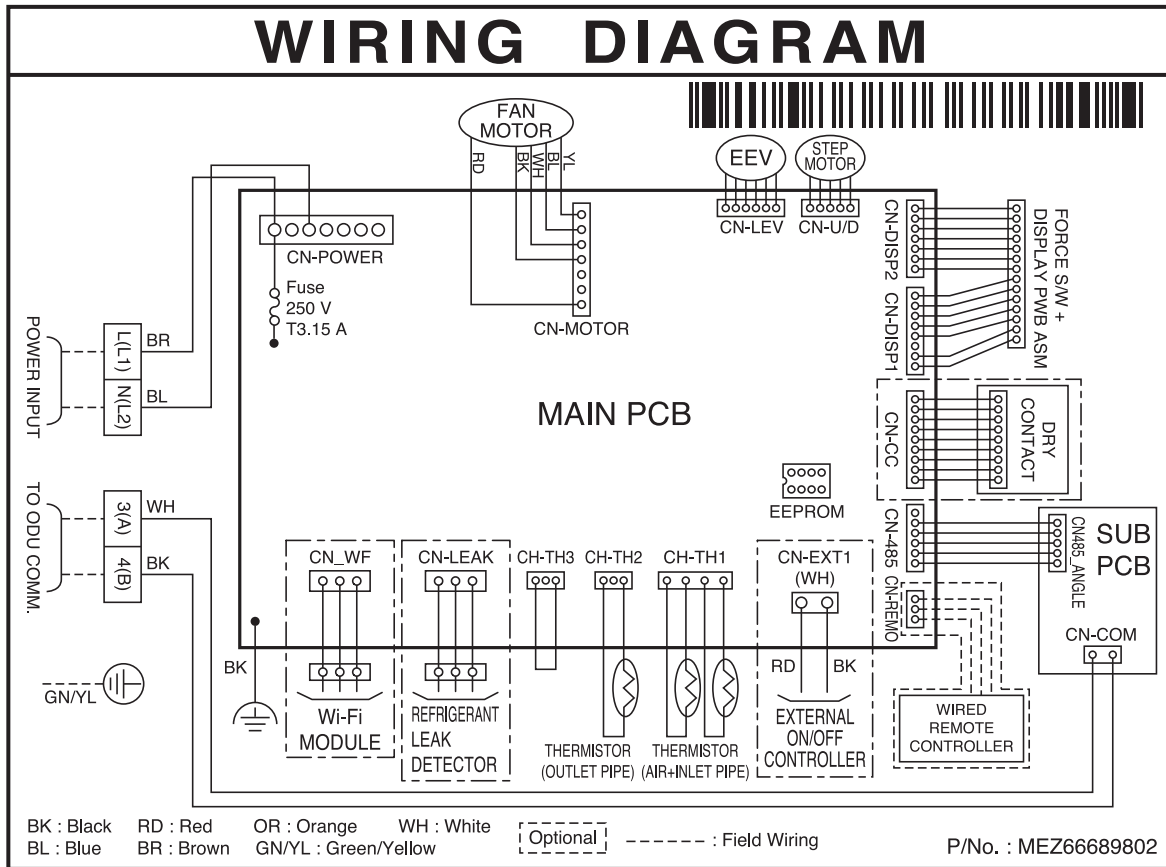

CONNECTOR NUMBER	LOCATION POINT	FUNCTION
CN-POWER	AC Power supply	AC Power line input for indoor
CN-MOTOR	Fan motor output	Motor output of BLDC
CN-485	Communication	Connection between indoor
CN-DISP1	Display	Display of indoor status
CN-DISP2	Display	Display of indoor status
CN-LEV	EEV output	EEV Control output : connect to EEV directly or through IPM (Independent Power Module)
CN-U/D	Step motor	Step motor output
CN-TH1	Room/inlet pipe sensor	Room and inlet pipe thermistor
CN-TH2	Outlet pipe sensor	Outlet pipe thermistor
CN-REMO	Remote controller	Remote control line
CN-CC	Dry contact	Dry contact line
CN-EXT	External On/Off	External On/Off signal input
CN-LEAK	Refrigerant leak detector	Refrigerant leak detector line
CN-WF	WIFI module	WIFI module connection line

6. Capacity Tables

■ Cooling Capacity

Nominal Capacity (kBtu/h) [Capacity Index (kW)]	Indoor air temp. (DB/WB, °C)													
	20		23		26		27		28		30		32	
	14		16		18		19		20		22		24	
	TC	SHC	TC	SHC	TC	SHC	TC	SHC	TC	SHC	TC	SHC	TC	SHC
5 [1.6]	1.1	1.1	1.3	1.3	1.5	1.4	1.6	1.4	1.7	1.5	1.7	1.4	1.8	1.3
7 [2.2]	1.5	1.5	1.8	1.6	2.0	1.8	2.2	1.8	2.4	1.9	2.4	1.8	2.4	1.6
9 [2.8]	1.9	1.7	2.2	1.9	2.6	2.1	2.8	2.1	3.0	2.2	3.0	2.1	3.1	1.9
12 [3.6]	2.4	2.0	2.9	2.3	3.3	2.5	3.6	2.6	3.9	2.7	3.9	2.5	4.0	2.3
15 [4.5]	3.0	2.5	3.6	2.9	4.2	3.2	4.5	3.2	4.8	3.4	4.9	3.2	4.9	2.9
18 [5.6]	3.8	3.3	4.5	3.6	5.2	3.9	5.6	4.0	6.0	4.1	6.1	3.9	6.2	3.6
24 [7.1]	4.8	3.9	5.7	4.5	6.6	4.9	7.1	5.0	7.6	5.2	7.7	4.9	7.8	4.5
30 [9.0]	5.9	5.2	7.1	5.7	8.2	6.2	8.8	6.3	9.4	6.6	9.5	6.2	9.7	5.7
36 [10.6]	7.0	6.0	8.3	6.6	9.7	7.1	10.4	7.3	11.1	7.6	11.3	7.1	11.4	6.6

Note

1. TC: Total Capacity(kW), SHC: Sensible Heat Capacity(kW)
2. Capacity tables show the average value of conditions which may occur.
3. Refer to Capacity tables and correction factor in the outdoor unit PDB for the actual performance data of each indoor unit and outdoor unit combination.

■ Heating Capacity

Nominal Capacity (kBtu/h) [Capacity Index (kW)]	Indoor air temp. (DB, °C)					
	16	18	20	21	22	24
	TC	TC	TC	TC	TC	TC
5 [1.6]	2.0	1.9	1.8	1.7	1.7	1.6
7 [2.2]	2.8	2.7	2.5	2.4	2.3	2.2
9 [2.8]	3.6	3.4	3.2	3.1	3.0	2.8
12 [3.6]	4.5	4.3	4.0	3.9	3.7	3.5
15 [4.5]	5.6	5.3	5.0	4.8	4.7	4.4
18 [5.6]	7.1	6.7	6.3	6.1	5.9	5.5
24 [7.1]	8.5	8.0	7.5	7.3	7.0	6.5
30 [9.0]	10.6	10.0	9.4	9.1	8.8	8.2
36 [10.6]	12.2	11.5	10.8	10.5	10.1	9.4

Note

1. TC: Total Capacity(kW)
2. Capacity tables show the average value of conditions which may occur.
3. Refer to Capacity tables and correction factor in the outdoor unit PDB for the actual performance data of each indoor unit and outdoor unit combination.

7. Air Velocity and Temperature Distribution

■ ARNU05GSJ*4

◆ Cooling

Side View

Discharge angle: 35°

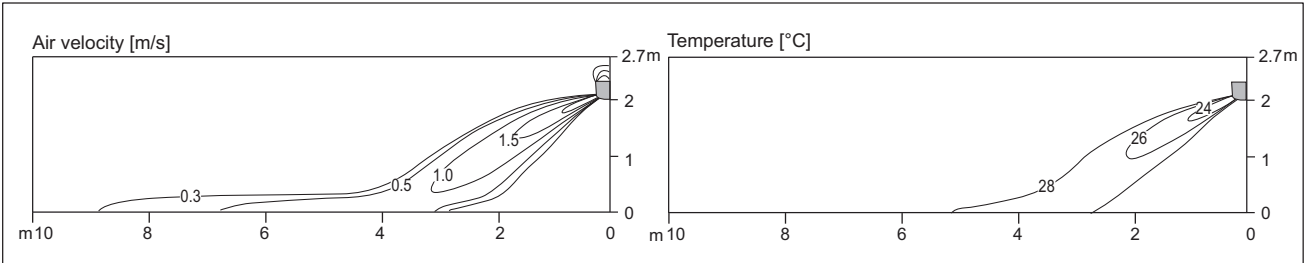

- Vertical Louver : Center
- Vertical Louver angle : 0°
- Fan speed : High

Top View

Discharge angle: 35°

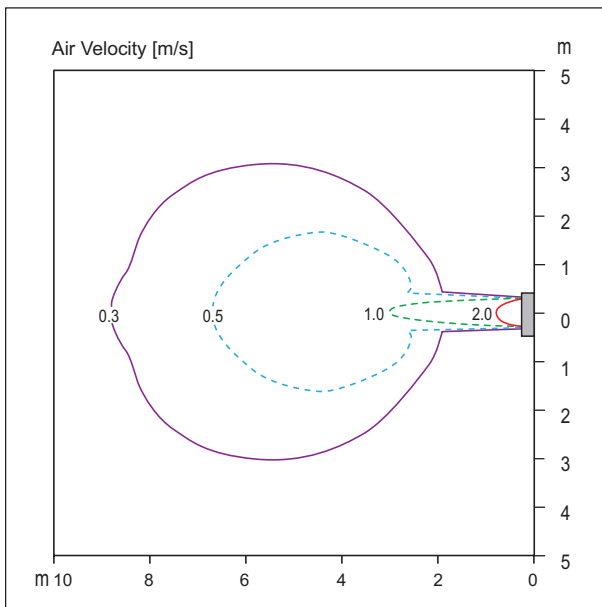

- Vertical Louver : Center
- Vertical Louver angle : 0°
- Air speed 0.3m/s Range : 8.9m
- Fan speed : High

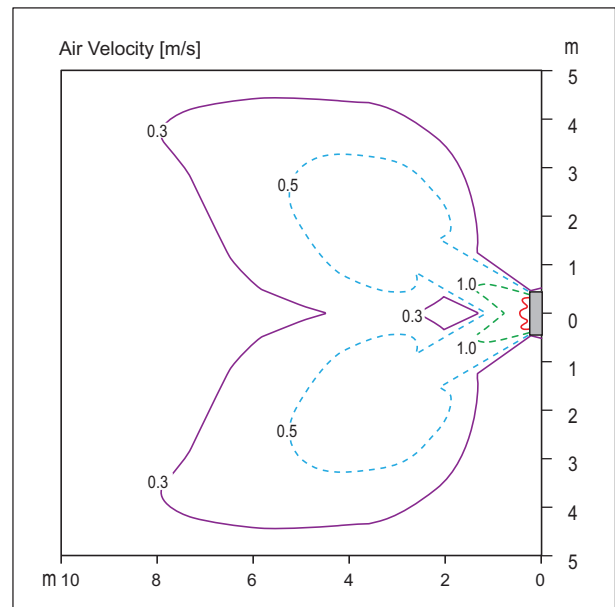

- Vertical Louver : Left & Right
- Vertical Louver angle : 50°
- Air speed 0.3m/s Range : 8m
- Fan speed : High

Note

- These figures are accordance with normal certain condition and environment. (Airflow step is 'High', Air discharge angle is fixed as indicated angle.)
- Indoor airflow distribution under actual installation or operating conditions depends on ambient temperature, ceiling height, product installation direction / location, indoor / Heating load, and other obstacles, etc.

7. Air Velocity and Temperature Distribution

◆ Heating

Side View

Discharge angle: 55°

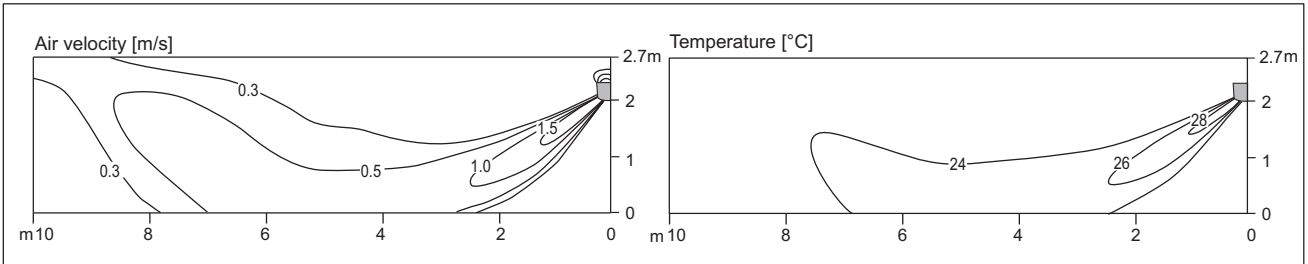

- Vertical Louver : Center
- Vertical Louver angle : 0°
- Fan speed : High

Top View

Discharge angle: 55°

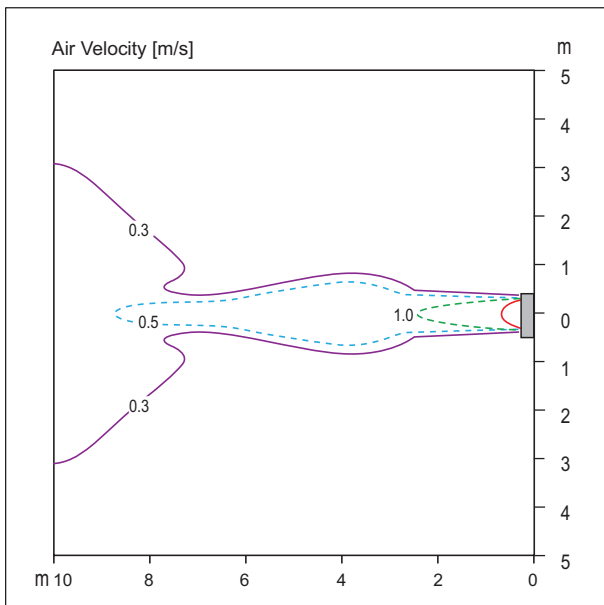

- Vertical Louver : Center
- Vertical Louver angle : 0°
- Air speed 0.3m/s Range : 11.9m
- Fan speed : High

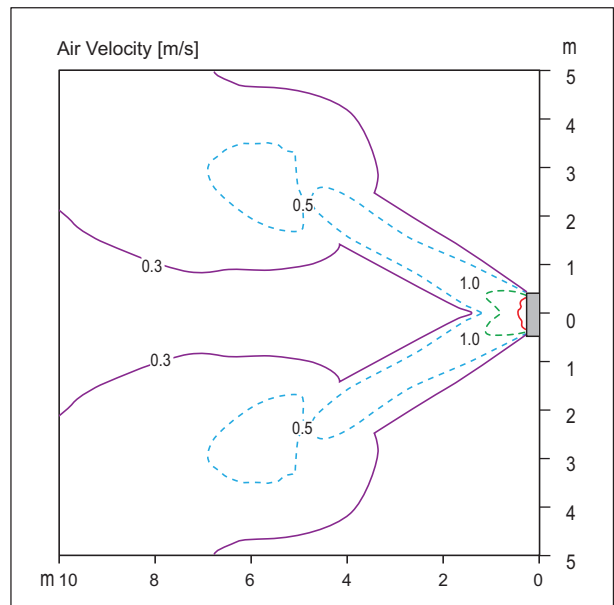

- Vertical Louver : Left & Right
- Vertical Louver angle : 50°
- Air speed 0.3m/s Range : 12.6m
- Fan speed : High

Note

- These figures are accordance with normal certain condition and environment.
(Airflow step is 'High', Air discharge angle is fixed as indicated angle.)
- Indoor airflow distribution under actual installation or operating conditions depends on ambient temperature, ceiling height, product installation direction / location, indoor / Heating load, and other obstacles, etc.

7. Air Velocity and Temperature Distribution

■ ARNU07GSJ*4

◆ Cooling

Side View

Discharge angle: 35°

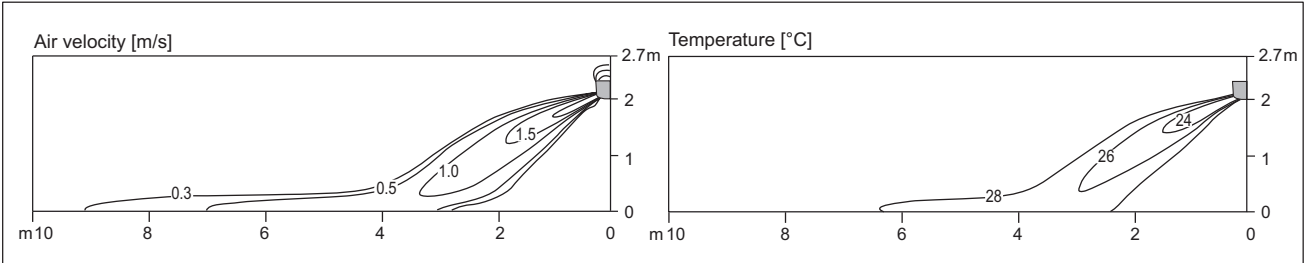

- Vertical Louver : Center
- Vertical Louver angle : 0°
- Fan speed : High

Top View

Discharge angle: 35°

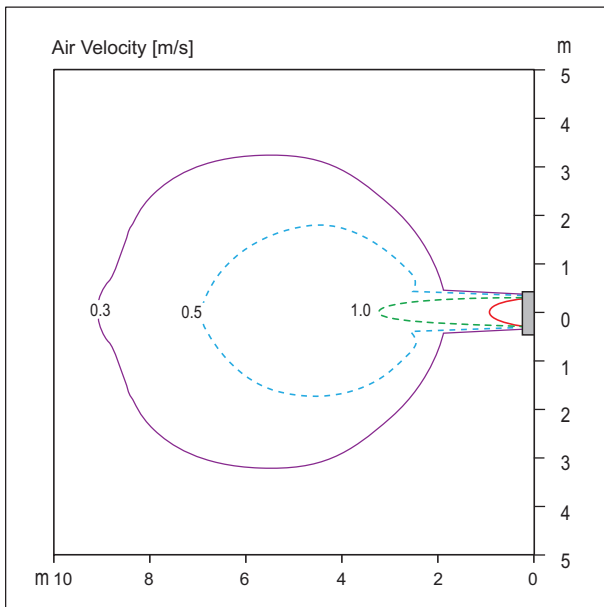

- Vertical Louver : Center
- Vertical Louver angle : 0°
- Air speed 0.3m/s Range : 9.2m
- Fan speed : High

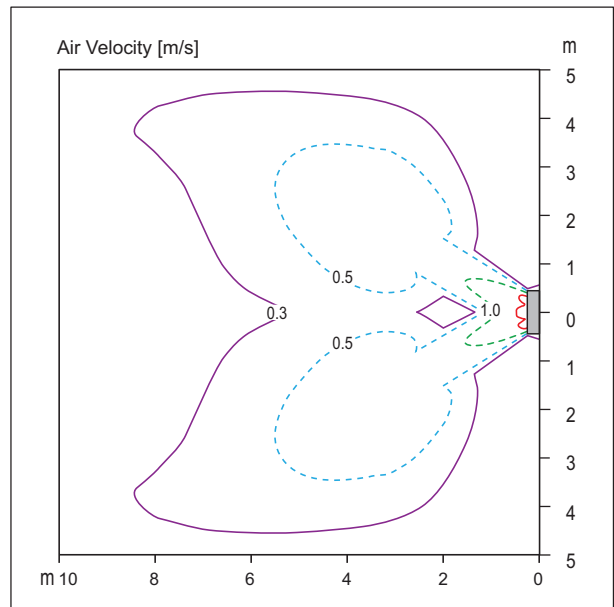

- Vertical Louver : Left & Right
- Vertical Louver angle : 50°
- Air speed 0.3m/s Range : 8.4m
- Fan speed : High

Note

- These figures are accordance with normal certain condition and environment. (Airflow step is 'High', Air discharge angle is fixed as indicated angle.)
- Indoor airflow distribution under actual installation or operating conditions depends on ambient temperature, ceiling height, product installation direction / location, indoor / Heating load, and other obstacles, etc.

7. Air Velocity and Temperature Distribution

◆ Heating

Side View

Discharge angle: 55°

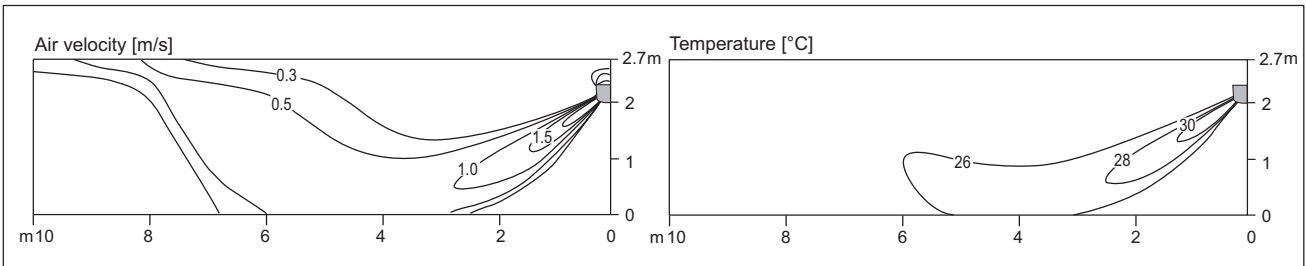

- Vertical Louver : Center
- Vertical Louver angle : 0°
- Fan speed : High

Top View

Discharge angle: 55°

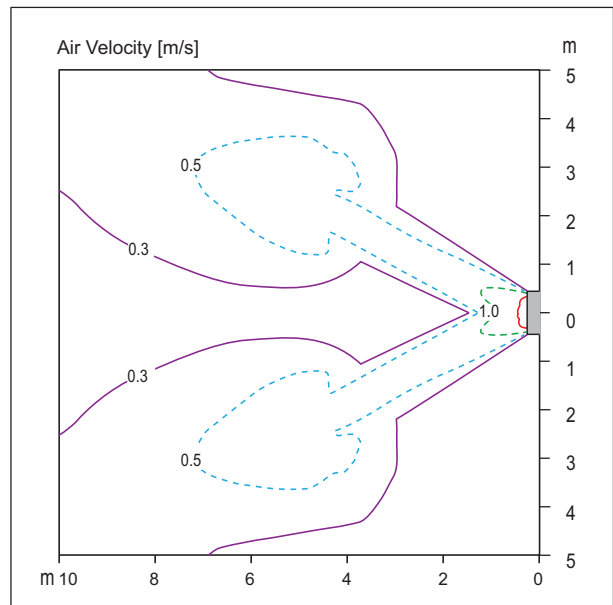
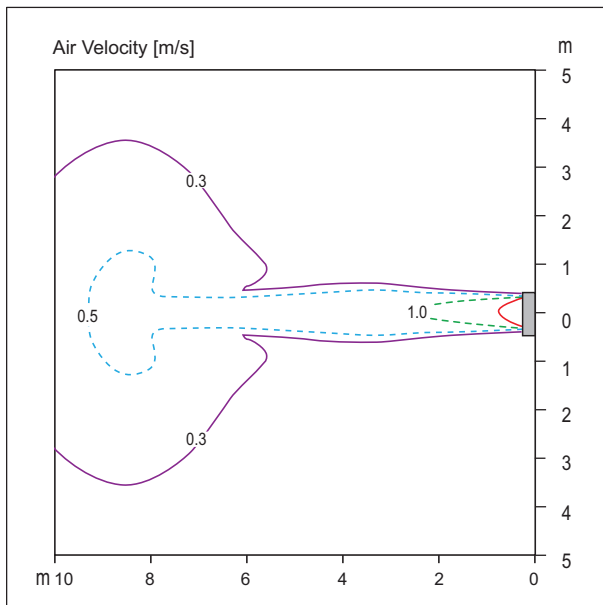

- Vertical Louver : Center
- Vertical Louver angle : 0°
- Air speed 0.3m/s Range : 11m
- Fan speed : High

- Vertical Louver : Left & Right
- Vertical Louver angle : 50°
- Air speed 0.3m/s Range : 13.2m
- Fan speed : High

Note

- These figures are accordance with normal certain condition and environment.
(Airflow step is 'High', Air discharge angle is fixed as indicated angle.)
- Indoor airflow distribution under actual installation or operating conditions depends on ambient temperature, ceiling height, product installation direction / location, indoor / Heating load, and other obstacles, etc.

7. Air Velocity and Temperature Distribution

■ ARNU09GSJ*4

◆ Cooling

Side View

Discharge angle: 35°

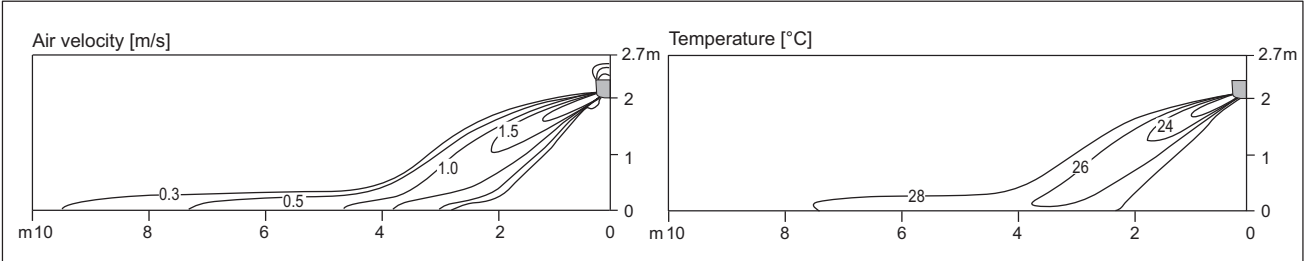

- Vertical Louver : Center
- Vertical Louver angle : 0°
- Fan speed : High

Top View

Discharge angle: 35°

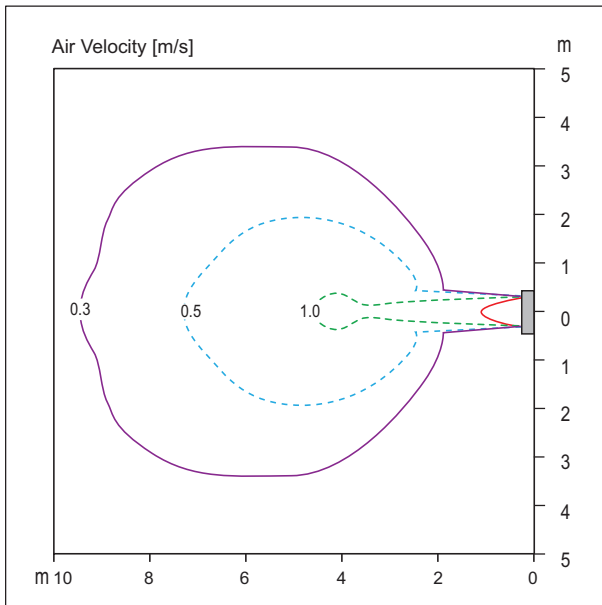

- Vertical Louver : Center
- Vertical Louver angle : 0°
- Air speed 0.3m/s Range : 9.6m
- Fan speed : High

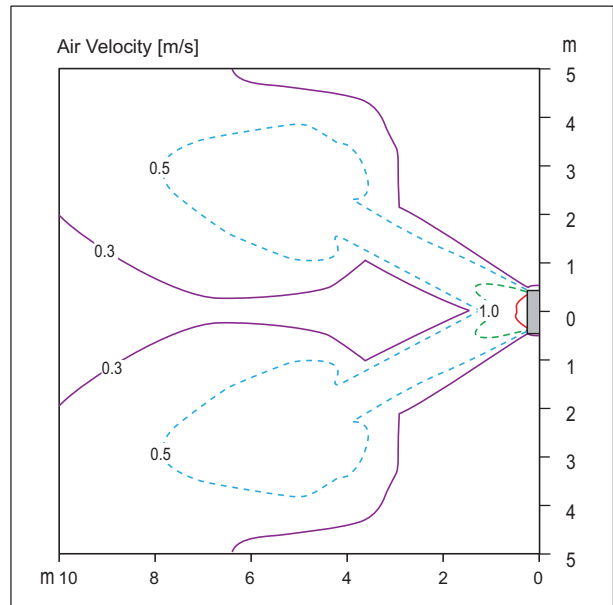

- Vertical Louver : Left & Right
- Vertical Louver angle : 50°
- Air speed 0.3m/s Range : 14m
- Fan speed : High

Note

- These figures are accordance with normal certain condition and environment. (Airflow step is 'High', Air discharge angle is fixed as indicated angle.)
- Indoor airflow distribution under actual installation or operating conditions depends on ambient temperature, ceiling height, product installation direction / location, indoor / Heating load, and other obstacles, etc.

7. Air Velocity and Temperature Distribution

◆ Heating

Side View

Discharge angle: 55°

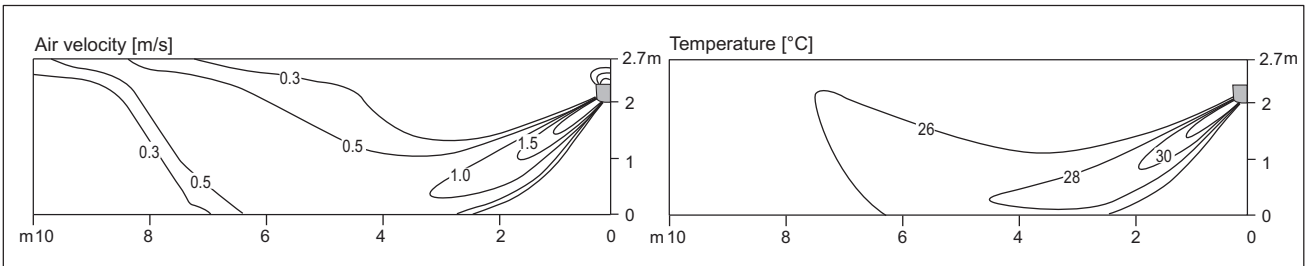

- Vertical Louver : Center
- Vertical Louver angle : 0°
- Fan speed : High

Top View

Discharge angle: 55°

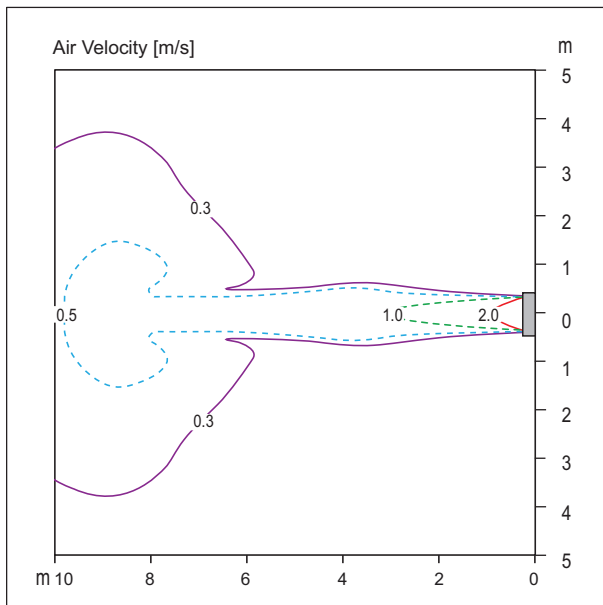

- Vertical Louver : Center
- Vertical Louver angle : 0°
- Air speed 0.3m/s Range : 11.8m
- Fan speed : High

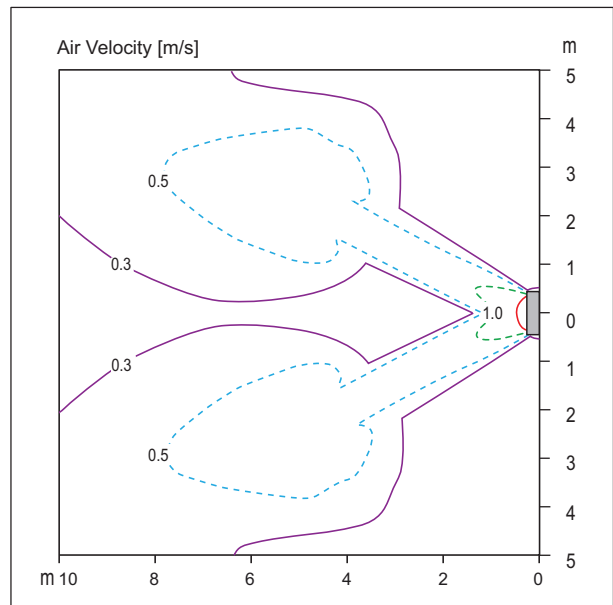

- Vertical Louver : Left & Right
- Vertical Louver angle : 50°
- Air speed 0.3m/s Range : 14m
- Fan speed : High

Note

- These figures are accordance with normal certain condition and environment. (Airflow step is 'High', Air discharge angle is fixed as indicated angle.)
- Indoor airflow distribution under actual installation or operating conditions depends on ambient temperature, ceiling height, product installation direction / location, indoor / Heating load, and other obstacles, etc.

7. Air Velocity and Temperature Distribution

■ ARNU12GSJ*4

◆ Cooling

Side View

Discharge angle: 35°

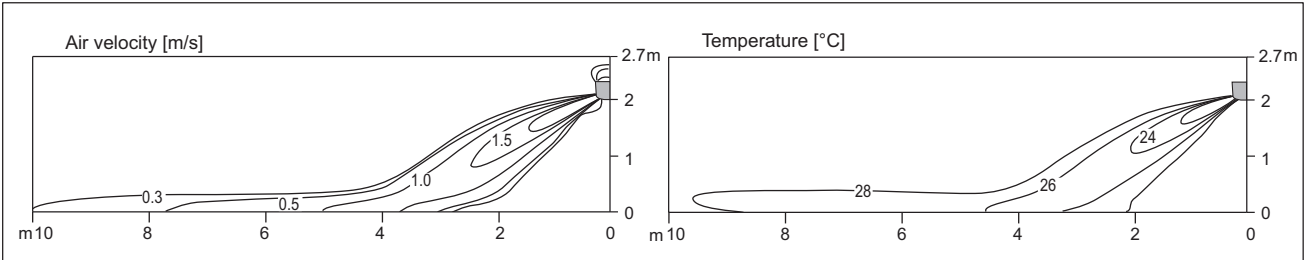

- Vertical Louver : Center
- Vertical Louver angle : 0°
- Fan speed : High

Top View

Discharge angle: 35°

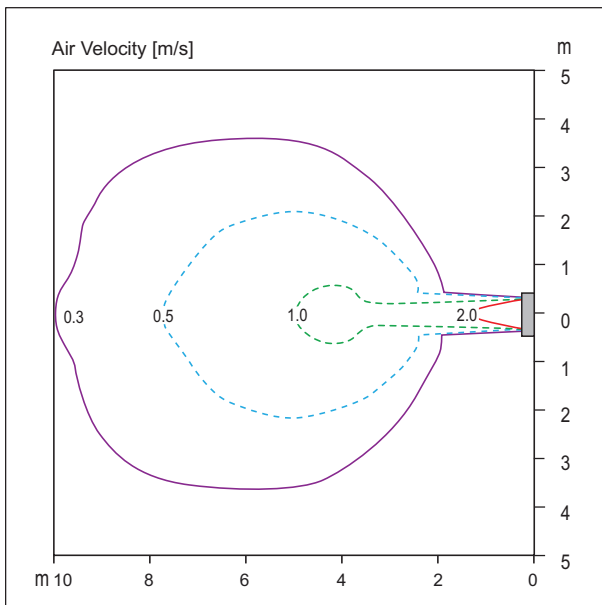

- Vertical Louver : Center
- Vertical Louver angle : 0°
- Air speed 0.3m/s Range : 10m
- Fan speed : High

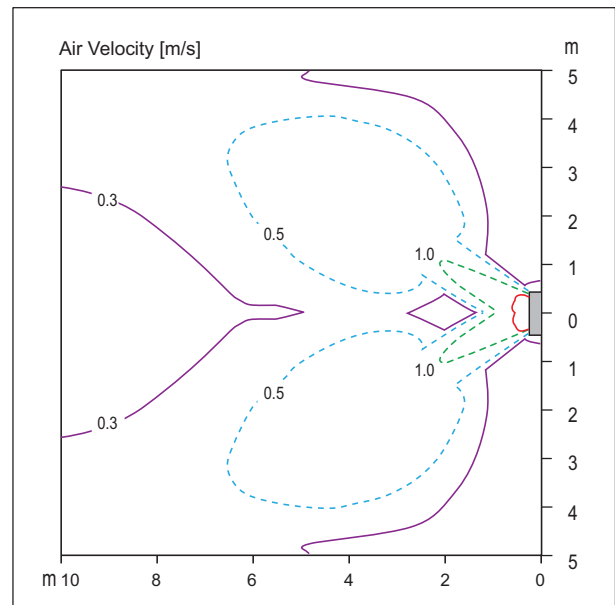

- Vertical Louver : Left & Right
- Vertical Louver angle : 50°
- Air speed 0.3m/s Range : 14.3m
- Fan speed : High

Note

- These figures are accordance with normal certain condition and environment. (Airflow step is 'High', Air discharge angle is fixed as indicated angle.)
- Indoor airflow distribution under actual installation or operating conditions depends on ambient temperature, ceiling height, product installation direction / location, indoor / Heating load, and other obstacles, etc.

7. Air Velocity and Temperature Distribution

◆ Heating

Side View

Discharge angle: 55°

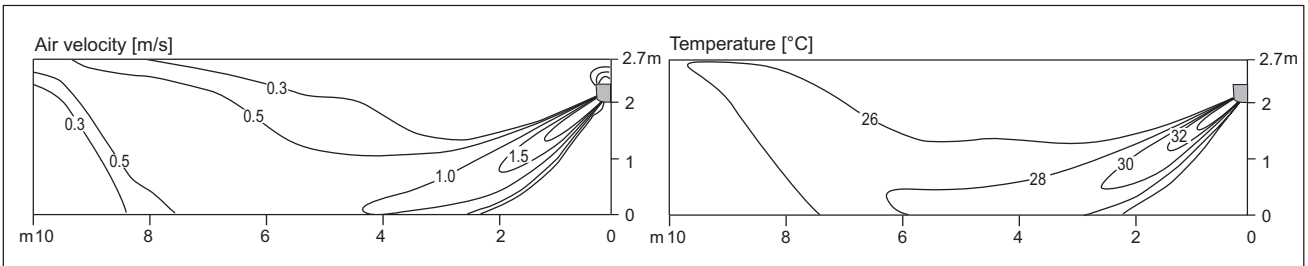

- Vertical Louver : Center
- Vertical Louver angle : 0°
- Fan speed : High

Top View

Discharge angle: 55°

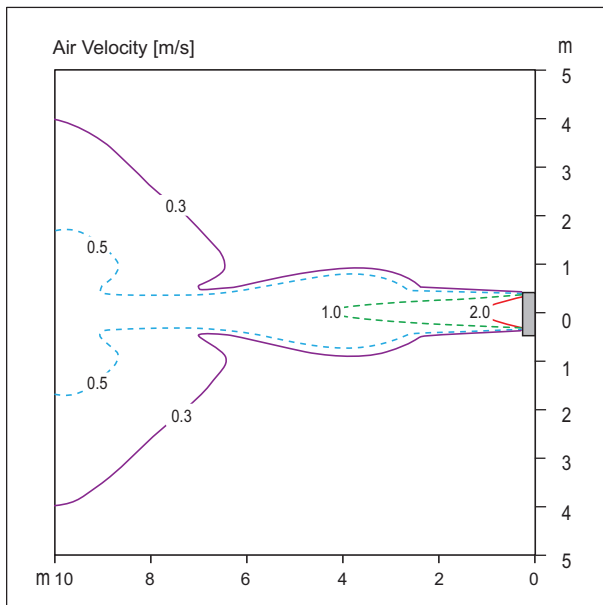

- Vertical Louver : Center
- Vertical Louver angle : 0°
- Air speed 0.3m/s Range : 13m
- Fan speed : High

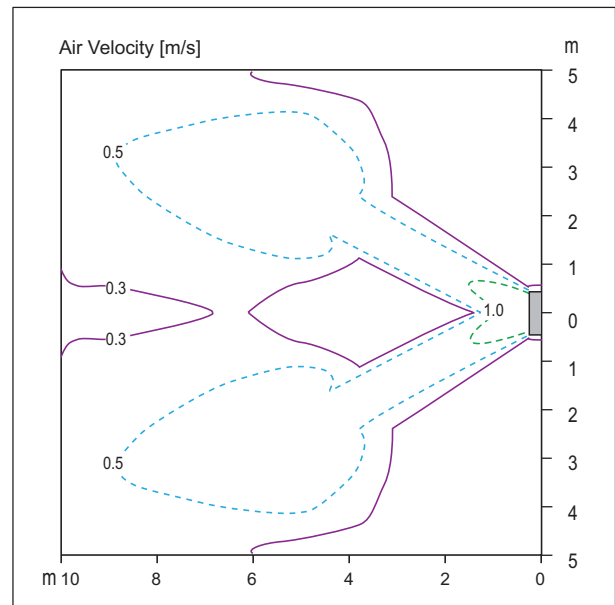

- Vertical Louver : Left & Right
- Vertical Louver angle : 50°
- Air speed 0.3m/s Range : 14.3m
- Fan speed : High

Note

- These figures are accordance with normal certain condition and environment. (Airflow step is 'High', Air discharge angle is fixed as indicated angle.)
- Indoor airflow distribution under actual installation or operating conditions depends on ambient temperature, ceiling height, product installation direction / location, indoor / Heating load, and other obstacles, etc.

7. Air Velocity and Temperature Distribution

■ ARNU15GSJ*4

◆ Cooling

Side View

Discharge angle: 35°

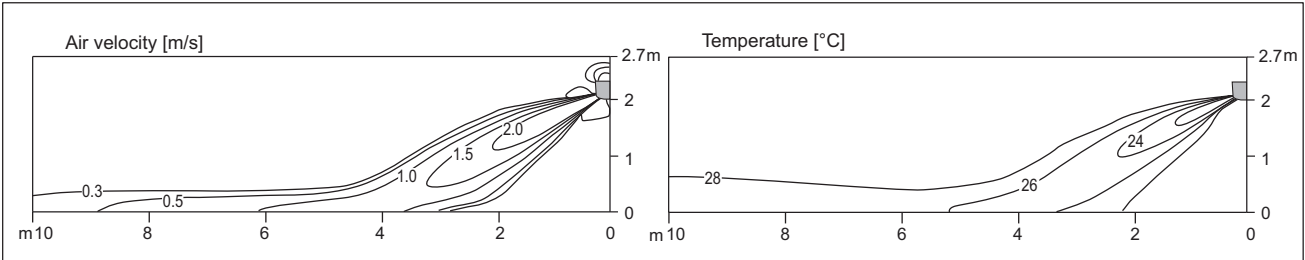

- Vertical Louver : Center
- Vertical Louver angle : 0°
- Fan speed : High

Top View

Discharge angle: 35°

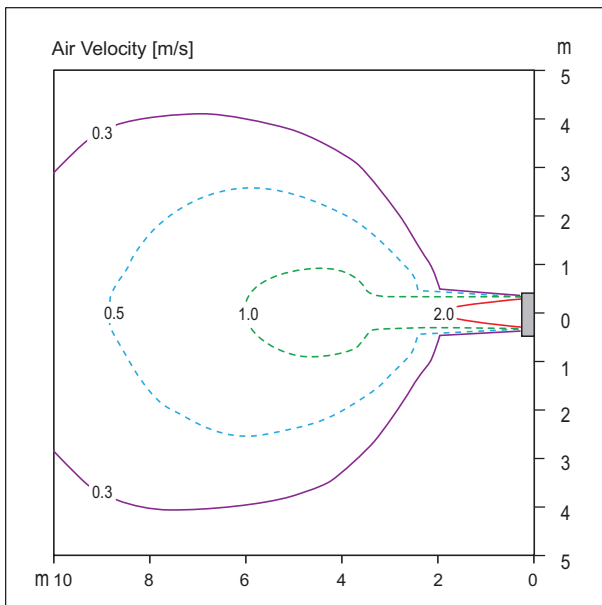

- Vertical Louver : Center
- Vertical Louver angle : 0°
- Air speed 0.3m/s Range : 11.5m
- Fan speed : High

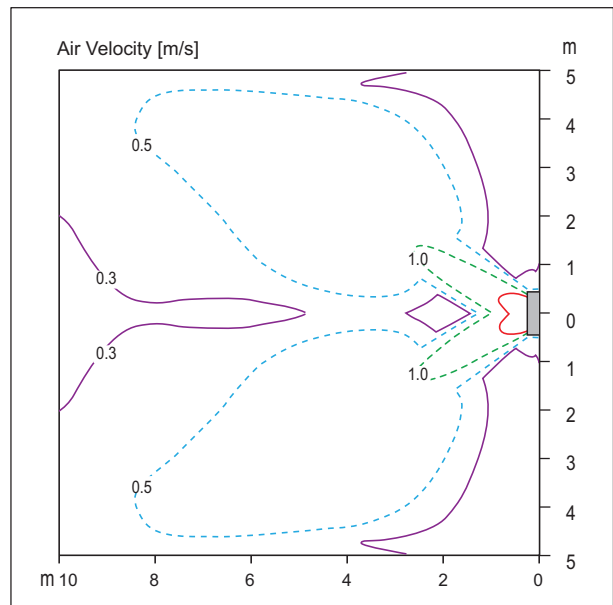

- Vertical Louver : Left & Right
- Vertical Louver angle : 50°
- Air speed 0.3m/s Range : 16.7m
- Fan speed : High

Note

- These figures are accordance with normal certain condition and environment. (Airflow step is 'High', Air discharge angle is fixed as indicated angle.)
- Indoor airflow distribution under actual installation or operating conditions depends on ambient temperature, ceiling height, product installation direction / location, indoor / Heating load, and other obstacles, etc.

7. Air Velocity and Temperature Distribution

◆ Heating

Side View

Discharge angle: 55°

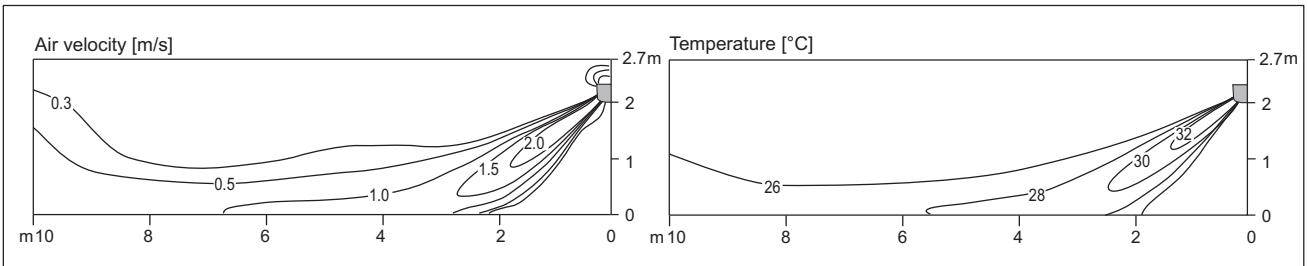

- Vertical Louver : Center
- Vertical Louver angle : 0°
- Fan speed : High

Top View

Discharge angle: 55°

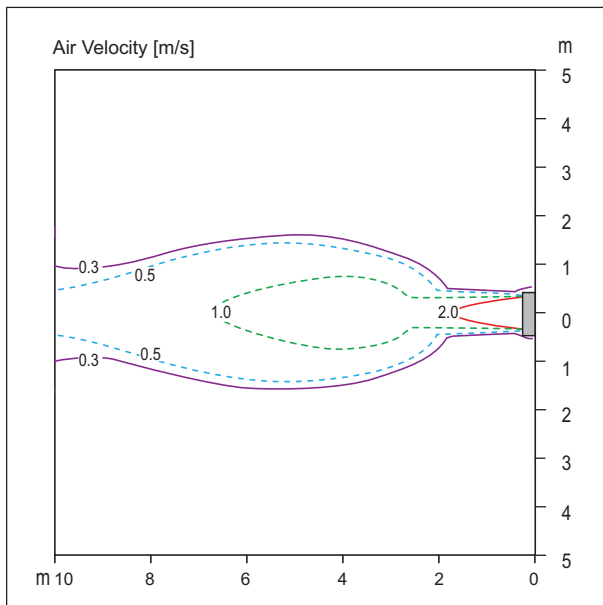

- Vertical Louver : Center
- Vertical Louver angle : 0°
- Air speed 0.3m/s Range : 18m
- Fan speed : High

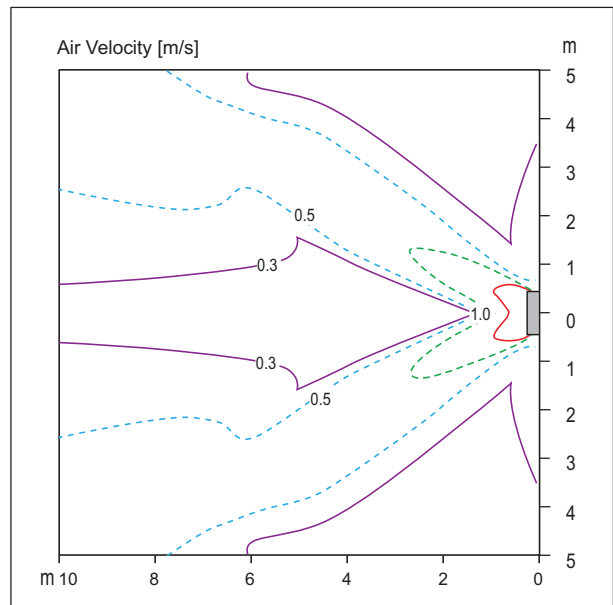

- Vertical Louver : Left & Right
- Vertical Louver angle : 50°
- Air speed 0.3m/s Range : 18.8m
- Fan speed : High

Note

- These figures are accordance with normal certain condition and environment. (Airflow step is 'High', Air discharge angle is fixed as indicated angle.)
- Indoor airflow distribution under actual installation or operating conditions depends on ambient temperature, ceiling height, product installation direction / location, indoor / Heating load, and other obstacles, etc.

7. Air Velocity and Temperature Distribution

■ ARNU18GSK*4

◆ Cooling

Side View

Discharge angle: 25°

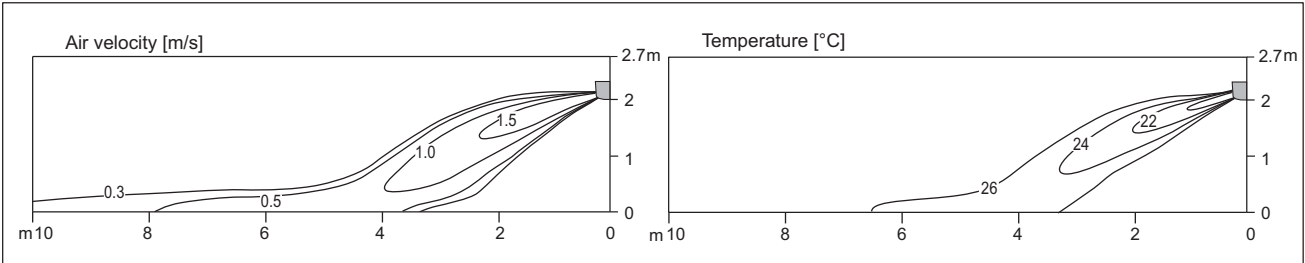

- Vertical Louver : Center
- Vertical Louver angle : 0°
- Fan speed : High

Top View

Discharge angle: 25°

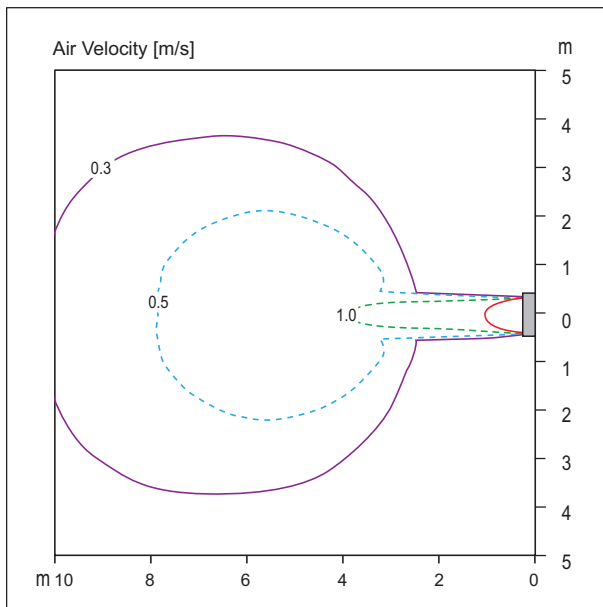

- Vertical Louver : Center
- Vertical Louver angle : 0°
- Air speed 0.3m/s Range : 10.4m
- Fan speed : High

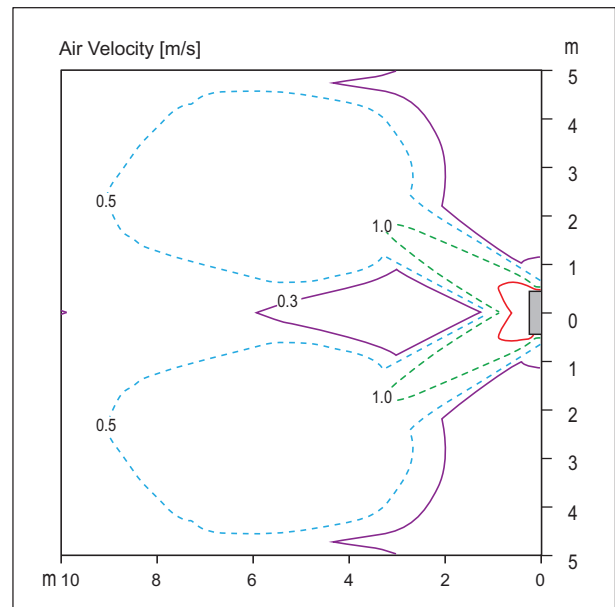

- Vertical Louver : Left & Right
- Vertical Louver angle : 50°
- Air speed 0.3m/s Range : 15.2m
- Fan speed : High

Note

- These figures are accordance with normal certain condition and environment. (Airflow step is 'High', Air discharge angle is fixed as indicated angle.)
- Indoor airflow distribution under actual installation or operating conditions depends on ambient temperature, ceiling height, product installation direction / location, indoor / Heating load, and other obstacles, etc.

7. Air Velocity and Temperature Distribution

◆ Heating

Side View

Discharge angle: 45°

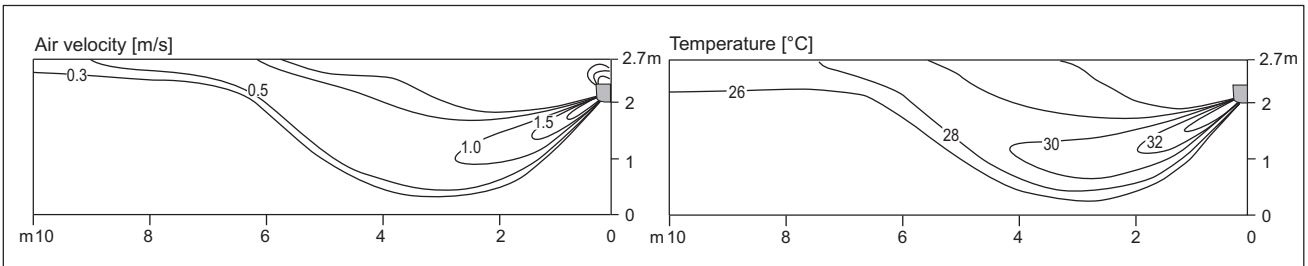

- Vertical Louver : Center
- Vertical Louver angle : 0°
- Fan speed : High

Top View

Discharge angle: 45°

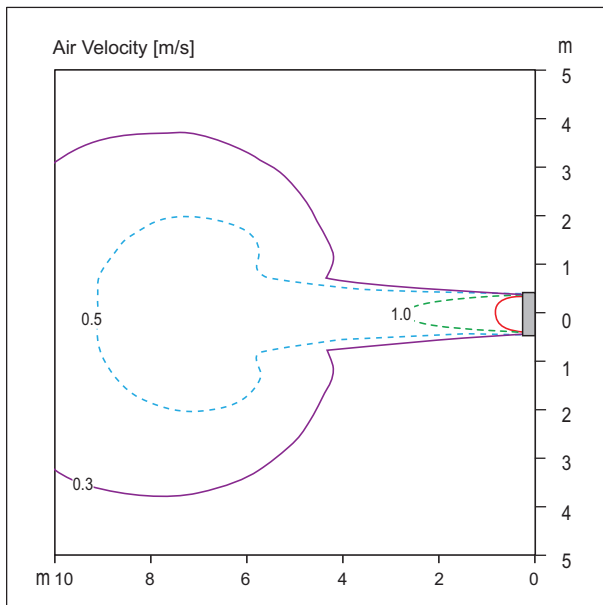

- Vertical Louver : Center
- Vertical Louver angle : 0°
- Air speed 0.3m/s Range : 11.6m
- Fan speed : High

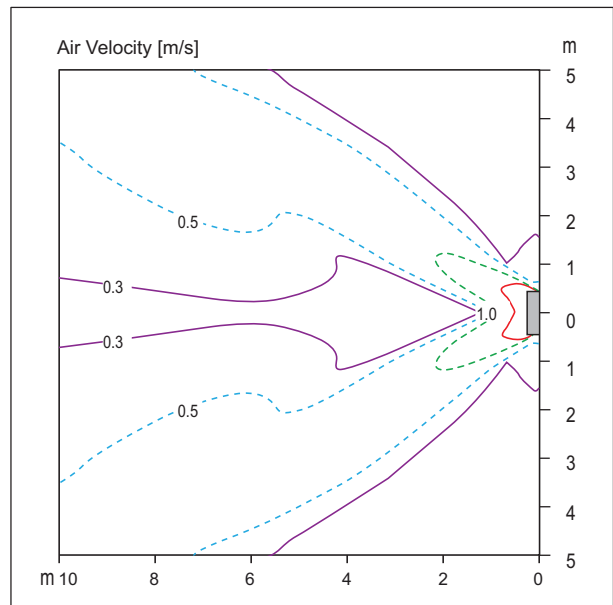

- Vertical Louver : Left & Right
- Vertical Louver angle : 50°
- Air speed 0.3m/s Range : 18.2m
- Fan speed : High

Note

- These figures are accordance with normal certain condition and environment. (Airflow step is 'High', Air discharge angle is fixed as indicated angle.)
- Indoor airflow distribution under actual installation or operating conditions depends on ambient temperature, ceiling height, product installation direction / location, indoor / Heating load, and other obstacles, etc.

7. Air Velocity and Temperature Distribution

■ ARNU24GSK*4

◆ Cooling

Side View

Discharge angle: 25°

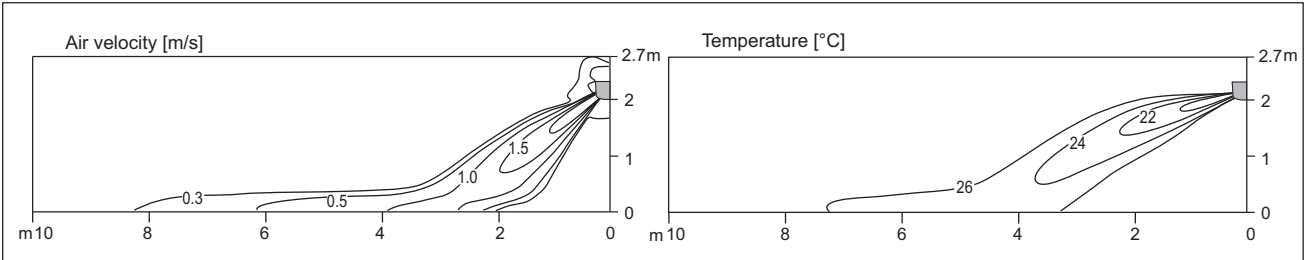

- Vertical Louver : Center
- Vertical Louver angle : 0°
- Fan speed : High

Top View

Discharge angle: 25°

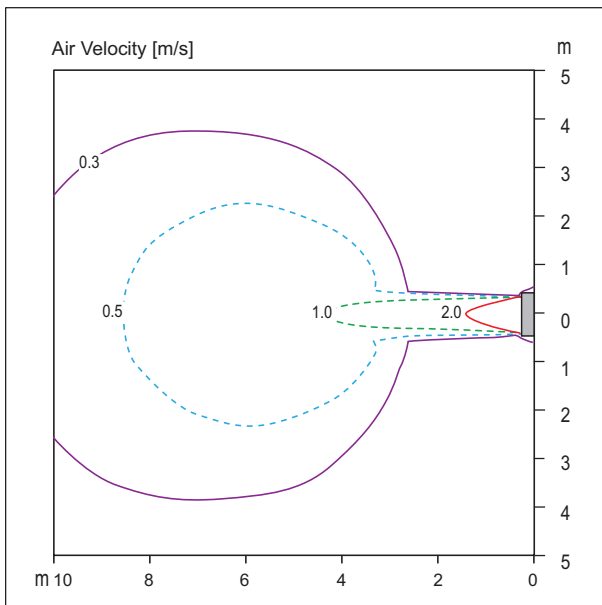

- Vertical Louver : Center
- Vertical Louver angle : 0°
- Air speed 0.3m/s Range : 11.2m
- Fan speed : High

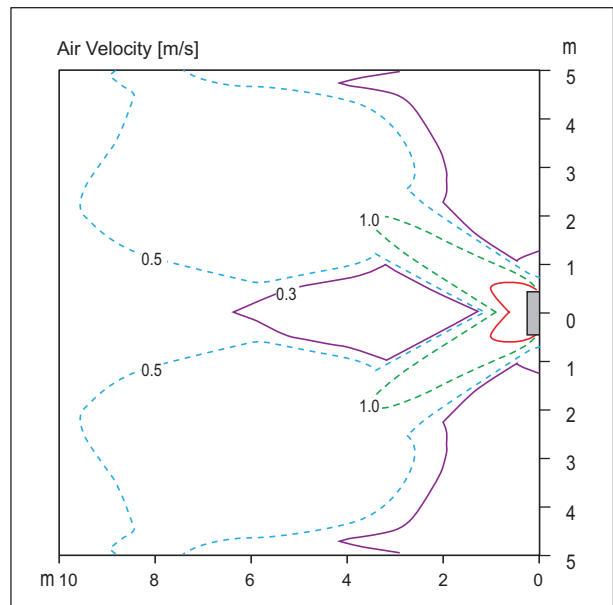

- Vertical Louver : Left & Right
- Vertical Louver angle : 50°
- Air speed 0.3m/s Range : 16.5m
- Fan speed : High

Note

- These figures are accordance with normal certain condition and environment. (Airflow step is 'High', Air discharge angle is fixed as indicated angle.)
- Indoor airflow distribution under actual installation or operating conditions depends on ambient temperature, ceiling height, product installation direction / location, indoor / Heating load, and other obstacles, etc.

7. Air Velocity and Temperature Distribution

◆ Heating

Side View

Discharge angle: 45°

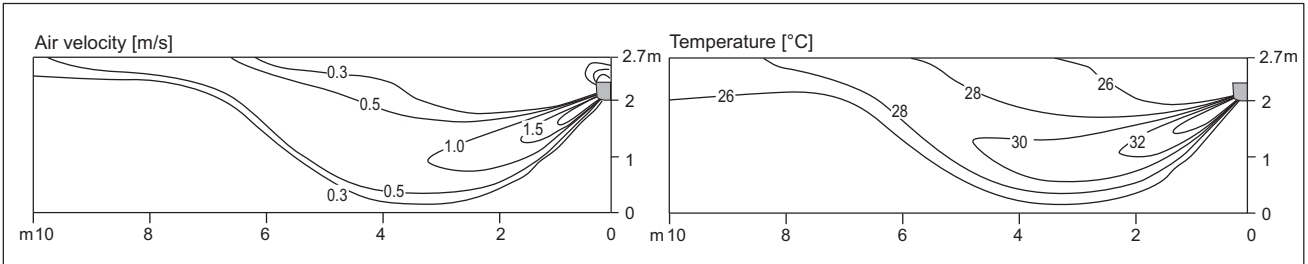

- Vertical Louver : Center
- Vertical Louver angle : 0°
- Fan speed : High

Top View

Discharge angle: 45°

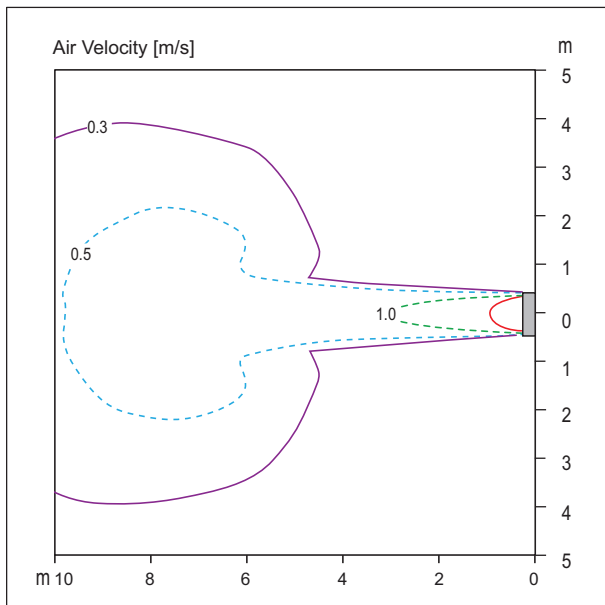

- Vertical Louver : Center
- Vertical Louver angle : 0°
- Air speed 0.3m/s Range : 12.1m
- Fan speed : High

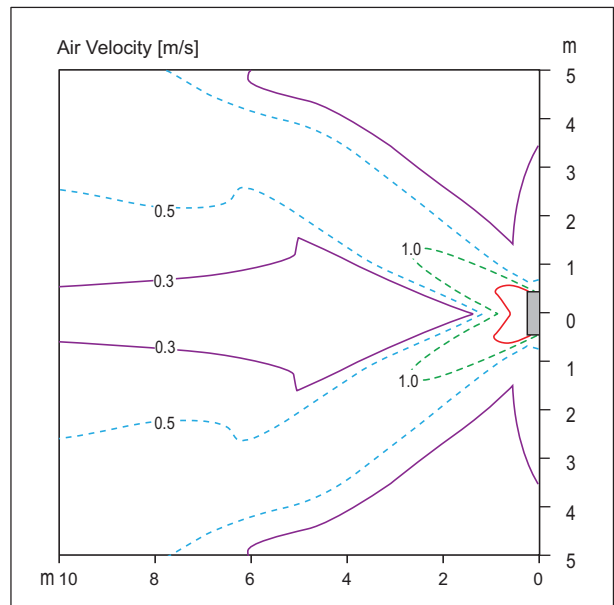

- Vertical Louver : Left & Right
- Vertical Louver angle : 50°
- Air speed 0.3m/s Range : 15.2m
- Fan speed : High

Note

- These figures are accordance with normal certain condition and environment. (Airflow step is 'High', Air discharge angle is fixed as indicated angle.)
- Indoor airflow distribution under actual installation or operating conditions depends on ambient temperature, ceiling height, product installation direction / location, indoor / Heating load, and other obstacles, etc.

7. Air Velocity and Temperature Distribution

■ ARNU30GSVA4

Cooling

Discharge angle: 25°

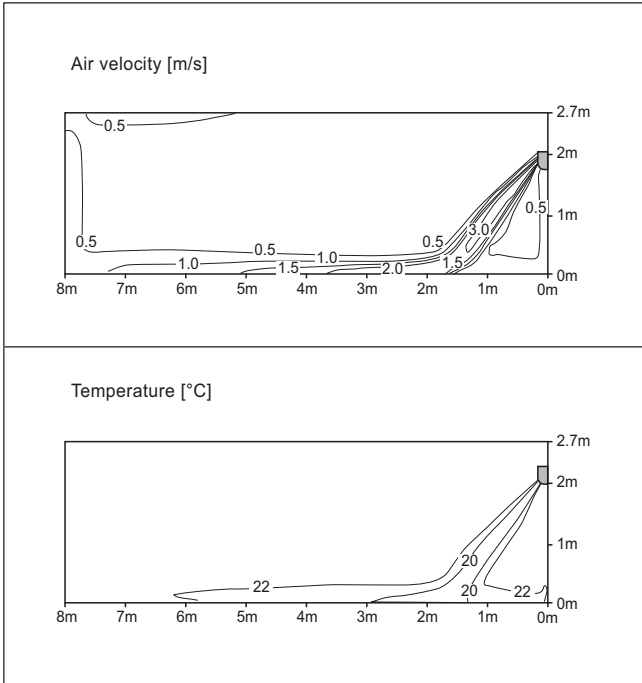

Heating

Discharge angle: 35°

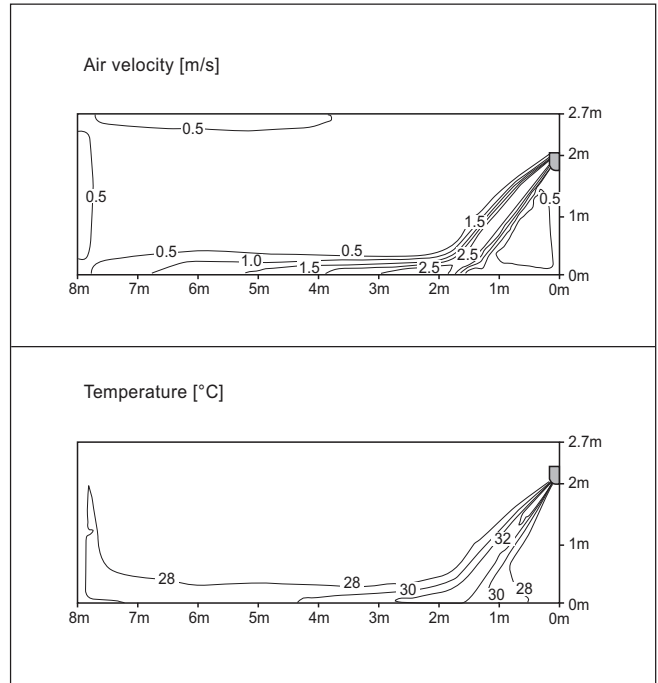

Note

- These figures are accordance with normal certain condition and environment. (Airflow step is 'High', Air discharge angle is fixed as indicated angle.)
- Indoor airflow distribution under actual installation or operating conditions depends on ambient temperature, ceiling height, product installation direction / location, indoor / Heating load, and other obstacles, etc.

7. Air Velocity and Temperature Distribution

■ ARNU36GSVA4

Cooling

Discharge angle: 25°

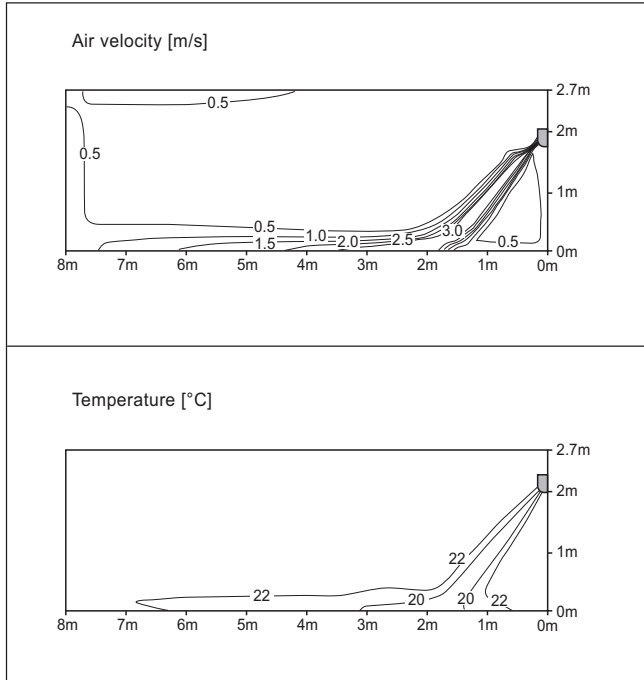

Heating

Discharge angle: 35°

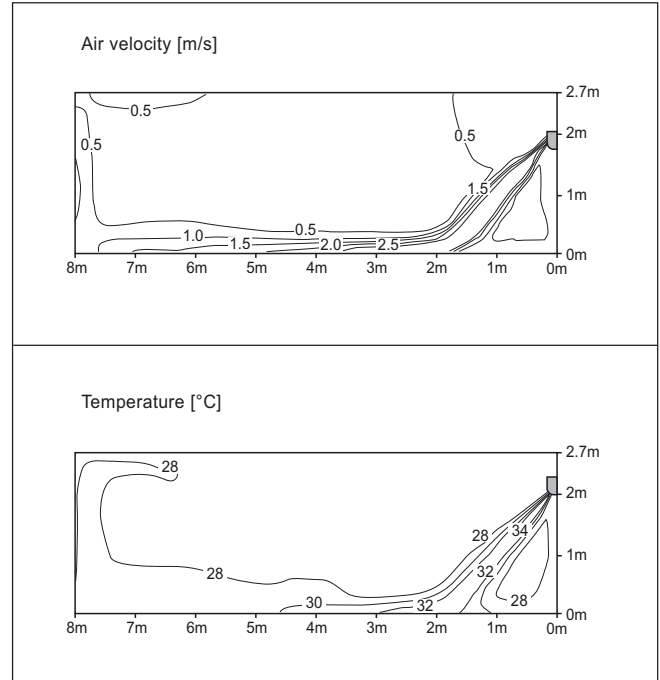

Note

- These figures are accordance with normal certain condition and environment. (Airflow step is 'High', Air discharge angle is fixed as indicated angle.)
- Indoor airflow distribution under actual installation or operating conditions depends on ambient temperature, ceiling height, product installation direction / location, indoor / Heating load, and other obstacles, etc.

8. Electric Characteristics

Units					Power supply	IFM		PI	
Model	Type	Hz	Volts	Voltage range	MCA	kW	FLA	Cooling	Heating
ARNU05GSJ*4	SJ	50	220-240	Max: 264 Min:198	0.31	0.030	0.25	30.0	30.0
ARNU07GSJ*4	SJ				0.31	0.030	0.25	30.0	30.0
ARNU09GSJ*4	SJ				0.31	0.030	0.25	30.0	30.0
ARNU12GSJ*4	SJ				0.31	0.030	0.25	30.0	30.0
ARNU15GSJ*4	SJ				0.31	0.030	0.25	30.0	30.0
ARNU18GSK*4	SK				0.65	0.058	0.52	53.0	53.0
ARNU24GSK*4	SK				0.65	0.058	0.52	53.0	53.0
ARNU30GSVA4	SV				0.64	0.113	0.51	88.0	88.0
ARNU36GSVA4	SV				1.01	0.113	0.81	105.0	105.0
ARNU05GSJ*4	SJ				60	220	Max: 242 Min:198	0.31	0.030
ARNU07GSJ*4	SJ	0.31	0.030	0.25				30.0	30.0
ARNU09GSJ*4	SJ	0.31	0.030	0.25				30.0	30.0
ARNU12GSJ*4	SJ	0.31	0.030	0.25				30.0	30.0
ARNU15GSJ*4	SJ	0.31	0.030	0.25				30.0	30.0
ARNU18GSK*4	SK	0.65	0.058	0.52				53.0	53.0
ARNU24GSK*4	SK	0.65	0.058	0.52				53.0	53.0
ARNU30GSVA4	SV	0.64	0.113	0.51				67.0	67.0
ARNU36GSVA4	SV	1.01	0.113	0.81				104.0	104.0

Symbols

MCA : Minimum Circuit Amperes (A)

MFA : Maximum Fuse Amperes (A)

kW : Fan Motor Rated Output (kW)

FLA : Full Load Amperes (A)

IFM : Indoor Fan Motor

PI : Maximum Power Input (W)

Note

- Voltage range
Units are suitable for use on electrical systems where voltage supplied to unit terminals is not below or above the listed range limits.
- Maximum allowable voltage unbalance between phases is 2%.
- MCA/MFA
 $MCA = 1.25 \times FLA$
 $MFA = 1.1 \times MCA, MFA \leq 4 \times FLA$
 (If MFA is smaller than minimum standard value, Use minimum standard value in region for selecting circuit breaker.)
- Select wire size based on the MCA
- Instead of fuse, use Circuit Breaker.

9. Sound Levels

9.1 Sound Pressure Levels

Overall

Note

1. Sound measured at some distance away from the center of the unit.
2. Data is valid at free field condition.
3. Reference acoustic pressure 0dB = 20μPa.
4. Data is valid at nominal operation condition.
Refer to the Model Specifications for nominal conditions(Power source and Ambient temperature, etc)
5. Sound levels can be increased in accordance with installation and operating conditions. (Static pressure mode, used air guide, Room target temperature setting, etc)
6. Sound level will vary depending on a range of factors such as the construction(acoustic absorption coefficient) of particular room in which the equipment is installed.
7. Sound pressure level is measured on the rated condition in the anechoic rooms by ISO 3745 standard.
Therefore, these values can be increased owing to ambient conditions during operation.

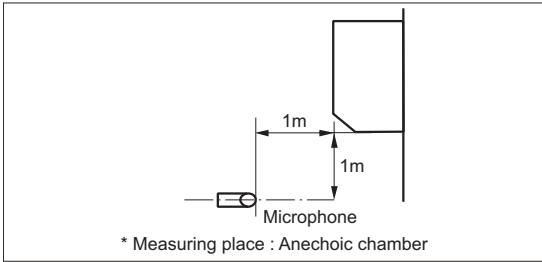

Model	Sound Pressure Levels [dB(A)]		
	High	Middle	Low
ARNU05GSJ*4	30	29	28
ARNU07GSJ*4	32	30	28
ARNU09GSJ*4	34	32	28
ARNU12GSJ*4	37	34	30
ARNU15GSJ*4	42	39	32
ARNU18GSK*4	43	39	34
ARNU24GSK*4	46	41	34
ARNU30GSVA4	49	44	42
ARNU36GSVA4	52	47	43

ARNU05GSJ*4

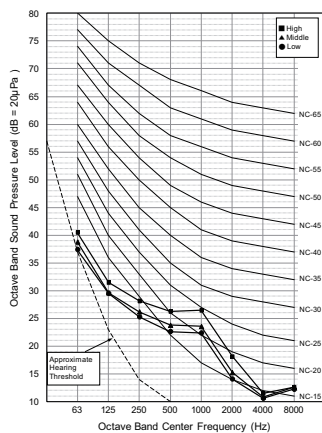

ARNU07GSJ*4

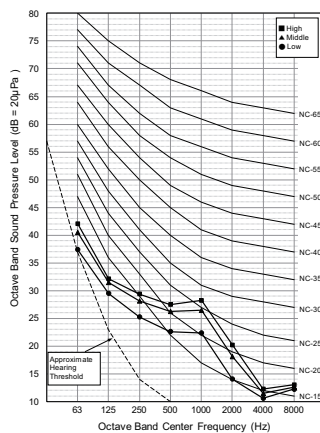

ARNU09GSJ*4

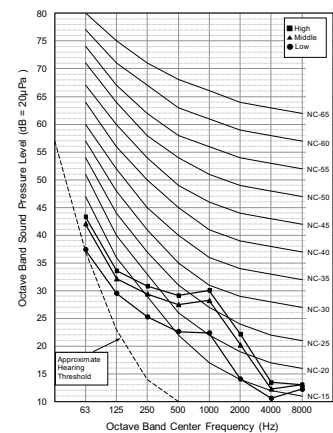

9. Sound Levels

ARNU12GSJ*4

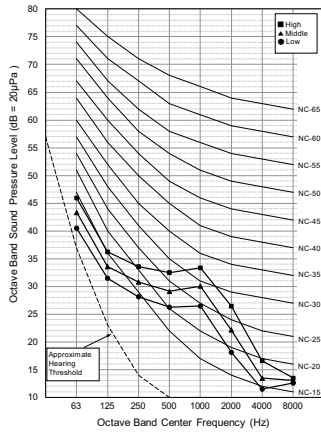

ARNU15GSJ*4

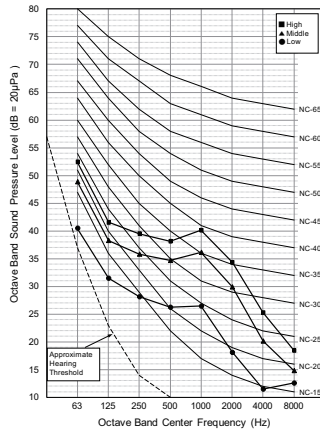

ARNU18GSK*4

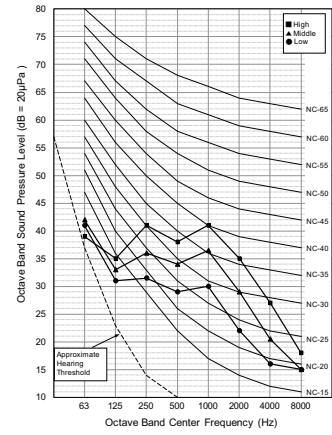

ARNU24GSK*4

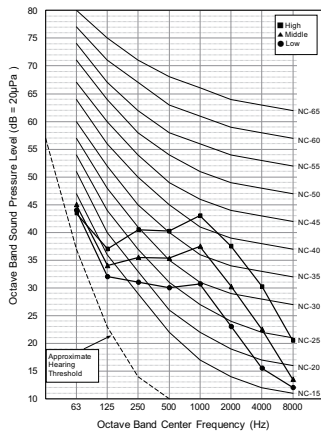

ARNU30GSVA4

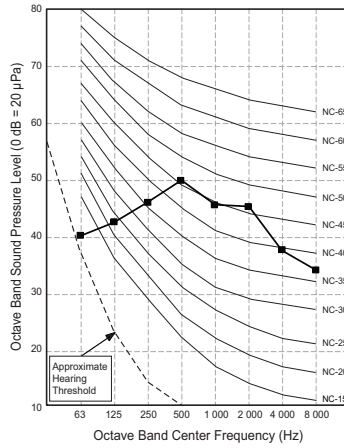

ARNU36GSVA4

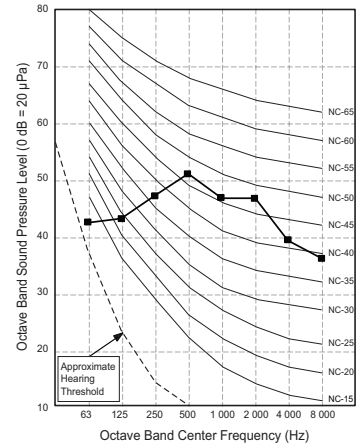

9. Sound Levels

9.2 Sound Power Levels

Note

- Data is valid at diffuse field condition
- Data is valid at nominal operating condition
- Sound level can be increased in static pressure mode or used air guide.
- Sound level will vary depending on a range of factors such as the construction (acoustic absorption coefficient) of particular room in which the equipment is installed.
- Reference acoustic intensity 0dB = $10E-6\mu W/m^2$
- Sound power level is measured on the rated condition in the semi-anechoic rooms by ISO 9614 standard. Therefore, these values can be increased owing to ambient conditions during operation.

Model	Sound Power Levels [dB(A)]		
	High	Middle	Low
ARNU05GSJ*4	45	43	42
ARNU07GSJ*4	46	45	42
ARNU09GSJ*4	48	46	42
ARNU12GSJ*4	51	48	45
ARNU15GSJ*4	55	52	45
ARNU18GSK*4	59	56	52
ARNU24GSK*4	63	56	52
ARNU30GSVA4	60	60	56
ARNU36GSVA4	63	60	58

ARNU05GSJ*4

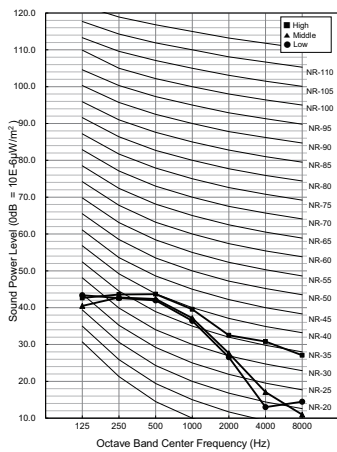

ARNU07GSJ*4

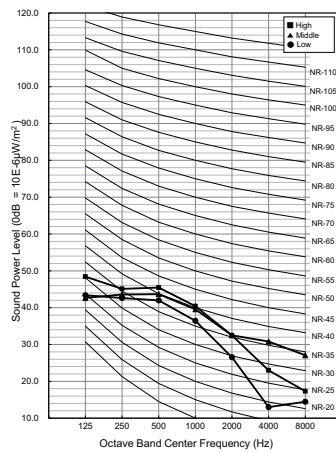

ARNU09GSJ*4

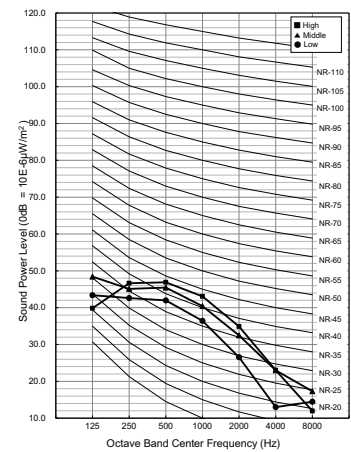

9. Sound Levels

ARNU12GSJ*4

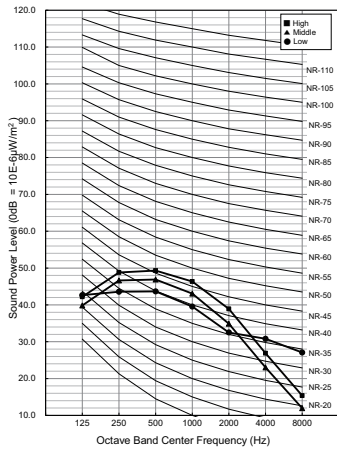

ARNU15GSJ*4

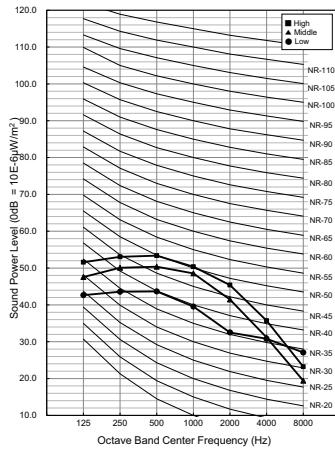

ARNU18GSK*4

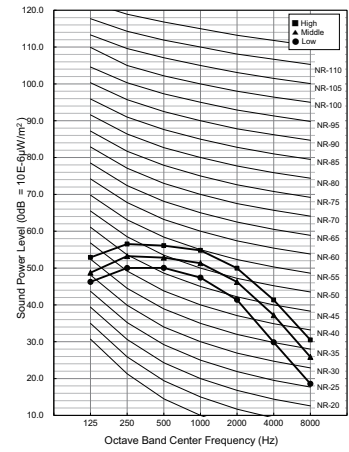

ARNU24GSK*4

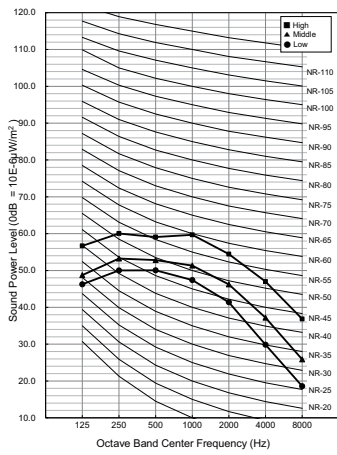

ARNU30GSVA4

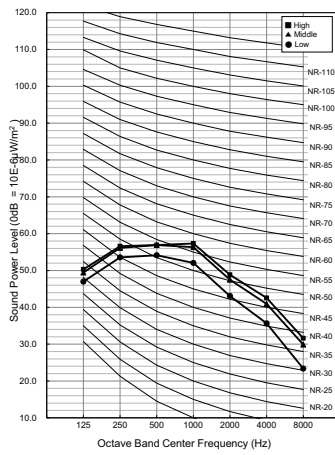

ARNU36GSVA4

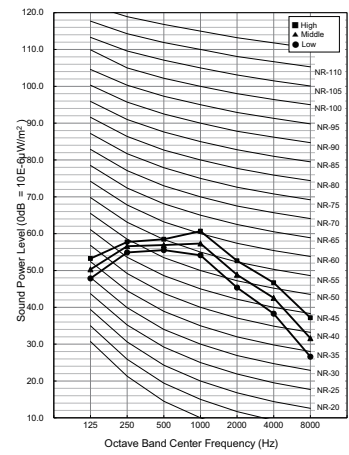

MULTI V™
Indoor Unit

ARTCOOL (Mirror)

- 1. List of functions**
- 2. Specifications**
- 3. Dimensions**
- 4. Piping Diagrams**
- 5. Wiring Diagrams**
- 6. Capacity Tables**
- 7. Air Velocity and Temperature Distribution**
- 8. Electric Characteristics**
- 9. Sound Levels**

1. List of functions

Category	Function	ARNU05GSJR4, ARNU07GSJR4, ARNU09GSJR4, ARNU12GSJR4, ARNU15GSJR4, ARNU18GSKR4, ARNU24GSKR4
Air Flow	Air Supply Outlet	1
	Airflow Direction Control (left & right)	Manual
	Airflow Direction Control (up & down)	Auto
	Auto Swing (left & right)	X
	Auto Swing (up & down)	Auto
	Airflow Steps (fan/cool/heat)	4 / 5 / 5
	Fan Speed Auto*	Advanced
	Power Cool/Heat	O / O
	Swirl Wind*	-
	Refresh Mode**	X
	Smart Mode**	X
	Indirect Wind*	O
	Direct Wind*	O
	Dry Operation	O
Air Purification	Air Purify	X
	Ionizer	O
	UV-C	X
	Pre-Filter	O
Reliability	Hot Start	O
	Self Diagnosis	O
Convenience	Auto Mode	O
	Auto Dry Operation	O
	Auto Restart	O
	Child Lock*	O
	Forced Operation	O
	Group Control*	O
	Sleep Timer	O
	Turn On/Off Reservation	O
	Schedule*	O
	Two Thermistor Control*	O
External On/Off	O	
Installation	Drain Pump	X
	E.S.P. Control*	X
	High Ceiling Operation*	-
Special Functions	Wi-Fi	O
	Auto Elevation Grille	X
	Human Detection Function**	X
	Floor Detection Function**	X

Note

- O : Applied, X : Not Applied, - : Unconfirmed or irrelevant
 Embedded : A kit is provided by default for using this function when the product is manufactured.
 Accessory : Ordered and purchased separately the accessory package referring to the model name provided and install at field. Accessory line-ups varies by region, so check your local catalogue or local sales material.
- Some functions can be limited by remote controller.
- In case of cassette type indoor units, Air Purification Kit and Auto Elevation Grille functions are not applicable at the same time.
- 'Auto Mode' varies depending on the outdoor unit type.
 - Auto Change Over(Heat Recovery Outdoor Unit)
 - Auto Mode Select(Heat Pump Outdoor Unit)
 - Auto Intensity Control(Cooling Only Outdoor Unit)
- * : These functions need to connect the wired remote controller.
- ** : This functions need to connect to the Standard III wired remote controller.

1. List of functions

■ Accessory Compatibility List

Category	Accessory Name	Model Name	Description	ARNU-GSJ(K)R4
Remote Controller	Wired - Premium	PREMTA000	-	○
		PREMTA000A	-	○
		PREMTA000B	-	○
	Wired - RS3 (Standard III)	PREMTB100/PREMTB101	White	○
		PREMTBB10/PREMTBB11	Black	○
	Wired - RS2 (Standard II)	PREMTB001	White	○
		PREMTBB01	Black	○
	Wired - Simple	PQRCVCL0QW	White	○
		PQRCVCL0Q	Black	○
	Wired - Simple for Hotel	PQRCHCA0QW	White	○
		PQRCHCA0Q	Black	○
	Wireless	PQWRCQ0FDB	For Cooling only	○
		PQWRHQ0FDB	For Heat pump	○
PWLSSB21C		For Cooling only	○	
PWLSSB21H		For Heat pump	○	
Dry Contact	Simple	PDRYCB000	1 input port, AC 220 - 240V	○
		PDRYCB100	1 input port, AC 24V	○
	Communication	PDRYCB400	2 input port	○
		PDRYCB300	8 input port, For 3rd party Thermostat	○
		PDRYCB320	8 input port, For 3rd Party Thermostat (Analog Input)	○
PDRYCB500	For 3rd Party Controller (Modbus RTU)	○		
Integration Device	Remote Temperature sensor	PQRSTA0	-	X
	Group Control wire	PZCWRCG3	Cable Assembly for group control (Y-type cable : 0.25m, cable : 9.6m)	○
ETC	Extension wire	PZCWRC1	Extension wire for IDU-wired remote controller (9.6m)	○
	2-Remo Control Wire	PZCWRC2	-	○
	Wi-Fi Modem	PWFMDD200	-	Embedded
	Wi-Fi Extension cable	PWYREW000	USB Extension cable : 10 m	○
	Independent Power Module	PRIP0	-	○
	Multi-tenant Power Module	PINPMB001	-	○
	Refrigerant Leakage Detector	PRLDNVS0	For R410A only	○
	Human Detection Sensor	PTVSMA0	For Cassette 4-way	X
		PTVSA0	For Cassette Dual Vane 4-way	X
	Floor Detection Sensor	PTFSMA0	-	X
	Auto Elevation Grille	PTEGM0	For TP/TN/TM	X
	Air Purification Kit	PTAHTP0	For Cassette 1-way	X
		PTAHMP0	For Cassette 4-way	X
		PTAHYP0	For Cassette Round	X
	EEV Kit	PRGK024A0	For Multi V Indoor Unit	○
	Auxiliary Heater Relay Kit	PRARS1	For Wall Mounted and Art Cool Indoor Units	○
		PRARH1	For Cassette and Duct Indoor Units	X
	Ventilation Kit	PTVK430	For TR/TQ/TP/TN/TM	X
		PTVK410 + PTVK420	For TP/TN/TM	X
Cassette Cover	PTDCQ	For TR/TQ	X	
	PTDCM	For TP/TN/TM	X	
	PTDCA	For TM-A/TP-B	X	

Note

1. ○: Possible, X: Impossible, -: Not applicable, Embedded : Included with product.
2. If there is a difference in development time between the product and the remote controller, some functions cannot be operated.
3. If using Wi-Fi controller, Some advanced functions controlled by remote controller cannot be operated.
4. If you need more detail, please refer to the **BECON** PDB or the manual of product. (<http://partner.lge.com/global> : Home> Doc.Library> Product > Control(BECON))

2. Specifications

Type			ARTCOOL Mirror	
Model		Unit	ARNU05GSJR4	ARNU07GSJR4
Cooling Capacity		kW	1.6	2.2
		kcal/h	1,400	1,900
		Btu/h	5,500	7,500
Heating Capacity		kW	1.8	2.5
		kcal/h	1,500	2,200
		Btu/h	6,100	8,500
Power Input (H / M / L)		W	11 / 10 / 9	12 / 11 / 9
Dimensions (W×H×D)	Body	mm	837 × 308 × 192	837 × 308 × 192
		inch	32-15/16 × 12-1/8 × 7-9/16	32-15/16 × 12-1/8 × 7-9/16
	Shipping	mm	892 × 381 × 249	892 × 381 × 249
		inch	35-1/8 x 15 x 9-13/16	35-1/8 x 15 x 9-13/16
Coil	Rows × Columns × FPI		2 × 15 × 19	2 × 15 × 19
	Face Area	m ²	0.19	0.19
Fan	Type		Cross Flow Fan	Cross Flow Fan
	Motor Output × Number		W	30 × 1
	Air Flow Rate(H / M / L)	m ³ /min	6.8 / 6.5 / 5.9	7.2 / 6.8 / 5.9
		ft ³ /min	240 / 230 / 208	254 / 240 / 208
	Drive		Direct	Direct
Motor type		BLDC	BLDC	
Temperature Control			Microprocessor, Thermostat for cooling and heating	
Sound Absorbing Thermal Insulation Material			Foamed polystyrene	Foamed polystyrene
Air Filter			Resin Net(washable)	Resin Net(washable)
Safety Device			Fuse	Fuse
Pipe Connections	Liquid Side	mm (inch)	Ø 6.35 (1/4)	Ø 6.35 (1/4)
	Gas Side	mm (inch)	Ø 12.7 (1/2)	Ø 12.7 (1/2)
	Drain Pipe(ID)	mm (inch)	16 (5/8)	16 (5/8)
Weight	Body	kg (lbs)	9.2(20.2)	9.2(20.2)
	Shipping	kg (lbs)	12.0(26.5)	12.0(26.5)
Sound Pressure Levels (H / M / L)		dB(A)	30 / 29 / 28	32 / 30 / 28
Sound Power Levels (H / M / L)		dB(A)	45 / 43 / 42	46 / 45 / 42
Power Supply		Ø, V, Hz	1, 220 - 230 - 240, 50/60	1, 220 - 230 - 240, 50/60
Running Current by voltage	Rated	A	0.10 - 0.09 - 0.09	0.10 - 0.10 - 0.10
Maximum Running Current		A	0.25	0.25
Refrigerant	Type		R410A / R32	R410A / R32
	Additional Charging Amount (CF Value of IDU)		kg(each)	0.24 / 0.20
	Control		-	EEV
Transmission cable		mm ²	1.0 ~ 1.5 × 2C	1.0 ~ 1.5 × 2C
Color			Mirror	Mirror
Note				
1. Due to our policy of innovation some specifications may be changed without notification.				
2. Wiring cable size must comply with the applicable local and national code. And "Electric characteristics" chapter should be considered for electrical work and design. Especially the power cable and circuit breaker should be selected in accordance with that.				
3. Sound pressure level is measured on the rated condition in the anechoic rooms by ISO 3745 standard. Sound power level is measured on the rated condition in the semi-anechoic rooms by ISO 9614 standard. Therefore, these values can be increased owing to ambient conditions during operation.				
4. Capacities are net capacities and based on the following conditions. Refer to the Outdoor Unit Specifications for calculating the real capacity. <ul style="list-style-type: none"> • Cooling : Indoor Ambient Temp. 27°CDB / 19°CWB, Outdoor Ambient Temp. 35°CDB / 24°CWB • Heating : Indoor Ambient Temp. 20°CDB / 15°CWB, Outdoor Ambient Temp. 7°CDB / 6°CWB • Interconnected Pipe is standard length and difference of Elevation (Outdoor ~ Indoor Unit) is 0m. 				
5. Refrigerant information (type, additional charging amount, etc.) must be applied by refrigerant type of the combined outdoor unit. Adapt after checking the specifications of outdoor unit.				

2. Specifications

Type			ARTCOOL Mirror	
Model		Unit	ARNU09GSJR4	ARNU12GSJR4
Cooling Capacity		kW	2.8	3.6
		kcal/h	2,400	3,100
		Btu/h	9,600	12,300
Heating Capacity		kW	3.2	4.0
		kcal/h	2,800	3,400
		Btu/h	10,900	13,600
Power Input (H / M / L)		W	13 / 12 / 9	15 / 13 / 11
Dimensions (W×H×D)	Body	mm	837 × 308 × 192	837 × 308 × 192
		inch	32-15/16 × 12-1/8 × 7-9/16	32-15/16 × 12-1/8 × 7-9/16
	Shipping	mm	892 × 381 × 249	892 × 381 × 249
		inch	35-1/8 x 15 x 9-13/16	35-1/8 x 15 x 9-13/16
Coil	Rows × Columns × FPI		2 × 15 × 19	2 × 15 × 19
	Face Area	m ²	0.19	0.19
Fan	Type		Cross Flow Fan	Cross Flow Fan
	Motor Output × Number		W	30 × 1
	Air Flow Rate(H / M / L)	m ³ /min	7.8 / 7.2 / 5.9	8.5 / 7.8 / 6.8
		ft ³ /min	275 / 254 / 208	300 / 254 / 240
	Drive		Direct	Direct
Motor type		BLDC	BLDC	
Temperature Control			Microprocessor, Thermostat for cooling and heating	
Sound Absorbing Thermal Insulation Material			Foamed polystyrene	Foamed polystyrene
Air Filter			Resin Net(washable)	Resin Net(washable)
Safety Device			Fuse	Fuse
Pipe Connections	Liquid Side	mm (inch)	Ø 6.35 (1/4)	Ø 6.35 (1/4)
	Gas Side	mm (inch)	Ø 12.7 (1/2)	Ø 12.7 (1/2)
	Drain Pipe(ID)	mm (inch)	16 (5/8)	16 (5/8)
Weight	Body	kg (lbs)	9.2(20.2)	9.2(20.2)
	Shipping	kg (lbs)	12.0(26.5)	12.0(26.5)
Sound Pressure Levels (H / M / L)		dB(A)	34 / 32 / 28	37 / 34 / 30
Sound Power Levels (H / M / L)		dB(A)	48 / 46 / 42	51 / 48 / 45
Power Supply		Ø, V, Hz	1, 220 - 230 - 240, 50/60	1, 220 - 230 - 240, 50/60
Running Current by voltage	Rated	A	0.11 - 0.11 - 0.10	0.13 - 0.13 - 0.12
Maximum Running Current		A	0.25	0.25
Refrigerant	Type		-	R410A / R32
	Additional Charging Amount (CF Value of IDU)		kg(each)	0.24 / 0.20
	Control		-	EEV
Transmission cable		mm ²	1.0 ~ 1.5 × 2C	1.0 ~ 1.5 × 2C
Color			Mirror	Mirror

Note

- Due to our policy of innovation some specifications may be changed without notification.
- Wiring cable size must comply with the applicable local and national code. And "Electric characteristics" chapter should be considered for electrical work and design. Especially the power cable and circuit breaker should be selected in accordance with that.
- Sound pressure level is measured on the rated condition in the anechoic rooms by ISO 3745 standard.
Sound power level is measured on the rated condition in the semi-anechoic rooms by ISO 9614 standard.
Therefore, these values can be increased owing to ambient conditions during operation.
- Capacities are net capacities and based on the following conditions. Refer to the Outdoor Unit Specifications for calculating the real capacity.
 - Cooling : Indoor Ambient Temp. 27°CDB / 19°CWB, Outdoor Ambient Temp. 35°CDB / 24°CWB
 - Heating : Indoor Ambient Temp. 20°CDB / 15°CWB, Outdoor Ambient Temp. 7°CDB / 6°CWB
 - Interconnected Pipe is standard length and difference of Elevation (Outdoor ~ Indoor Unit) is 0m.
- Refrigerant information (type, additional charging amount, etc.) must be applied by refrigerant type of the combined outdoor unit.
Adapt after checking the specifications of outdoor unit.

2. Specifications

Type		ARTCOOL Mirror	
Model	Unit	ARNU15GSJR4	
Cooling Capacity	kW	4.5	
	kcal/h	3,900	
	Btu/h	15,400	
Heating Capacity	kW	5.0	
	kcal/h	4,300	
	Btu/h	17,100	
Power Input (H / M / L)		W	23 / 18 / 11
Dimensions (W×H×D)	Body	mm	837 × 308 × 192
		inch	32-15/16 × 12-1/8 × 7-9/16
	Shipping	mm	892 × 381 × 249
		inch	35-1/8 x 15 x 9-13/16
Coil	Rows × Columns × FPI		2 × 15 × 19
	Face Area	m ²	0.19
Fan	Type		Cross Flow Fan
	Motor Output × Number	W	30 × 1
	Air Flow Rate(H / M / L)	m ³ /min	10.5 / 9.5 / 6.8
		ft ³ /min	371 / 336 / 240
	Drive		Direct
Motor type		BLDC	
Temperature Control			Microprocessor, Thermostat for cooling and heating
Sound Absorbing Thermal Insulation Material			Foamed polystyrene
Air Filter			Resin Net(washable)
Safety Device			Fuse
Pipe Connections	Liquid Side	mm (inch)	Ø 6.35 (1/4)
	Gas Side	mm (inch)	Ø 12.7 (1/2)
	Drain Pipe(ID)	mm (inch)	16 (5/8)
Weight	Body	kg (lbs)	9.2(20.2)
	Shipping	kg (lbs)	12.0(26.5)
Sound Pressure Levels (H / M / L)		dB(A)	42 / 39 / 32
Sound Power Levels (H / M / L)		dB(A)	55 / 52 / 44
Power Supply		Ø, V, Hz	1, 220 - 230 - 240, 50/60
Running Current by voltage	Rated	A	0.20 - 0.19 - 0.18
Maximum Running Current		A	0.25
Refrigerant	Type		R410A / R32
	Additional Charging Amount (CF Value of IDU)	kg(each)	0.24 / 0.20
	Control		EEV
Transmission cable		mm ²	1.0 ~ 1.5 × 2C
Color			Mirror
Note			
1. Due to our policy of innovation some specifications may be changed without notification.			
2. Wiring cable size must comply with the applicable local and national code. And "Electric characteristics" chapter should be considered for electrical work and design. Especially the power cable and circuit breaker should be selected in accordance with that.			
3. Sound pressure level is measured on the rated condition in the anechoic rooms by ISO 3745 standard. Sound power level is measured on the rated condition in the semi-anechoic rooms by ISO 9614 standard. Therefore, these values can be increased owing to ambient conditions during operation.			
4. Capacities are net capacities and based on the following conditions. Refer to the Outdoor Unit Specifications for calculating the real capacity. <ul style="list-style-type: none"> • Cooling : Indoor Ambient Temp. 27°CDB / 19°CWB, Outdoor Ambient Temp. 35°CDB / 24°CWB • Heating : Indoor Ambient Temp. 20°CDB / 15°CWB, Outdoor Ambient Temp. 7°CDB / 6°CWB • Interconnected Pipe is standard length and difference of Elevation (Outdoor ~ Indoor Unit) is 0m. 			
5. Refrigerant information (type, additional charging amount, etc.) must be applied by refrigerant type of the combined outdoor unit. Adapt after checking the specifications of outdoor unit.			

2. Specifications

Type		ARTCOOL Mirror			
Model	Unit	ARNU18GSKR4	ARNU24GSKR4		
Cooling Capacity	kW	5.6	7.1		
	kcal/h	4,800	6,100		
	Btu/h	19,100	24,200		
Heating Capacity	kW	6.3	7.5		
	kcal/h	5,400	6,400		
	Btu/h	21,500	25,600		
Power Input (H / M / L)		W	32 / 26 / 16	39 / 26 / 16	
Dimensions (W×H×D)	Body	mm	998 × 345 × 212	998 × 345 × 212	
		inch	39-9/32 × 13-19/32 × 8-11/32	39-9/32 × 13-19/32 × 8-11/32	
	Shipping	mm	1,063 × 420 × 274	1,063 × 420 × 274	
		inch	41-27/32 x 16-17/32 x 10-25/32	41-27/32 x 16-17/32 x 10-25/32	
Coil	Rows × Columns × FPI		2 × 16 × 20	2 × 16 × 20	
	Face Area	m ²	0.25	0.25	
Fan	Type		Cross Flow Fan	Cross Flow Fan	
	Motor Output × Number		W	58 × 1	58 × 1
	Air Flow Rate(H / M / L)	m ³ /min	14.0 / 12.0 / 10.5	15.2 / 12.7 / 10.5	
		ft ³ /min	494 / 424 / 371	537 / 449 / 371	
	Drive		Direct	Direct	
Motor type		BLDC	BLDC		
Temperature Control		Microprocessor, Thermostat for cooling and heating			
Sound Absorbing Thermal Insulation Material		Foamed polystyrene	Foamed polystyrene		
Air Filter		Resin Net(washable)	Resin Net(washable)		
Safety Device		Fuse	Fuse		
Pipe Connections	Liquid Side	mm (inch)	Ø6.35 (1/4)	Ø9.52(3/8)	
	Gas Side	mm (inch)	Ø12.7 (1/2)	Ø15.88(5/8)	
	Drain Pipe(ID)	mm (inch)	16 (5/8)	16 (5/8)	
Weight	Body	kg (lbs)	13.4(29.5)	13.4(29.5)	
	Shipping	kg (lbs)	17.2(37.9)	17.2(37.9)	
Sound Pressure Levels (H / M / L)		dB(A)	43 / 39 / 34	46 / 41 / 34	
Sound Power Levels (H / M / L)		dB(A)	59 / 56 / 52	63 / 58 / 52	
Power Supply		Ø, V, Hz	1, 220 - 230 - 240, 50/60	1, 220 - 230 - 240, 50/60	
Running Current by voltage	Rated	A	0.33 - 0.31 - 0.30	0.40 - 0.38 - 0.37	
Maximum Running Current		A	0.52	0.52	
Refrigerant	Type		-	R410A / R32	R410A / R32
	Additional Charging Amount (CF Value of IDU)		kg(each)	0.28 / 0.23	0.28 / 0.23
	Control		-	EEV	EEV
Transmission cable		mm ²	1.0 ~ 1.5 × 2C	1.0 ~ 1.5 × 2C	
Color			Mirror	Mirror	

Note

- Due to our policy of innovation some specifications may be changed without notification.
- Wiring cable size must comply with the applicable local and national code. And "Electric characteristics" chapter should be considered for electrical work and design. Especially the power cable and circuit breaker should be selected in accordance with that.
- Sound pressure level is measured on the rated condition in the anechoic rooms by ISO 3745 standard.
Sound power level is measured on the rated condition in the semi-anechoic rooms by ISO 9614 standard.
Therefore, these values can be increased owing to ambient conditions during operation.
- Capacities are net capacities and based on the following conditions. Refer to the Outdoor Unit Specifications for calculating the real capacity.
 - Cooling : Indoor Ambient Temp. 27°CDB / 19°CWB, Outdoor Ambient Temp. 35°CDB / 24°CWB
 - Heating : Indoor Ambient Temp. 20°CDB / 15°CWB, Outdoor Ambient Temp. 7°CDB / 6°CWB
 - Interconnected Pipe is standard length and difference of Elevation (Outdoor ~ Indoor Unit) is 0m.
- Refrigerant information (type, additional charging amount, etc.) must be applied by refrigerant type of the combined outdoor unit.
Adapt after checking the specifications of outdoor unit.

3. Dimensions

3.1 Dimensional Drawings

[SJ Chassis] ARNU05GSJR4 / ARNU07GSJR4 / ARNU09GSJR4 / ARNU12GSJR4
ARNU15GSJR4

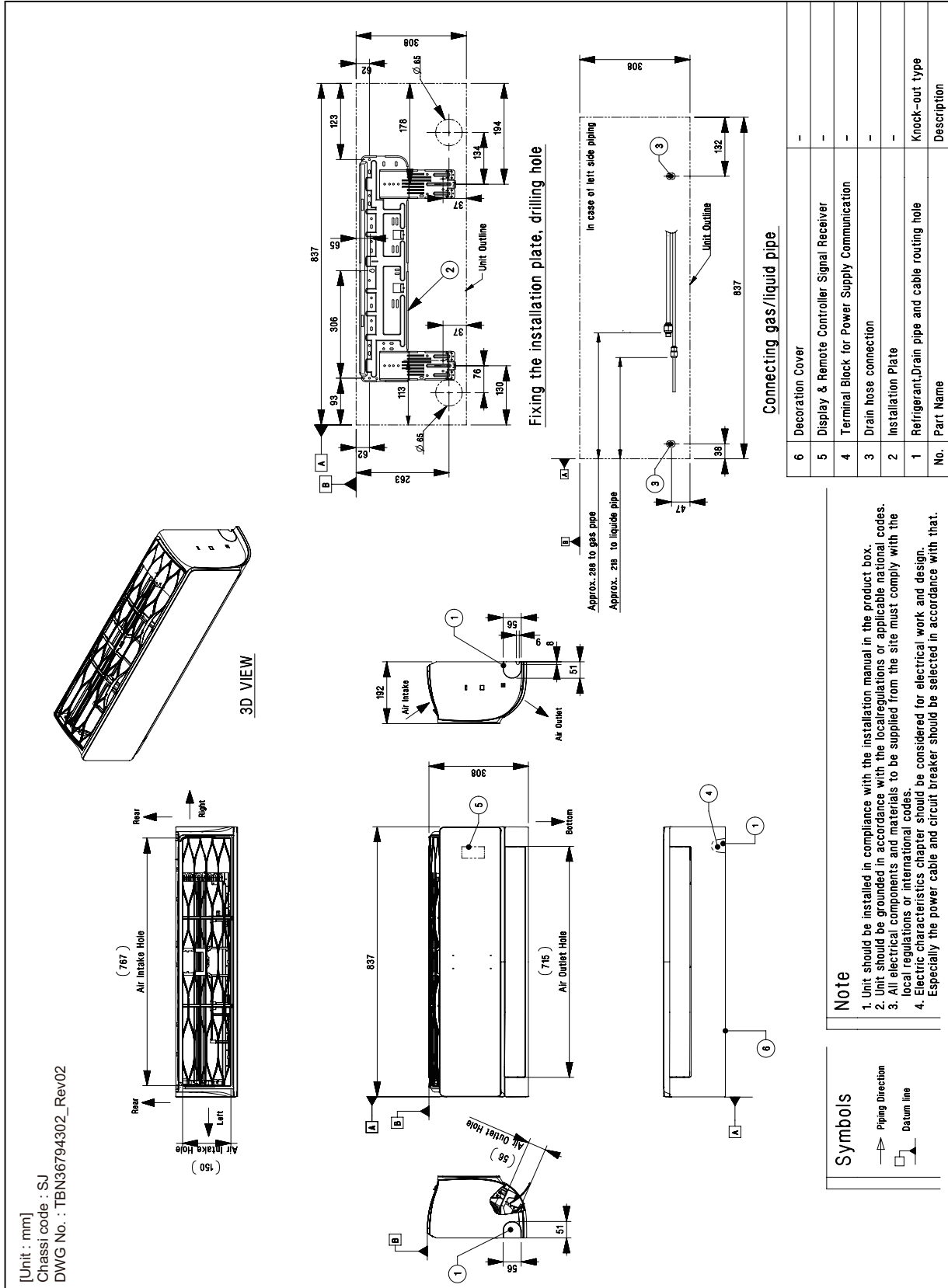

3. Dimensions

[SK Chassis] ARNU18GSKR4 / ARNU24GSKR4

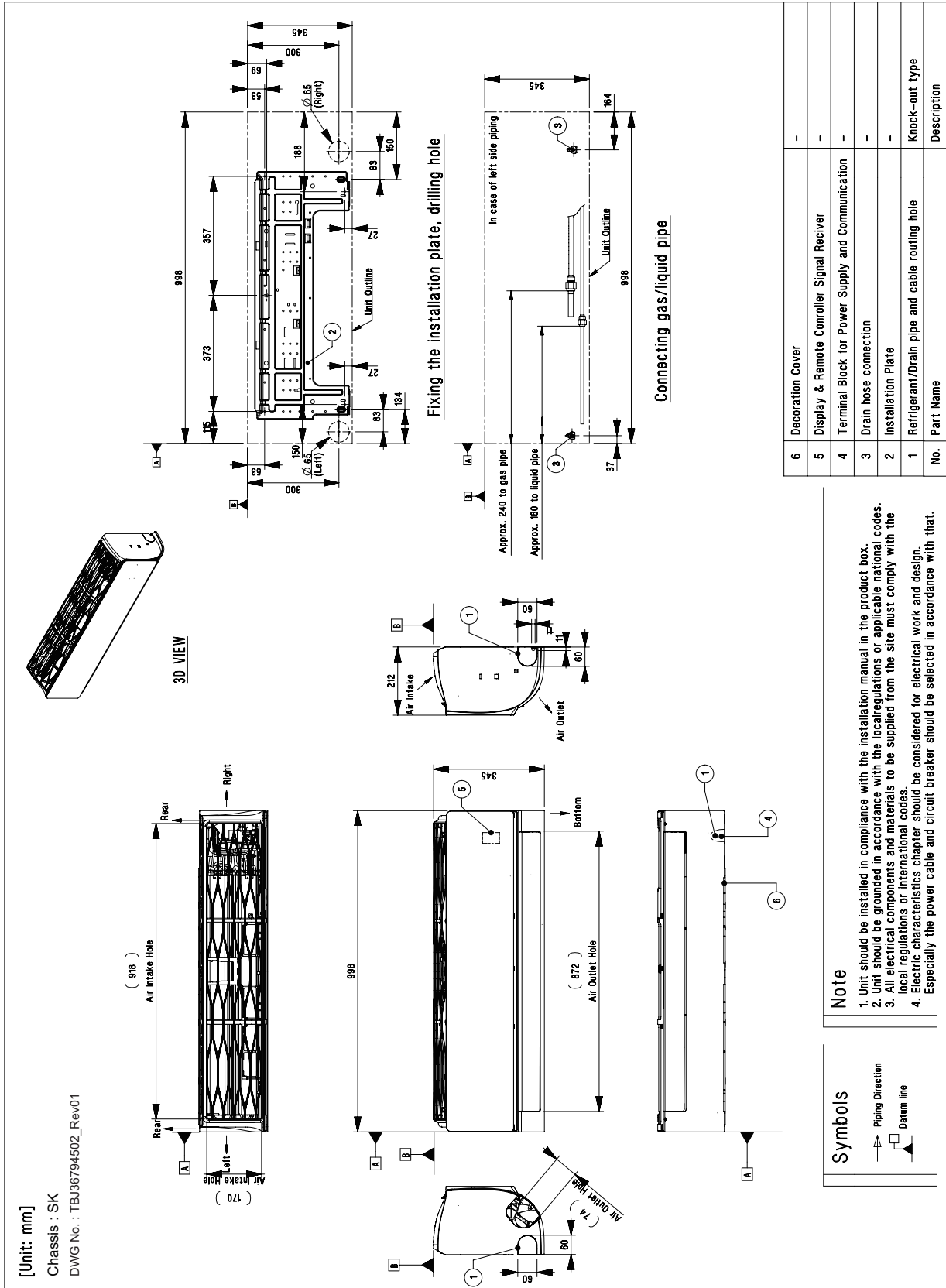

3. Dimensions

3.2 Installation Space

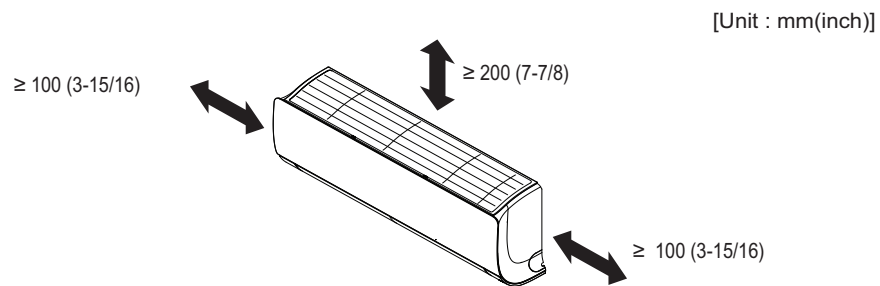

Note

- Places where products are installed should not be any obstacles to the air circulation or installation. Ensure the spaces from the wall, ceiling, or other obstacles.
- According to type of indoor unit, external appearance or installed structure could be different.
- According to product type, model line up, sales region..etc, applicability of each chassis could be different.

4. Piping Diagrams

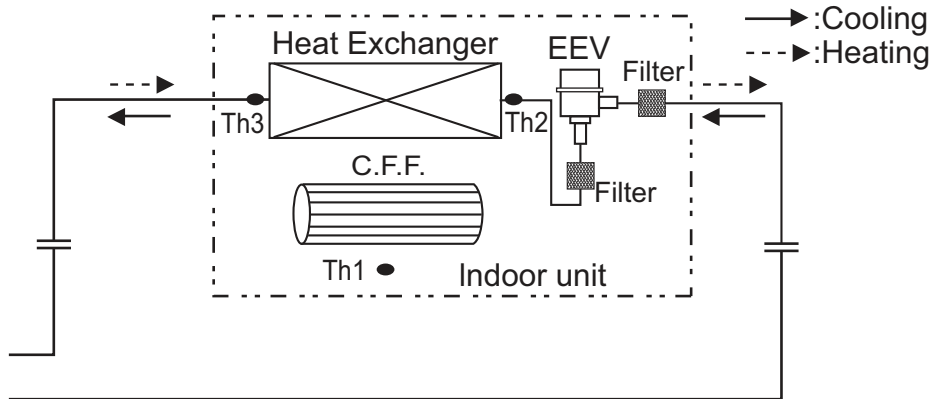

◆ Refrigerant pipe connection port diameter

Model	Gas [mm(inch)]	Liquid [mm(inch)]
ARNU05GSJR4	Ø12.7(1/2)	Ø6.35(1/4)
ARNU07GSJR4	Ø12.7(1/2)	Ø6.35(1/4)
ARNU09GSJR4	Ø12.7(1/2)	Ø6.35(1/4)
ARNU12GSJR4	Ø12.7(1/2)	Ø6.35(1/4)
ARNU15GSJR4	Ø12.7(1/2)	Ø6.35(1/4)
ARNU18GSKR4	Ø12.7(1/2)	Ø6.35(1/4)
ARNU24GSKR4	Ø15.88(5/8)	Ø9.52(3/8)

LOC.	Description
Th1	Room thermistor
Th2	Pipe in thermistor
Th3	Pipe out thermistor

5. Wiring Diagrams

■ SJ/SK Chassis

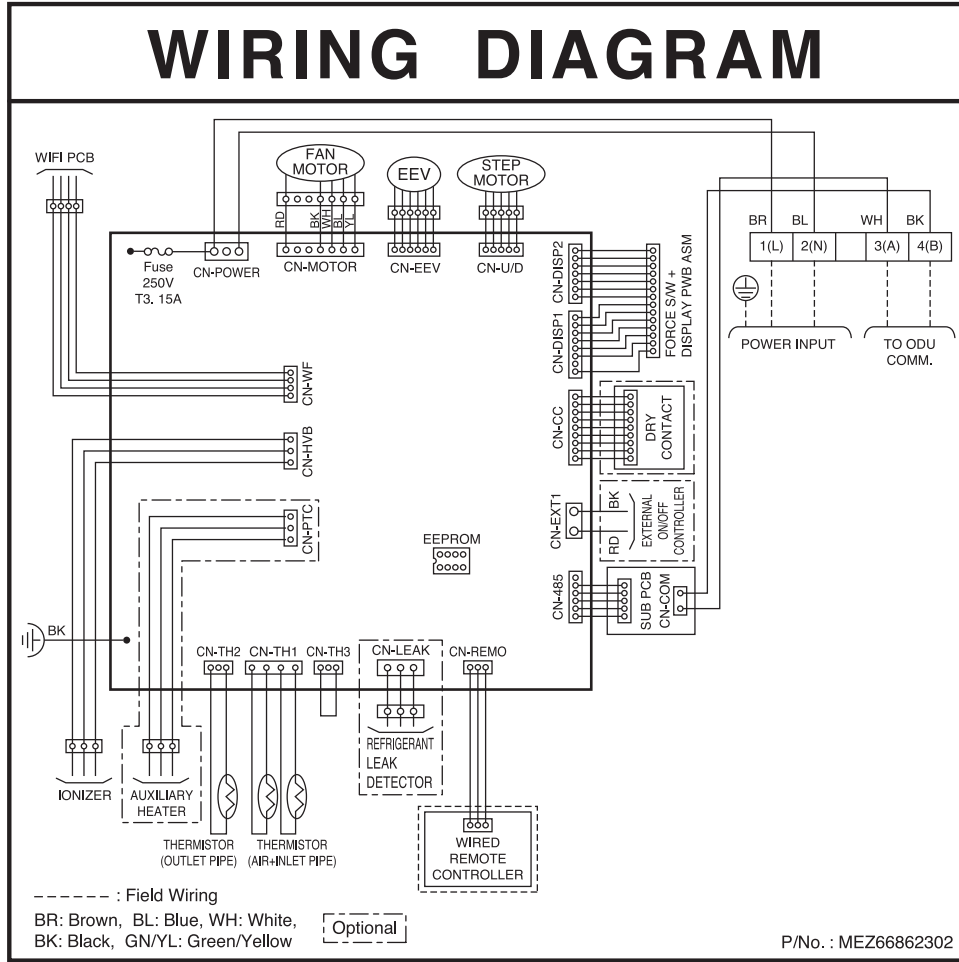

CONNECTOR NUMBER	LOCATION POINT	FUNCTION
CN-POWER	AC Power supply	AC Power line input for indoor
CN-MOTOR	Fan motor output	Motor output of BLDC
CN-485	Communication	Connection between indoor
CN-DISP1	Display	Display of indoor status
CN-DISP2	Display	Display of indoor status
CN-EEV	EEV output	EEV Control output : connect to EEV directly or through IPM(Independent Power Module)
CN-U/D	Step motor	Step motor output
CN-TH1	Room/inlet pipe sensor	Room and inlet pipe thermistor
CN-TH2	Outlet pipe sensor	Outlet pipe thermistor
CN-REMO	Remote controller	Remote control line
CN-CC	Dry contact	Dry contact line
CN-EXT1	External On/Off	External On/Off signal input
CN-LEAK	Refrigerant leak detector	Refrigerant leak detector line
CN-PTC	Auxiliary heater	Auxiliary heater line
CN-WF	WIFI module	WIFI module connection line
CN-HVB	Ionizer module	Ionizer connection line

6. Capacity Tables

■ Cooling Capacity

Nominal Capacity (kBtu/h) [Capacity Index (kW)]	Indoor air temp. (DB/WB, °C)													
	20		23		26		27		28		30		32	
	14		16		18		19		20		22		24	
	TC	SHC	TC	SHC	TC	SHC	TC	SHC	TC	SHC	TC	SHC	TC	SHC
5 [1.6]	1.1	1.1	1.3	1.3	1.5	1.4	1.6	1.4	1.7	1.5	1.7	1.4	1.8	1.3
7 [2.2]	1.5	1.5	1.8	1.6	2.0	1.8	2.2	1.8	2.4	1.9	2.4	1.8	2.4	1.6
9 [2.8]	1.9	1.7	2.2	1.9	2.6	2.1	2.8	2.1	3.0	2.2	3.0	2.1	3.1	1.9
12 [3.6]	2.4	2.0	2.9	2.3	3.3	2.5	3.6	2.6	3.9	2.7	3.9	2.5	4.0	2.3
15 [4.5]	3.0	2.5	3.6	2.9	4.2	3.2	4.5	3.2	4.8	3.4	4.9	3.2	4.9	2.9
18 [5.6]	3.8	3.3	4.5	3.6	5.2	3.9	5.6	4.0	6.0	4.1	6.1	3.9	6.2	3.6
24 [7.1]	4.8	3.9	5.7	4.5	6.6	4.9	7.1	5.0	7.6	5.2	7.7	4.9	7.8	4.5

Note

1. TC: Total Capacity(kW), SHC: Sensible Heat Capacity(kW)
2. Capacity tables show the average value of conditions which may occur.
3. Refer to Capacity tables and correction factor in the outdoor unit PDB for the actual performance data of each indoor unit and outdoor unit combination.

■ Heating Capacity

Nominal Capacity (kBtu/h) [Capacity Index (kW)]	Indoor air temp. (DB, °C)					
	16	18	20	21	22	24
	TC	TC	TC	TC	TC	TC
5 [1.6]	2.0	1.9	1.8	1.7	1.7	1.6
7 [2.2]	2.8	2.7	2.5	2.4	2.3	2.2
9 [2.8]	3.6	3.4	3.2	3.1	3.0	2.8
12 [3.6]	4.5	4.3	4.0	3.9	3.7	3.5
15 [4.5]	5.6	5.3	5.0	4.8	4.7	4.4
18 [5.6]	7.1	6.7	6.3	6.1	5.9	5.5
24 [7.1]	8.5	8.0	7.5	7.3	7.0	6.5

Note

1. TC: Total Capacity(kW)
2. Capacity tables show the average value of conditions which may occur.
3. Refer to Capacity tables and correction factor in the outdoor unit PDB for the actual performance data of each indoor unit and outdoor unit combination.

7. Air Velocity and Temperature Distribution

■ ARNU05GSJR4

◆ Cooling

Side View

Discharge angle: 35°

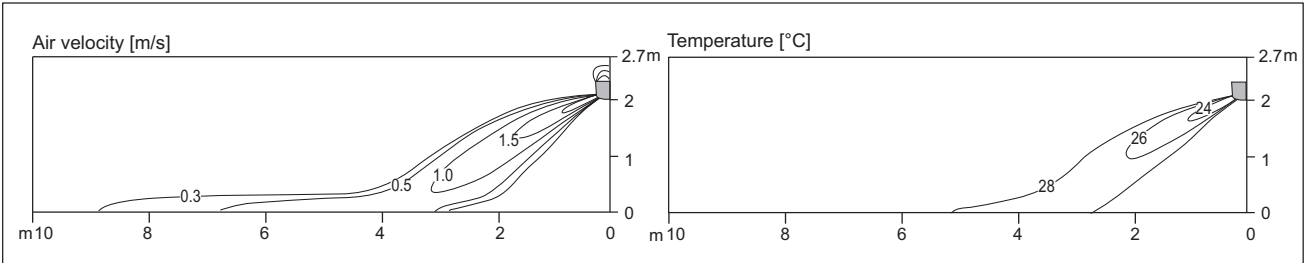

- Vertical Louver : Center
- Vertical Louver angle : 0°
- Fan speed : High

Top View

Discharge angle: 35°

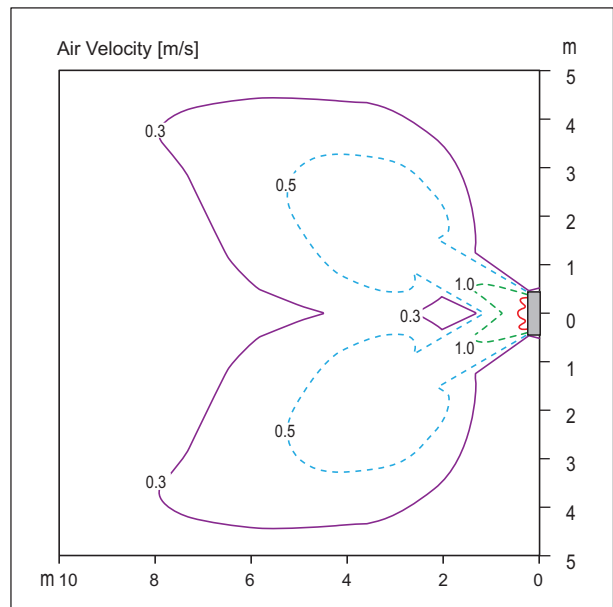
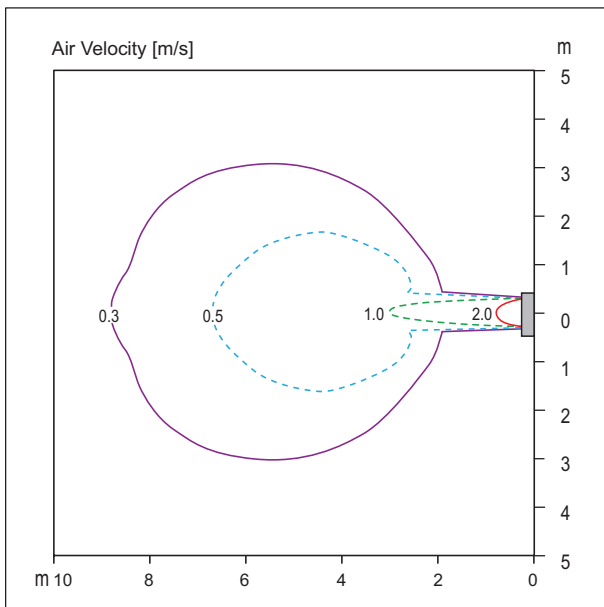

- Vertical Louver : Center
- Vertical Louver angle : 0°
- Air speed 0.3m/s Range : 8.9m
- Fan speed : High

- Vertical Louver : Left & Right
- Vertical Louver angle : 50°
- Air speed 0.3m/s Range : 8m
- Fan speed : High

Note

- These figures are accordance with normal certain condition and environment. (Airflow step is 'High', Air discharge angle is fixed as indicated angle.)
- Indoor airflow distribution under actual installation or operating conditions depends on ambient temperature, ceiling height, product installation direction / location, indoor / Heating load, and other obstacles, etc.

7. Air Velocity and Temperature Distribution

◆ Heating

Side View

Discharge angle: 55°

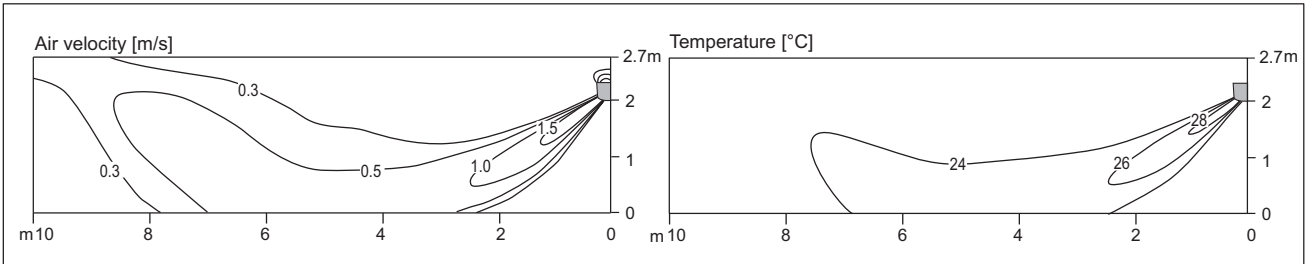

- Vertical Louver : Center
- Vertical Louver angle : 0°
- Fan speed : High

Top View

Discharge angle: 55°

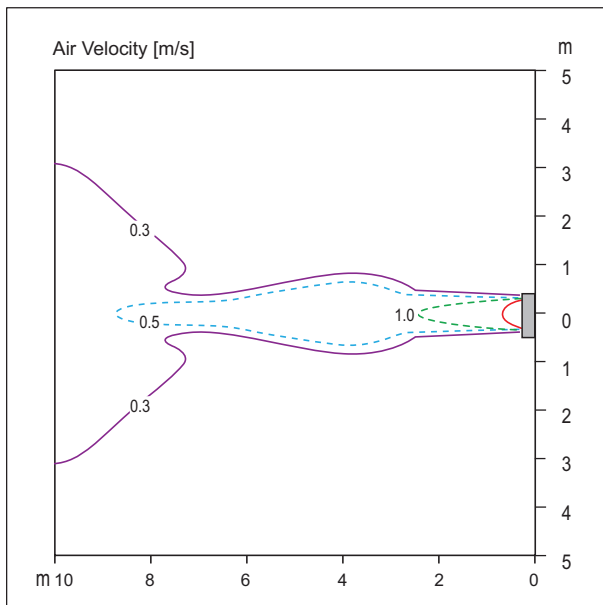

- Vertical Louver : Center
- Vertical Louver angle : 0°
- Air speed 0.3m/s Range : 11.9m
- Fan speed : High

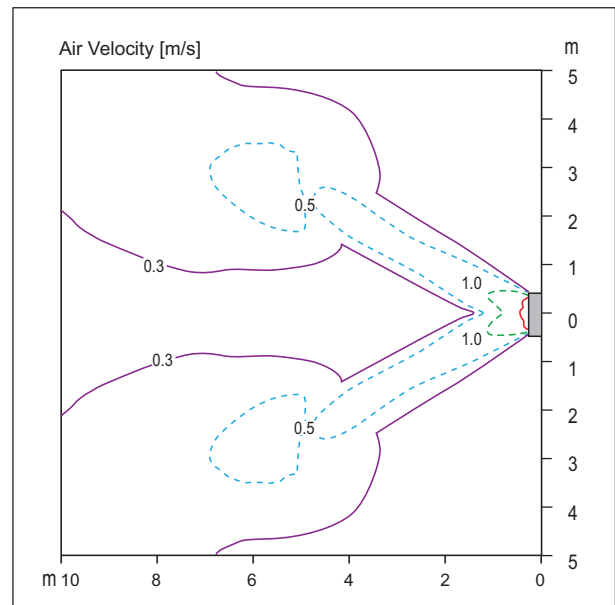

- Vertical Louver : Left & Right
- Vertical Louver angle : 50°
- Air speed 0.3m/s Range : 12.6m
- Fan speed : High

Note

- These figures are accordance with normal certain condition and environment. (Airflow step is 'High', Air discharge angle is fixed as indicated angle.)
- Indoor airflow distribution under actual installation or operating conditions depends on ambient temperature, ceiling height, product installation direction / location, indoor / Heating load, and other obstacles, etc.

7. Air Velocity and Temperature Distribution

■ ARNU07GSJR4

◆ Cooling

Side View

Discharge angle: 35°

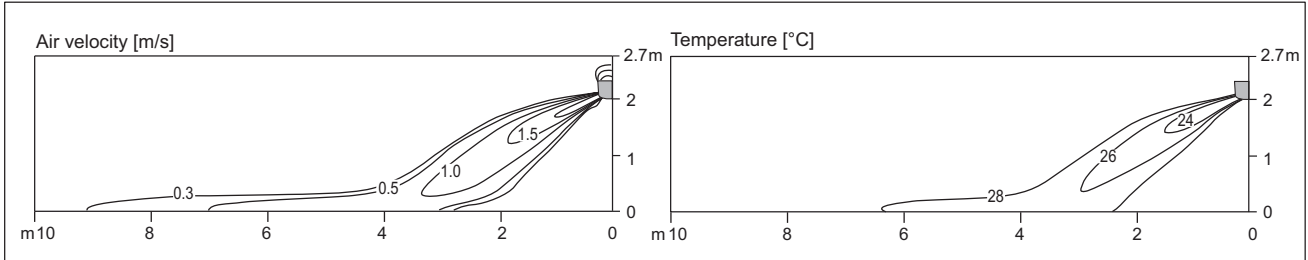

- Vertical Louver : Center
- Vertical Louver angle : 0°
- Fan speed : High

Top View

Discharge angle: 35°

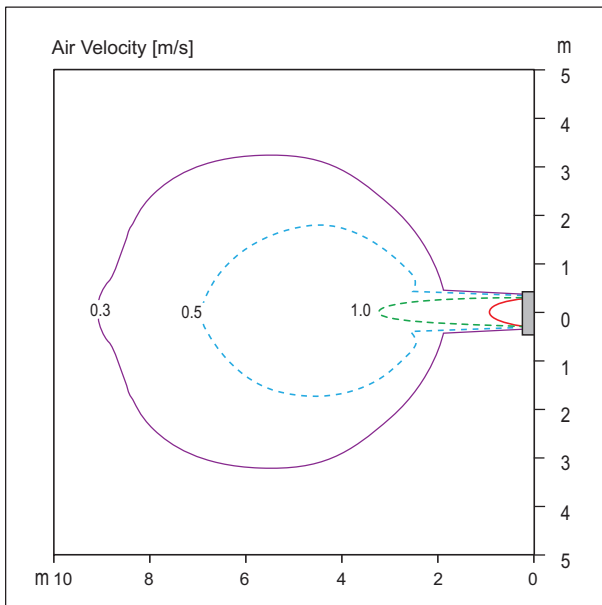

- Vertical Louver : Center
- Vertical Louver angle : 0°
- Air speed 0.3m/s Range : 9.2m
- Fan speed : High

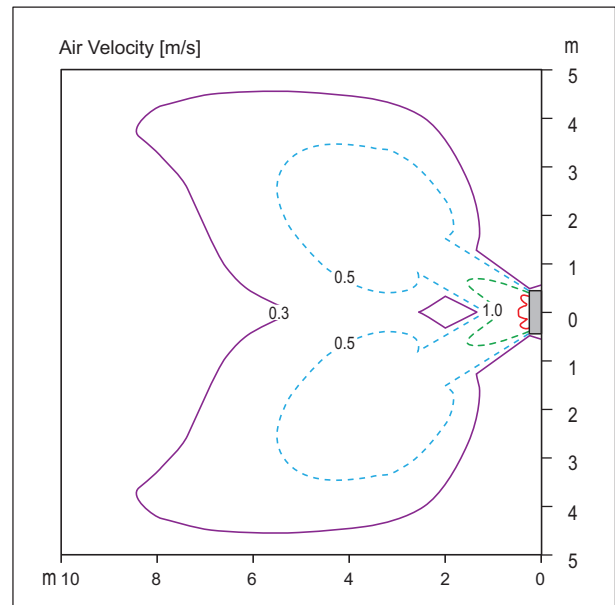

- Vertical Louver : Left & Right
- Vertical Louver angle : 50°
- Air speed 0.3m/s Range : 8.4m
- Fan speed : High

Note

- These figures are accordance with normal certain condition and environment. (Airflow step is 'High', Air discharge angle is fixed as indicated angle.)
- Indoor airflow distribution under actual installation or operating conditions depends on ambient temperature, ceiling height, product installation direction / location, indoor / Heating load, and other obstacles, etc.

7. Air Velocity and Temperature Distribution

◆ Heating

Side View

Discharge angle: 55°

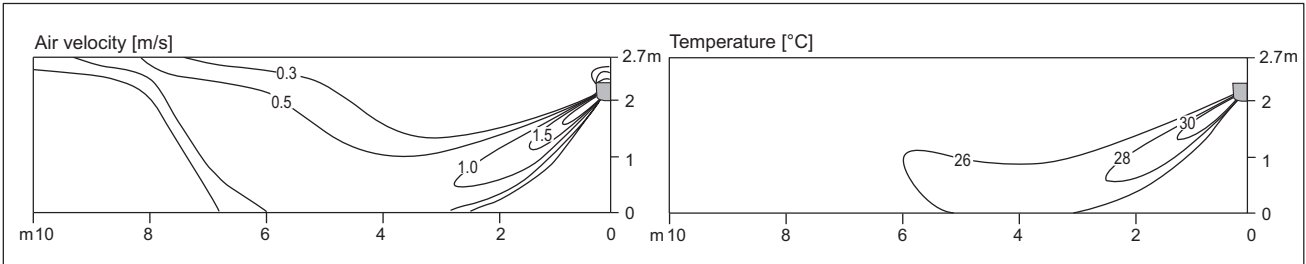

- Vertical Louver : Center
- Vertical Louver angle : 0°
- Fan speed : High

Top View

Discharge angle: 55°

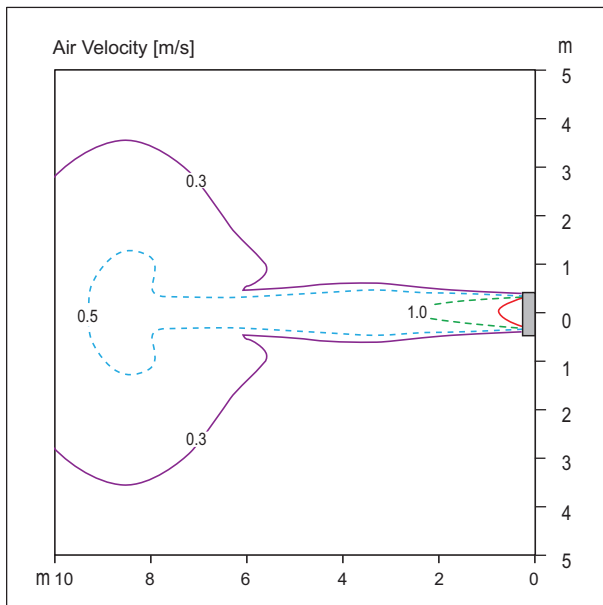

- Vertical Louver : Center
- Vertical Louver angle : 0°
- Air speed 0.3m/s Range : 11m
- Fan speed : High

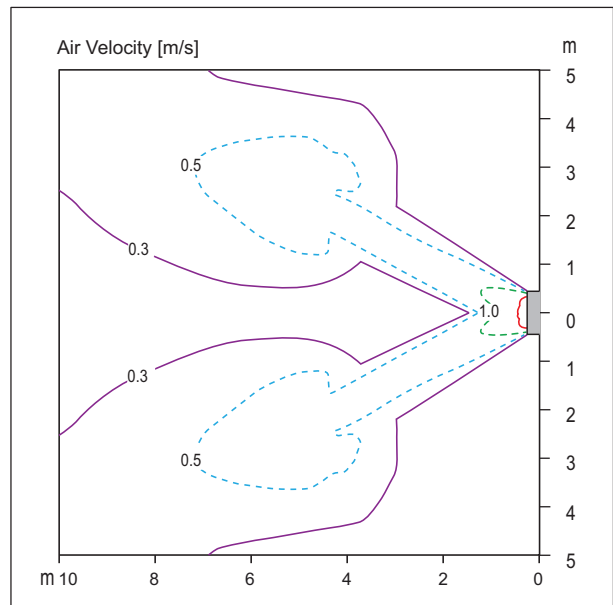

- Vertical Louver : Left & Right
- Vertical Louver angle : 50°
- Air speed 0.3m/s Range : 13.2m
- Fan speed : High

Note

- These figures are accordance with normal certain condition and environment. (Airflow step is 'High', Air discharge angle is fixed as indicated angle.)
- Indoor airflow distribution under actual installation or operating conditions depends on ambient temperature, ceiling height, product installation direction / location, indoor / Heating load, and other obstacles, etc.

7. Air Velocity and Temperature Distribution

■ ARNU09GSJR4

◆ Cooling

Side View

Discharge angle: 35°

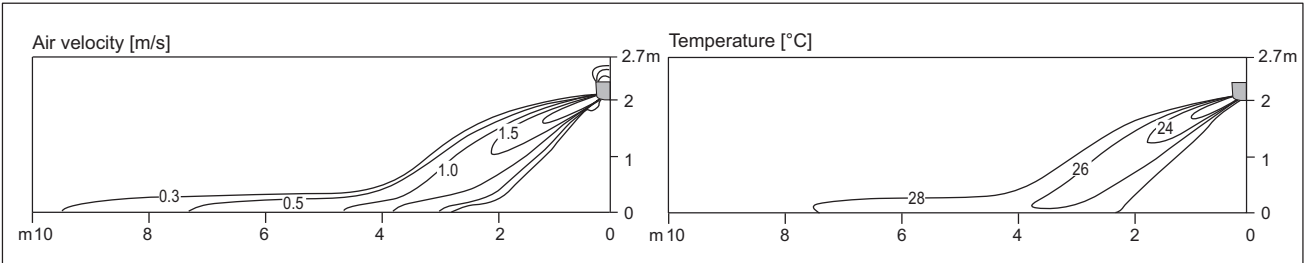

- Vertical Louver : Center
- Vertical Louver angle : 0°
- Fan speed : High

Top View

Discharge angle: 35°

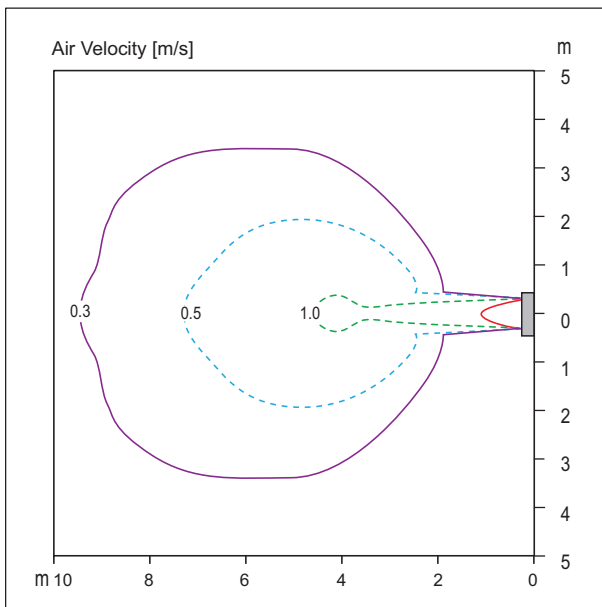

- Vertical Louver : Center
- Vertical Louver angle : 0°
- Air speed 0.3m/s Range : 9.6m
- Fan speed : High

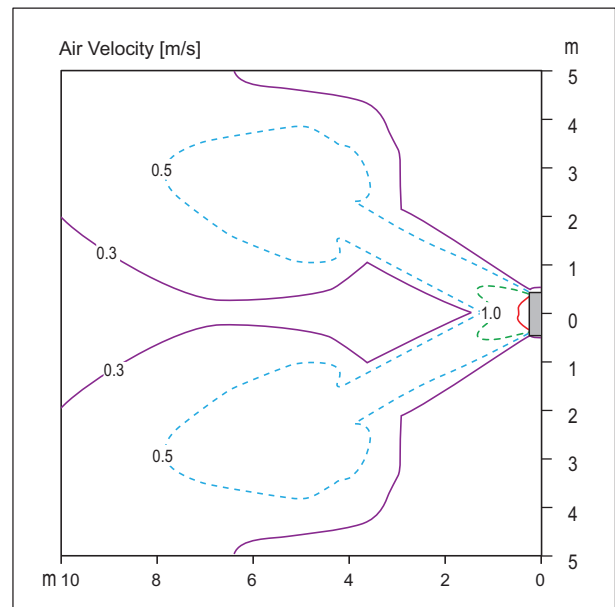

- Vertical Louver : Left & Right
- Vertical Louver angle : 50°
- Air speed 0.3m/s Range : 14m
- Fan speed : High

Note

- These figures are accordance with normal certain condition and environment. (Airflow step is 'High', Air discharge angle is fixed as indicated angle.)
- Indoor airflow distribution under actual installation or operating conditions depends on ambient temperature, ceiling height, product installation direction / location, indoor / Heating load, and other obstacles, etc.

7. Air Velocity and Temperature Distribution

◆ Heating

Side View

Discharge angle: 55°

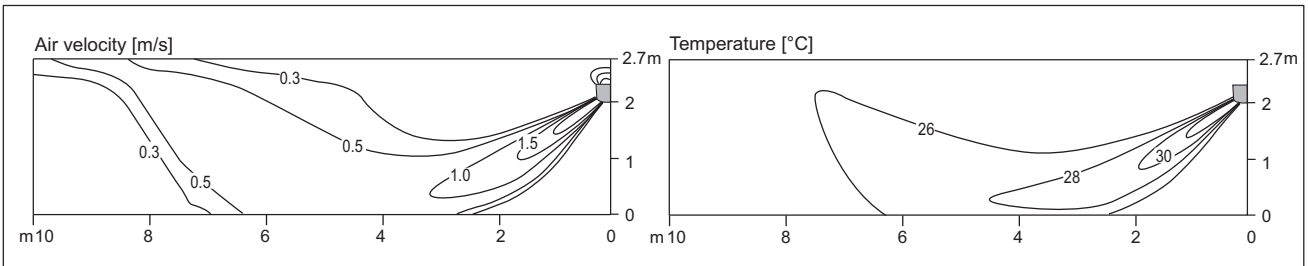

- Vertical Louver : Center
- Vertical Louver angle : 0°
- Fan speed : High

Top View

Discharge angle: 55°

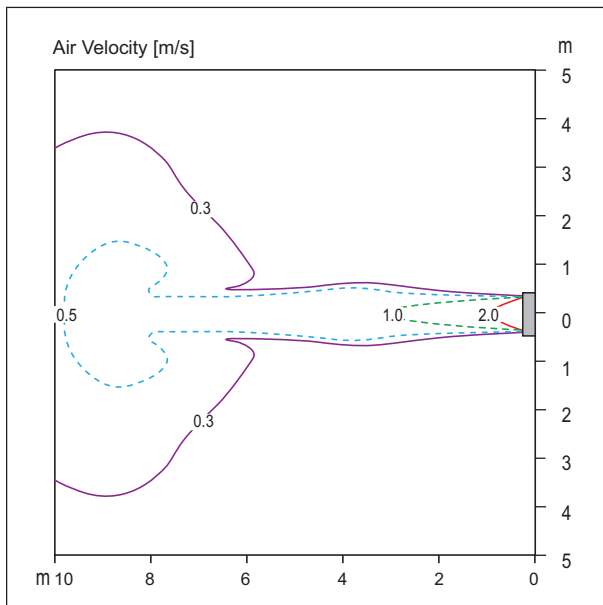

- Vertical Louver : Center
- Vertical Louver angle : 0°
- Air speed 0.3m/s Range : 11.8m
- Fan speed : High

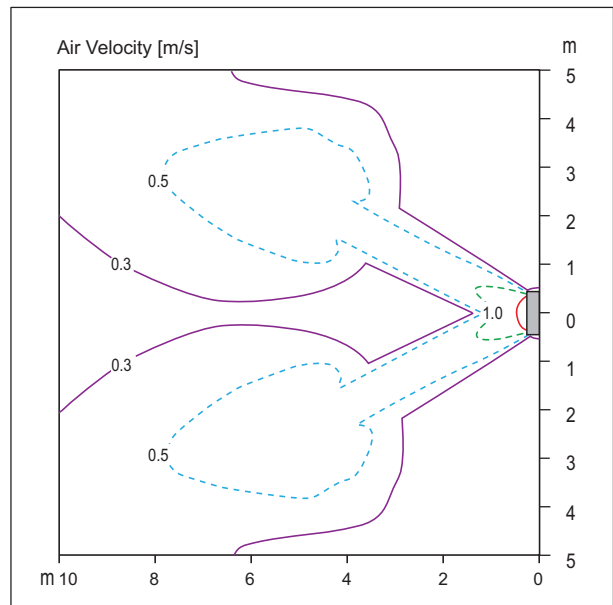

- Vertical Louver : Left & Right
- Vertical Louver angle : 50°
- Air speed 0.3m/s Range : 14m
- Fan speed : High

Note

- These figures are accordance with normal certain condition and environment.
(Airflow step is 'High', Air discharge angle is fixed as indicated angle.)
- Indoor airflow distribution under actual installation or operating conditions depends on ambient temperature, ceiling height, product installation direction / location, indoor / Heating load, and other obstacles, etc.

7. Air Velocity and Temperature Distribution

■ ARNU12GSJR4

◆ Cooling

Side View

Discharge angle: 35°

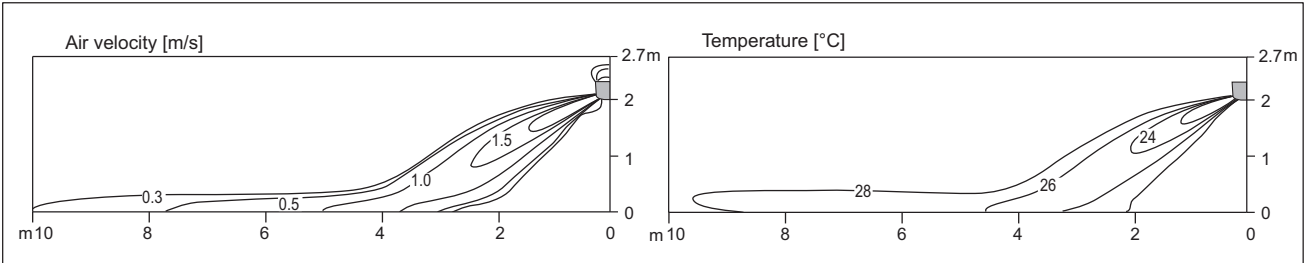

- Vertical Louver : Center
- Vertical Louver angle : 0°
- Fan speed : High

Top View

Discharge angle: 35°

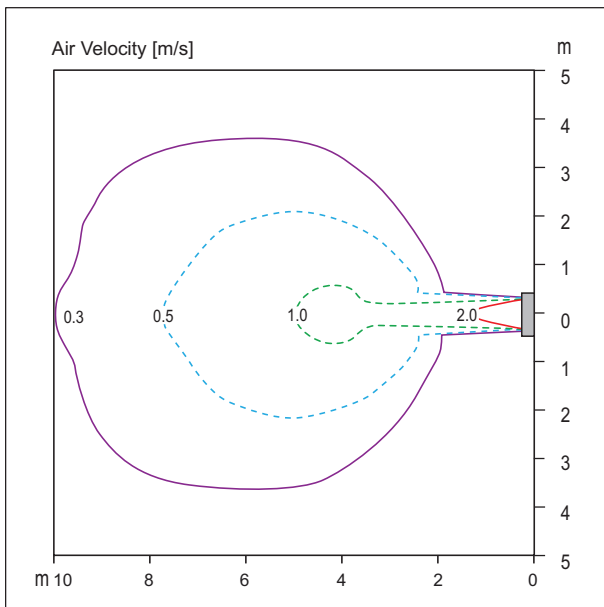

- Vertical Louver : Center
- Vertical Louver angle : 0°
- Air speed 0.3m/s Range : 10m
- Fan speed : High

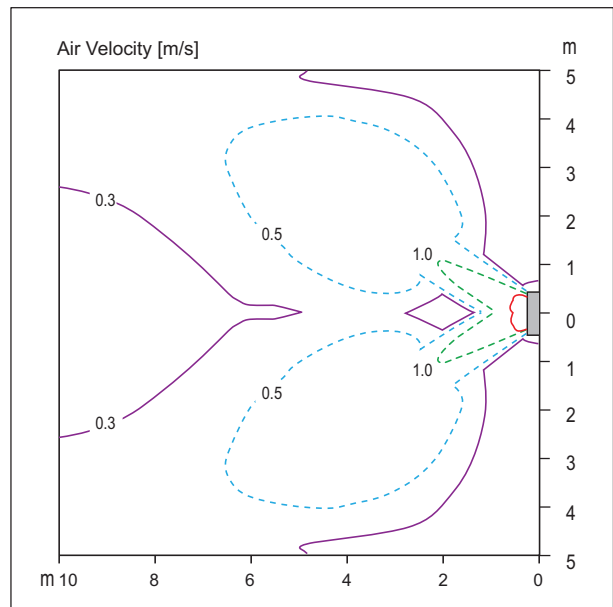

- Vertical Louver : Left & Right
- Vertical Louver angle : 50°
- Air speed 0.3m/s Range : 14.3m
- Fan speed : High

Note

- These figures are accordance with normal certain condition and environment. (Airflow step is 'High', Air discharge angle is fixed as indicated angle.)
- Indoor airflow distribution under actual installation or operating conditions depends on ambient temperature, ceiling height, product installation direction / location, indoor / Heating load, and other obstacles, etc.

7. Air Velocity and Temperature Distribution

◆ Heating

Side View

Discharge angle: 55°

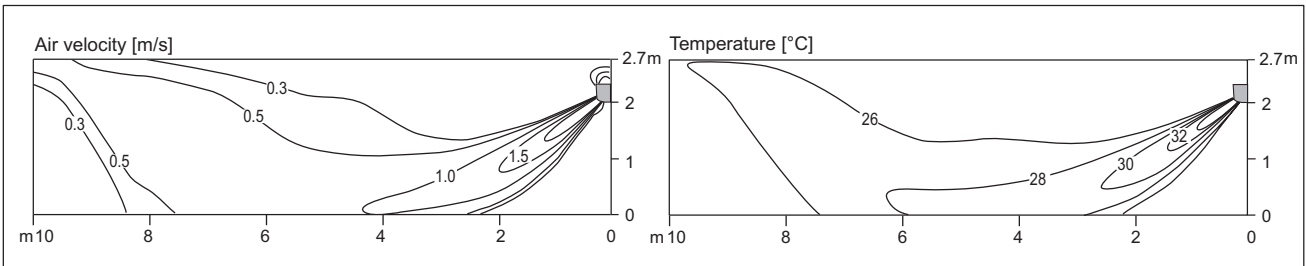

- Vertical Louver : Center
- Vertical Louver angle : 0°
- Fan speed : High

Top View

Discharge angle: 55°

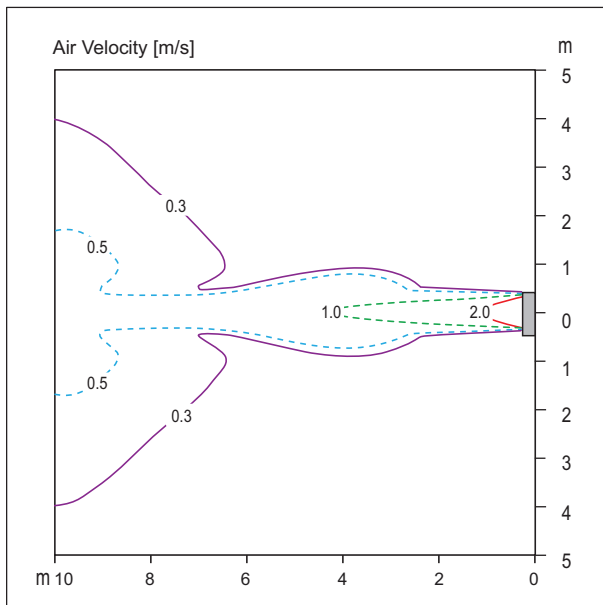

- Vertical Louver : Center
- Vertical Louver angle : 0°
- Air speed 0.3m/s Range : 13m
- Fan speed : High

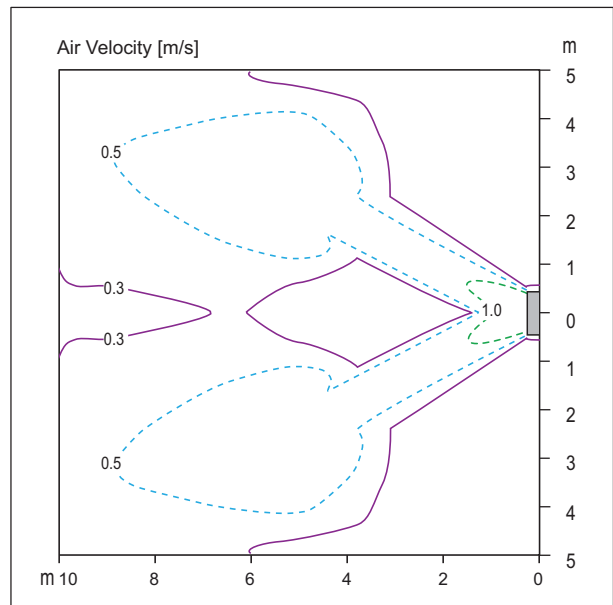

- Vertical Louver : Left & Right
- Vertical Louver angle : 50°
- Air speed 0.3m/s Range : 14.3m
- Fan speed : High

Note

- These figures are accordance with normal certain condition and environment. (Airflow step is 'High', Air discharge angle is fixed as indicated angle.)
- Indoor airflow distribution under actual installation or operating conditions depends on ambient temperature, ceiling height, product installation direction / location, indoor / Heating load, and other obstacles, etc.

7. Air Velocity and Temperature Distribution

■ ARNU15GSJR4

◆ Cooling

Side View

Discharge angle: 35°

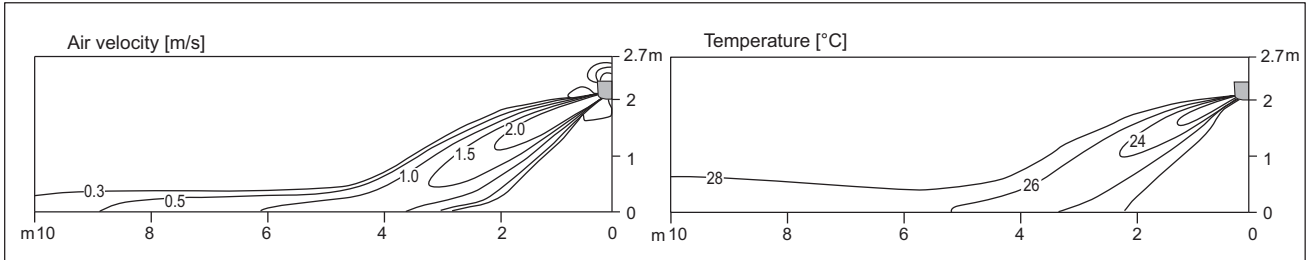

- Vertical Louver : Center
- Vertical Louver angle : 0°
- Fan speed : High

Top View

Discharge angle: 35°

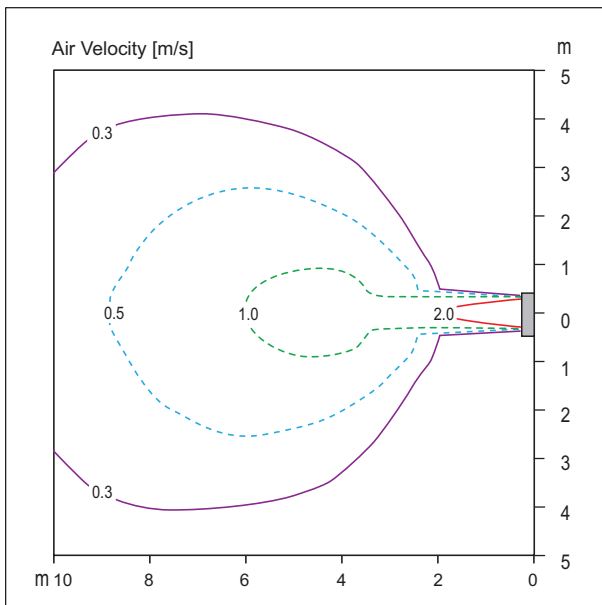

- Vertical Louver : Center
- Vertical Louver angle : 0°
- Air speed 0.3m/s Range : 11.5m
- Fan speed : High

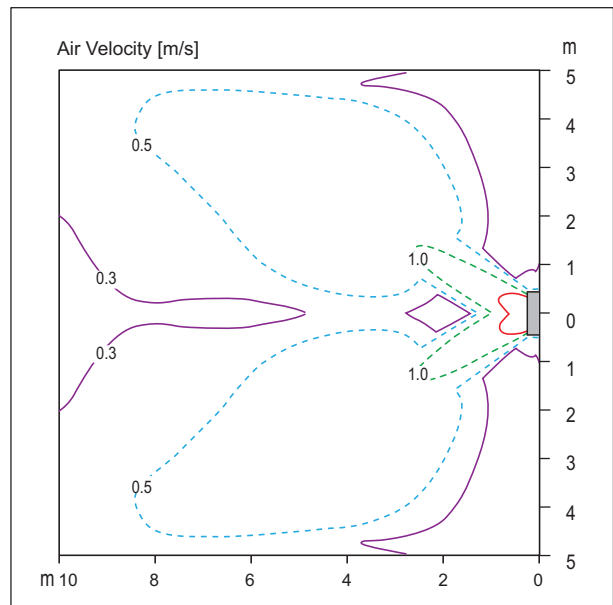

- Vertical Louver : Left & Right
- Vertical Louver angle : 50°
- Air speed 0.3m/s Range : 16.7m
- Fan speed : High

Note

- These figures are accordance with normal certain condition and environment. (Airflow step is 'High', Air discharge angle is fixed as indicated angle.)
- Indoor airflow distribution under actual installation or operating conditions depends on ambient temperature, ceiling height, product installation direction / location, indoor / Heating load, and other obstacles, etc.

7. Air Velocity and Temperature Distribution

◆ Heating

Side View

Discharge angle: 55°

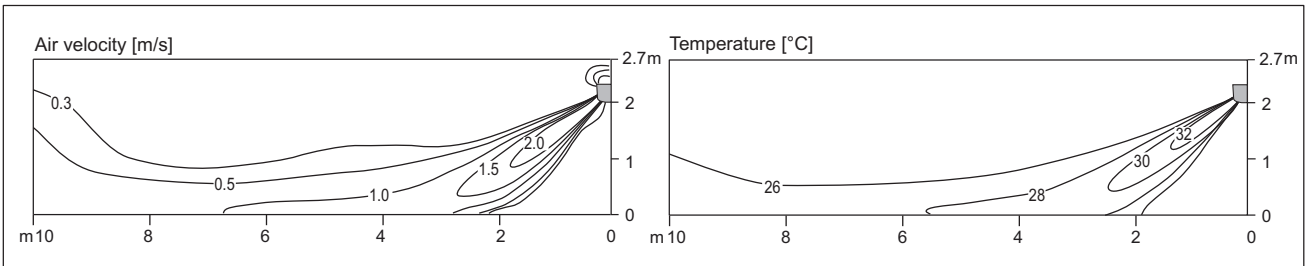

- Vertical Louver : Center
- Vertical Louver angle : 0°
- Fan speed : High

Top View

Discharge angle: 55°

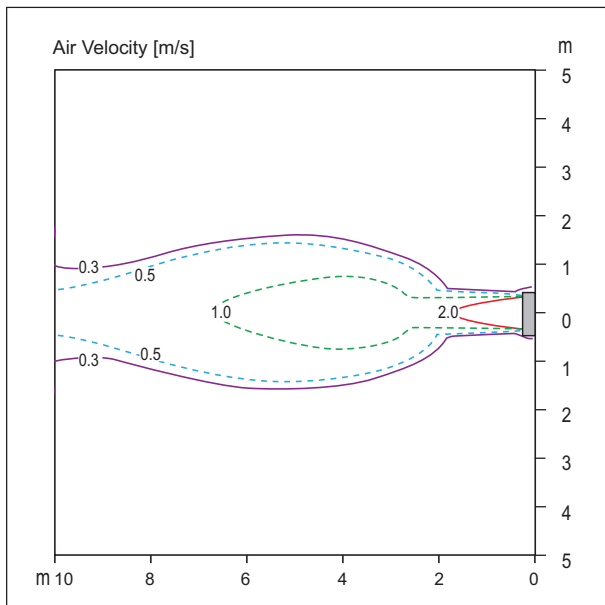

- Vertical Louver : Center
- Vertical Louver angle : 0°
- Air speed 0.3m/s Range : 18m
- Fan speed : High

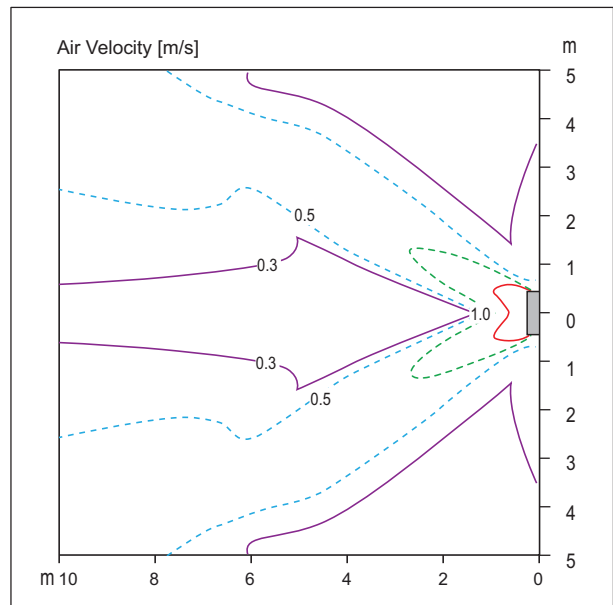

- Vertical Louver : Left & Right
- Vertical Louver angle : 50°
- Air speed 0.3m/s Range : 18.8m
- Fan speed : High

Note

- These figures are accordance with normal certain condition and environment.
(Airflow step is 'High', Air discharge angle is fixed as indicated angle.)
- Indoor airflow distribution under actual installation or operating conditions depends on ambient temperature, ceiling height, product installation direction / location, indoor / Heating load, and other obstacles, etc.

7. Air Velocity and Temperature Distribution

■ ARNU18GSKR4

◆ Cooling

Side View

Discharge angle: 25°

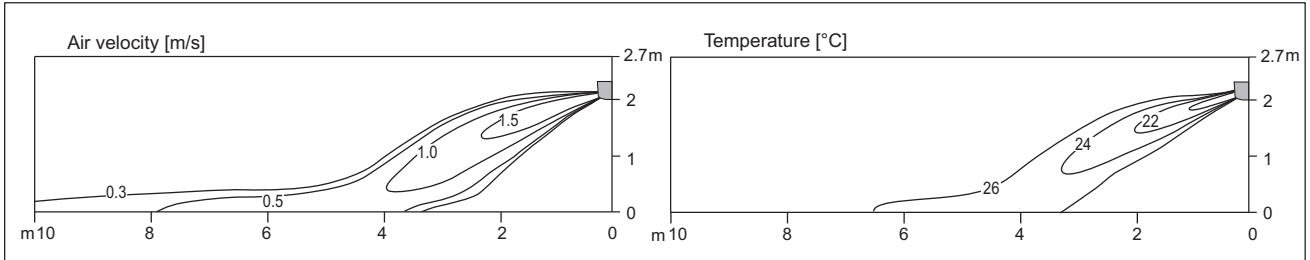

- Vertical Louver : Center
- Vertical Louver angle : 0°
- Fan speed : High

Top View

Discharge angle: 25°

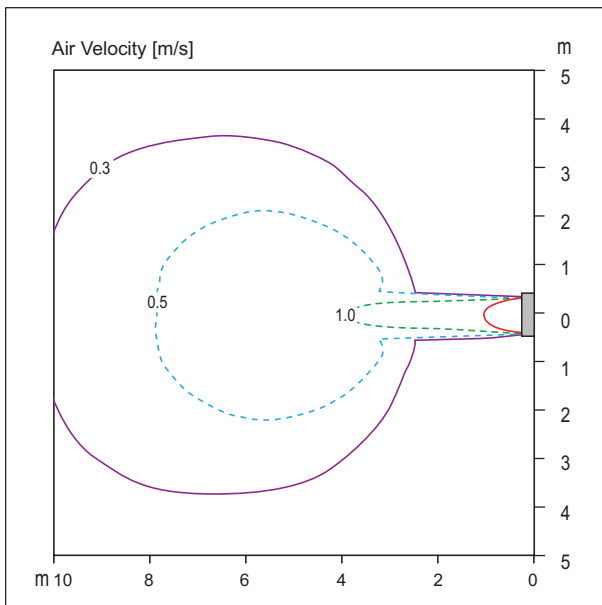

- Vertical Louver : Center
- Vertical Louver angle : 0°
- Air speed 0.3m/s Range : 10.4m
- Fan speed : High

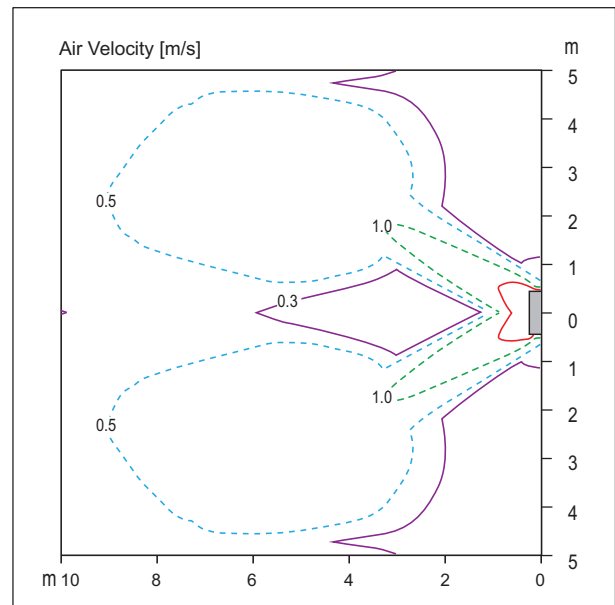

- Vertical Louver : Left & Right
- Vertical Louver angle : 50°
- Air speed 0.3m/s Range : 15.2m
- Fan speed : High

Note

- These figures are accordance with normal certain condition and environment. (Airflow step is 'High', Air discharge angle is fixed as indicated angle.)
- Indoor airflow distribution under actual installation or operating conditions depends on ambient temperature, ceiling height, product installation direction / location, indoor / Heating load, and other obstacles, etc.

7. Air Velocity and Temperature Distribution

◆ Heating

Side View

Discharge angle: 45°

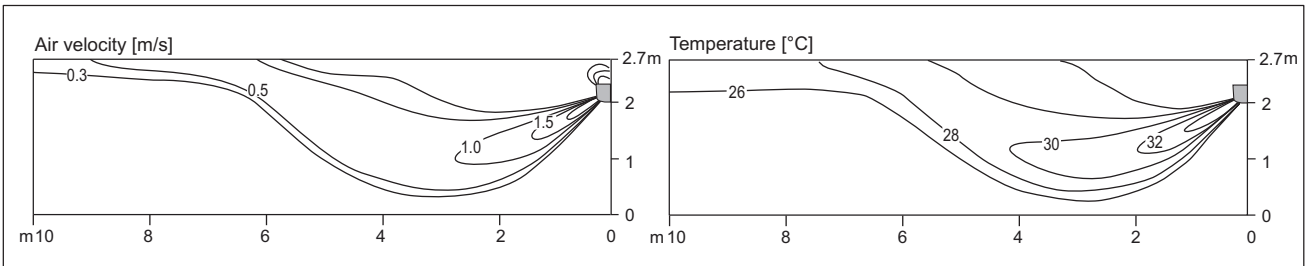

- Vertical Louver : Center
- Vertical Louver angle : 0°
- Fan speed : High

Top View

Discharge angle: 45°

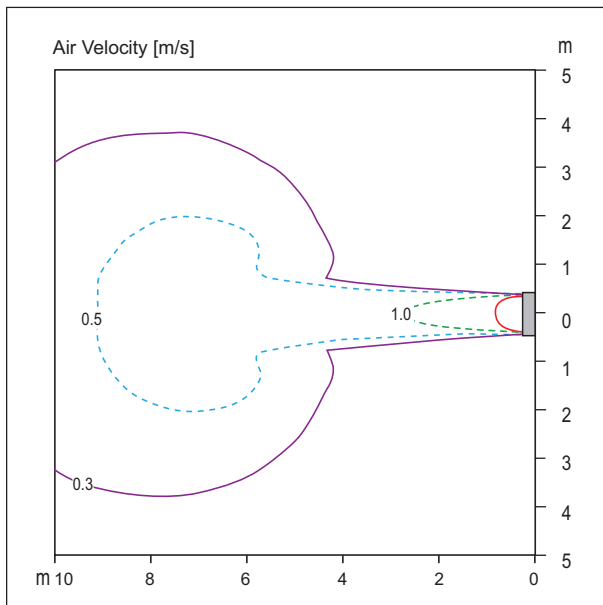

- Vertical Louver : Center
- Vertical Louver angle : 0°
- Air speed 0.3m/s Range : 11.6m
- Fan speed : High

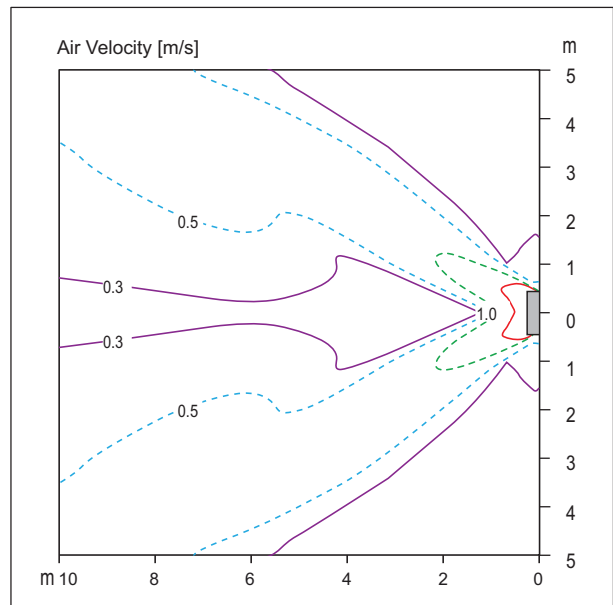

- Vertical Louver : Left & Right
- Vertical Louver angle : 50°
- Air speed 0.3m/s Range : 18.2m
- Fan speed : High

Note

- These figures are accordance with normal certain condition and environment. (Airflow step is 'High', Air discharge angle is fixed as indicated angle.)
- Indoor airflow distribution under actual installation or operating conditions depends on ambient temperature, ceiling height, product installation direction / location, indoor / Heating load, and other obstacles, etc.

7. Air Velocity and Temperature Distribution

■ ARNU24GSKR4

◆ Cooling

Side View

Discharge angle: 25°

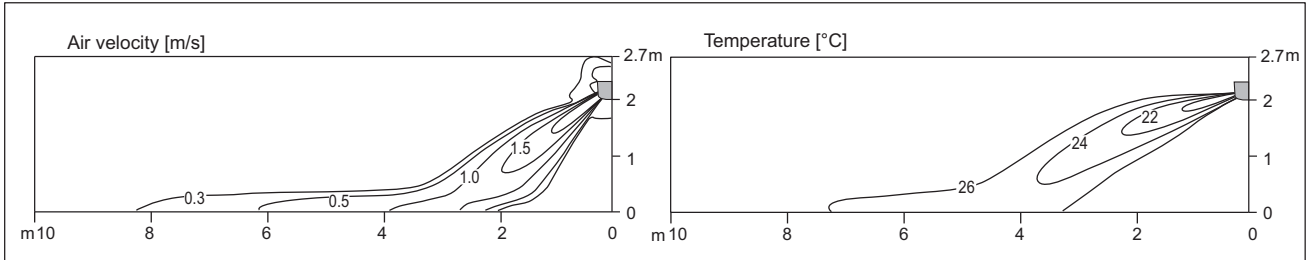

- Vertical Louver : Center
- Vertical Louver angle : 0°
- Fan speed : High

Top View

Discharge angle: 25°

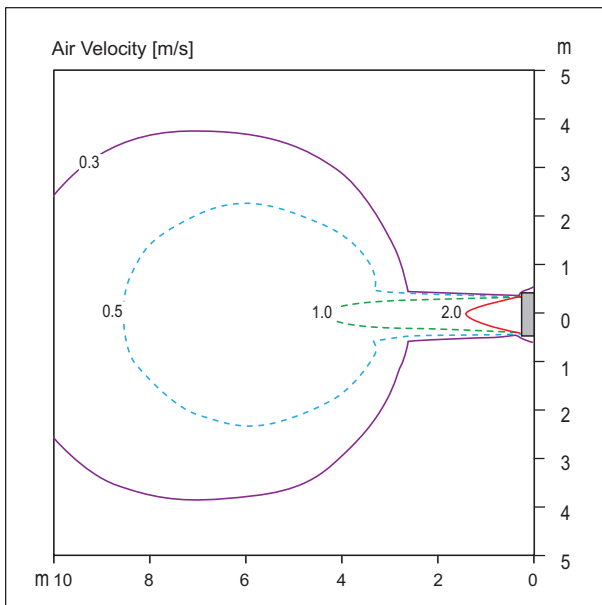

- Vertical Louver : Center
- Vertical Louver angle : 0°
- Air speed 0.3m/s Range : 11.2m
- Fan speed : High

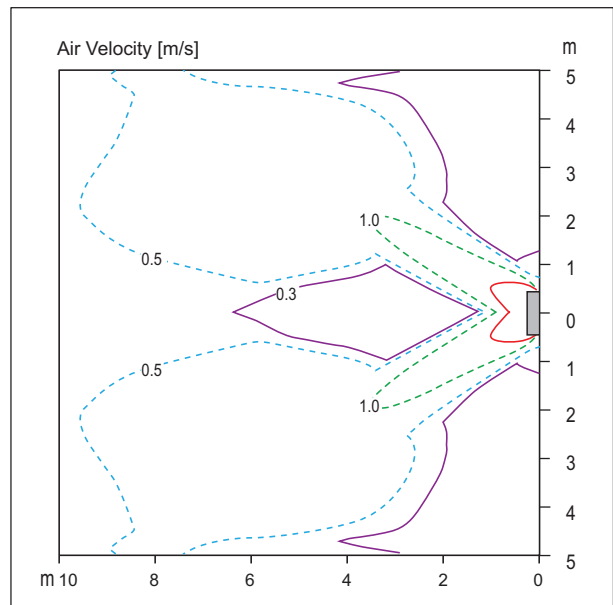

- Vertical Louver : Left & Right
- Vertical Louver angle : 50°
- Air speed 0.3m/s Range : 16.5m
- Fan speed : High

Note

- These figures are accordance with normal certain condition and environment. (Airflow step is 'High', Air discharge angle is fixed as indicated angle.)
- Indoor airflow distribution under actual installation or operating conditions depends on ambient temperature, ceiling height, product installation direction / location, indoor / Heating load, and other obstacles, etc.

7. Air Velocity and Temperature Distribution

◆ Heating

Side View

Discharge angle: 45°

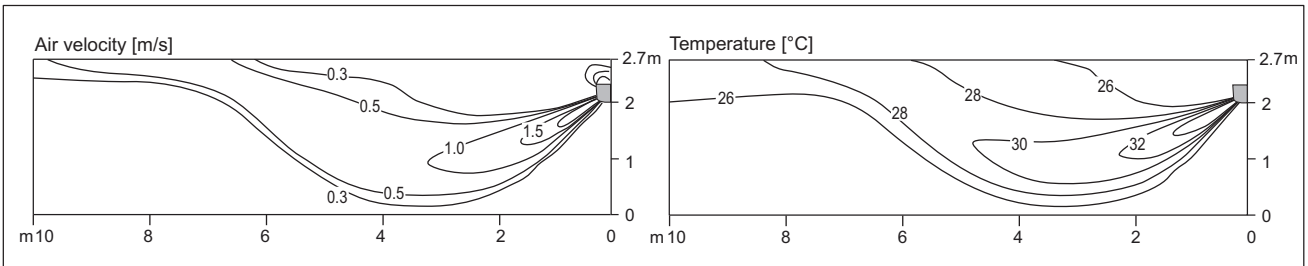

- Vertical Louver : Center
- Vertical Louver angle : 0°
- Fan speed : High

Top View

Discharge angle: 45°

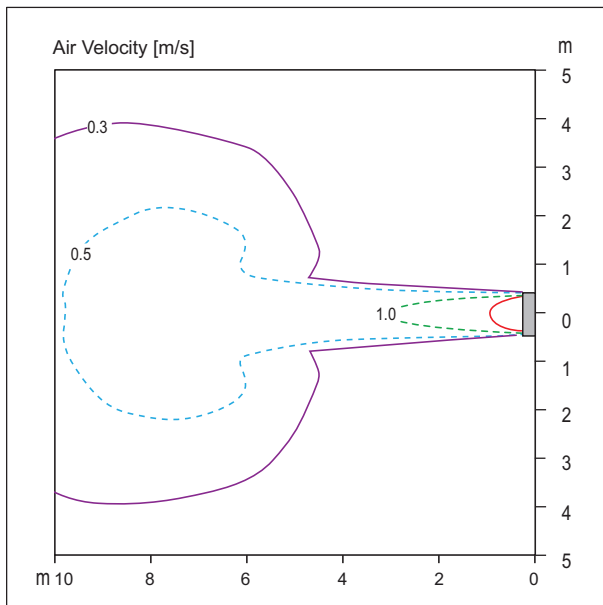

- Vertical Louver : Center
- Vertical Louver angle : 0°
- Air speed 0.3m/s Range : 12.1m
- Fan speed : High

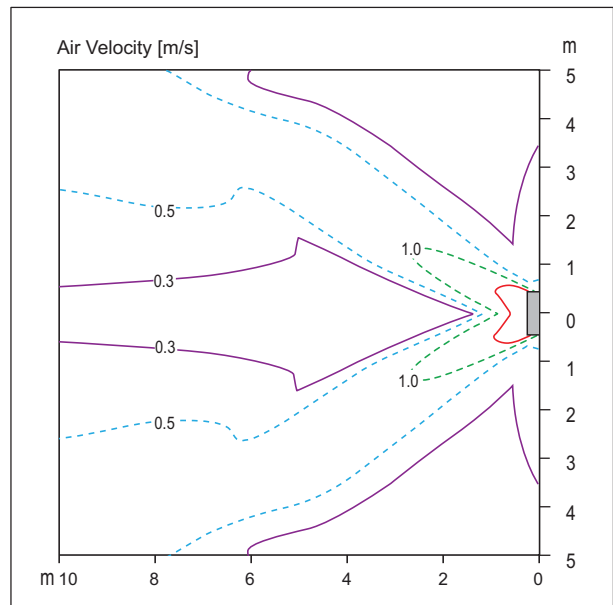

- Vertical Louver : Left & Right
- Vertical Louver angle : 50°
- Air speed 0.3m/s Range : 15.2m
- Fan speed : High

Note

- These figures are accordance with normal certain condition and environment. (Airflow step is 'High', Air discharge angle is fixed as indicated angle.)
- Indoor airflow distribution under actual installation or operating conditions depends on ambient temperature, ceiling height, product installation direction / location, indoor / Heating load, and other obstacles, etc.

8. Electric Characteristics

Units					Power supply	IFM		PI	
Model	Type	Hz	Volts	Voltage range	MCA	kW	FLA	Cooling	Heating
ARNU05GSJR4	SJ	50	220-240	Max: 264 Min: 198	0.31	0.030	0.25	30.0	30.0
ARNU07GSJR4	SJ				0.31	0.030	0.25	30.0	30.0
ARNU09GSJR4	SJ				0.31	0.030	0.25	30.0	30.0
ARNU12GSJR4	SJ				0.31	0.030	0.25	30.0	30.0
ARNU15GSJR4	SJ				0.31	0.030	0.25	30.0	30.0
ARNU18GSKR4	SK				0.65	0.058	0.52	53.0	53.0
ARNU24GSKR4	SK				0.65	0.058	0.52	53.0	53.0
ARNU05GSJR4	SJ	60	220	Max: 242 Min: 198	0.31	0.030	0.25	30.0	30.0
ARNU07GSJR4	SJ				0.31	0.030	0.25	30.0	30.0
ARNU09GSJR4	SJ				0.31	0.030	0.25	30.0	30.0
ARNU12GSJR4	SJ				0.31	0.030	0.25	30.0	30.0
ARNU15GSJR4	SJ				0.31	0.030	0.25	30.0	30.0
ARNU18GSKR4	SK				0.65	0.058	0.52	53.0	53.0
ARNU24GSKR4	SK				0.65	0.058	0.52	53.0	53.0

Symbols

MCA : Minimum Circuit Amperes (A)

MFA : Maximum Fuse Amperes (A)

kW : Fan Motor Rated Output (kW)

FLA : Full Load Amperes (A)

IFM : Indoor Fan Motor

PI : Maximum Power Input (W)

Note

- Voltage range
Units are suitable for use on electrical systems where voltage supplied to unit terminals is not below or above the listed range limits.
- Maximum allowable voltage unbalance between phases is 2%.
- MCA/MFA
MCA=1.25 x FLA
MFA = 1.1 x MCA, MFA ≤ 4 x FLA
(If MFA is smaller than minimum standard value, Use minimum standard value in region for selecting circuit breaker.)
- Select wire size based on the MCA
- Instead of fuse, use Circuit Breaker.

9. Sound Levels

9.1 Sound Pressure Levels

Overall

Note

- 1.Sound measured at some distance away from the center of the unit.
- 2.Data is valid at free field condition.
- 3.Reference acoustic pressure 0dB = 20μPa.
- 4.Data is valid at nominal operation condition.
Refer to the Model Specifications for nominal conditions(Power source and Ambient temperature, etc)
- 5.Sound levels can be increased in accordance with installation and operating conditions. (Static pressure mode, used air guide, Room target temperature setting, etc)
- 6.Sound level will vary depending on a range of factors such as the construction(acoustic absorption coefficient) of particular room in which the equipment is installed.
- 7.Sound pressure level is measured on the rated condition in the anechoic rooms by ISO 3745 standard.
Therefore, these values can be increased owing to ambient conditions during operation.

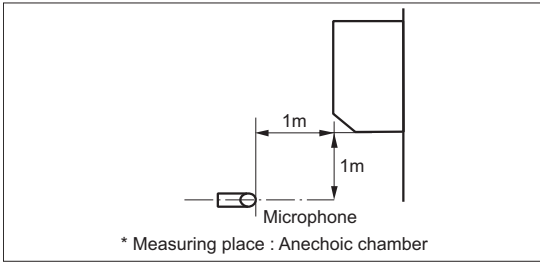

Model	Sound Pressure Levels [dB(A)]		
	High	Middle	Low
ARNU05GSJR4	30	29	28
ARNU07GSJR4	32	30	28
ARNU09GSJR4	34	32	28
ARNU12GSJR4	37	34	30
ARNU15GSJR4	42	39	32
ARNU18GSKR4	43	39	34
ARNU24GSKR4	46	41	34

ARNU05GSJR4

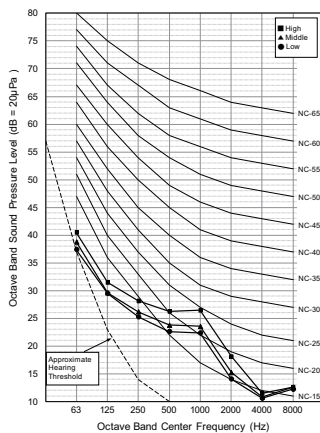

ARNU07GSJR4

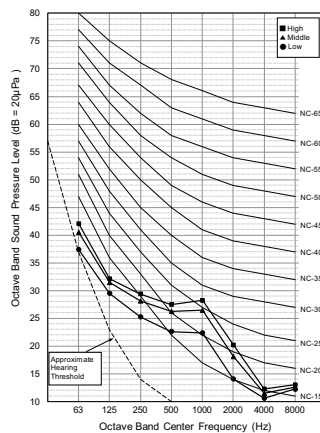

ARNU09GSJR4

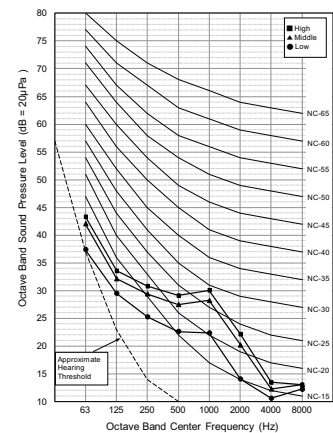

9. Sound Levels

ARNU12GSJR4

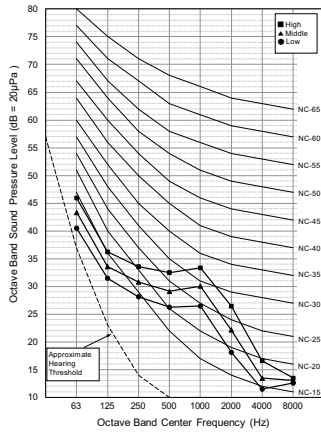

ARNU15GSJR4

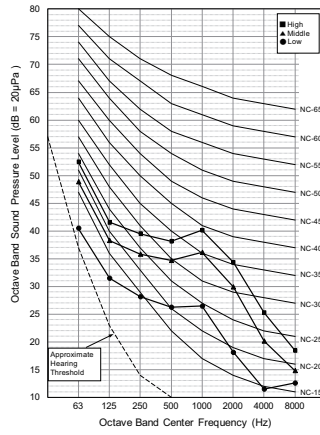

ARNU18GSKR4

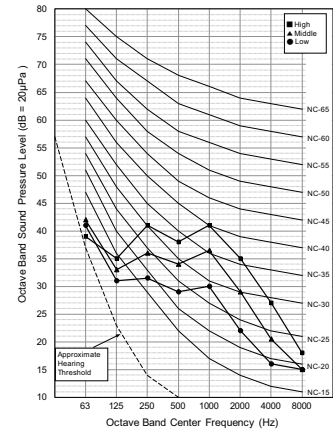

ARNU24GSKR4

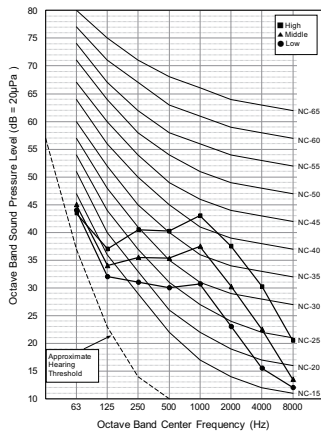

9. Sound Levels

9.2 Sound Power Levels

Note

- Data is valid at diffuse field condition
- Data is valid at nominal operating condition
- Sound level can be increased in static pressure mode or used air guide.
- Sound level will vary depending on a range of factors such as the construction (acoustic absorption coefficient) of particular room in which the equipment is installed.
- Reference acoustic intensity 0dB = $10E-6\mu W/m^2$
- Sound power level is measured on the rated condition in the semi-anechoic rooms by ISO 9614 standard. Therefore, these values can be increased owing to ambient conditions during operation.

Model	Sound Power Levels [dB(A)]		
	High	Middle	Low
ARNU05GSJR4	45	43	42
ARNU07GSJR4	46	45	42
ARNU09GSJR4	48	46	42
ARNU12GSJR4	51	48	45
ARNU15GSJR4	55	52	44
ARNU18GSKR4	59	56	52
ARNU24GSKR4	63	58	52

ARNU05GSJR4

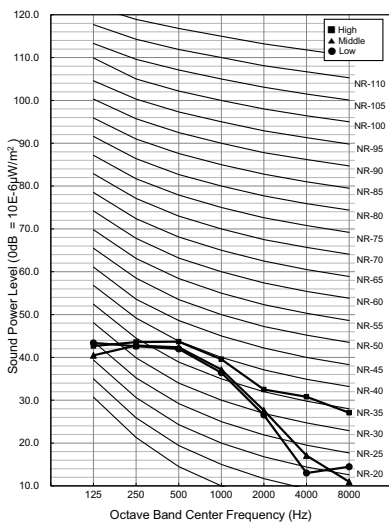

ARNU07GSJR4

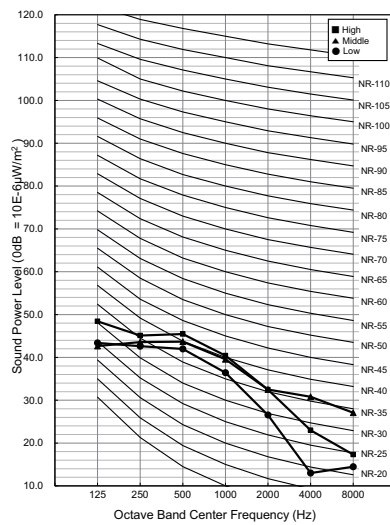

ARNU09GSJR4

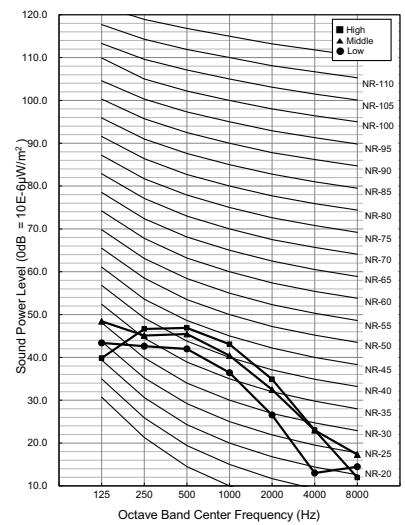

9. Sound Levels

ARNU12GSJR4

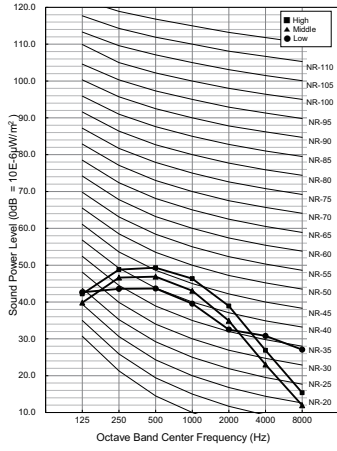

ARNU15GSJR4

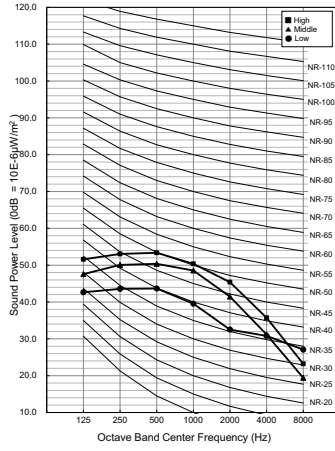

ARNU18GSKR4

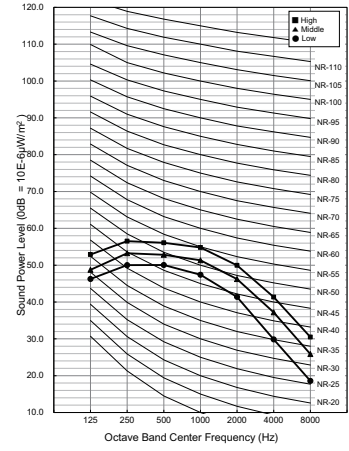

ARNU24GSKR4

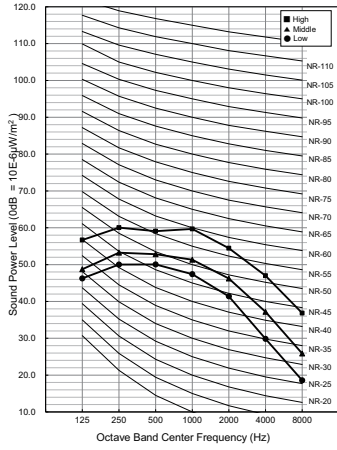

MULTI V™
Indoor Unit

ARTCOOL (Gallery)

- 1. List of functions**
- 2. Specifications**
- 3. Dimensions**
- 4. Piping Diagrams**
- 5. Wiring Diagrams**
- 6. Capacity Tables**
- 7. Air Velocity and Temperature Distribution**
- 8. Electric Characteristics**
- 9. Sound Levels**

1. List of functions

Category	Function	ARNU07GSF14, ARNU09GSF14, ARNU12GSF14
Air Flow	Air Supply Outlet	3
	Airflow Direction Control (left & right)	Auto
	Airflow Direction Control (up & down)	Auto
	Auto Swing (left & right)	O
	Auto Swing (up & down)	O
	Airflow Steps (fan/cool/heat)	4 / 5 / 5
	Fan Speed Auto*	Advanced
	Power Cool/Heat	O / O
	Swirl Wind*	O
	Refresh Mode**	X
	Smart Mode**	X
	Indirect Wind*	X
	Direct Wind*	X
	Dry Operation	O
Air Purification	Air Purify	X
	Ionizer	X
	UV-C	X
	Pre-Filter	O
Reliability	Hot Start	O
	Self Diagnosis	O
Convenience	Auto Mode	O
	Auto Dry Operation	O
	Auto Restart	O
	Child Lock*	O
	Forced Operation	O
	Group Control*	O
	Sleep Timer	O
	Turn On/Off Reservation	O
	Schedule*	O
	Two Thermistor Control*	O
External On/Off	O	
Installation	Drain Pump	X
	E.S.P. Control*	-
	High Ceiling Operation*	-
Special Functions	Wi-Fi	Accessory
	Auto Elevation Grille	X
	Human Detection Function**	X
	Floor Detection Function**	X

Note

- O : Applied, X : Not Applied, - : Unconfirmed or irrelevant
Embedded : A kit is provided by default for using this function when the product is manufactured.
Accessory : Ordered and purchased separately the accessory package referring to the model name provided and install at field. Accessory line-ups varies by region, so check your local catalogue or local sales material.
- Some functions can be limited by remote controller.
- In case of cassette type indoor units, Air Purification Kit and Auto Elevation Grille functions are not applicable at the same time.
- 'Auto Mode' varies depending on the outdoor unit type.
 - Auto Change Over(Heat Recovery Outdoor Unit)
 - Auto Mode Select(Heat Pump Outdoor Unit)
 - Auto Intensity Control(Cooling Only Outdoor Unit)
- * : These functions need to connect the wired remote controller.
- ** : This functions need to connect to the Standard III wired remote controller.

1. List of functions

■ Accessory Compatibility List

Category	Accessory Name	Model Name	Description	ARNU07GSF14 ARNU09GSF14 ARNU12GSF14
Remote Controller	Wired - Premium	PREMTA000	-	○
		PREMTA000A	-	○
		PREMTA000B	-	○
	Wired - RS3 (Standard III)	PREMTB100/PREMTB101	White	○
		PREMTBB10/PREMTBB11	Black	○
	Wired - RS2 (Standard II)	PREMTB001	White	○
		PREMTBB01	Black	○
	Wired - Simple	PQRCVCL0QW	White	○
		PQRCVCL0Q	Black	○
	Wired - Simple for Hotel	PQRCHCA0QW	White	○
		PQRCHCA0Q	Black	○
	Wireless	PQWRCQ0FDB	For Cooling only	○
PQWRHQ0FDB		For Heat pump	○	
PWLSSB21C		For Cooling only	○	
PWLSSB21H		For Heat pump	○	
Dry Contact	Simple	PDRYCB000	1 input port, AC 220 - 240V	○
		PDRYCB100	1 input port, AC 24V	○
	Communication	PDRYCB400	2 input port	○
		PDRYCB300	8 input port, For 3rd party Thermostat	○
		PDRYCB320	8 input port, For 3rd Party Thermostat (Analog Input)	○
PDRYCB500	For 3rd Party Controller (Modbus RTU)	○		
Integration Device	Remote Temperature sensor	PQRSTA0	-	X
	Group Control wire	PZCWRCG3	Cable Assembly for group control (Y-type cable : 0.25m, cable : 9.6m)	○
ETC	Extension wire	PZCWRC1	Extension wire for IDU-wired remote controller (9.6m)	X
	2-Remo Control Wire	PZCWRC2	-	X
	Wi-Fi Modem	PWFMDD200	-	○
	Wi-Fi Extension cable	PWYREW000	USB Extension cable : 10 m	○
	Independent Power Module	PRIP0	-	○
	Multi-tenant Power Module	PINPMB001	-	○
	Refrigerant Leakage Detector	PRLDNVS0	For R410A only	○
	Human Detection Sensor	PTVSMA0	For Cassette 4-way	X
		PTVSA00	For Cassette Dual Vane 4-way	X
	Floor Detection Sensor	PTFSMA0	-	X
	Auto Elevation Grille	PTEGM0	For TP/TN/TM	X
	Air Purification Kit	PTAHTP0	For Cassette 1-way	X
		PTAHMP0	For Cassette 4-way	X
		PTAHYP0	For Cassette Round	X
	EEV Kit	PRGK024A0	For Multi V Indoor Unit	○
	Auxiliary Heater Relay Kit	PRARS1	For Wall Mounted and Art Cool Indoor Units	○
		PRARH1	For Cassette and Duct Indoor Units	X
	Ventilation Kit	PTVK430	For TR/TQ/TP/TN/TM	X
		PTVK410 + PTVK420	For TP/TN/TM	X
	Cassette Cover	PTDCQ	For TR/TQ	X
PTDCM		For TP/TN/TM	X	
PTDCA		For TM-A/TP-B	X	

Note

1. O: Possible, X: Impossible, -: Not applicable, Embedded : Included with product.
2. If there is a difference in development time between the product and the remote controller, some functions cannot be operated.
3. If using Wi-Fi controller, Some advanced functions controlled by remote controller cannot be operated.
4. If you need more detail, please refer to the **BECON** PDB or the manual of product. (<http://partner.lge.com/global> : Home> Doc.Library> Product > Control(BECON))

2. Specifications

Type			ARTCOOL Gallery	
Model		Unit	ARNU07GSF14	ARNU09GSF14
Cooling Capacity		kW	2.2	2.8
		kcal/h	1,900	2,400
		Btu/h	7,500	9,600
Heating Capacity		kW	2.5	3.2
		kcal/h	2,200	2,800
		Btu/h	8,500	10,900
Power Input (H / M / L)		W	28 / 16 / 10	28 / 16 / 10
Dimensions (W x H x D)	Body	mm	600 x 600 x 146	600 x 600 x 146
		inch	23-5/8 x 23-5/8 x 5-25/32	23-5/8 x 23-5/8 x 5-25/32
Coil	Rows x Columns x FPI		2x20x21	2x20x21
	Face Area	m ²	0.18	0.18
Fan	Type		Turbo Fan	Turbo Fan
	Motor Output x Number	W	30	30
	Air Flow Rate (H / M / L)	m ³ /min	8.1 / 6.3 / 4.2	8.1 / 6.3 / 4.2
		ft ³ /min	286 / 222 / 148	286 / 222 / 148
	Drive		Direct	Direct
Motor type		BLDC	BLDC	
Temperature Control			Microprocessor, Thermostat for cooling and heating	
Sound Absorbing Thermal Insulation Material			Foamed polystyrene	
Air Filter			Resin Net(washable)	
Safety Device			Fuse	
Pipe Connections	Liquid Side	mm (inch)	Ø6.35 (1/4)	Ø6.35 (1/4)
	Gas Side	mm (inch)	Ø12.7 (1/2)	Ø12.7 (1/2)
	Drain Pipe(Internal Dia.)	mm (inch)	12.2 (15/32)	12.2 (15/32)
Net Weight		kg (lbs)	15.4 (34.0)	15.4 (34.0)
Sound Pressure Level (H / M / L)		dB(A)	38 / 32 / 27	38 / 32 / 27
Sound Power Level (H / M / L)		dB(A)	48 / 46 / 41	48 / 46 / 41
Power Supply		Ø, V, Hz	1, 220 - 230 - 240, 50/60	1, 220 - 230 - 240, 50/60
Running Current by voltage	Rated	A	0.23 - 0.22 - 0.21	0.23 - 0.22 - 0.21
Maximum Running Current		A	0.30	0.30
Refrigerant	Type		R410A / R32	R410A / R32
	Additional Charging Amount (CF Value of IDU)	kg(each)	0.10 / 0.08	0.10 / 0.08
	Control		EEV	EEV
Transmission Cable		mm ²	1.0~1.5 x 2C	1.0~1.5 x 2C
Front Panel Color			1: Kiss (Photo changeable)	
Note				
1. Due to our policy of innovation some specifications may be changed without notification.				
2. Wiring cable size must comply with the applicable local and national code. And "Electric characteristics" chapter should be considered for electrical work and design. Especially the power cable and circuit breaker should be selected in accordance with that.				
3. Sound pressure level is measured on the rated condition in the anechoic rooms by ISO 3745 standard. Sound power level is measured on the rated condition in the semi-anechoic rooms by ISO 9614 standard. Therefore, these values can be increased owing to ambient conditions during operation.				
4. Capacities are net capacities and based on the following conditions. Refer to the Outdoor Unit Specifications for calculating the real capacity. <ul style="list-style-type: none"> • Cooling : Indoor Ambient Temp. 27°CDB / 19°CWB, Outdoor Ambient Temp. 35°CDB / 24°CWB • Heating : Indoor Ambient Temp. 20°CDB / 15°CWB, Outdoor Ambient Temp. 7°CDB / 6°CWB • Interconnected Pipe is standard length and difference of Elevation (Outdoor ~ Indoor Unit) is 0m. 				
5. Refrigerant information (type, additional charging amount, etc.) must be applied by refrigerant type of the combined outdoor unit. Adapt after checking the specifications of outdoor unit.				

2. Specifications

Type		ARTCOOL Gallery	
Model	Unit	ARNU12GSF14	
Cooling Capacity	kW	3.6	
	kcal/h	3,100	
	Btu/h	12,300	
Heating Capacity	kW	4.0	
	kcal/h	3,400	
	Btu/h	13,600	
Power Input (H / M / L)		W	32 / 20 / 12
Dimensions (W x H x D)	Body	mm	600 x 600 x 146
		inch	23-5/8 x 23-5/8 x 5-25/32
Coil	Rows x Columns x FPI		2x20x21
	Face Area	m ²	0.18
Fan	Type		Turbo Fan
	Motor Output x Number	W	30
	Air Flow Rate (H / M / L)	m ³ /min	9.3 / 7.7 / 6.0
		ft ³ /min	328 / 272 / 212
	Drive		Direct
Motor type		BLDC	
Temperature Control			Microprocessor, Thermostat for cooling and heating
Sound Absorbing Thermal Insulation Material			Foamed polystyrene
Air Filter			Resin Net(washable)
Safety Device			Fuse
Pipe Connections	Liquid Side	mm (inch)	Ø6.35(1/4)
	Gas Side	mm (inch)	Ø12.7(1/2)
	Drain Pipe(Internal Dia.)	mm (inch)	12.2(15/32)
Net Weight		kg (lbs)	15.4 (34.0)
Sound Pressure Level (H / M / L)		dB(A)	44 / 38 / 32
Sound Power Level (H / M / L)		dB(A)	54 / 48 / 42
Power Supply		Ø, V, Hz	1, 220 - 230 - 240, 50/60
Running Current by voltage	Rated	A	0.26 - 0.25 - 0.24
Maximum Running Current		A	0.30
Refrigerant	Type		R410A / R32
	Additional Charging Amount (CF Value of IDU)	kg(each)	0.10 / 0.08
	Control		EEV
Transmission Cable		mm ²	1.0~1.5 x 2C
Front Panel Color			1: Kiss (Photo changeable)

Note

- Due to our policy of innovation some specifications may be changed without notification.
- Wiring cable size must comply with the applicable local and national code. And "Electric characteristics" chapter should be considered for electrical work and design. Especially the power cable and circuit breaker should be selected in accordance with that.
- Sound pressure level is measured on the rated condition in the anechoic rooms by ISO 3745 standard.
Sound power level is measured on the rated condition in the semi-anechoic rooms by ISO 9614 standard.
Therefore, these values can be increased owing to ambient conditions during operation.
- Capacities are net capacities and based on the following conditions. Refer to the Outdoor Unit Specifications for calculating the real capacity.
 - Cooling : Indoor Ambient Temp. 27°CDB / 19°CWB, Outdoor Ambient Temp. 35°CDB / 24°CWB
 - Heating : Indoor Ambient Temp. 20°CDB / 15°CWB, Outdoor Ambient Temp. 7°CDB / 6°CWB
 - Interconnected Pipe is standard length and difference of Elevation (Outdoor ~ Indoor Unit) is 0m.
- Refrigerant information (type, additional charging amount, etc.) must be applied by refrigerant type of the combined outdoor unit.
Adapt after checking the specifications of outdoor unit.

3. Dimensions

3.1 Dimensional Drawings

ARNU07GSF14 / ARNU09GSF14 / ARNU12GSF14

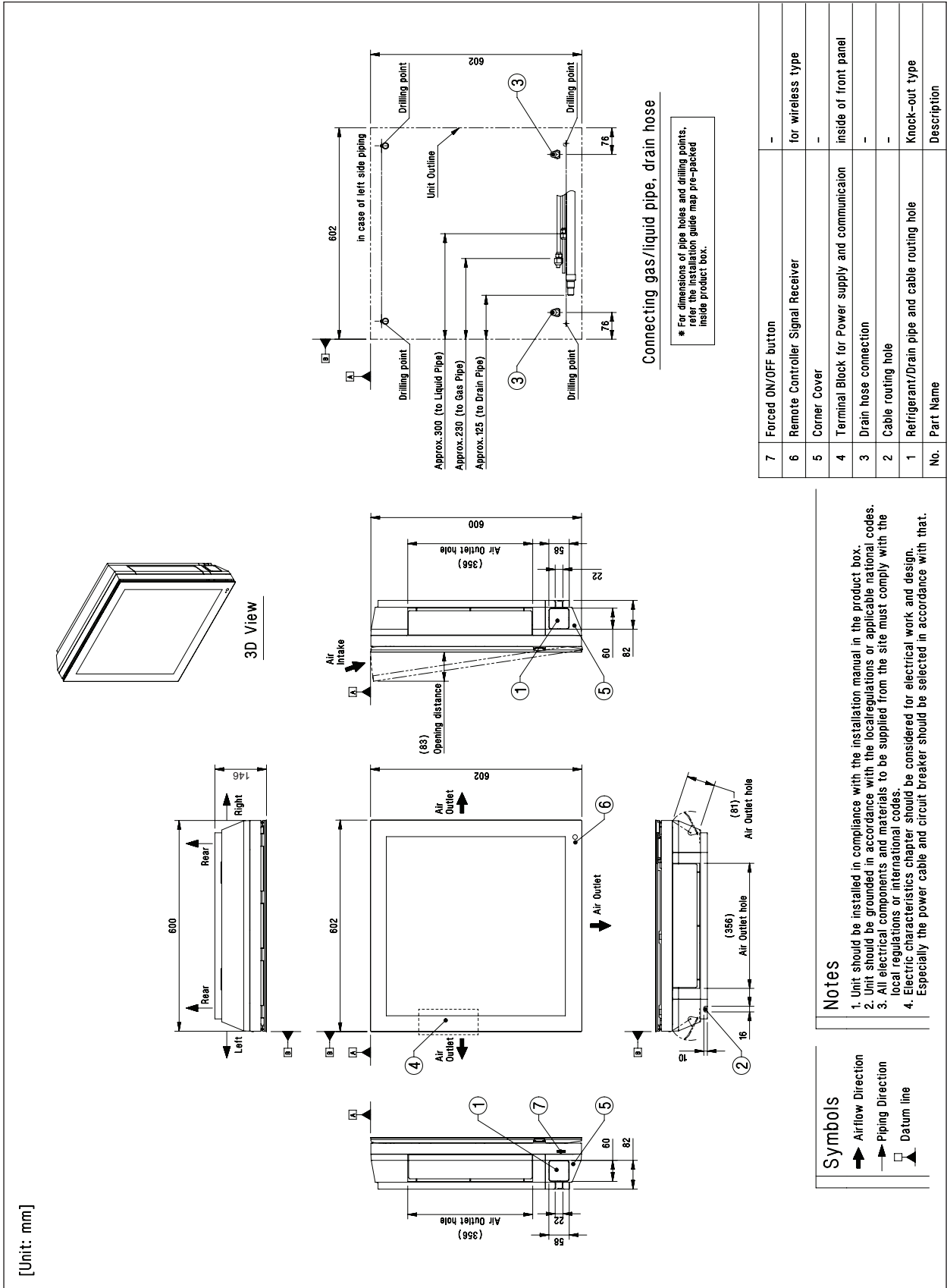

No.	Part Name	Description
7	Forced ON/OFF button	-
6	Remote Controller Signal Receiver	for wireless type
5	Corner Cover	-
4	Terminal Block for Power supply and communication	inside of front panel
3	Drain hose connection	-
2	Cable routing hole	-
1	Refrigerant/Drain pipe and cable routing hole	Knock-out type

Notes

- Unit should be installed in compliance with the installation manual in the product box.
- Unit should be grounded in accordance with the local regulations or applicable national codes.
- All electrical components and materials to be supplied from the site must comply with the local regulations or international codes.
- Electric characteristics chapter should be considered for electrical work and design. Especially the power cable and circuit breaker should be selected in accordance with that.

Symbols

- ▲ Airflow Direction
- Piping Direction
- Datum line

3. Dimensions

3.2 Installation Space

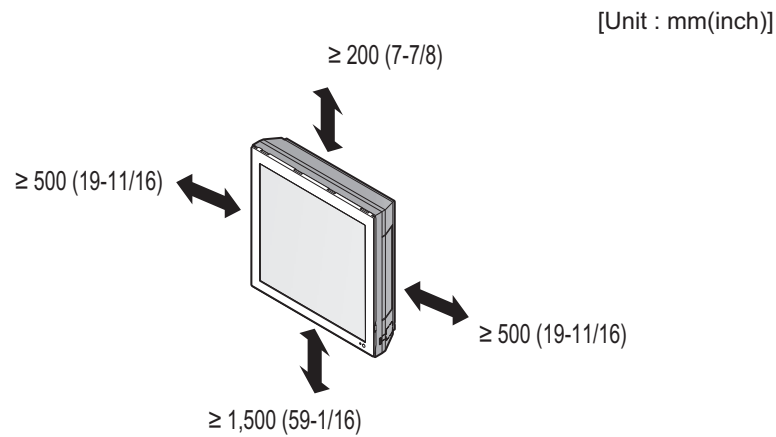

Note

- Places where products are installed should not be any obstacles to the air circulation or installation. Ensure the spaces from the wall, ceiling, or other obstacles.
- According to type of indoor unit, external appearance or installed structure could be different.
- According to product type, model line up, sales region..etc, applicability of each chassis could be different.

4. Piping Diagrams

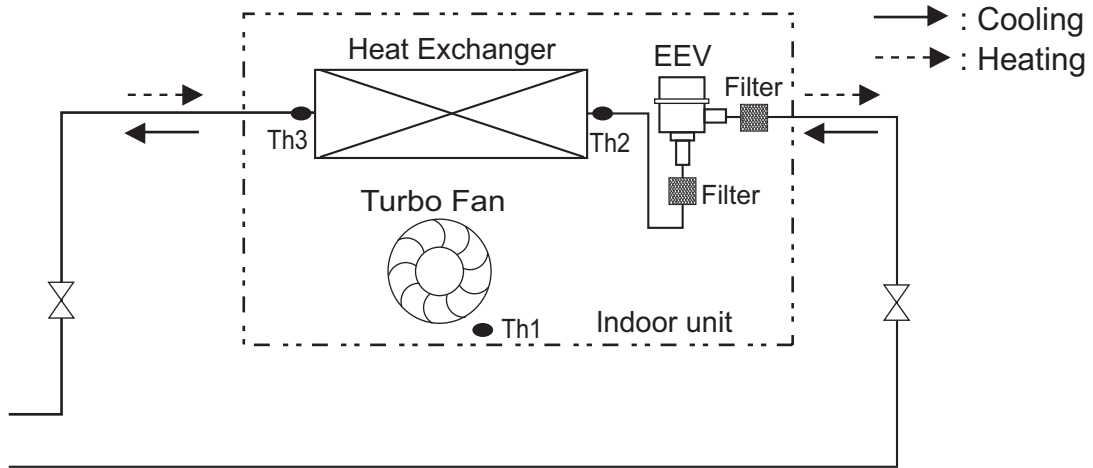

◆ Refrigerant pipe connection port diameter

Model	Gas [mm(inch)]	Liquid [mm(inch)]
ARNU07GSF14	Ø12.7(1/2)	Ø6.35(1/4)
ARNU09GSF14	Ø12.7(1/2)	Ø6.35(1/4)
ARNU12GSF14	Ø12.7(1/2)	Ø6.35(1/4)

*Panel color :E(Red), V(Silver), G(Gold), 1(Kiss (Photo changeable))

LOC.	Description	PCB Connector
Th1	Thermistor for inlet air temperature	CN-TH1
Th2	Thermistor for EVA. in temperature	
Th3	Thermistor for EVA. out temperature	CN-TH2

5. Wiring Diagrams

SF Chassis

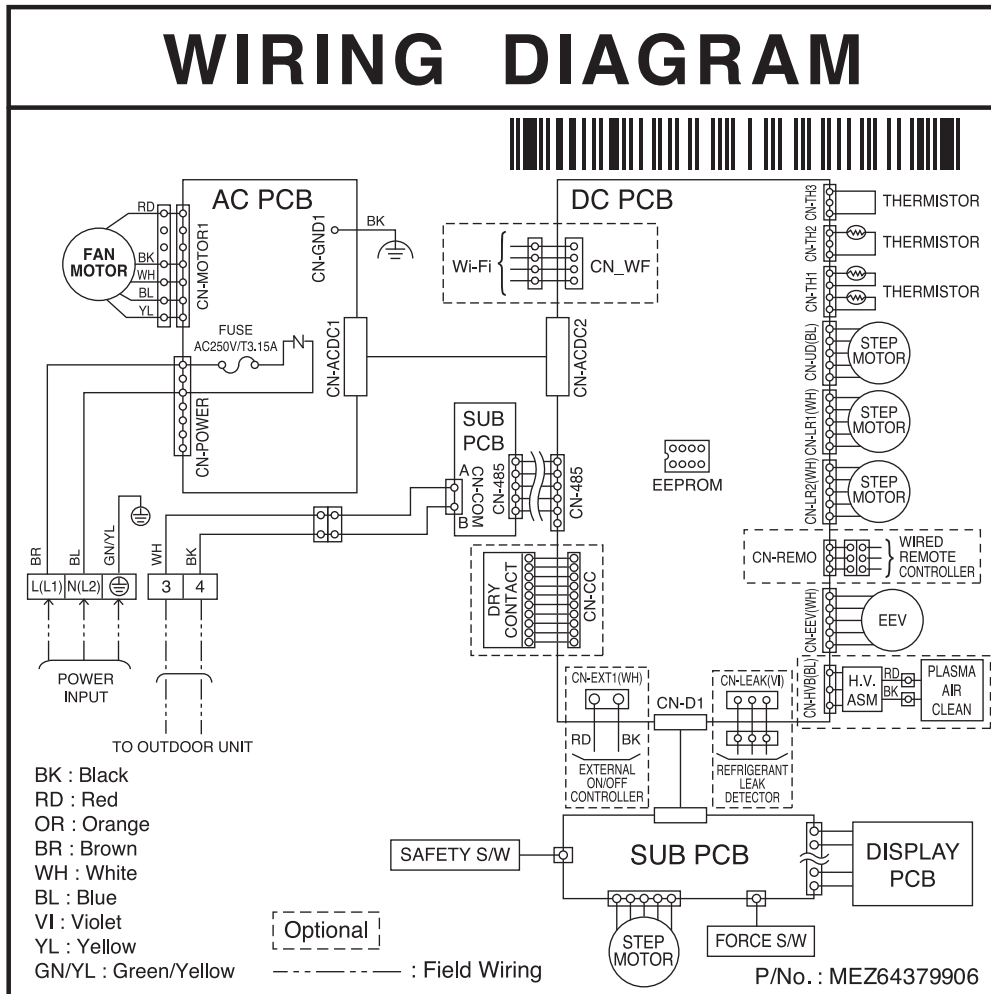

CONNECTOR NUMBER	LOCATION POINT	FUNCTION
CN-POWER	AC Power supply	AC Power line input for indoor
CN-MOTOR	Fan motor output	Motor output of BLDC
CN-485	Communication	Connection between indoor
CN-DISP1	Display	Display of indoor status
CN-DISP2	Display	Display of indoor status
CN-LEV	EEV output	EEV Control output : connect to EEV directly or through IPM(Independent Power Module)
CN-U/D	Step motor	Step motor output
CN-TH1	Room/inlet pipe sensor	Room and inlet pipe thermistor
CN-TH2	Outlet pipe sensor	Outlet pipe thermistor
CN-REMO	Remote controller	Remote control line
CN-CC	Dry contact	Dry contact line
CN-HVB	Air clean	Air clean control
CN-EXT	External On/Off	External On/Off signal input
CN-LEAK	Refrigerant leak detector	Refrigerant leak detector line
CN_WF	Wi-Fi Controller	Wifi control line

6. Capacity Tables

■ Cooling Capacity

Nominal Capacity (kBtu/h) [Capacity Index (kW)]	Indoor air temp. (DB/WB, °C)													
	20		23		26		27		28		30		32	
	14		16		18		19		20		22		24	
	TC	SHC	TC	SHC	TC	SHC	TC	SHC	TC	SHC	TC	SHC	TC	SHC
7 [2.2]	1.5	1.3	1.8	1.4	2.1	1.5	2.2	1.6	2.3	1.6	2.4	1.5	2.4	1.4
9 [2.8]	1.9	1.6	2.3	1.8	2.6	2.0	2.8	2.0	3.0	2.0	3.0	1.9	3.1	1.8
12 [3.6]	2.4	2.1	2.9	2.4	3.4	2.6	3.6	2.6	3.8	2.7	3.9	2.5	4.0	2.3

Note

1. TC: Total Capacity(kW), SHC: Sensible Heat Capacity(kW)
2. Capacity tables show the average value of conditions which may occur.
3. Refer to Capacity tables and correction factor in the outdoor unit PDB for the actual performance data of each indoor unit and outdoor unit combination.

■ Heating Capacity

Nominal Capacity (kBtu/h) [Capacity Index (kW)]	Indoor air temp. (DB, °C)					
	16	18	20	21	22	24
	TC	TC	TC	TC	TC	TC
7 [2.2]	2.8	2.7	2.5	2.4	2.3	2.2
9 [2.8]	3.6	3.4	3.2	3.1	3.0	2.8
12 [3.6]	4.5	4.3	4.0	3.9	3.7	3.5

Note

1. TC: Total Capacity(kW)
2. Capacity tables show the average value of conditions which may occur.
3. Refer to Capacity tables and correction factor in the outdoor unit PDB for the actual performance data of each indoor unit and outdoor unit combination.

7. Air Velocity and Temperature Distribution

◆ ARNU07GSF14, ARNU09GSF14

Cooling

Discharge angle:40°

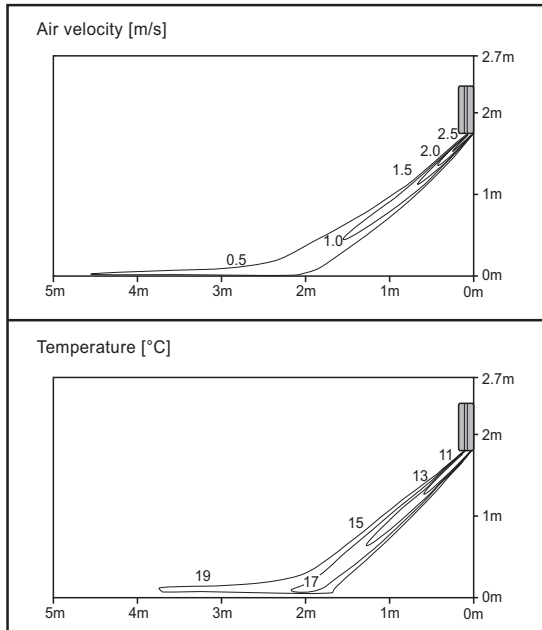

Heating

Discharge angle:50°

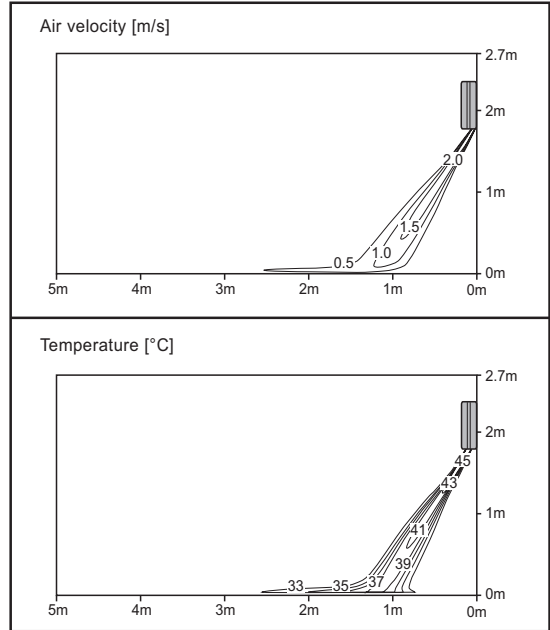

◆ ARNU12GSF14

Cooling

Discharge angle:40°

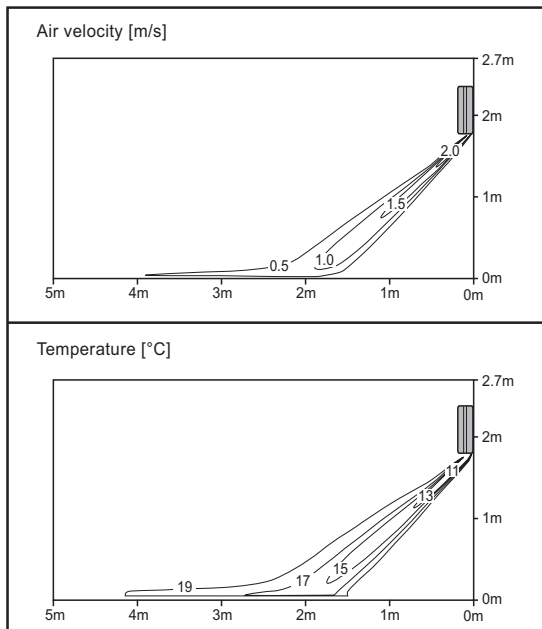

Heating

Discharge angle:50°

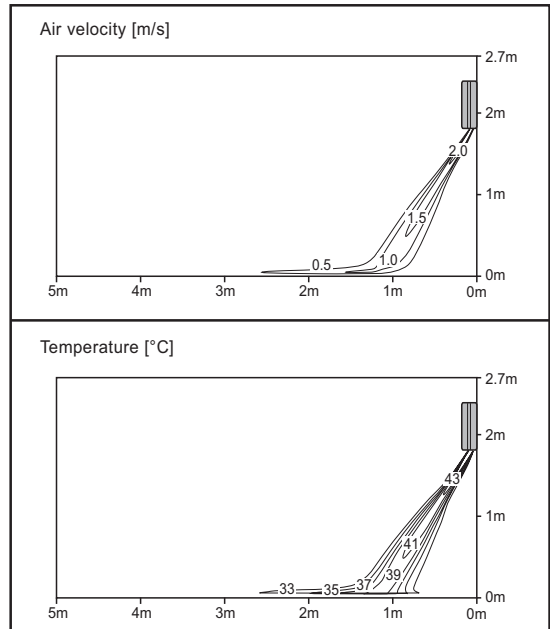

Note

- These figures are accordance with normal certain condition and environment. (Airflow step is 'High', Air discharge angle is fixed as indicated angle.)
- Indoor airflow distribution under actual installation or operating conditions depends on ambient temperature, ceiling height, product installation direction / location, indoor / Heating load, and other obstacles, etc.

8. Electric Characteristics

Units					Power Supply	IFM		PI	
Model	Type	Hz	Volts	Voltage Range	MCA	kW	FLA	Cooling	Heating
ARNU07GSF14	SF	50	220-240	Max:264 Min:198	0.38	0.024	0.30	28	28
ARNU09GSF14	SF				0.38	0.024	0.30	28	28
ARNU12GSF14	SF				0.38	0.024	0.30	32	32
ARNU07GSF14	SF	60	220	Max:242 Min:198	0.38	0.024	0.30	28	28
ARNU09GSF14	SF				0.38	0.024	0.30	28	28
ARNU12GSF14	SF				0.38	0.024	0.30	32	32

Symbols

MCA : Minimum Circuit Amperes (A)

MFA : Maximum Fuse Amperes (A)

kW : Fan Motor Rated Output (kW)

FLA : Full Load Amperes (A)

IFM : Indoor Fan Motor

PI : Maximum Power Input (W)

Note

- Voltage range
Units are suitable for use on electrical systems where voltage supplied to unit terminals is not below or above the listed range limits.
- Maximum allowable voltage unbalance between phases is 2%.
- MCA/MFA
MCA=1.25 x FLA
MFA = 1.1 x MCA, MFA ≤ 4 x FLA
(If MFA is smaller than minimum standard value, Use minimum standard value in region for selecting circuit breaker.)
- Select wire size based on the MCA
- Instead of fuse, use Circuit Breaker.

9. Sound Levels

9.1 Sound Pressure Levels

Overall

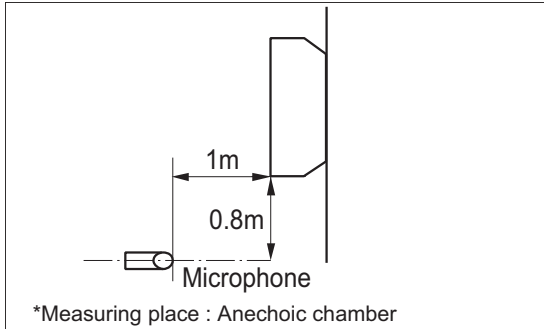

Note

1. Sound measured at some distance away from the center of the unit.
2. Data is valid at free field condition.
3. Reference acoustic pressure 0dB = 20μPa.
4. Data is valid at nominal operation condition.
Refer to the Model Specifications for nominal conditions(Power source and Ambient temperature, etc)
5. Sound levels can be increased in accordance with installation and operating conditions. (Static pressure mode, used air guide, Room target temperature setting, etc)
6. Sound level will vary depending on a range of factors such as the construction(acoustic absorption coefficient) of particular room in which the equipment is installed.
7. Sound pressure level is measured on the rated condition in the anechoic rooms by ISO 3745 standard.
Therefore, these values can be increased owing to ambient conditions during operation.

Model	Sound Pressure Levels [dB(A)]		
	H	M	L
ARNU07GSF14	38	32	27
ARNU09GSF14	38	32	27
ARNU12GSF14	44	38	32

**ARNU07GSF14
ARNU09GSF14**

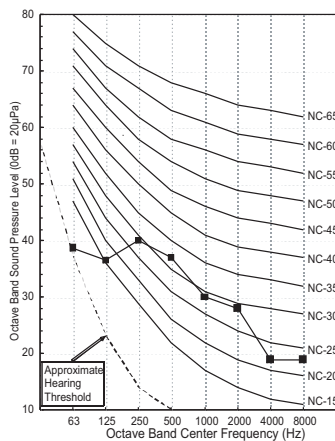

ARNU12GSF14

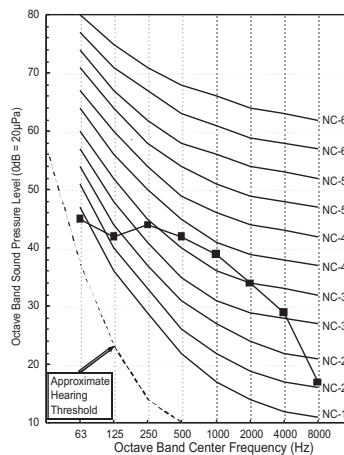

9. Sound Levels

9.2 Sound Power Levels

Note

- Data is valid at diffuse field condition
- Data is valid at nominal operating condition
- Sound level can be increased in static pressure mode or used air guide.
- Sound level will vary depending on a range of factors such as the construction (acoustic absorption coefficient) of particular room in which the equipment is installed.
- Reference acoustic intensity 0dB = $10E-6\mu W/m^2$
- Sound power level is measured on the rated condition in the semi-anechoic rooms by ISO 9614 standard. Therefore, these values can be increased owing to ambient conditions during operation.

Model	Sound Power Levels [dB(A)]		
	H	M	L
ARNU07GSF14	48	46	41
ARNU09GSF14	48	46	41
ARNU12GSF14	54	48	42

**ARNU07GSF14
ARNU09GSF14**

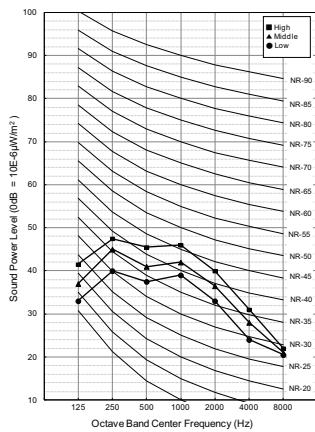

ARNU12GSF14

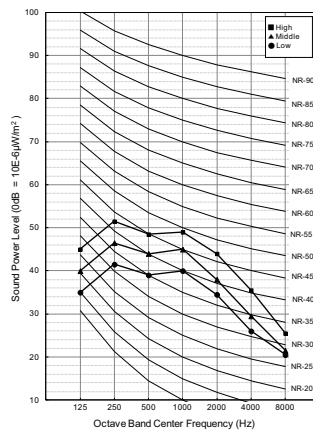

MULTI V™

Indoor Unit

Console

- 1. List of functions**
- 2. Specifications**
- 3. Dimensions**
- 4. Piping Diagrams**
- 5. Wiring Diagrams**
- 6. Capacity Tables**
- 7. Air Velocity and Temperature Distribution**
- 8. Electric Characteristics**
- 9. Sound Levels**

1. List of functions

Category	Function	ARNU07GQAA4, ARNU09GQAA4, ARNU12GQAA4, ARNU15GQAA4
Air Flow	Air Supply Outlet	2
	Airflow Direction Control (left & right)	Manual(Upper Vane Only)
	Airflow Direction Control (up & down)	Auto(Upper Vane Only)
	Auto Swing (left & right)	X
	Auto Swing (up & down)	O(Upper Vane Only)
	Airflow Steps (fan/cool/heat)	4 / 5 / 5
	Fan Speed Auto*	X
	Power Cool/Heat	O / O
	Swirl Wind*	X
	Refresh Mode**	X
	Smart Mode**	X
	Indirect Wind*	O
	Direct Wind*	O
Dry Operation	O	
Air Purification	Air Purify	X
	Ionizer	X
	UV-C	X
	Pre-Filter	O
Reliability	Hot Start	O
	Self Diagnosis	O
Convenience	Auto Mode	O
	Auto Dry Operation	O
	Auto Restart	O
	Child Lock*	O
	Forced Operation	O
	Group Control*	O
	Sleep Timer	O
	Turn On/Off Reservation	O
	Schedule*	O
	Two Thermistor Control*	O
External On/Off	O	
Installation	Drain Pump	X
	E.S.P. Control*	X
	High Ceiling Operation*	X
Special Functions	Wi-Fi	Accessory
	Auto Elevation Grille	X
	Human Detection Function**	X
	Floor Detection Function**	X

Note

- O : Applied, X : Not Applied, - : Unconfirmed or irrelevant
 Embedded : A kit is provided by default for using this function when the product is manufactured.
 Accessory : Ordered and purchased separately the accessory package referring to the model name provided and install at field. Accessory line-ups varies by region, so check your local catalogue or local sales material.
- Some functions can be limited by remote controller.
- In case of cassette type indoor units, Air Purification Kit and Auto Elevation Grille functions are not applicable at the same time.
- 'Auto Mode' varies depending on the outdoor unit type.
 - Auto Change Over(Heat Recovery Outdoor Unit)
 - Auto Mode Select(Heat Pump Outdoor Unit)
 - Auto Intensity Control(Cooling Only Outdoor Unit)
- * : These functions need to connect the wired remote controller.
- ** : These functions need to connect to the Standard III wired remote controller.

1. List of functions

■ Accessory Compatibility List

Category	Accessory Name	Model Name	Description	ARNU07GQAA4 ARNU09GQAA4 ARNU12GQAA4 ARNU15GQAA4
Remote Controller	Wired - Premium	PREMTA000	-	○
		PREMTA000A	-	○
		PREMTA000B	-	○
	Wired - RS3 (Standard III)	PREMTB100/PREMTB101	White	○
		PREMTBB10/PREMTBB11	Black	○
	Wired - RS2 (Standard II)	PREMTB001	White	○
		PREMTBB01	Black	○
	Wired - Simple	PQRCVCL0QW	White	○
		PQRCVCL0Q	Black	○
	Wired - Simple for Hotel	PQRCHCA0QW	White	○
		PQRCHCA0Q	Black	○
	Wireless	PQWRCQ0FDB	For Cooling only	○
PQWRHQ0FDB		For Heat pump	○	
PWLSSB21C		For Cooling only	○	
PWLSSB21H		For Heat pump	○	
Dry Contact	Simple	PDRYCB000	1 input port, AC 220 - 240V	○
		PDRYCB100	1 input port, AC 24V	○
	Communication	PDRYCB400	2 input port	○
		PDRYCB300	8 input port, For 3rd party Thermostat	○
		PDRYCB320	8 input port, For 3rd Party Thermostat (Analog Input)	○
PDRYCB500	For 3rd Party Controller (Modbus RTU)	○		
Integration Device	Remote Temperature sensor	PQRSTA0	-	X
	Group Control wire	PZCWRCG3	Cable Assembly for group control (Y-type cable : 0.25m, cable : 9.6m)	○
ETC	Extension wire	PZCWRC1	Extension wire for IDU-wired remote controller (9.6m)	X
	2-Remo Control Wire	PZCWRC2	-	X
	Wi-Fi Modem	PWFMDD200	-	○
	Wi-Fi Extension cable	PWYREW000	USB Extension cable : 10 m	○
	Independent Power Module	PRIP0	-	○
	Multi-tenant Power Module	PINPMB001	-	○
	Refrigerant Leakage Detector	PRLDNVS0	For R410A only	○
	Human Detection Sensor	PTVSMA0	For Cassette 4-way	X
		PTVSAA0	For Cassette Dual Vane 4-way	X
	Floor Detection Sensor	PTFSMA0	-	X
	Auto Elevation Grille	PTEGM0	For TP/TN/TM	X
	Air Purification Kit	PTAHTP0	For Cassette 1-way	X
		PTAHMP0	For Cassette 4-way	X
		PTAHYP0	For Cassette Round	X
	EEV Kit	PRGK024A0	For Multi V Indoor Unit	○
	Auxiliary Heater Relay Kit	PRARS1	For Wall Mounted and Art Cool Indoor Units	X
		PRARH1	For Cassette and Duct Indoor Units	X
	Ventilation Kit	PTVK430	For TR/TQ/TP/TN/TM	X
		PTVK410 + PTVK420	For TP/TN/TM	X
	Cassette Cover	PTDCQ	For TR/TQ	X
PTDCM		For TP/TN/TM	X	
PTDCA		For TM-A/TP-B	X	
Note				
1. O: Possible, X: Impossible, - : Not applicable, Embedded : Included with product.				
2. If there is a difference in development time between the product and the remote controller, some functions cannot be operated.				
3. If using Wi-Fi controller, Some advanced functions controlled by remote controller cannot be operated.				
4. If you need more detail, please refer to the BECON PDB or the manual of product. (http://partner.lge.com/global : Home> Doc.Library> Product > Control(BECON))				

2. Specifications

Type			Console	
Model	Unit		ARNU07GQAA4	ARNU09GQAA4
Cooling Capacity	kW		2.2	2.8
	kcal/h		1,900	2,400
	Btu/h		7,500	9,600
Heating Capacity	kW		2.5	3.2
	kcal/h		2,200	2,800
	Btu/h		8,500	10,900
Power Input (H / M / L)		W	15 / 12 / 10	15 / 12 / 10
Casing			Galvanized Steel Plate	Galvanized Steel Plate
Dimensions (WxHxD)	Body	mm	700 x 600 x 210	700 x 600 x 210
		inch	27-9/16 x 23-5/8 x 8-1/4	27-9/16 x 23-5/8 x 8-1/4
Coil	Rows x Columns x FPI		19 x 2 x 19	19 x 2 x 19
	Face Area	m ²	-	-
Fan	Type		Turbo fan	Turbo fan
	Motor Output x Number		W	48 x 1
	Air Flow Rate (H / M / L)	m ³ /min	6.7 / 5.9 / 4.8	6.7 / 5.9 / 4.8
		ft ³ /min	236 / 209 / 170	236 / 209 / 170
	Drive		Direct	Direct
Motor type		BLDC	BLDC	
Temperature Control			Microprocessor, Thermostat for cooling and heating	
Sound Absorbing Thermal Insulation Material			Foamed polystyrene	Foamed polystyrene
Safety Device			Fuse	Fuse
Pipe Connections	Liquid Side	mm(inch)	Ø6.35(1/4)	Ø6.35(1/4)
	Gas Side	mm(inch)	Ø12.7(1/2)	Ø12.7(1/2)
	Drain(OD/ID)	mm	17/12.2	17/12.2
Net Weight Body		kg(lbs)	15.2(33.5)	15.2(33.5)
Sound Pressure Levels (H / M / L)		dB(A)	37 / 34 / 28	37 / 34 / 28
Sound Power Levels (H / M / L)		dB(A)	53 / 50 / 44	53 / 50 / 44
Power Supply		Ø, V, Hz	1, 220 - 230 - 240, 50/60	1, 220 - 230 - 240, 50/60
Running Current by voltage	Rated	A	0.12 - 0.12 - 0.11	0.12 - 0.12 - 0.11
Maximum Running Current		A	0.30	0.30
Refrigerant	Type		-	R410A / R32
	Additional Charging Amount (CF Value of IDU)		kg(each)	0.17 / 0.14
	Control		-	EEV
Transmission cable		mm ²	1.0 ~ 1.5 x 2C	1.0 ~ 1.5 x 2C

Note

- Due to our policy of innovation some specifications may be changed without notification.
- Wiring cable size must comply with the applicable local and national code. And "Electric characteristics" chapter should be considered for electrical work and design. Especially the power cable and circuit breaker should be selected in accordance with that.
- Sound pressure level is measured on the rated condition in the anechoic rooms by ISO 3745 standard.
Sound power level is measured on the rated condition in the semi-anechoic rooms by ISO 9614 standard.
Therefore, these values can be increased owing to ambient conditions during operation.
- Capacities are net capacities and based on the following conditions. Refer to the Outdoor Unit Specifications for calculating the real capacity.
 - Cooling : Indoor Ambient Temp. 27°CDB / 19°CWB, Outdoor Ambient Temp. 35°CDB / 24°CWB
 - Heating : Indoor Ambient Temp. 20°CDB / 15°CWB, Outdoor Ambient Temp. 7°CDB / 6°CWB
 - Interconnected Pipe is standard length and difference of Elevation (Outdoor ~ Indoor Unit) is 0m.
- Refrigerant information (type, additional charging amount, etc.) must be applied by refrigerant type of the combined outdoor unit.
Adapt after checking the specifications of outdoor unit.

2. Specifications

Type			Console		
Model	Unit		ARNU12GQAA4	ARNU15GQAA4	
Cooling Capacity	kW		3.6	4.5	
	kcal/h		3,100	3,900	
	Btu/h		12,300	15,400	
Heating Capacity	kW		4.0	5.0	
	kcal/h		3,400	4,300	
	Btu/h		13,600	17,100	
Power Input (H / M / L)	W		18 / 15 / 13	24 / 19 / 17	
Casing			Galvanized Steel Plate	Galvanized Steel Plate	
Dimensions (WxHxD)	Body	mm	700 x 600 x 210	700 x 600 x 210	
		inch	27-9/16 x 23-5/8 x 8-1/4	27-9/16 x 23-5/8 x 8-1/4	
Coil	Rows x Columns x FPI		19 x 2 x 19	19 x 2 x 19	
	Face Area	m ²	-	-	
Fan	Type		Turbo fan	Turbo fan	
	Motor Output x Number	W	48 x 1	48 x 1	
	Air Flow Rate (H / M / L)	m ³ /min		7.5 / 5.9 / 4.8	8.7 / 6.7 / 5.9
		ft ³ /min		265 / 209 / 170	307 / 236 / 209
	Drive		Direct	Direct	
Motor type		BLDC	BLDC		
Temperature Control			Microprocessor, Thermostat for cooling and heating		
Sound Absorbing Thermal Insulation Material			Foamed polystyrene	Foamed polystyrene	
Safety Device			Fuse	Fuse	
Pipe Connections	Liquid Side	mm(inch)	Ø6.35(1/4)	Ø6.35(1/4)	
	Gas Side	mm(inch)	Ø12.7(1/2)	Ø12.7(1/2)	
	Drain(OD/ID)	mm	17/12.2	17/12.2	
Net Weight Body	kg(lbs)		15.2(33.5)	15.2(33.5)	
Sound Pressure Levels (H / M / L)	dB(A)		39 / 34 / 28	42 / 37 / 31	
Sound Power Levels (H / M / L)	dB(A)		56 / 50 / 44	58 / 53 / 50	
Power Supply	Ø, V, Hz		1, 220 - 230 - 240, 50/60	1, 220 - 230 - 240, 50/60	
Running Current by voltage	Rated	A	0.15 - 0.14 - 0.14	0.20 - 0.19 - 0.18	
Maximum Running Current		A	0.30	0.30	
Refrigerant	Type	-	R410A / R32	R410A / R32	
	Additional Charging Amount (CF Value of IDU)	kg(each)	0.17 / 0.14	0.17 / 0.14	
	Control	-	EEV	EEV	
Transmission cable	mm ²		1.0 ~ 1.5 x 2C	1.0 ~ 1.5 x 2C	

Note

1. Due to our policy of innovation some specifications may be changed without notification.
2. Wiring cable size must comply with the applicable local and national code. And "Electric characteristics" chapter should be considered for electrical work and design. Especially the power cable and circuit breaker should be selected in accordance with that.
3. Sound pressure level is measured on the rated condition in the anechoic rooms by ISO 3745 standard.
Sound power level is measured on the rated condition in the semi-anechoic rooms by ISO 9614 standard.
Therefore, these values can be increased owing to ambient conditions during operation.
4. Capacities are net capacities and based on the following conditions. Refer to the Outdoor Unit Specifications for calculating the real capacity.
 - Cooling : Indoor Ambient Temp. 27°CDB / 19°CWB, Outdoor Ambient Temp. 35°CDB / 24°CWB
 - Heating : Indoor Ambient Temp. 20°CDB / 15°CWB, Outdoor Ambient Temp. 7°CDB / 6°CWB
 - Interconnected Pipe is standard length and difference of Elevation (Outdoor ~ Indoor Unit) is 0m.
5. Refrigerant information (type, additional charging amount, etc.) must be applied by refrigerant type of the combined outdoor unit.
Adapt after checking the specifications of outdoor unit.

3. Dimensions

3.1 Dimensional Drawings

ARNU07GQAA4 / ARNU09GQAA4 / ARNU12GQAA4 / ARNU15GQAA4

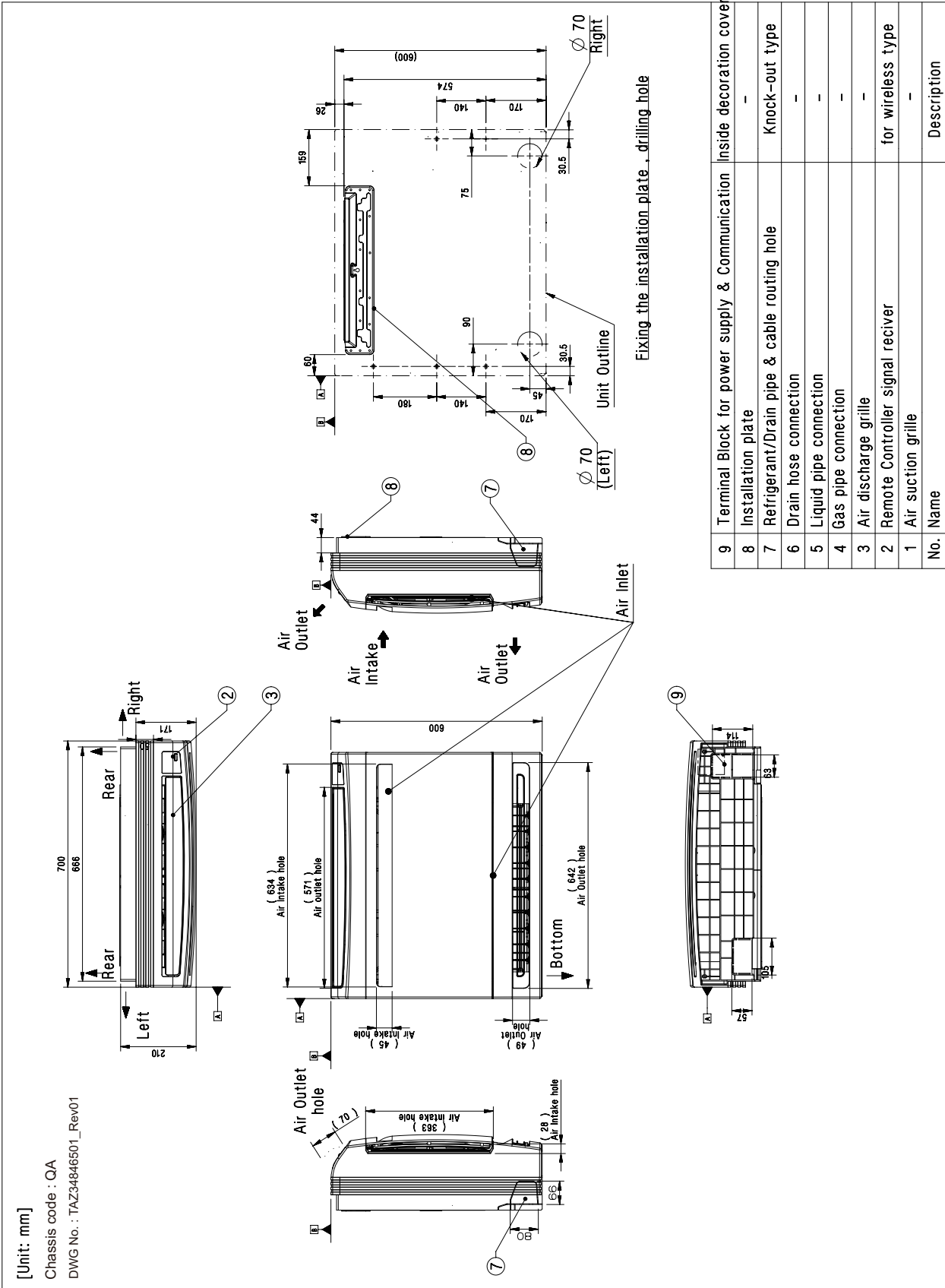

No.	Name	Description
9	Terminal Block for power supply & Communication	Inside decoration cover
8	Installation plate	-
7	Refrigerant/Drain pipe & cable routing hole	Knock-out type
6	Drain hose connection	-
5	Liquid pipe connection	-
4	Gas pipe connection	-
3	Air discharge grille	-
2	Remote Controller signal receiver	for wireless type
1	Air suction grille	-

3. Dimensions

3.2 Installation Space

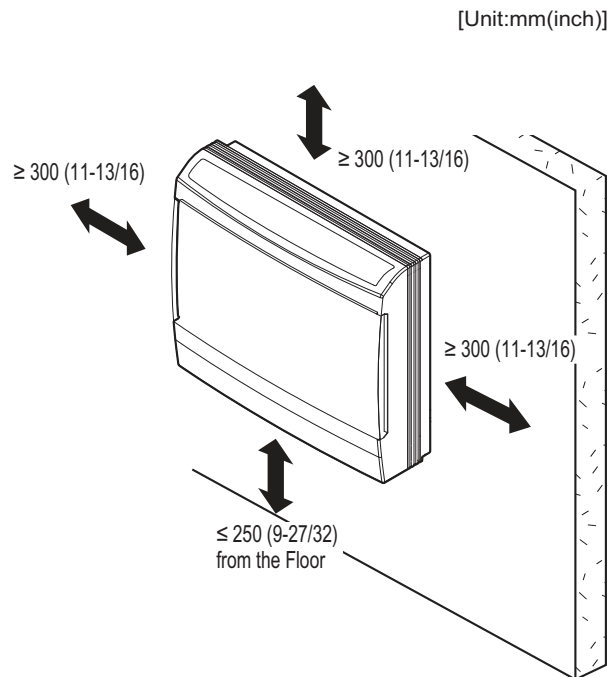

Note

- Places where products are installed should not be any obstacles to the air circulation or installation. Ensure the spaces from the wall, ceiling, or other obstacles.
- According to type of indoor unit, external appearance or installed structure could be different.
- According to product type, model line up, sales region..etc, applicability of each chassis could be different.

4. Piping Diagrams

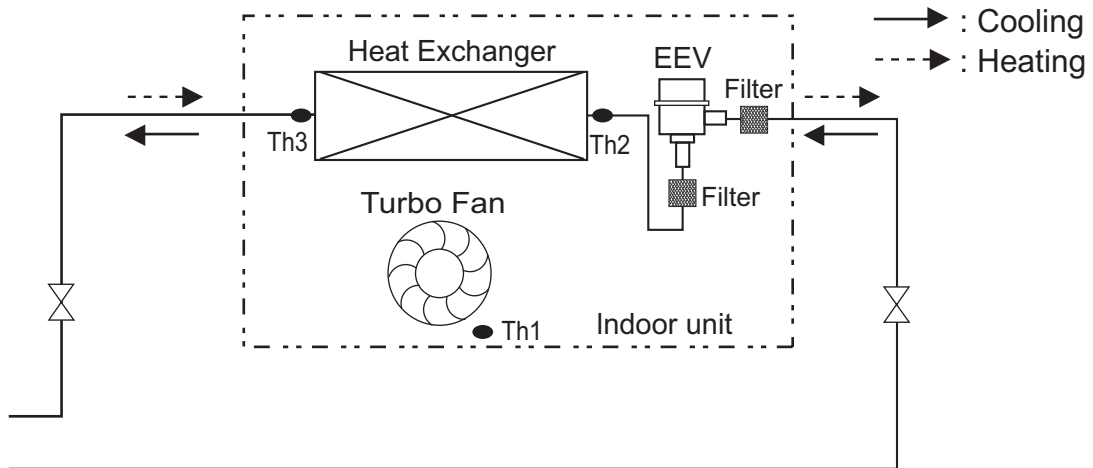

◆ Refrigerant pipe connection port diameter

Model	Gas [mm(inch)]	Liquid [mm(inch)]
ARNU07GQAA4	Ø12.7(1/2)	Ø6.35(1/4)
ARNU09GQAA4	Ø12.7(1/2)	Ø6.35(1/4)
ARNU12GQAA4	Ø12.7(1/2)	Ø6.35(1/4)
ARNU15GQAA4	Ø12.7(1/2)	Ø6.35(1/4)

LOC.	Description
Th1	Room thermistor
Th2	Pipe in thermistor
Th3	Pipe out thermistor

5. Wiring Diagrams

■ QA Chassis

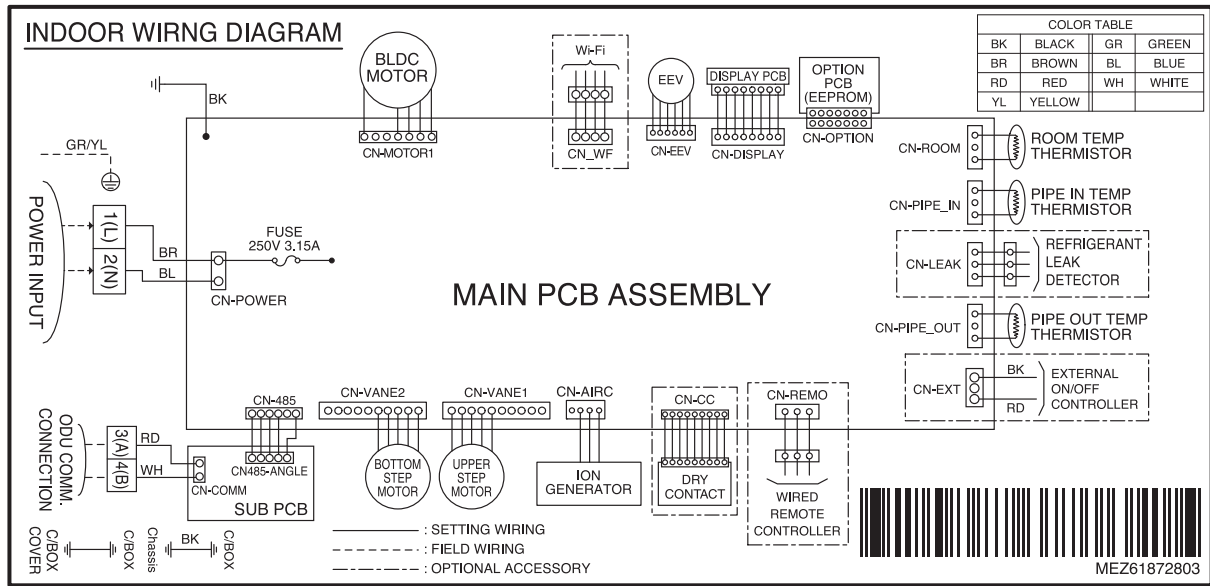

CONNECTOR NUMBER	LOCATION POINT	FUNCTION
CN-POWER	AC Power supply	AC Power line input for indoor controller
CN-MOTOR1	Fan motor output	Motor output of BLDC
CN-485	Communication	Connection between indoor and outdoor
CN-DISP	Display	Display of indoor status
CN-EEV	EEV Output	EEV Control output : connect to EEV directly or through IPM(Independent Power Module)
CN-LEAK	Refrigerant leak detector	Refrigerant leak detector line
CN-VANE2	Step motor	Step motor output
CN-FLOAT	Float switch input	Float switch sensing
CN-PIPE_IN	Suction pipe sensor	Pipe in thermistor
CN-PIPE_OUT	Discharge pipe sensor	Pipe out thermistor
CN-ROOM	Room sensor	Room air thermistor
CN-REMO	Remote controller	Remote control line
CN-CC	Dry contact	Dry contact line
CN-AIRC	Air clean	Air cleaner control
CN_WF	Wi-Fi Controller	Wifi control line

Dip Switch Setting		Off	On	Remarks
SW3	GROUP	Master	Slave	Group Control setting using Wired Remote Controller
SW4	DRY CONTACT	Variable	Auto	Old Dry Contact Mode Setting 1. Variable : Auto/Manual Mode can be chosen by Wide wired remote controller or Wireless remote controller (When shipped from Factory → Manual Mode) 2. Auto : For Dry Contact, it is always Auto mode.
SW5	EXTRA 1	Off	On	1. Duct model -. OFF : Default(not operate continuously) -. ON : Fan operate continuously 2. Cassette Model : No Function 3. Ceiling Suspended Model -. OFF : Ceiling(default) -. ON : Floor

⚠ CAUTION

For Multi V Model, Dip Switch 1,2,6,7,8 must be set OFF
 That dip switch is used for the other model.

6. Capacity Tables

■ Cooling Capacity

Nominal Capacity (kBtu/h) [Capacity Index (kW)]	Indoor air temp. (DB/WB, °C)													
	20		23		26		27		28		30		32	
	14		16		18		19		20		22		24	
	TC	SHC	TC	SHC	TC	SHC	TC	SHC	TC	SHC	TC	SHC	TC	SHC
7 [2.2]	1.5	1.3	1.8	1.4	2.1	1.6	2.2	1.6	2.3	1.6	2.4	1.4	2.4	1.4
9 [2.8]	1.9	1.6	2.3	1.8	2.6	2.0	2.8	2.0	2.9	2.0	3.0	1.7	3.1	1.8
12 [3.6]	2.4	1.9	2.9	2.2	3.4	2.5	3.6	2.6	3.7	2.6	3.9	2.2	3.9	2.3
15 [4.5]	3.0	2.4	3.6	2.7	4.2	3.0	4.5	3.1	4.6	3.1	4.8	2.8	4.9	2.9

Note

1. TC: Total Capacity(kW), SHC: Sensible Heat Capacity(kW)
2. Capacity tables show the average value of conditions which may occur.
3. Refer to Capacity tables and correction factor in the outdoor unit PDB for the actual performance data of each indoor unit and outdoor unit combination.

■ Heating Capacity

Nominal Capacity (kBtu/h) [Capacity Index (kW)]	Indoor air temp. (DB, °C)					
	16	18	20	21	22	24
	TC	TC	TC	TC	TC	TC
7 [2.2]	2.8	2.7	2.5	2.4	2.3	2.2
9 [2.8]	3.6	3.4	3.2	3.1	3.0	2.8
12 [3.6]	4.5	4.3	4.0	3.9	3.7	3.5
15 [4.5]	5.6	5.3	5.0	4.8	4.7	4.4

Note

1. TC: Total Capacity(kW)
2. Capacity tables show the average value of conditions which may occur.
3. Refer to Capacity tables and correction factor in the outdoor unit PDB for the actual performance data of each indoor unit and outdoor unit combination.

7. Air Velocity and Temperature Distribution

◆ ARNU07GQAA4

Cooling

Heating

Discharge angle:40°

Discharge angle:50°

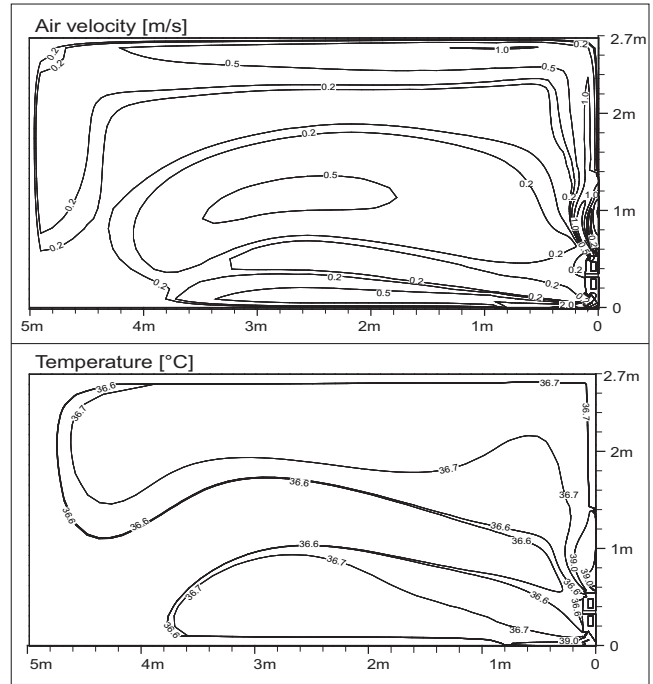
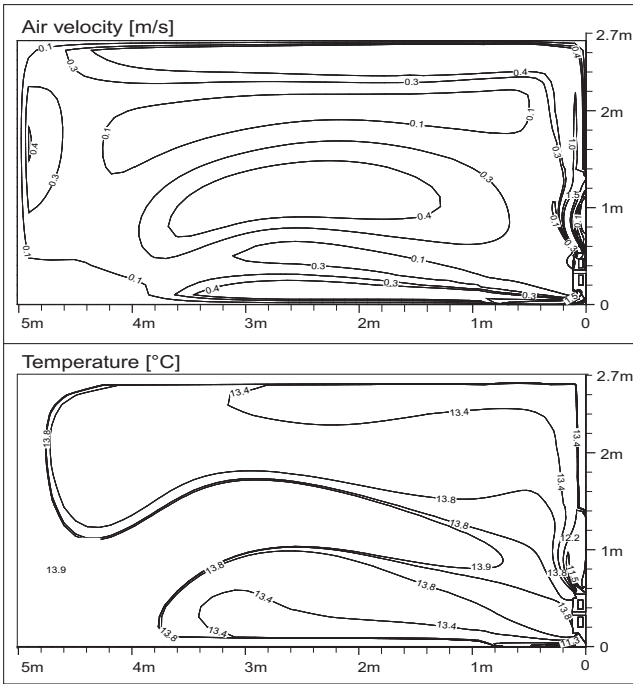

◆ ARNU09GQAA4

Cooling

Heating

Discharge angle:40°

Discharge angle:50°

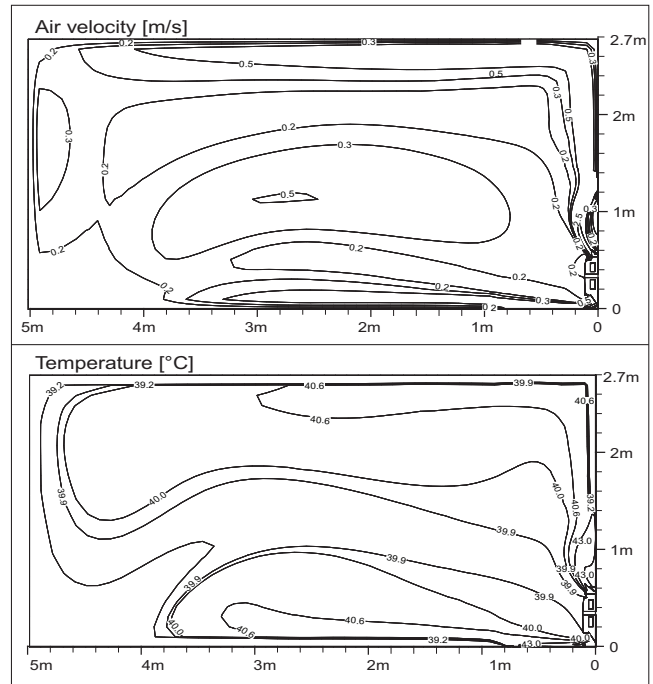
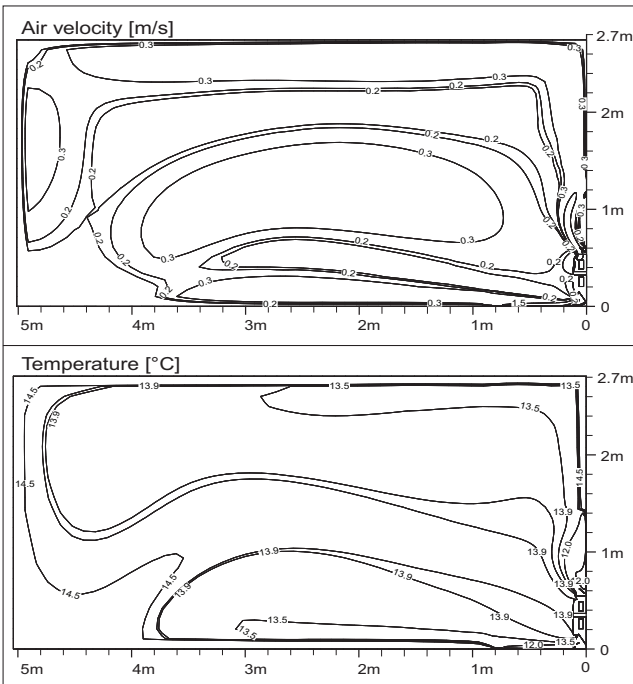

Note

- These figures are accordance with normal certain condition and environment. (Airflow step is 'High', Air discharge angle is fixed as indicated angle.)
- Indoor airflow distribution under actual installation or operating conditions depends on ambient temperature, ceiling height, product installation direction / location, indoor / Heating load, and other obstacles, etc.

7. Air Velocity and Temperature Distribution

◆ ARNU12GQAA4

Cooling

Heating

Discharge angle:40°

Discharge angle:50°

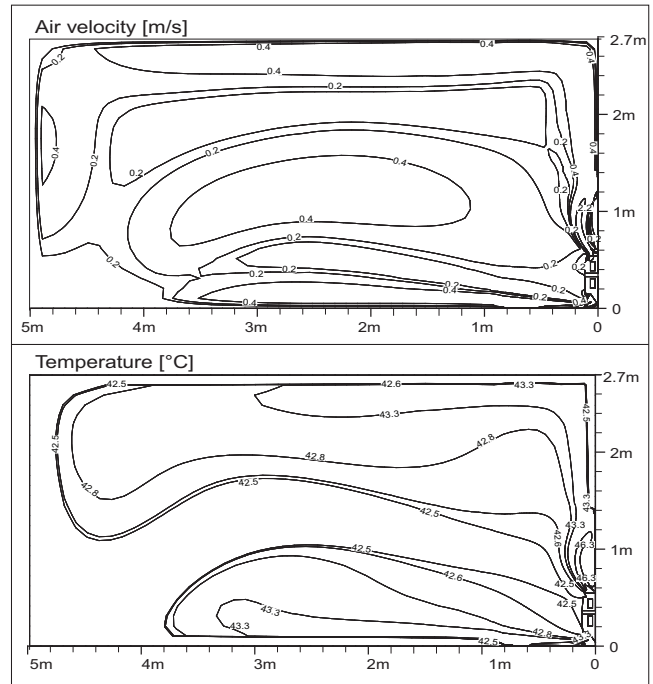
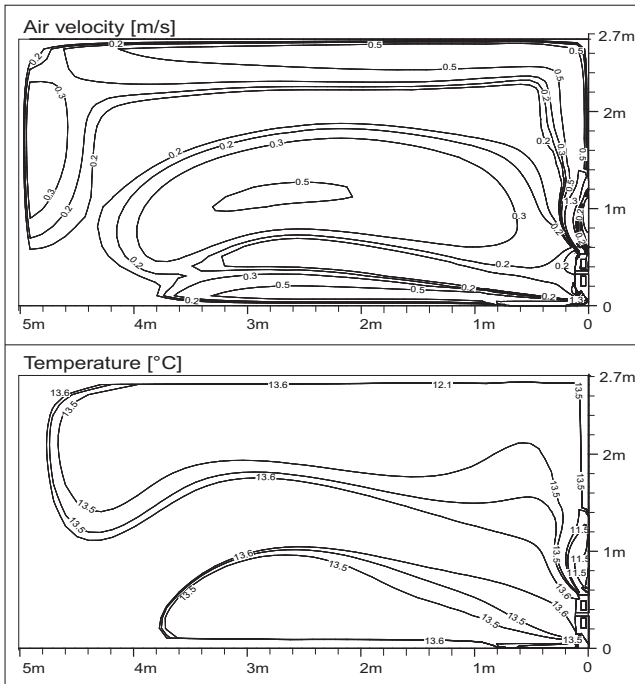

◆ ARNU15GQAA4

Cooling

Heating

Discharge angle:40°

Discharge angle:50°

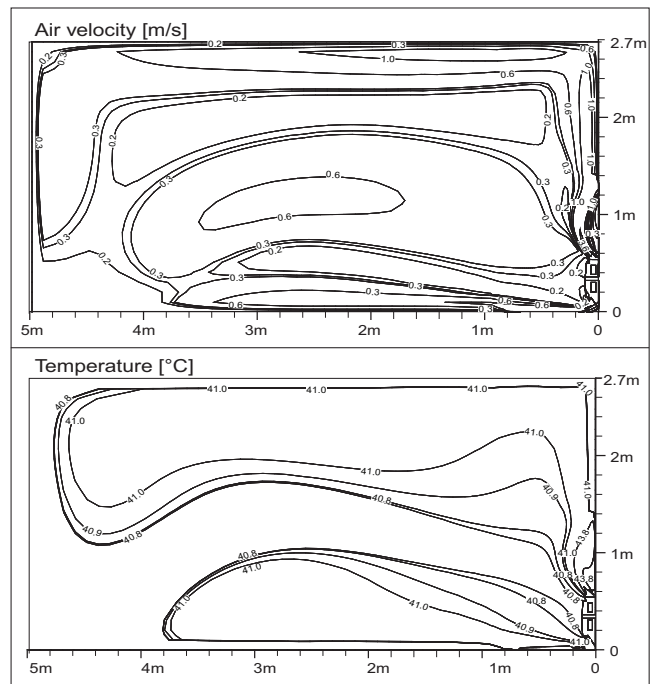
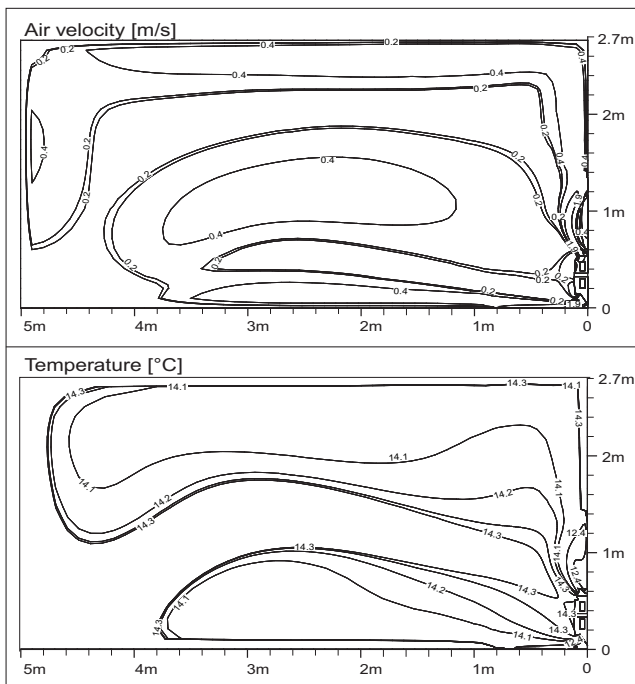

Note

- These figures are accordance with normal certain condition and environment. (Airflow step is 'High', Air discharge angle is fixed as indicated angle.)
- Indoor airflow distribution under actual installation or operating conditions depends on ambient temperature, ceiling height, product installation direction / location, indoor / Heating load, and other obstacles, etc.

8. Electric Characteristics

Units					Power Supply	IFM		PI	
Model	Type	Hz	Volts	Voltage Range	MCA	kW	FLA	Cooling	Heating
ARNU07GQAA4	QA	50	220-240	Min.:198, Max.:264	0.38	0.048	0.30	15	15
ARNU09GQAA4	QA				0.38	0.048	0.30	15	15
ARNU12GQAA4	QA				0.38	0.048	0.30	18	18
ARNU15GQAA4	QA				0.38	0.048	0.30	24	24
ARNU07GQAA4	QA	60	220	Min.:198, Max.:242	0.38	0.048	0.30	15	15
ARNU09GQAA4	QA				0.38	0.048	0.30	15	15
ARNU12GQAA4	QA				0.38	0.048	0.30	18	18
ARNU15GQAA4	QA				0.38	0.048	0.30	24	24

Symbols

MCA : Minimum Circuit Amperes (A)

MFA : Maximum Fuse Amperes (A)

kW : Fan Motor Rated Output (kW)

FLA : Full Load Amperes (A)

IFM : Indoor Fan Motor

PI : Maximum Power Input (W)

Note

1. Voltage range

Units are suitable for use on electrical systems where voltage supplied to unit terminals is not below or above the listed range limits.

2. Maximum allowable voltage unbalance between phases is 2%.

3. MCA/MFA

$MCA = 1.25 \times FLA$

$MFA = 1.1 \times MCA, MFA \leq 4 \times FLA$

(If MFA is smaller than minimum standard value, Use minimum standard value in region for selecting circuit breaker.)

4. Select wire size based on the MCA

5. Instead of fuse, use Circuit Breaker.

9. Sound Levels

9.1 Sound Pressure Levels

Overall

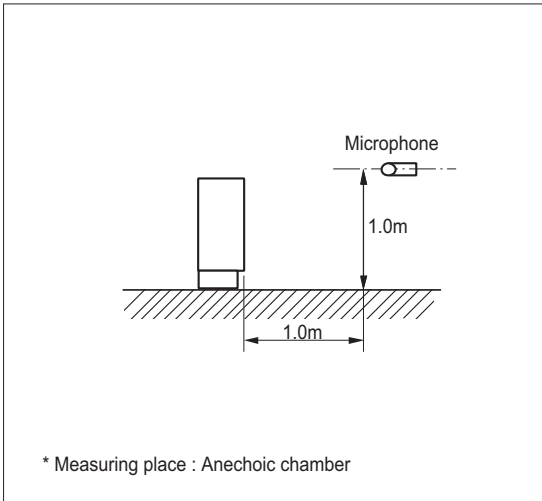

Note

- 1.Sound measured at some distance away from the center of the unit.
- 2.Data is valid at free field condition.
- 3.Reference acoustic pressure 0dB = 20μPa.
- 4.Data is valid at nominal operation condition.
Refer to the Model Specifications for nominal conditions(Power source and Ambient temperature, etc)
- 5.Sound levels can be increased in accordance with installation and operating conditions. (Static pressure mode, used air guide, Room target temperature setting, etc)
- 6.Sound level will vary depending on a range of factors such as the construction(acoustic absorption coefficient) of particular room in which the equipment is installed.
- 7.Sound pressure level is measured on the rated condition in the anechoic rooms by ISO 3745 standard.
Therefore, these values can be increased owing to ambient conditions during operation.

Model	Sound Levels [dB(A)]		
	H	M	L
ARNU07GQAA4	37	34	28
ARNU09GQAA4	37	34	28
ARNU12GQAA4	39	34	28
ARNU15GQAA4	42	37	31

ARNU07GQAA4

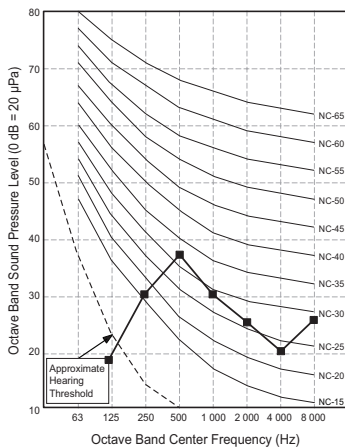

ARNU09GQAA4

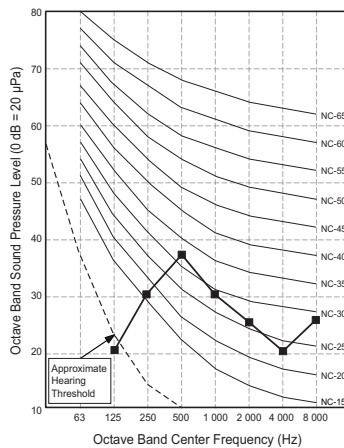

ARNU12GQAA4

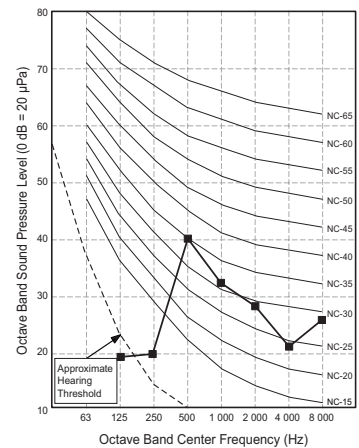

9. Sound Levels

ARNU15GQAA4

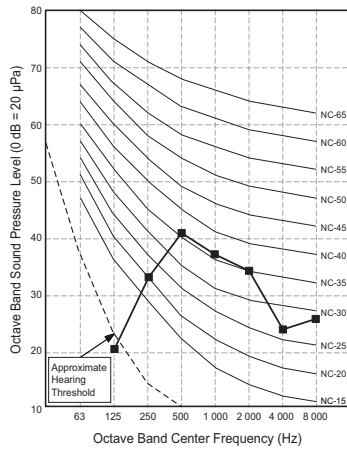

9. Sound Levels

9.2 Sound Power Levels

Note

- Data is valid at diffuse field condition
- Data is valid at nominal operating condition
- Sound level can be increased in static pressure mode or used air guide.
- Sound level will vary depending on a range of factors such as the construction (acoustic absorption coefficient) of particular room in which the equipment is installed.
- Reference acoustic intensity 0dB = 10E-6μW/m²
- Sound power level is measured on the rated condition in the semi-anechoic rooms by ISO 9614 standard. Therefore, these values can be increased owing to ambient conditions during operation.

Model	Sound Power Levels [dB(A)]
	High Fan Speed
ARNU073QAA4	53.0
ARNU093QAA4	53.0
ARNU123QAA4	56.0
ARNU153QAA4	58.0

ARNU073QAA4

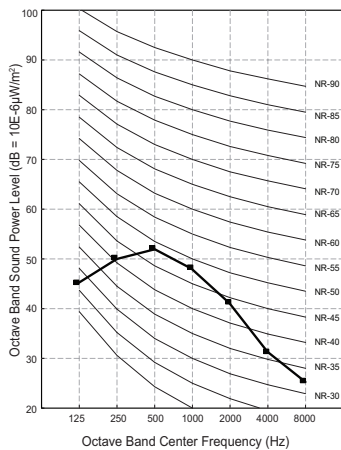

ARNU093QAA4

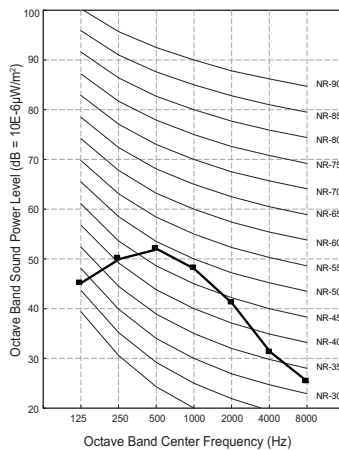

ARNU123QAA4

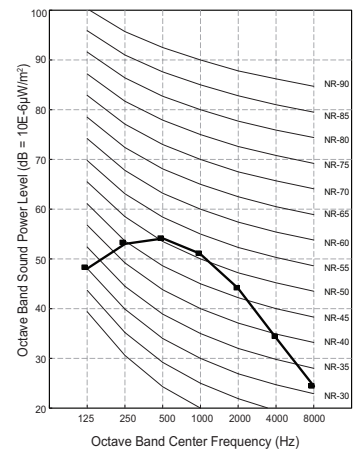

ARNU153QAA4

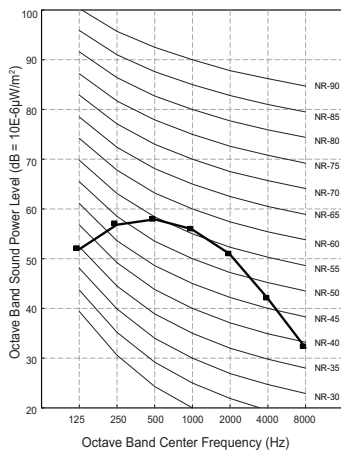

MULTI V™

Indoor Unit

Compact Model

- 1. List of functions**
- 2. Specifications**
- 3. Dimensions**
- 4. Piping Diagrams**
- 5. Wiring Diagrams**
- 6. Capacity Tables**
- 7. Air Velocity and Temperature Distribution**
- 8. Electric Characteristics**
- 9. Sound Levels**

1. List of functions

Category	Function	ARNU09GTR*4, ARNU15GTR*4
Air Flow	Air Supply Outlet	4
	Airflow Direction Control (left & right)	X
	Airflow Direction Control (up & down)	Auto
	Auto Swing (left & right)	X
	Auto Swing (up & down)	O
	Airflow Steps (fan/cool/heat)	4 / 5 / 4
	Fan Speed Auto*	Advanced
	Power Cool/Heat	O / X
	Swirl Wind*	O
	Refresh Mode**	X
	Smart Mode**	X
	Indirect Wind*	O
	Direct Wind*	O
	Dry Operation	O
Air Purification	Air Purify	X
	Ionizer	X
	UV-C	X
	Pre-Filter	O
Reliability	Hot Start	O
	Self Diagnosis	O
Convenience	Auto Mode	O
	Auto Dry Operation	O
	Auto Restart	O
	Child Lock*	O
	Forced Operation	O
	Group Control*	O
	Sleep Timer	O
	Turn On/Off Reservation	O
	Schedule*	O
	Two Thermistor Control*	O
External On/Off	O	
Installation	Drain Pump	O
	E.S.P. Control*	X
	High Ceiling Operation*	O
Special Functions	Wi-Fi	Accessory
	Auto Elevation Grille	X
	Human Detection Function**	X
	Floor Detection Function**	X

Note

- O : Applied, X : Not Applied, - : Unconfirmed or irrelevant
Embedded : A kit is provided by default for using this function when the product is manufactured.
Accessory : Ordered and purchased separately the accessory package referring to the model name provided and install at field. Accessory line-ups varies by region, so check your local catalogue or local sales material.
- Some functions can be limited by remote controller.
- In case of cassette type indoor units, Air Purification Kit and Auto Elevation Grille functions are not applicable at the same time.
- 'Auto Mode' varies depending on the outdoor unit type.
 - Auto Change Over(Heat Recovery Outdoor Unit)
 - Auto Mode Select(Heat Pump Outdoor Unit)
 - Auto Intensity Control(Cooling Only Outdoor Unit)
- * : These functions need to connect the wired remote controller.
- ** : This functions need to connect to the Standard III wired remote controller.

1. List of functions

■ Accessory Compatibility List

Category	Accessory Name	Model Name	Description	ARNU09GTR*4 ARNU15GTR*4
Remote Controller	Wired - Premium	PREMTA000	-	○
		PREMTA000A	-	○
		PREMTA000B	-	○
	Wired - RS3 (Standard III)	PREMTB100/PREMTB101	White	○
		PREMTBB10/PREMTBB11	Black	○
	Wired - RS2 (Standard II)	PREMTB001	White	○
		PREMTBB01	Black	○
	Wired - Simple	PQRCVCL0QW	White	○
		PQRCVCL0Q	Black	○
	Wired - Simple for Hotel	PQRCHCA0QW	White	○
		PQRCHCA0Q	Black	○
	Wireless	PQWRCQ0FDB	For Cooling only	○
		PQWRHQ0FDB	For Heat pump	○
PWLSSB21C		For Cooling only	○	
PWLSSB21H		For Heat pump	○	
Dry Contact	Simple	PDRYCB000	1 input port, AC 220 - 240V	○
		PDRYCB100	1 input port, AC 24V	○
	Communication	PDRYCB400	2 input port	○
		PDRYCB300	8 input port, For 3rd party Thermostat	○
		PDRYCB320	8 input port, For 3rd Party Thermostat (Analog Input)	○
PDRYCB500	For 3rd Party Controller (Modbus RTU)	○		
Integration Device	Remote Temperature sensor	PQRSTA0	-	○
	Group Control wire	PZCWRCG3	Cable Assembly for group control (Y-type cable : 0.25m, cable : 9.6m)	○
ETC	Extension wire	PZCWRC1	Extension wire for IDU-wired remote controller (9.6m)	○
	2-Remo Control Wire	PZCWRC2	-	○
	Wi-Fi Modem	PWFMDD200	-	○
	Wi-Fi Extension cable	PWYREW000	USB Extension cable : 10 m	○
	Independent Power Module	PRIP0	-	○
	Multi-tenant Power Module	PINPMB001	-	○
	Refrigerant Leakage Detector	PRLDNVS0	For R410A only	○
	Human Detection Sensor	PTVSMA0	For Cassette 4-way	X
		PTVSA0	For Cassette Dual Vane 4-way	X
	Floor Detection Sensor	PTFSMA0	-	X
	Auto Elevation Grille	PTEGM0	For TP/TN/TM	X
	Air Purification Kit	PTAHTP0	For Cassette 1-way	X
		PTAHMP0	For Cassette 4-way	X
		PTAHYP0	For Cassette Round	X
	EEV Kit	PRGK024A0	For Multi V Indoor Unit	○
	Auxiliary Heater Relay Kit	PRARS1	For Wall Mounted and Art Cool Indoor Units	X
		PRARH1	For Cassette and Duct Indoor Units	○
	Ventilation Kit	PTVK430	For TR/TQ/TP/TN/TM	○
		PTVK410 + PTVK420	For TP/TN/TM	X
	Cassette Cover	PTDCQ	For TR/TQ	○
PTDCM		For TP/TN/TM	X	
PTDCA		For TM-A/TP-B	X	

Note

1. ○: Possible, X: Impossible, -: Not applicable, Embedded : Included with product.
2. If there is a difference in development time between the product and the remote controller, some functions cannot be operated.
3. If using Wi-Fi controller, Some advanced functions controlled by remote controller cannot be operated.
4. If you need more detail, please refer to the **BECON** PDB or the manual of product. (<http://partner.lge.com/global> : Home> Doc.Library> Product > Control(BECON))

2. Specifications

* Model Name E/A:Basic, F/C:Plasma

Type			4 Way Ceiling Cassette		
Model		Unit	ARNU09GTR*4	ARNU15GTR*4	
Cooling Capacity		kW	2.8	4.5	
		kcal/h	2,400	3,900	
		Btu/h	9,600	15,400	
Heating Capacity		kW	3.2	5.0	
		kcal/h	2,800	4,300	
		Btu/h	10,900	17,100	
Power Input (H / M / L)		W	14 / 13 / 12	18 / 15 / 14	
Casing			Galvanized Steel Plate	Galvanized Steel Plate	
Dimensions (WxHxD)	Body	mm	570 x 214 x 570	570 x 214 x 570	
		inch	22-7/16 x 8-7/16 x 22-7/16	22-7/16 x 8-7/16 x 22-7/16	
	Decoration Panel #1	mm	700 x 22 x 700	700 x 22 x 700	
		inch	27-9/16 x 7/8 x 27-9/16	27-9/16 x 7/8 x 27-9/16	
	Decoration Panel #2	mm	620 x 34 x 620	620 x 34 x 620	
		inch	24-13/32 x 1-11/32 x 24-13/32	24-13/32 x 1-11/32 x 24-13/32	
Coil	Rows x Columns x FPI		1 x 8 x 18	2 x 8 x 18	
	Face Area		m ²	0.21	
Fan	Type		Turbo Fan	Turbo Fan	
	Motor Output x Number		W	43 x 1	
	Air Flow Rate (H / M / L)	m ³ /min		8.2 / 7.4 / 6.9	9.2 / 7.5 / 7.0
		ft ³ /min		289 / 261 / 244	325 / 265 / 247
	Drive		Direct	Direct	
Motor type		BLDC	BLDC		
Temperature Control			Microprocessor, Thermostat for cooling and heating		
Sound Absorbing Thermal Insulation Material			Foamed polystyrene	Foamed polystyrene	
Safety Device			Fuse	Fuse	
Pipe Connections	Liquid Side	mm(inch)	Ø6.35(1/4)	Ø6.35(1/4)	
	Gas Side	mm(inch)	Ø12.7(1/2)	Ø12.7(1/2)	
	Drain Pipe(Internal Dia.)	mm(inch)	25(1)	25(1)	
Net Weight	Body	kg(lbs)	12.6(27.8)	13.7(30.2)	
	Packaged	kg(lbs)	15.3(33.7)	16.4(36.1)	
Sound Pressure Levels (H / M / L)		dB(A)	33 / 31 / 28	37 / 33 / 30	
Sound Power Levels (H / M / L)		dB(A)	-	-	
Power Supply		Ø, V, Hz	1, 220 - 230 - 240, 50/60	1, 220 - 230 - 240, 50/60	
Running Current by voltage	Rated	A	0.10 - 0.09 - 0.09	0.13 - 0.12 - 0.12	
Maximum Running Current		A	0.20	0.20	
Refrigerant	Type	-	R410A / R32	R410A / R32	
	Additional Charging Amount (CF Value of IDU)	kg(each)	0.18 / 0.15	0.25 / 0.21	
	Control	-	EEV	EEV	
Transmission cable		mm ²	1.0~1.5 x 2C	1.0~1.5 x 2C	
Panel Color			Morning fog	Morning fog	
Panel Name(Accessory)			PT-UQC / PT-QCHW0	PT-UQC / PT-QCHW0	

Note

- Due to our policy of innovation some specifications may be changed without notification.
- Wiring cable size must comply with the applicable local and national code. And "Electric characteristics" chapter should be considered for electrical work and design. Especially the power cable and circuit breaker should be selected in accordance with that.
- Sound pressure level is measured on the rated condition in the anechoic rooms by ISO 3745 standard.
Sound power level is measured on the rated condition in the semi-anechoic rooms by ISO 9614 standard.
Therefore, these values can be increased owing to ambient conditions during operation.
- Capacities are net capacities and based on the following conditions. Refer to the Outdoor Unit Specifications for calculating the real capacity.
 - Cooling : Indoor Ambient Temp. 27°CDB / 19°CWB, Outdoor Ambient Temp. 35°CDB / 24°CWB
 - Heating : Indoor Ambient Temp. 20°CDB / 15°CWB, Outdoor Ambient Temp. 7°CDB / 6°CWB
 - Interconnected Pipe is standard length and difference of Elevation (Outdoor ~ Indoor Unit) is 0m.
- Refrigerant information (type, additional charging amount, etc.) must be applied by refrigerant type of the combined outdoor unit.
Adapt after checking the specifications of outdoor unit.

3. Dimensions

3.1 Dimensional Drawings

ARNU15GTR*4 / ARNU09GTR*4

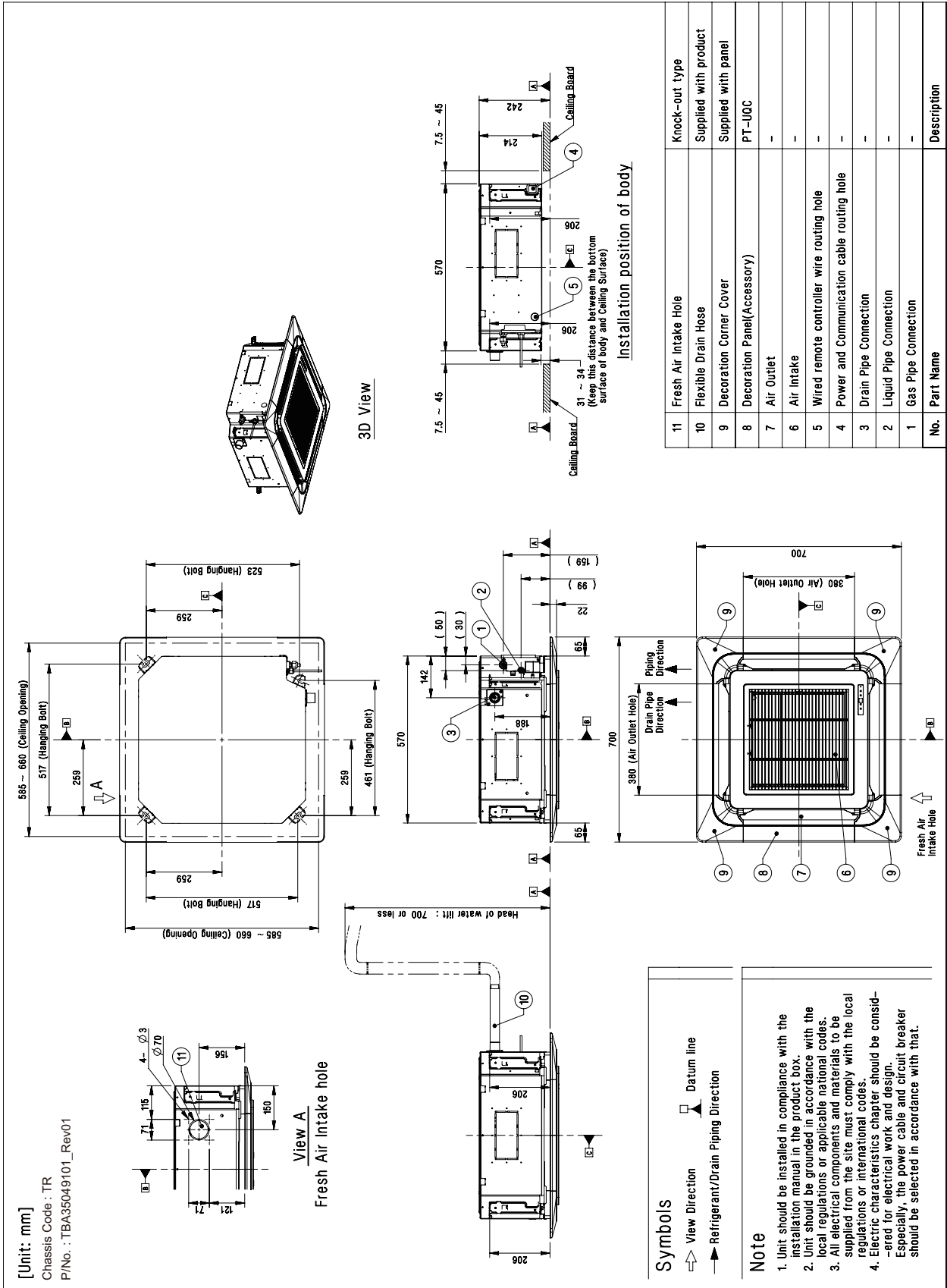

3. Dimensions

3.2 Installation Space

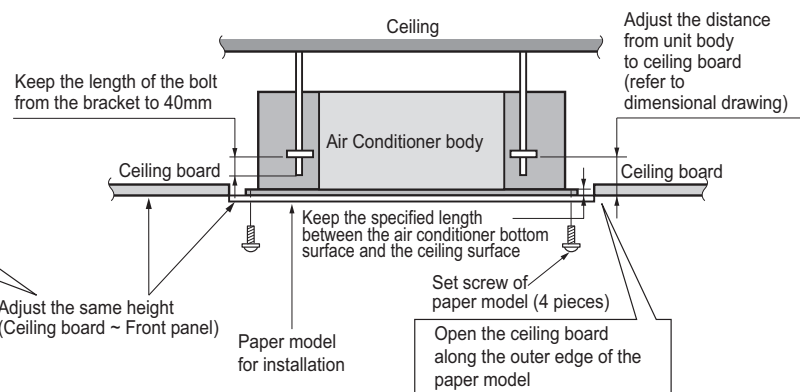
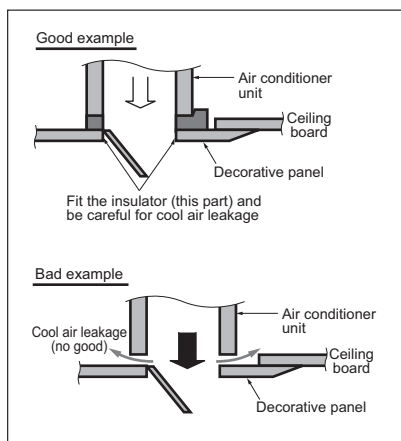
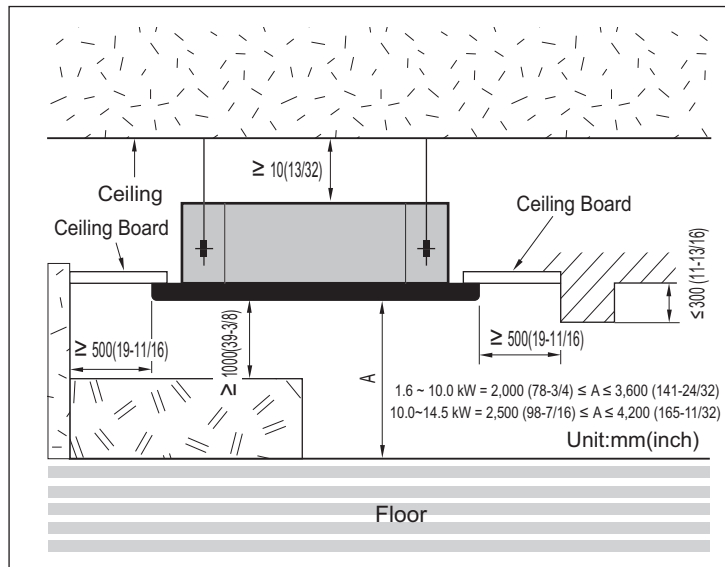

Note

- Places where products are installed should not be any obstacles to the air circulation or installation. Ensure the spaces from the wall, ceiling, or other obstacles.
- According to type of indoor unit, external appearance or installed structure could be different.
- According to product type, model line up, sales region..etc, applicability of each chassis could be different.
- Install certainly the decoration panel. Cool air leakage causes sweating or falling of water-drops.

4. Piping Diagrams

■ TR Chassis

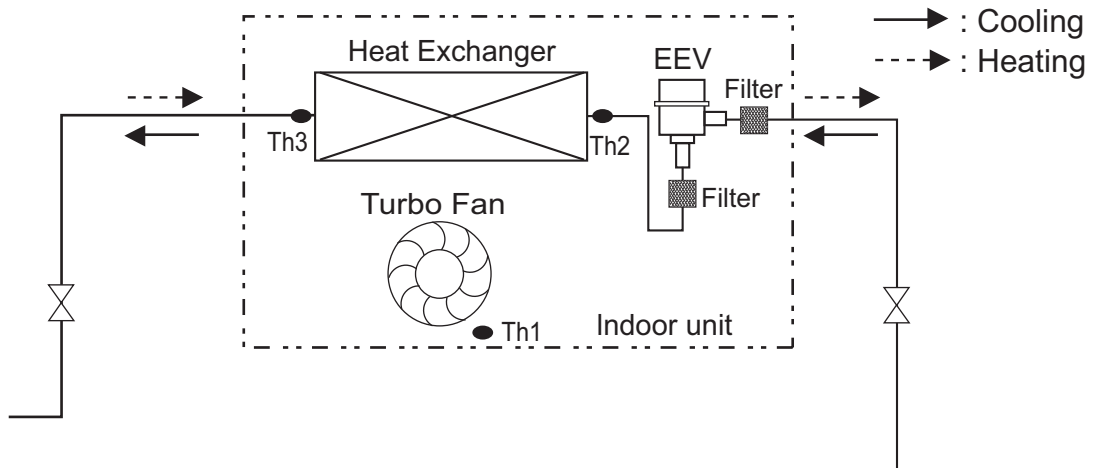

◆ Refrigerant pipe connection port diameter

Model	Gas [mm(inch)]	Liquid [mm(inch)]
ARNU09GTR*4	Ø12.7(1/2)	Ø6.35(1/4)
ARNU15GTR*4	Ø12.7(1/2)	Ø6.35(1/4)

LOC.	Description
Th1	Roomthermistor
Th2	Pipe inthermistor
Th3	Pipe outthermistor

5. Wiring Diagrams

TR Chassis

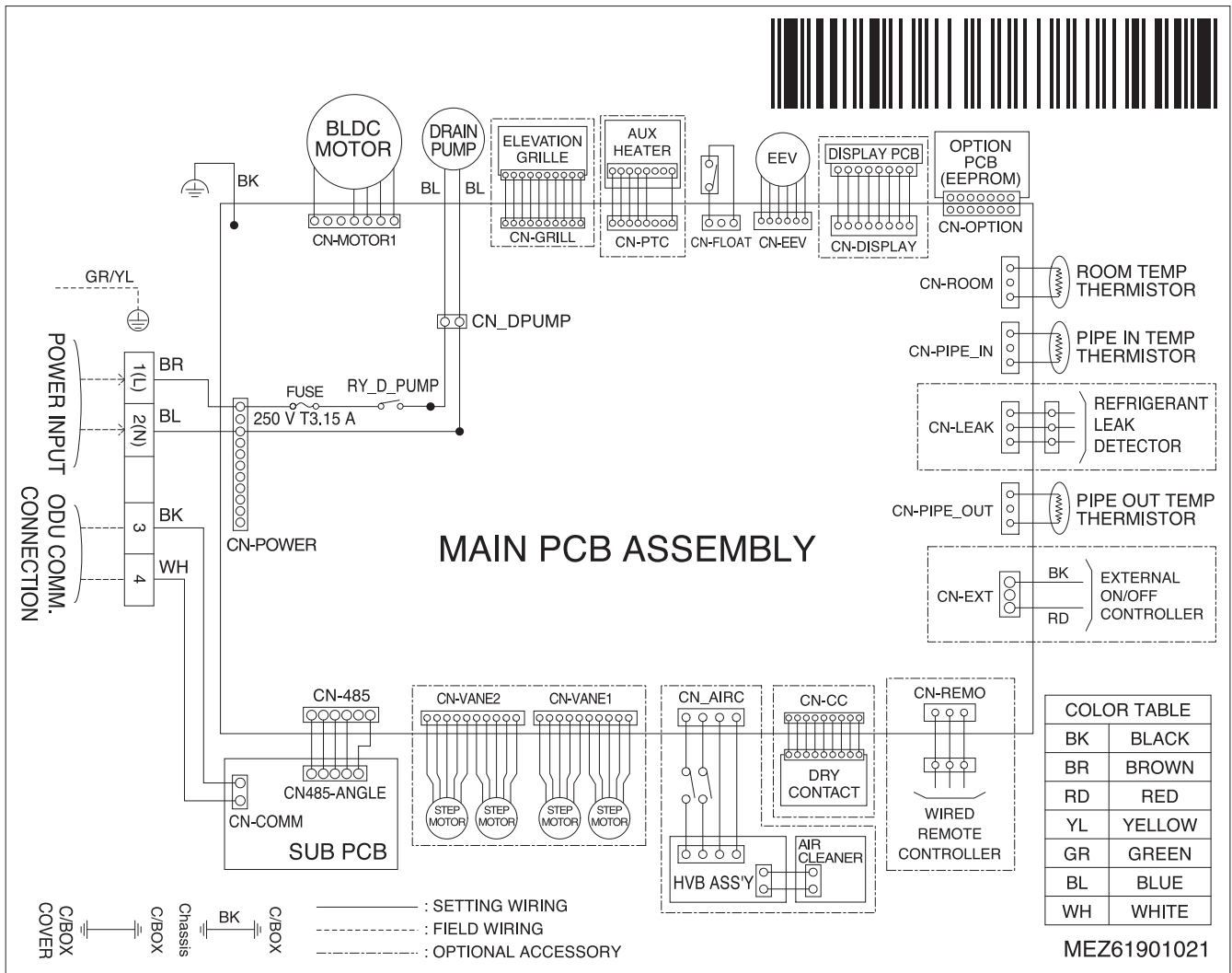

CONNECTOR NUMBER	LOCATION POINT	FUNCTION
CN-MOTOR1	Fan motor output	Motor output of BLDC
CN_DPUMP	Drain pump output	AC output for drain pump
CN-GRILL	Elevation grill	Elevation grill line
CN-PTC	Aux heater	Aux heater line
CN-LEAK	Refrigerant leak detector	Refrigerant leak detector line
CN-AIRC	Air cleaner	Air cleaner line
CN-DISPLAY	Display	Display of indoor status
CN-OPTION	Option pwb.	Communication between main and option
CN-EEV	EEV Output	EEV Control output : connect to EEV directly or through IPM(Independent Power Module)
CN-FLOAT	Float switch input	Float switch sensing
CN-ROOM	Room sensor	Room air thermistor
CN-PIPE_IN	Suction pipe sensor	Pipe in thermistor
CN-PIPE_OUT	Discharge pipe sensor	Pipe out thermistor
CN-REMO	Remote controller	Remote control line
CN-CC	Dry contact	Dry contact line
CN-COMM	Communication	Communication between indoor and outdoor
CN-VANE1	Step motor	Step motor output
CN-VANE2	Step motor	Step motor output
CN-485	Communication	Connection between indoor and outdoor
CN-EXT	External On/Off	External On/Off signal input

5. Wiring Diagrams

Dip Switch Setting		Off	On	Remarks
SW3	GROUP	Master	Slave	Group Control setting using Wired Remote Controller
SW4	DRY CONTACT	Variable	Auto	Old Dry Contact Mode Setting 1. Variable : Auto/Manual Mode can be chosen by Wide wired remote controller or Wireless remote controller (When shipped from Factory → Manual Mode) 2. Auto : For Dry Contact, it is always Auto mode.
SW5	EXTRA 1	Off	On	1. Duct model -. OFF : Default(not operate continuously) -. ON : Fan operate continuously 2. Cassette Model : No Function 3. Ceiling Suspended Model -. OFF : Ceiling(default) -. ON : Floor

CAUTION

For Multi V Model, Dip Switch 1,2,6,7,8 must be set OFF

Those are used for the other model.

6. Capacity Tables

■ Cooling Capacity

Nominal Capacity (kBtu/h) [Capacity Index (kW)]	Indoor air temp. (DB/WB, °C)													
	20		23		26		27		28		30		32	
	14		16		18		19		20		22		24	
	TC	SHC	TC	SHC	TC	SHC	TC	SHC	TC	SHC	TC	SHC	TC	SHC
9 [2.8]	1.9	1.6	2.2	1.8	2.6	2.0	2.8	2.0	3.0	2.1	3.0	2.0	3.1	1.8
15 [4.5]	3.0	2.4	3.6	2.8	4.2	3.1	4.5	3.1	4.8	3.2	4.9	3.1	4.9	2.8

Note

1. TC: Total Capacity(kW), SHC: Sensible Heat Capacity(kW)
2. Capacity tables show the average value of conditions which may occur.
3. Refer to Capacity tables and correction factor in the outdoor unit PDB for the actual performance data of each indoor unit and outdoor unit combination.

■ Heating Capacity

Nominal Capacity (kBtu/h) [Capacity Index (kW)]	Indoor air temp. (DB, °C)					
	16	18	20	21	22	24
	TC	TC	TC	TC	TC	TC
9 [2.8]	3.6	3.4	3.2	3.1	3.0	2.8
15 [4.5]	5.6	5.3	5.0	4.8	4.7	4.4

Note

1. TC: Total Capacity(kW)
2. Capacity tables show the average value of conditions which may occur.
3. Refer to Capacity tables and correction factor in the outdoor unit PDB for the actual performance data of each indoor unit and outdoor unit combination.

7. Air Velocity and Temperature Distribution

◆ ARNU09GTR*4

Cooling

Discharge angle: 40°

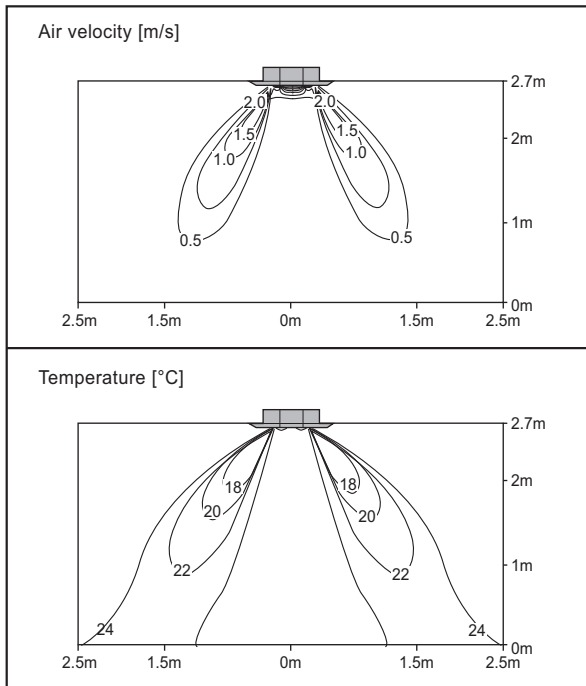

Heating

Discharge angle: 50°

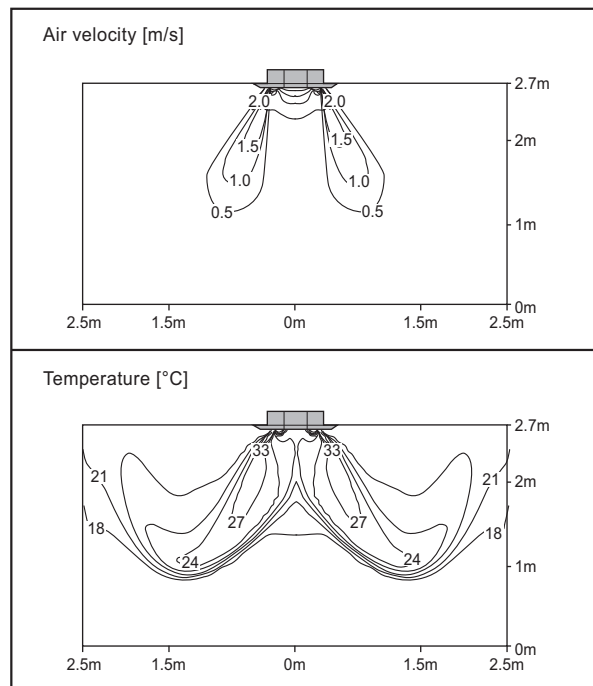

◆ ARNU15GTR*4

Cooling

Discharge angle: 40°

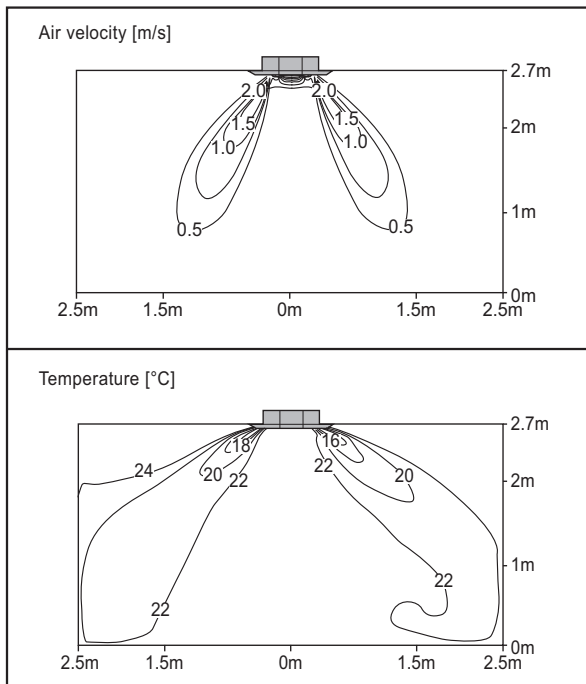

Heating

Discharge angle: 50°

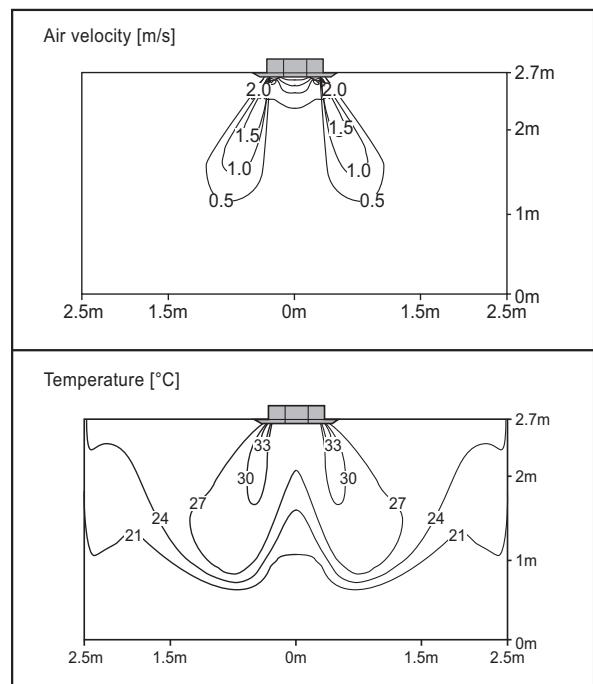

Note

- These figures are accordance with normal certain condition and environment. (Airflow step is 'High', Air discharge angle is fixed as indicated angle.)
- Indoor airflow distribution under actual installation or operating conditions depends on ambient temperature, ceiling height, product installation direction / location, indoor / Heating load, and other obstacles, etc.

8. Electric Characteristics

Units					Power Supply	IFM		PI	
Model	Type	Hz	Volts	Voltage Range	MCA	kW	FLA	Cooling	Heating
ARNU09GTR*4	TR	50	220-240	Max:264 Min:198	0.25	0.043	0.2	30	30
ARNU15GTR*4	TR				0.25	0.043	0.2	30	30
ARNU09GTR*4	TR	60	220	Max:242 Min:198	0.25	0.043	0.2	30	30
ARNU15GTR*4	TR				0.25	0.043	0.2	30	30

Symbols

MCA : Minimum Circuit Amperes (A)

MFA : Maximum Fuse Amperes (A)

kW : Fan Motor Rated Output (kW)

FLA : Full Load Amperes (A)

IFM : Indoor Fan Motor

PI : Maximum Power Input (W)

Note

- Voltage range
Units are suitable for use on electrical systems where voltage supplied to unit terminals is not below or above the listed range limits.
- Maximum allowable voltage unbalance between phases is 2%.
- MCA/MFA
 $MCA = 1.25 \times FLA$
 $MFA = 1.1 \times MCA, MFA \leq 4 \times FLA$
 (If MFA is smaller than minimum standard value, Use minimum standard value in region for selecting circuit breaker.)
- Select wire size based on the MCA
- Instead of fuse, use Circuit Breaker.

9. Sound Levels

9.1 Sound Pressure Levels

■ Ceiling Cassette 4-way

◆ Overall

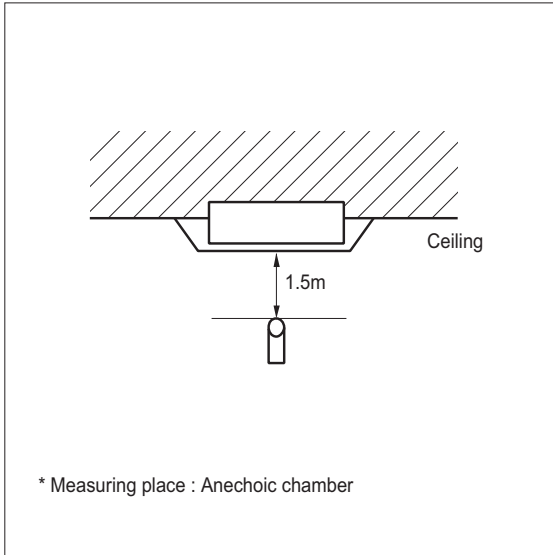

Note

1. Sound measured at some distance away from the center of the unit.
2. Data is valid at free field condition.
3. Reference acoustic pressure 0dB = 20μPa.
4. Data is valid at nominal operation condition.
Refer to the Model Specifications for nominal conditions(Power source and Ambient temperature, etc)
5. Sound levels can be increased in accordance with installation and operating conditions. (Static pressure mode, used air guide, Room target temperature setting, etc)
6. Sound level will vary depending on a range of factors such as the construction(acoustic absorption coefficient) of particular room in which the equipment is installed.
7. Sound pressure level is measured on the rated condition in the anechoic rooms by ISO 3745 standard.
Therefore, these values can be increased owing to ambient conditions during operation.

Model	Sound Pressure Levels [dB(A)]		
	H	M	L
ARNU09GTR*4	33	31	28
ARNU15GTR*4	37	33	30

ARNU09GTR*4

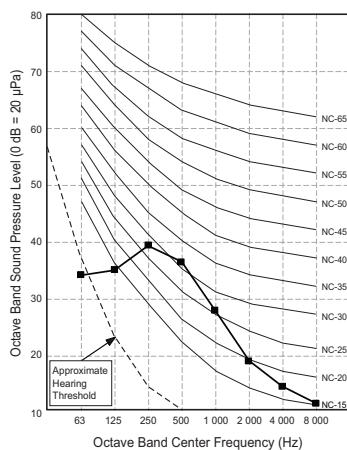

ARNU15GTR*4

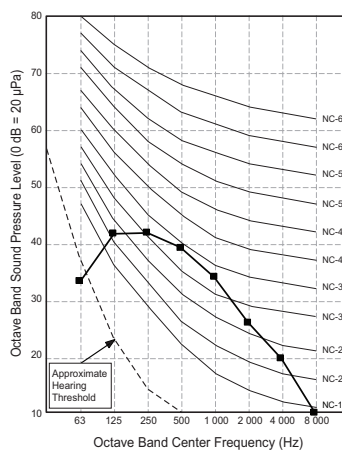

9. Sound Levels

9.2 Sound Power Levels

Note

- Data is valid at diffuse field condition
- Data is valid at nominal operating condition
- Sound level can be increased in static pressure mode or used air guide.
- Sound level will vary depending on a range of factors such as the construction (acoustic absorption coefficient) of particular room in which the equipment is installed.
- Reference acoustic intensity 0dB = $10E-6\mu W/m^2$
- Sound power level is measured on the rated condition in the semi-anechoic rooms by ISO 9614 standard. Therefore, these values can be increased owing to ambient conditions during operation.

Model	Sound Power Levels [dB(A)]
	High Fan Speed
ARNU09GTR*4	51.0
ARNU15GTR*4	55.0

ARNU09GTR*4

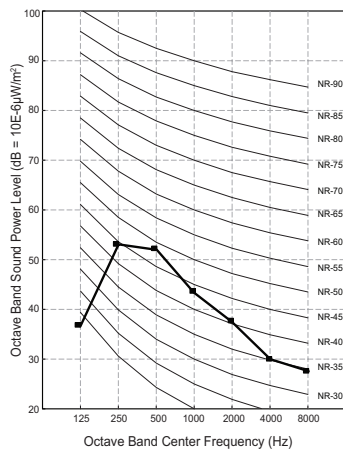

ARNU15GTR*4

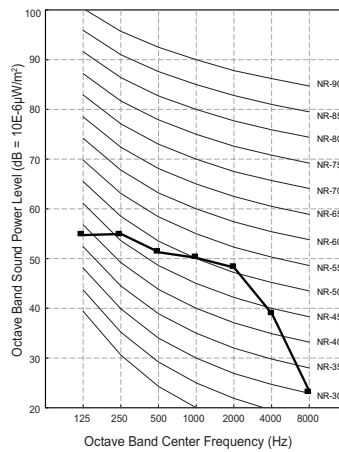

Indoor Units

Installation

- 1. Selection of the best Location**
- 2. Precautions regarding cassette indoor unit installation**
- 3. Connecting pipes**
- 4. Electrical Wiring**
- 5. Drain pipe connection**

1. Installation

1.1 Selection of the best Location

- The unit must be installed indoor area.
- Do not install the unit near the door.
- There should not be any obstacles to the air circulation or installation. Ensure the spaces from the wall, ceiling, or other obstacles.
- The place where the unit is leveled.
- The place shall allow easy water drainage.
- The place where bear a load exceeding four times of weight of the unit.
- The mounting ceiling or wall should be solid enough to protect it from the vibration.
- The place where the unit is not affected by an electrical noise.
- The place where noise prevention is taken into consideration.
- The place where the maintenance space for product is sufficient.
- The servicing inspection hole of the ceiling should be larger than the indoor unit, and that location should be approved by the customer.
- There should not be any heat source or steam near the unit. Avoid the following installation location.
 1. Such places as restaurants and kitchen where considerable amount of oil steam and flour is generated. These may cause heat exchange efficiency reduction, or water drops, drain pump mal-function. In these cases, take the following actions;
 - Make sure that ventilation fan is enough to cover all noxious gases from this place.
 - Ensure enough distance from the cooking room to install the unit in such a place where it may not suck oily steam.

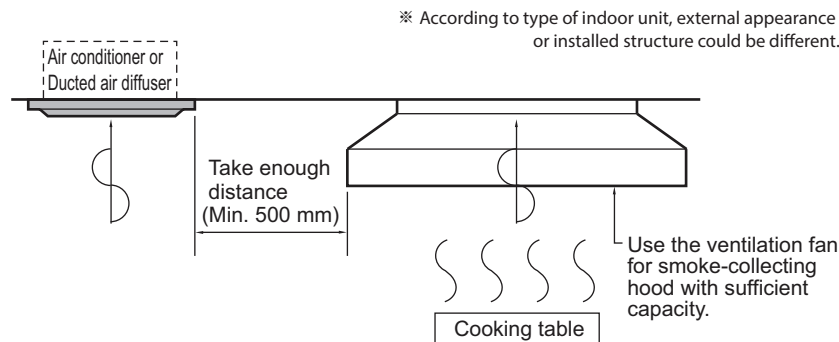

2. Avoid installing the unit in such places where cooking oil or iron powder is generated.
3. Avoid places where inflammable gas is generated.
4. Avoid places where noxious gas is generated.
5. Avoid places near high frequency generators.

⚠ CAUTION

- If the temperature rise above 30°C or the humidity rise above RH 80%, additional insulation working is needed to the unit body for protection of dew formation.
 - Use the glass wool material or polyethylene foam and it make sure to be thick of 10mm at least.

1. Installation

1.2 Precautions regarding cassette indoor unit installation

■ In case of high Ceiling space installation

In general commercial places and offices though the height of the ceiling is 2.7m, and the ceiling height could be over 3 m.

In such cases because of the temperature difference with the floor the heating effect can fall down.

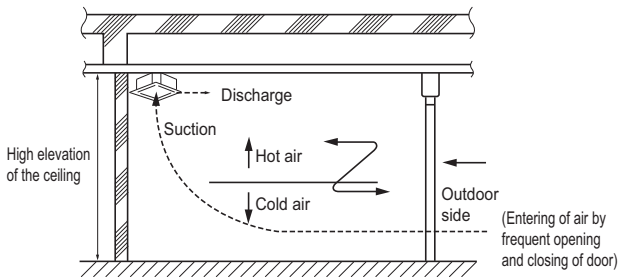

• Countermeasure method

1. Air conditioner should be able to operate in high ceiling operation mode.
2. Plan to install the circulator.
3. The air discharge port should be made to give more airflow to the down floor directions.
4. The gate or exit of the building is protected by dual door system to minimize inflow of outdoor air.

■ In case the floor or surfaces is contact with the outdoor air directly

If the floor of air conditioned room contact with the outside air, like the store room or garage, the floor temperature will be decreased and users can have a cold feeling in the feet.

In such places where the feet comes in direct contact with floors will give a cold feeling to the foot.

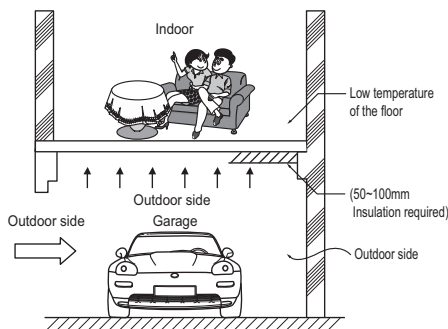

• Countermeasure method

1. Use the carpet on the floor.
(compared to the tiles the carpet over it will have a 3 degree rise in temperature)
2. Insulating the floor.
3. Floor heating.

⚠ CAUTION

In case there is a cold air intake, the duct surface may have some dew drops.

So a insulation on the duct is a must. (Insulation material: a glass wool of thickness 25 mm will be appropriate.)

■ In case of multiple indoor cassette units (recommended)

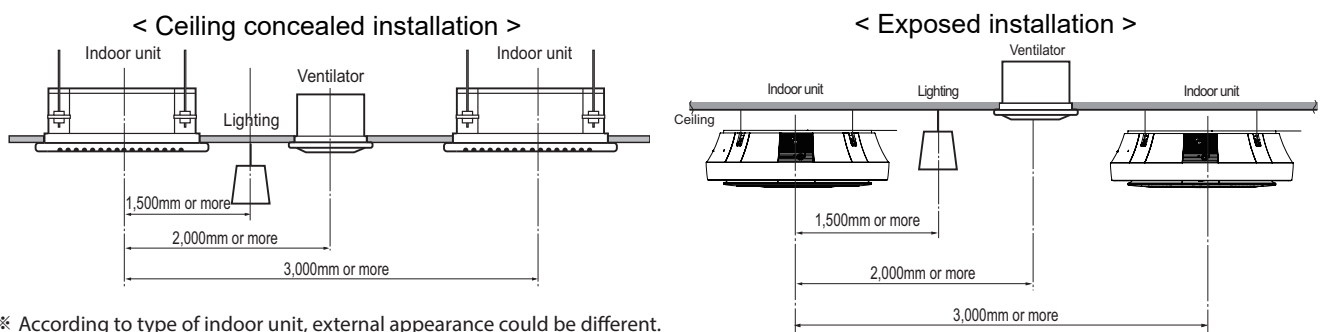

※ According to type of indoor unit, external appearance could be different.

1. Installation

■ In case of installation where high temperature or humidity

- In case of places having the temperature and humidity of the surrounding water sources(sea, river etc.)
- In case the steam is generated between the false ceiling and the ceiling slab due to some nearby by steam source.
- In case of temperature of 30 degree and humidity above 80%, the units body as well as the piping insulation should be strengthened. Refer to the psychrometric chart.

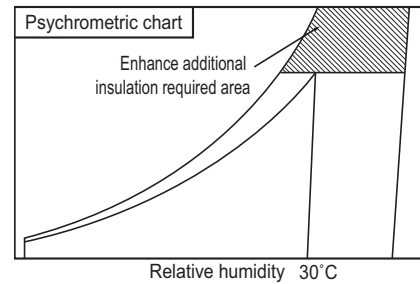

• Countermeasure method

- Indoor unit: Insulate the unit body with some insulation like glass wool at least 10 mm in thickness.
- Refrigerant piping: Increase the piping insulation thickness with thickness above 20 mm.
- Others: Inside the ceiling near th air tight seal places. (No escape of the humidity inside false ceiling)

Additional insulation required

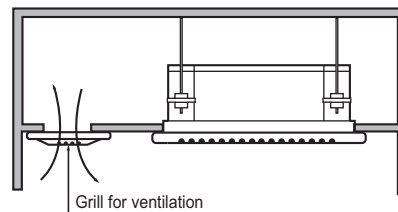
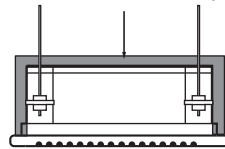

Note

- According to type of indoor unit, external appearance or installed structure could be different.
- According to product type, model line up, sales region..etc, applicability of each chassis could be different.

1. Installation

1.3 Connecting pipes

⚠ CAUTION

- When mechanical connectors are reused, indoors' sealing parts shall be renewed. (for R32)
- When flared joints are reused, indoors' the flare part shall be re-fabricated. (for R32)

■ Refrigerant piping work

To detail information for connecting the refrigerant pipes, please refer to the installation manual included with product.

■ Piping insulation work

- Perform heat insulation work completely on both gas and the liquid pipe. Because improper insulation will result condensate formation over pipe.
- Use the heat insulation material for the refrigerant piping which has an excellent heat resistance (over 120°C (248°F)).
- Precautions in high humidity circumstance
 - This air conditioner has been tested according to the "KS Conditions" and confirmed.
 - If it is operated for a long time in high humid atmosphere (dew point temperature: more than 23°C(73°F)), water drops are liable to fall. In this case, add heat insulation material according to the following procedure.

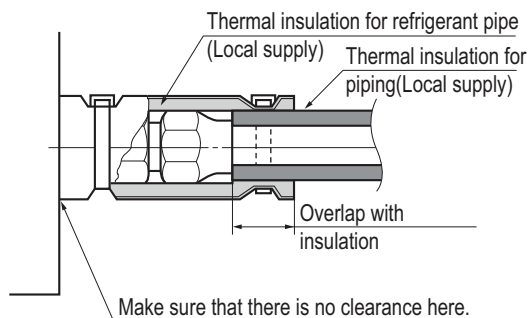

- Heat insulation material : Adiabatic glass wool with thickness of 10~20mm(13/32 ~13/16 inch).
- Stick glass wool on all air conditioners that are located in ceiling atmosphere.

⚠ CAUTION

- Make sure to insulate any field piping all the way to the piping connection inside the unit. Any exposed piping may cause condensation or burns if touched.

1. Installation

1.4 Electrical Wiring

- All field supplied parts and materials, electric works must conform to local codes. Use copper wire only.
 - Follow the "**WIRING DIAGRAM**" attached to the unit body to wire the outdoor unit, indoor units and the remote controller.
 - All wiring must be performed by an authorized electrician.
 - A circuit breaker capable of shutting down the power supply to the entire system must be installed.
-

CAUTION

After the confirmation of the above conditions, prepare the wiring as follows:

- Never fail to have separate power specially for the air conditioner.
 - Provide a circuit breaker switch between power source and the unit.
 - Confirm the Specification of power source.
 - Confirm that electrical capacity is sufficient.
 - Be sure that the starting voltage is maintained at more than 90 percent of the rated voltage marked on the name plate.
 - Confirm that the cable thickness is as specified in the power sources specification. (Particularly note the relation between cable length and thickness.)
 - Do not install the leakage breaker in a place which is wet or moist. Water or moist may cause short circuit.
 - The following troubles would be caused by voltage drop-down.
 - » Vibration of a magnetic switch, damage on the contact point there of, fuse breaking, disturbance to the normal function of a overload protection device.
 - » Proper starting power is not given to the compressor.
-

■ Wiring Connections

- Connect the wires to the terminals on the control board individually according to the outdoor unit connection.
 - Ensure that the color of the wires of outdoor unit and the terminal No. are the same as those of indoor unit respectively.
 - In case of the system with multiple indoor units, mark each indoor unit as unit A, unit B, etc and be sure the terminal board wiring to the outdoor unit and indoor units are properly matched. If wiring and piping between the outdoor unit and an indoor unit are mismatched, the system may cause a malfunction.
-

WARNING

- Make sure that the screws of the terminal are fixed tightly.
 - The screw which fasten the wiring in the casing of electrical fittings are liable to come loose from vibrations to which the unit is subjected during the course of transportation. Check them and make sure that they are all tightly fastened. (If they are loose, it could give rise to burn-out of the wires.)
 - Make sure to attach the sealing material or (field supplied) to hole of wiring to prevent the infiltration of foreign particle from outside. Otherwise a short-circuit may occur inside the electric parts box.
 - When clamping the wires, be sure no pressure is applied to the wire connections by using the included clamping material to make appropriate clamps. Also, when wiring, make sure the cover on the electric parts box fits snugly by arranging the wires neatly and attaching the electric parts box cover firmly. When attaching the electric parts box cover, make sure no wires get caught in the edges. Pass wiring through the wiring through holes to prevent damage to them.
 - Make sure the remote controller wiring, the wiring between the units, and other electrical wiring do not pass through the same locations outside of the unit, separating them properly, otherwise electrical noise (external static) could cause product malfunction.
-

1. Installation

■ Wired remote controller installation (Optional)

Since the room temperature sensor is in the remote controller, the remote controller box should be installed in a place away from direct sunlight, high humidity and direct supply of cold air to maintain proper space temperature. Install the remote controller about 5ft(1.5m) above the floor in an area with good air circulation at an average temperature.

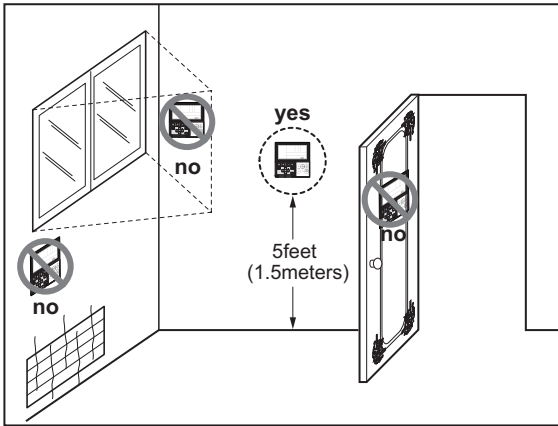

• Do not install the remote controller where it can be affected by :

- Drafts, or dead spots behind doors and in corners.
- Hot or cold air from ducts.
- Radiant heat from sun or appliances.
- Concealed pipes and chimneys.
- Uncontrolled areas such as an outside wall behind the remote controller.
- This remote controller is equipped with a seven segment LED display. For proper display of the remote controller LED's, the remote controller should be installed properly. (The standard height is 1.2~1.5 m from floor level.)

1. Installation

1.5 Drain pipe connection

Important

- The drain pipe should be at least equal in size to drain conduit of the indoor unit.
- The drain pipe is thermally insulated to prevent the formation of condensation inside the pipe.
- The drain up mechanism should be fitted before the indoor unit is installed and when the electricity has been connected a little of water should be added to the drain pan and the drain pump to check and see if it is functioning correctly.
- All connections should be secure. (Special care is needed with PVC pipe)

Dimension of drain pipe connection

- Drain piping must have down-slope (1/50 to 1/100). Be sure not to provide up-and-down slope to prevent reversal flow.
- During drain piping connection, be careful not to exert force on the drain port on the indoor unit.
- The outside diameter of the drain connection on the indoor unit and drain piping fittings should be referenced from 'Specifications' of each models.
 - Piping material: Use the Polyvinyl chloride pipe. VP 20 or VP 25 pipe fittings.
- Be sure to install heat insulation on the drain piping.
 - Heat insulation material: Polyethylene foam with thickness more than 8 mm (5/16 inch).
- Possible drain head height is specified to range of 700 ~ 800 mm (27-6/19 ~ 31-1/2 inch). So the drain head should be installed below that (Refer to Dimensional Drawings of each).

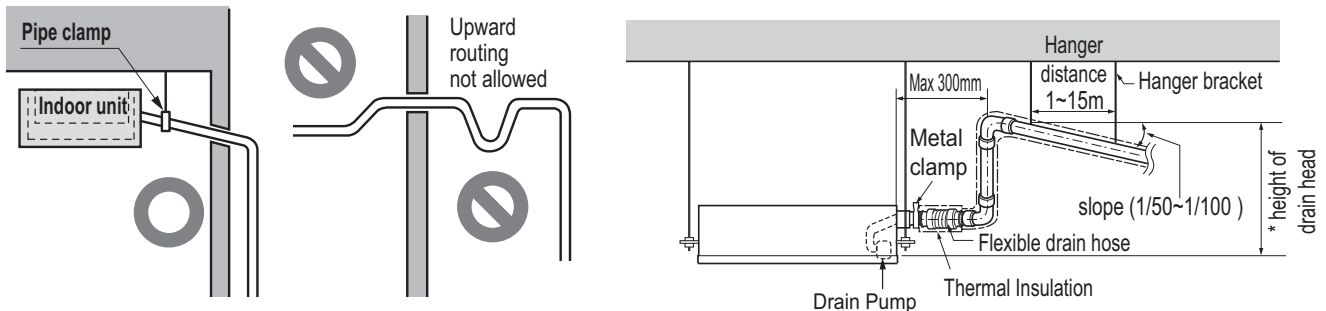

※ According to type of indoor unit, external appearance could be different.

※ *: drain head height should be considered by dimensional drawings of each models.
 ※ According to type of indoor unit, external appearance could be different.

Connection of an auxiliary(flexible) drain hose

- To connect drain pipe to the drain socket on the indoor unit, an auxiliary flexible drain hose should be used. Auxiliary flexible drain hose allows that the drain pipe can be connected to the socket without breaking by excessive strain.

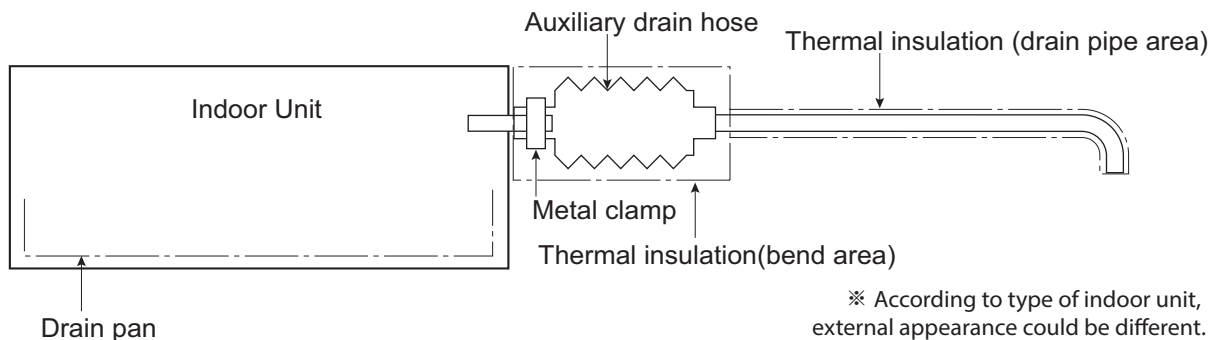

※ According to type of indoor unit, external appearance could be different.

1. Installation

⚠ CAUTION

- The supplied flexible drain hose should not be curved, neither screwed. The curved or screwed hose may cause a leakage of water.
- It is need to insulate the auxiliary drain hose with thermal insulation material.
 - When extending the drain hose, use a commercially available drain extension hose, and be sure to insulate the extended section of the drain hose which is indoors.
 - Make sure the diameter of the extension drain piping is the same as the indoor unit drain hose size or bigger.

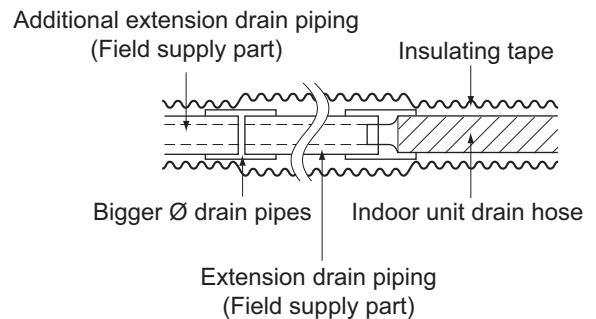

■ Ground drain piping

- Select diameter of drain piping which adapts to the capacity of the unit connected. The pipe down from the combination should be as large as possible.
- The pipe work should be kept as short as possible and the number of indoor units per group kept to a minimum.
- Face the vent pipe opening facing downward to keep foreign matter from penetrating the system.

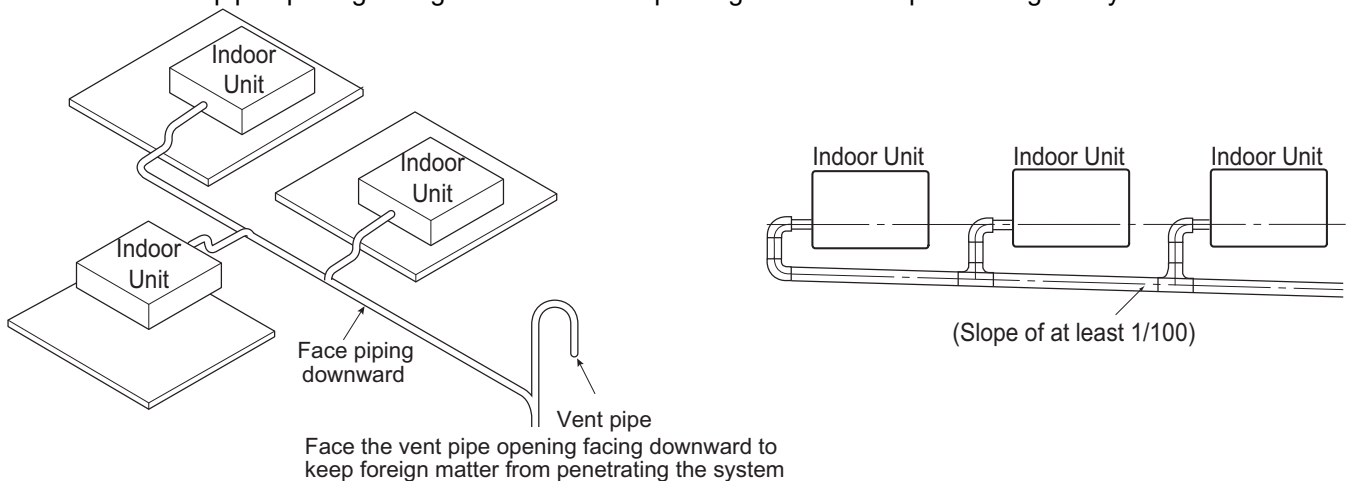

Note

- According to type of indoor unit, external appearance or installed structure could be different.
- According to product type, model line up, sales region..etc, applicability of each chassis could be different.

Dip Switch & Group Control Setting

- 1. Installer Setting**
- 2. Group Control Setting**
- 3. 2 Remote Control**
- 4. Accessories for group control setting**

1. Installer Setting

1.1 Dip Switch Setting of Indoor unit PCB

SW No.	Function	Description	Setting Off	Setting On	Default
SW1	Communication	N/A (Default)	-	-	Off
SW2	Cycle	N/A (Default)	-	-	Off
SW3	Group Control	Selection of Master or Slave	Master	Slave	Off
SW4	Dry Contact Mode	Selection of Dry Contact Mode	Wired/Wireless remote controller selection of Manual or Auto operation Mode	Auto	Off
SW5	Installation	Fan continuous operation	Continuous operation Removal	-	Off
SW6	Heater linkage	N/A	-	-	Off
SW7	Ventilator linkage	Selection of Ventilator linkage	Linkage Removal	Working	Off
	Vane selection (Console)	Selection of up/down side Vane	Up side + Down side Vane	Up side Vane Only	
	Region selection	Selection tropical region	General model	Tropical model	
SW8	Etc.	Spare	-	-	Off

CAUTION

For Multi V Model, Dip Switch 1,2,6,8 must be set OFF

1. Installer Setting

1.2 Installer Setting with wireless remote controller

⚠ CAUTION

Installer setting mode is to set the detail function of the remote controller.

If the installer setting mode is not set correctly, it can cause problems to the product, user injury or property damage. This must be set by a certificated installer, and any installation or change that is carried out by a non-certificated per- son should be responsible for the results. In this case, free service cannot be provided.

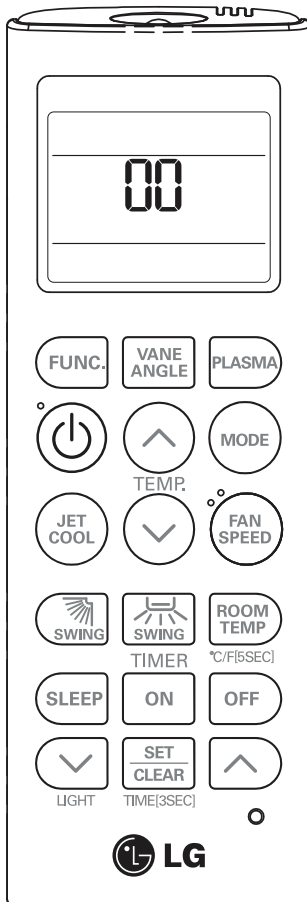

1 When JET COOL button pressed, press RESET button



2 By using the TEMPERATURE SETTING button, set function code and setting value. (Please refer the Installer Setting Code Table.)

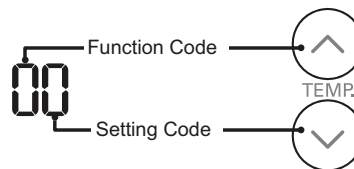

3 Press the ON/OFF button toward the indoor unit 1 time.



4 Reset the remote controller to use the general operation mode.



1. Installer Setting

◆ Installer Setting Code Table

No.	Function	FunctionCode	SettingValue	Remote ControllerLCD
0	Mode Override	0	0 : Set to Master	00
			1 : Set to Slave	01
1	Ceiling Height Selection	1	1 : Standard	11
			2 : Low	12
			3 : High	13
			4 : Super High	14
2	Group Control	2	0 : Set to Master	20
			1 : Set to Slave	21
			2 : Check Master/Slave	22
	Auxiliary heater	2	3 : Set to Auxiliary heater	23
			4 : Cancel Auxiliary heater	24
			2 : Check Auxiliary heater Installation	25

■ Group ControlSetting

- This function is only for group control.
- Please don't set this function in case of non-group control.
- This function is the Master or Slave setting function of indoor unit
- Set only one indoor unit to Master, set the others to slave.
- After setting Group Control of the product, turn off the power then turn it back on after 1 minute.
- Master checking whether the buzzer sounds, such as indoor rings below.
 - ▶ Master: "Beep" (Buzzer sound 1 time)
 - ▶ Slave: "Beep, Beep, Beep, Beep, Beep" (Buzzer sounds 5 times)

2. Group Control Setting

- Selection of operation options (operation/stop/mode/set temperature)
- Control of flow rate (High/Middle/Low)
- It is not possible at some functions.
- Master/Slave setting of indoor units be set possible using a PCB Dip Switch.
- It is possible to connect indoor units since Feb. 2009.
In the other cases, please contact LGE.
- It can be the cause of malfunctions when there is no setting of master and slave.

■ Group Control 2

◆ Wired remote controllers + Standard Indoor Units

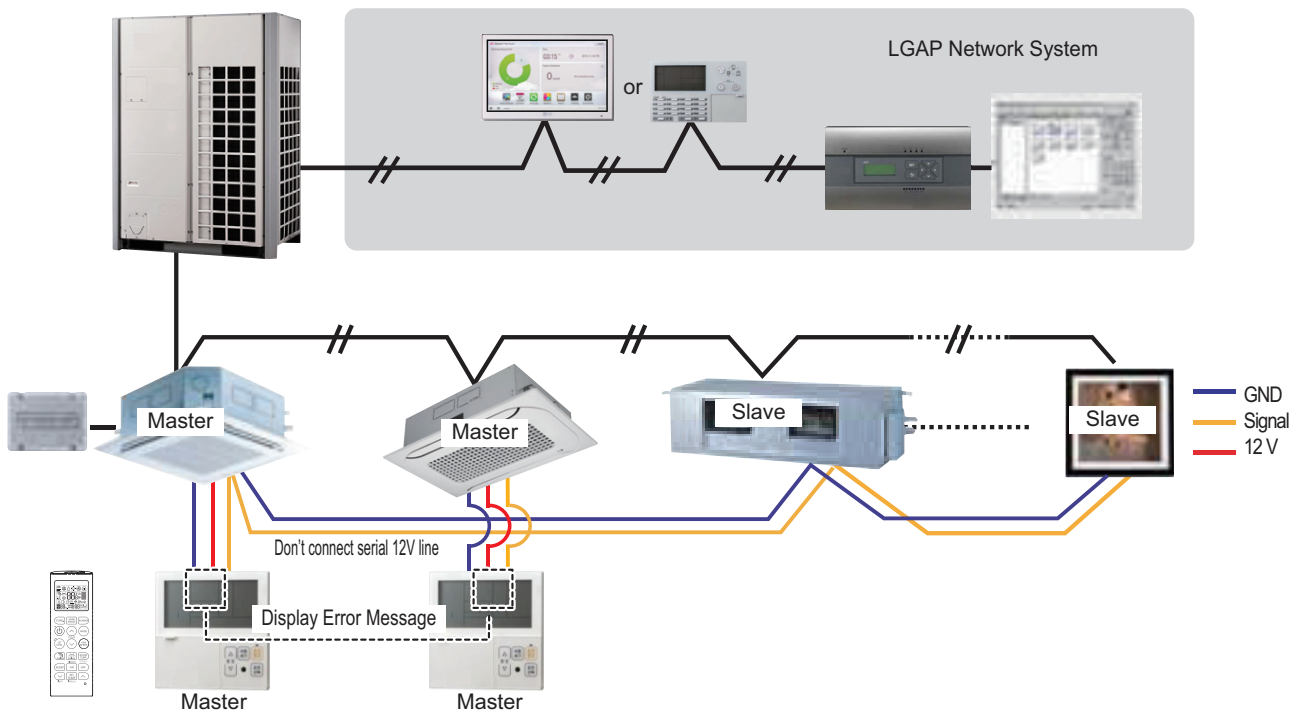

- It is possible to control 16 indoor units(Max.) with the master wired remote control.
- Set only one indoor unit to Master, set the others to Slave.
Set only one wired remote controller to Master, set the others to Slave.

2. Group Control Setting

- Other than those, it is same with the Group Control 1.

■ Group Control 3

◆ Mixture connection with indoor units and Fresh Air Intake Unit

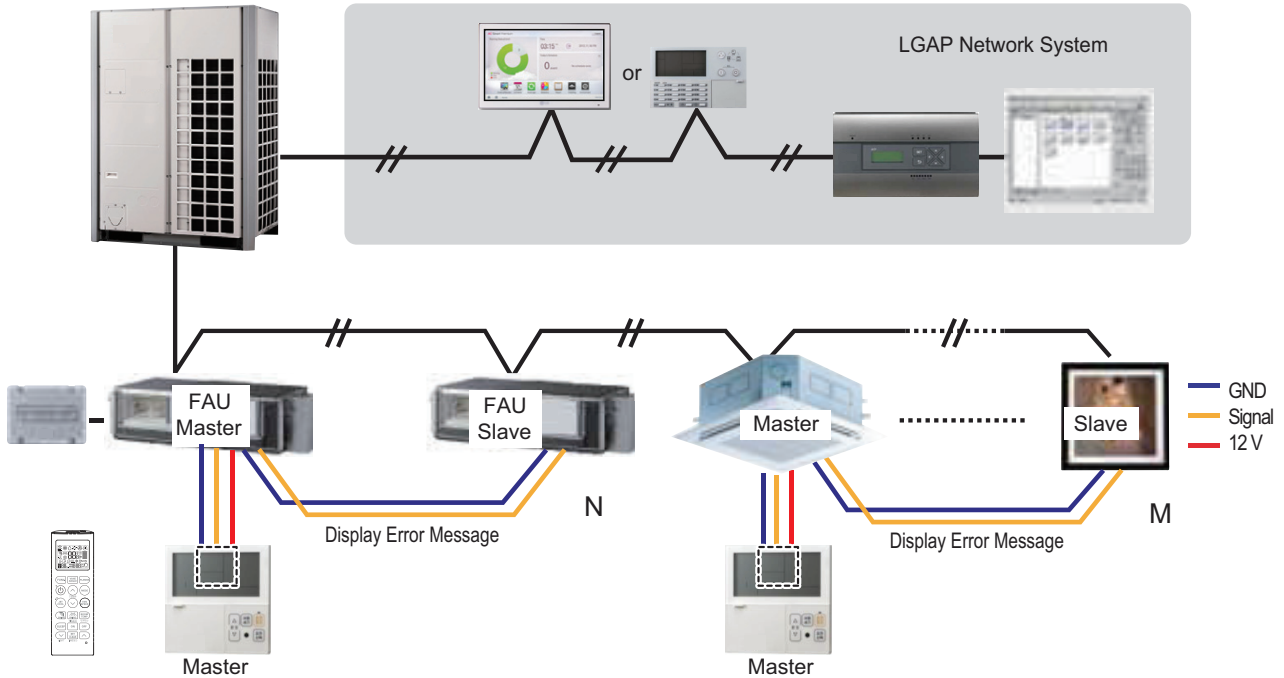

- In the case that you connect standard indoor units and Fresh Air Intake Units together, separate Fresh Air Intake Unit with standard units. (N, M < 17) controllers. (Because setting temperature are different.)
- Other than those, it is same with Group Control 1.

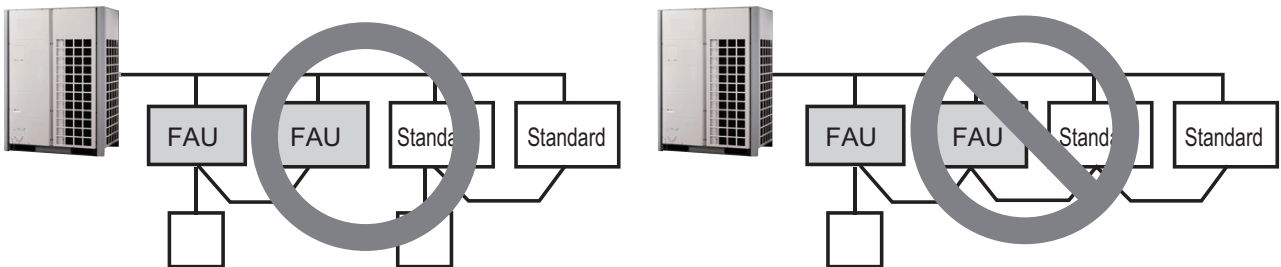

* FAU : Fresh Air Intake Unit
Standard: Standard Indoor Unit

3. 2 Remote Control

■ Wired remote controller 2 + Indoor unit 1

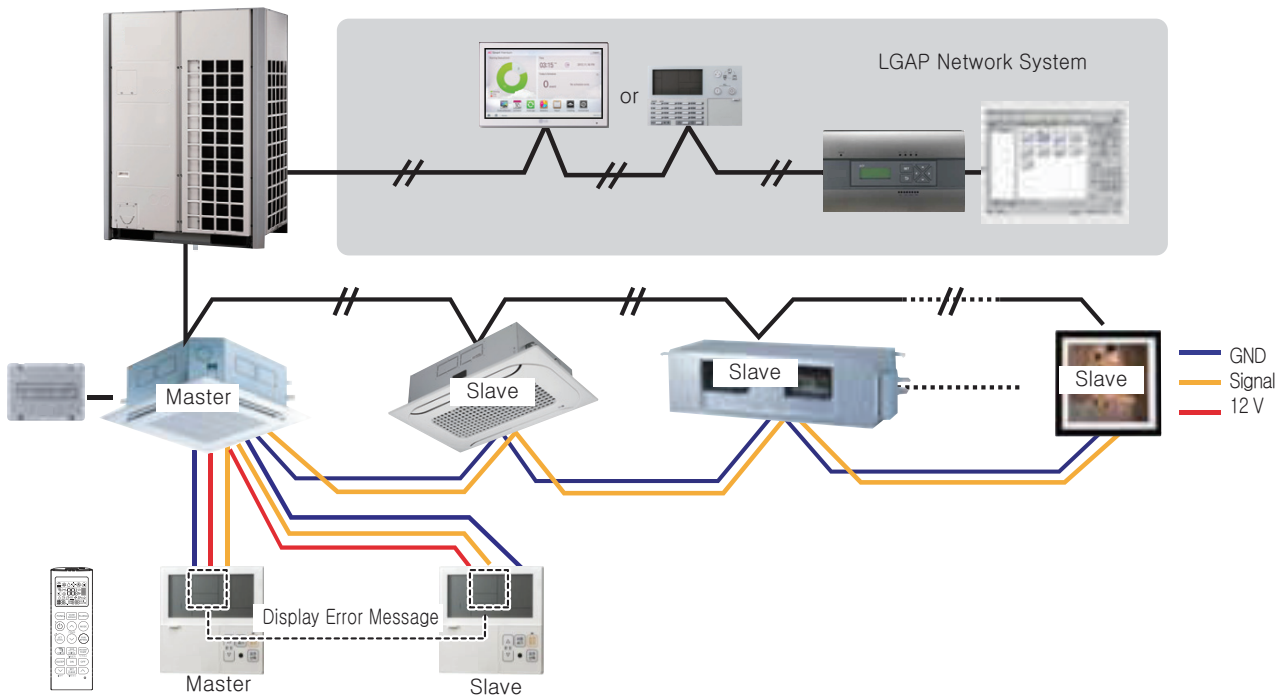

1. It is possible to connect two wired remote controllers(Max.) with one indoor unit.
2. Every types of indoor unit is possible to connect two remote controllers.
3. It is possible to use wireless remote controller at the same time.
4. It is possible to connect with Dry Contact and Central controller at the same time.
5. In case that the indoor unit has an abnormal problem an error code will be displayed on the wired remote controller.

With the exception of the indoor unit with the error, you can control each indoor unit individually.

6. There isn't limits of indoor unit function.

4. Accessories for group control setting

It is possible to set group control by using below accessories.

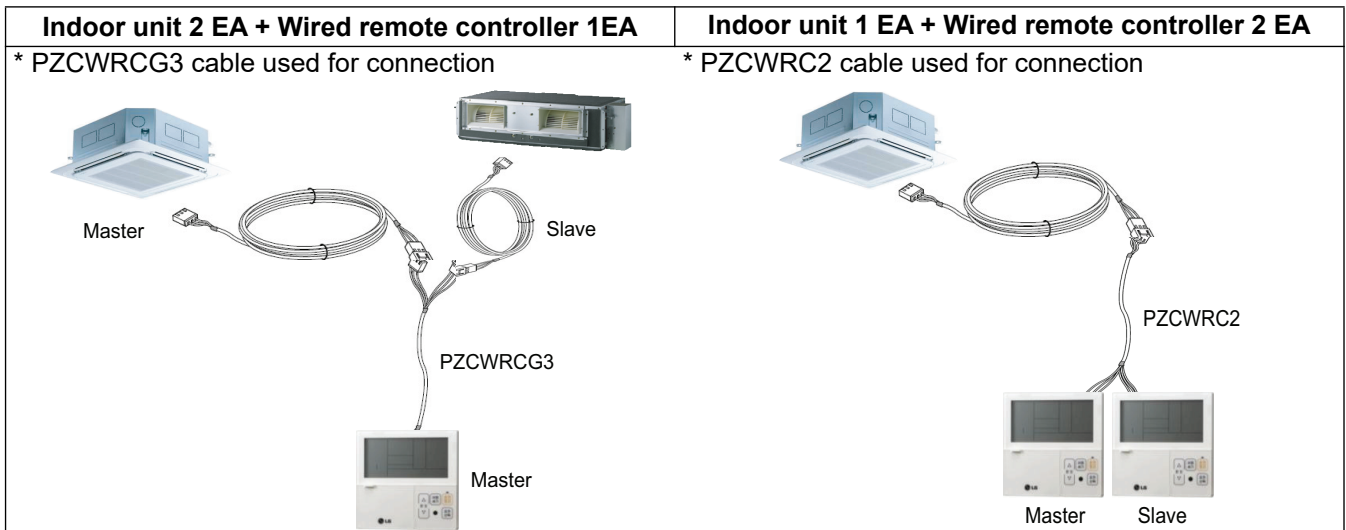

CAUTION

- Apply totally enclosed noncombustible conduit in case of local building code Requiring plenum cable usage.

ACCESSORY

Accessory List

1. Air Purification Kit
2. UVnano Filter Box

ACCESSORY

Air Purification Kit

1.Specification

1. Air Purification Kit

1.1 Specification

Specification		Unit	1way Cassette	
			TU	TT
Air Purification Kit Model		-	PTAHTP0	
Air Purification Panel		-	PT-UPHG0	PT-TPHG0
PM1.0 Sensor	Size (W x H x D)	mm	59 x 45 x 22	
	Supply Voltage	V	5	
	Measure	-	PM1.0 / PM2.5 / PM10	
HVPS	Size (W x H x D)	mm	99 X 50 X 30	
	Input	-	DC 12V	
	Output (Electrification / Dust Collection)	-	-7.7kV / -5.2kV	
PM1.0 Filter	Size (W x H x D)	mm	524 x 18 x 141	
	Weight	g	430	
Deodorization filter	Material	-	Pulp + Carbon (Corrugate)	
	Size (W x H x D)	mm	301 x 11 x 100	
	Weight	g	40	
Ionizer	Size (W x H x D)	mm	71 x 19 x 30	
	Input	-	DC 12V	
	Output	-	-3.2kV	
	Amount of Ion emission	EA/cc	3,000,000	

Specification		Unit	4way Cassette	
			TP / TN / TM	TP-B / TM-A
Air Purification Kit Model		-	PTAHMP0	
Air Purification Panel		-	PT-MPGW0 (U-style)	PT-AFGW0 (Dual Vane)
PM1.0 Sensor	Size (W x H x D)	mm	59 x 45 x 22	
	Supply Voltage	V	5	
	Measure	-	PM1.0 / PM2.5 / PM10	
HVPS	Size (W x H x D)	mm	99 X 50 X 30	
	Input	-	DC 12V	
	Output (Electrification / Dust Collection)	-	-7.7kV / -5.2kV	
PM1.0 Filter	Size (W x H x D)	mm	500 x 38 x 395	
	Weight	g	2,090	
Deodorization filter	Material	-	Pulp + Carbon (Corrugate)	
	Size (W x H x D)	mm	478 x 14 x 138	
	Weight	g	180	
Ionizer	Size (W x H x D)	mm	71 x 19 x 30	
	Input	-	DC 12V	
	Output	-	-3.2kV	
	Amount of Ion emission	EA/cc	3,000,000	

1. Air Purification Kit

Specification		Unit	Round Cassette
			TY
Air Purification Kit Model		-	PTAHYP0
Air Purification Panel		-	-
PM1.0 Sensor	Size (W x H x D)	mm	59 x 45 x 16.6
	Supply Voltage	V	5
	Measure	-	PM1.0 / PM2.5 / PM10
HVPS	Size (W x H x D)	mm	99 X 50 X 30
	Input	-	DC 12V
	Output (Electrification / Dust Collection)	-	-7.7kV / -5.2kV
PM1.0 Filter	Size (W x H x D)	mm	500 x 38 x 395
	Weight	g	2,090
Deodorization filter	Material	-	Pulp + Carbon (Corrugate)
	Size (W x H x D)	mm	478 x 14 x 138
	Weight	g	180
Ionizer	Size (W x H x D)	mm	-
	Input	-	-
	Output	-	-
	Amount of Ion emission	EA/cc	-

ACCESSORY

UVnano Filter Box

1.Specification

2.Dimensions

3.External Static Pressure(E.S.P) & Air Flow

1. Specification

Model		Unit	PBM13M1UA0	PBM13M2UA0	PBM13M3UA0
Applied Chassis			M1	M2	M3
Net Size (W x H x D)		mm	900 x 270 x 280	1,250 x 270 x 280	1,250 x 360 x 280
Shipping Size (W x H x D)		mm	1,048 x 340 x 377	1,440 x 340 x 377	1,440 x 430 x 377
Net Weight		kg	9.1	11.6	12.7
Shipping Weight		kg	11.4	14.7	16.2
Filter (1)	Size(W x H x D)	mm	600 x 251 x 50.8	600 x 251 x 50.8	600 x 341 x 50.8
	Quantity	EA	1	2	2
	Grade 1	-	ePM1 65%	ePM1 65%	ePM1 65%
	Grade 2	-	MERV 13	MERV 13	MERV 13
Filter (2)	Size(W x H x D)	mm	250 x 251 x 50.8	-	-
	Quantity	EA	1	-	-
	Grade 1	-	ePM1 65%	-	-
	Grade 2	-	MERV 13	-	-
Pre-Filter (1)	Size(W x H x D)	mm	596 x 247 x 4	596 x 247 x 4	596 x 377 x 4
	Mesh	-	34 x 39	34 x 39	34 x 39
	Color	-	BLACK	BLACK	BLACK
	Quantity	-	1	2	2
Pre-Filter (2)	Size(W x H x D)	mm	247 x 247 x 4	-	-
	Mesh	-	34 x 39	-	-
	Color	-	BLACK	-	-
	Quantity	EA	1	-	-
UVnano	LED Quantity	EA	8	8	8
	Input	V	DC 12V	DC 12V	DC 12V
	Wavelength	nm	275	275	275

Note

1. Grade 1 : ISO EN 16890
2. Grade 2 : ASHRAE 52.2

2. Dimensions

◆ PBM13M1UA0

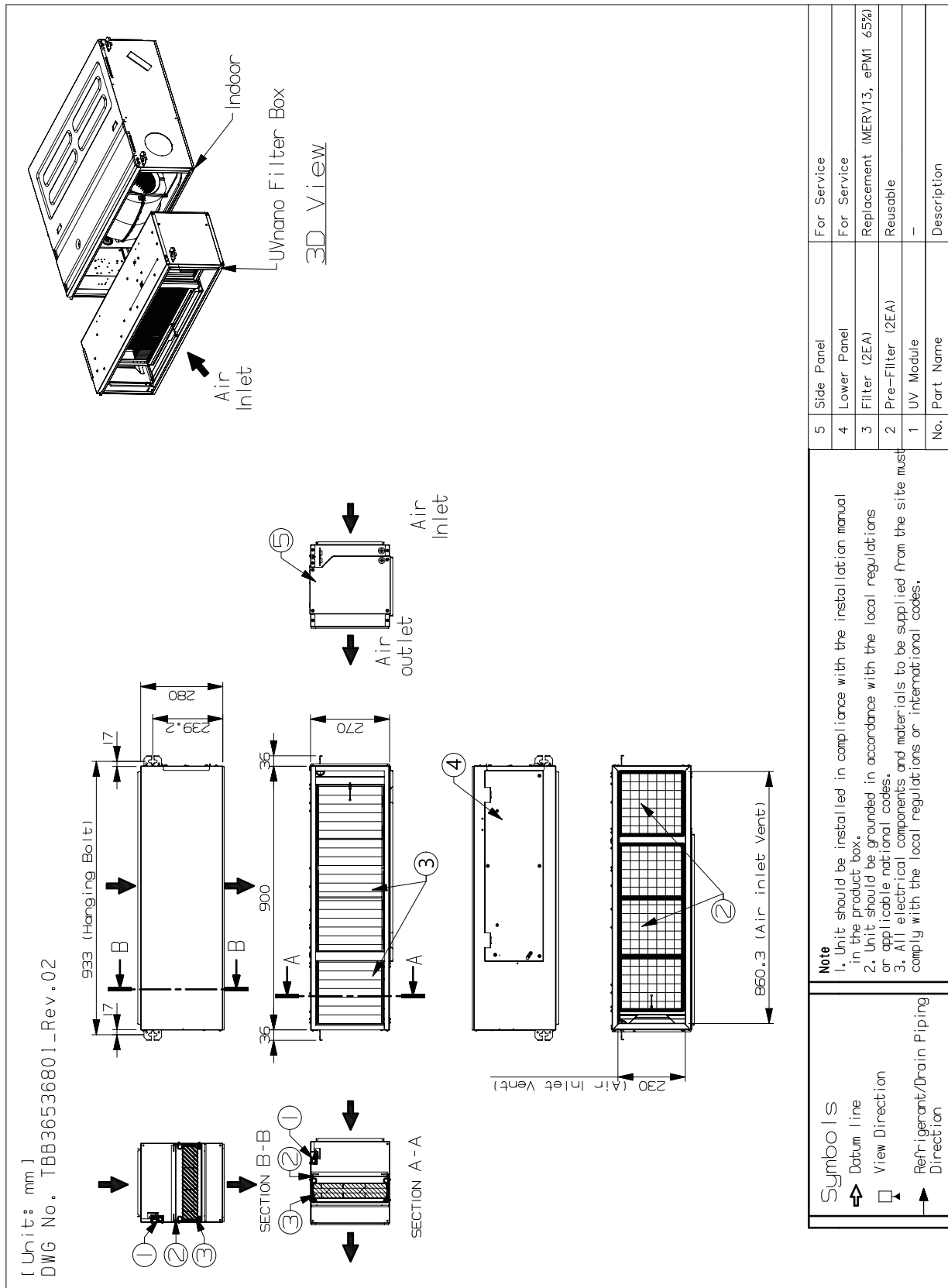

2. Dimensions

◆ PBM13M2UA0

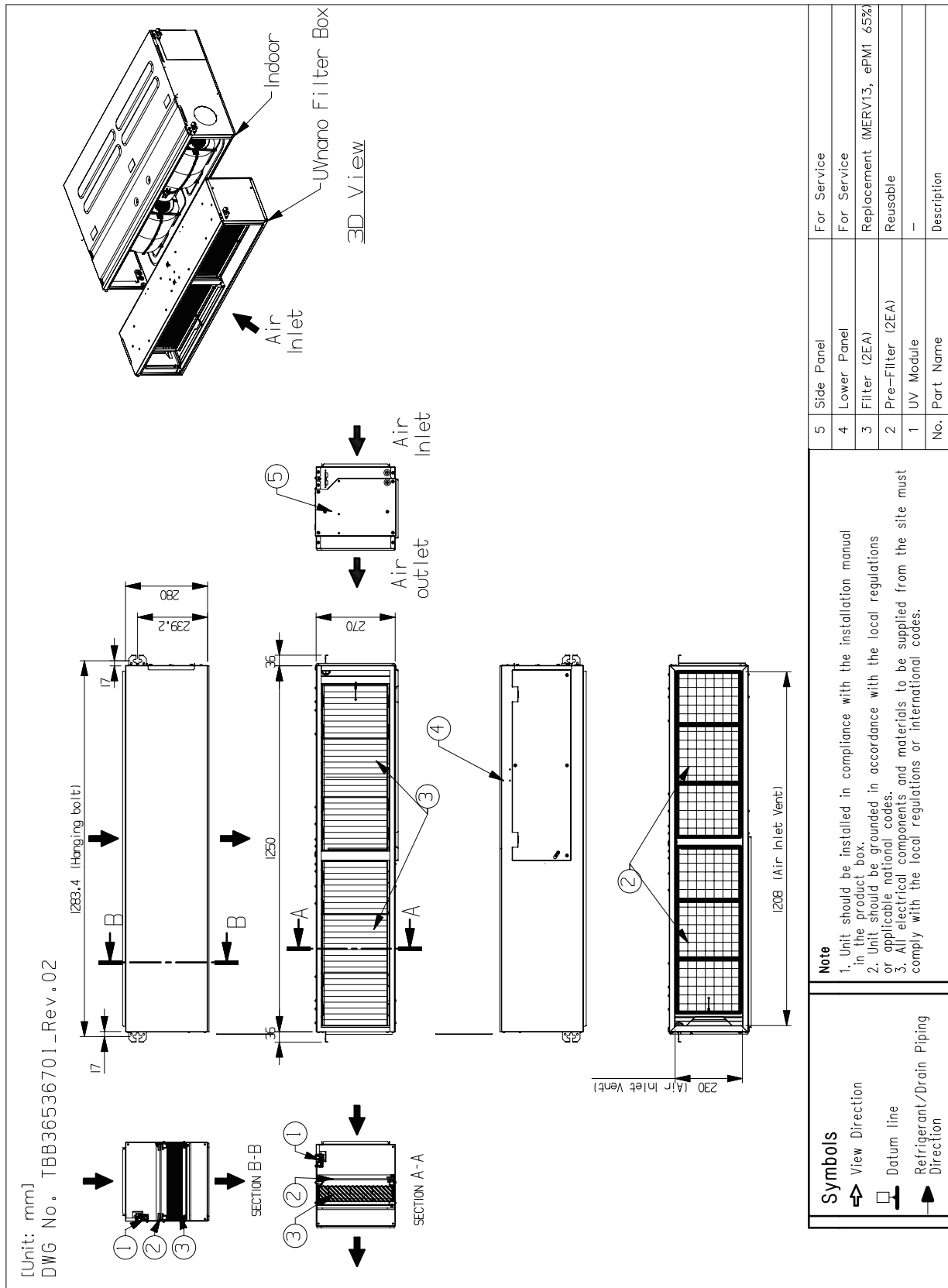

2. Dimensions

◆ PBM13M3UA0

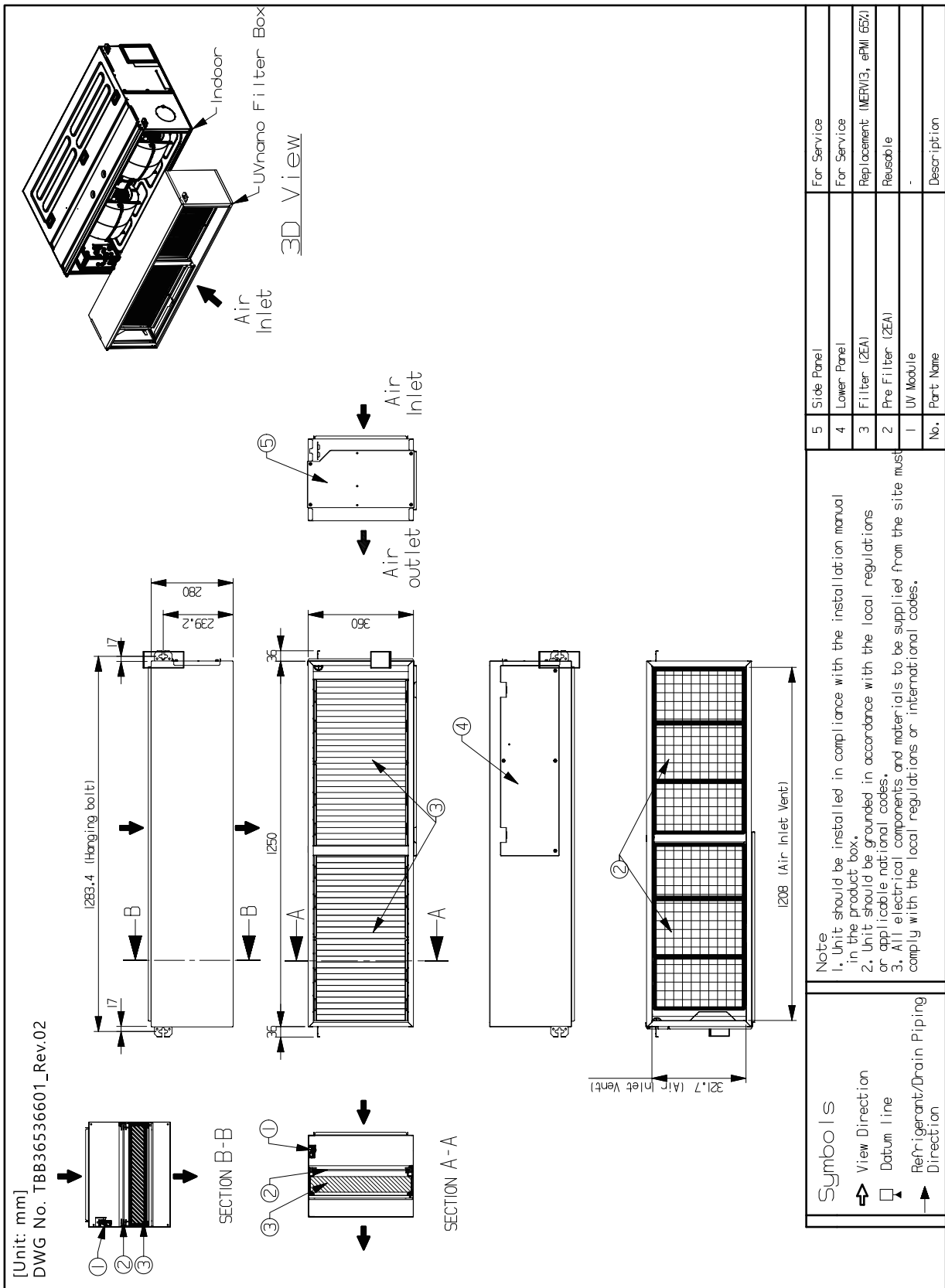

3. External Static Pressure(E.S.P) & Air Flow

◆ M1 Chassis (7~18 kBTu/h)

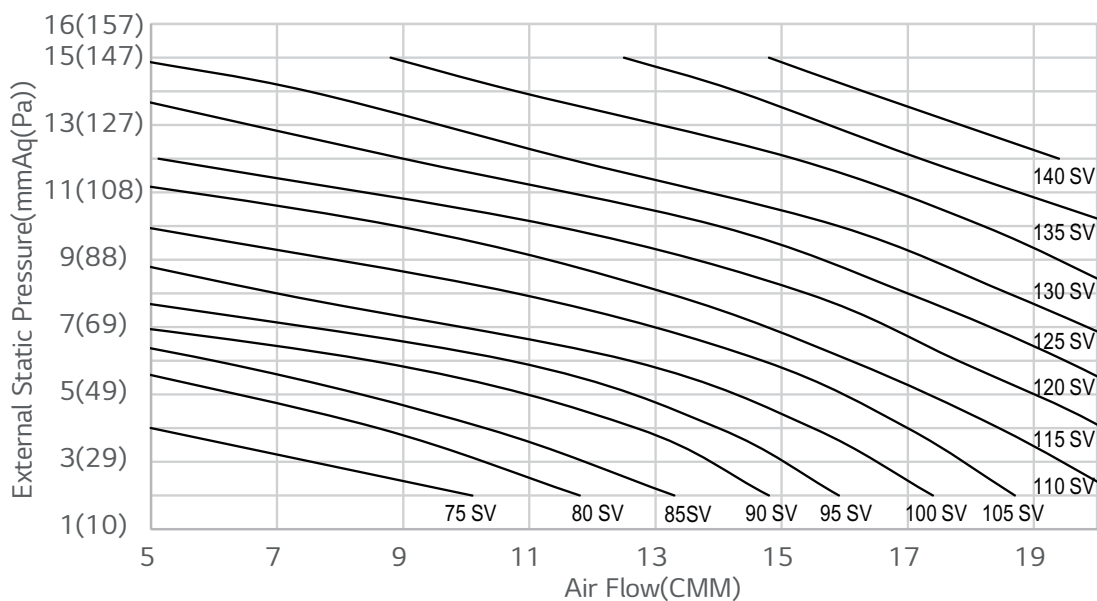

Note

1. SV : Setting Value
2. The available range of External Static Pressure and Setting Value depends on the applied model. Please check the specifications of the applied model.

◆ M1 Chassis (24 kBTu/h)

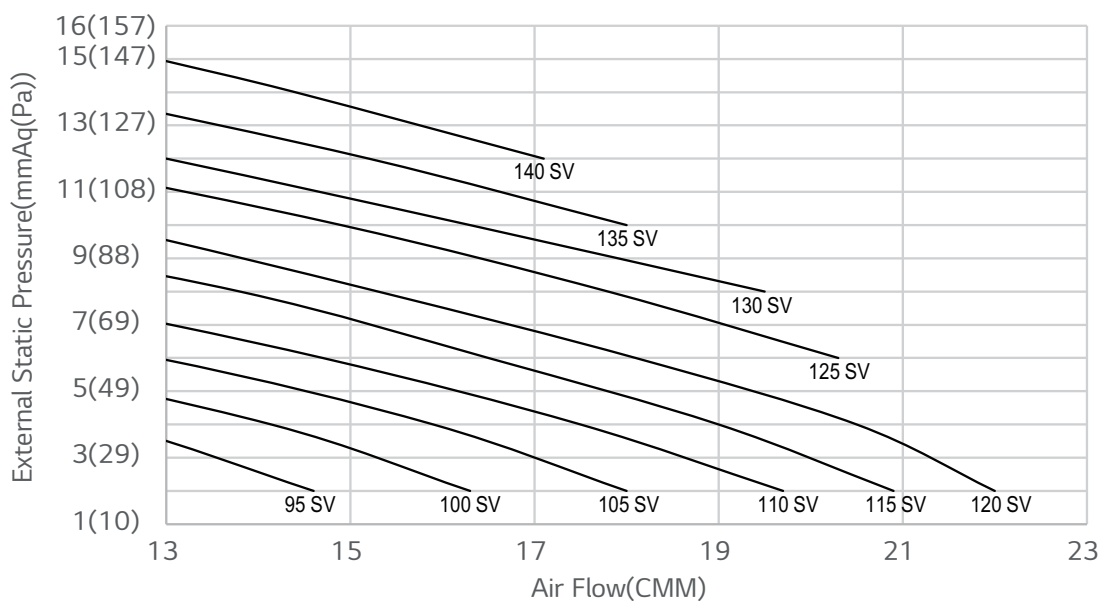

Note

1. SV : Setting Value
2. The available range of External Static Pressure and Setting Value depends on the applied model. Please check the specifications of the applied model.

3. External Static Pressure(E.S.P) & Air Flow

◆ M2 Chassis (7~36 kBTu/h)

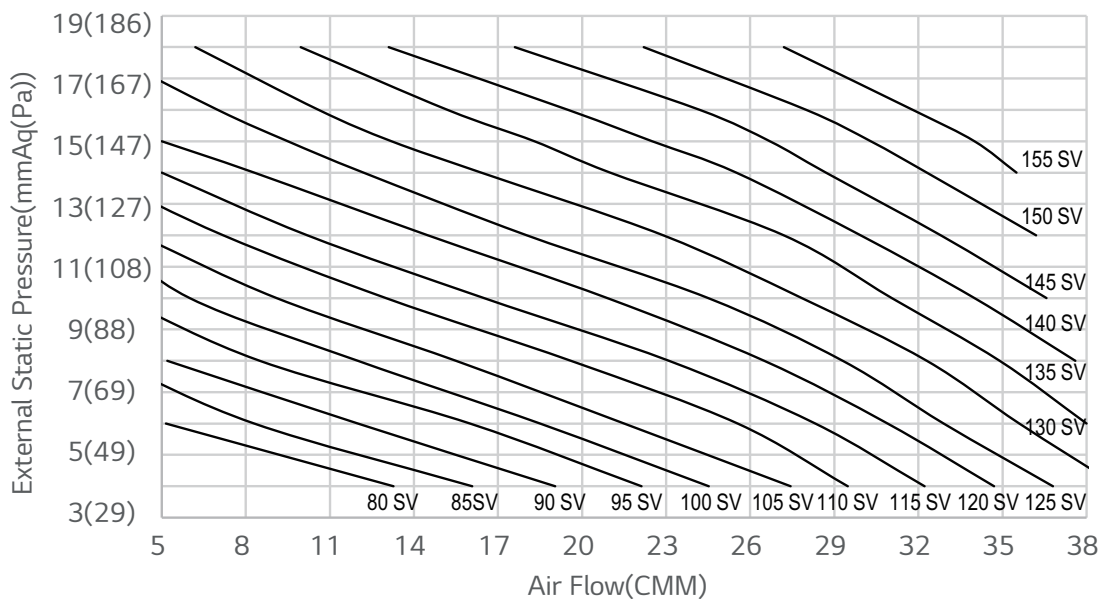

Note

1. SV : Setting Value
2. The available range of External Static Pressure and Setting Value depends on the applied model. Please check the specifications of the applied model.

◆ M2 Chassis (42 kBTu/h)

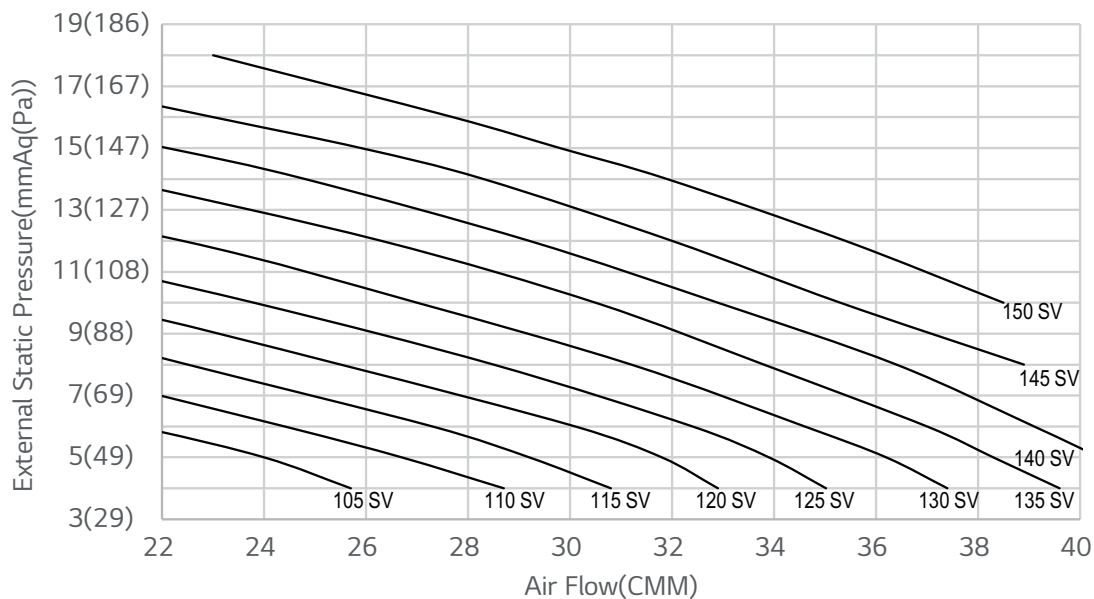

Note

1. SV : Setting Value
2. The available range of External Static Pressure and Setting Value depends on the applied model. Please check the specifications of the applied model.

3. External Static Pressure(E.S.P) & Air Flow

◆ M3 Chassis (18~54 kBtu/h)

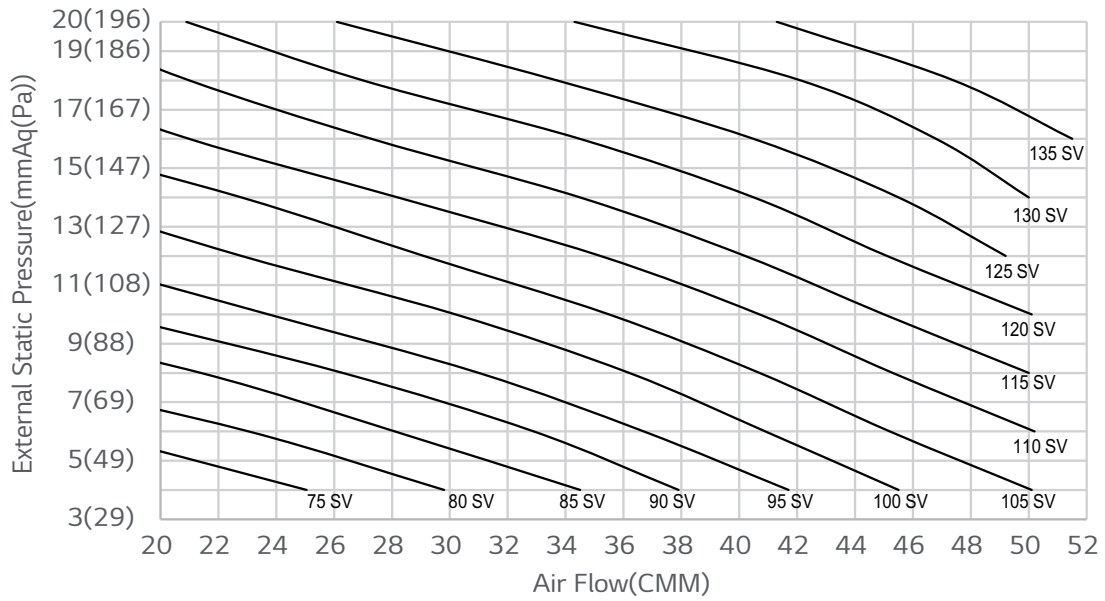

Note

1. SV : Setting Value
2. The available range of External Static Pressure and Setting Value depends on the applied model. Please check the specifications of the applied model.



Air Solution

LG Electronics Inc, 128, Yeoui-daero,
Yeongdeungpo-gu, Seoul, Korea
(07336)
<http://partner.lge.com>

Copyright © 2017-2023 LG Electronics Inc.
All Rights Reserved.
Printed in Korea November / 2023

The air conditioners manufactured by LG have received ISO9001 certificate for quality assurance and ISO14001 certificate for environmental management system.
The specifications, designs, and information in this brochure are subject to change without notice.