



PRESENTING
LG WASHING MACHINE

GO Easy Intelligent!

with AI **ThinQ** MORE CONVENIENCE &
MORE FABRIC CARE



Life's Good.



Images/products shown are for illustration purposes only. Actual product may vary due to product enhancement. Features may vary from model to model. All third party logos, trademark and other Intellectual Properties are property of respective brands and LG doesn't hold any rights pursuant to same. For more details, visit www.lg.com

NO PROBLEM!

Presenting AI Direct Drive®

Gone are the days when washing clothes included the hassles of separating clothes according to their fabric type and then choosing the correct wash cycle for them. Meet AI DD®. It not only detects the weight but also senses the softness of the fabric and then chooses the optimal wash pattern for the fabric by itself. Hence, it gives you peace of mind and freedom from the struggle of separating clothes depending on their fabric. And while at it, it also provides more convenience & more fabric care.

More Convenience

Automatically Detects Softness and Fabric Load

More Fabric Care

Provides Complete Fabric Protection



Images/products shown are for illustration purposes only. Actual product may vary due to product enhancement. Features may vary from model to model. All third party logos, trademark and other Intellectual Properties are property of respective brands and LG doesn't hold any rights pursuant to same. For more details, visit www.lg.com

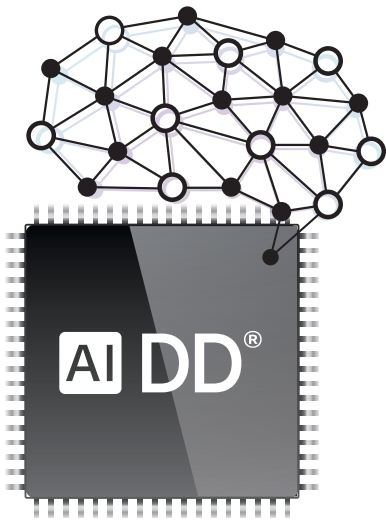

Why Choose LG AI DD®?

From conventional to Artificial Intelligence, LG AI DD® technology has come a long way. It has data of 20,000 Wash Patterns, tested with various laundry characteristics, to give your clothes a perfect wash, every time. The machine does all this on its own, making it a gift for a hassle-free life.

Images/products shown are for illustration purposes only. Actual product may vary due to product enhancement. Features may vary from model to model. All third party logos, trademark and other Intellectual Properties are property of respective brands and LG doesn't hold any rights pursuant to same. For more details, visit www.lg.com





AI DD[®]

AUTOMATICALLY SELECTS OPTIMAL WASH PATTERN FROM
20,000 WASH PATTERNS



A celebratory scene featuring three women in vibrant, colorful clothing (orange, green, and yellow) holding wine glasses and a small bag, surrounded by falling gold confetti. The background is white with scattered confetti.

WASH SMARTLY. LIVE WORRY-FREE.

Go Easy
Go Intelligent!

Images/products shown are for illustration purposes only. Actual product may vary due to product enhancement. Features may vary from model to model. All third party logos, trademark and other Intellectual Properties are property of respective brands and LG doesn't hold any rights pursuant to same. For more details, visit www.lg.com



Inverter
Direct Drive

LESS VIBRATION. LESS NOISE.

Inverter Direct Drive motor enhances washing performance with less noise. Inverter Direct Drive technology uses fewer moving parts, which reduces vibrations and enhances durability. Plus, the motors dissipate less energy, reducing electricity consumption.

CONVENTIONAL MOTOR



More friction caused by the pulley and belt causes more noise & vibration which lead to less durability.

LG INVERTER DIRECT DRIVE



The drum and motor are connected directly which leads to less noise & vibration and more durability.



MOTION DD Direct Drive

WASH WITH COMPLETE CARE

The unique motions of 6 Motion Direct Drive are designed ingeniously to deliver better wash performance to each fabric.

TUMBLING



A standard motion in all washing machines, tumbling works for all types of clothes.

SCRUBBING



As an intensive wash cycle, scrubbing dissolves detergent quickly and works strongly on tough stains.

FILTRATION



While filtration soaks bulky laundry faster and thoroughly, it is made for a big wash.

ROLLING



Also known as the Silent Wash, it rolls the laundry below the water level and causes no damage to the clothes.

STEPPING



No more wrinkles on your shirts. Stepping is just like wrinkle care that prevents creases and causes no damage to the fabrics.

SWING



Designed for delicate clothes, the swing motion ensures smooth drum action which prevents fabric damage and creasing.

ALLERGEN REMOVAL

Steam* Technology activates Allergy Care* that removes allergens.



Without Steam*

With Steam*



Steam+

Allergen + **Wrinkle Free***

- Removes 99.9%* Allergens
- Reduces 30%* wrinkles



Images/products shown are for illustration purposes only. Actual product may vary due to product enhancement. Features may vary from model to model. All third party logos, trademark and other Intellectual Properties are property of respective brands and LG doesn't hold any rights pursuant to same. *Tested by 3rd Party under standard conditions. The results may be different depending on the clothes and environment. Allergy Care cycle approved by BAF (British Allergy Foundation) for reduction in exposure to house dust mite allergen, cat allergen, dog allergen, pollen allergen, fungi, and bacteria. Cotton cycle with 'Wrinkle Care' option (3 mixed shirts) compared to Cotton cycle without option. The results may be different depending on the clothes and environment. Wrinkle Care is available as an option in 6 cycles. For more details, visit www.lg.com

TurboWash 360°

THOROUGHLY CLEANS IN 39 MINUTES*

With TurboWash 360° your laundry can be thoroughly done in just 39 minutes* with more fabric protection. 4 directions of 3D multi-nozzles reach every inch of your laundry to add to the wash performance.



**36%* Less
Laundry Time**

Enhances the wash results with reduced laundry time.



**28%* More
Energy Efficiency**

Performs better to add to your savings.



**16%* Less
Clothes Damage**

Washes clothes better and keeps them new for longer.



Images/products shown are for illustration purposes only. Actual product may vary due to product enhancement. Features may vary from model to model. All third party logos, trademark and other Intellectual Properties are property of respective brands and LG doesn't hold any rights pursuant to same. *Tested by Intertek, based on IEC 60456 : edition 5.0. TurboWash39 cycle with 5kg of IEC load compared to Conventional Cotton Cycle with TurboWash (F4V9RWP2W vs. FC1450S2W). The results may be different depending on the environment. For more details, visit www.lg.com



BIGGER DRUM

Bigger Capacity in the same space

LG's new Bigger Drum is designed to cater to the Indian need of washing big loads at once. So, be it an entire load of a joint family or a compiled load of a nuclear one, it allows you to wash them at the same time and enhances your washing experience.

More Height leads to a Better Wash

The Tumble Wash motion drops clothes from a higher elevation, making the dirt lose its grip, to give a superior wash.



Step 1



Step 2



Step 3

BE AT HOME, WITHOUT BEING AT HOME.

powered by **ThinQ*** (Works on Wi-Fi)

Control & monitor your washer anytime,
from anywhere with just one app (Wi-Fi only)

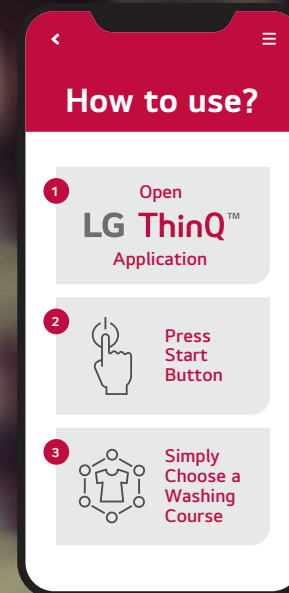

Remote Control & Monitor

Monitors and controls your smart Washing Machine from anywhere.



Push Alerts

Notifies when a cycle is completed, or an error occurs on the Washing Machine.



Smart Diagnosis

Allows you to troubleshoot the Washing Machine.



Tub Clean Coach

Alarms when it is time to clean the tub.



Download Cycle

Downloads new cycles to the Washing Machine.



Energy Monitoring

Checks energy usage for recent cycles in the month.

FULLY STAINLESS STEEL DRUM More Hygiene. More Durability.

Built to bring convenience and durability, this Stainless Steel Drum makes your washing machine last longer. Not just this, its Stainless Steel Lifters keep the insides of the washing machine hygienic.



Conventional Plastic Lifters

Contaminate the clothes with bacteria.



LG Stainless Steel Lifters

No contamination.
Only hygiene.

WASHTOWER



FWT1310BG 13 kg / 10 kg

Washer

- AI DD®
- 6 Motion DD
- Steam+
- TurboWash 360°

Dryer

- Dual Inverter Heat Pump™
- Condenser Dryer
- Auto Cleaning Condenser
- Double Layer Air Filter

Common Features

- Time Saving (16 Mins Wash+43 Mins Dry)
- Smart Pairing
- Space Saving Design
- Centre Control Panel
- LG ThinQ™ (Wi-Fi)
- Color: Natural Green, Natural Beige



FWT1310PB 13 kg / 10 kg

Washer

- AI DD®
- 6 Motion DD
- Steam+
- TurboWash 360°

Dryer

- Dual Inverter Heat Pump™
- Condenser Dryer
- Auto Cleaning Condenser
- Double Layer Air Filter

Common Features

- Time Saving (16 Mins Wash+43 Mins Dry)
- Smart Pairing
- Space Saving Design
- Centre Control Panel
- LG ThinQ™ (Wi-Fi)
- Color: Platinum Black



DRYER



DHV09SWB 9 kg

- Dual Inverter Heat Pump™
- EcoHybrid
- Allergy Care
- Dual Lint Filter
- LG ThinQ™ (Wi-Fi)
- Color: Black VCM



LG ThinQ™



DHV09SAB 9 kg

- Dual Inverter Heat Pump™
- EcoHybrid
- Allergy Care
- Dual Lint Filter
- Auto Restart
- LG ThinQ™ (Wi-Fi)
- Color: Black Steel



LG ThinQ™



DHV09SAM 9 kg

- Dual Inverter Heat Pump™
- Eco Hybrid
- Allergy Care
- Dual Lint Filter
- Auto Restart
- LG ThinQ™ (Wi-Fi)
- Color: Middle Black



LG ThinQ™

WASHER DRYER



FHD2112STB

21 kg / 12 kg

BIGGER CAPACITY

- Inverter Direct Drive
- 6 Motion DD
- TurboWash™
- Steam™
- LG ThinQ™ (Wi-Fi)
- Smart Diagnosis
- 10-Year Warranty*
- RPM: Max. 1000
- Color: Black VCM



FHD1508STB

15 kg / 8 kg

BIGGER CAPACITY

- AI DD®
- Inverter Direct Drive
- 6 Motion DD
- TurboWash™
- Steam™
- LG ThinQ™ (Wi-Fi)
- Smart Diagnosis
- 10-Year Warranty*
- RPM: Max. 1000
- Color: Black VCM



FHD1308STB

13 kg / 8 kg

BIGGER CAPACITY

- AI DD®
- Inverter Direct Drive
- 6 Motion DD
- Ez-Dispense™
- TurboWash 360°
- Steam+
- LG ThinQ™ (Wi-Fi)
- Smart Diagnosis
- 10-Year Warranty*
- RPM: Max. 1400
- Color: Black VCM



FHD1107STB

11 kg / 7 kg

BIGGER CAPACITY

- AI DD®
- Inverter Direct Drive
- 6 Motion DD
- TurboWash 360°
- Steam+
- LG ThinQ™ (Wi-Fi)
- Smart Diagnosis
- 10-Year Warranty*
- RPM: Max. 1400
- Color: Black VCM



FHD0905STB

9 kg / 5 kg

- AI DD®
- Inverter Direct Drive
- 6 Motion DD
- TurboWash 360°
- Steam+
- LG ThinQ™ (Wi-Fi)
- Smart Diagnosis
- 10-Year Warranty*
- RPM: Max. 1200
- Color: Black VCM



FRONT LOAD WASHING MACHINES



FHP1413Z7M 13 kg

- BIGGER CAPACITY**
- AI DD®
 - Inverter Direct Drive
 - 6 Motion DD
 - Ez-Dispense™
 - TurboWash 360°
 - Steam™
 - LG ThinQ™ (Wi-Fi)
 - Smart Diagnosis
 - 10-Year Warranty*
 - RPM: Max. 1400
 - Color: Middle Black
- AI DD® Steam™ Inverter Direct Drive
MOTION DD DirectDrive Ez-Dispense™



FHP1411Z9B 11 kg

- BIGGER CAPACITY**
- AI DD®
 - Inverter Direct Drive
 - 6 Motion DD
 - TurboWash 360°
 - Steam+
 - LG ThinQ™ (Wi-Fi)
 - Smart Diagnosis
 - 10-Year Warranty*
 - RPM: Max. 1400
 - Color: Black VCM
- AI DD® Steam+™ Inverter Direct Drive
MOTION DD DirectDrive



FHP1411Z9P 11 kg

- BIGGER CAPACITY**
- AI DD®
 - Inverter Direct Drive
 - 6 Motion DD
 - TurboWash 360°
 - Steam+
 - LG ThinQ™ (Wi-Fi)
 - Smart Diagnosis
 - 10-Year Warranty*
 - RPM: Max. 1400
 - Color: Platinum Silver
- AI DD® Steam+™ Inverter Direct Drive
MOTION DD DirectDrive



FHP1411Z5M 11 kg

- BIGGER CAPACITY**
- AI DD®
 - Inverter Direct Drive
 - 6 Motion DD
 - Steam™
 - LG ThinQ™ (Wi-Fi)
 - Smart Diagnosis
 - 10-Year Warranty*
 - RPM: Max. 1400
 - Color: Middle Black
- AI DD® Steam™ Inverter Direct Drive
MOTION DD DirectDrive



FHP1410Z7P 10 kg

- BIGGER CAPACITY**
- AI DD®
 - Inverter Direct Drive
 - 6 Motion DD
 - TurboWash™
 - Steam+
 - LG ThinQ™ (Wi-Fi)
 - Smart Diagnosis
 - 10-Year Warranty*
 - RPM: Max. 1400
 - Color: Platinum Silver
- AI DD® Steam+™ Inverter Direct Drive
MOTION DD DirectDrive



FHP1410Z7B 10 kg

- BIGGER CAPACITY**
- AI DD®
 - Inverter Direct Drive
 - 6 Motion DD
 - TurboWash™
 - Steam+
 - LG ThinQ™ (Wi-Fi)
 - Smart Diagnosis
 - 10-Year Warranty*
 - RPM: Max. 1400
 - Color: Black VCM
- AI DD® Steam+™ Inverter Direct Drive
MOTION DD DirectDrive



FHP1410Z5M 10 kg

- BIGGER CAPACITY**
- AI DD®
 - Inverter Direct Drive
 - 6 Motion DD
 - Steam™
 - LG ThinQ™ (Wi-Fi)
 - Smart Diagnosis
 - 10-Year Warranty*
 - RPM: Max. 1400
 - Color: Middle Black
- AI DD® Steam™ Inverter Direct Drive
MOTION DD DirectDrive



FHP1209Z9B 9 kg

- BIGGER CAPACITY**
- AI DD®
 - Inverter Direct Drive
 - 6 Motion DD
 - TurboWash 360°
 - Steam+
 - LG ThinQ™ (Wi-Fi)
 - Smart Diagnosis
 - 10-Year Warranty*
 - RPM: Max. 1200
 - Color: Black VCM
- AI DD® Steam+™ Inverter Direct Drive
MOTION DD DirectDrive



FHP1209Z7P 9 kg

- AI DD®
- Inverter Direct Drive
- 6 Motion DD
- TurboWash™
- Steam+
- LG ThinQ™ (Wi-Fi)
- Smart Diagnosis
- 10-Year Warranty*
- RPM: Max. 1200
- Color: Platinum Silver



FHP1209Z5M 9 kg

- AI DD®
- Inverter Direct Drive
- 6 Motion DD
- Steam™
- LG ThinQ™ (Wi-Fi)
- Smart Diagnosis
- 10-Year Warranty*
- RPM: Max. 1200
- Color: Middle Black



FHV1409Z4M 9 kg

- AI DD®
- Inverter Direct Drive
- 6 Motion DD
- Steam™
- LG ThinQ™ (Wi-Fi)
- Smart Diagnosis
- 10-Year Warranty*
- RPM: Max. 1400
- Color: Middle Black



FHV1409Z2M 9 kg

- AI DD®
- Inverter Direct Drive
- 6 Motion DD
- Steam™
- LG ThinQ™ (Wi-Fi)
- Smart Diagnosis
- 10-Year Warranty*
- RPM: Max. 1400
- Color: Middle Black



NEW **FHB1209Z4B** 9 kg

- Inverter Direct Drive
- 6 Motion DD
- Steam™
- LG ThinQ™ (Wi-Fi)
- Smart Diagnosis
- 10-Year Warranty*
- RPM: Max. 1200
- Color: Platinum Black



NEW **FHB1209Z4P** 9 kg

- Inverter Direct Drive
- 6 Motion DD
- Steam™
- LG ThinQ™ (Wi-Fi)
- Smart Diagnosis
- 10-Year Warranty*
- RPM: Max. 1200
- Color: Platinum Silver



NEW **FHB1209Z4M** 9 kg

- Inverter Direct Drive
- 6 Motion DD
- Steam™
- LG ThinQ™ (Wi-Fi)
- Smart Diagnosis
- 10-Year Warranty*
- RPM: Max. 1200
- Color: Middle Black



NEW **FHB1209Z2M** 9 kg

- Inverter Direct Drive
- 6 Motion DD
- Steam™
- Smart Diagnosis
- 10-Year Warranty*
- RPM: Max. 1200
- Color: Middle Black



FHP1208Z5P 8 kg

- AI DD®
- Inverter Direct Drive
- 6 Motion DD
- Steam™
- LG ThinQ™ (Wi-Fi)
- Smart Diagnosis
- 10-Year Warranty*
- RPM: Max. 1200
- Color: Platinum Silver





FHP1208Z5M 8 kg

- AI DD®
- Inverter Direct Drive
- 6 Motion DD
- Steam™
- LG ThinQ™ (Wi-Fi)
- Smart Diagnosis
- 10-Year Warranty*
- RPM: Max. 1200
- Color: Middle Black



FHP1208A5M 8 kg

- AI DD®
- Inverter Direct Drive
- 6 Motion DD
- Steam™
- LG ThinQ™ (Wi-Fi)
- Smart Diagnosis
- 10-Year Warranty*
- RPM: Max. 1200
- Color: Middle Black



FHP1208Z3M 8 kg

- AI DD®
- Inverter Direct Drive
- 6 Motion DD
- Steam™
- Smart Diagnosis
- 10-Year Warranty*
- RPM: Max. 1200
- Color: Middle Black



FHV1408Z2M 8 kg

- AI DD®
- Inverter Direct Drive
- 6 Motion DD
- Steam™
- Smart Diagnosis
- 10-Year Warranty*
- RPM: Max. 1400
- Color: Middle Black



NEW **FHB1208Z4P** 8 kg

- Inverter Direct Drive
- 6 Motion DD
- Steam™
- LG ThinQ™ (Wi-Fi)
- Smart Diagnosis
- 10-Year Warranty*
- RPM: Max. 1200
- Color: Platinum Silver



NEW **FHB1208Z4M** 8 kg

- Inverter Direct Drive
- 6 Motion DD
- Steam™
- LG ThinQ™ (Wi-Fi)
- Smart Diagnosis
- 10-Year Warranty*
- RPM: Max. 1200
- Color: Middle Black



NEW **FHB1208Z2M** 8 kg

- Inverter Direct Drive
- 6 Motion DD
- Steam™
- Smart Diagnosis
- 10-Year Warranty*
- RPM: Max. 1200
- Color: Middle Black



FHV1207Z4M 7 kg

- AI DD®
- Inverter Direct Drive
- 6 Motion DD
- Steam™
- LG ThinQ™ (Wi-Fi)
- Smart Diagnosis
- 10-Year Warranty*
- RPM: Max. 1200
- Color: Middle Black



FHV1207Z2M 7 kg

- AI DD®
- Inverter Direct Drive
- 6 Motion DD
- Steam™
- Smart Diagnosis
- 10-Year Warranty*
- RPM: Max. 1200
- Color: Middle Black





FHB1207Z4M 7 kg

- Inverter Direct Drive
- 6 Motion DD
- Steam™
- LG ThinQ™ (Wi-Fi)
- Smart Diagnosis
- 10-Year Warranty*
- RPM: Max. 1200
- Color: Middle Black



FHB1207Z2MA 7 kg

- Inverter Direct Drive
- 6 Motion DD
- Steam™
- Smart Diagnosis
- 10-Year Warranty*
- RPM: Max. 1200
- Color: Middle Black



FHB1207Z2M 7 kg

- Inverter Direct Drive
- 6 Motion DD
- Steam™
- Smart Diagnosis
- 10-Year Warranty*
- RPM: Max. 1200
- Color: Middle Black



FHV1265Z2M 6.5 kg

- AI DD®
- Inverter Direct Drive
- 6 Motion DD
- Steam™
- Smart Diagnosis
- 10-Year Warranty*
- RPM: Max. 1200
- Color: Middle Black





Presenting the new range of
**LG TOP LOAD
WASHING
MACHINES WITH
AI DIRECT DRIVE®**

Go Easy, Go Intelligent!

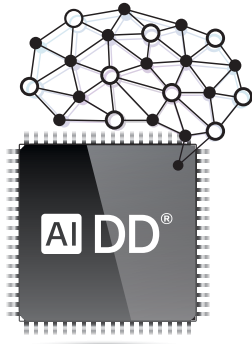

LG AI DD[®]

LG's AI Direct Drive technology automatically selects the optimal wash cycle from over 20,000 pre-loaded wash patterns. So, now you can get more fabric protection with just a push of a button.

MORE FABRIC CARE

INVERTER DIRECT DRIVE MOTOR Less Vibration. Less Noise. More Durability.

The LG Direct Drive Motor with Inverter Technology is a reliable, quiet, and durable mechanism in which fewer parts move, unlike the traditional belt and pulley system.

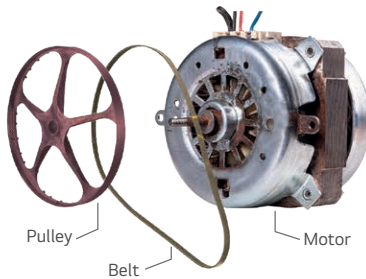

Conventional Motor Belt and Pulley System



LG Direct Drive Motor
No Belt No Pulley



MOTION DD^{DirectDrive} Better Wash Performance. Cleaner Clothes.



Agitating



Rotating



Swing



Rubbing



Compressing



Power Motion

AUTOMATICALLY DETECTS

FABRIC LOAD AND SOFTNESS



MORE CONVENIENCE



Images/products shown are for illustration purposes only. Actual product may vary due to product enhancement. Features may vary from model to model. All third party logos, trademark and other Intellectual Properties are property of respective brands and LG doesn't hold any rights pursuant to same. For more details, visit www.lg.com

Steam™ IN-BUILT HEATER

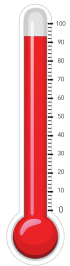

Steam Wash for Allergy Removal

Now say goodbye to House Dust Mites and Allergens with LG Top Load Washing Machine's In-built Heater. Located beneath the inner tub, this heater raises the water temperature up to 60°C, resulting in more hygienic clothes.

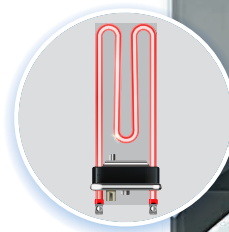

Images/products shown are for illustration purposes only. Actual product may vary due to product enhancement. Features may vary from model to model. All third party logos, trademark and other Intellectual Properties are property of respective brands and LG doesn't hold any rights pursuant to same. *Tested by 3rd Party under standard conditions. The results may be different depending on the clothes and environment. Allergy Care cycle approved by BAF (British Allergy Foundation) for reduction in exposure to house dust mite allergen, cat allergen, dog allergen, pollen allergen, fungi, and bacteria. For more details, visit www.lg.com



| **LG ThinQ™** Operate Laundry Remotely

- Our LG ThinQ feature lets you control the LG Washing Machine from anywhere.
- You can download additional wash programs depending on the fabrics and stains.

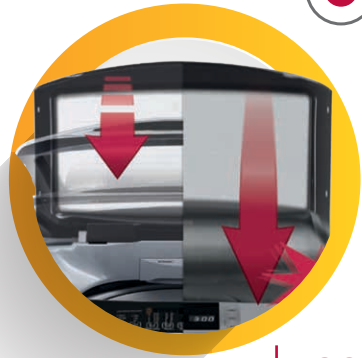

| **SOFT CLOSING DOOR** Safe & Convenient

Unlike other washing machine doors, LG's Top Load Washing Machine comes with a soft closing door that is safe and convenient.



LG v/s Conventional



| **NEW WIDE FILTER** Better Lint Collection

LG Top Load Washing Machines come with a new wide filter design that increases the lint collection rate.



| **STAINLESS STEEL PULSATOR** Built to Bring More Durability

The Stainless Steel Pulsator stays rust-free and it keeps you worry-free by providing hygienic clothes. What's more, it is built tough to increase the machine's life.

BIGGER DRUM

Bigger Capacity in the Same Space

Do more laundry in one load with less vibration, more spin speed and smooth operation.



TurboDrum Better Wash Performance

TurboDrum enables the most powerful wash and removes the toughest dirt through a strong water stream generated by rotating the drum and pulsator in the opposite direction.

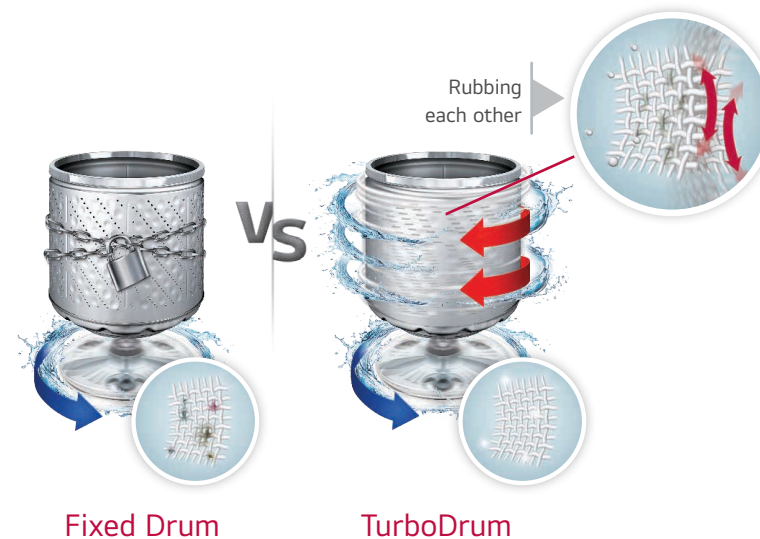

AI DIRECT DRIVE® TOP LOAD WASHING MACHINES



THD13SWP
THD12SWP
THD11SWP
THD10SWP

13 kg
12 kg
11 kg
10 kg

BIGGER CAPACITY

- AI DD®
- Direct Drive Motor
- 6 Motion DD
- Steam™ with In-built Heater
- TurboWash™ • LG ThinQ™ (Wi-Fi)
- Soft Closing Door • Smart Diagnosis
- Color: Platinum Black



THD11SWM
THD09SWM

11 kg
9 kg

BIGGER CAPACITY

- AI DD®
- Direct Drive Motor
- 6 Motion DD
- Steam™ with In-built Heater
- TurboWash™
- LG ThinQ™ (Wi-Fi)
- Soft Closing Door
- Smart Diagnosis
- Color: Middle Black



THD11NWM
THD10NWM
THD09NWM

11 kg
10 kg
9 kg

BIGGER CAPACITY

- AI DD®
- Direct Drive Motor
- 6 Motion DD
- TurboWash™
- LG ThinQ™ (Wi-Fi)
- Soft Closing Door
- Smart Diagnosis
- Color: Middle Black



NEW

THD10NPM
THD08NPM

10 kg
8 kg

- AI DD®
- Direct Drive Motor
- 6 Motion DD
- Soft Closing Door
- Smart Diagnosis
- Color: Middle Black



NEW

THD09SPM
THD08SPM

9 kg
8 kg

- AI DD®
- Direct Drive Motor
- 6 Motion DD
- Steam™ with In-built Heater
- Soft Closing Door
- Smart Diagnosis
- Color: Middle Black



NEW

THD08SJM

8 kg

- AI DD®
- Direct Drive Motor
- 6 Motion DD
- Steam™ with In-built Heater
- Jet Spray+
- TurboWash™
- Soft Closing Door
- Smart Diagnosis
- Color: Middle Black





**GOOD FOR
CLOTHES.
HARSH ON
STAINS.**

Smart Inverter Range

SMART INVERTER. SMART CHOICE.

LG Washing Machine comes with Smart Inverter Technology that is designed to multiply your delight with



36%*
Energy Saving

Uses less energy without impacting the performance



**New Compact &
Waterproof Motor**

Built to serve durability



**10-Year
Warranty***

Provides you with complete peace of mind

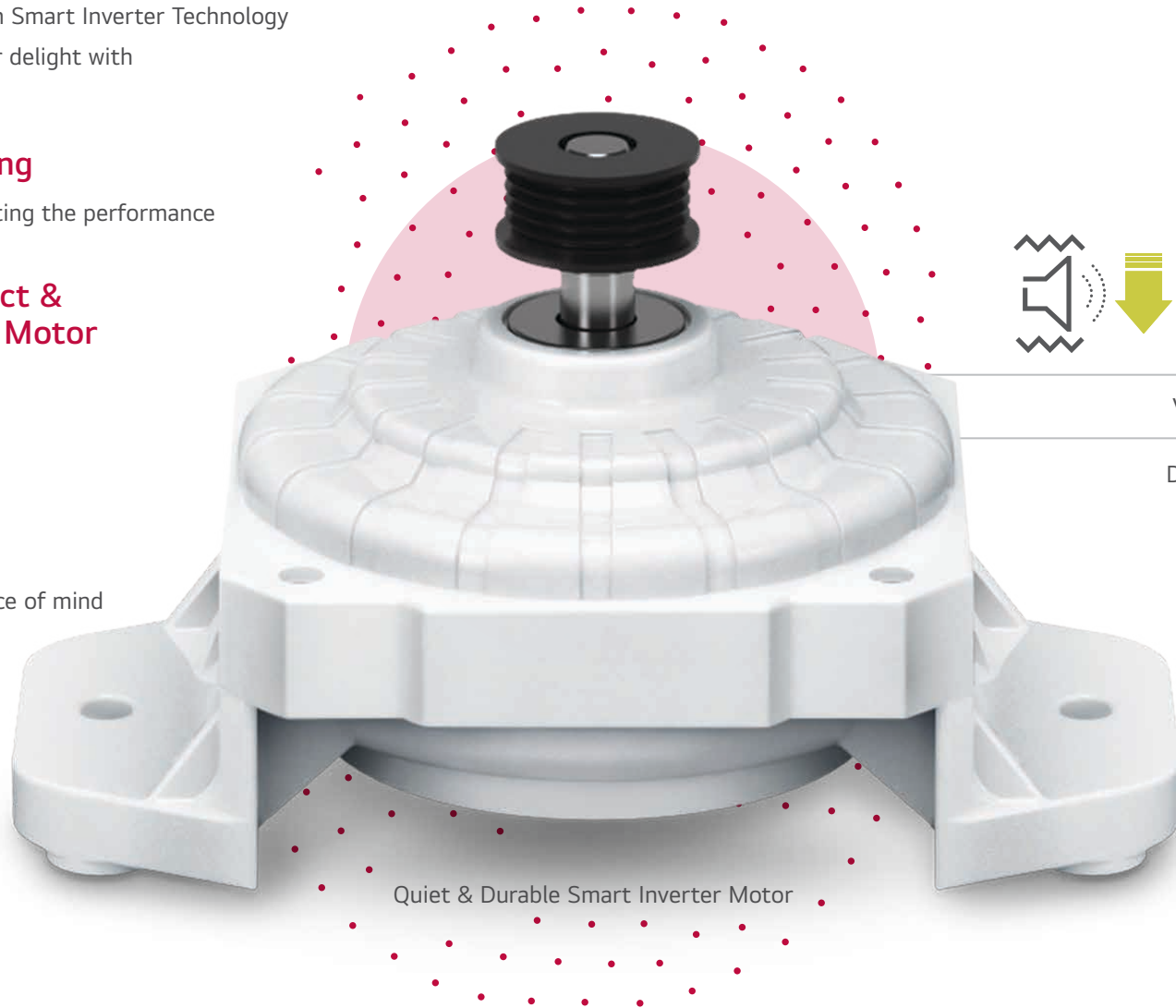

Quiet & Durable Smart Inverter Motor

FULLY-AUTOMATIC WASHING MACHINE FOR A PERFECT WASH

The revolutionary in-built Jet Spray+, with its powerful water spray, washes off dirt and excess detergent, giving you the best possible wash.

Jet Spray+

No Rubbing. No Scrubbing.

Key Benefits: _____



SAVE 70L*
WATER
per wash cycle



SAVE 40%*
ENERGY
with less cycle time



Wash cycle
LESS THAN
39* MINS

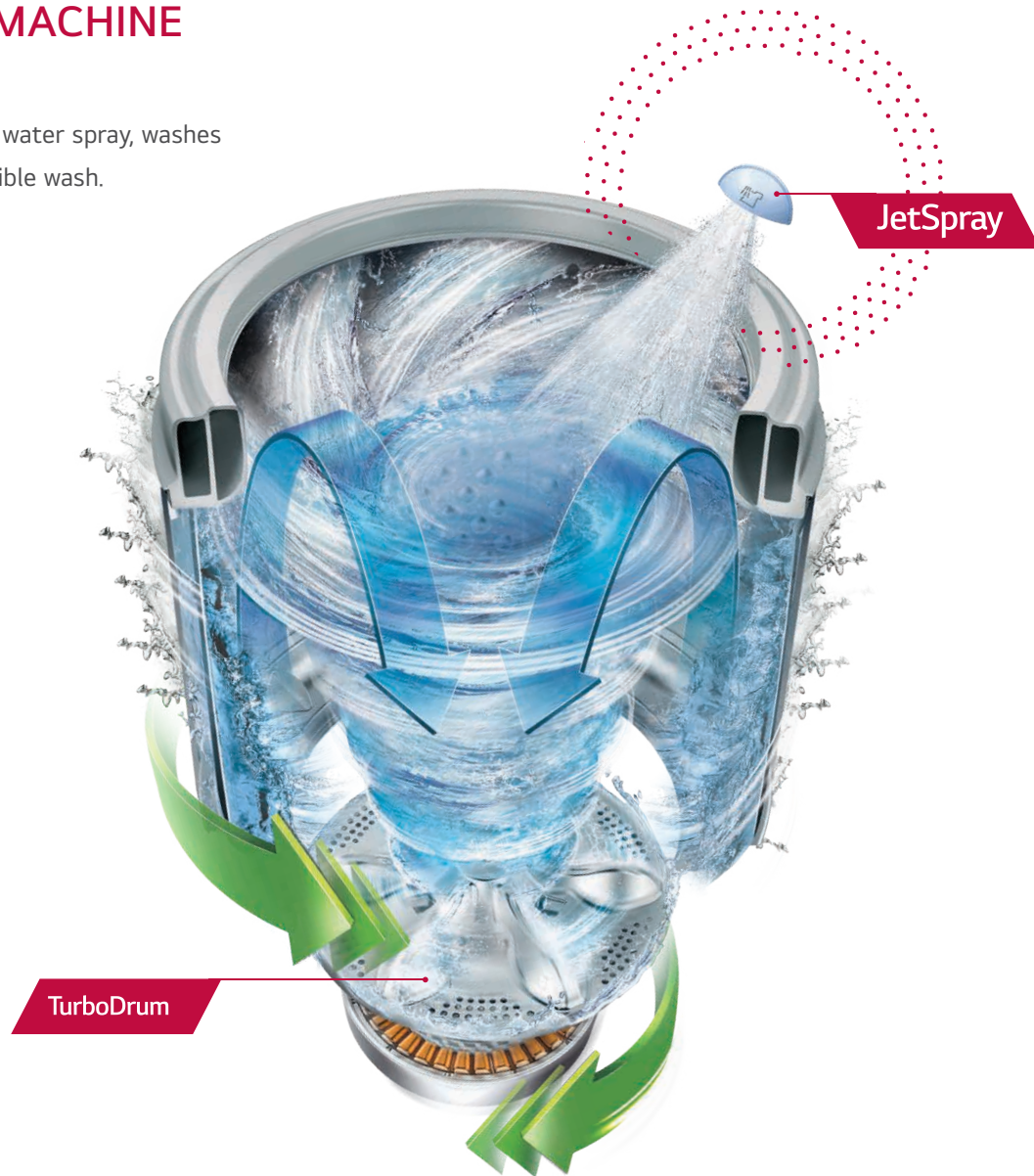

3 SMART MOTIONS

3 kinds of tub movements, controlled by Smart Inverter, provide enhanced washing performance along with better care of clothes.

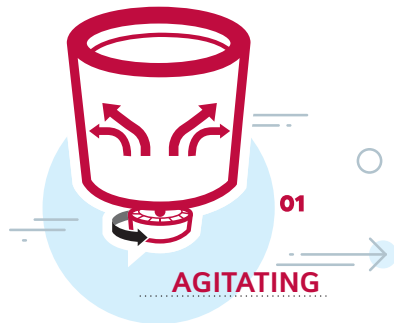

Powerful Washing

Removes heavy stains by creating a powerful water stream.

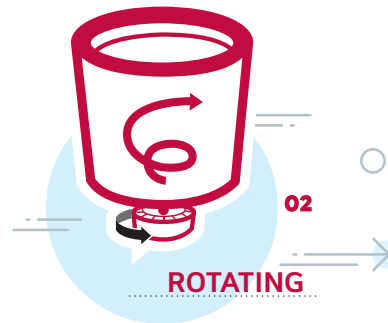

Tangle-Free

Untangles clothes at the end of the washing and rinsing cycle by frequently changing spin direction.

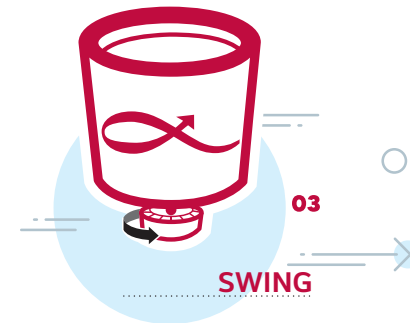

Delicate Wash

Minimizes fabric damage by moving clothes gently, especially delicate clothes.

Punch+ 3

Punch+ 3 creates water streams in the vertical direction which move laundry up and down repeatedly for an even washing result.



TurboDrum Better Wash Performance

TurboDrum enables the most powerful wash and removes the toughest dirt through a strong water stream made by rotating the drum and pulsator in the opposite direction.

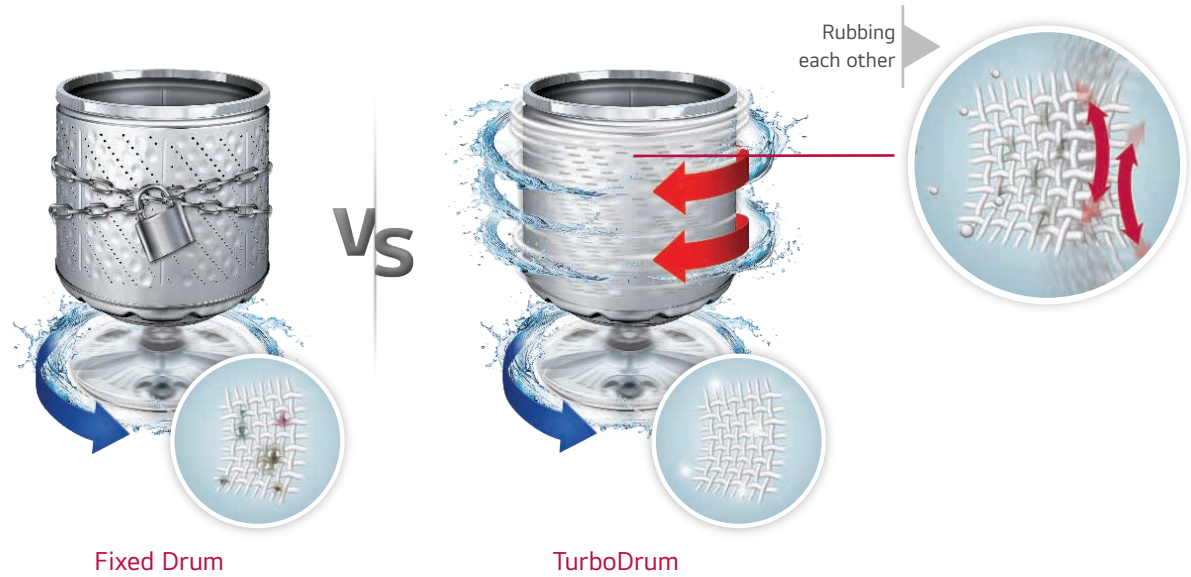

SOFT CLOSING & WIDE DIAMOND GLASS DOOR



Safe, Convenient,
and Noise-Reducing



Shock-Resistant, Anti-Scratch,
and Wide View

Keep Dust, Bacteria &
Lint Away with

LG AUTO TUB CLEAN

Introducing the game changer Auto Tub Clean feature that lets your LG Washing Machine's tub clean itself automatically. So now, bid goodbye to scrubbing and say hello to effortless maintenance. Enjoy impeccable hygiene with every wash, minus the manual labour and make way for a cleaner and more convenient laundry experience.



BETTER HYGIENE | **NO MANUAL CLEANING** | **MORE LINT REMOVAL** | **ENHANCED DURABILITY**

INTRODUCING TOP LOAD WASHING MACHINES AUTO TUB CLEAN SERIES



T85AJMB1Z
T80AJMB1Z **8.5 kg**
8 kg

- Smart Inverter Motor
- Auto Tub Clean
- Jet Spray+
- TurboWash™
- Smart Diagnosis
- TurboDrum
- Soft Closing Door
- Color: Middle Black



T90AJPB1Z **9 kg**

- Smart Inverter Motor
- Auto Tub Clean
- Jet Spray+
- TurboWash™
- Smart Diagnosis
- TurboDrum
- Soft Closing Door
- Color: Platinum Black



T90AJMB1Z **9 kg**

- Smart Inverter Motor
- Auto Tub Clean
- Jet Spray+
- TurboWash™
- Smart Diagnosis
- TurboDrum
- Soft Closing Door
- Color: Middle Black



T80AJSF1Z **8 kg**

- Smart Inverter Motor
- Auto Tub Clean
- Jet Spray+
- TurboWash™
- Smart Diagnosis
- TurboDrum
- Soft Closing Door
- Color: Middle Free Silver



T70AJMB1Z **7 kg**

- Smart Inverter Motor
- Auto Tub Clean
- Jet Spray+
- TurboWash™
- Smart Diagnosis
- TurboDrum
- Soft Closing Door
- Color: Middle Black



TOP LOAD WASHING MACHINES



T12SJMB1Z 12 kg
T10SJMB1Z 10 kg

BIGGER CAPACITY

- Smart Inverter Motor
- Jet Spray+
- TurboWash™
- Smart Diagnosis
- TurboDrum
- Soft Closing Door
- Auto Pre Wash
- Color: Middle Black



T80SNMB1Z 8 kg

- Smart Inverter Motor
- TurboDrum
- Smart Diagnosis
- 3 Smart Motions
- Soft Closing Door
- Auto Pre Wash
- Auto Restart
- Color: Middle Black



T80SNSF1Z 8 kg

- Smart Inverter Motor
- TurboDrum
- Smart Diagnosis
- 3 Smart Motions
- Soft Closing Door
- Auto Pre Wash
- Auto Restart
- Color: Middle Free Silver



T80SPMB1Z 8 kg
T70SPMB1Z 7 kg

- Smart Inverter Motor
- TurboDrum
- Smart Diagnosis
- 3 Smart Motions
- Soft Closing Door
- Auto Pre Wash
- Auto Restart
- Color: Middle Black



T80SPSF1Z 8 kg
T70SPSF1Z 7 kg

- Smart Inverter Motor
- TurboDrum
- Smart Diagnosis
- 3 Smart Motions
- Soft Closing Door
- Auto Pre Wash
- Auto Restart
- Color: Middle Free Silver



T80SKSF1Z 8 kg
T75SKSF1Z 7.5 kg

- Smart Inverter Motor
- TurboDrum
- Smart Diagnosis
- 3 Smart Motions
- Auto Pre Wash
- Auto Restart
- Color: Middle Free Silver



T80VMB1Z 8 kg

- Smart Inverter Motor
- TurboDrum
- Smart Diagnosis
- 3 Smart Motions
- Soft Closing Door
- Auto Pre Wash
- Auto Restart
- Color: Middle Black



T75VMB1Z 7.5 kg

- Smart Inverter Motor
- TurboDrum
- Smart Diagnosis
- 3 Smart Motions
- Soft Closing Door
- Auto Pre Wash
- Auto Restart
- Color: Middle Black





T75SPSF1Z 7.5 kg

- Smart Inverter Motor
- TurboDrum
- Smart Diagnosis
- 3 Smart Motions
- Soft Closing Door
- Auto Pre Wash
- Auto Restart
- Color: Middle Free Silver



T75SKMB1Z 7.5 kg

- Smart Inverter Motor
- TurboDrum
- Smart Diagnosis
- 3 Smart Motions
- Auto Pre Wash
- Auto Restart
- Color: Middle Black



T75SKSF1Z 7.5 kg
T70SKSF1Z 7 kg

- Smart Inverter Motor
- TurboDrum
- Smart Diagnosis
- 3 Smart Motions
- Auto Pre Wash
- Auto Restart
- Color: Middle Free Silver



T70SPSF1ZA 7 kg
T70SPSF2Z 7 kg

- Smart Inverter Motor
- TurboDrum
- Smart Diagnosis
- 3 Smart Motions
- Soft Closing Door
- Auto Pre Wash
- Auto Restart
- Color: Middle Free Silver



T70SPMB1Z 7 kg

- Smart Inverter Motor
- TurboDrum
- Smart Diagnosis
- 3 Smart Motions
- Soft Closing Door
- Auto Pre Wash
- Auto Restart
- Color: Middle Black



T65SKSF4Z 6.5 kg

- Smart Inverter Motor
- TurboDrum
- Smart Diagnosis
- 3 Smart Motions
- Auto Pre Wash
- Auto Restart
- Color: Middle Free Silver





LG SEMI-AUTOMATIC
WASHING MACHINES

**STAIN-FREE
CLOTHES.
STRESS-FREE
YOU.**



| ROLLER JET PULSATOR

Roller Jet Pulsator rotates the clothes effectively & washes out every stain from the clothes, giving you the best wash performance while being gentle on the clothes. The roller case creates friction to effectively remove dust and mites. This technology propels detergent-rich water into every thread of the fabric. It also scrubs your clothes effectively, resulting in a better-quality wash.

3 WASH PROGRAMS

The 3 Wash Programs add delight to your wash experience. With gentle, normal and strong wash programs, the machine caters to a diverse range of washing with utmost ease.

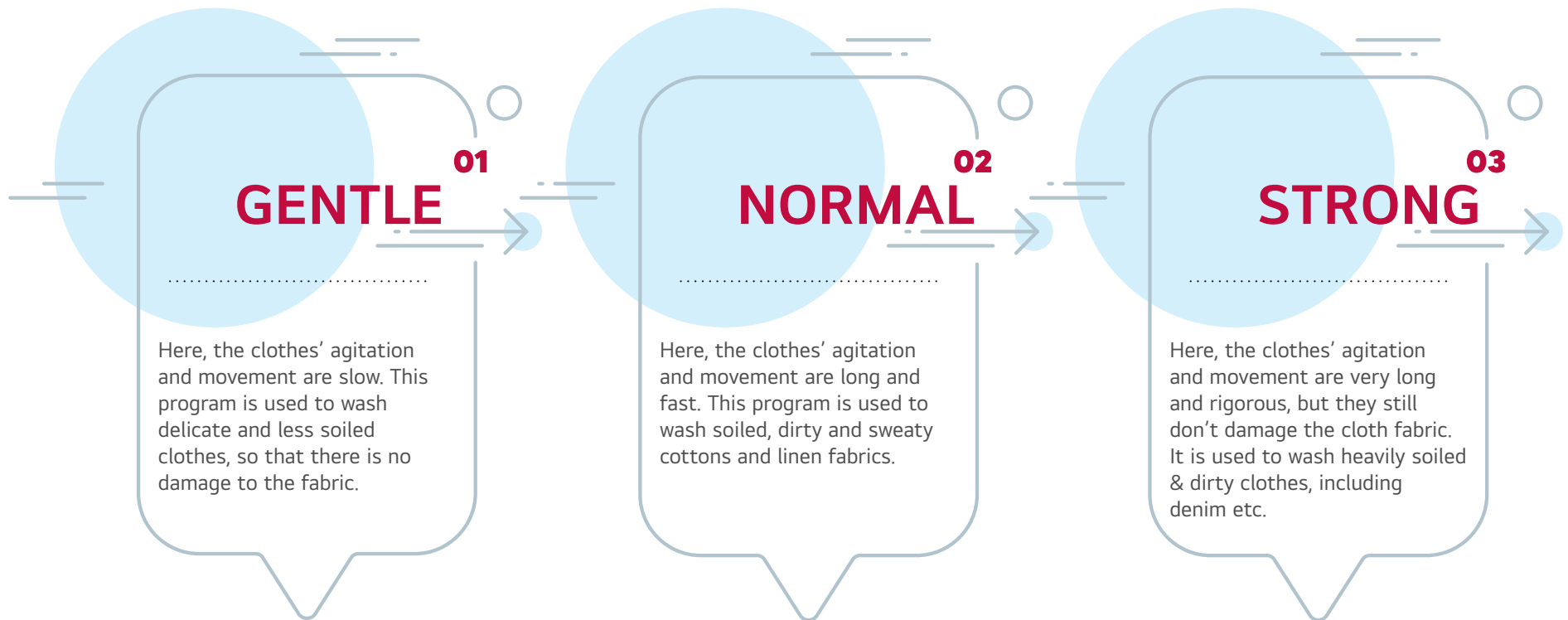

MAGIC FILTER

LG Magic Filter is here to provide you relief from the worry of lint and threads sticking to your clothes by separating the extra lint. So, with LG Magic Filter, get clean and lint-free clothes every time.



STAR WASHING MACHINES



LG Washing Machines qualify the norms of the Bureau of Energy Efficiency of India with 5-Star Ratings (Labels). Created with the best technology, our wide range of Washing Machines not only saves water and electricity but also provides the best wash quality.



RAT AWAY TECHNOLOGY

Better Protection. Enhanced Durability.

The Rat Away Technology comes with a 3 mm strong plastic cover with a rat-repellent chemical that helps in keeping rats away from your machine.

Now don't worry about rats damaging your washing machine by cutting internal wires which in turn affects its durability & performance.



Less damage
in machine by
RAT BITE



More
DURABILITY
of machine



Better
SAVINGS with low
maintenance cost

Additional Features

Introducing additional features like soak, wind jet dry, and magic wheels, we aim at enhancing your wash experience.

01

SOAK

The machine's unique soak process soaks clothes in a concentrated detergent solution to help loosen tough dirt particles.



02

WIND JET DRY

It removes the remaining moisture from the laundry and from within the washing machine. When the Spin Tub rotates at high RPM, the air flows into the tub and circulates to remove water. This circulation of air through air vents dries the clothes.



03

MAGIC WHEELS

With 360-degree Magic Wheels, you can swiftly move and rotate your washing machine in any direction with ease and without any help.



SEMI-AUTOMATIC WASHING MACHINES



P1465SKAZ 14 kg
BIGGER CAPACITY

- Roller Jet Pulsator + Soak
- 5-Year Motor Warranty
- Rat Away
- Buzzer
- Smart Filter
- Wind Jet Dry
- Color: Middle Black



P115ASKAZ 11.5 kg
BIGGER CAPACITY

- Roller Jet Pulsator + Soak
- 5-Year Motor Warranty
- Rat Away
- Buzzer
- Smart Filter
- Wind Jet Dry
- Color: Middle Black



P115ASLAZ 11.5 kg
BIGGER CAPACITY

- Roller Jet Pulsator + Soak
- 5-Year Motor Warranty
- Rat Away
- Buzzer
- Smart Filter
- Wind Jet Dry
- Color: Full Black



P115ASDAZ 11.5 kg

- Roller Jet Pulsator + Soak
- 5-Year Motor Warranty
- Rat Away
- Buzzer
- Smart Filter
- Wind Jet Dry
- Color: Full Burgundy



P1155SRAZ 11 kg
BIGGER CAPACITY

- Roller Jet Pulsator + Soak
- 5-Year Motor Warranty
- Rat Away
- Buzzer
- Smart Filter
- Wind Jet Dry
- Color: Burgundy



P105ASRAZ 10.5 kg
BIGGER CAPACITY

- Roller Jet Pulsator + Soak
- 5-Year Motor Warranty
- Rat Away
- Buzzer
- Smart Filter
- Wind Jet Dry
- Color: Burgundy



P1040RGAZ 10 kg
BIGGER CAPACITY

- Roller Jet Pulsator
- 5-Year Motor Warranty
- Rat Away
- Buzzer
- Color: Dark Grey



P9555SKAZ 9.5 kg

- Roller Jet Pulsator + Soak
- 5-Year Motor Warranty
- Rat Away
- Buzzer
- Smart Filter
- Wind Jet Dry
- Color: Middle Black





P955ASGAZ 9.5 kg

- Roller Jet Pulsator + Soak
- 5-Year Motor Warranty
- Rat Away
- Buzzer
- Smart Filter
- Wind Jet Dry
- Color: Dark Grey



P8535SKMZ 8.5 kg

- Roller Jet Pulsator + Soak
- 5-Year Motor Warranty
- Rat Away
- Buzzer
- Magic Wheels
- Dual Magic Filter
- Wind Jet Dry
- Color: Middle Black



P8535SLMZ 8.5 kg

- Roller Jet Pulsator + Soak
- 5-Year Motor Warranty
- Rat Away
- Buzzer
- Magic Wheels
- Dual Magic Filter
- Wind Jet Dry
- Color: Full Black



P8535SDAZ 8.5 kg

- Roller Jet Pulsator + Soak
- 5-Year Motor Warranty
- Rat Away
- Buzzer
- Wind Jet Dry
- Color: Full Burgundy



P8525SGAZ 8.5 kg

- Roller Jet Pulsator + Soak
- 5-Year Motor Warranty
- Rat Away
- Buzzer
- Wind Jet Dry
- Color: Dark Grey



P8530SRAZ 8.5 kg

- Roller Jet Pulsator + Soak
- 5-Year Motor Warranty
- Rat Away
- Buzzer
- Wind Jet Dry
- Color: Burgundy



P8015SKAZ 8 kg

- Roller Jet Pulsator + Soak
- 5-Year Motor Warranty
- Rat Away
- Buzzer
- Wind Jet Dry
- Color: Middle Black



P8035SRAZ 8 kg

- Roller Jet Pulsator + Soak
- 5-Year Motor Warranty
- Rat Away
- Buzzer
- Wind Jet Dry
- Color: Burgundy



P8030SRAZ 8 kg

- Roller Jet Pulsator + Soak
- 5-Year Motor Warranty
- Rat Away
- Buzzer
- Wind Jet Dry
- Color: Burgundy





NEW

P8015SBAZ 8 kg

- Roller Jet Pulsator + Soak
- 5-Year Motor Warranty
- Rat Away
- Buzzer
- Wind Jet Dry
- Color: Full Blue



P8015SGAZ 8 kg

- Roller Jet Pulsator + Soak
- 5-Year Motor Warranty
- Rat Away
- Buzzer
- Wind Jet Dry
- Color: Dark Grey



P7510RRAZ 7.5 kg

- Roller Jet Pulsator
- 5-Year Motor Warranty
- Rat Away
- Buzzer
- Wind Jet Dry
- Color: Burgundy



P7510RGAZ 7.5 kg

- Roller Jet Pulsator
- 5-Year Motor Warranty
- Rat Away
- Buzzer
- Wind Jet Dry
- Color: Dark Grey



P7510RBAZ 7.5 kg

- Roller Jet Pulsator
- 5-Year Motor Warranty
- Rat Away
- Color: Dark Blue



P7020NGAZ 7 kg

- Normal Jet
- 5-Year Motor Warranty
- Rat Away
- Buzzer
- Wind Jet Dry
- Color: Dark Grey



P7010NBAZ 7 kg

- Normal Jet Pulsator
- 5-Year Motor Warranty
- Rat Away
- Color: Dark Blue



P6001RGZ 6 kg

- Opaque Top
- Roller Jet Pulsator
- 3 Wash Program
- 5 Star Rating
- Color: Dark Grey



THE NEW LG DRYER

A DELIGHTFUL SURPRISE

Powered by **DUAL**Inverter HeatPump™



DUAL Inverter Heat Pump™

Dual inverters, along with two compression chambers, help you dry faster and save more energy.

A+++ - **10%** Energy Efficiency by
DUAL INVERTER HEAT PUMP™

DUAL 10 YEAR WARRANTY
- Inverter Compressor 10Y Warranty
- Inverter Motor 10Y Warranty

99.9%* Bacteria & House Dust Mites Reduced by
ALLERGY CARE



LG ThinQ™





HYGIENIC CARE

Removes 99.9%* Bacteria & House Dust Mites

Eliminates up to 99.9%* of allergens and sterilizes bacteria.



Proven to Reduce Household Dust Mites & Bacteria

LG Dryer has been tested with BAF standards and has been proven to reduce 99.9% house dust mites & bacteria from laundry.



Images/products shown are for illustration purposes only. Actual product may vary due to product enhancement. Features may vary from model to model. All third party logos, trademark and other Intellectual Properties are property of respective brands and LG doesn't hold any rights pursuant to same. *As tested by third party TUV under controlled lab conditions. Actual results & reductions may vary as per use environment. For more details, visit www.lg.com

Plug and Play

LG Dryer is a no-fuss machine that can be plugged anywhere and works like a charm. Since water gets collected in its inbuilt chamber tray, no water residue is released from the dryer, making it fit for use in any home space and giving you clean, dry, and hygienic clothes.

Tower Display Stacking

Our 9 kg LG Dryer goes hand-in-hand with the 9 kg LG Front Load Washing Machine to give you a holistic washing experience and more convenience in washing & drying clothes.

9KG DRYER

9KG WASHER



SMART DRYING

Sensor Dry



Detects the moisture of the clothes and sets the drying time automatically.

Reversible Door



Allows you to install the door on either left or right side as per the availability of space.

LG ThinQ™ with Wi-Fi

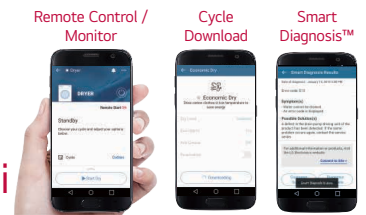

Lets you dry anytime, from anywhere, and helps you download up to 16 drying cycles. While it connects the Washer & Dryer with LG ThinQ™, it also sets the dryer's optimal cycle automatically based on the washer's cycle.

| DUAL Inverter Heat Pump™

Inverter Compressor

LG EcoHybrid dryer uses a unique BLDC compressor which includes a BLDC motor with a specially designed neodymium magnet. Energy efficiency improvement and drying time are enabled through inverter control technology.

Compressor Speed Control

Compressor speed control reduces drying time and saves energy.

Dual Inverter Compressor

The most advanced heat pump technology contributes to saving energy.

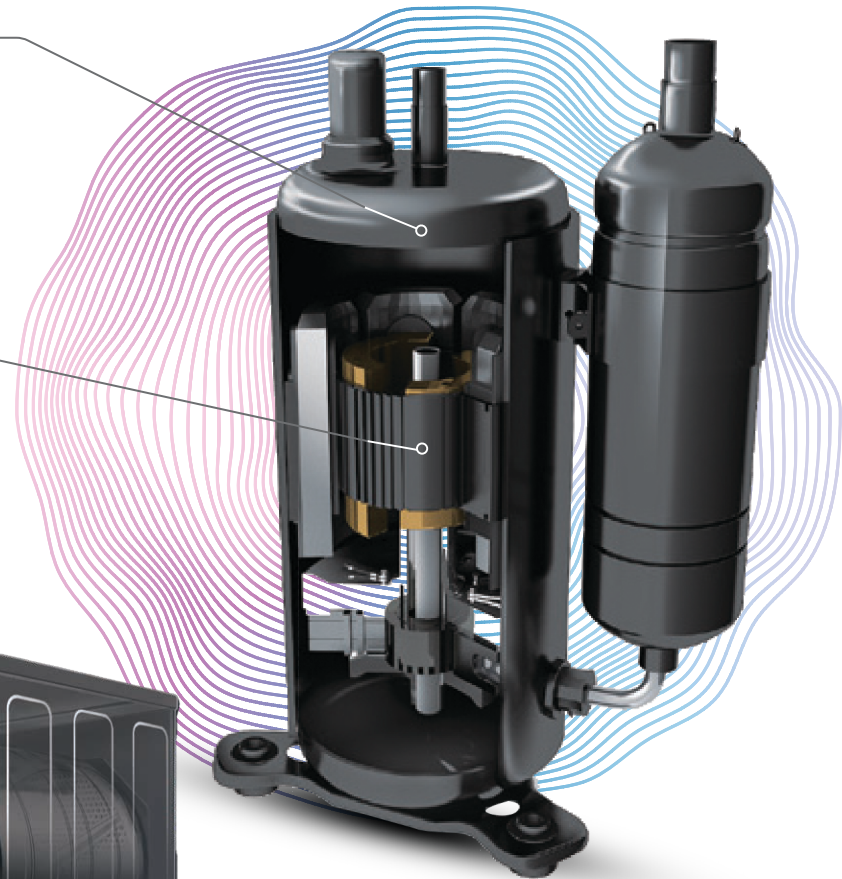
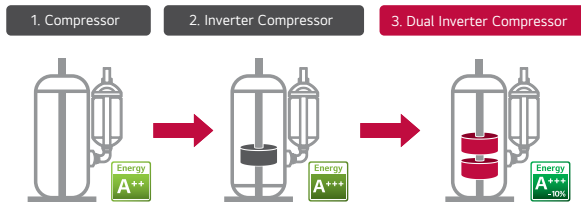

Save Energy, Save Time with EcoHybrid

With LG EcoHybrid, select between energy-saving and time-saving.

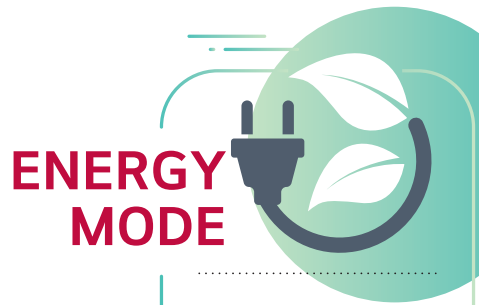

23% Less Energy than Time Mode

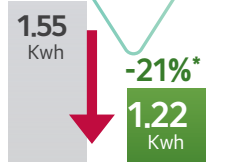

Time Mode Energy Mode



About **16%** Faster than Energy Mode

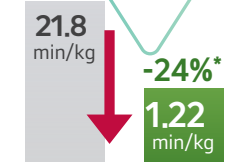

Time Mode Energy Mode

Durable & Reliable with Dual 10-Year Warranty



Dual Inverter Compressor & Inverter Motor

Gentle Care with Low Temperature Drying



Smoothens crease and reduces shrinkage with Low Temperature.

Images/products shown are for illustration purposes only. Actual product may vary due to product enhancement. Features may vary from model to model. All third party logos, trademark and other Intellectual Properties are property of respective brands and LG doesn't hold any rights pursuant to same. *Tested by Interterk, 9kg of IEC standard load, cotton cycle, comparison between Energy and Time Mode. For more details, visit www.lg.com

SPECIFICATIONS



Model Name	DHVO9SWB
Capacity	9Kg
Color	Black Steel
Door	Tempered Glass+Chrome
Dryer Type	Heat Pump Drying
Drum	Stainless Drum
Programs	14
Technology	Dual Inverter Heat Pump™
Auto Cleaning Condenser	Yes
LG ThinQ™	Yes
Smart Pairing	Yes
EcoHybrid	Yes
Allergy Care	Yes
Download Cycle	Yes
Warranty	2 Year on Product & 10 Year on Compressor
Dimension (WxDxH) mm	600x690x850



LG BEST Care

LG 24 x 7 CUSTOMER CARE



08069379999

www.lg.com/in/support



LG WhatsApp No.
9711709999



LG Service India Mobile App
Available at **Google Play**



www.facebook.com/lgindiapage/



www.twitter.com/LGIndia

To know more about LG,
visit www.lg.com/in
For Corporate/Institutional enquiries,
please write to corp.enquiries@lge.com

