





* All images in this datasheet are for illustrative purposes only

Interactive Digital Board TR3DK Series

A New Level of Classroom with **LG CreateBoard**



 Genuine Touch & Writing Experience

 Easy Connection & Sharing

 Security & Compatibility

 User Friendly Experience

 Remote-control Services

TR3DK Series

Display	Screen Size	218.44cm (86) / 190.5cm (75) / 165.1cm (65) / 139.7cm (55)
	Native Resolution	3,840 × 2,160 (UHD)
Touch	Brightness	440 nit
	Multi-Touch Point	Max. 40 Points
Connectivity	Input	HDMI (3, HDCP2.2), RGB (1, VGA), Audio (1), RS-232C (1), RJ45(1, LAN), USB3.0 Type A (4), USB2.0 Type A (1), USB Type-C (1, USB-PD, DP-Alt)
	Output	HDMI (1), Audio Out (1, Optical 1(SPDIF)), Touch USB (2), RJ45(1, LAN)

CREATIVE WHITEBOARD SOLUTION

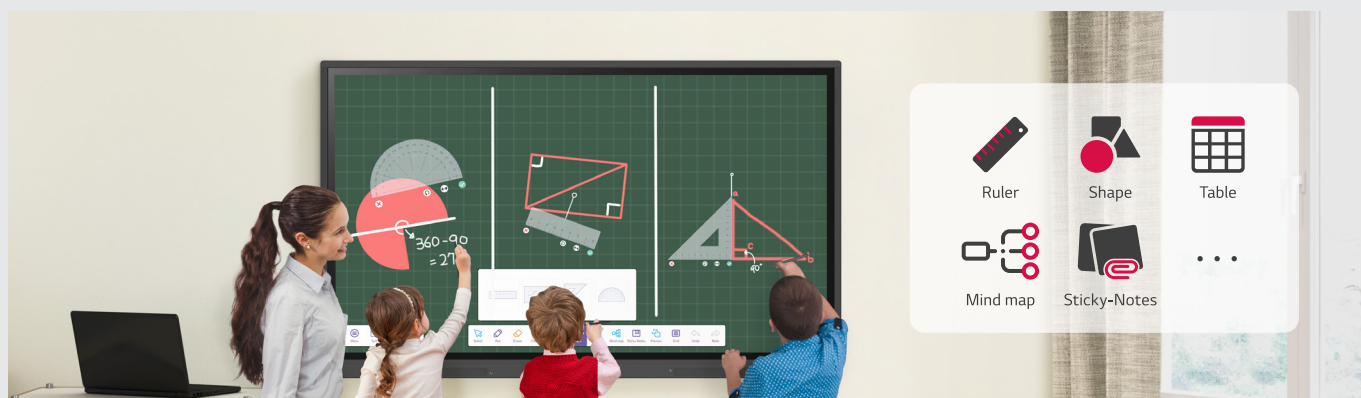

Various Teaching Templates

LG CreateBoard offers a variety of educational templates and teaching tools such as a ruler, table, and sticky notes, allowing for active engagement by students and enabling intuitive classes. Editing images and videos becomes easy with LG CreateBoard, and created resources can be easily shared with others through QR codes.



Multi-touch

LG CreateBoard can simultaneously detect up to 40 points for multi-touch functionality. This creates a lifelike board touch experience, helping students easily become accustomed and truly engage in classes. This leads to the maximum concentration and organic engagement of students.

* A max of 32 points are recognized in the Android environment, and a max of 40 points are detected in the Windows environment.

* Up to 10 points can be recognized in the writing app.

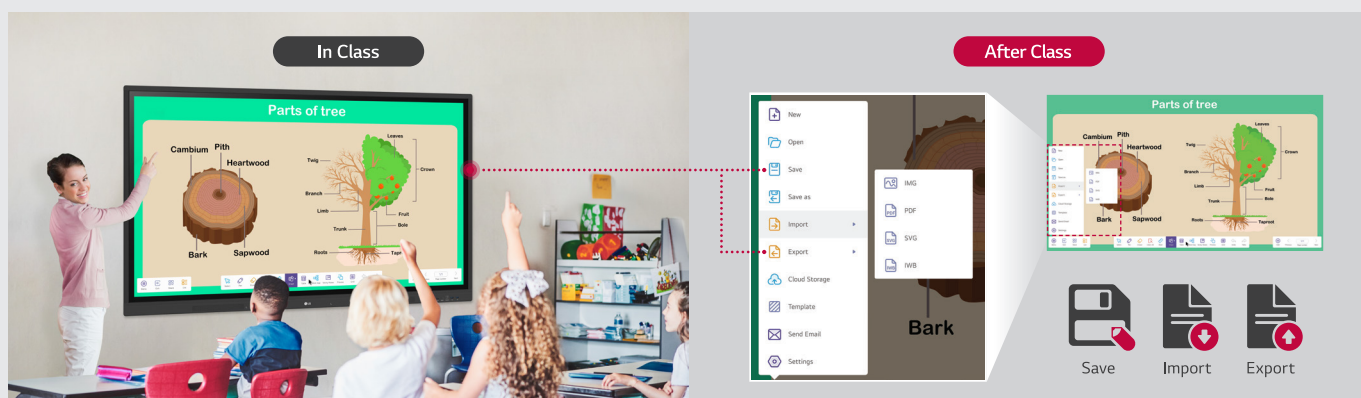

Easy to Save / Import / Export

LG CreateBoard includes simple import and export functionality. Resources can be saved and imported directly to and from Google Drive or OneDrive, and files can be imported from a USB drive (Users can browse resources saved on USB storage).

REMOTE MANAGEMENT SOLUTION

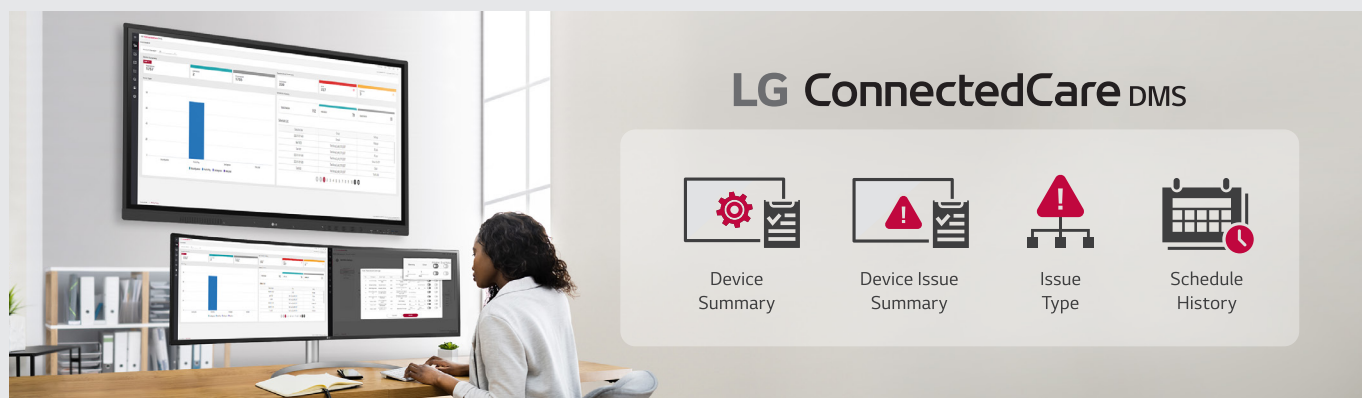

LG ConnectedCare DMS

LG ConnectedCare DMS is a cloud solution for remotely monitoring, controlling, and managing the status of LG CreateBoard installed in educational environments. This feature enables IT managers to operate and manage important resources on operating devices without physically visiting sites.

* 'LG ConnectedCare DMS' needs to be purchased separately.

* The availability of the 'LG ConnectedCare DMS' service differs by region, so please contact the LG sales representative in your region for more details.

* LG ConnectedCare DMS supports the TR3DJ/TR3PJ/TR3DK Series as of now(plus more to come) under a cloud environment.



Remote-control / Scheduling

Frequently used controls such as the power on/off, scheduling, brightness, and screen lock functions can be applied using a remote control.

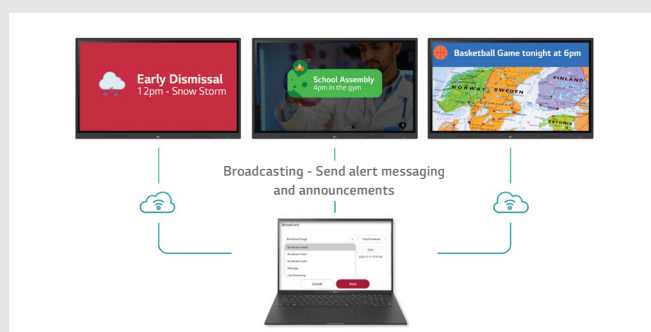

Broadcasting / Alert Messaging

Messages and a range of other content can be sent from the main system to individual classroom devices connected to LG ConnectedCare DMS. In case of urgent occasions such as a fire or a natural disaster, alert messages can be distributed manually across the system, which help teachers and students promptly take safety action.

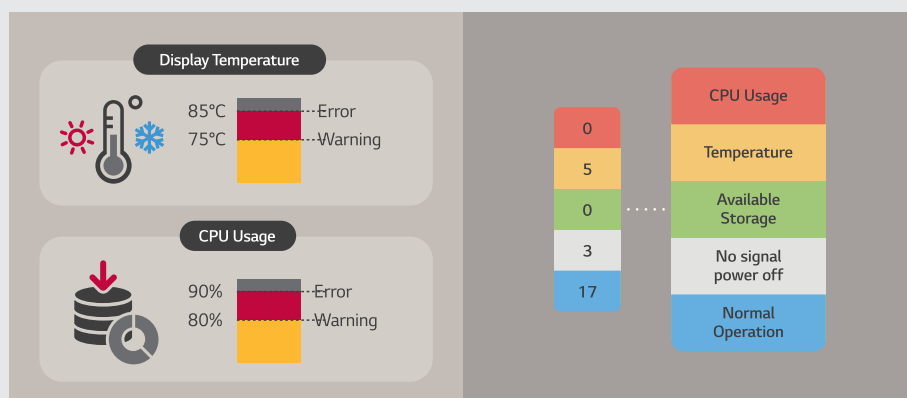

Threshold Settings

Users can set thresholds in eight categories including display temperature, memory usage, or signal, and can receive warning or error notifications based on their threshold settings.

Monitoring & Fault Diagnosis

An engineer can check the status in real-time and diagnose problems remotely. Also, the current status of issues can be categorized, allowing for easy viewing and quick responses.



Issue Management

Remote issue management can be carried out by the LG ConnectedCare DMS solution. This makes management safer and more efficient, facilitating the stable operation of the classroom.

* All images in this datasheet are for illustrative purposes only.

EASY CONNECTION & SHARING

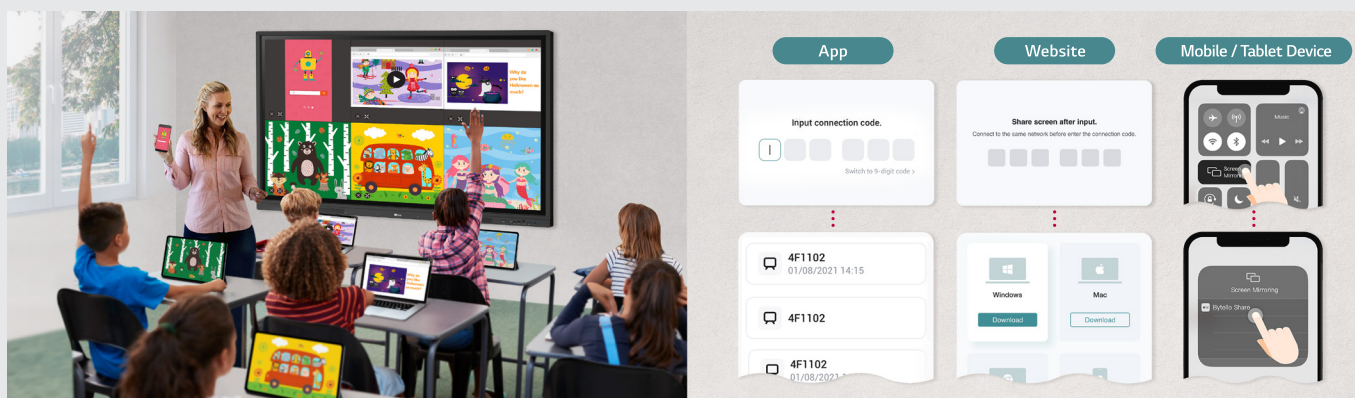

Wireless ScreenShare

LG CreateBoard Share enables users to show up to 9 shared screens or a file on a screen in real-time when the LG CreateBoard Share app is installed on the device. Also, files from the host can be easily sent to any devices connected to the LG CreateBoard Share app, and several quick controls by the host are available.

* LG CreateBoard also supports app-less sharing for PC (via website) and mobile devices within the same network.

* For a more stable connection, we recommend the installation of a dedicated app (LG CreateBoard Share).

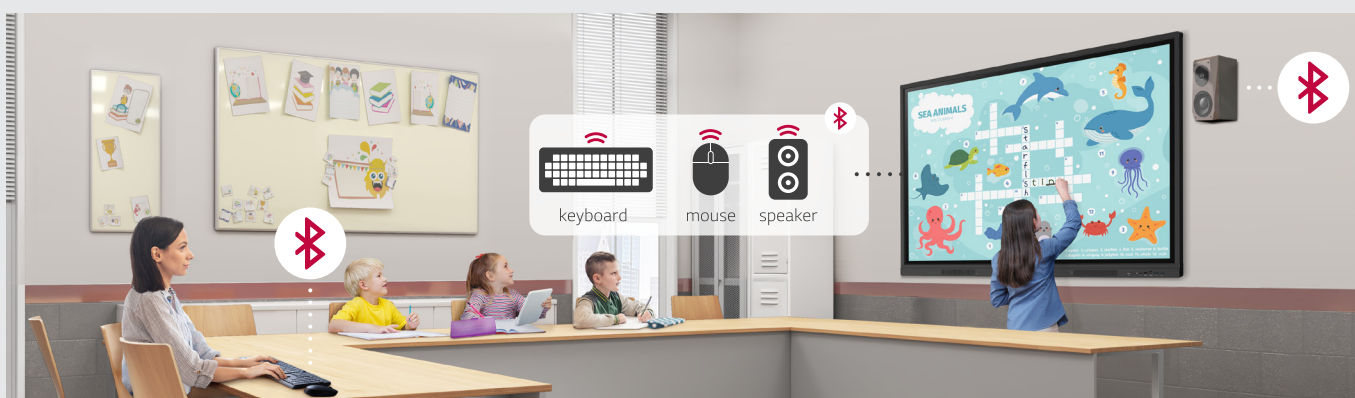

Bluetooth Connectivity

LG CreateBoard supports wireless Bluetooth connections to various devices such as a speaker, mouse, keyboard, etc. This is optimal for building a hybrid environment so that online and offline classes can proceed smoothly.

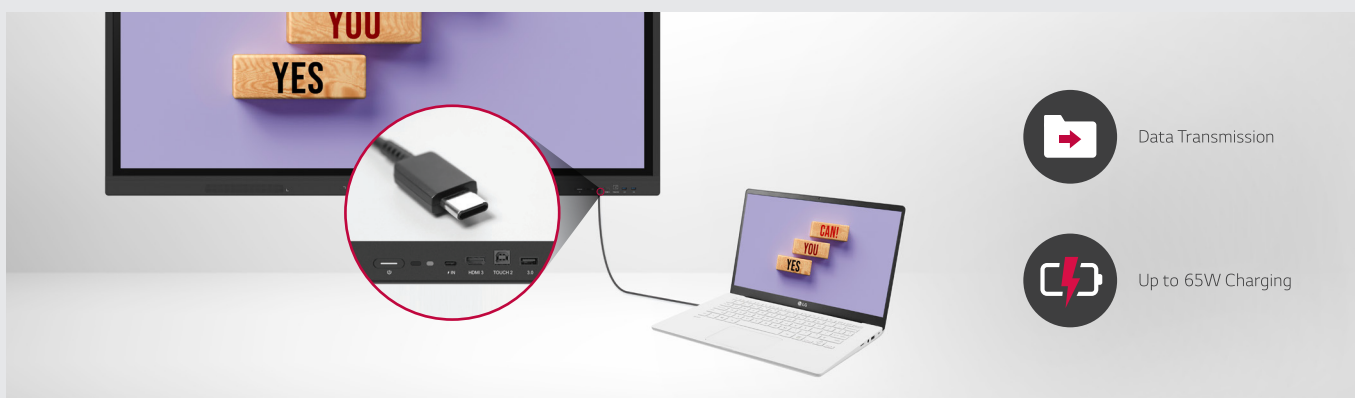

C-type Connection

USB-C connectivity simplifies connections which enables charging and sending data simultaneously over just one single cable.

* USB Type-C cables are sold separately.

* All images in this datasheet are for illustrative purposes only.

OTHER FEATURES

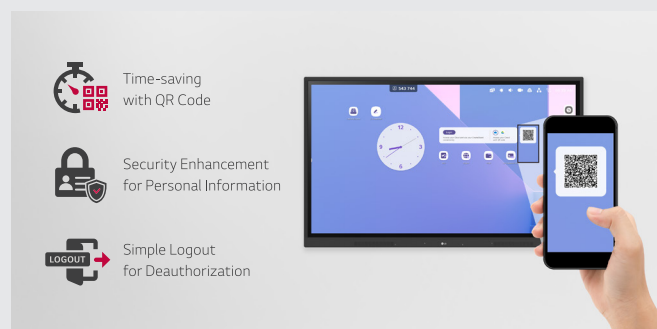

QR Login for Easy Cloud Access

The QR code on the home screen reduces preparation time for class by enabling personal device verification. Users can sign up for a variety of apps on the LG CreateBoard including Google Drive and OneDrive with just one QR verification without any additional login process. Once a lesson is finished, users can simply click the Logout button to disconnect, thus the risk of a personal information leak is reduced.

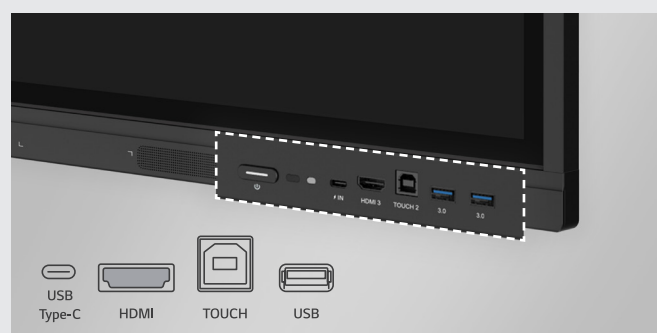

Front Connectivity Design

LG CreateBoard features front display ports and speakers which are ideal for both teachers and students, enabling content to be delivered easier with more immersive sound.



Smart Viewing

The Smart Viewing feature of LG CreateBoard enables efficient teaching. Two or more materials can be displayed on the same screen simultaneously without having to repeat Alt-tab, making teaching more convenient and efficient. Two materials can be displayed side by side (multi window mode), or one material can be overlaid on the other one (picture-in-picture mode).

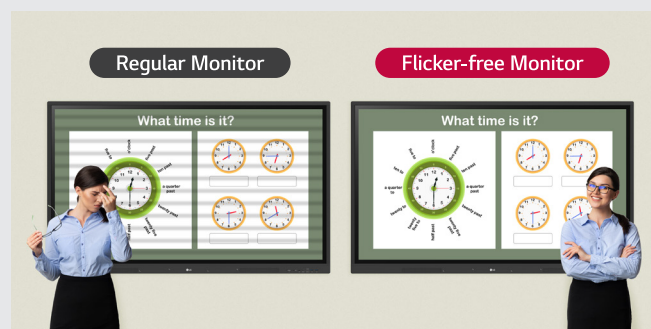

Advanced Eye-Care

LG CreateBoard has introduced a flicker-free function. With the reduced flickering of the monitor's backlight, users can use the device with more comfort even when using it for a long time.

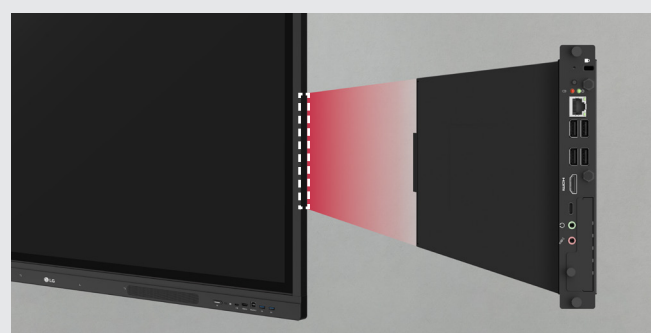

Built-in OPS Slot

LG CreateBoard supports OPS slots, allowing you to easily and conveniently mount OPS desktop at the back of the LG CreateBoard without the hassle of connecting to an external desktop, offering you more expanded functions.

* OPS : Open Pluggable Specification



Power Saving

When a device doesn't receive an external input signal for a specific amount of time set by the user, the device goes into standby mode. Devices can also be automatically turned on or off at specific time or day set by the user, which contributes to save energy.

OTHER FEATURES

SECURE FUNCTION



Screen Lock

Teachers can lock the screen using the Screen Lock function, and unlock it by entering a password. Users can set the Screen Lock in the Settings menu to protect the device from unidentified users.



Secure Mode

LG CreateBoard supports Secure Mode that disables the LG CreateBoard Share function to prevent unauthorized content from being shown on various devices.

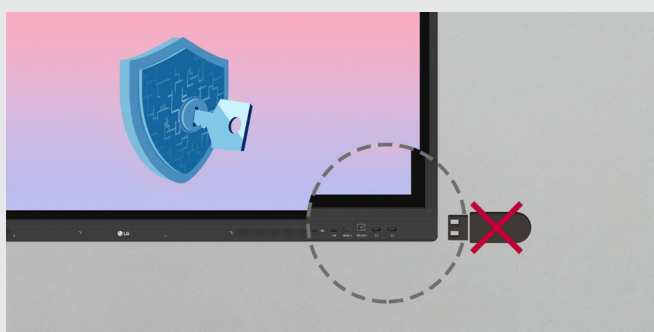

USB Lock Mode

USB Lock Mode is a security measure that helps prevent data from being copied to unauthorized devices, which is essential when being used in spaces where security is critical.



Auto-remove Files

Users can set LG CreateBoard to delete files regularly for enhanced security.

* All images in this datasheet are for illustrative purposes only.

CONNECTIVITY

Front

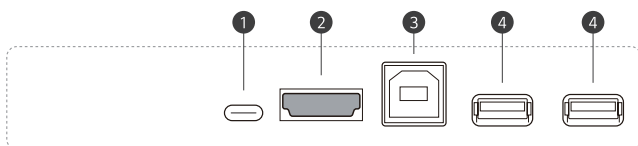

Bottom



Side

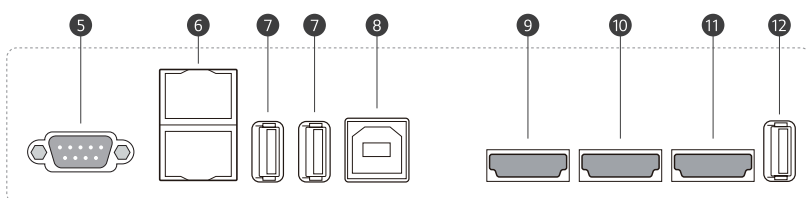

- | | | |
|--------------|-------------|--------------|
| 1 USB Type-C | 7 USB 3.0 | 13 SPDIF |
| 2 HDMI 3 | 8 TOUCH 1 | 14 AUDIO OUT |
| 3 TOUCH 2 | 9 HDMI 1 | 15 AUDIO IN |
| 4 USB 3.0 | 10 HDMI 2 | 16 VGA |
| 5 RS-232C | 11 HDMI OUT | 17 SWITCH |
| 6 LAN | 12 USB 2.0 | 18 POWER |

* Jack Panels may differ from the above image, so please contact LG sales team to verify before ordering.

DIMENSION (unit: mm)

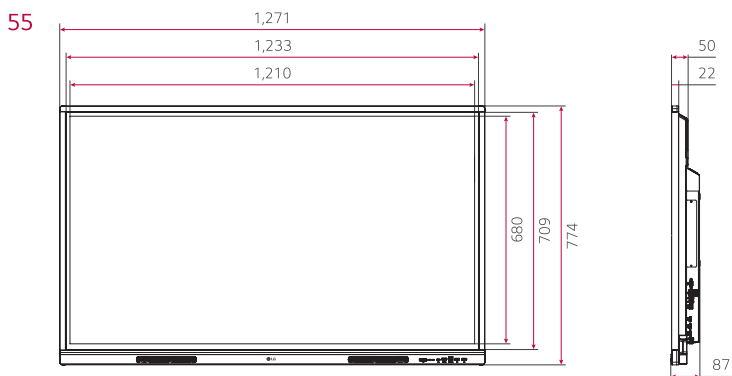
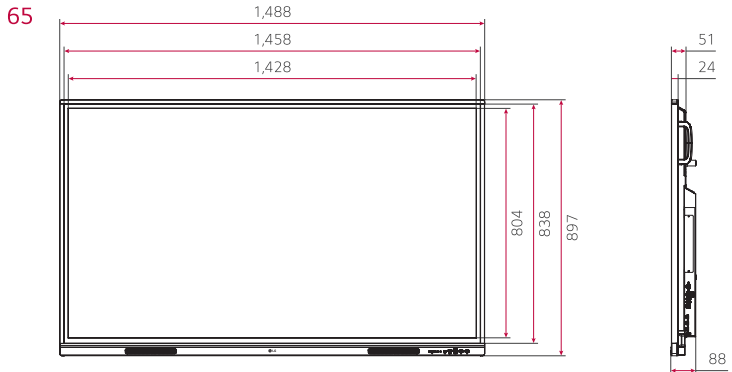
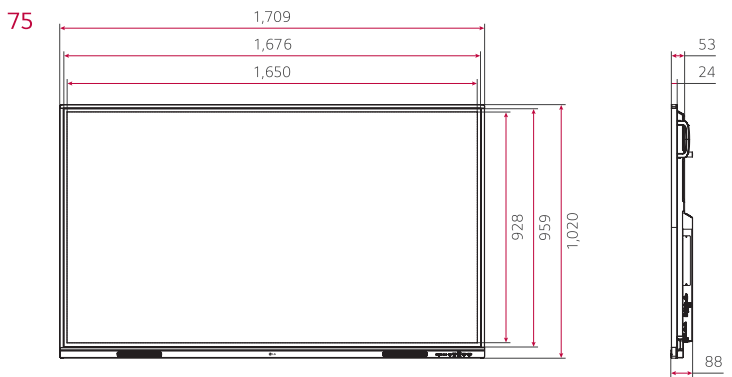
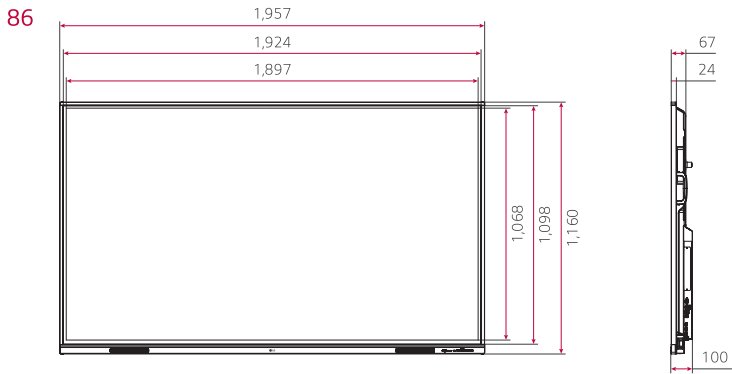

* Dimensions may differ from the above image, so please contact LG sales team to verify before ordering.

SPECIFICATIONS

Model Name		86TR3DK	75TR3DK	65TR3DK	55TR3DK	
PANEL	Screen Size	218.44cm (86)	190.5cm (75)	165.1cm (65)	139.7cm (55)	
	Panel Technology	IPS				
	Back Light Type	Direct				
	Aspect Ratio	16:9				
	Native Resolution	3840x2160 (UHD)				
	Refresh Rate	60Hz				
	Brightness	440 nit				
	Contrast Ratio	1200:1				
	Dynamic CR	5000:1				
	Color gamut	NTSC 68%	NTSC 72%			
	Viewing Angle (H x V)	178°(H/V)				
	Color Depth	1.07B(10bit)				
	Response Time	8ms				
	Surface Treatment (Haze)	Haze 28%	Haze 25%			
	Lifetime	50,000hrs (L30)				
Operation Hours (Hours/Day)	16/7					
Connectivity (Jack Interface)	Input	Digital	HDMI (3) HDCP2.2			
		Analog	(1, VGA)			
		Audio In	(1)			
		RS232C IN	(1)			
		RJ45(LAN)	(1)			
	USB	USB3.0 Type A(4), USB2.0 Type A(1), USB Type-C (1, USB-PD, DP-Alt)				
	Output	Display Out	HDMI Out (1)			
		Audio Out	(1, Optical 1(SPDIF))			
		Touch USB	(2)			
		RJ45(LAN)	(1)			
Mechanical Specification	Bezel Color	Black				
	Bezel Width	T/R/L/B : 15/15/15/44mm	T/R/L/B : 15/15/15/44mm	T/R/L/B : 15/15/15/44mm	T/R/L/B : 18/18/18/45mm	
	Weight(Head)	58.6Kg	47.3Kg	35.0Kg	26.1Kg	
	Packed Weight	75.9Kg	60.6Kg	44.7Kg	34.5Kg	
	Monitor Dimension (W x H x D)	1957*1160*100mm	1709*1020*88mm	1488.4*896.6*87.2mm	1271*774*87mm	
	Carton Dimensions (W x H x D) (Box outer size)	2110*1283*225mm	1863*1140*225mm	1628*1005*208mm	1401*859*220mm	
	Handle	Yes				
	VESA/ATM Standard Mount Interface	800*600mm		600*400mm	400*200mm	
Key Feature	HW	Internal Memory	32GB			
		Wi-Fi	Built-in			
		Auto Brightness sensor	Yes			
		Power Indicator	Yes			
		webOS ver.	Android 11.0			
	SW	Background Image	Bootling Logo Image			
		Multi-screen	PIP PBP			
		Screen Share	LG CreateBoard Share			
		Power	Smart Energy Saving Wake on LAN			
			Energy Saving Yes			
Environment Conditions	Operation Temperature	0 - 40 °C				
	Operation Humidity	10 - 90 % RH				
POWER	Power Supply	100-240V~ 50/60Hz 5.5A				
	Power Type	Built-In Power				
Power Consumption	Typ.	385W	225	220	170	
	Max.	580W	430	420	395	
	BTU (British Thermal Unit)	1314 BTU/Hr(Typ.), 1979 BTU/Hr(Max)	768 BTU/Hr(Typ.), 1467 BTU/Hr(Max)	751 BTU/Hr(Typ.), 1433 BTU/Hr(Max)	580 BTU/Hr(Typ.), 1348 BTU/Hr(Max)	
	DPM	≤0.5W				
	Power off	≤0.5W				
SOUND	Speaker	15W x 2				
CERTIFICATION	Safety	CB / NRTL				
	EMC	FCC Class "A" / CE / KC				
OPS Compatibility	OPS type compatible	Slot type				
	OPS Power built in	Yes				
Language	LG ConnectedCare	Yes				
	LG ConnectedCare DMS	DMS (paid License)				
Accessory	OSD	English, Denmark, Finnish, German, Korean, Norwegian, Polski, Portugues(Europe), Portugues(Brazil), Romanian, Spanish, Swedish, Hungarian, Thai				
Touch	Basic	Power Cord 3 M*1, USB Cable (Type A-Type B) 5 M*1, HDMI Cable 3 M*1, Writing Pen*2pcs, User Manual, QSG, Remote Controller (include battery 2ea), Wifi module				
	Reponse Time	≤5ms				
	Accuracy	±1mm				
	Interface	USB2.0				
	Protection Glass Thickness	Toughened glass with 9H level 7 Mohs standard				
Android System	Operating System Support	Windows 7/8/10/Linux/Mac/Android (Linux/Mac Support one point touch)				
	Multi touch point	Max 40 points				
	SoC	Quad core A55				
	GPU	Mali G52MP2				
	Internal Memory	Storage	32GB			
	RAM	4GB				
	Wi-Fi	802.11a/b/g/n/ac/ax (WiFi 6)				
	LAN	Gigabit LAN				
	Bluetooth	Bluetooth 5.0				

As a continuing policy of product development at LG Electronics, the design and specifications are subject to change. They may vary from model to model. Colour/shades may vary due to printing restrictions. E&OE.



To know more about LG, visit www.lg.com/in/business
For B2B Solutions/Product enquiries, please write to b2b.solutions@lge.com
For B2B Service, please write to b2bsupport.india@lge.com

