

MULTI V™ 5 PRO

Total Air Solution Provider



LG ELECTRONICS VIETNAM

- Hanoi** 35F, Keangnam Landmark 72, Pham Hung str., Nam Tu Liem Dist. – Tel: 024 3934 5151
- Hochiminh** 10F, Sofic Building, 10 Mai Chi Tho str., Thu Thiem ward, Thu Duc – Tel: 028 3925 6886
- Danang** 9F, Indochina Building, 74 Bach Dang str. – Tel: 0236 3691 307
- Nhatrang** 7F, Nha Trang Building, 42 Le Thanh Phuong str. – Tel: 0258 3813 468
- Halong** Shophouse, Lot D2 -06, Ha Long Marine Plaza, Bai Chay - Tel: 02033900369
- Hotline** 18001503

www.lg.com/vn/business | www.lghvac.vn | www.partner.lge.com



*For continual product development, LG reserves the right to change specifications or designs without notice





* Note
This product uses inverter technology, so it can generate harmonics. If local law or the Investor requires harmonic suppression at the construction site, please coordinate with the electrical design unit to take measures to suppress harmonics. Contact your supplier for more detailed information on the electrical characteristics of LG air conditioners.

<http://partner.lge.com> | <http://www.lg.com/vn/business>



OUTDOOR UNITS LINE-UP

Unit : HP / ● 380V, 3Ø

Features	Appearance	8	10	12	14	16	18	20	22	24	26	28	30	32	
<p>MULTI V™ 5 PRO</p> <ul style="list-style-type: none"> • Dual Sensing Control • Large capacity ODU (Up to 26HP) • Compact footprint & Light Weight • Black Fin heat exchanger • Heat pump function • For large space, high rise building and individual control building 		●	●	●	●										
						●	●	●	●	●	●				
													●	●	●
															
															

34	36	38	40	42	44	46	48	50	52	54	56	58	60	62	64	66	68	70	72	74	76	78	80	82	84	86	88	90	92	94	96	...	104
●	●	●	●	●	●	●	●	●	●	●																							
										●	●	●	●	●	●	●	●	●	●	●	●	●											
																							●	●	●	●	●	●	●	●	●	●	●

MULTI VTM 5 PRO

- Air cooled VRF Heat Pump
- 22.4kW – 291.2kW (Cooling capacity based)
- 3Ø, 380 – 415V, 50Hz
- Top discharge outdoor unit

1,000M
TOTAL PIPING LENG

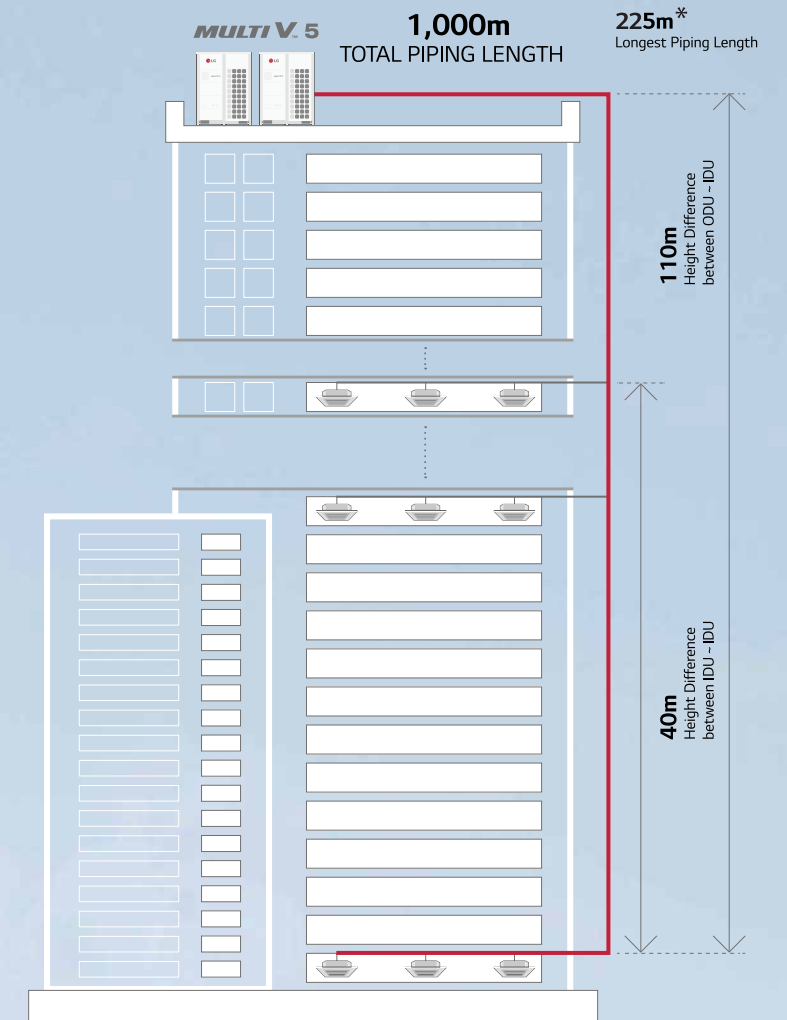

Design
For
The Ultimate



Energy savings



Reliability



Low noise



Advanced performance

How does it work?

Dual Sensing



* To apply conditional application

AS A TOTAL HVAC & ENERGY SOLUTION PROVIDER

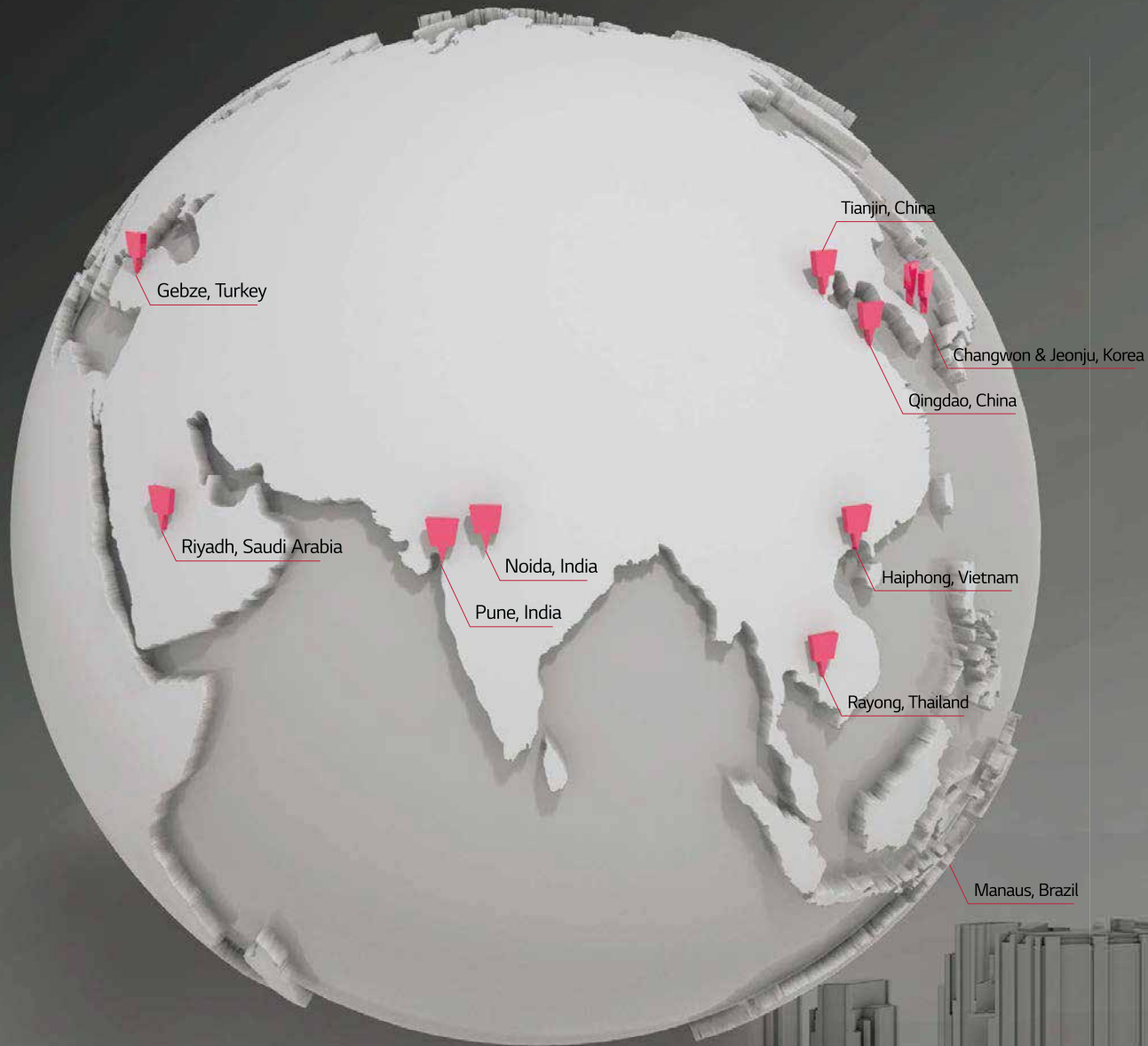

* LG Air Solution production sites

The LG Electronics Air Solution Business Unit is a provider of total HVAC and energy solution. The company offers a broad portfolio of air conditioner products that are compatible with any building anywhere, including compact residences, towering skyscrapers, massive factories and giant concert halls. As a true total HVAC and energy solution provider, LG also supplies even the largest buildings and industrial facilities with central air conditioning systems such as chillers and efficient control solutions.

The history of the business unit goes back to 1968, when LG (then called GoldStar) rolled out Korea's first residential air conditioner. As the company first began making chillers for large commercial buildings in 1970, the commercial air conditioning business has grown

exponentially, especially within the last 20 years. In 2008, LG sold its 100 millionth air conditioning unit, becoming the first company in the industry to reach that significant milestone. The success of LG air conditioners has allowed the company to become one of the major players in the highly competitive HVAC industry. By enhancing the industry's B2B infrastructure and finding further solutions for the HVAC sector, LG has risen to become a total HVAC solutions specialist. The company has steadily increased its sales and market share by introducing energy efficient and reliable HVAC solutions and actively pursuing new opportunities wherever they arise. This sustained, excellent performance is built on a solid foundation of global R&D and advanced manufacturing capabilities.

HVAC TOOL & SUPPORT

From planning to service & maintenance and then to de-construction, an architectural project goes along many stages from the beginning to the end of its lifecycle. Along those stages, various engineering tools are applied to solve the diverse issues happening in each stage, with the most optimal solution possible. Due to the usage of such tools, buildings are effectively designed, built, supervised, and maintained throughout the lifecycle.

Dedicated to provide the best HVAC engineering support, LG Electronics Air-Solution Business Unit offers several engineering tools and solutions focused on HVAC, during the overall lifecycle of a building, related to the three categories: I. Draft Energy Estimation & Energy Modeling, II. Model Selection & Design, and III. Installation Environment Simulation. Among them, the LATS* Program series has been developed to offer the best and the most optimized tool for LG HVAC systems, providing our customers a faster, easier, and a more accurate way in everyday duties of Model-selection, Draft Energy Estimation & Designing, and many more.

* LATS : LG Air-conditioner Technical Solution



I
Energy Estimation
& Energy Modeling



II
Model Selection
& Design



III
Installation
Environment
Simulation

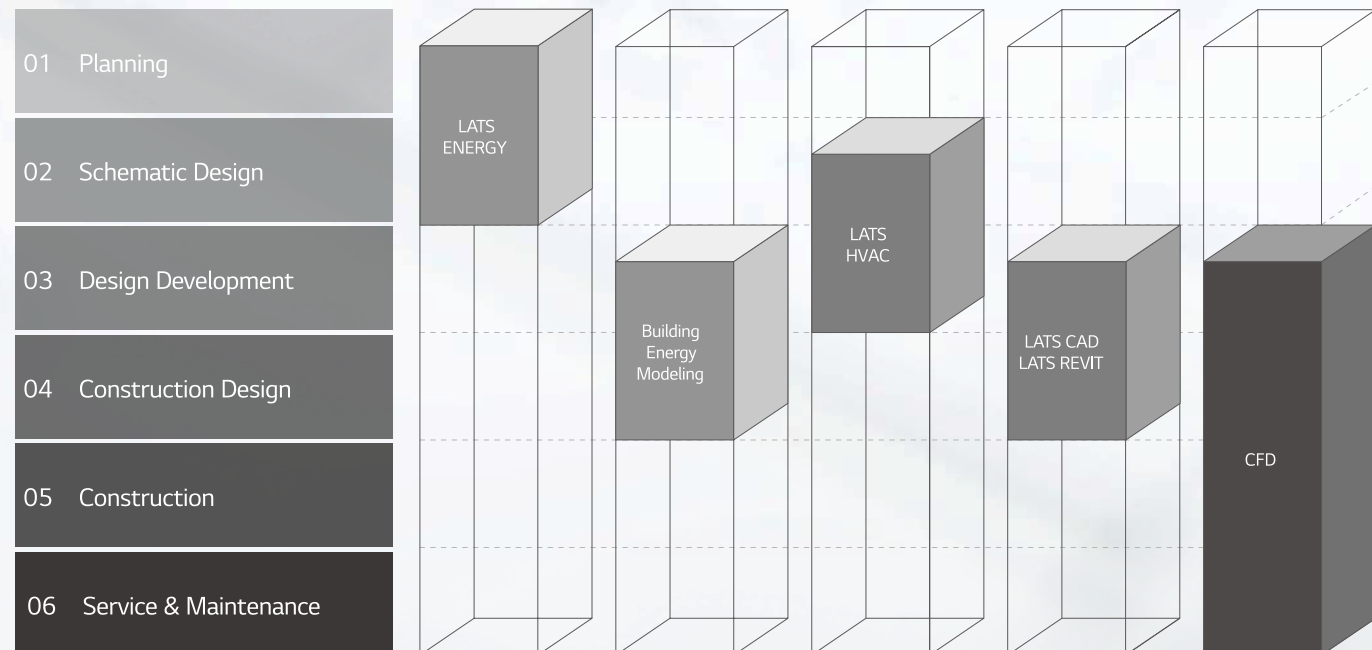

01 Draft Energy Estimation

LATS Energy

LATS Energy program is a draft energy estimation program, self-developed by LG. This program helps estimate the draft energy usage and analyzes the life cycle cost of LG VRF models during the early stage of a project.



02 Building Energy Modeling

eQuest, EnergyPro, Trace700 and More

These are certified commercial programs which assess the HVAC system efficiency and building's annual energy saving for building standard or certification like LEED. LG HQ supports these programs for the project stages of Design Development and Construction Design wherein the overall designing is finished.

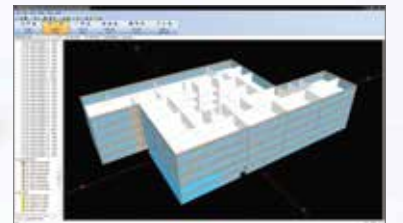

03 Model Selection

LATS HVAC

LATS HVAC is an integrated model selection program of LG HVAC products, enabling an accurate and quick selection on the best model suitable to each sites. In addition to model selection, faster estimation on refrigerant piping diameter and additional refrigerant is possible, along with auto printing of reports.



04 Design

LATS CAD

LATS CAD enables faster and a more accurate design of LG HVAC products. Moreover, it offers not only designing, but also quotation and installation review in order to minimize problems during installation processes.

LATS Revit

LATS REVIT is developed to make 3D designing of LG HVAC products easier than the previous program. It enables engineers to check 3D images from designing stage and prevents possible issues of the installation stage.

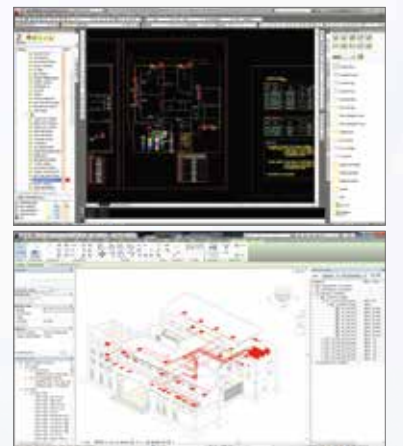

05 Installation Environment Simulation

CFD Analysis

CFD Analysis is applied in areas of estimating: indoor airflow and temperature distribution while operating VRF products, outdoor airflow distribution, and noise level. By running a simulation before construction, engineers estimate possible issues and find optimal solutions of malfunction that could occur after construction.

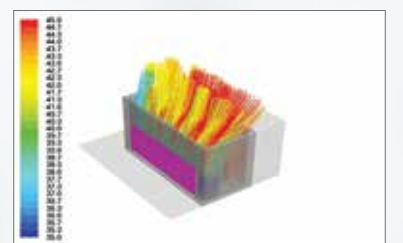

LG CONTROL SOLUTION

MULTI V 5 PRO offers diverse range of effective control solutions that satisfy specific needs of each building and its user scene. These controlling systems are equipped with user friendly interface, flexible interlocking environment, energy management and smart individual controller for optimized controlling conditions and smart building management.

HOTEL
Hotel Room Solution



Key tag

OFFICE

Central Control Solution



3rd Party BMS

Service / Maintenance

· Energy Management

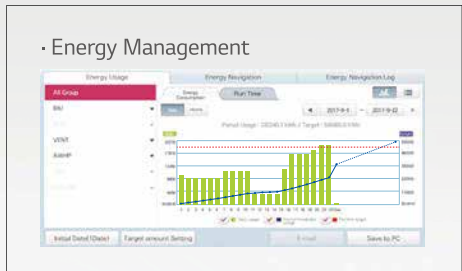

· External Device

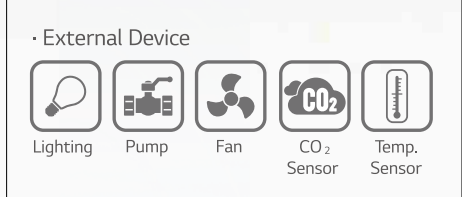

92kW

20kW

50kW

Integration Solution



SHOPPING MALL
Power Distribution Solution



RESIDENTIAL
Smart Individual Control Solution



SMALL BUILDING
Small Central Control Solution



DUAL SENSING CONTROL

The cooling load is mainly based on the amount of both sensible heat load and latent heat load. Most importantly, the cooling load is keen to, and thus, greatly affected by external humidity, rather than the outdoor temperature. For such reason, Dual Sensing Control of MULTI V 5 PRO senses both temperature and humidity and applies sensed data for load latent heat load. This helps preventing excessive cooling load supply and eventually offers the most pleasant and comfortable cooling environment the users want with reduction in energy consumption.



MULTI VTM 5 PRO
: Dual Sensing



COMFORT

Dual Sensing Control Dry Summer

Dual Sensing SLC is a function that changes evaporation temperature according to temperature & humidity.

MULTI V IV PRO

- Single sensing Smart Load Control (Temperature only)
- Excessive latent heat elimination regardless of humidity
- Waste Energy to eliminate latent heat

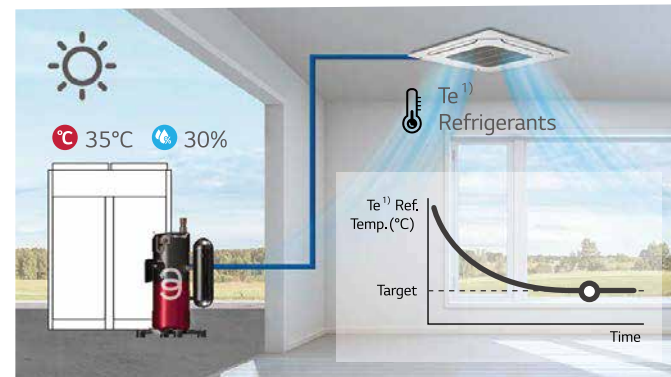

* 1) Te : Evaporation Temperature
* Dual Sensing Control requires Standard III Wired Remote Controller (option).

MULTI V 5 PRO

- Comfortable environment by making the room less dry
- Increased Seasonal Efficiency

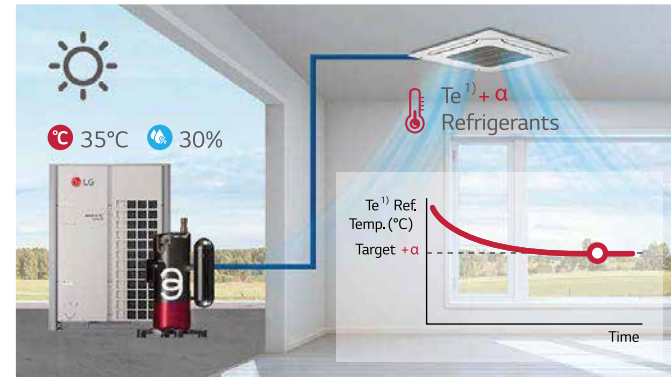

Dual Sensing Control Wet Summer

In wet summer season, the system senses the high humidity level and increases operating ratio to decrease humidity level rapidly for making room condition in comfort zone.

MULTI V IV PRO

- High humidity condition is not considered by only sensing the room temperature.
- General latent heat elimination regardless of humidity

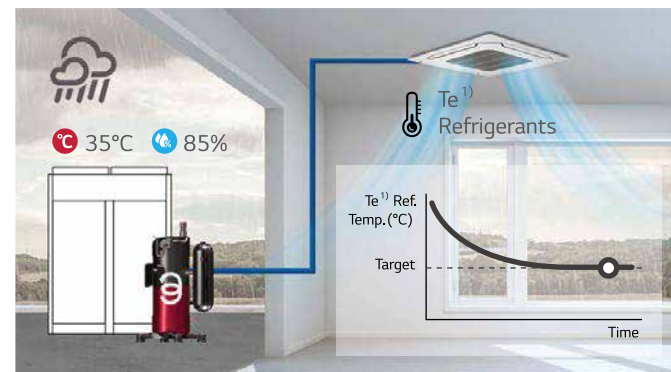

* 1) Te : Evaporation Temperature
* Dual Sensing Control requires Standard III Wired Remote Controller (option).

MULTI V 5 PRO

- Comfortable environment
- With quick latent heat elimination by sensing humidity
- At higher humidity, the compressor runs more powerfully

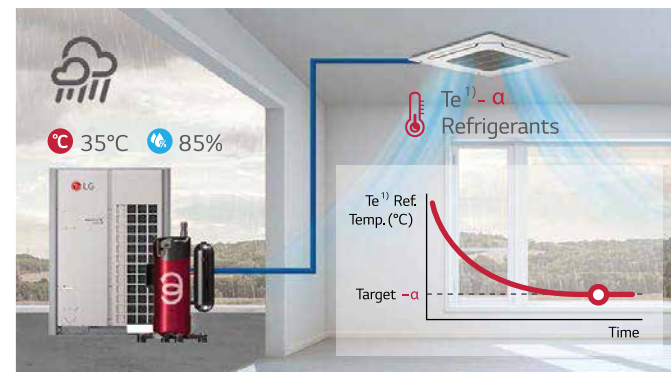

Dual Sensing Control with Temperature & Humidity Sensor

MULTI V 5 PRO can provide better comfort environment and save energy by referring indoor humidity level. MULTI V 5 PRO can be operated by dual sensors for comfort and effective operation. (Temperature & Humidity)



Comfort Cooling

Without stopping in between operations, this function allows MULTI V 5 PRO to maintain operation at mild cooling mode around the set temperature by sensing both temperature and humidity with Dual Sensing Control. By preventing both cold draft and repeated turn on/off's previously required to match the set temperature, users can experience more comfortable indoor environment.



Cooling operation comparison

- Conventional vs. MULTI V 5 PRO

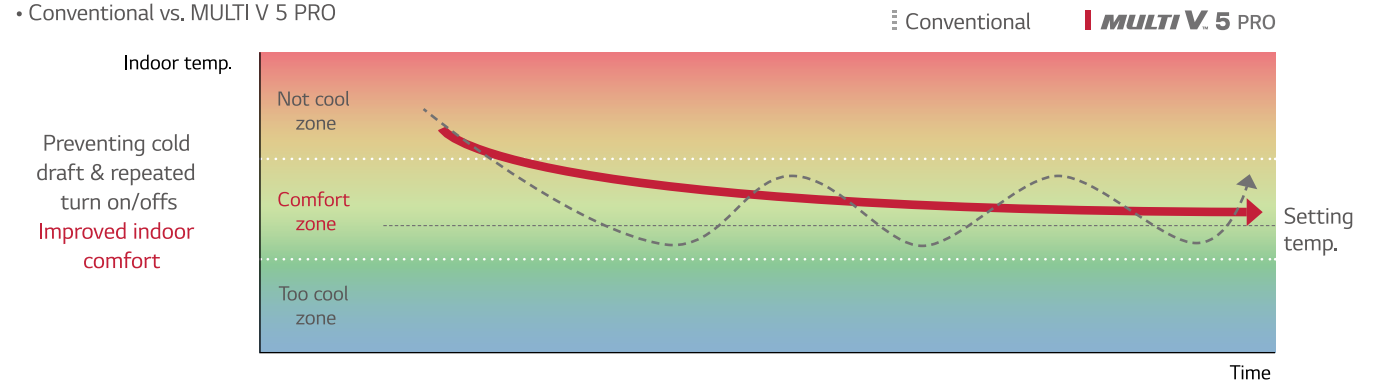

Energy Saving

With comfort cooling feature, target superheat of indoor unit is increased while refrigerant flow rate is decreased. Moreover, thermo-on time has been increased from Conventional 47 minutes to 120 minutes or longer. Since there is no repeating of thermo on/off, average electric power is saved up to 2%.

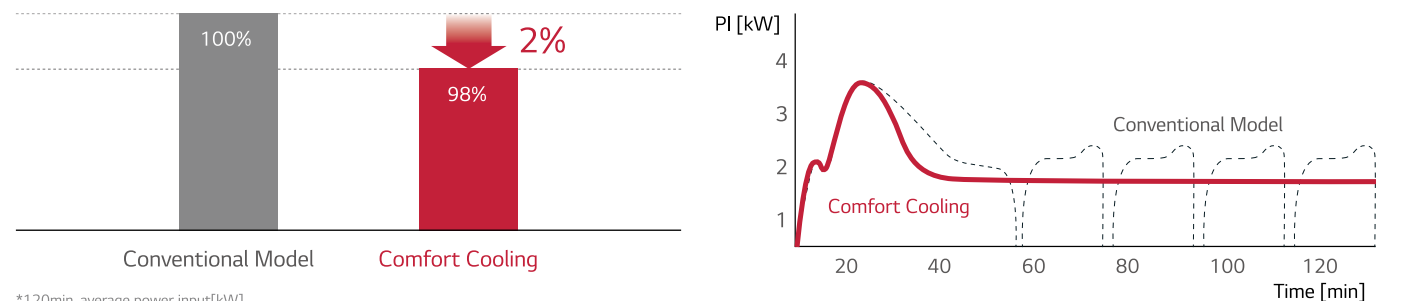

*120min. average power input[kW]

LARGE CAPACITY OUTDOOR UNIT



FOOT PRINT AREA **30%¹⁾** REDUCTION
PRODUCT WEIGHT **32%¹⁾** REDUCTION

1) Based on 26 HP, Compare with MULTI V IV PRO



Large Capacity Outdoor Unit

Enhanced core parts like biomimetics technology-based fans, 4-sided heat exchanger as opposed to 3-sided heat exchanger of previous model and compressor with increased efficiency and capacity allow large capacity for outdoor units. A single unit of MULTI V 5 PRO can provide up to 26HP.

As a result of the biomimetics technology invented through years of joint study with Department of Mechanical and Aerospace Engineering of Seoul National University, the fan of MULTI V 5 PRO increased wind capacity while it reduced its power consumption when operating.

FLEXIBILITY

Large Capacity Outdoor Unit

Without cooling operation stopping, this function allows MULTI V 5 PRO to maintain operation at mild cooling mode.

Biomimetic Fan

The moire pattern from external texture of clam shells has been applied on fans to create the range difference which results in reduction of noise level. At the same time, unlike the fans installed in previous products that generate separation of flow due to absence of tubercles, the bumpy back design inspired by the bumps on the humpback whale's flipper is applied as the tubercles on the back side of the fans, increasing wind power by reducing flacking.

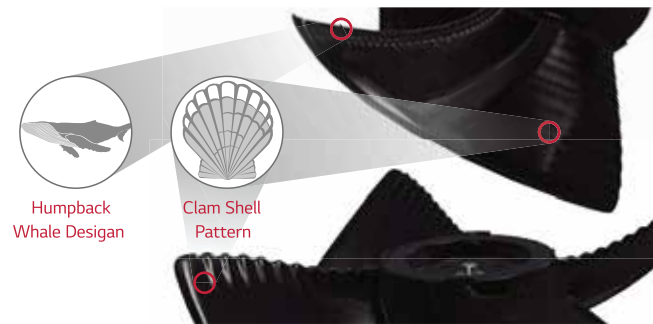

4-sided Heat Exchanger

LG's exclusive Ocean Black Fin is applied on the heat exchanger of MULTI V 5 PRO in order to perform even in corrosive environments. The strong protection from various corrosive external environments such as seaside with high salt contamination and industrial cities with severe air pollution caused by fumes from factories keeps MULTI V 5 PRO operating without breakdown. This improvement in durability prolongs the product's lifespan and lowers both the operational and maintenance costs.

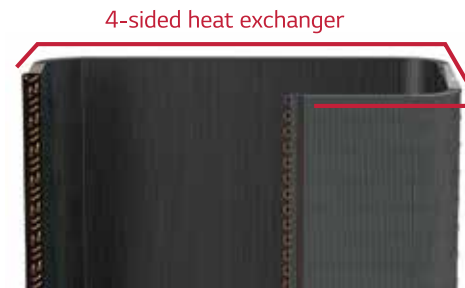

Piping Capabilities

Design flexibility for high rise building is enhanced.

Total piping length	1,000m
Longest pipe equivalent length	175m (225m) ¹⁾
Longest piping length after 1 st branch (Conditional application)	40 (90m) ¹⁾
Height between ODU-IDU	110m
Height between IDU-IDU	40m

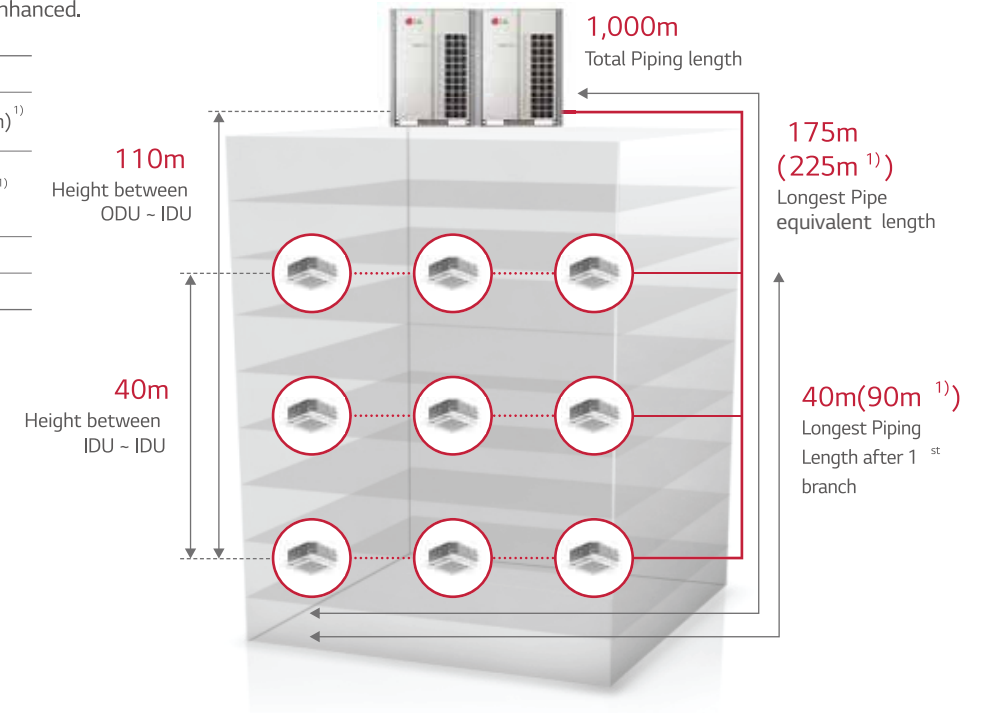

* ODU : Outdoor unit, IDU : Indoor unit
1) To apply conditional application

Flexible Installation Space with Large Capacity Outdoor Units

Large capacity outdoor units of MULTI V 5 PRO minimizes installation space that spares valuable floor space and significantly decreases total installed weights. This allows users the flexible design potential and better use of the saved space.

Installation space area comparison

- Previous Model vs. MULTI V 5 PRO

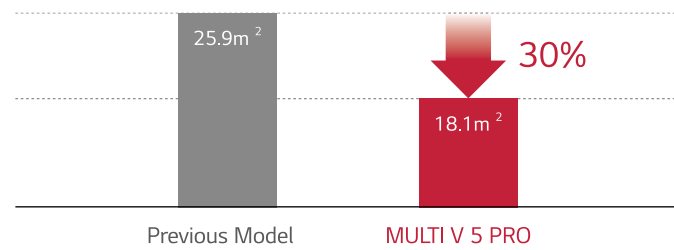

* 156HP(26HP x 6sets) installation case



* Comparison basis: 26HP (MULTI V 5 PRO vs. MULTI V IV PRO)

Comparison on installation space

- Previous Model vs. MULTI V 5 PRO

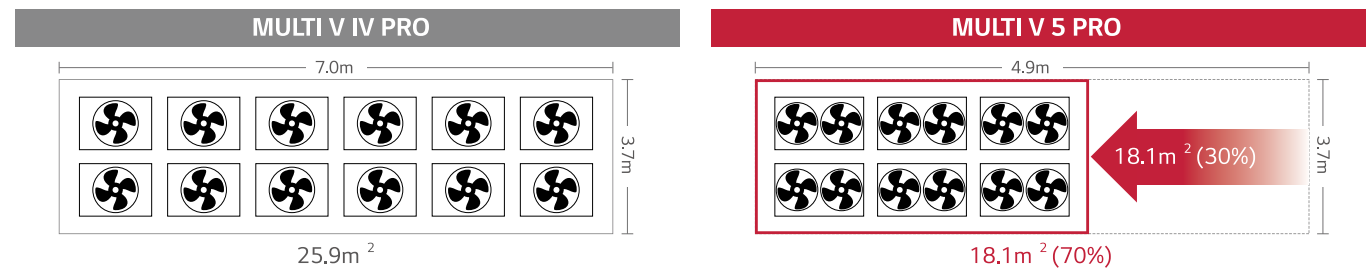

* 156HP(26HP x 6sets) installation case

Light Weight

Large capacity outdoor units of MULTI V 5 PRO significantly decreases total installed weights.

- The weight is 12% reduced than MULTI V IV PRO. (based on 8-26HP average)
- Easy transportation and installation

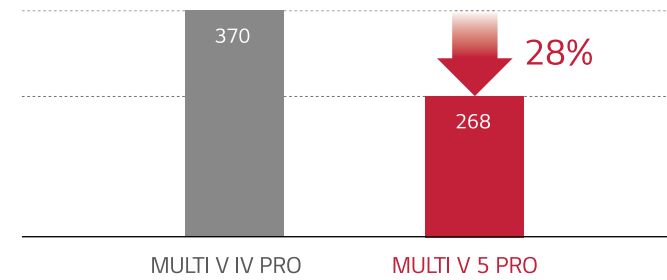

* Based on 26 HP

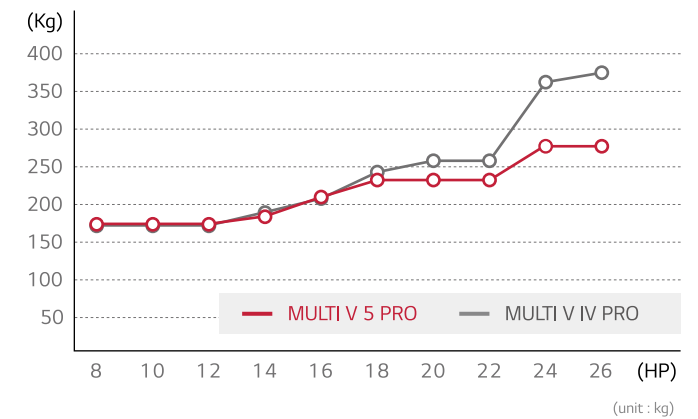

	8	10	12	14	16	18	20	22	24*	26*
MULTI V 5 PRO	167	167	172	184	205	230	230	230	268	268
MULTI V IV PRO	175	175	175	190	205	245	255	255	360	370

* MULTI V 5 PRO is single unit, MULTI V IV PRO is combined unit (2unit)

PERFORMANCE & EFFICIENCY

Powerful Cooling Performance in High Ambient

MULTI V 5 PRO can perform stable cooling operation even when the outdoor air temperature goes up to maximum of 48°C. The supplying cooling capacity is also increased from the previous model, specially when the ambient temperature is as high as 46°C. This powerful cooling capability enables reliable operation even under extremely high temperature conditions.

Increasing cooling capacity

- Previous Model vs. MULTI V 5 PRO

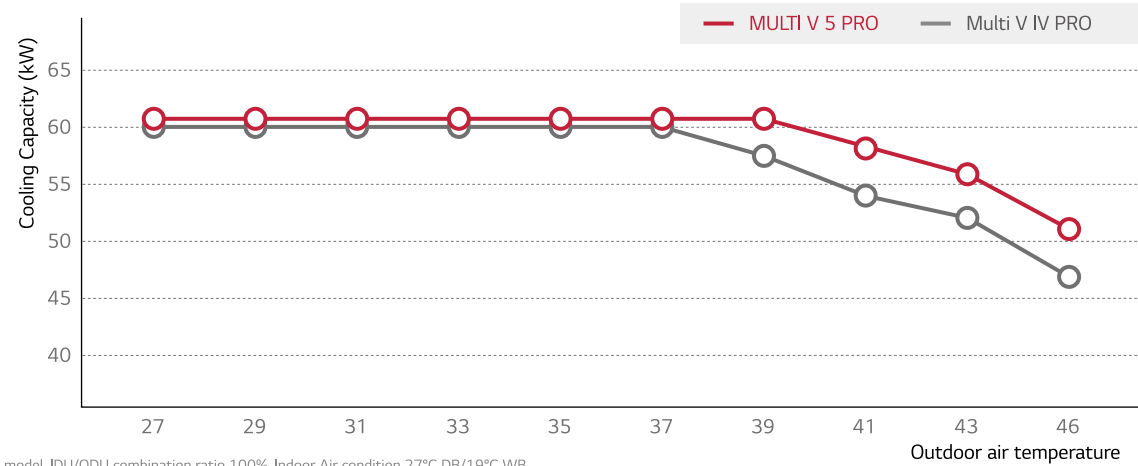

* Based on 22HP model, IDU/ODU combination ratio 100%, Indoor Air condition 27°C DB/19°C WB

Energy Saving from Improved Efficiency

During the morning and night time, outdoor temp. is relatively low and partial load condition is occurred but in the day time, peak cooling load is occurred. MULTI V 5 PRO's cooling efficiency has been improved in every outdoor air temperature condition which is more actual operating condition than previous model (In case of 22HP model, average 24% increased)

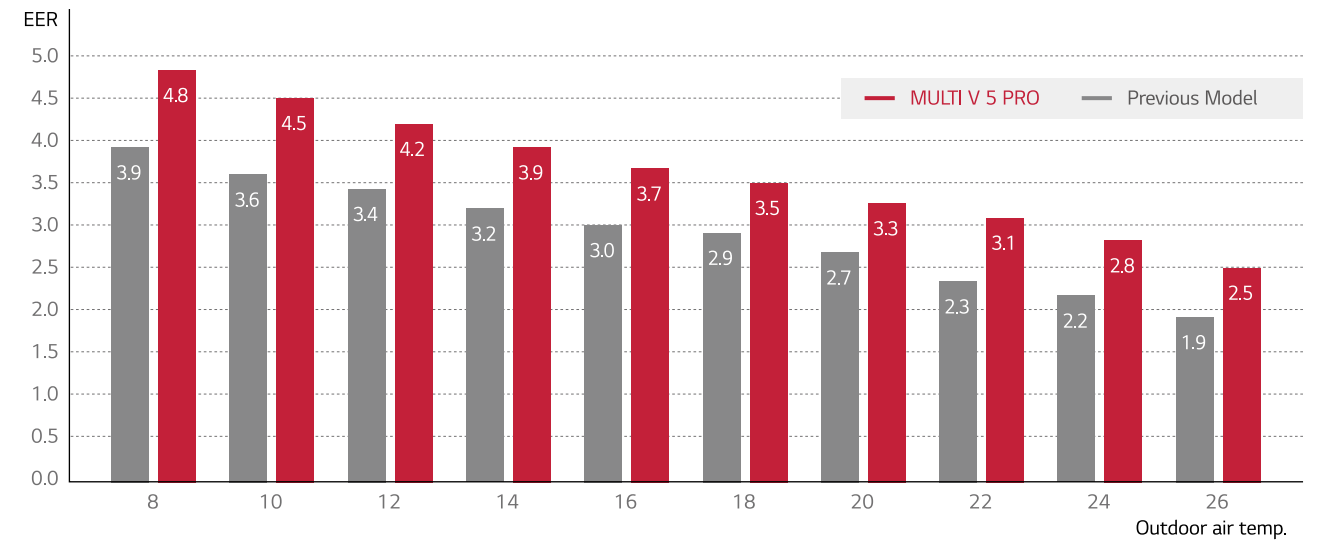

* Based on 22HP model, IDU/ODU combination ratio 100%, indoor Air condition 27°C DB/19°C WB

Cooling Efficiency

MULTI V 5 PRO cooling efficiency improved than MULTI V IV PRO specially in 18~22HP model ranges.

EER (Cooling)

- Cooling efficiency is improved 5% than MULTI V IV PRO. (based on 8~26HP average)

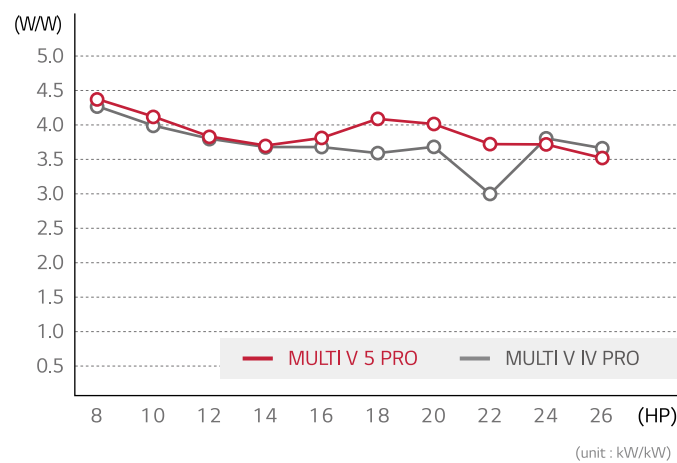
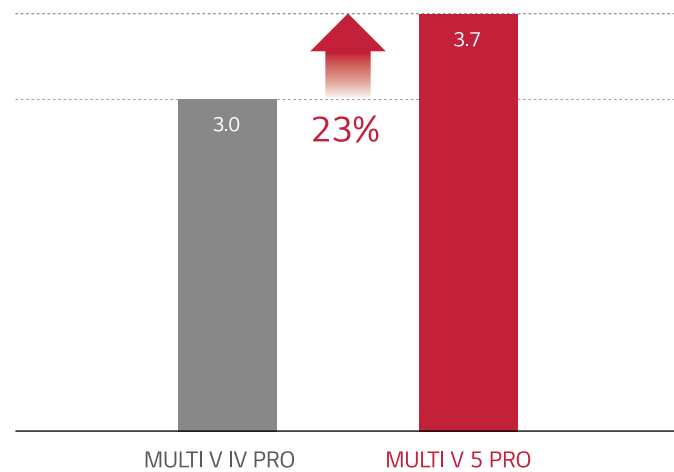

	8	10	12	14	16	18	20	22	24*	26*
MULTI V 5 PRO	4.4	4.1	3.8	3.7	3.8	4.1	4.0	3.7	3.7	3.5
MULTI V IV PRO	4.3	4.0	3.8	3.7	3.7	3.6	3.7	3.0	3.8	3.7

* MULTI V 5 PRO is single unit, MULTI V IV PRO is combined unit (2unit)

* Based on 22HP
 Test Condition
 - Cooling : Indoor 27°C(80.6°F) DB / 19°C(66.2°F) WB, Outdoor 35°C(95°F) DB / 24°C(75.2°F) WB
 - Heating : Indoor 20°C(68°F) DB / 15°C(59°F) WB, Outdoor 7°C(44.6°F) DB / 6°C(42.8°F) WB
 - Piping Length : Interconnected Pipe Length = 7.5m
 - Difference of Elevation (ODU - IDU) is Zero.

Reliable Performance in Extreme Environment

With enhanced inverter compressor and control technology coming from improved supercooling technology installation, MULTI V 5 PRO extended range of cooling operations. MULTI V 5 PRO's cycle technology with enhanced durability enables optimal cooling performance at high temperature that increases up to 48°C.

Wider operational range for each performance

With enhanced inverter compressor and control technology coming from improved inverter

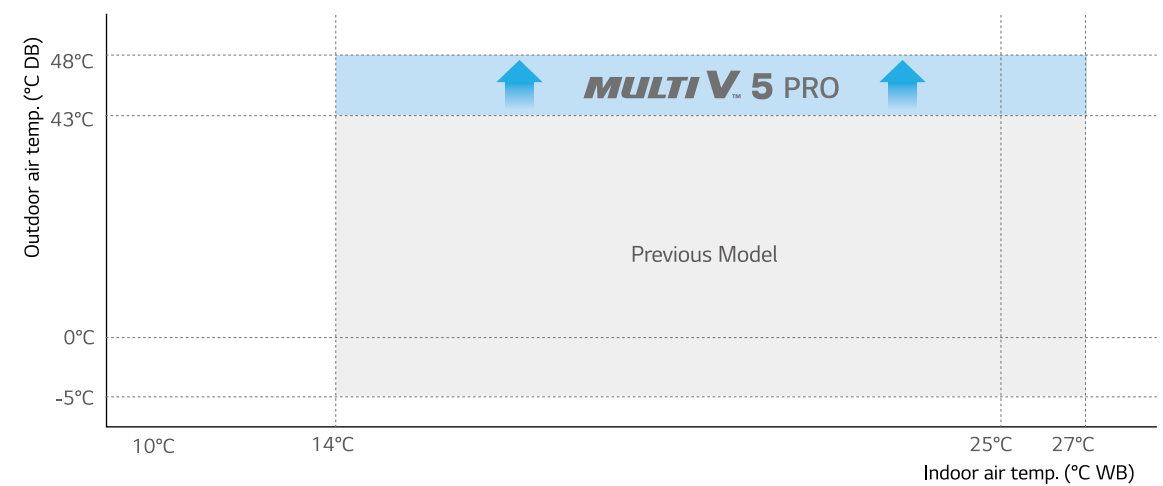

< Cooling >

RELIABILITY

Ultimate Inverter Compressor

Motivated by the lubricative material of PEEK* bearing used for aero engines, the newly invented scroll system with refined shape increases durability and reliability of compressor.

Enhanced Bearing with PEEK* Material

- Improved Efficiency Up to 5% / 10% (Cooling / Heating)
- Noise Level 3dB reduction
- Enhanced low-load operation (min. 10Hz @ 6.8HP Comp)
- Min. 1.1HP (about 35% vs. MULTI V IV PRO)

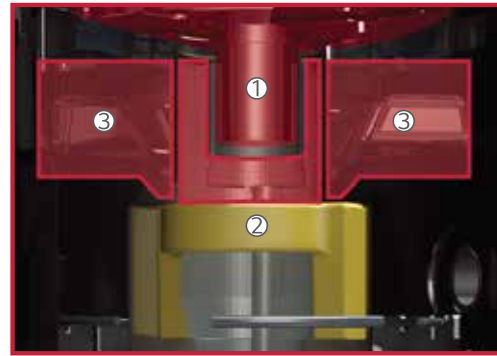

- ① Material : PEEK (Polyetheretherketone)
- ①+② Structure : New Outer Bearing
- ③ Supporter : High speed operation with reduction of bearing load and vibration

* PEEK is a semicrystalline thermoplastic with excellent mechanical and chemical resistance properties that are retained to high temperatures.

Black Fin

LG's exclusive "Black Fin" heat exchanger is designed for Improved Corrosion Resistance.

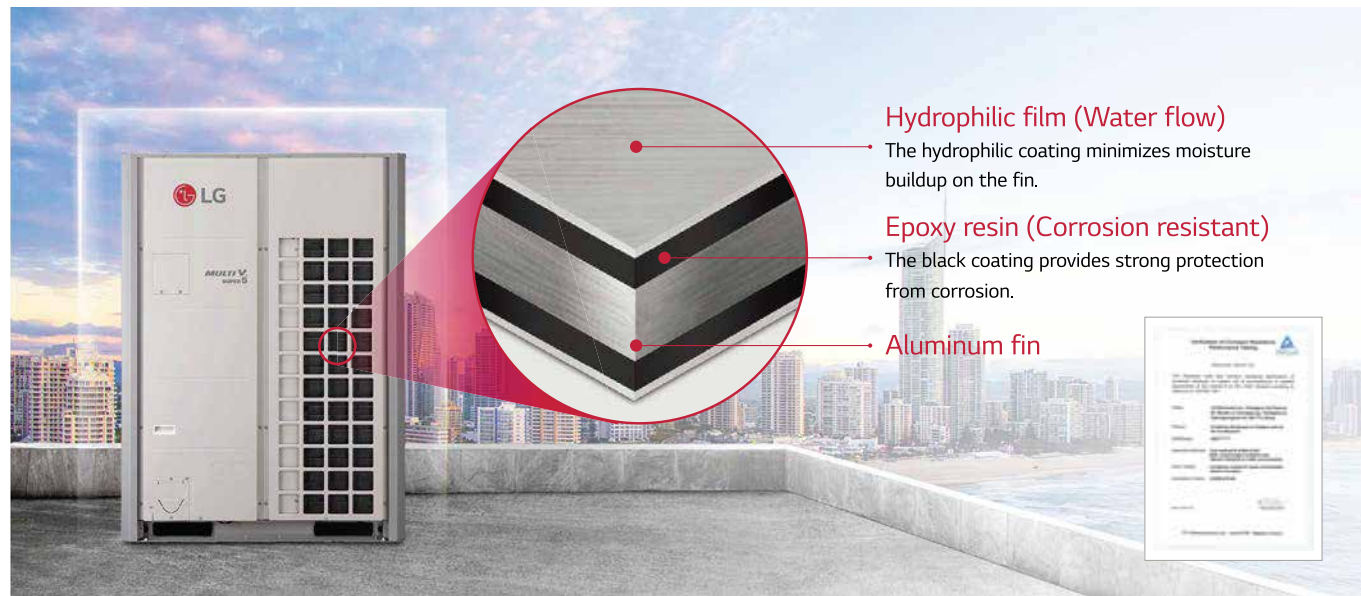

Back Up Function

When an operating compressor is malfunctioning, automatic emergency back up function is activated in order to continue cooling or heating operation using another compressor or another outdoor unit for back up operation whilst waiting for service. This function is for emergency situation, so users should contact their authorized service dealer as soon as fault has occurred.

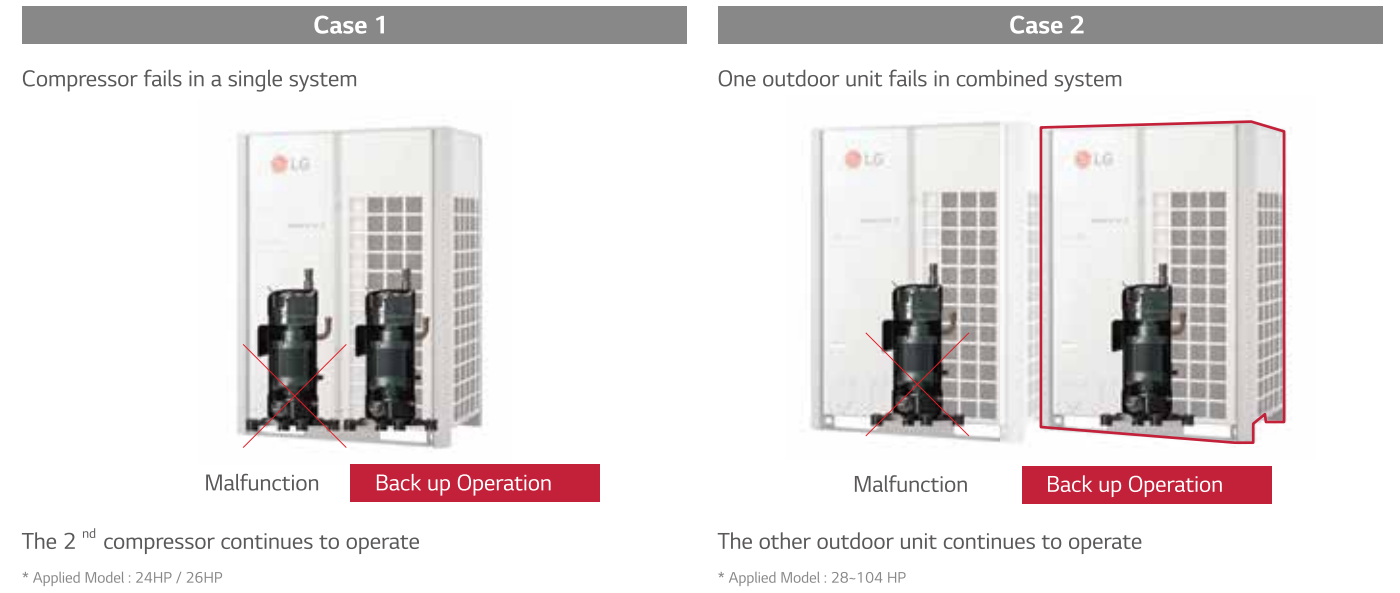

Extended Compressor Life Cycle by Alternative Operation

The running sequence of compressors are monitored by a built-in micro computer to ensure accumulated operation hours of all compressors are balanced. This leads to the longer working life of the compressors and the system.

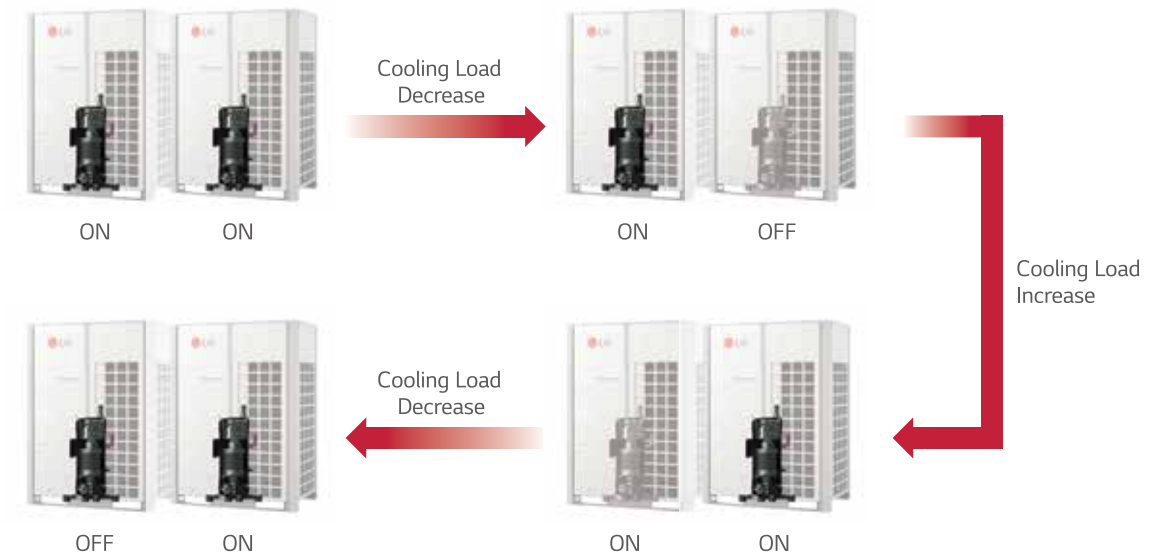

CONVENIENCE

Smart Individual Controller

Standard III Wired Remote Controller offers 4.3-inch large LCD screen with neat and premium design. This luxurious design well-matches interior design through colored screen and simple button layout.



- Premium Design
 - New Modern design 4.3 inch colored LCD & Simple touch button
- Intuitive Interface
 - Emotional graphic design Simple & user friendly
- Energy Management
 - Energy Monitoring
 - Real time ~ Yearly, Target setting & Alarm pop-up
 - Energy saving function (Time limit control, Setback)
- Variable Functions
 - Environment Information (Temperature, Humidity)
 - Integrated Schedule (Simple, Weekly)
 - Programmable with Digital Output (Option)



Wi-Fi Control

Control your air conditioners via using the smart internet devices as Android or iOS based smartphones.

Wi-Fi Modem & Smart ThinQ

- It is possible to access LG air conditioner anytime and from anywhere with Wi-Fi equipped device.
- Simple operation for various functions
 - On / Off
 - Operation Mode
 - Current / Set Temperature
 - Fan Speed
 - Vane Control
 - Reservation (Sleep, Weekly On / Off)
 - Energy Monitoring
 - Filter Management
 - Error check



Overview

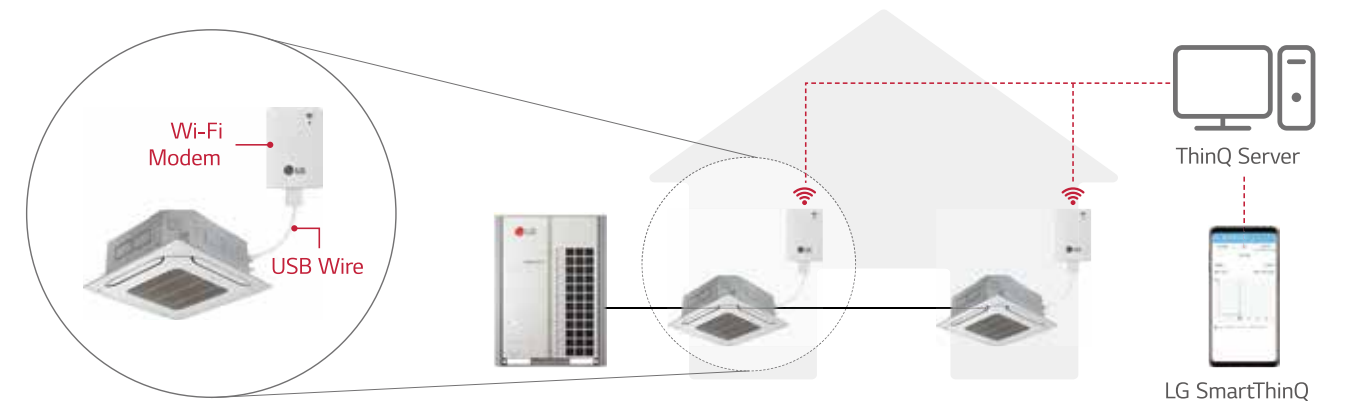

☒ Search "LG SmartThinQ" on Google market or Appstore then download the app.
 ☒ Internet service with Wi-Fi connection has to be available.

CONVENIENCE

Low-Noise Operation

The Low-Noise Operation is possible regardless of the time where noise sensitive areas. This function can be set by users through remote controller

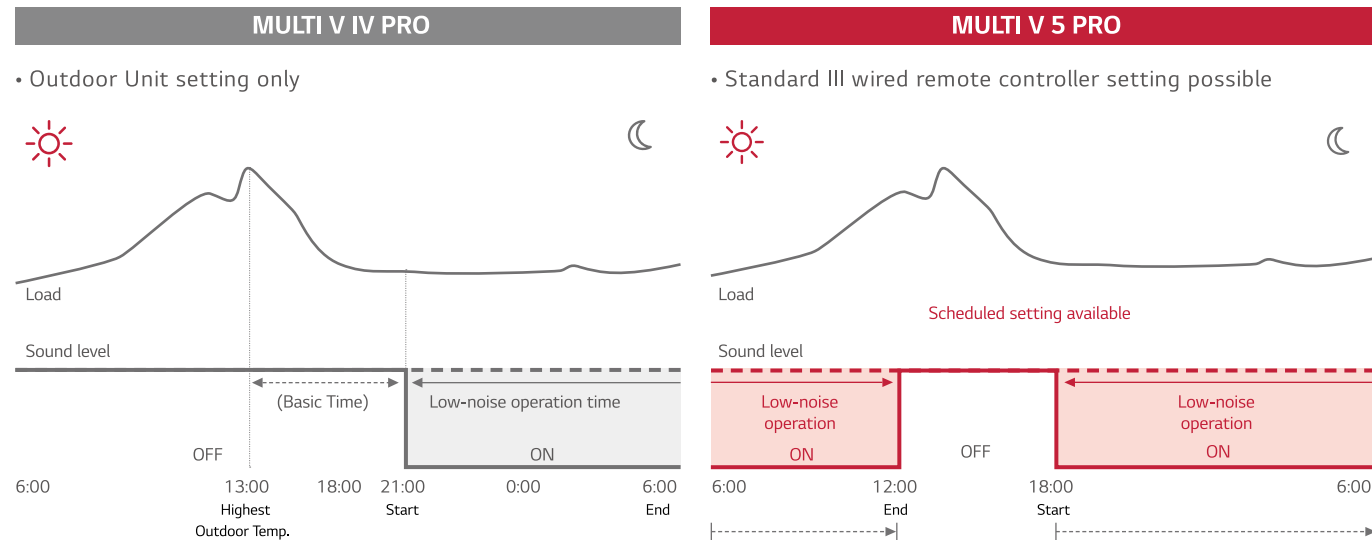

Refrigerant Leakage Detection

Refrigerant leakage detector senses real time refrigerant leakage and can secure Customer's safety.

- This detector alarms refrigerant leakage when the refrigerant concentration exceeds 6,000ppm. (The green and red LED lights blink simultaneously.)
- Alarm is "ON" over 6,000ppm has been maintained 5 seconds, and Alarm is "OFF" under 6,000ppm has been maintained 5 seconds.
- When the alarm of the refrigerant leak detector is switched on the user must ventilate the room until the alarm is disabled

CASE 1	CASE 2	CASE 3
Stop Operating (System Termination)	Main Pipe Closing & Pump Down	Branch Pipe Closing & Continuous Operating

• Accessory Specification (To realize the case2 application)

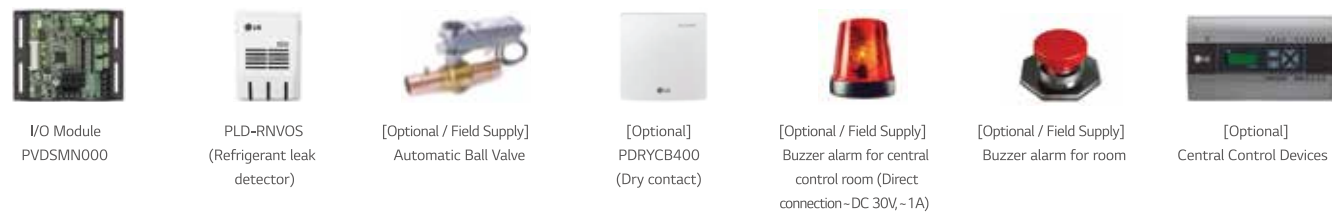

* Field supply item: Please contact to subsidiary to get the recommended specification of Necessary accessory. (LG Electronic don't provide this accessory)

Other Convenient functions

MULTI V 5 PRO has many useful functions.

Pump Down, Pump Out

- This function is very useful and convenient to repair the malfunction unit.
- Pump Down : When an indoor unit malfunctions, this function collects the refrigerant remaining in the piping line or indoor units to an outdoor unit.

- Pump Out : When an outdoor unit malfunctions, this function collects the refrigerant in other outdoor units, indoor unit, and piping line.

Auto Dust Removal

- MULTI V 5 PRO can remove dust(sand, leaves, and etc.) on heat exchanger of outdoor unit. This function can prevent performance degradation of the ODU heat exchanger
- Dust is removed on heat exchanger by reverse rotation of fan with Dip switch setting, 5 min. operation in every 2 hours.

Simple Test Run via LGMV

In order to bring out performance to the 100% level, proper product test run is necessary. For previous product, professional engineer who is well-aware of more than 40 different functional settings and 200+ error codes had to check main parts in order to make sure that the test run had succeeded. With Mobile LGMV of MULTI V 5 PRO, however, fast and accurate auto test run can be executed and the professional installer running the test can receive test results via email, which shortens installation hours and increases overall efficiency in installation processes.

Test run comparison

- Previous Model vs. MULTI V 5 PRO

Previous Model (Manual) vs. MULTI V 5 PRO (Automatic)

Wi-Fi MV Module

37% Reduction in Installation Hours

MULTI V 5 PRO

ARUN080LLS5 / ARUN100LLS5
ARUN120LLS5 / ARUN140LLS5



HP			8	10	12	14
Model Name	Combination Unit		ARUN080LLS5	ARUN100LLS5	ARUN120LLS5	ARUN140LLS5
	Independent Unit		ARUN080LLS5	ARUN100LLS5	ARUN120LLS5	ARUN140LLS5
Capacity	Cooling (Rated)	kW	22.4	28.0	33.6	39.2
		Btu/h	76,400	95,500	114,600	133,800
	Heating (Rated)	kW	22.4	28.0	33.6	39.2
		Btu/h	76,400	95,500	114,600	133,800
Input (Rated)	Cooling	kW	5.10	6.80	8.90	10.60
	Heating	kW	5.03	7.07	9.10	11.60
EER (Rated)			4.39	4.12	3.78	3.70
COP (Rated)			4.45	3.96	3.69	3.38
Power Factor	Rated	-	0.93	0.93	0.93	0.93
Exterior	Casing Color		Warm Gray / Dawn Gray	Warm Gray / Dawn Gray	Warm Gray / Dawn Gray	Warm Gray / Dawn Gray
	RAL code		RAL7038 / RAL 7037	RAL7038 / RAL 7037	RAL7038 / RAL 7037	RAL7038 / RAL 7037
Heat Exchanger			Wide Louver Plus	Wide Louver Plus	Wide Louver Plus	Wide Louver Plus
Compressor	Motor Output x Number	W x No.	4,200	4,200	5,300	5,300
	Type		Propeller fan	Propeller fan	Propeller fan	Propeller fan
Fan	Motor Output x Number	W	1,500	1,500	1,500	1,500
	Air Flow Rate (High)	m ³ /min	240	240	240	240
		ft ³ /min	8,476	8,476	8,476	8,476
	Drive		DC INVERTER	DC INVERTER	DC INVERTER	DC INVERTER
	Discharge	Side / Top	TOP	TOP	TOP	TOP
Pipe Connections For Heat Pump	Liquid Pipe	mm (inch)	9.52 (3/8)	9.52 (3/8)	12.7 (1/2)	12.7 (1/2)
	Gas Pipe	mm (inch)	19.05 (3/4)	22.2 (7/8)	28.58 (1-1/8)	28.58 (1-1/8)
Dimensions (W x H x D)			mm x No. (930 x 1,690 x 760) x 1	(930 x 1,690 x 760) x 1	(930 x 1,690 x 760) x 1	(930 x 1,690 x 760) x 1
Net Weight			kg 167	167	172	184
Sound Pressure Level	Cooling	dB(A)	58.0	58.0	59.0	60.0
	Heating	dB(A)	59.0	59.0	60.0	61.0
Communication Cable			mm ² x No. (VCTF-SB) 1.0 - 1.5 x 2C	1.0 - 1.5 x 2C	1.0 - 1.5 x 2C	1.0 - 1.5 x 2C
Refrigerant	Refrigerant Name		R410A	R410A	R410A	R410A
	Precharged Amount in Factory	kg	4.7	4.7	4.7	7.5
	GWP		2,087.5	2,087.5	2,087.5	2,087.5
	t-CO ₂ eq		9.8	9.8	9.8	15.7
	Control		Electronic Expansion Valve	Electronic Expansion Valve	Electronic Expansion Valve	Electronic Expansion Valve
Power Supply			∅, V, Hz 3, 380-415, 50	3, 380-415, 50	3, 380-415, 50	3, 380-415, 50
Number of Maximum Connectable Indoor Units			13 (20)	16 (25)	20 (30)	23 (35)

1. Due to our policy of innovation some specifications may be changed without notification.
 2. Wiring cable size must comply with the applicable local and national codes. And "Electric characteristics" chapter should be considered for electrical work and design. Especially the power cable and circuit breaker should be selected in accordance with that.
 3. Power factor could vary less than ±1% according to the operating conditions.
 4. Sound pressure level is measured on the rated condition in the anechoic rooms by ISO 3745 standard. Sound power level is measured on the rated condition in the reverberation rooms by ISO 9614 standard. Therefore, these values can be increased owing to ambient conditions during operation.
 5. Performances are based on the following conditions - Cooling : Indoor Ambient Temp. 27°CDB / 19°CWB, Outdoor Ambient Temp. 35°CDB / 24°CWB
 - Heating : Indoor Ambient Temp. 20°CDB / 15°CWB, Outdoor Ambient Temp. 7°CDB / 6°CWB
 Interconnected Pipe Length is 7.5m and difference of Elevation (Outdoor ~ Indoor Unit) is Zero.
 6. The numbers in parentheses means maximum connectable indoor units in accordance with outdoor units combination. The recommended ratio is 130%.
 7. This product contains Fluorinated greenhouse gases. (R410A, GWP(Global warming potential) = 2087.5)

MULTI V 5 PRO

ARUN160LLS5 / ARUN180LLS5
ARUN200LLS5



HP			16	18	20
Model Name	Combination Unit		ARUN160LLS5	ARUN180LLS5	ARUN200LLS5
	Independent Unit		ARUN160LLS5	ARUN180LLS5	ARUN200LLS5
Capacity	Cooling (Rated)	kW	44.8	50.4	56.0
		Btu/h	152,900	172,000	191,100
	Heating (Rated)	kW	44.8	50.4	56.0
		Btu/h	152,900	172,000	191,100
Input (Rated)	Cooling	kW	11.90	12.30	14.10
	Heating	kW	12.10	12.10	14.50
EER (Rated)			3.76	4.10	3.97
COP (Rated)			3.70	4.17	3.86
Power Factor	Rated	-	0.93	0.93	0.93
Exterior	Casing Color		Warm Gray / Dawn Gray	Warm Gray / Dawn Gray	Warm Gray / Dawn Gray
	RAL code		RAL7038 / RAL 7037	RAL7038 / RAL 7037	RAL7038 / RAL 7037
Heat Exchanger			Wide Louver Plus	Wide Louver Plus	Wide Louver Plus
Compressor	Motor Output x Number	W x No.	5,300	7,500	7,500
	Type		Propeller fan	Propeller fan	Propeller fan
Fan	Motor Output x Number	W	900 x 2	900 x 2	900 x 2
	Air Flow Rate (High)	m ³ /min	320	320	320
		ft ³ /min	11,301	11,301	11,301
	Drive		DC INVERTER	DC INVERTER	DC INVERTER
	Discharge	Side / Top	TOP	TOP	TOP
Pipe Connections For Heat Pump	Liquid Pipe	mm (inch)	12.7 (1/2)	15.88 (5/8)	15.88 (5/8)
	Gas Pipe	mm (inch)	28.58 (1-1/8)	28.58 (1-1/8)	28.58 (1-1/8)
Dimensions (W x H x D)			mm x No. (1,240 x 1,690 x 760) x 1	(1,240 x 1,690 x 760) x 1	(1,240 x 1,690 x 760) x 1
Net Weight			kg 205	230	230
Sound Pressure Level	Cooling	dB(A)	60.5	62.0	63.0
	Heating	dB(A)	61.5	64.5	66.0
Communication Cable			mm ² x No. (VCTF-SB) 1.0 - 1.5 x 2C	1.0 - 1.5 x 2C	1.0 - 1.5 x 2C
Refrigerant	Refrigerant Name		R410A	R410A	R410A
	Precharged Amount in Factory	kg	6.5	7.5	7.5
	GWP		2,087.5	2,087.5	2,087.5
	t-CO ₂ eq		13.6	15.7	15.7
	Control		Electronic Expansion Valve	Electronic Expansion Valve	Electronic Expansion Valve
Power Supply			∅, V, Hz 3, 380-415, 50	3, 380-415, 50	3, 380-415, 50
Number of Maximum Connectable Indoor Units			26 (40)	29 (45)	32 (50)

1. Due to our policy of innovation some specifications may be changed without notification.
 2. Wiring cable size must comply with the applicable local and national codes. And "Electric characteristics" chapter should be considered for electrical work and design. Especially the power cable and circuit breaker should be selected in accordance with that.
 3. Power factor could vary less than ±1% according to the operating conditions.
 4. Sound pressure level is measured on the rated condition in the anechoic rooms by ISO 3745 standard. Sound power level is measured on the rated condition in the reverberation rooms by ISO 9614 standard. Therefore, these values can be increased owing to ambient conditions during operation.
 5. Performances are based on the following conditions - Cooling : Indoor Ambient Temp. 27°CDB / 19°CWB, Outdoor Ambient Temp. 35°CDB / 24°CWB
 - Heating : Indoor Ambient Temp. 20°CDB / 15°CWB, Outdoor Ambient Temp. 7°CDB / 6°CWB
 Interconnected Pipe Length is 7.5m and difference of Elevation (Outdoor ~ Indoor Unit) is Zero.
 6. The numbers in parentheses means maximum connectable indoor units in accordance with outdoor units combination. The recommended ratio is 130%.
 7. This product contains Fluorinated greenhouse gases. (R410A, GWP(Global warming potential) = 2087.5)

MULTI V 5 PRO

ARUN220LLS5 / ARUN240LLS5
ARUN260LLS5



HP			22	24	26	
Model Name	Combination Unit		ARUN220LLS5	ARUN240LLS5	ARUN260LLS5	
	Independent Unit		ARUN220LLS5	ARUN240LLS5	ARUN260LLS5	
Capacity	Cooling (Rated)	kW	61.6	67.2	72.8	
		Btu/h	210,200	229,300	248,400	
	Heating (Rated)	kW	61.6	67.2	72.8	
		Btu/h	210,200	229,300	248,400	
Input (Rated)	Cooling	kW	16.80	18.20	20.80	
	Heating	kW	17.80	17.90	20.50	
EER (Rated)			3.67	3.69	3.50	
COP (Rated)			3.46	3.75	3.55	
Power Factor	Rated	-	0.93	0.93	0.93	
Exterior	Casing Color		Warm Gray / Dawn Gray	Warm Gray / Dawn Gray	Warm Gray / Dawn Gray	
	RAL code		RAL7038 / RAL 7037	RAL7038 / RAL 7037	RAL7038 / RAL 7037	
Heat Exchanger			Wide Louver Plus	Wide Louver Plus	Wide Louver Plus	
Compressor	Motor Output x Number	W x No.	7,500	5,300 x 2	5,300 x 2	
	Type		Propeller fan	Propeller fan	Propeller fan	
Fan	Motor Output x Number	W	900 x 2	900 x 2	900 x 2	
	Air Flow Rate (High)	m ³ /min	320	320	320	
		ft ³ /min	11,301	11,301	11,301	
	Drive		DC INVERTER	DC INVERTER	DC INVERTER	
	Discharge	Side / Top	TOP	TOP	TOP	
Pipe Connections For Heat Pump	Liquid Pipe	mm (inch)	15.88 (5/8)	15.88 (5/8)	19.05 (3/4)	
	Gas Pipe	mm (inch)	28.58 (1-1/8)	34.9 (1-3/8)	34.9 (1-3/8)	
Dimensions (W x H x D)		mm x No.	(1,240 x 1,690 x 760) x 1	(1,240 x 1,690 x 760) x 1	(1,240 x 1,690 x 760) x 1	
Net Weight		kg	230	268	268	
Sound Pressure Level	Cooling	dB(A)	64.0	65.0	65.0	
	Heating	dB(A)	67.0	67.0	67.0	
Communication Cable		mm ² x No. (VCTF-SB)	1.0 - 1.5 x 2C	1.0 - 1.5 x 2C	1.0 - 1.5 x 2C	
Refrigerant	Refrigerant Name		R410A	R410A	R410A	
	Precharged Amount in Factory		kg	7.5	11	11
	GWP			2,087.5	2,087.5	2,087.5
	t-CO ₂ eq			15.7	23.0	23.0
	Control			Electronic Expansion Valve	Electronic Expansion Valve	Electronic Expansion Valve
Power Supply		∅, V, Hz	3, 380-415, 50	3, 380-415, 50	3, 380-415, 50	
Number of Maximum Connectable Indoor Units			3, 380, 60	3, 380, 60	3, 380, 60	
			35 (56)	39 (61)	42 (64)	

1. Due to our policy of innovation some specifications may be changed without notification.
 2. Wiring cable size must comply with the applicable local and national codes. And "Electric characteristics" chapter should be considered for electrical work and design. Especially the power cable and circuit breaker should be selected in accordance with that.
 3. Power factor could vary less than ±1% according to the operating conditions.
 4. Sound pressure level is measured on the rated condition in the anechoic rooms by ISO 3745 standard. Sound power level is measured on the rated condition in the reverberation rooms by ISO 9614 standard. Therefore, these values can be increased owing to ambient conditions during operation.
 5. Performances are based on the following conditions - Cooling : Indoor Ambient Temp. 27°CDB / 19°CWB, Outdoor Ambient Temp. 35°CDB / 24°CWB
 - Heating : Indoor Ambient Temp. 20°CDB / 15°CWB, Outdoor Ambient Temp. 7°CDB / 6°CWB
 Interconnected Pipe Length is 7.5m and difference of Elevation (Outdoor - Indoor Unit) is Zero.
 6. The numbers in parentheses means maximum connectable indoor units in accordance with outdoor units combination. The recommended ratio is 130%.
 7. This product contains Fluorinated greenhouse gases. (R410A, GWP(Global warming potential) = 2087.5)

MULTI V 5 PRO

ARUN280LLS5 / ARUN300LLS5
ARUN320LLS5



HP			28	30	32	
Model Name	Combination Unit		ARUN280LLS5	ARUN300LLS5	ARUN320LLS5	
	Independent Unit		ARUN160LLS5 ARUN120LLS5	ARUN180LLS5 ARUN120LLS5	ARUN200LLS5 ARUN120LLS5	
Capacity	Cooling (Rated)	kW	78.4	84.0	89.6	
		Btu/h	267,500	286,600	305,700	
	Heating (Rated)	kW	78.4	84.0	89.6	
		Btu/h	267,500	286,600	305,700	
Input (Rated)	Cooling	kW	20.8	21.2	23.0	
	Heating	kW	21.2	21.2	23.6	
EER (Rated)			3.77	3.96	3.90	
COP (Rated)			3.70	3.96	3.80	
Power Factor	Rated	-	0.93	0.93	0.93	
Exterior	Casing Color		Warm Gray / Dawn Gray	Warm Gray / Dawn Gray	Warm Gray / Dawn Gray	
	RAL code		RAL7038 / RAL 7037	RAL7038 / RAL 7037	RAL7038 / RAL 7037	
Heat Exchanger			Wide Louver Plus	Wide Louver Plus	Wide Louver Plus	
Compressor	Motor Output x Number	W x No.	5,300 x 2	(7,500 x 1) + (5,300 x 1)	(7,500 x 1) + (5,300 x 1)	
	Type		Propeller fan	Propeller fan	Propeller fan	
Fan	Motor Output x Number	W	(900 x 2) + (1,500 x 1)	(900 x 2) + (1,500 x 1)	(900 x 2) + (1,500 x 1)	
	Air Flow Rate (High)	m ³ /min	(320 x 1) + (240 x 1)	(320 x 1) + (240 x 1)	(320 x 1) + (240 x 1)	
		ft ³ /min	(11,301 x 1) + (8,476 x 1)	(11,301 x 1) + (8,476 x 1)	(11,301 x 1) + (8,476 x 1)	
	Drive		DC INVERTER	DC INVERTER	DC INVERTER	
	Discharge	Side / Top	TOP	TOP	TOP	
Pipe Connections For Heat Pump	Liquid Pipe	mm (inch)	19.05 (3/4)	19.05 (3/4)	19.05 (3/4)	
	Gas Pipe	mm (inch)	34.9 (1-3/8)	34.9 (1-3/8)	34.9 (1-3/8)	
Dimensions (W x H x D)		mm x No.	(1,240 x 1,690 x 760) x 1 + (930 x 1,690 x 760) x 1	(1,240 x 1,690 x 760) x 1 + (930 x 1,690 x 760) x 1	(1,240 x 1,690 x 760) x 1 + (930 x 1,690 x 760) x 1	
Net Weight		kg	(205) + (172)	(230) + (172)	(230) + (172)	
Sound Pressure Level	Cooling	dB(A)	62.8	63.8	64.5	
	Heating	dB(A)	63.8	65.8	67.0	
Communication Cable		mm ² x No. (VCTF-SB)	1.0 - 1.5 x 2C	1.0 - 1.5 x 2C	1.0 - 1.5 x 2C	
Refrigerant	Refrigerant Name		R410A	R410A	R410A	
	Precharged Amount in Factory		kg	11.2	12.2	12.2
	GWP			2,087.5	2,087.5	2,087.5
	t-CO ₂ eq			23.4	25.5	25.5
	Control			Electronic Expansion Valve	Electronic Expansion Valve	Electronic Expansion Valve
Power Supply		∅, V, Hz	3, 380-415, 50	3, 380-415, 50	3, 380-415, 50	
			3, 380, 60	3, 380, 60	3, 380, 60	
Number of Maximum Connectable Indoor Units			45 (56)	49 (60)	52 (64)	

1. Due to our policy of innovation some specifications may be changed without notification.
 2. Wiring cable size must comply with the applicable local and national codes. And "Electric characteristics" chapter should be considered for electrical work and design. Especially the power cable and circuit breaker should be selected in accordance with that.
 3. Power factor could vary less than ±1% according to the operating conditions.
 4. Sound pressure level is measured on the rated condition in the anechoic rooms by ISO 3745 standard. Sound power level is measured on the rated condition in the reverberation rooms by ISO 9614 standard. Therefore, these values can be increased owing to ambient conditions during operation.
 5. Performances are based on the following conditions - Cooling : Indoor Ambient Temp. 27°CDB / 19°CWB, Outdoor Ambient Temp. 35°CDB / 24°CWB
 - Heating : Indoor Ambient Temp. 20°CDB / 15°CWB, Outdoor Ambient Temp. 7°CDB / 6°CWB
 Interconnected Pipe Length is 7.5m and difference of Elevation (Outdoor - Indoor Unit) is Zero.
 6. The numbers in parentheses means maximum connectable indoor units in accordance with outdoor units combination. The recommended ratio is 130%.
 7. This product contains Fluorinated greenhouse gases. (R410A, GWP(Global warming potential) = 2087.5)

MULTI V 5 PRO

ARUN340LLS5 / ARUN360LLS5
ARUN380LLS5



HP			34	36	38
Model Name	Combination Unit		ARUN340LLS5	ARUN360LLS5	ARUN380LLS5
	Independent Unit		ARUN220LLS5 ARUN120LLS5	ARUN240LLS5 ARUN120LLS5	ARUN260LLS5 ARUN120LLS5
Capacity	Cooling (Rated)	kW	95.2	100.8	106.4
		Btu/h	324,800	343,900	363,000
	Heating (Rated)	kW	95.2	100.8	106.4
		Btu/h	324,800	343,900	363,000
Input (Rated)	Cooling	kW	25.7	27.1	29.7
	Heating	kW	26.9	27.0	29.6
EER (Rated)			3.70	3.72	3.58
COP (Rated)			3.54	3.73	3.59
Power Factor	Rated	-	0.93	0.93	0.93
Exterior	Casing Color		Warm Gray / Dawn Gray	Warm Gray / Dawn Gray	Warm Gray / Dawn Gray
	RAL code		RAL7038 / RAL 7037	RAL7038 / RAL 7037	RAL7038 / RAL 7037
Heat Exchanger			Wide Louver Plus	Wide Louver Plus	Wide Louver Plus
Compressor	Motor Output x Number	W x No.	(7,500 x 1) + (5,300 x 1)	5,300 x 3	5,300 x 3
	Type		Propeller fan	Propeller fan	Propeller fan
Fan	Motor Output x Number	W	(900 x 2) + (1,500 x 1)	(900 x 2) + (1,500 x 1)	(900 x 2) + (1,500 x 1)
	Air Flow Rate (High)	m ³ /min	(320 x 1) + (240 x 1)	(320 x 1) + (240 x 1)	(320 x 1) + (240 x 1)
		ft ³ /min	(11,301 x 1) + (8,476 x 1)	(11,301 x 1) + (8,476 x 1)	(11,301 x 1) + (8,476 x 1)
	Drive		DC INVERTER	DC INVERTER	DC INVERTER
	Discharge	Side / Top	TOP	TOP	TOP
Pipe Connections For Heat Pump	Liquid Pipe	mm (inch)	19.05 (3/4)	19.05 (3/4)	19.05 (3/4)
	Gas Pipe	mm (inch)	34.9 (1-3/8)	41.3 (1-5/8)	41.3 (1-5/8)
Dimensions (W x H x D)		mm x No.	(1,240 x 1,690 x 760) x 1 + (930 x 1,690 x 760) x 1	(1,240 x 1,690 x 760) x 1 + (930 x 1,690 x 760) x 1	(1,240 x 1,690 x 760) x 1 + (930 x 1,690 x 760) x 1
Net Weight		kg	(230) + (172)	(268) + (172)	(268) + (172)
Sound Pressure Level	Cooling	dB(A)	65.2	66.0	66.0
	Heating	dB(A)	67.8	67.8	67.8
Communication Cable		mm ² x No. (VCTF-SB)	1.0 - 1.5 x 2C	1.0 - 1.5 x 2C	1.0 - 1.5 x 2C
Refrigerant	Refrigerant Name		R410A	R410A	R410A
	Precharged Amount in Factory	kg	12.2	15.7	15.7
	GWP		2,087.5	2,087.5	2,087.5
	t-CO ₂ ,eq		25.5	32.8	32.8
	Control			Electronic Expansion Valve	Electronic Expansion Valve
Power Supply	∅, V, Hz		3, 380-415, 50	3, 380-415, 50	3, 380-415, 50
			3, 380, 60	3, 380, 60	3, 380, 60
Number of Maximum Connectable Indoor Units			55 (64)	58 (64)	61 (64)

- Due to our policy of innovation some specifications may be changed without notification.
- Wiring cable size must comply with the applicable local and national codes. And "Electric characteristics" chapter should be considered for electrical work and design. Especially the power cable and circuit breaker should be selected in accordance with that.
- Power factor could vary less than ±1% according to the operating conditions.
- Sound pressure level is measured on the rated condition in the anechoic rooms by ISO 3745 standard. Sound power level is measured on the rated condition in the reverberation rooms by ISO 9614 standard. Therefore, these values can be increased owing to ambient conditions during operation.
- Performances are based on the following conditions - Cooling : Indoor Ambient Temp. 27°CDB / 19°CWB, Outdoor Ambient Temp. 35°CDB / 24°CWB
- Heating : Indoor Ambient Temp. 20°CDB / 15°CWB, Outdoor Ambient Temp. 7°CDB / 6°CWB
Interconnected Pipe Length is 7.5m and difference of Elevation (Outdoor - Indoor Unit) is Zero.
- The numbers in parentheses means maximum connectable indoor units in accordance with outdoor units combination. The recommended ratio is 130%.
- This product contains Fluorinated greenhouse gases. (R410A, GWP(Global warming potential) = 2087.5)

MULTI V 5 PRO

ARUN400LLS5 / ARUN420LLS5
ARUN440LLS5



HP			40	42	44
Model Name	Combination Unit		ARUN400LLS5	ARUN420LLS5	ARUN440LLS5
	Independent Unit		ARUN260LLS5 ARUN140LLS5	ARUN260LLS5 ARUN160LLS5	ARUN260LLS5 ARUN180LLS5
Capacity	Cooling (Rated)	kW	112.0	117.6	123.2
		Btu/h	382,200	401,300	420,400
	Heating (Rated)	kW	112.0	117.6	123.2
		Btu/h	382,200	401,300	420,400
Input (Rated)	Cooling	kW	31.4	32.7	33.1
	Heating	kW	32.1	32.6	32.6
EER (Rated)			3.57	3.60	3.72
COP (Rated)			3.49	3.61	3.78
Power Factor	Rated	-	0.93	0.93	0.93
Exterior	Casing Color		Warm Gray / Dawn Gray	Warm Gray / Dawn Gray	Warm Gray / Dawn Gray
	RAL code		RAL7038 / RAL 7037	RAL7038 / RAL 7037	RAL7038 / RAL 7037
Heat Exchanger			Wide Louver Plus	Wide Louver Plus	Wide Louver Plus
Compressor	Motor Output x Number	W x No.	5,300 x 3	5,300 x 3	(5,300 x 2) + (7,500 x 1)
	Type		Propeller fan	Propeller fan	Propeller fan
Fan	Motor Output x Number	W	(900 x 2) + (1,500 x 1)	900 x 4	900 x 4
	Air Flow Rate (High)	m ³ /min	(320 x 1) + (240 x 1)	320 x 2	320 x 2
		ft ³ /min	(11,301 x 1) + (8,476 x 1)	11,301 x 2	11,301 x 2
	Drive		DC INVERTER	DC INVERTER	DC INVERTER
	Discharge	Side / Top	TOP	TOP	TOP
Pipe Connections For Heat Pump	Liquid Pipe	mm (inch)	19.05 (3/4)	19.05 (3/4)	19.05 (3/4)
	Gas Pipe	mm (inch)	41.3 (1-5/8)	41.3 (1-5/8)	41.3 (1-5/8)
Dimensions (W x H x D)		mm x No.	(1,240 x 1,690 x 760) x 1 + (930 x 1,690 x 760) x 1	(1,240 x 1,690 x 760) x 2	(1,240 x 1,690 x 760) x 2
Net Weight		kg	(268) + (184)	(268) + (205)	(268) + (230)
Sound Pressure Level	Cooling	dB(A)	66.2	66.3	66.8
	Heating	dB(A)	68.0	68.1	68.9
Communication Cable		mm ² x No. (VCTF-SB)	1.0 - 1.5 x 2C	1.0 - 1.5 x 2C	1.0 - 1.5 x 2C
Refrigerant	Refrigerant Name		R410A	R410A	R410A
	Precharged Amount in Factory	kg	18.5	17.5	18.5
	GWP		2,087.5	2,087.5	2,087.5
	t-CO ₂ ,eq		38.6	36.5	38.6
	Control			Electronic Expansion Valve	Electronic Expansion Valve
Power Supply	∅, V, Hz		3, 380-415, 50	3, 380-415, 50	3, 380-415, 50
			3, 380, 60	3, 380, 60	3, 380, 60
Number of Maximum Connectable Indoor Units			64	64	64

- Due to our policy of innovation some specifications may be changed without notification.
- Wiring cable size must comply with the applicable local and national codes. And "Electric characteristics" chapter should be considered for electrical work and design. Especially the power cable and circuit breaker should be selected in accordance with that.
- Power factor could vary less than ±1% according to the operating conditions.
- Sound pressure level is measured on the rated condition in the anechoic rooms by ISO 3745 standard. Sound power level is measured on the rated condition in the reverberation rooms by ISO 9614 standard. Therefore, these values can be increased owing to ambient conditions during operation.
- Performances are based on the following conditions - Cooling : Indoor Ambient Temp. 27°CDB / 19°CWB, Outdoor Ambient Temp. 35°CDB / 24°CWB
- Heating : Indoor Ambient Temp. 20°CDB / 15°CWB, Outdoor Ambient Temp. 7°CDB / 6°CWB
Interconnected Pipe Length is 7.5m and difference of Elevation (Outdoor - Indoor Unit) is Zero.
- The numbers in parentheses means maximum connectable indoor units in accordance with outdoor units combination. The recommended ratio is 130%.
- This product contains Fluorinated greenhouse gases. (R410A, GWP(Global warming potential) = 2087.5)

MULTI V 5 PRO

ARUN460LLS5 / ARUN480LLS5
ARUN500LLS5



HP			46	48	50
Model Name	Combination Unit		ARUN460LLS5	ARUN480LLS5	ARUN500LLS5
	Independent Unit		ARUN260LLS5 ARUN200LLS5	ARUN260LLS5 ARUN220LLS5	ARUN260LLS5 ARUN240LLS5
Capacity	Cooling (Rated)	kW	128.8	134.4	140.0
		Btu/h	439,500	458,600	477,700
	Heating (Rated)	kW	128.8	134.4	140.0
		Btu/h	439,500	458,600	477,700
Input (Rated)	Cooling	kW	34.9	37.6	39.0
	Heating	kW	35.0	38.3	38.4
EER (Rated)			3.69	3.57	3.59
COP (Rated)			3.68	3.51	3.65
Power Factor	Rated	-	0.93	0.93	0.93
Exterior	Casing Color		Warm Gray / Dawn Gray	Warm Gray / Dawn Gray	Warm Gray / Dawn Gray
	RAL code		RAL7038 / RAL 7037	RAL7038 / RAL 7037	RAL7038 / RAL 7037
Heat Exchanger			Wide Louver Plus	Wide Louver Plus	Wide Louver Plus
Compressor	Motor Output x Number	W x No.	(5,300 x 2) + (7,500 x 1)	(5,300 x 2) + (7,500 x 1)	5,300 x 4
	Type		Propeller fan	Propeller fan	Propeller fan
Fan	Motor Output x Number	W	900 x 4	900 x 4	900 x 4
	Air Flow Rate (High)	m ³ /min	320 x 2	320 x 2	320 x 2
		ft ³ /min	11,301 x 2	11,301 x 2	11,301 x 2
	Drive		DC INVERTER	DC INVERTER	DC INVERTER
	Discharge	Side / Top	TOP	TOP	TOP
Pipe Connections For Heat Pump	Liquid Pipe	mm (inch)	19.05 (3/4)	19.05 (3/4)	19.05 (3/4)
	Gas Pipe	mm (inch)	41.3 (1-5/8)	41.3 (1-5/8)	41.3 (1-5/8)
Dimensions (W x H x D)		mm x No.	(1,240 x 1,690 x 760) x 2	(1,240 x 1,690 x 760) x 2	(1,240 x 1,690 x 760) x 2
Net Weight		kg	(268) + (230)	(268) + (230)	(268) + (268)
Sound Pressure Level	Cooling	dB(A)	67.1	67.5	68.0
	Heating	dB(A)	69.5	70.0	70.0
Communication Cable		mm ² x No. (VCTF-SB)	1.0 - 1.5 x 2C	1.0 - 1.5 x 2C	1.0 - 1.5 x 2C
Refrigerant	Refrigerant Name		R410A	R410A	R410A
	Precharged Amount in Factory	kg	18.5	18.5	22.0
	GWP		2,087.5	2,087.5	2,087.5
	t-CO ₂ eq		38.6	38.6	45.9
	Control		Electronic Expansion Valve	Electronic Expansion Valve	Electronic Expansion Valve
Power Supply	Ø, V, Hz		3, 380-415, 50	3, 380-415, 50	3, 380-415, 50
			3, 380, 60	3, 380, 60	3, 380, 60
Number of Maximum Connectable Indoor Units			64	64	64

1. Due to our policy of innovation some specifications may be changed without notification.
 2. Wiring cable size must comply with the applicable local and national codes. And "Electric characteristics" chapter should be considered for electrical work and design. Especially the power cable and circuit breaker should be selected in accordance with that.
 3. Power factor could vary less than ±1% according to the operating conditions.
 4. Sound pressure level is measured on the rated condition in the anechoic rooms by ISO 3745 standard. Sound power level is measured on the rated condition in the reverberation rooms by ISO 9614 standard. Therefore, these values can be increased owing to ambient conditions during operation.
 5. Performances are based on the following conditions - Cooling : Indoor Ambient Temp. 27°CDB / 19°CWB, Outdoor Ambient Temp. 35°CDB / 24°CWB
 - Heating : Indoor Ambient Temp. 20°CDB / 15°CWB, Outdoor Ambient Temp. 7°CDB / 6°CWB
 Interconnected Pipe Length is 7.5m and difference of Elevation (Outdoor - Indoor Unit) is Zero.
 6. The numbers in parentheses means maximum connectable indoor units in accordance with outdoor units combination. The recommended ratio is 130%.
 7. This product contains Fluorinated greenhouse gases. (R410A, GWP(Global warming potential) = 2087.5)

MULTI V 5 PRO

ARUN520LLS5 / ARUN540LLS5
ARUN560LLS5



HP			52	54	56
Model Name	Combination Unit		ARUN520LLS5	ARUN540LLS5	ARUN560LLS5
	Independent Unit		ARUN260LLS5 ARUN260LLS5	ARUN260LLS5 ARUN160LLS5 ARUN120LLS5	ARUN260LLS5 ARUN180LLS5 ARUN120LLS5
Capacity	Cooling (Rated)	kW	145.6	151.2	156.8
		Btu/h	496,800	515,900	535,000
	Heating (Rated)	kW	145.6	151.2	156.8
		Btu/h	496,800	515,900	535,000
Input (Rated)	Cooling	kW	41.6	41.6	42.0
	Heating	kW	41.0	41.7	41.7
EER (Rated)			3.50	3.63	3.73
COP (Rated)			3.55	3.63	3.76
Power Factor	Rated	-	0.93	0.93	0.93
Exterior	Casing Color		Warm Gray / Dawn Gray	Warm Gray / Dawn Gray	Warm Gray / Dawn Gray
	RAL code		RAL7038 / RAL 7037	RAL7038 / RAL 7037	RAL7038 / RAL 7037
Heat Exchanger			Wide Louver Plus	Wide Louver Plus	Wide Louver Plus
Compressor	Motor Output x Number	W x No.	5,300 x 4	5,300 x 4	(5,300 x 3) + (7,500 x 1)
	Type		Propeller fan	Propeller fan	Propeller fan
Fan	Motor Output x Number	W	900 x 4	(900 x 4) + (1,500 x 1)	(900 x 4) + (1,500 x 1)
	Air Flow Rate (High)	m ³ /min	320 x 2	(320 x 2) + (240 x 1)	(320 x 2) + (240 x 1)
		ft ³ /min	11,301 x 2	(11,301 x 2) + (8,476 x 1)	(11,301 x 2) + (8,476 x 1)
	Drive		DC INVERTER	DC INVERTER	DC INVERTER
	Discharge	Side / Top	TOP	TOP	TOP
Pipe Connections For Heat Pump	Liquid Pipe	mm (inch)	19.05 (3/4)	19.05 (3/4)	19.05 (3/4)
	Gas Pipe	mm (inch)	41.3 (1-5/8)	41.3 (1-5/8)	41.3 (1-5/8)
Dimensions (W x H x D)		mm x No.	(1,240 x 1,690 x 760) x 2	(1,240 x 1,690 x 760) x 2 + (930 x 1,690 x 760) x 1	(1,240 x 1,690 x 760) x 2 + (930 x 1,690 x 760) x 1
Net Weight		kg	(268) + (268)	(268) + (205) + (172)	(268) + (230) + (172)
Sound Pressure Level	Cooling	dB(A)	68.0	67.1	67.4
	Heating	dB(A)	70.0	68.7	69.5
Communication Cable		mm ² x No. (VCTF-SB)	1.0 - 1.5 x 2C	1.0 - 1.5 x 2C	1.0 - 1.5 x 2C
Refrigerant	Refrigerant Name		R410A	R410A	R410A
	Precharged Amount in Factory	kg	22.0	22.2	23.2
	GWP		2,087.5	2,087.5	2,087.5
	t-CO ₂ eq		45.9	46.3	48.4
	Control		Electronic Expansion Valve	Electronic Expansion Valve	Electronic Expansion Valve
Power Supply	Ø, V, Hz		3, 380-415, 50	3, 380-415, 50	3, 380-415, 50
			3, 380, 60	3, 380, 60	3, 380, 60
Number of Maximum Connectable Indoor Units			64	64	64

1. Due to our policy of innovation some specifications may be changed without notification.
 2. Wiring cable size must comply with the applicable local and national codes. And "Electric characteristics" chapter should be considered for electrical work and design. Especially the power cable and circuit breaker should be selected in accordance with that.
 3. Power factor could vary less than ±1% according to the operating conditions.
 4. Sound pressure level is measured on the rated condition in the anechoic rooms by ISO 3745 standard. Sound power level is measured on the rated condition in the reverberation rooms by ISO 9614 standard. Therefore, these values can be increased owing to ambient conditions during operation.
 5. Performances are based on the following conditions - Cooling : Indoor Ambient Temp. 27°CDB / 19°CWB, Outdoor Ambient Temp. 35°CDB / 24°CWB
 - Heating : Indoor Ambient Temp. 20°CDB / 15°CWB, Outdoor Ambient Temp. 7°CDB / 6°CWB
 Interconnected Pipe Length is 7.5m and difference of Elevation (Outdoor - Indoor Unit) is Zero.
 6. The numbers in parentheses means maximum connectable indoor units in accordance with outdoor units combination. The recommended ratio is 130%.
 7. This product contains Fluorinated greenhouse gases. (R410A, GWP(Global warming potential) = 2087.5)

MULTI V 5 PRO

ARUN580LLS5 / ARUN600LLS5
ARUN620LLS5



HP			58	60	62
Model Name	Combination Unit		ARUN580LLS5	ARUN600LLS5	ARUN620LLS5
	Independent Unit		ARUN260LLS5 ARUN200LLS5 ARUN120LLS5	ARUN260LLS5 ARUN220LLS5 ARUN120LLS5	ARUN260LLS5 ARUN240LLS5 ARUN120LLS5
Capacity	Cooling (Rated)	kW	162.4	168.0	173.6
		Btu/h	554,100	573,200	592,300
	Heating (Rated)	kW	162.4	168.0	173.6
		Btu/h	554,100	573,200	592,300
Input (Rated)	Cooling	kW	43.8	46.5	47.9
	Heating	kW	44.1	47.4	47.5
EER (Rated)			3.71	3.61	3.62
COP (Rated)			3.68	3.54	3.65
Power Factor	Rated	-	0.93	0.93	0.93
Exterior	Casing Color		Warm Gray / Dawn Gray	Warm Gray / Dawn Gray	Warm Gray / Dawn Gray
	RAL code		RAL7038 / RAL 7037	RAL7038 / RAL 7037	RAL7038 / RAL 7037
Heat Exchanger			Wide Louver Plus	Wide Louver Plus	Wide Louver Plus
Compressor	Motor Output x Number	W x No.	(5,300 x 3) + (7,500 x 1)	(5,300 x 3) + (7,500 x 1)	5,300 x 5
	Type		Propeller fan	Propeller fan	Propeller fan
Fan	Motor Output x Number	W	(900 x 4) + (1,500 x 1)	(900 x 4) + (1,500 x 1)	(900 x 4) + (1,500 x 1)
	Air Flow Rate (High)	m ³ /min	(320 x 2) + (240 x 1)	(320 x 2) + (240 x 1)	(320 x 2) + (240 x 1)
		ft ³ /min	(11,301 x 2) + (8,476 x 1)	(11,301 x 2) + (8,476 x 1)	(11,301 x 2) + (8,476 x 1)
	Drive		DC INVERTER	DC INVERTER	DC INVERTER
Discharge	Side / Top	TOP	TOP	TOP	
Pipe Connections For Heat Pump	Liquid Pipe	mm (inch)	19.05 (3/4)	19.05 (3/4)	22.2 (7/8)
	Gas Pipe	mm (inch)	41.3 (1-5/8)	41.3 (1-5/8)	41.3 (1-5/8)
Dimensions (W x H x D)	mm x No.		(1,240 x 1,690 x 760) x 2 + (930 x 1,690 x 760) x 1	(1,240 x 1,690 x 760) x 2 + (930 x 1,690 x 760) x 1	(1,240 x 1,690 x 760) x 2 + (930 x 1,690 x 760) x 1
Net Weight	kg		(268) + (230) + (172)	(268) + (230) + (172)	(268) + (230) + (172)
Sound Pressure Level	Cooling	dB(A)	67.7	68.1	68.5
	Heating	dB(A)	70.0	70.4	70.4
Communication Cable	mm ² x No. (VCTF-SB)		1.0 - 1.5 x 2C	1.0 - 1.5 x 2C	1.0 - 1.5 x 2C
Refrigerant	Refrigerant Name		R410A	R410A	R410A
	Precharged Amount in Factory	kg	23.2	23.2	26.7
	GWP		2,087.5	2,087.5	2,087.5
	t-CO ₂ eq		48.4	48.4	55.7
Control			Electronic Expansion Valve	Electronic Expansion Valve	Electronic Expansion Valve
Power Supply	Ø, V, Hz		3, 380-415, 50	3, 380-415, 50	3, 380-415, 50
			3, 380, 60	3, 380, 60	3, 380, 60
Number of Maximum Connectable Indoor Units			64	64	64

1. Due to our policy of innovation some specifications may be changed without notification.
 2. Wiring cable size must comply with the applicable local and national codes. And "Electric characteristics" chapter should be considered for electrical work and design. Especially the power cable and circuit breaker should be selected in accordance with that.
 3. Power factor could vary less than ±1% according to the operating conditions.
 4. Sound pressure level is measured on the rated condition in the anechoic rooms by ISO 3745 standard. Sound power level is measured on the rated condition in the reverberation rooms by ISO 9614 standard. Therefore, these values can be increased owing to ambient conditions during operation.
 5. Performances are based on the following conditions - Cooling : Indoor Ambient Temp. 27°CDB / 19°CWB, Outdoor Ambient Temp. 35°CDB / 24°CWB
 - Heating : Indoor Ambient Temp. 20°CDB / 15°CWB, Outdoor Ambient Temp. 7°CDB / 6°CWB
 Interconnected Pipe Length is 7.5m and difference of Elevation (Outdoor - Indoor Unit) is Zero.
 6. The numbers in parentheses means maximum connectable indoor units in accordance with outdoor units combination. The recommended ratio is 130%.
 7. This product contains Fluorinated greenhouse gases. (R410A, GWP(Global warming potential) = 2087.5)

MULTI V 5 PRO

ARUN640LLS5 / ARUN660LLS5
ARUN680LLS5



HP			64	66	68
Model Name	Combination Unit		ARUN640LLS5	ARUN660LLS5	ARUN680LLS5
	Independent Unit		ARUN260LLS5 ARUN260LLS5 ARUN120LLS5	ARUN260LLS5 ARUN260LLS5 ARUN140LLS5	ARUN260LLS5 ARUN260LLS5 ARUN160LLS5
Capacity	Cooling (Rated)	kW	179.2	184.8	190.4
		Btu/h	611,400	630,600	649,700
	Heating (Rated)	kW	179.2	184.8	190.4
		Btu/h	611,400	630,600	649,700
Input (Rated)	Cooling	kW	50.5	52.2	53.5
	Heating	kW	50.1	52.6	53.1
EER (Rated)			3.55	3.54	3.56
COP (Rated)			3.58	3.51	3.59
Power Factor	Rated	-	0.93	0.93	0.93
Exterior	Casing Color		Warm Gray / Dawn Gray	Warm Gray / Dawn Gray	Warm Gray / Dawn Gray
	RAL code		RAL7038 / RAL 7037	RAL7038 / RAL 7037	RAL7038 / RAL 7037
Heat Exchanger			Wide Louver Plus	Wide Louver Plus	Wide Louver Plus
Compressor	Motor Output x Number	W x No.	5,300 x 5	5,300 x 5	5,300 x 5
	Type		Propeller fan	Propeller fan	Propeller fan
Fan	Motor Output x Number	W	(900 x 4) + (1,500 x 1)	(900 x 4) + (1,500 x 1)	900 x 6
	Air Flow Rate (High)	m ³ /min	(320 x 2) + (240 x 1)	(320 x 2) + (240 x 1)	320 x 3
		ft ³ /min	(11,301 x 2) + (8,476 x 1)	(11,301 x 2) + (8,476 x 1)	11,301 x 3
	Drive		DC INVERTER	DC INVERTER	DC INVERTER
Discharge	Side / Top	TOP	TOP	TOP	
Pipe Connections For Heat Pump	Liquid Pipe	mm (inch)	22.2 (7/8)	22.2 (7/8)	22.2 (7/8)
	Gas Pipe	mm (inch)	41.3 (1-5/8)	53.98 (2-1/8)	53.98 (2-1/8)
Dimensions (W x H x D)	mm x No.		(1,240 x 1,690 x 760) x 2 + (930 x 1,690 x 760) x 1	(1,240 x 1,690 x 760) x 2 + (930 x 1,690 x 760) x 1	(1,240 x 1,690 x 760) x 3
Net Weight	kg		(268) + (268) + (172)	(268) + (268) + (184)	(268) + (268) + (205)
Sound Pressure Level	Cooling	dB(A)	68.5	68.6	68.7
	Heating	dB(A)	70.4	70.5	70.6
Communication Cable	mm ² x No. (VCTF-SB)		1.0 - 1.5 x 2C	1.0 - 1.5 x 2C	1.0 - 1.5 x 2C
Refrigerant	Refrigerant Name		R410A	R410A	R410A
	Precharged Amount in Factory	kg	26.7	29.5	28.5
	GWP		2,087.5	2,087.5	2,087.5
	t-CO ₂ eq		55.7	61.6	59.5
Control			Electronic Expansion Valve	Electronic Expansion Valve	Electronic Expansion Valve
Power Supply	Ø, V, Hz		3, 380-415, 50	3, 380-415, 50	3, 380-415, 50
			3, 380, 60	3, 380, 60	3, 380, 60
Number of Maximum Connectable Indoor Units			64	64	64

1. Due to our policy of innovation some specifications may be changed without notification.
 2. Wiring cable size must comply with the applicable local and national codes. And "Electric characteristics" chapter should be considered for electrical work and design. Especially the power cable and circuit breaker should be selected in accordance with that.
 3. Power factor could vary less than ±1% according to the operating conditions.
 4. Sound pressure level is measured on the rated condition in the anechoic rooms by ISO 3745 standard. Sound power level is measured on the rated condition in the reverberation rooms by ISO 9614 standard. Therefore, these values can be increased owing to ambient conditions during operation.
 5. Performances are based on the following conditions - Cooling : Indoor Ambient Temp. 27°CDB / 19°CWB, Outdoor Ambient Temp. 35°CDB / 24°CWB
 - Heating : Indoor Ambient Temp. 20°CDB / 15°CWB, Outdoor Ambient Temp. 7°CDB / 6°CWB
 Interconnected Pipe Length is 7.5m and difference of Elevation (Outdoor - Indoor Unit) is Zero.
 6. The numbers in parentheses means maximum connectable indoor units in accordance with outdoor units combination. The recommended ratio is 130%.
 7. This product contains Fluorinated greenhouse gases. (R410A, GWP(Global warming potential) = 2087.5)

MULTI V 5 PRO

ARUN700LLS5 / ARUN720LLS5
ARUN740LLS5



HP			70	72	74
Model Name	Combination Unit		ARUN700LLS5	ARUN720LLS5	ARUN740LLS5
	Independent Unit		ARUN260LLS5 ARUN260LLS5 ARUN180LLS5	ARUN260LLS5 ARUN260LLS5 ARUN200LLS5	ARUN260LLS5 ARUN260LLS5 ARUN220LLS5
Capacity	Cooling (Rated)	kW	196.0	201.6	207.2
		Btu/h	668,800	687,900	707,000
Capacity	Heating (Rated)	kW	196.0	201.6	207.2
		Btu/h	668,800	687,900	707,000
Input (Rated)	Cooling	kW	53.9	55.7	58.4
	Heating	kW	53.1	55.5	58.8
EER (Rated)			3.64	3.62	3.55
COP (Rated)			3.69	3.63	3.52
Power Factor	Rated	-	0.93	0.93	0.93
Exterior	Casing Color		Warm Gray / Dawn Gray	Warm Gray / Dawn Gray	Warm Gray / Dawn Gray
	RAL code		RAL7038 / RAL 7037	RAL7038 / RAL 7037	RAL7038 / RAL 7037
Heat Exchanger			Wide Louver Plus	Wide Louver Plus	Wide Louver Plus
Compressor	Motor Output x Number	W x No.	(5,300 x 4) + (7,500 x 1)	(5,300 x 4) + (7,500 x 1)	(5,300 x 4) + (7,500 x 1)
	Type		Propeller fan	Propeller fan	Propeller fan
Fan	Motor Output x Number	W	900 x 6	900 x 6	900 x 6
	Air Flow Rate (High)	m ³ /min	320 x 3	320 x 3	320 x 3
		ft ³ /min	11,301 x 3	11,301 x 3	11,301 x 3
	Drive		DC INVERTER	DC INVERTER	DC INVERTER
Discharge	Side / Top	TOP	TOP	TOP	
Pipe Connections For Heat Pump	Liquid Pipe	mm (inch)	22.2 (7/8)	22.2 (7/8)	22.2 (7/8)
	Gas Pipe	mm (inch)	53.98 (2-1/8)	53.98 (2-1/8)	53.98 (2-1/8)
Dimensions (W x H x D)	mm x No.		(1,240 x 1,690 x 760) x 3	(1,240 x 1,690 x 760) x 3	(1,240 x 1,690 x 760) x 3
Net Weight	kg		(268) + (268) + (230)	(268) + (268) + (230)	(268) + (268) + (230)
Sound Pressure Level	Cooling	dB(A)	69.0	69.2	69.5
	Heating	dB(A)	71.1	71.5	71.8
Communication Cable		mm ² x No. (VCTF-SB)	1.0 - 1.5 x 2C	1.0 - 1.5 x 2C	1.0 - 1.5 x 2C
Refrigerant	Refrigerant Name		R410A	R410A	R410A
	Precharged Amount in Factory	kg	29.5	29.5	29.5
	GWP		2,087.5	2,087.5	2,087.5
	t-CO ₂ eq		61.6	61.6	61.6
Control			Electronic Expansion Valve	Electronic Expansion Valve	Electronic Expansion Valve
Power Supply		∅, V, Hz	3, 380-415, 50	3, 380-415, 50	3, 380-415, 50
			3, 380, 60	3, 380, 60	3, 380, 60
Number of Maximum Connectable Indoor Units			64	64	64

1. Due to our policy of innovation some specifications may be changed without notification.
 2. Wiring cable size must comply with the applicable local and national codes. And "Electric characteristics" chapter should be considered for electrical work and design. Especially the power cable and circuit breaker should be selected in accordance with that.
 3. Power factor could vary less than ±1% according to the operating conditions.
 4. Sound pressure level is measured on the rated condition in the anechoic rooms by ISO 3745 standard. Sound power level is measured on the rated condition in the reverberation rooms by ISO 9614 standard. Therefore, these values can be increased owing to ambient conditions during operation.
 5. Performances are based on the following conditions - Cooling : Indoor Ambient Temp. 27°CDB / 19°CWB, Outdoor Ambient Temp. 35°CDB / 24°CWB
 - Heating : Indoor Ambient Temp. 20°CDB / 15°CWB, Outdoor Ambient Temp. 7°CDB / 6°CWB
 Interconnected Pipe Length is 7.5m and difference of Elevation (Outdoor - Indoor Unit) is Zero.
 6. The numbers in parentheses means maximum connectable indoor units in accordance with outdoor units combination. The recommended ratio is 130%.
 7. This product contains Fluorinated greenhouse gases. (R410A, GWP(Global warming potential) = 2087.5)

MULTI V 5 PRO

ARUN760LLS5 / ARUN780LLS5
ARUN800LLS5



HP			76	78	80
Model Name	Combination Unit		ARUN760LLS5	ARUN780LLS5	ARUN800LLS5
	Independent Unit		ARUN260LLS5 ARUN260LLS5 ARUN240LLS5	ARUN260LLS5 ARUN260LLS5 ARUN260LLS5	ARUN260LLS5 ARUN260LLS5 ARUN160LLS5 ARUN120LLS5
Capacity	Cooling (Rated)	kW	212.8	218.4	224.0
		Btu/h	726,100	745,200	764,300
Capacity	Heating (Rated)	kW	212.8	218.4	224.0
		Btu/h	726,100	745,200	764,300
Input (Rated)	Cooling	kW	59.8	62.4	62.4
	Heating	kW	58.9	61.5	62.2
EER (Rated)			3.56	3.50	3.59
COP (Rated)			3.61	3.55	3.60
Power Factor	Rated	-	0.93	0.93	0.93
Exterior	Casing Color		Warm Gray / Dawn Gray	Warm Gray / Dawn Gray	Warm Gray / Dawn Gray
	RAL code		RAL7038 / RAL 7037	RAL7038 / RAL 7037	RAL7038 / RAL 7037
Heat Exchanger			Wide Louver Plus	Wide Louver Plus	Wide Louver Plus
Compressor	Motor Output x Number	W x No.	5,300 x 6	5,300 x 6	5,300 x 6
	Type		Propeller fan	Propeller fan	Propeller fan
Fan	Motor Output x Number	W	900 x 6	900 x 6	(900 x 6) + (1,500 x 1)
	Air Flow Rate (High)	m ³ /min	320 x 3	320 x 3	(320 x 3) + (240 x 1)
		ft ³ /min	11,301 x 3	11,301 x 3	(11,301 x 3) + (8,476 x 1)
	Drive		DC INVERTER	DC INVERTER	DC INVERTER
Discharge	Side / Top	TOP	TOP	TOP	
Pipe Connections For Heat Pump	Liquid Pipe	mm (inch)	22.2 (7/8)	22.2 (7/8)	22.2 (7/8)
	Gas Pipe	mm (inch)	53.98 (2-1/8)	53.98 (2-1/8)	53.98 (2-1/8)
Dimensions (W x H x D)	mm x No.		(1,240 x 1,690 x 760) x 3	(1,240 x 1,690 x 760) x 3	(1,240 x 1,690 x 760) x 3 + (930 x 1,690 x 760) x 1
Net Weight	kg		(268) + (268) + (268)	(268) + (268) + (268)	(268) + (268) + (205) + (172)
Sound Pressure Level	Cooling	dB(A)	69.8	69.8	69.2
	Heating	dB(A)	71.8	71.8	70.9
Communication Cable		mm ² x No. (VCTF-SB)	1.0 - 1.5 x 2C	1.0 - 1.5 x 2C	1.0 - 1.5 x 2C
Refrigerant	Refrigerant Name		R410A	R410A	R410A
	Precharged Amount in Factory	kg	33.0	33.0	33.2
	GWP		2,087.5	2,087.5	2,087.5
	t-CO ₂ eq		68.9	68.9	69.3
Control			Electronic Expansion Valve	Electronic Expansion Valve	Electronic Expansion Valve
Power Supply		∅, V, Hz	3, 380-415, 50	3, 380-415, 50	3, 380-415, 50
			3, 380, 60	3, 380, 60	3, 380, 60
Number of Maximum Connectable Indoor Units			64	64	64

1. Due to our policy of innovation some specifications may be changed without notification.
 2. Wiring cable size must comply with the applicable local and national codes. And "Electric characteristics" chapter should be considered for electrical work and design. Especially the power cable and circuit breaker should be selected in accordance with that.
 3. Power factor could vary less than ±1% according to the operating conditions.
 4. Sound pressure level is measured on the rated condition in the anechoic rooms by ISO 3745 standard. Sound power level is measured on the rated condition in the reverberation rooms by ISO 9614 standard. Therefore, these values can be increased owing to ambient conditions during operation.
 5. Performances are based on the following conditions - Cooling : Indoor Ambient Temp. 27°CDB / 19°CWB, Outdoor Ambient Temp. 35°CDB / 24°CWB
 - Heating : Indoor Ambient Temp. 20°CDB / 15°CWB, Outdoor Ambient Temp. 7°CDB / 6°CWB
 Interconnected Pipe Length is 7.5m and difference of Elevation (Outdoor - Indoor Unit) is Zero.
 6. The numbers in parentheses means maximum connectable indoor units in accordance with outdoor units combination. The recommended ratio is 130%.
 7. This product contains Fluorinated greenhouse gases. (R410A, GWP(Global warming potential) = 2087.5)

MULTI V 5 PRO

ARUN820LLS5 / ARUN840LLS5
ARUN860LLS5



HP			82	84	86
Model Name	Combination Unit		ARUN820LLS5	ARUN840LLS5	ARUN860LLS5
	Independent Unit		ARUN260LLS5 ARUN260LLS5 ARUN180LLS5 ARUN120LLS5	ARUN260LLS5 ARUN260LLS5 ARUN200LLS5 ARUN120LLS5	ARUN260LLS5 ARUN260LLS5 ARUN220LLS5 ARUN120LLS5
Capacity	Cooling (Rated)	kW	229.6	235.2	240.8
		Btu/h	783,400	802,500	821,600
	Heating (Rated)	kW	229.6	235.2	240.8
		Btu/h	783,400	802,500	821,600
Input (Rated)	Cooling	kW	62.8	64.6	67.3
	Heating	kW	62.2	64.6	67.9
EER (Rated)			3.66	3.64	3.58
COP (Rated)			3.69	3.64	3.55
Power Factor	Rated	-	0.93	0.93	0.93
Exterior	Casing Color		Warm Gray / Dawn Gray	Warm Gray / Dawn Gray	Warm Gray / Dawn Gray
	RAL code		RAL7038 / RAL 7037	RAL7038 / RAL 7037	RAL7038 / RAL 7037
Heat Exchanger			Wide Louver Plus	Wide Louver Plus	Wide Louver Plus
Compressor	Motor Output x Number	W x No.	(5,300 x 5) + (7,500 x 1)	(5,300 x 5) + (7,500 x 1)	(5,300 x 5) + (7,500 x 1)
	Type		Propeller fan	Propeller fan	Propeller fan
Fan	Motor Output x Number	W	(900 x 6) + (1,500 x 1)	(900 x 6) + (1,500 x 1)	(900 x 6) + (1,500 x 1)
	Air Flow Rate (High)	m ³ /min	(320 x 3) + (240 x 1)	(320 x 3) + (240 x 1)	(320 x 3) + (240 x 1)
		ft ³ /min	(11,301 x 3) + (8,476 x 1)	(11,301 x 3) + (8,476 x 1)	(11,301 x 3) + (8,476 x 1)
	Drive		DC INVERTER	DC INVERTER	DC INVERTER
Discharge	Side / Top		TOP	TOP	TOP
Pipe Connections For Heat Pump	Liquid Pipe	mm (inch)	22.2 (7/8)	22.2 (7/8)	22.2 (7/8)
	Gas Pipe	mm (inch)	53.98 (2-1/8)	53.98 (2-1/8)	53.98 (2-1/8)
Dimensions (W x H x D)		mm x No.	(1,240 x 1,690 x 760) x 3 + (930 x 1,690 x 760) x 1	(1,240 x 1,690 x 760) x 3 + (930 x 1,690 x 760) x 1	(1,240 x 1,690 x 760) x 3 + (930 x 1,690 x 760) x 1
Net Weight		kg	(268) + (268) + (230) + (172)	(268) + (268) + (230) + (172)	(268) + (268) + (268) + (172)
Sound Pressure Level	Cooling	dB(A)	69.4	69.6	69.8
	Heating	dB(A)	71.4	71.8	72.1
Communication Cable		mm ² x No. (VCTF-SB)	1.0 - 1.5 x 2C	1.0 - 1.5 x 2C	1.0 - 1.5 x 2C
Refrigerant	Refrigerant Name		R410A	R410A	R410A
	Precharged Amount in Factory	kg	34.2	34.2	34.2
	GWP		2,087.5	2,087.5	2,087.5
	t-CO ₂ eq		71.4	71.4	71.4
	Control		Electronic Expansion Valve	Electronic Expansion Valve	Electronic Expansion Valve
Power Supply		Ø, V, Hz	3, 380-415, 50	3, 380-415, 50	3, 380-415, 50
			3, 380, 60	3, 380, 60	3, 380, 60
Number of Maximum Connectable Indoor Units			64	64	64

1. Due to our policy of innovation some specifications may be changed without notification.
 2. Wiring cable size must comply with the applicable local and national codes. And "Electric characteristics" chapter should be considered for electrical work and design. Especially the power cable and circuit breaker should be selected in accordance with that.
 3. Power factor could vary less than ±1% according to the operating conditions.
 4. Sound pressure level is measured on the rated condition in the anechoic rooms by ISO 3745 standard. Sound power level is measured on the rated condition in the reverberation rooms by ISO 9614 standard. Therefore, these values can be increased owing to ambient conditions during operation.
 5. Performances are based on the following conditions - Cooling : Indoor Ambient Temp. 27°CDB / 19°CWB, Outdoor Ambient Temp. 35°CDB / 24°CWB
 - Heating : Indoor Ambient Temp. 20°CDB / 15°CWB, Outdoor Ambient Temp. 7°CDB / 6°CWB
 Interconnected Pipe Length is 7.5m and difference of Elevation (Outdoor - Indoor Unit) is Zero.
 6. The numbers in parentheses means maximum connectable indoor units in accordance with outdoor units combination. The recommended ratio is 130%.
 7. This product contains Fluorinated greenhouse gases. (R410A, GWP(Global warming potential) = 2087.5)

MULTI V 5 PRO

ARUN880LLS5 / ARUN900LLS5
ARUN920LLS5



HP			88	90	92
Model Name	Combination Unit		ARUN880LLS5	ARUN900LLS5	ARUN920LLS5
	Independent Unit		ARUN260LLS5 ARUN260LLS5 ARUN240LLS5 ARUN120LLS5	ARUN260LLS5 ARUN260LLS5 ARUN260LLS5 ARUN120LLS5	ARUN260LLS5 ARUN260LLS5 ARUN260LLS5 ARUN140LLS5
Capacity	Cooling (Rated)	kW	246.4	252.0	257.6
		Btu/h	840,700	859,800	879,000
	Heating (Rated)	kW	246.4	252.0	257.6
		Btu/h	840,700	859,800	879,000
Input (Rated)	Cooling	kW	68.7	71.3	73.0
	Heating	kW	68.0	70.6	73.1
EER (Rated)			3.59	3.53	3.53
COP (Rated)			3.62	3.57	3.52
Power Factor	Rated	-	0.93	0.93	0.93
Exterior	Casing Color		Warm Gray / Dawn Gray	Warm Gray / Dawn Gray	Warm Gray / Dawn Gray
	RAL code		RAL7038 / RAL 7037	RAL7038 / RAL 7037	RAL7038 / RAL 7037
Heat Exchanger			Wide Louver Plus	Wide Louver Plus	Wide Louver Plus
Compressor	Motor Output x Number	W x No.	5,300 x 7	5,300 x 7	5,300 x 7
	Type		Propeller fan	Propeller fan	Propeller fan
Fan	Motor Output x Number	W	(900 x 6) + (1,500 x 1)	(900 x 6) + (1,500 x 1)	(900 x 6) + (1,500 x 1)
	Air Flow Rate (High)	m ³ /min	(320 x 3) + (240 x 1)	(320 x 3) + (240 x 1)	(320 x 3) + (240 x 1)
		ft ³ /min	(11,301 x 3) + (8,476 x 1)	(11,301 x 3) + (8,476 x 1)	(11,301 x 3) + (8,476 x 1)
	Drive		DC INVERTER	DC INVERTER	DC INVERTER
Discharge	Side / Top		TOP	TOP	TOP
Pipe Connections For Heat Pump	Liquid Pipe	mm (inch)	22.2 (7/8)	22.2 (7/8)	22.2 (7/8)
	Gas Pipe	mm (inch)	53.98 (2-1/8)	53.98 (2-1/8)	53.98 (2-1/8)
Dimensions (W x H x D)		mm x No.	(1,240 x 1,690 x 760) x 3 + (930 x 1,690 x 760) x 1	(1,240 x 1,690 x 760) x 3 + (930 x 1,690 x 760) x 1	(1,240 x 1,690 x 760) x 3 + (930 x 1,690 x 760) x 1
Net Weight		kg	(268) + (268) + (230) + (172)	(268) + (268) + (268) + (172)	(268) + (268) + (268) + (184)
Sound Pressure Level	Cooling	dB(A)	70.1	70.1	70.2
	Heating	dB(A)	72.1	72.1	72.1
Communication Cable		mm ² x No. (VCTF-SB)	1.0 - 1.5 x 2C	1.0 - 1.5 x 2C	1.0 - 1.5 x 2C
Refrigerant	Refrigerant Name		R410A	R410A	R410A
	Precharged Amount in Factory	kg	37.7	37.7	40.5
	GWP		2,087.5	2,087.5	2,087.5
	t-CO ₂ eq		78.7	78.7	84.5
	Control		Electronic Expansion Valve	Electronic Expansion Valve	Electronic Expansion Valve
Power Supply		Ø, V, Hz	3, 380-415, 50	3, 380-415, 50	3, 380-415, 50
			3, 380, 60	3, 380, 60	3, 380, 60
Number of Maximum Connectable Indoor Units			64	64	64

1. Due to our policy of innovation some specifications may be changed without notification.
 2. Wiring cable size must comply with the applicable local and national codes. And "Electric characteristics" chapter should be considered for electrical work and design. Especially the power cable and circuit breaker should be selected in accordance with that.
 3. Power factor could vary less than ±1% according to the operating conditions.
 4. Sound pressure level is measured on the rated condition in the anechoic rooms by ISO 3745 standard. Sound power level is measured on the rated condition in the reverberation rooms by ISO 9614 standard. Therefore, these values can be increased owing to ambient conditions during operation.
 5. Performances are based on the following conditions - Cooling : Indoor Ambient Temp. 27°CDB / 19°CWB, Outdoor Ambient Temp. 35°CDB / 24°CWB
 - Heating : Indoor Ambient Temp. 20°CDB / 15°CWB, Outdoor Ambient Temp. 7°CDB / 6°CWB
 Interconnected Pipe Length is 7.5m and difference of Elevation (Outdoor - Indoor Unit) is Zero.
 6. The numbers in parentheses means maximum connectable indoor units in accordance with outdoor units combination. The recommended ratio is 130%.
 7. This product contains Fluorinated greenhouse gases. (R410A, GWP(Global warming potential) = 2087.5)

MULTI V 5 PRO

ARUN940LLS5 / ARUN960LLS5
ARUN980LLS5



HP			94	96	98
Model Name	Combination Unit		ARUN940LLS5	ARUN960LLS5	ARUN980LLS5
	Independent Unit		ARUN260LLS5 ARUN260LLS5 ARUN260LLS5 ARUN160LLS5	ARUN260LLS5 ARUN260LLS5 ARUN260LLS5 ARUN180LLS5	ARUN260LLS5 ARUN260LLS5 ARUN260LLS5 ARUN200LLS5
Capacity	Cooling (Rated)	kW	263.2	268.8	274.4
		Btu/h	898,100	917,200	936,300
	Heating (Rated)	kW	263.2	268.8	274.4
		Btu/h	898,100	917,200	936,300
Input (Rated)	Cooling	kW	74.3	74.7	76.5
	Heating	kW	73.6	73.6	76.0
EER (Rated)			3.54	3.60	3.59
COP (Rated)			3.58	3.65	3.61
Power Factor	Rated	-	0.93	0.93	0.93
Exterior	Casing Color		Warm Gray / Dawn Gray	Warm Gray / Dawn Gray	Warm Gray / Dawn Gray
	RAL code		RAL7038 / RAL 7037	RAL7038 / RAL 7037	RAL7038 / RAL 7037
Heat Exchanger			Wide Louver Plus	Wide Louver Plus	Wide Louver Plus
Compressor	Motor Output x Number	W x No.	5,300 x 7	(5,300 x 6) + (7,500 x 1)	(5,300 x 6) + (7,500 x 1)
	Type		Propeller fan	Propeller fan	Propeller fan
Fan	Motor Output x Number	W	900 x 8	900 x 8	900 x 8
	Air Flow Rate (High)	m ³ /min	320 x 4	320 x 4	320 x 4
		ft ³ /min	11,301 x 4	11,301 x 4	11,301 x 4
	Drive		DC INVERTER	DC INVERTER	DC INVERTER
Discharge	Side / Top	TOP	TOP	TOP	
Pipe Connections For Heat Pump	Liquid Pipe	mm (inch)	22.2 (7/8)	22.2 (7/8)	22.2 (7/8)
	Gas Pipe	mm (inch)	53.98 (2-1/8)	53.98 (2-1/8)	53.98 (2-1/8)
Dimensions (W x H x D)	mm x No.		(1,240 x 1,690 x 760) x 4	(1,240 x 1,690 x 760) x 4	(1,240 x 1,690 x 760) x 4
Net Weight	kg		(268) + (268) + (268) + (205)	(268) + (268) + (268) + (230)	(268) + (268) + (268) + (230)
Sound Pressure Level	Cooling	dB(A)	70.3	70.4	70.6
	Heating	dB(A)	72.2	72.5	72.8
Communication Cable	mm ² x No. (VCTF-SB)		1.0 - 1.5 x 2C	1.0 - 1.5 x 2C	1.0 - 1.5 x 2C
Refrigerant	Refrigerant Name		R410A	R410A	R410A
	Precharged Amount in Factory	kg	39.5	40.5	40.5
	GWP		2,087.5	2,087.5	2,087.5
	t-CO ₂ eq		82.5	84.5	84.5
	Control		Electronic Expansion Valve	Electronic Expansion Valve	Electronic Expansion Valve
Power Supply	∅, V, Hz		3, 380-415, 50	3, 380-415, 50	3, 380-415, 50
Number of Maximum Connectable Indoor Units			64	64	64

1. Due to our policy of innovation some specifications may be changed without notification.
 2. Wiring cable size must comply with the applicable local and national codes. And "Electric characteristics" chapter should be considered for electrical work and design. Especially the power cable and circuit breaker should be selected in accordance with that.
 3. Power factor could vary less than ±1% according to the operating conditions.
 4. Sound pressure level is measured on the rated condition in the anechoic rooms by ISO 3745 standard. Sound power level is measured on the rated condition in the reverberation rooms by ISO 9614 standard. Therefore, these values can be increased owing to ambient conditions during operation.
 5. Performances are based on the following conditions - Cooling : Indoor Ambient Temp. 27°CDB / 19°CWB, Outdoor Ambient Temp. 35°CDB / 24°CWB
 - Heating : Indoor Ambient Temp. 20°CDB / 15°CWB, Outdoor Ambient Temp. 7°CDB / 6°CWB
 Interconnected Pipe Length is 7.5m and difference of Elevation (Outdoor - Indoor Unit) is Zero.
 6. The numbers in parentheses means maximum connectable indoor units in accordance with outdoor units combination. The recommended ratio is 130%.
 7. This product contains Fluorinated greenhouse gases. (R410A, GWP(Global warming potential) = 2087.5)

MULTI V 5 PRO

ARUN1000LLS5 / ARUN1020LLS5
ARUN1040LLS5



HP			100	102	104
Model Name	Combination Unit		ARUN1000LLS5	ARUN1020LLS5	ARUN1040LLS5
	Independent Unit		ARUN260LLS5 ARUN260LLS5 ARUN260LLS5 ARUN220LLS5	ARUN260LLS5 ARUN260LLS5 ARUN260LLS5 ARUN240LLS5	ARUN260LLS5 ARUN260LLS5 ARUN260LLS5 ARUN260LLS5
Capacity	Cooling (Rated)	kW	280.0	285.6	291.2
		Btu/h	955,400	974,500	993,600
	Heating (Rated)	kW	280.0	285.6	291.2
		Btu/h	955,400	974,500	993,600
Input (Rated)	Cooling	kW	79.2	80.6	83.2
	Heating	kW	79.3	79.4	82.0
EER (Rated)			3.54	3.54	3.50
COP (Rated)			3.53	3.60	3.55
Power Factor	Rated	-	0.93	0.93	0.93
Exterior	Casing Color		Warm Gray / Dawn Gray	Warm Gray / Dawn Gray	Warm Gray / Dawn Gray
	RAL code		RAL7038 / RAL 7037	RAL7038 / RAL 7037	RAL7038 / RAL 7037
Heat Exchanger			Wide Louver Plus	Wide Louver Plus	Wide Louver Plus
Compressor	Motor Output x Number	W x No.	(5,300 x 6) + (7,500 x 1)	5,300 x 8	5,300 x 8
	Type		Propeller fan	Propeller fan	Propeller fan
Fan	Motor Output x Number	W	900 x 8	900 x 8	900 x 8
	Air Flow Rate (High)	m ³ /min	320 x 4	320 x 4	320 x 4
		ft ³ /min	11,301 x 4	11,301 x 4	11,301 x 4
	Drive		DC INVERTER	DC INVERTER	DC INVERTER
Discharge	Side / Top	TOP	TOP	TOP	
Pipe Connections For Heat Pump	Liquid Pipe	mm (inch)	22.2 (7/8)	22.2 (7/8)	22.2 (7/8)
	Gas Pipe	mm (inch)	53.98 (2-1/8)	53.98 (2-1/8)	53.98 (2-1/8)
Dimensions (W x H x D)	mm x No.		(1,240 x 1,690 x 760) x 4	(1,240 x 1,690 x 760) x 4	(1,240 x 1,690 x 760) x 4
Net Weight	kg		(268) + (268) + (268) + (230)	(268) + (268) + (268) + (268)	(268) + (268) + (268) + (268)
Sound Pressure Level	Cooling	dB(A)	70.8	71.0	71.0
	Heating	dB(A)	73.0	73.0	73.0
Communication Cable	mm ² x No. (VCTF-SB)		1.0 - 1.5 x 2C	1.0 - 1.5 x 2C	1.0 - 1.5 x 2C
Refrigerant	Refrigerant Name		R410A	R410A	R410A
	Precharged Amount in Factory	kg	40.5	44.0	44.0
	GWP		2,087.5	2,087.5	2,087.5
	t-CO ₂ eq		84.5	91.9	91.9
	Control		Electronic Expansion Valve	Electronic Expansion Valve	Electronic Expansion Valve
Power Supply	∅, V, Hz		3, 380-415, 50	3, 380-415, 50	3, 380-415, 50
Number of Maximum Connectable Indoor Units			64	64	64

1. Due to our policy of innovation some specifications may be changed without notification.
 2. Wiring cable size must comply with the applicable local and national codes. And "Electric characteristics" chapter should be considered for electrical work and design. Especially the power cable and circuit breaker should be selected in accordance with that.
 3. Power factor could vary less than ±1% according to the operating conditions.
 4. Sound pressure level is measured on the rated condition in the anechoic rooms by ISO 3745 standard. Sound power level is measured on the rated condition in the reverberation rooms by ISO 9614 standard. Therefore, these values can be increased owing to ambient conditions during operation.
 5. Performances are based on the following conditions - Cooling : Indoor Ambient Temp. 27°CDB / 19°CWB, Outdoor Ambient Temp. 35°CDB / 24°CWB
 - Heating : Indoor Ambient Temp. 20°CDB / 15°CWB, Outdoor Ambient Temp. 7°CDB / 6°CWB
 Interconnected Pipe Length is 7.5m and difference of Elevation (Outdoor - Indoor Unit) is Zero.
 6. The numbers in parentheses means maximum connectable indoor units in accordance with outdoor units combination. The recommended ratio is 130%.
 7. This product contains Fluorinated greenhouse gases. (R410A, GWP(Global warming potential) = 2087.5)

ARUN080LLS5 / ARUN100LLS5 / ARUN120LLS5 / ARUN140LLS5

[Unit: mm]
 Gravity point

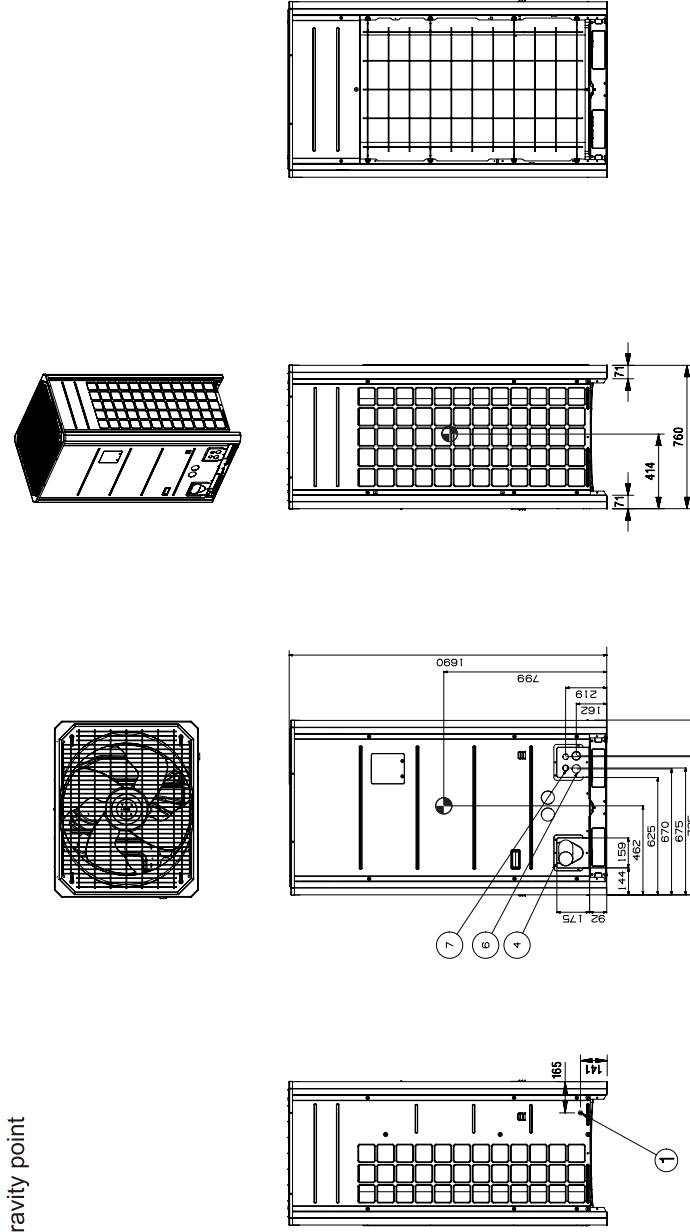

Note
 1. Unit should be installed in compliance with the installation manual in the product box.
 2. Unit should be grounded in accordance with the local regulations or applicable national codes.
 3. All electrical components and materials to be supplied from the site must comply with the local regulations or international codes.
 4. Electrical characteristics chapter should be considered for electrical work and design. Especially the power cable and circuit breaker should be selected in accordance with that.

No.	Part Name	Description
7	Wire routing hole(front)	2- \varnothing 30
6	Power cord routing hole(front)	2- \varnothing 45
5	Pipe routing hole(bottom)	2- \varnothing 66, \varnothing 53.88
4	Pipe routing hole(front)	-
3	Power cord routing hole(bottom)	2- \varnothing 50
2	Wire routing hole(bottom)	2- \varnothing 22.2
1	Leakage test hole(side)	\varnothing 22.2

ARUN160LLS5 / ARUN180LLS5 / ARUN200LLS5 / ARUN220LLS5
 ARUN240LLS5 / ARUN260LLS5

[Unit: mm]
 Gravity point

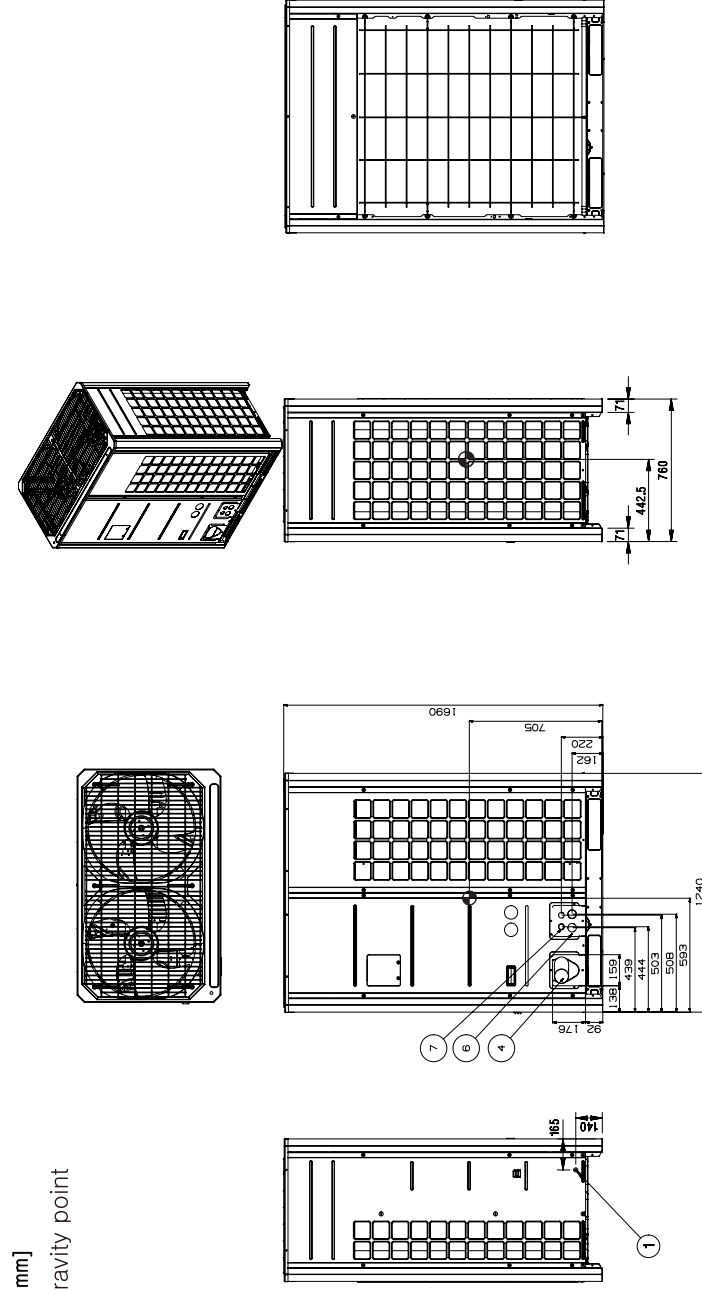

Note
 1. Unit should be installed in compliance with the installation manual in the product box.
 2. Unit should be grounded in accordance with the local regulations or applicable national codes.
 3. All electrical components and materials to be supplied from the site must comply with the local regulations or international codes.
 4. Electrical characteristics chapter should be considered for electrical work and design. Especially the power cable and circuit breaker should be selected in accordance with that.

No.	Part Name	Description
7	Wire routing hole(front)	2- \varnothing 30
6	Power cord routing hole(front)	2- \varnothing 45
5	Pipe routing hole(bottom)	2- \varnothing 66, \varnothing 53.88
4	Pipe routing hole(front)	-
3	Power cord routing hole(bottom)	2- \varnothing 50
2	Wire routing hole(bottom)	2- \varnothing 22.2
1	Leakage test hole(side)	\varnothing 22.2

Example Connection of Communication Cable

Single Outdoor Unit

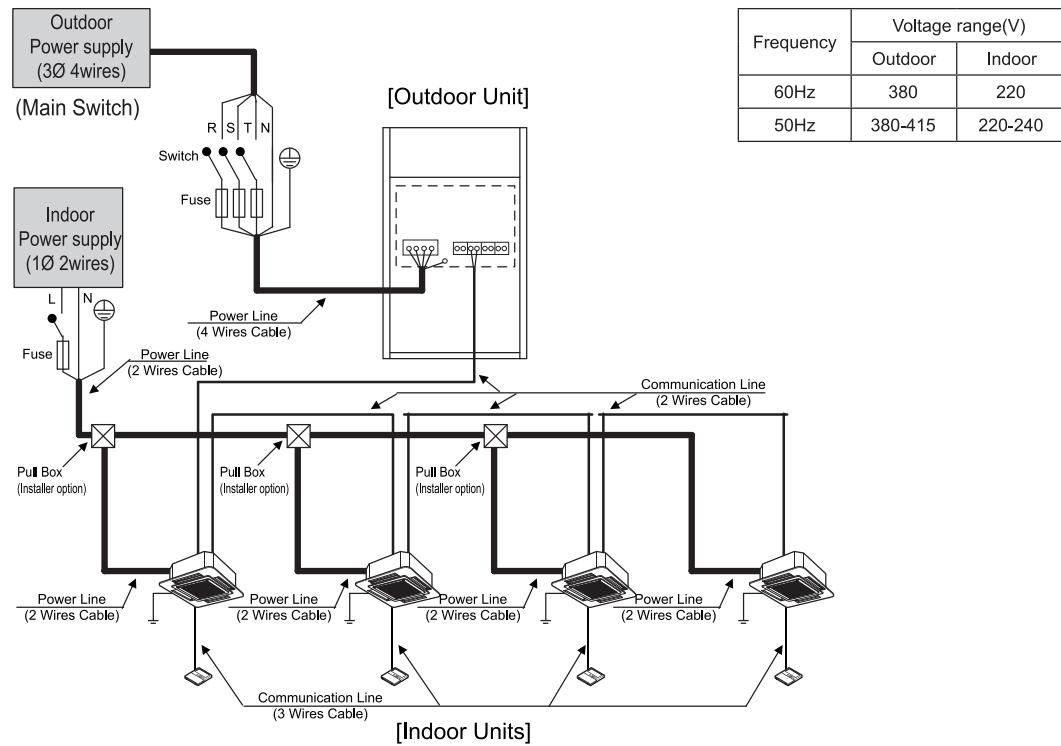

WARNING

- Installation site must require attachment of an earth leakage breaker. If no earth leakage breaker is installed, it may cause an electric shock.
 - Indoor Unit ground Lines are required for preventing electrical shock accident during current leakage, Communication disorder by noise effect and motor current leakage (without connection to pipe).
 - Don't install an individual switch or electrical outlet to disconnect each of indoor unit separately from the power supply.
- If individual power supply is necessary for each indoor unit, IPM (Independent Power Module) should be applied at each indoor unit. (optional)
- Install the main switch that can interrupt all the power sources in an integrated manner because this system consists of the equipment utilizing the multiple power sources.
 - If there exists the possibility of reversed phase, lose phase, momentary blackout or the power goes on and off while the product is operating, attach a reversed phase protection circuit locally.
- Running the product in reversed phase may break the compressor and other parts.

Between Indoor and Master Outdoor unit

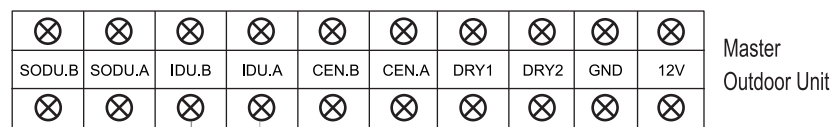

The GND terminal at the main PCB is a '-' terminal for day contact, it is not the point to make ground connection.

Series Outdoor Unit

When the power source is connected In series between the units.

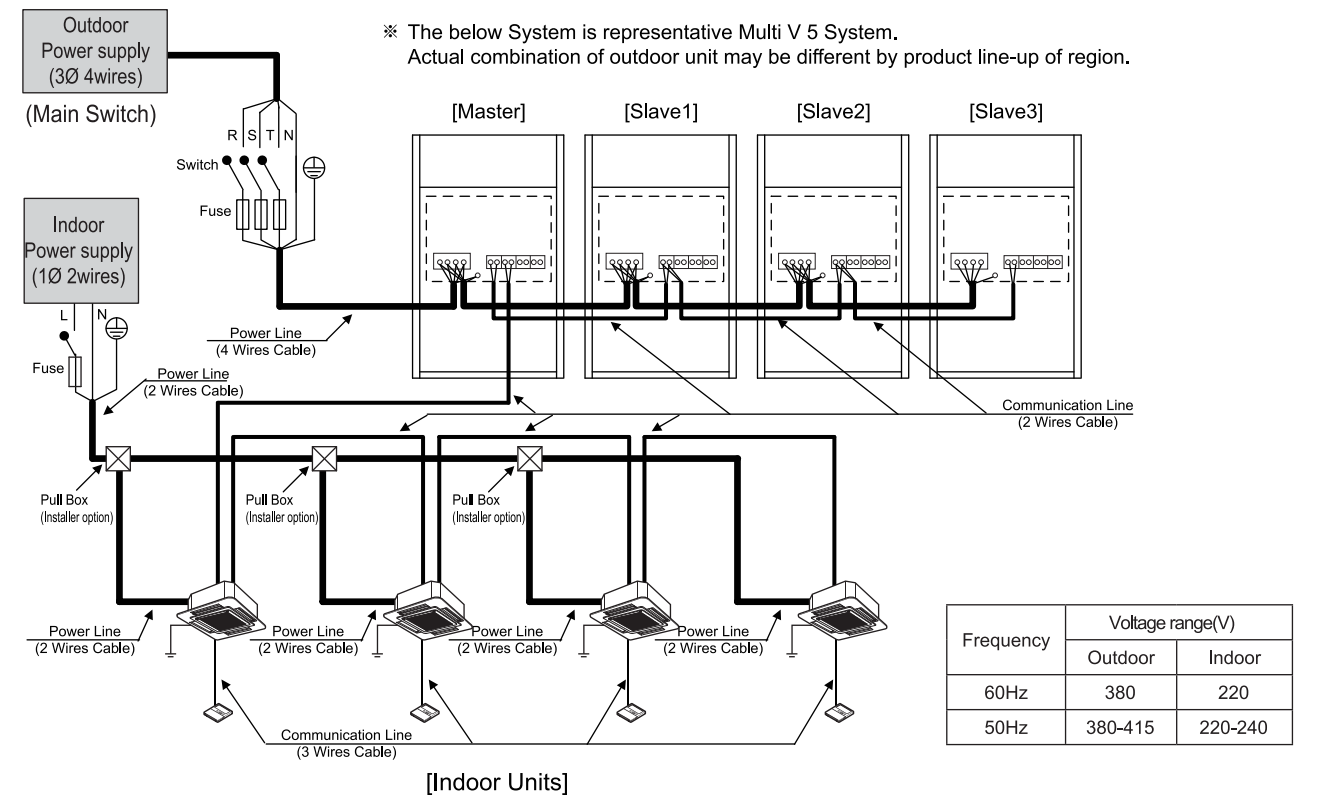

WARNING

When the total capacity is over than 68Hp, do not use single power source for connecting series units. The First terminal block could be burnt out.

When the power source is supplied to Each outdoor unit individually.

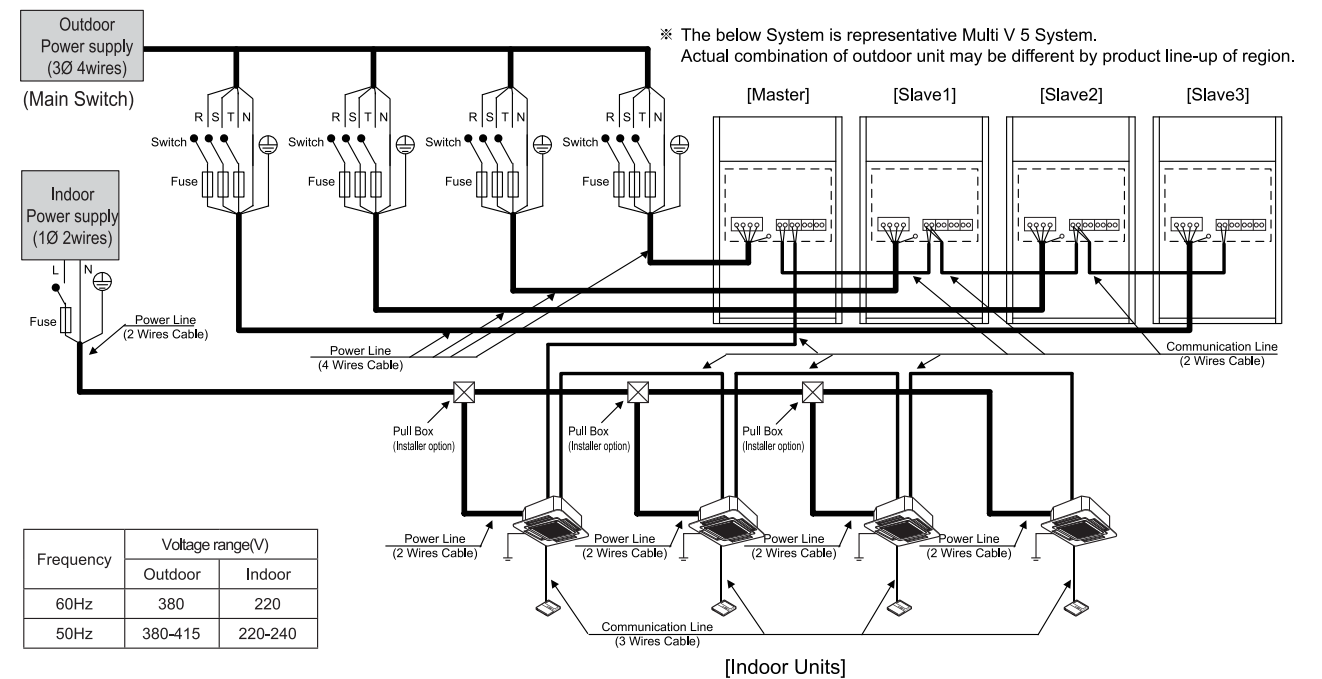

■ 50Hz

Model	Unit			Power Supply			COMP			OFM	
	Hz	Volts	Voltage-range	MCA	TOCA	MFA	MSC	RLA (Cooling)	RLA(Heating)	kW	FLA
8 HP	50	380-415	Min.:342, Max.:456	19.3	20.0	20	4.3	5.8	5.7	1.2	2.5
10 HP	50	380-415	Min.:342, Max.:456	23.3	24.0	25	4.3	8.6	9.1	1.2	2.5
12 HP	50	380-415	Min.:342, Max.:456	25.5	28.0	32	5.9	12.0	12.4	1.2	2.5
14 HP	50	380-415	Min.:342, Max.:456	26.1	29.0	32	5.9	14.8	16.5	1.2	2.5
16 HP	50	380-415	Min.:342, Max.:456	27.3	30.0	32	5.9	16.9	17.3	1.8	2.5
18 HP	50	380-415	Min.:342, Max.:456	31.8	35.0	35	7.5	17.6	17.3	1.8	2.5
20 HP	50	380-415	Min.:342, Max.:456	35.5	39.0	40	7.5	20.5	21.2	1.8	2.5
22 HP	50	380-415	Min.:342, Max.:456	37.8	42.0	45	7.5	24.9	26.6	1.8	2.5
24 HP	50	380-415	Min.:342, Max.:456	50.0	56.0	60	11.8	27.2	26.7	1.8	2.5
26 HP	50	380-415	Min.:342, Max.:456	54.5	60.0	60	11.8	31.5	31.0	1.8	2.5
28 HP	50	380-415	Min.:342, Max.:456	52.7	58.0	60	11.8	29.0	29.6	3.0	5.0
30 HP	50	380-415	Min.:342, Max.:456	57.3	63.0	63	13.4	29.6	29.6	3.0	5.0
32 HP	50	380-415	Min.:342, Max.:456	60.9	67.0	70	13.4	32.6	33.6	3.0	5.0
34 HP	50	380-415	Min.:342, Max.:456	61.8	68.0	70	13.4	36.9	39.0	3.0	5.0
36 HP	50	380-415	Min.:342, Max.:456	76.4	84.0	80	17.7	39.3	39.1	3.0	5.0
38 HP	50	380-415	Min.:342, Max.:456	80.0	88.0	90	17.7	43.5	43.4	3.0	5.0
40 HP	50	380-415	Min.:342, Max.:456	80.9	89.0	90	17.7	46.3	47.4	3.0	5.0
42 HP	50	380-415	Min.:342, Max.:456	81.8	90.0	90	17.7	48.4	48.3	3.6	5.0
44 HP	50	380-415	Min.:342, Max.:456	86.4	95.0	100	19.3	49.1	48.3	3.6	5.0
46 HP	50	380-415	Min.:342, Max.:456	88.4	99.0	100	19.3	52.0	52.2	3.6	5.0
48 HP	50	380-415	Min.:342, Max.:456	92.7	102.0	110	19.3	56.4	57.6	3.6	5.0
50 HP	50	380-415	Min.:342, Max.:456	105.0	116.0	125	23.6	58.7	57.7	3.6	5.0
52 HP	50	380-415	Min.:342, Max.:456	109.1	120.0	125	23.6	63.0	62.0	3.6	5.0
54 HP	50	380-415	Min.:342, Max.:456	107.3	118.0	125	23.6	60.5	60.6	4.8	7.5
56 HP	50	380-415	Min.:342, Max.:456	110.8	123.0	125	25.2	61.1	60.6	4.8	7.5
58 HP	50	380-415	Min.:342, Max.:456	115.5	127.0	150	25.2	64.1	64.5	4.8	7.5
60 HP	50	380-415	Min.:342, Max.:456	117.6	130.0	150	25.2	68.5	69.9	4.8	7.5
62 HP	50	380-415	Min.:342, Max.:456	127.0	141.0	150	29.5	70.7	69.9	4.8	7.5
64 HP	50	380-415	Min.:342, Max.:456	134.5	148.0	150	29.5	75.0	74.4	4.8	7.5
66 HP	50	380-415	Min.:342, Max.:456	134.2	149.0	150	29.5	77.8	78.4	4.8	7.5
68 HP	50	380-415	Min.:342, Max.:456	136.4	150.0	150	29.5	79.9	79.3	5.4	7.5
70 HP	50	380-415	Min.:342, Max.:456	140.9	155.0	150	31.1	80.6	79.3	5.4	7.5
72 HP	50	380-415	Min.:342, Max.:456	143.2	159.0	175	31.1	83.5	83.2	5.4	7.5
74 HP	50	380-415	Min.:342, Max.:456	146.6	162.0	175	31.1	87.9	88.6	5.4	7.5
76 HP	50	380-415	Min.:342, Max.:456	160.0	176.0	175	35.4	90.2	88.7	5.4	7.5
78 HP	50	380-415	Min.:342, Max.:456	163.6	180.0	200	35.4	94.4	93.0	5.4	7.5
80 HP	50	380-415	Min.:342, Max.:456	161.8	178.0	200	35.4	91.9	91.6	6.6	10.0
82 HP	50	380-415	Min.:342, Max.:456	166.4	183.0	200	37.0	92.6	91.6	6.6	10.0
84 HP	50	380-415	Min.:342, Max.:456	168.5	187.0	200	37.0	95.5	95.5	6.6	10.0
86 HP	50	380-415	Min.:342, Max.:456	171.2	190.0	200	37.0	100.0	100.9	6.6	10.0
88 HP	50	380-415	Min.:342, Max.:456	185.5	204.0	200	41.3	102.2	101.1	6.6	10.0
90 HP	50	380-415	Min.:342, Max.:456	189.1	208.0	200	41.3	106.5	105.3	6.6	10.0
92 HP	50	380-415	Min.:342, Max.:456	188.2	207.0	200	42.9	109.3	109.5	7.2	10.0
94 HP	50	380-415	Min.:342, Max.:456	190.9	210.0	200	41.3	111.4	110.3	7.2	10.0
96 HP	50	380-415	Min.:342, Max.:456	195.5	215.0	250	42.9	112.0	110.3	7.2	10.0

Note
 1. Voltage supplied to the unit terminals should be within the minimum and maximum range.
 2. Maximum allowable voltage unbalance between phase is 2%.
 3. MSC means the Max. current during the starting of compressor.
 4. MSC and RLA are measured as the compressor only test condition.
 5. OFM are measured as the outdoor unit test condition.
 6. TOCA means the total over current value of each outdoor unit.
 7. Select the wire size based on the larger value among MCA or TOCA.
 8. MFA is recommended fuse amps.
 9. TOCA is minimum required amperes for selecting the circuit breaker and ground fault circuit interrupter. Please select the circuit breaker size equal or greater than TOCA.
 All installation site must require attachment of an earth leakage breaker.[Circuit breaker type is ELCB (Earth Leakage Circuit Breaker)].
 10. Select the electrical equipment of combination unit according to the electrical characteristics of individual unit.

Symbols
MCA : Minimum Circuit Amperes (A)
TOCA : Total Over Current Amperes (A)
MFA : Maximum Fuse Amperes (A)
MSC : Maximum Starting Current (A)
RLA : Rated Load Amperes (A)
OFM : Outdoor Fan Motor
kW : Fan Motor rated output (kW)
FLA : Full Load Amperes (A)

Model	Unit			Power Supply			COMP			OFM	
	Hz	Volts	Voltage-range	MCA	TOCA	MFA	MSC	RLA (Cooling)	RLA(Heating)	kW	FLA
98 HP	50	380-415	Min.:342, Max.:456	199.1	219.0	250	42.9	115.0	114.2	7.2	10.0
100 HP	50	380-415	Min.:342, Max.:456	201.8	222.0	250	42.9	119.4	119.6	7.2	10.0
102 HP	50	380-415	Min.:342, Max.:456	214.5	236.0	250	47.2	121.7	119.7	7.2	10.0
104 HP	50	380-415	Min.:342, Max.:456	218.2	240.0	250	47.2	125.9	124.0	7.2	10.0

Note
 1. Voltage supplied to the unit terminals should be within the minimum and maximum range.
 2. Maximum allowable voltage unbalance between phase is 2%.
 3. MSC means the Max. current during the starting of compressor.
 4. MSC and RLA are measured as the compressor only test condition.
 5. OFM are measured as the outdoor unit test condition.
 6. TOCA means the total over current value of each outdoor unit.
 7. Select the wire size based on the larger value among MCA or TOCA.
 8. MFA is recommended fuse amps.
 9. TOCA is minimum required amperes for selecting the circuit breaker and ground fault circuit interrupter. Please select the circuit breaker size equal or greater than TOCA.
 All installation site must require attachment of an earth leakage breaker.[Circuit breaker type is ELCB (Earth Leakage Circuit Breaker)].
 10. Select the electrical equipment of combination unit according to the electrical characteristics of individual unit.

Symbols
MCA : Minimum Circuit Amperes (A)
TOCA : Total Over Current Amperes (A)
MFA : Maximum Fuse Amperes (A)
MSC : Maximum Starting Current (A)
RLA : Rated Load Amperes (A)
OFM : Outdoor Fan Motor
kW : Fan Motor rated output (kW)
FLA : Full Load Amperes (A)

NOTE

A series of horizontal dashed lines for writing notes.