

LG Electronics

Ahead of the Expected  
with LG HVAC Solutions











# **MULTI V<sup>TM</sup> 5 PRO II**

Total Air Solution Provider



[www.lg.com/vn/business](http://www.lg.com/vn/business) | [www.partner.lge.com](http://www.partner.lge.com)

Features	Appearance	8	10	12	14	16	18	20	22	24	26	28	30	32	34	36	38	40	42	44	46	48	50	52	54	56	58	60	62	64	66	68	70	72	74	76	78	80	...	96	...	104					
<p><b>MULTI V™ 5 PRO II</b></p> <ul style="list-style-type: none"> <li>• Dual Sensing Control</li> <li>• Large capacity ODU (Up to 26 HP)</li> <li>• Compact footprint &amp; Light Weight</li> <li>• Black Fin heat exchanger</li> <li>• Large space, Individual control building</li> </ul> <div style="display: flex; justify-content: space-around; align-items: center;"> <div style="text-align: center;">  <p>Shopping mall</p> </div> <div style="text-align: center;">  <p>Education</p> </div> <div style="text-align: center;">  <p>Office</p> </div> </div>		□	□	□	□																																										
						□	□	□	□	□	□																																				
													□	□	□	□	□	□	□	□	□	□	□	□																							
																										□	□	□	□	□	□	□	□	□	□	□											
																																															

# MULTI V™ 5 PRO II

## Highlight



Higher Energy Efficiency



High Reliability



Low Noise



Advanced Performance

- Air Cooled VRF Cooling Only
- Biggest Combination Capacity
- Flexible Combination of Outdoor Units



LG

MULTI V.5

## Dual Sensing Smart Load Control

MULTI V 5 PRO II can operate by sensing indoor temperature and humidity to save energy and provide comfort.

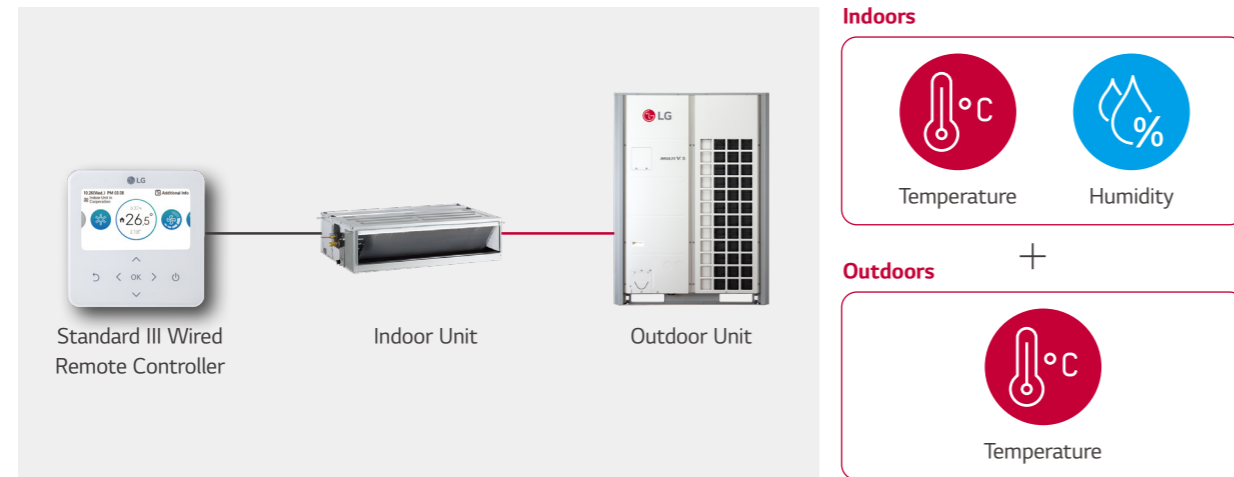

※ The Standard III Wired Remote Controller is required for this function.  
 ※ The controller is sold separately as an accessory.

## Corrosion Resistance

The Black Fin is applied for strong protection from various corrosive external conditions such as salt contamination and air pollution including fumes.

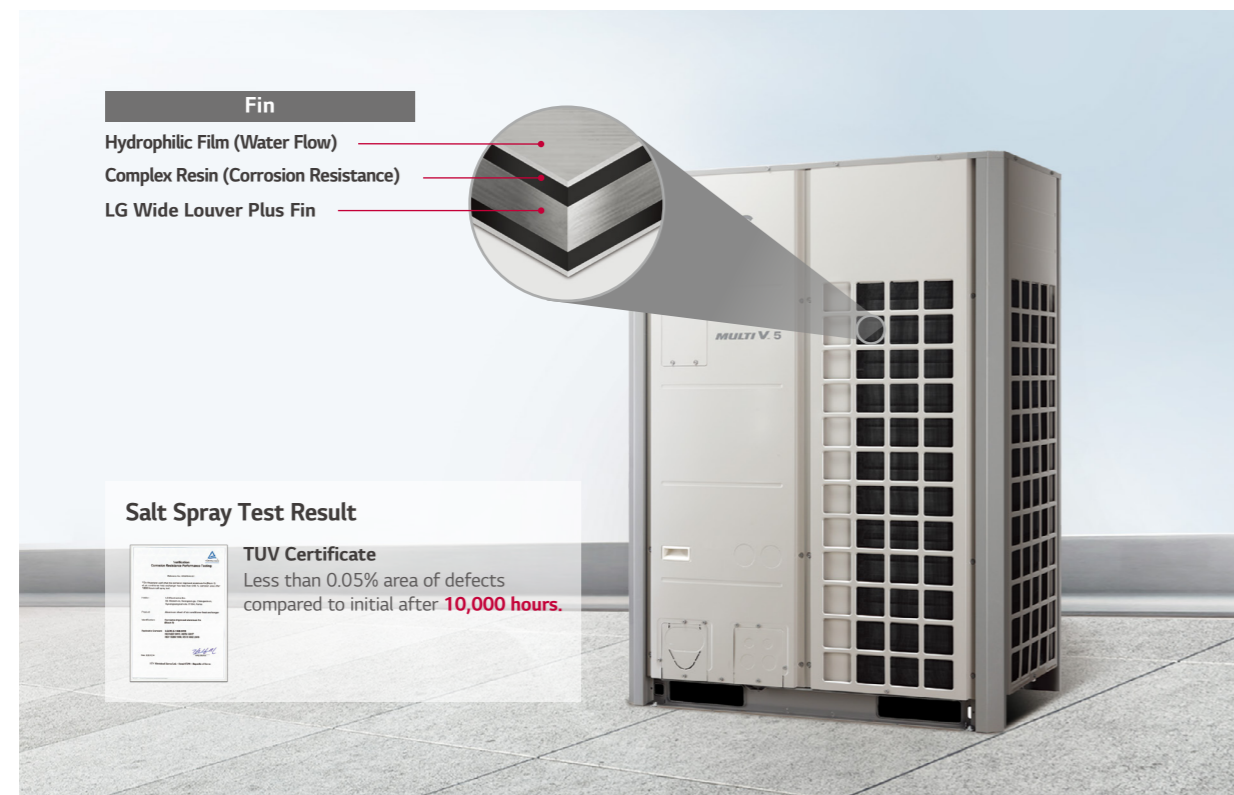

## Low ELCB Ampere

A lower MFA value can reduce ELCB costs during product installation and system maintenance.

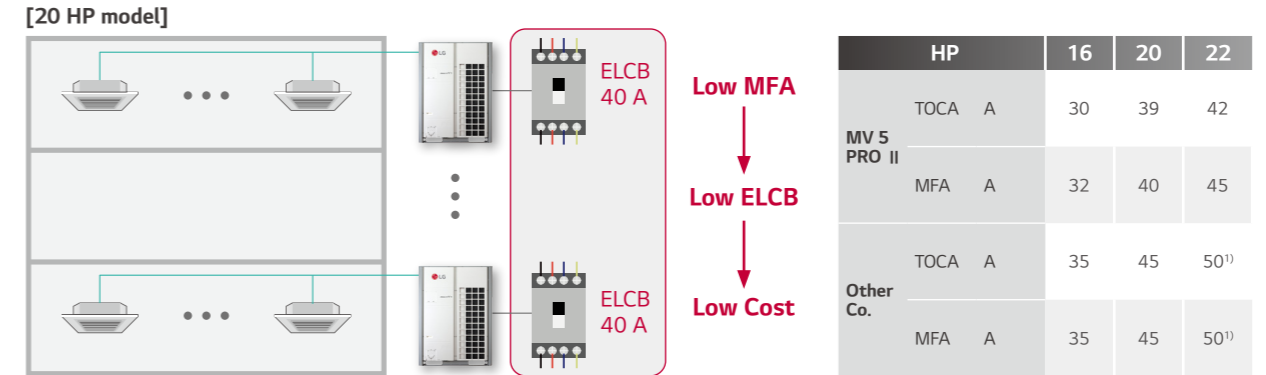

1) This model is combined with two outdoor units.  
 ※ The above images are for easy understanding and may be exaggerated.

## Reliable Inverter Compressor

MULTI V 5 PRO II is equipped with the 5<sup>th</sup> generation compressor which has the outer bearing structure for high reliability. And the outer bearing is composed of steel and PEEK.

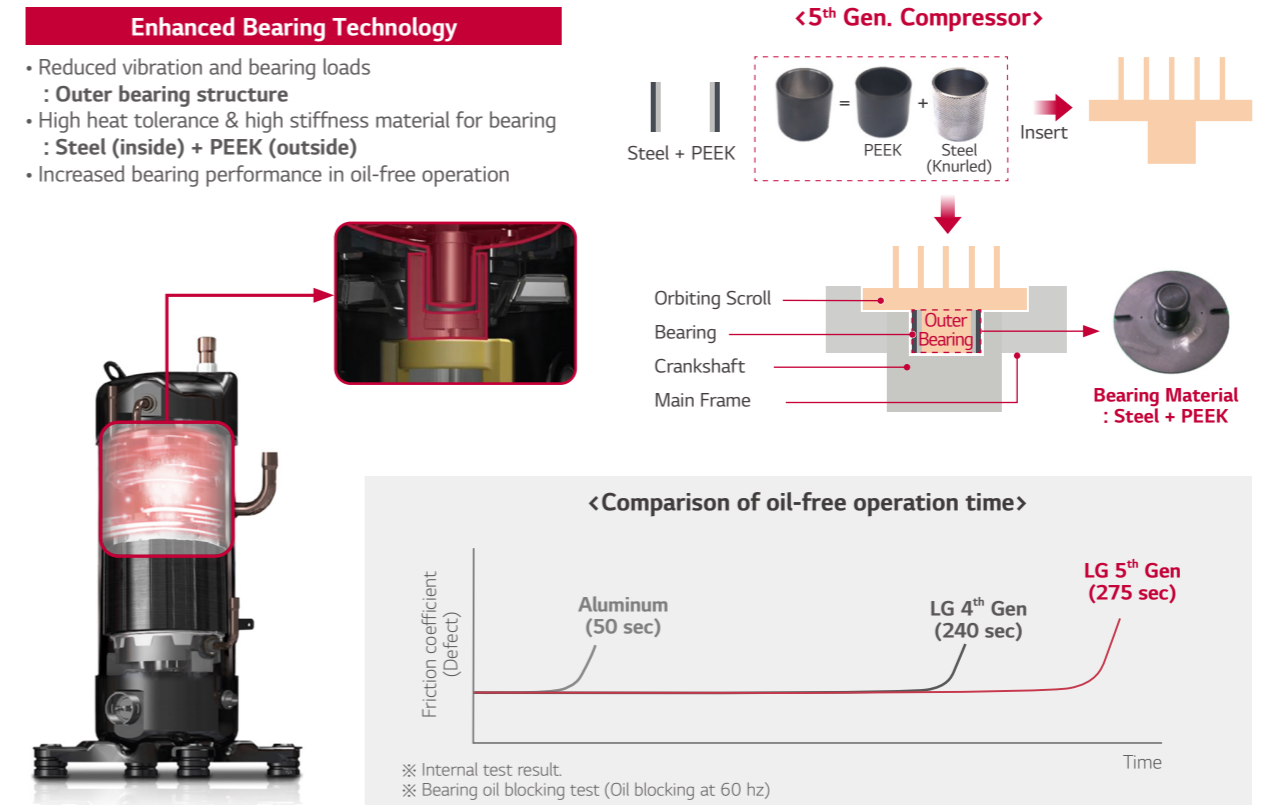

※ The PEEK is a semi-crystalline thermoplastic with excellent mechanical and chemical resistance properties that are retained to high temperatures.  
 ※ The above images are for customer understanding, and may differ from the actual parts.

## Wide Operation Range

MULTI V 5 PRO II is capable of continuous cooling operation in many countries thanks to its wide cooling operating range.

[Southeast Asia Region]



- 1 **Yangon, Myanmar**  
Max. 40.4°CDB / 28.6°CWB  
Min. 13.3°CDB / 12.5°CWB
- 2 **Bangkok, Thailand**  
Max. 38.5°CDB / 30.9°CWB  
Min. 15.0°CDB / 13.3°CWB
- 3 **Vientiane, Laos**  
Max. 38.9°CDB / 25.4°CWB  
Min. 12.7°CDB / 11.0°CWB
- 4 **Phnom Penh, Cambodia**  
Max. 37.8°CDB / 25.0°CWB  
Min. 20.6°CDB / 20.6°CWB
- 5 **Manila, Philippines**  
Max. 38.0°CDB / 32.8°CWB  
Min. 20.0°CDB / 19.3°CWB
- 6 **Ho Chi Minh, Vietnam**  
Max. 36.7°CDB / 26.7°CWB  
Min. 20.0°CDB / 20.0°CWB
- 7 **Jakarta, Indonesia**  
Max. 34.4°CDB / 25.0°CWB  
Min. 19.4°CDB / 18.9°CWB
- 8 **Singapore, Singapore**  
Max. 33.8°CDB / 29.7°CWB  
Min. 21.0°CDB / 21.0°CWB
- 9 **Kuala Lumpur, Malaysia**  
Max. 35.8°CDB / 30.6°CWB  
Min. 20.9°CDB / 20.9°CWB

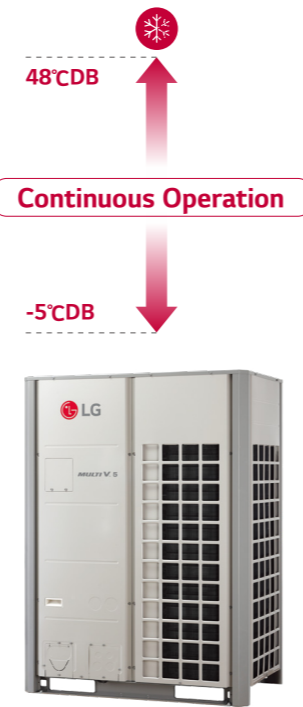

※ The source of weather data is TMY (Typical Meteorological Year) data. The TMY data contains one year of hourly data that best represents weather conditions over many years.

## Flexible Outdoor Units Combination

Flexible combination can contribute to realize faster delivery and installation. It provides more options for designing according to customers' preferences.

**Applicable Free Combination**

**Standard Combination**

18 HP 12 HP

**Flexible Combination**

20 HP 10 HP

**Flexible Combination**

16 HP 14 HP

**For Customer**  
Faster Delivery

**For Consultant**  
Flexible Design

**For Distributor**  
Convenient Inventory Management

※ More detailed information can be checked in the LATS tool.

## Total Piping Length

**1,000 m**  
Total Piping Length

**225 m**  
Longest Piping Length

**110 m**  
Height Difference between ODU - IDU

**40 m**  
Height Difference between IDU - IDU

Total Piping Length	1,000 m
Actual longest piping length (Equivalent)	200 m (225 m)
Longest piping length after 1 <sup>st</sup> branch (Conditional application)	40 m (90 m)
Max. Height difference between ODU - IDU	110 m
Max. Height difference between IDU - IDU	40 m
Max. Height difference between Indoor Units	5 m

## Mobile LGMV

Installers and service engineers can monitor the status of the air conditioner and diagnose problems with their smartphone.

Wi-Fi

LGMV Modem (Option)

MULTI V 5 PRO II

Service Time

Reliability

**LGMV**

- Monitoring Data
- Diagnosis
- Commissioning
- Troubleshooting Guide

※ Search "Mobile LGMV" on Google market or App store then download the app.  
 ※ The LGMV Modem is required for this function, and is sold separately as an accessory (Model Name : PLGMVW100).

# ENGINEERING TOOLS & SUPPORT

From planning to design, installation, service & maintenance and retrofit, an architectural project goes through many stages from the beginning to the end of its lifecycle. Along those stages, various engineering tools are applied to solve the diverse issues happening in each stage, with the most optimal solution possible. Given the usage of such tools, buildings are effectively designed, built, supervised, and maintained throughout their lifecycle.

Dedicated to provide the best HVAC engineering support, LG Air Solution offers several engineering tools and solutions focused on the overall lifecycle of a building HVAC system. The LATS\* Program has been developed to offer the best solution for LG HVAC systems, providing customers with a solution that allows for faster, easier and more accurate model selection, energy estimations and more.

\* LATS : LG Air-conditioner Technical Solution

## 01 Model Selection

### LATS HVAC

An integrated model selection program, enabling an accurate and quick selection on the best model suitable for each site. By providing detailed information on refrigerant piping and control design, design mistakes can be minimized.

- Various LG HVAC product design (MULTI V, MULTI, Single, ERV, AHU, DOAS and Central Controller)
- Calculate the diameter and length of refrigerant pipes
- Check design guide easily
- Simulate capacity and power input based on design condition
- Calculate the amount of additional refrigerant
- Provide engineering data in various formats such as report, submittal and equipment list

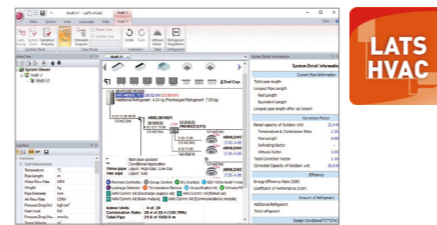

## 02 Design

### LATS CAD (2D Drawing)

Easy, quick and accurate add-in design program for AutoCAD or ZWCAD.

- Selection for outdoor unit, indoor unit, accessories and controllers
- Design ref-pipe, control line and drain pipe
- Calculate the diameter and length of pipes and drains
- Check pipe rules
- Simulate capacity and power input based on design condition
- Calculate the amount of additional refrigerant
- Output of equipment schedules and reports
- Project information sharing with LATS HVAC

※ AutoCAD / ZWCAD program is required.

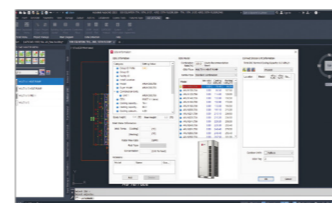

### LATS REVIT / REVIT Family (3D Drawing)

An add-in program that provides a range of functions for designing LGE VRF in Autodesk Revit for Building Information Modeling (BIM).

The Revit family of LGE products features realistic shapes and specifications, making it easy for consultants and engineers to design and plan HVAC systems.

※ AutoCAD REVIT program is required.

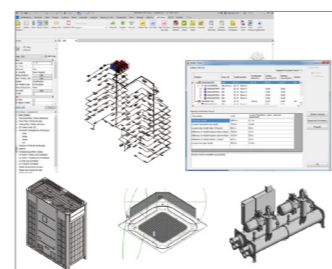

## 03 LATS LCC (Life Cycle Cost estimation)

LATS LCC simulates annual energy usage amount and life cycle cost based on whole year weather data and product performance data.

- Alternative system's Life Cycle Cost simulation
- Detail LCC analysis function
- Improved user input freedom (User can input directly)

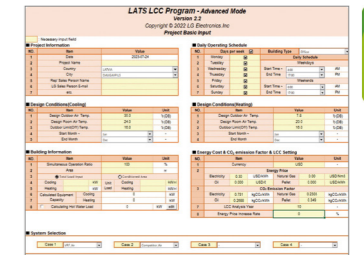

## 04 Mobile Application & Website

### LG Energy Payback Application

Payback application provides a comparison of the payback period and Low Cycle Cost of LG inverter products.

- Life Cycle Cost comparison proposal for Each HVAC System
- Payback calculation of RAC/CAC products



### CAC Partner Application

Partner application provides technical and marketing materials for each model and various utility functions.

- Search and download technical and marketing materials
- Refrigerant amount calculation and error code search function, etc.

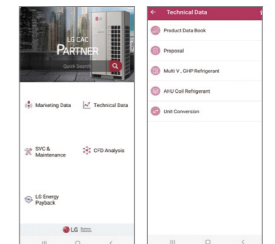

### B2B Partner Portal

B2B partner portal provides technical data and various utilities, case studies by region and model.

- Search and download of PDB, catalogue, proposals, CAD files, etc.
- Provides various case studies for each segment

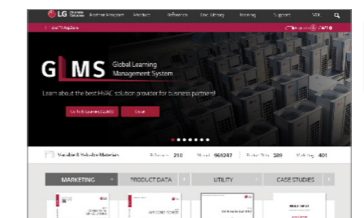

## 05 Environment Simulation

### CFD Analysis

CFD analysis can review potential issues and provide optimal solution.

- Outdoor airflow analysis : Operability check
- Indoor airflow analysis : Airflow distribution
- Outdoor noise analysis : Environmental noise impact pre-study

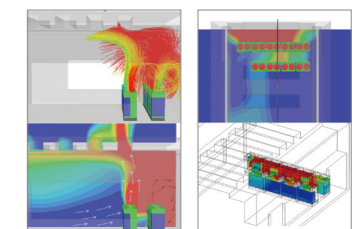

# BENEFITS OF LG MULTI V 5 PRO II

## Benefits for Building Owners



### Efficient Management & Cost Reduction

- Fault Detection Diagnosis enables easy maintenance & no extra manpower for regular maintenance.
- Saves space, time, and installation costs by offering a larger capacity single outdoor unit
- More reliable cooling operation provides stable and powerful cooling condition at the unexpected extreme environment.



### Reliability at Every Stage

- Ultimate Inverter Compressor developed and manufactured in Korea.
- Corrosion resistant Black Fin & Panel for harsh conditions operation.



### Customized Comfort and Solution

- Preset monthly energy usage and consume power according to the target that has been previously set.



## Benefits for Developers & Construction Companies



### Green Solutions

- More environmentally friendly system & higher energy efficiency, less carbon emission.



### Maximizing Space Utilization

- Large capacity in compact size enhances space utilization.



### Smart Building Solutions

- Seamless integration with current Building Management Systems.
- User friendly interface, flexible interlocking environment, energy management and smart individual controller for optimized controlling conditions and smart building management.
- Expandable control system can makes building management smart by setting up logic optimized for the site.



## Benefits for Consultants



### Versatile Solutions

- Air-cooled, Water-cooled, Heating, ERV, and Air Handling Unit interlocking solutions.



### Professional Design Support

- LATS (LG Air-conditioner Technical Solution) for draft energy estimation, model selection, HVAC design and 3D designing.
- CFD Analysis to ensure suitable solutions and prevent malfunctions.
- Energy simulation offered to find the optimal solution.



### Optimized Convenience with HVAC Design

- Flexible combination provides more options for designing according to customers' preferences.
- The outdoor unit noise can be restricted by the set noise level in advance.



## Benefits for End-users



### Cost Saving Operation

- High efficiency guaranteed throughout product line-up.
- Prevent overuse of the HVAC system operational costs by AI Energy management.



### Comfort Cooling & Heating

- MULTI V 5 Pro II is able to take control by itself in various situations through deep learning algorithms that enable it to self-learn.
- Automatic operation provides more comfort and convenience by checking ambient weather conditions.



### Convenient Functions

- Low-noise operation provides a pleasant environment.



## Interlocking Operation with ERV

LG ERV DX with humidification function interlock operation is a solution for humidifying and ventilating the indoor space while communicating with other IDUs and the ODU. They provide improved comfort conditions considering the indoor conditions without additional facility installation.

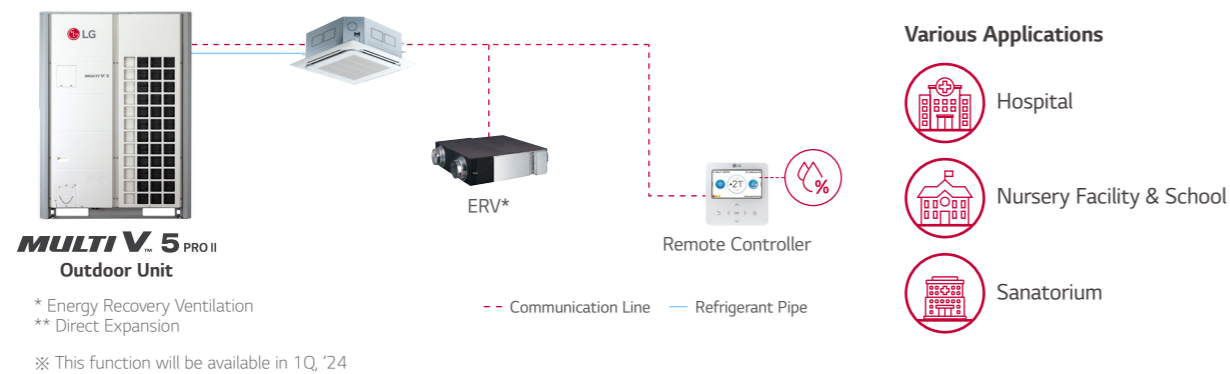

## Air Handling Unit (AHU) Solution

AHU is a suitable solution for cooling and heating in large spaces. With an LG AHU Comm. Kit (for both return air / supply air control) connected to the DX coil of the AHU, LG VRF system can be applied to deliver conditioned air.

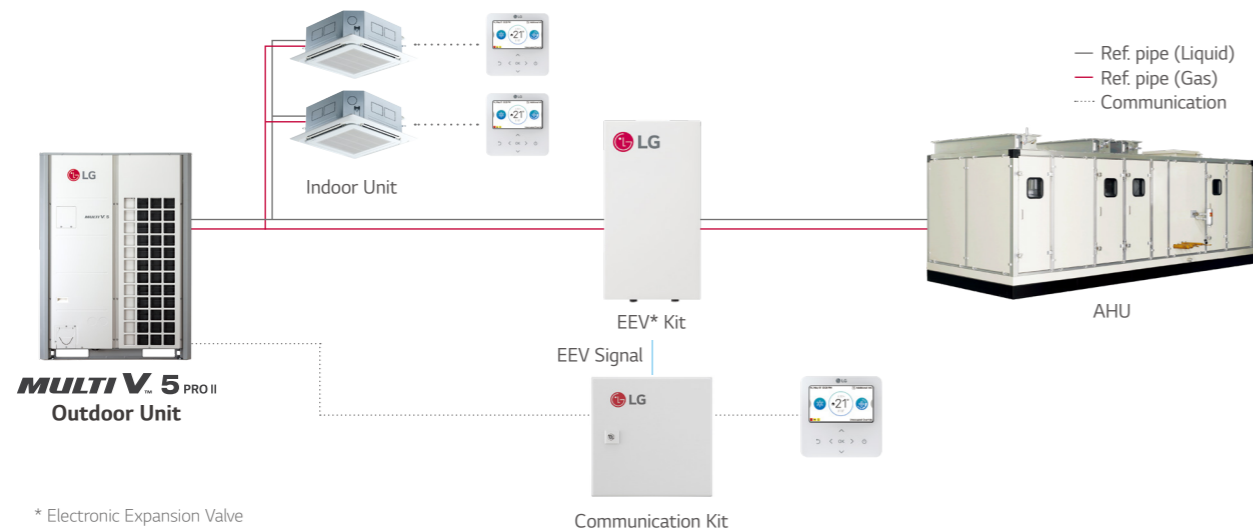

## Refrigerant Leak Detection Solution

LG leakage detector keep the indoor space safe and guarantees the customer's peace of mind.

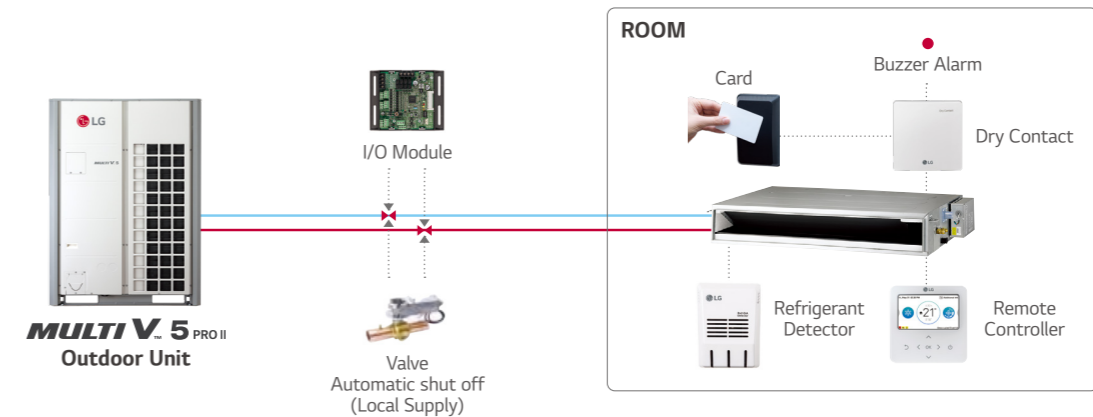

## Power Consumption Distribution Solution

In case of shared power consumption in a building, a solution to distribute the power consumption amount per tenant might be necessary. Electricity charges can be billed to each tenant by using output from the LG Power Distributor Indicator (PDI). An administrator is able to check the power usage for each space and date as needed. If the PDI is used in conjunction with an LG central controller, the results can be exported in excel format.

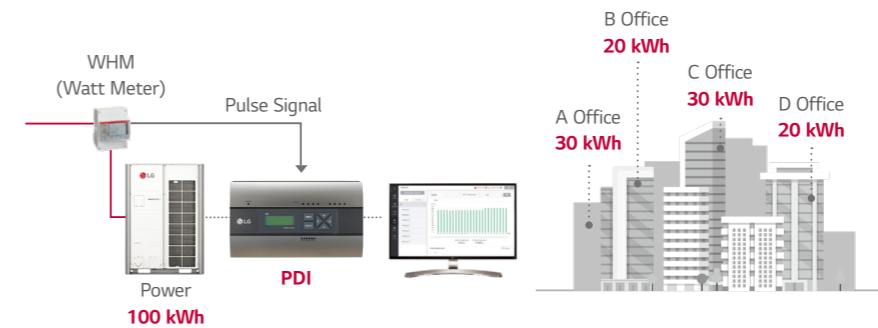

## Total Control via Any Device

When managing multiple spaces, building administrators should be able to control systems from wherever they are. The LG central controller can be accessed from any web browser that supports HTML5. The interface has been adapted to look great and perform well on any device.





## Energy Management Solution

Energy navigation function allows LG Multi V 5 Pro II to preset monthly energy usage and consume what has been previously planned. By comparing and analyzing previous consumption and planned energy usage for the month, overuse of the HVAC system operational costs can be prevented with central controller.

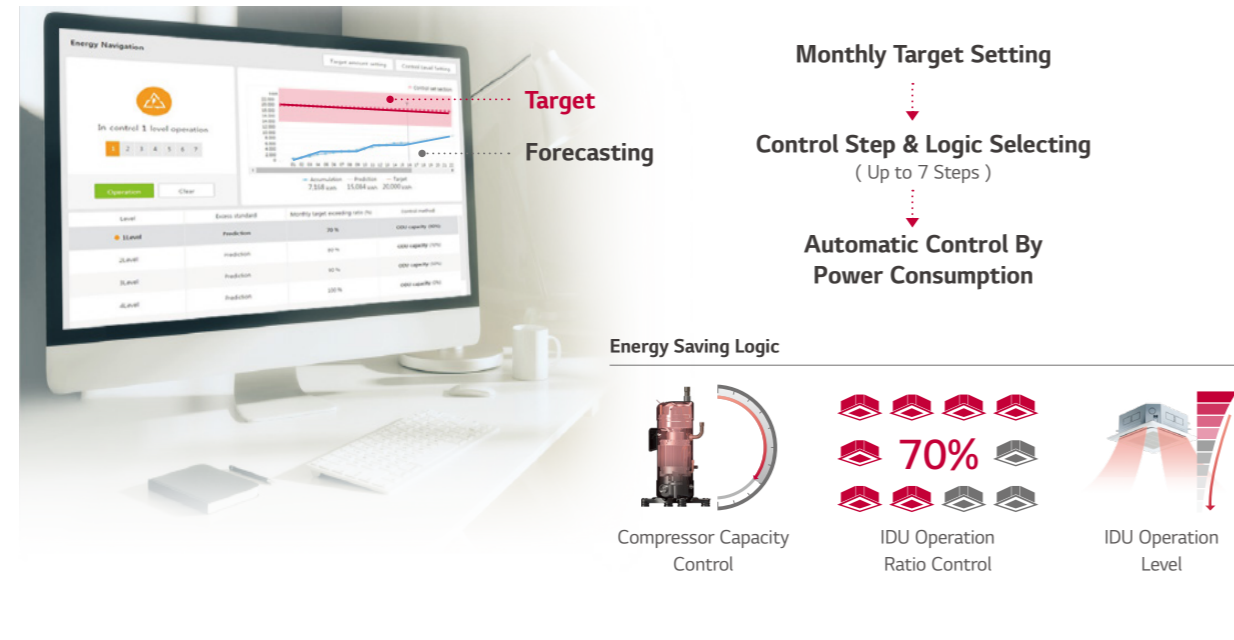

## Integration Solution with BMS

There are many BMS protocols used for the control of buildings' various systems such as HVAC, lighting, power and security. LG has a wide range of gateway products for different protocols such as BACnet, Modbus. In addition, LG gateways include Stand-alone central control capability to act as a back-up controller of the BMS if needed.

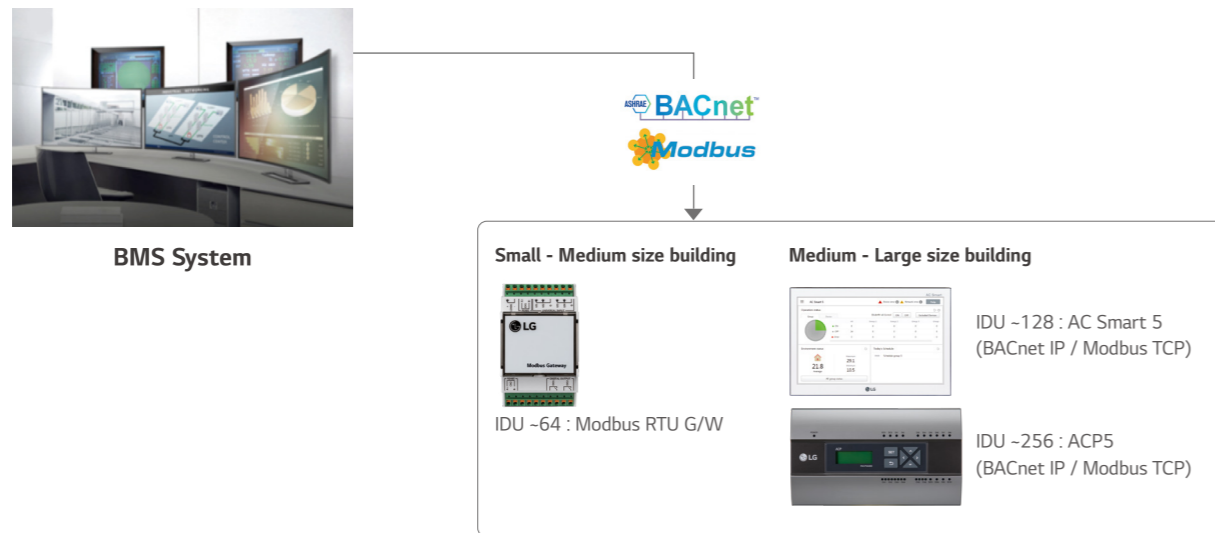

## Interlocking Solution by Using ACU Module

It is costly to introduce a BMS system to control multiple devices or systems in a small building. With the ACU module, various IO contact points (DI, DO, UI, AO) can be interlocked and integrated, while control is possible from the LG central controller. This enables an efficient management of lighting, pumps and other devices in the building in conjunction with the HVAC system.

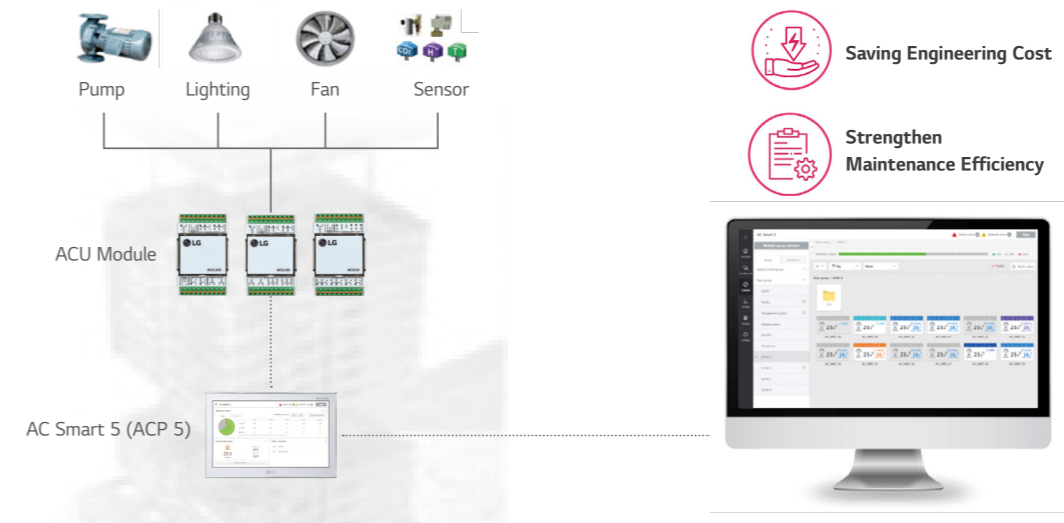

## Interlocking Solution Using Dry Contact

3<sup>rd</sup> party thermostats can be used to control LG air conditioners in a room by using a multi point dry contact. The dry contact enables basic control of air conditioners as well as making it possible to report the status and any errors impacting the indoor unit. The Standard III remote control has a DO port. With this DO port, it is possible to interlock the indoor unit with 3<sup>rd</sup> party devices such as lighting, a fan, or a radiator, based on parameters like operation mode or current temperature. The indoor unit can be interlocked with various types of input such as card key-tag, door sensor, human detection sensor etc. so that the air conditioner is automatically operated. In addition, the dry contact option settings enable operation of air conditioner to maintain proper temperature when the occupant is absent. This solution makes sure that the room does not overheat or become too cold when unoccupied so that energy cost can be saved.



**ARUV081LLS5 / ARUV101LLS5  
ARUV121LLS5 / ARUV141LLS5**



HP			8	10	12	14
<b>Model Name</b>	Combination Unit		ARUV081LLS5	ARUV101LLS5	ARUV121LLS5	ARUV141LLS5
	Independent Unit		ARUV081LLS5	ARUV101LLS5	ARUV121LLS5	ARUV141LLS5
<b>Capacity</b>	Cooling (Rated)	kW	22.4	28.0	33.6	39.2
		Btu/h	76,400	95,500	114,600	133,800
<b>Power Input</b>	Cooling	kW	5.10	6.80	8.90	10.60
<b>COP Cooling</b>			4.39	4.12	3.78	3.70
<b>Power Factor</b>	Rated		0.93	0.93	0.93	0.93
<b>Exterior</b>	Casing Color		Morning Gray / Dawn Gray	Morning Gray / Dawn Gray	Morning Gray / Dawn Gray	Morning Gray / Dawn Gray
	RAL code		RAL 7038 / RAL 7037	RAL 7038 / RAL 7037	RAL 7038 / RAL 7037	RAL 7038 / RAL 7037
<b>Heat Exchanger</b>			Wide Louver Plus	Wide Louver Plus	Wide Louver Plus	Wide Louver Plus
	Type		Hermetically Sealed Scroll	Hermetically Sealed Scroll	Hermetically Sealed Scroll	Hermetically Sealed Scroll
<b>Compressor</b>	Piston Displacement	cm <sup>3</sup> /rev	62.1	62.1	62.1	62.1
	Number of Revolution	rev/min	3,600	3,600	3,600	3,600
	Motor Output x Number	W x No.	5,300 x 1	5,300 x 1	5,300 x 1	5,300 x 1
	Starting Method		Inverter	Inverter	Inverter	Inverter
	Oil Type		FW68L (PVE)	FW68L (PVE)	FW68L (PVE)	FW68L (PVE)
	Type		Propeller Fan	Propeller Fan	Propeller Fan	Propeller Fan
	Motor Output x Number	W	1,200 x 1	1,200 x 1	1,200 x 1	1,200 x 1
<b>Fan</b>	Air Flow Rate (High)	m <sup>3</sup> /min	240	240	240	240
	Drive		DC Inverter	DC Inverter	DC Inverter	DC Inverter
	Discharge	Side / Top	TOP	TOP	TOP	TOP
<b>Pipe Connections For Heat Pump</b>	Liquid Pipe	mm (inch)	Ø 9.52 (3/8)	Ø 9.52 (3/8)	Ø 12.7 (1/2)	Ø 12.7 (1/2)
	Gas Pipe	mm (inch)	Ø 19.05 (3/4)	Ø 22.2 (7/8)	Ø 28.58 (1-1/8)	Ø 28.58 (1-1/8)
<b>Dimensions (W x H x D)</b>		mm	(930 x 1,690 x 760)	(930 x 1,690 x 760)	(930 x 1,690 x 760)	(930 x 1,690 x 760)
<b>Weight</b>	Net	kg	164	164	164	180
<b>Sound Pressure Level</b>	Cooling	dB (A)	58.0	58.0	59.0	60.0
<b>Communication Cable</b>		No. x mm <sup>2</sup> (VCTF-SB)	2 C x 1.0 - 1.5	2 C x 1.0 - 1.5	2 C x 1.0 - 1.5	2 C x 1.0 - 1.5
<b>Refrigerant</b>	Refrigerant Name		R410A	R410A	R410A	R410A
	Precharged Amount in Factory	kg	4.7	4.7	4.7	7.5
	GWP		2,087.5	2,087.5	2,087.5	2,087.5
	t-CO <sub>2</sub> eq		9.8	9.8	9.8	15.7
	Control		Electronic Expansion Valve	Electronic Expansion Valve	Electronic Expansion Valve	Electronic Expansion Valve
<b>Power Supply</b>		V / Ø / Hz	380-415, 3, 50	380-415, 3, 50	380-415, 3, 50	380-415, 3, 50
<b>Number of Maximum Connectable Indoor Units</b>			13 (20)	16 (25)	20 (30)	23 (35)

1. Due to our policy of innovation some specifications may be changed without notification.
2. Wiring cable size must comply with the applicable local and national codes. And "Electric characteristics" chapter should be considered for electrical work and design. Especially the power cable and circuit breaker should be selected in accordance with that.
3. Power factor could vary less than ±1% according to the operating conditions.
4. Sound pressure level is measured on the rated condition in the anechoic rooms by ISO 3745 standard. Sound power level is measured on the rated condition in the reverberation rooms by ISO 3741 standard. Therefore, these values can be increased owing to ambient conditions during operation.
5. Performances are based on the following conditions - Cooling : Indoor Ambient Temp. 27°CDB / 19°CWB, Outdoor Ambient Temp. 35°CDB / 24°CWB  
- Heating : Indoor Ambient Temp. 20°CDB / 15°CWB, Outdoor Ambient Temp. 7°CDB / 6°CWB  
Interconnected Pipe Length is 7.5m and difference of Elevation (Outdoor - Indoor Unit) is Zero.
6. The numbers in parentheses means maximum connectable indoor units in accordance with outdoor units combination. The recommended ratio is 130%.
7. This product contains Fluorinated greenhouse gases. (R410A, GWP(Global warming potential) = 2,087.5)

**ARUV161LLS5 / ARUV181LLS5  
ARUV201LLS5**



HP			16	18	20
<b>Model Name</b>	Combination Unit		ARUV161LLS5	ARUV181LLS5	ARUV201LLS5
	Independent Unit		ARUV161LLS5	ARUV181LLS5	ARUV201LLS5
<b>Capacity</b>	Cooling (Rated)	kW	44.8	50.4	56.0
		Btu/h	152,900	172,000	191,100
<b>Power Input</b>	Cooling	kW	11.90	12.30	14.10
<b>COP Cooling</b>			3.76	4.10	3.97
<b>Power Factor</b>	Rated		0.93	0.93	0.93
<b>Exterior</b>	Casing Color		Morning Gray / Dawn Gray	Morning Gray / Dawn Gray	Morning Gray / Dawn Gray
	RAL code		RAL 7038 / RAL 7037	RAL 7038 / RAL 7037	RAL 7038 / RAL 7037
<b>Heat Exchanger</b>			Wide Louver Plus	Wide Louver Plus	Wide Louver Plus
	Type		Hermetically Sealed Scroll	Hermetically Sealed Scroll	Hermetically Sealed Scroll
<b>Compressor</b>	Piston Displacement	cm <sup>3</sup> /rev	62.1	87.6	87.6
	Number of Revolution	rev/min	3,600	3,600	3,600
	Motor Output x Number	W x No.	5,300 x 1	7,500 x 1	7,500 x 1
	Starting Method		Inverter	Inverter	Inverter
	Oil Type		FW68L (PVE)	FW68L (PVE)	FW68L (PVE)
	Type		Propeller Fan	Propeller Fan	Propeller Fan
	Motor Output x Number	W	900 x 2	900 x 2	900 x 2
<b>Fan</b>	Air Flow Rate (High)	m <sup>3</sup> /min	320	320	320
	Drive		DC Inverter	DC Inverter	DC Inverter
	Discharge	Side / Top	TOP	TOP	TOP
<b>Pipe Connections For Heat Pump</b>	Liquid Pipe	mm (inch)	Ø 12.7 (1/2)	Ø 15.88 (5/8)	Ø 15.88 (5/8)
	Gas Pipe	mm (inch)	Ø 28.58 (1-1/8)	Ø 28.58 (1-1/8)	Ø 28.58 (1-1/8)
<b>Dimensions (W x H x D)</b>		mm	(1,240 x 1,690 x 760)	(1,240 x 1,690 x 760)	(1,240 x 1,690 x 760)
<b>Weight</b>	Net	kg	195.5	205	221
<b>Sound Pressure Level</b>	Cooling	dB (A)	60.5	62.0	63.0
<b>Communication Cable</b>		No. x mm <sup>2</sup> (VCTF-SB)	2 C x 1.0 - 1.5	2 C x 1.0 - 1.5	2 C x 1.0 - 1.5
<b>Refrigerant</b>	Refrigerant Name		R410A	R410A	R410A
	Precharged Amount in Factory	kg	6.5	6.5	7.5
	GWP		2,087.5	2,087.5	2,087.5
	t-CO <sub>2</sub> eq		13.6	13.6	15.7
	Control		Electronic Expansion Valve	Electronic Expansion Valve	Electronic Expansion Valve
<b>Power Supply</b>		V / Ø / Hz	380-415, 3, 50	380-415, 3, 50	380-415, 3, 50
<b>Number of Maximum Connectable Indoor Units</b>			26 (40)	29 (45)	32 (50)

1. Due to our policy of innovation some specifications may be changed without notification.
2. Wiring cable size must comply with the applicable local and national codes. And "Electric characteristics" chapter should be considered for electrical work and design. Especially the power cable and circuit breaker should be selected in accordance with that.
3. Power factor could vary less than ±1% according to the operating conditions.
4. Sound pressure level is measured on the rated condition in the anechoic rooms by ISO 3745 standard. Sound power level is measured on the rated condition in the reverberation rooms by ISO 3741 standard. Therefore, these values can be increased owing to ambient conditions during operation.
5. Performances are based on the following conditions - Cooling : Indoor Ambient Temp. 27°CDB / 19°CWB, Outdoor Ambient Temp. 35°CDB / 24°CWB  
- Heating : Indoor Ambient Temp. 20°CDB / 15°CWB, Outdoor Ambient Temp. 7°CDB / 6°CWB  
Interconnected Pipe Length is 7.5m and difference of Elevation (Outdoor - Indoor Unit) is Zero.
6. The numbers in parentheses means maximum connectable indoor units in accordance with outdoor units combination. The recommended ratio is 130%.
7. This product contains Fluorinated greenhouse gases. (R410A, GWP(Global warming potential) = 2,087.5)

**ARUV221LLS5 / ARUV241LLS5  
ARUV261LLS5**



HP		22	24	26	
<b>Model Name</b>	Combination Unit	ARUV221LLS5	ARUV241LLS5	ARUV261LLS5	
	Independent Unit	ARUV221LLS5	ARUV241LLS5	ARUV261LLS5	
<b>Capacity</b>	Cooling (Rated)	61.6	67.2	72.8	
		Btu/h	210,200	229,300	248,400
<b>Power Input</b>	Cooling	16.80	18.20	20.80	
<b>COP Cooling</b>		3.67	3.69	3.50	
<b>Power Factor</b>	Rated	0.93	0.93	0.93	
<b>Exterior</b>	Casing Color	Morning Gray / Dawn Gray	Morning Gray / Dawn Gray	Morning Gray / Dawn Gray	
	RAL code	RAL 7038 / RAL 7037	RAL 7038 / RAL 7037	RAL 7038 / RAL 7037	
<b>Heat Exchanger</b>		Wide Louver Plus	Wide Louver Plus	Wide Louver Plus	
<b>Compressor</b>	Type	Hermetically Sealed Scroll	Hermetically Sealed Scroll	Hermetically Sealed Scroll	
	Piston Displacement	cm <sup>3</sup> /rev	87.6	62.1 × 2	62.1 × 2
	Number of Revolution	rev/min	3,600	3,600 × 2	3,600 × 2
	Motor Output x Number	W x No.	7,500 × 1	5,300 × 2	5,300 × 2
	Starting Method		Inverter	Inverter	Inverter
	Oil Type		FW68L (PVE)	FW68L (PVE)	FW68L (PVE)
<b>Fan</b>	Type	Propeller Fan	Propeller Fan	Propeller Fan	
	Motor Output x Number	W	900 × 2	900 × 2	900 × 2
	Air Flow Rate (High)	m <sup>3</sup> /min	320	320	320
	Drive		DC Inverter	DC Inverter	DC Inverter
<b>Pipe Connections For Heat Pump</b>	Liquid Pipe	mm (inch)	Ø 15.88 (5/8)	Ø 15.88 (5/8)	Ø 19.05 (3/4)
	Gas Pipe	mm (inch)	Ø 28.58 (1-1/8)	Ø 34.9 (1-3/8)	Ø 34.9 (1-3/8)
<b>Dimensions (W x H x D)</b>	mm	(1,240 × 1,690 × 760)	(1,240 × 1,690 × 760)	(1,240 × 1,690 × 760)	
<b>Weight</b>	Net	kg	221	256.5	256.5
<b>Sound Pressure Level</b>	Cooling	dB (A)	64.0	65.0	65.0
<b>Communication Cable</b>	No. x mm <sup>2</sup> (VCTF-SB)		2 C × 1.0 - 1.5	2 C × 1.0 - 1.5	2 C × 1.0 - 1.5
<b>Refrigerant</b>	Refrigerant Name		R410A	R410A	R410A
	Precharged Amount in Factory	kg	7.5	11	11
	GWP		2,087.5	2,087.5	2,087.5
	t-CO <sub>2</sub> eq		15.7	23.0	23.0
<b>Power Supply</b>	V / Ø / Hz		380-415, 3, 50	380-415, 3, 50	380-415, 3, 50
<b>Number of Maximum Connectable Indoor Units</b>			35 (56)	39 (61)	42 (64)

1. Due to our policy of innovation some specifications may be changed without notification.  
 2. Wiring cable size must comply with the applicable local and national codes. And "Electric characteristics" chapter should be considered for electrical work and design. Especially the power cable and circuit breaker should be selected in accordance with that.  
 3. Power factor could vary less than ±1% according to the operating conditions.  
 4. Sound pressure level is measured on the rated condition in the anechoic rooms by ISO 3745 standard. Sound power level is measured on the rated condition in the reverberation rooms by ISO 3741 standard. Therefore, these values can be increased owing to ambient conditions during operation.  
 5. Performances are based on the following conditions - Cooling : Indoor Ambient Temp. 27°CDB / 19°CWB, Outdoor Ambient Temp. 35°CDB / 24°CWB  
 - Heating : Indoor Ambient Temp. 20°CDB / 15°CWB, Outdoor Ambient Temp. 7°CDB / 6°CWB  
 Interconnected Pipe Length is 7.5m and difference of Elevation (Outdoor - Indoor Unit) is Zero.  
 6. The numbers in parentheses means maximum connectable indoor units in accordance with outdoor units combination. The recommended ratio is 130%.  
 7. This product contains Fluorinated greenhouse gases. (R410A, GWP(Global warming potential) = 2,087.5)

**ARUV281LLS5 / ARUV301LLS5  
ARUV321LLS5**



HP		28	30	32	
<b>Model Name</b>	Combination Unit	ARUV281LLS5	ARUV301LLS5	ARUV321LLS5	
	Independent Unit	ARUV161LLS5 ARUV121LLS5	ARUV181LLS5 ARUV121LLS5	ARUV201LLS5 ARUV121LLS5	
<b>Capacity</b>	Cooling (Rated)	78.4	84.0	89.6	
		Btu/h	267,500	286,600	305,700
<b>Power Input</b>	Cooling	20.8	21.2	23.0	
<b>COP Cooling</b>		3.77	3.96	3.90	
<b>Power Factor</b>	Rated	0.93	0.93	0.93	
<b>Exterior</b>	Casing Color	Morning Gray / Dawn Gray	Morning Gray / Dawn Gray	Morning Gray / Dawn Gray	
	RAL code	RAL 7038 / RAL 7037	RAL 7038 / RAL 7037	RAL 7038 / RAL 7037	
<b>Heat Exchanger</b>		Wide Louver Plus	Wide Louver Plus	Wide Louver Plus	
<b>Compressor</b>	Type	Hermetically Sealed Scroll	Hermetically Sealed Scroll	Hermetically Sealed Scroll	
	Piston Displacement	cm <sup>3</sup> /rev	62.1 × 2	(87.6 × 1) + (62.1)	(87.6 × 1) + (62.1)
	Number of Revolution	rev/min	3,600 × 2	3,600 × 2	3,600 × 2
	Motor Output x Number	W x No.	5,300 × 2	(7,500 × 1) + (5,300 × 1)	(7,500 × 1) + (5,300 × 1)
	Starting Method		Inverter	Inverter	Inverter
	Oil Type		FW68L (PVE)	FW68L (PVE)	FW68L (PVE)
<b>Fan</b>	Type	Propeller Fan	Propeller Fan	Propeller Fan	
	Motor Output x Number	W	(900 × 2) + (1,500 × 1)	(900 × 2) + (1,500 × 1)	(900 × 2) + (1,500 × 1)
	Air Flow Rate (High)	m <sup>3</sup> /min	(320 × 1) + (240 × 1)	(320 × 1) + (240 × 1)	(320 × 1) + (240 × 1)
	Drive		DC Inverter	DC Inverter	DC Inverter
<b>Pipe Connections For Heat Pump</b>	Liquid Pipe	mm (inch)	Ø 19.05 (3/4)	Ø 19.05 (3/4)	Ø 19.05 (3/4)
	Gas Pipe	mm (inch)	Ø 34.9 (1-3/8)	Ø 34.9 (1-3/8)	Ø 34.9 (1-3/8)
<b>Dimensions (W x H x D)</b>	mm	(1,240 × 1,690 × 760) × 1 + (930 × 1,690 × 760) × 1	(1,240 × 1,690 × 760) × 1 + (930 × 1,690 × 760) × 1	(1,240 × 1,690 × 760) × 1 + (930 × 1,690 × 760) × 1	
<b>Weight</b>	Net	kg	(195.5) + (164)	(205) + (164)	(221) + (164)
<b>Sound Pressure Level</b>	Cooling	dB (A)	62.8	63.8	64.5
<b>Communication Cable</b>	No. x mm <sup>2</sup> (VCTF-SB)		2 C × 1.0 - 1.5	2 C × 1.0 - 1.5	2 C × 1.0 - 1.5
<b>Refrigerant</b>	Refrigerant Name		R410A	R410A	R410A
	Precharged Amount in Factory	kg	11.2	11.2	12.2
	GWP		2,087.5	2,087.5	2,087.5
	t-CO <sub>2</sub> eq		23.4	23.4	25.5
<b>Power Supply</b>	V / Ø / Hz		380-415, 3, 50	380-415, 3, 50	380-415, 3, 50
<b>Number of Maximum Connectable Indoor Units</b>			45 (56)	49 (60)	52 (64)

1. Due to our policy of innovation some specifications may be changed without notification.  
 2. Wiring cable size must comply with the applicable local and national codes. And "Electric characteristics" chapter should be considered for electrical work and design. Especially the power cable and circuit breaker should be selected in accordance with that.  
 3. Power factor could vary less than ±1% according to the operating conditions.  
 4. Sound pressure level is measured on the rated condition in the anechoic rooms by ISO 3745 standard. Sound power level is measured on the rated condition in the reverberation rooms by ISO 3741 standard. Therefore, these values can be increased owing to ambient conditions during operation.  
 5. Performances are based on the following conditions - Cooling : Indoor Ambient Temp. 27°CDB / 19°CWB, Outdoor Ambient Temp. 35°CDB / 24°CWB  
 - Heating : Indoor Ambient Temp. 20°CDB / 15°CWB, Outdoor Ambient Temp. 7°CDB / 6°CWB  
 Interconnected Pipe Length is 7.5m and difference of Elevation (Outdoor - Indoor Unit) is Zero.  
 6. The numbers in parentheses means maximum connectable indoor units in accordance with outdoor units combination. The recommended ratio is 130%.  
 7. This product contains Fluorinated greenhouse gases. (R410A, GWP(Global warming potential) = 2,087.5)

**ARUV341LLS5 / ARUV361LLS5  
ARUV381LLS5**



HP		34	36	38	
<b>Model Name</b>	Combination Unit	ARUV341LLS5	ARUV361LLS5	ARUV381LLS5	
	Independent Unit	ARUV221LLS5 ARUV121LLS5	ARUV241LLS5 ARUV121LLS5	ARUV261LLS5 ARUV121LLS5	
<b>Capacity</b>	Cooling (Rated)	kW	95.2	100.8	106.4
		Btu/h	324,800	343,900	363,000
<b>Power Input</b>	Cooling	kW	25.7	27.1	29.7
<b>COP Cooling</b>			3.70	3.72	3.58
<b>Power Factor</b>	Rated		0.93	0.93	0.93
<b>Exterior</b>	Casing Color	Morning Gray / Dawn Gray	Morning Gray / Dawn Gray	Morning Gray / Dawn Gray	
	RAL code	RAL 7038 / RAL 7037	RAL 7038 / RAL 7037	RAL 7038 / RAL 7037	
<b>Heat Exchanger</b>		Wide Louver Plus	Wide Louver Plus	Wide Louver Plus	
<b>Compressor</b>	Type	Hermetically Sealed Scroll	Hermetically Sealed Scroll	Hermetically Sealed Scroll	
	Piston Displacement	cm <sup>3</sup> /rev	(87.6 x 1) + (62.1)	62.1 x 3	62.1 x 3
	Number of Revolution	rev/min	3,600 x 2	3,600 x 3	3,600 x 3
	Motor Output x Number	W x No.	(7,500 x 1) + (5,300 x 1)	5,300 x 3	5,300 x 3
	Starting Method		Inverter	Inverter	Inverter
	Oil Type		FW68L (PVE)	FW68L (PVE)	FW68L (PVE)
<b>Fan</b>	Type	Propeller Fan	Propeller Fan	Propeller Fan	
	Motor Output x Number	W	(900 x 2) + (1,500 x 1)	(900 x 2) + (1,500 x 1)	(900 x 2) + (1,500 x 1)
	Air Flow Rate (High)	m <sup>3</sup> /min	(320 x 1) + (240 x 1)	(320 x 1) + (240 x 1)	(320 x 1) + (240 x 1)
	Drive		DC Inverter	DC Inverter	DC Inverter
	Discharge	Side / Top	TOP	TOP	TOP
<b>Pipe Connections For Heat Pump</b>	Liquid Pipe	mm (inch)	Ø 19.05 (3/4)	Ø 19.05 (3/4)	Ø 19.05 (3/4)
	Gas Pipe	mm (inch)	Ø 34.9 (1-3/8)	Ø 41.3 (1-5/8)	Ø 41.3 (1-5/8)
<b>Dimensions (W x H x D)</b>	mm	(1,240 x 1,690 x 760) x 1 + (930 x 1,690 x 760) x 1	(1,240 x 1,690 x 760) x 1 + (930 x 1,690 x 760) x 1	(1,240 x 1,690 x 760) x 1 + (930 x 1,690 x 760) x 1	
<b>Weight</b>	Net	kg	(221) + (164)	(256.5) + (164)	(256.5) + (164)
<b>Sound Pressure Level</b>	Cooling	dB (A)	65.2	66.0	66.0
<b>Communication Cable</b>	No. x mm <sup>2</sup> (VCTF-SB)		2 C x 1.0 - 1.5	2 C x 1.0 - 1.5	2 C x 1.0 - 1.5
<b>Refrigerant</b>	Refrigerant Name		R410A	R410A	R410A
	Precharged Amount in Factory	kg	12.2	15.7	15.7
	GWP		2,087.5	2,087.5	2,087.5
	t-CO <sub>2</sub> eq		25.5	32.8	32.8
	Control		Electronic Expansion Valve	Electronic Expansion Valve	Electronic Expansion Valve
<b>Power Supply</b>	V / Ø / Hz		380-415, 3, 50	380-415, 3, 50	380-415, 3, 50
<b>Number of Maximum Connectable Indoor Units</b>			55 (64)	58 (64)	61 (64)

1. Due to our policy of innovation some specifications may be changed without notification.
2. Wiring cable size must comply with the applicable local and national codes. And "Electric characteristics" chapter should be considered for electrical work and design. Especially the power cable and circuit breaker should be selected in accordance with that.
3. Power factor could vary less than ±1% according to the operating conditions.
4. Sound pressure level is measured on the rated condition in the anechoic rooms by ISO 3745 standard. Sound power level is measured on the rated condition in the reverberation rooms by ISO 3741 standard. Therefore, these values can be increased owing to ambient conditions during operation.
5. Performances are based on the following conditions - Cooling : Indoor Ambient Temp. 27°CDB / 19°CWB, Outdoor Ambient Temp. 35°CDB / 24°CWB - Heating : Indoor Ambient Temp. 20°CDB / 15°CWB, Outdoor Ambient Temp. 7°CDB / 6°CWB Interconnected Pipe Length is 7.5m and difference of Elevation (Outdoor - Indoor Unit) is Zero.
6. The numbers in parentheses means maximum connectable indoor units in accordance with outdoor units combination. The recommended ratio is 130%.
7. This product contains Fluorinated greenhouse gases. (R410A, GWP(Global warming potential) = 2,087.5)

**ARUV401LLS5 / ARUV421LLS5  
ARUV441LLS5**



HP		40	42	44	
<b>Model Name</b>	Combination Unit	ARUV401LLS5	ARUV421LLS5	ARUV441LLS5	
	Independent Unit	ARUV261LLS5 ARUV141LLS5	ARUV261LLS5 ARUV161LLS5	ARUV261LLS5 ARUV181LLS5	
<b>Capacity</b>	Cooling (Rated)	kW	112.0	117.6	123.2
		Btu/h	382,200	401,300	420,400
<b>Power Input</b>	Cooling	kW	31.4	32.7	33.1
<b>COP Cooling</b>			3.57	3.60	3.72
<b>Power Factor</b>	Rated		0.93	0.93	0.93
<b>Exterior</b>	Casing Color	Morning Gray / Dawn Gray	Morning Gray / Dawn Gray	Morning Gray / Dawn Gray	
	RAL code	RAL 7038 / RAL 7037	RAL 7038 / RAL 7037	RAL 7038 / RAL 7037	
<b>Heat Exchanger</b>		Wide Louver Plus	Wide Louver Plus	Wide Louver Plus	
<b>Compressor</b>	Type	Hermetically Sealed Scroll	Hermetically Sealed Scroll	Hermetically Sealed Scroll	
	Piston Displacement	cm <sup>3</sup> /rev	62.1 x 3	62.1 x 3	(62.1 x 2) + (87.6)
	Number of Revolution	rev/min	3,600 x 3	3,600 x 3	3,600 x 3
	Motor Output x Number	W x No.	5,300 x 3	5,300 x 3	(5,300 x 2) + (7,500 x 1)
	Starting Method		Inverter	Inverter	Inverter
	Oil Type		FW68L (PVE)	FW68L (PVE)	FW68L (PVE)
<b>Fan</b>	Type	Propeller Fan	Propeller Fan	Propeller Fan	
	Motor Output x Number	W	(900 x 2) + (1,500 x 1)	900 x 4	900 x 4
	Air Flow Rate (High)	m <sup>3</sup> /min	(320 x 1) + (240 x 1)	320 x 2	320 x 2
	Drive		DC Inverter	DC Inverter	DC Inverter
	Discharge	Side / Top	TOP	TOP	TOP
<b>Pipe Connections For Heat Pump</b>	Liquid Pipe	mm (inch)	Ø 19.05 (3/4)	Ø 19.05 (3/4)	Ø 19.05 (3/4)
	Gas Pipe	mm (inch)	Ø 41.3 (1-5/8)	Ø 41.3 (1-5/8)	Ø 41.3 (1-5/8)
<b>Dimensions (W x H x D)</b>	mm	(1,240 x 1,690 x 760) x 1 + (930 x 1,690 x 760) x 1	(1,240 x 1,690 x 760) x 2	(1,240 x 1,690 x 760) x 2	
<b>Weight</b>	Net	kg	(256.5) + (180)	(256.5) + (195.5)	(256.5) + (205)
<b>Sound Pressure Level</b>	Cooling	dB (A)	66.2	66.3	66.8
<b>Communication Cable</b>	No. x mm <sup>2</sup> (VCTF-SB)		2 C x 1.0 - 1.5	2 C x 1.0 - 1.5	2 C x 1.0 - 1.5
<b>Refrigerant</b>	Refrigerant Name		R410A	R410A	R410A
	Precharged Amount in Factory	kg	18.5	17.5	17.5
	GWP		2,087.5	2,087.5	2,087.5
	t-CO <sub>2</sub> eq		38.6	36.5	36.5
	Control		Electronic Expansion Valve	Electronic Expansion Valve	Electronic Expansion Valve
<b>Power Supply</b>	V / Ø / Hz		380-415, 3, 50	380-415, 3, 50	380-415, 3, 50
<b>Number of Maximum Connectable Indoor Units</b>			64	64	64

1. Due to our policy of innovation some specifications may be changed without notification.
2. Wiring cable size must comply with the applicable local and national codes. And "Electric characteristics" chapter should be considered for electrical work and design. Especially the power cable and circuit breaker should be selected in accordance with that.
3. Power factor could vary less than ±1% according to the operating conditions.
4. Sound pressure level is measured on the rated condition in the anechoic rooms by ISO 3745 standard. Sound power level is measured on the rated condition in the reverberation rooms by ISO 3741 standard. Therefore, these values can be increased owing to ambient conditions during operation.
5. Performances are based on the following conditions - Cooling : Indoor Ambient Temp. 27°CDB / 19°CWB, Outdoor Ambient Temp. 35°CDB / 24°CWB - Heating : Indoor Ambient Temp. 20°CDB / 15°CWB, Outdoor Ambient Temp. 7°CDB / 6°CWB Interconnected Pipe Length is 7.5m and difference of Elevation (Outdoor - Indoor Unit) is Zero.
6. The numbers in parentheses means maximum connectable indoor units in accordance with outdoor units combination. The recommended ratio is 130%.
7. This product contains Fluorinated greenhouse gases. (R410A, GWP(Global warming potential) = 2,087.5)

**ARUV461LLS5 / ARUV481LLS5  
ARUV501LLS5**



HP		46	48	50
<b>Model Name</b>	Combination Unit	ARUV461LLS5	ARUV481LLS5	ARUV501LLS5
	Independent Unit	ARUV261LLS5 ARUV201LLS5	ARUV261LLS5 ARUV221LLS5	ARUV261LLS5 ARUV241LLS5
<b>Capacity</b>	Cooling (Rated)	kW 128.8	134.4	140.0
		Btu/h 439,500	458,600	477,700
<b>Power Input</b>	Cooling	kW 34.9	37.6	39.0
<b>COP Cooling</b>		3.69	3.57	3.59
<b>Power Factor</b>	Rated	0.93	0.93	0.93
<b>Exterior</b>	Casing Color	Morning Gray / Dawn Gray	Morning Gray / Dawn Gray	Morning Gray / Dawn Gray
	RAL code	RAL 7038 / RAL 7037	RAL 7038 / RAL 7037	RAL 7038 / RAL 7037
<b>Heat Exchanger</b>		Wide Louver Plus	Wide Louver Plus	Wide Louver Plus
<b>Compressor</b>	Type	Hermetically Sealed Scroll	Hermetically Sealed Scroll	Hermetically Sealed Scroll
	Piston Displacement	cm <sup>3</sup> /rev (62.1 x 2) + (87.6)	(62.1 x 2) + (87.6)	62.1 x 4
	Number of Revolution	rev/min 3,600 x 3	3,600 x 3	3,600 x 4
	Motor Output x Number	W x No. (5,300 x 2) + (7,500 x 1)	(5,300 x 2) + (7,500 x 1)	5,300 x 4
	Starting Method	Inverter	Inverter	Inverter
	Oil Type	FW68L (PVE)	FW68L (PVE)	FW68L (PVE)
<b>Fan</b>	Type	Propeller Fan	Propeller Fan	Propeller Fan
	Motor Output x Number	W 900 x 4	900 x 4	900 x 4
	Air Flow Rate (High)	m <sup>3</sup> /min 320 x 2	320 x 2	320 x 2
	Drive	DC Inverter	DC Inverter	DC Inverter
	Discharge	Side / Top TOP	TOP	TOP
<b>Pipe Connections For Heat Pump</b>	Liquid Pipe	mm (inch) Ø 19.05 (3/4)	Ø 19.05 (3/4)	Ø 19.05 (3/4)
	Gas Pipe	mm (inch) Ø 41.3 (1-5/8)	Ø 41.3 (1-5/8)	Ø 41.3 (1-5/8)
<b>Dimensions (W x H x D)</b>	mm	(1,240 x 1,690 x 760) x 2	(1,240 x 1,690 x 760) x 2	(1,240 x 1,690 x 760) x 2
<b>Weight</b>	Net	kg (256.5) + (221)	(256.5) + (221)	(256.5) + (256.5)
<b>Sound Pressure Level</b>	Cooling	dB (A) 67.1	67.5	68.0
<b>Communication Cable</b>	No. x mm <sup>2</sup> (VCTF-SB)	2 C x 1.0 - 1.5	2 C x 1.0 - 1.5	2 C x 1.0 - 1.5
<b>Refrigerant</b>	Refrigerant Name	R410A	R410A	R410A
	Precharged Amount in Factory	kg 18.5	18.5	22.0
	GWP	2,087.5	2,087.5	2,087.5
	t-CO <sub>2</sub> eq	38.6	38.6	45.9
	Control	Electronic Expansion Valve	Electronic Expansion Valve	Electronic Expansion Valve
<b>Power Supply</b>	V / Ø / Hz	380-415, 3, 50	380-415, 3, 50	380-415, 3, 50
<b>Number of Maximum Connectable Indoor Units</b>		64	64	64

1. Due to our policy of innovation some specifications may be changed without notification.
2. Wiring cable size must comply with the applicable local and national codes. And "Electric characteristics" chapter should be considered for electrical work and design. Especially the power cable and circuit breaker should be selected in accordance with that.
3. Power factor could vary less than ±1% according to the operating conditions.
4. Sound pressure level is measured on the rated condition in the anechoic rooms by ISO 3745 standard. Sound power level is measured on the rated condition in the reverberation rooms by ISO 3741 standard. Therefore, these values can be increased owing to ambient conditions during operation.
5. Performances are based on the following conditions - Cooling : Indoor Ambient Temp. 27°CDB / 19°CWB, Outdoor Ambient Temp. 35°CDB / 24°CWB  
- Heating : Indoor Ambient Temp. 20°CDB / 15°CWB, Outdoor Ambient Temp. 7°CDB / 6°CWB  
Interconnected Pipe Length is 7.5m and difference of Elevation (Outdoor - Indoor Unit) is Zero.
6. The numbers in parentheses means maximum connectable indoor units in accordance with outdoor units combination. The recommended ratio is 130%.
7. This product contains Fluorinated greenhouse gases. (R410A, GWP(Global warming potential) = 2,087.5)

**ARUV521LLS5 / ARUV541LLS5  
ARUV561LLS5**



HP		52	54	56
<b>Model Name</b>	Combination Unit	ARUV521LLS5	ARUV541LLS5	ARUV561LLS5
	Independent Unit	ARUV261LLS5 ARUV261LLS5	ARUV261LLS5 ARUV161LLS5 ARUV121LLS5	ARUV261LLS5 ARUV181LLS5 ARUV121LLS5
<b>Capacity</b>	Cooling (Rated)	kW 145.6	151.2	156.8
		Btu/h 496,800	515,900	535,000
<b>Power Input</b>	Cooling	kW 41.6	41.6	42.0
<b>COP Cooling</b>		3.50	3.63	3.73
<b>Power Factor</b>	Rated	0.93	0.93	0.93
<b>Exterior</b>	Casing Color	Morning Gray / Dawn Gray	Morning Gray / Dawn Gray	Morning Gray / Dawn Gray
	RAL code	RAL 7038 / RAL 7037	RAL 7038 / RAL 7037	RAL 7038 / RAL 7037
<b>Heat Exchanger</b>		Wide Louver Plus	Wide Louver Plus	Wide Louver Plus
<b>Compressor</b>	Type	Hermetically Sealed Scroll	Hermetically Sealed Scroll	Hermetically Sealed Scroll
	Piston Displacement	cm <sup>3</sup> /rev 62.1 x 4	62.1 x 4	(62.1 x 3) + (87.6)
	Number of Revolution	rev/min 3,600 x 4	3,600 x 4	3,600 x 4
	Motor Output x Number	W x No. 5,300 x 4	5,300 x 4	(5,300 x 3) + (7,500 x 1)
	Starting Method	Inverter	Inverter	Inverter
	Oil Type	FW68L (PVE)	FW68L (PVE)	FW68L (PVE)
<b>Fan</b>	Type	Propeller Fan	Propeller Fan	Propeller Fan
	Motor Output x Number	W 900 x 4	(900 x 4) + (1,500 x 1)	(900 x 4) + (1,500 x 1)
	Air Flow Rate (High)	m <sup>3</sup> /min 320 x 2	(320 x 2) + (240 x 1)	(320 x 2) + (240 x 1)
	Drive	DC Inverter	DC Inverter	DC Inverter
	Discharge	Side / Top TOP	TOP	TOP
<b>Pipe Connections For Heat Pump</b>	Liquid Pipe	mm (inch) Ø 19.05 (3/4)	Ø 19.05 (3/4)	Ø 19.05 (3/4)
	Gas Pipe	mm (inch) Ø 41.3 (1-5/8)	Ø 41.3 (1-5/8)	Ø 41.3 (1-5/8)
<b>Dimensions (W x H x D)</b>	mm	(1,240 x 1,690 x 760) x 2	(1,240 x 1,690 x 760) x 2 + (930 x 1,690 x 760) x 1	(1,240 x 1,690 x 760) x 2 + (930 x 1,690 x 760) x 1
<b>Weight</b>	Net	kg (256.5) + (256.5)	(256.5) + (195.5) + (164)	(256.5) + (205) + (164)
<b>Sound Pressure Level</b>	Cooling	dB (A) 68.0	67.1	67.4
<b>Communication Cable</b>	No. x mm <sup>2</sup> (VCTF-SB)	2 C x 1.0 - 1.5	2 C x 1.0 - 1.5	2 C x 1.0 - 1.5
<b>Refrigerant</b>	Refrigerant Name	R410A	R410A	R410A
	Precharged Amount in Factory	kg 22.0	22.2	22.2
	GWP	2,087.5	2,087.5	2,087.5
	t-CO <sub>2</sub> eq	45.9	46.3	46.3
	Control	Electronic Expansion Valve	Electronic Expansion Valve	Electronic Expansion Valve
<b>Power Supply</b>	V / Ø / Hz	380-415, 3, 50	380-415, 3, 50	380-415, 3, 50
<b>Number of Maximum Connectable Indoor Units</b>		64	64	64

1. Due to our policy of innovation some specifications may be changed without notification.
2. Wiring cable size must comply with the applicable local and national codes. And "Electric characteristics" chapter should be considered for electrical work and design. Especially the power cable and circuit breaker should be selected in accordance with that.
3. Power factor could vary less than ±1% according to the operating conditions.
4. Sound pressure level is measured on the rated condition in the anechoic rooms by ISO 3745 standard. Sound power level is measured on the rated condition in the reverberation rooms by ISO 3741 standard. Therefore, these values can be increased owing to ambient conditions during operation.
5. Performances are based on the following conditions - Cooling : Indoor Ambient Temp. 27°CDB / 19°CWB, Outdoor Ambient Temp. 35°CDB / 24°CWB  
- Heating : Indoor Ambient Temp. 20°CDB / 15°CWB, Outdoor Ambient Temp. 7°CDB / 6°CWB  
Interconnected Pipe Length is 7.5m and difference of Elevation (Outdoor - Indoor Unit) is Zero.
6. The numbers in parentheses means maximum connectable indoor units in accordance with outdoor units combination. The recommended ratio is 130%.
7. This product contains Fluorinated greenhouse gases. (R410A, GWP(Global warming potential) = 2,087.5)

**ARUV581LLS5 / ARUV601LLS5  
ARUV621LLS5**



HP		58	60	62	
<b>Model Name</b>	Combination Unit	ARUV581LLS5	ARUV601LLS5	ARUV621LLS5	
	Independent Unit	ARUV261LLS5 ARUV201LLS5 ARUV121LLS5	ARUV261LLS5 ARUV221LLS5 ARUV121LLS5	ARUV261LLS5 ARUV261LLS5 ARUV121LLS5	
<b>Capacity</b>	Cooling (Rated)	kW	162.4	168.0	173.6
		Btu/h	554,100	573,200	592,300
<b>Power Input</b>	Cooling	kW	43.8	46.5	47.9
<b>COP Cooling</b>			3.71	3.61	3.62
<b>Power Factor</b>	Rated		0.93	0.93	0.93
<b>Exterior</b>	Casing Color	Morning Gray / Dawn Gray	Morning Gray / Dawn Gray	Morning Gray / Dawn Gray	
	RAL code	RAL 7038 / RAL 7037	RAL 7038 / RAL 7037	RAL 7038 / RAL 7037	
<b>Heat Exchanger</b>		Wide Louver Plus	Wide Louver Plus	Wide Louver Plus	
<b>Compressor</b>	Type	Hermetically Sealed Scroll	Hermetically Sealed Scroll	Hermetically Sealed Scroll	
	Piston Displacement	cm <sup>3</sup> /rev	(62.1 x 3) + (87.6)	(62.1 x 3) + (87.6)	62.1 x 5
	Number of Revolution	rev/min	3,600 x 4	3,600 x 4	3,600 x 5
	Motor Output x Number	W x No.	(5,300 x 3) + (7,500 x 1)	(5,300 x 3) + (7,500 x 1)	5,300 x 5
	Starting Method		Inverter	Inverter	Inverter
	Oil Type		FW68L (PVE)	FW68L (PVE)	FW68L (PVE)
	Type		Propeller Fan	Propeller Fan	Propeller Fan
<b>Fan</b>	Motor Output x Number	W	(900 x 4) + (1,500 x 1)	(900 x 4) + (1,500 x 1)	(900 x 4) + (1,500 x 1)
	Air Flow Rate (High)	m <sup>3</sup> /min	(320 x 2) + (240 x 1)	(320 x 2) + (240 x 1)	(320 x 2) + (240 x 1)
	Drive		DC Inverter	DC Inverter	DC Inverter
	Discharge	Side / Top	TOP	TOP	TOP
<b>Pipe Connections For Heat Pump</b>	Liquid Pipe	mm (inch)	Ø 19.05 (3/4)	Ø 19.05 (3/4)	Ø 22.2 (7/8)
	Gas Pipe	mm (inch)	Ø 41.3 (1-5/8)	Ø 41.3 (1-5/8)	Ø 41.3 (1-5/8)
<b>Dimensions (W x H x D)</b>	mm	(1,240 x 1,690 x 760) x 2 + (930 x 1,690 x 760) x 1	(1,240 x 1,690 x 760) x 2 + (930 x 1,690 x 760) x 1	(1,240 x 1,690 x 760) x 2 + (930 x 1,690 x 760) x 1	
<b>Weight</b>	Net	kg	(256.5) + (221) + (164)	(256.5) + (221) + (164)	(256.5) + (256.5) + (164)
<b>Sound Pressure Level</b>	Cooling	dB (A)	67.7	68.1	68.5
<b>Communication Cable</b>		No. x mm <sup>2</sup> (VCTF-SB)	2 C x 1.0 - 1.5	2 C x 1.0 - 1.5	2 C x 1.0 - 1.5
<b>Refrigerant</b>	Refrigerant Name		R410A	R410A	R410A
	Precharged Amount in Factory	kg	23.2	23.2	26.7
	GWP		2,087.5	2,087.5	2,087.5
	t-CO <sub>2</sub> eq		48.4	48.4	55.7
	Control		Electronic Expansion Valve	Electronic Expansion Valve	Electronic Expansion Valve
<b>Power Supply</b>		V / Ø / Hz	380-415, 3, 50	380-415, 3, 50	380-415, 3, 50
<b>Number of Maximum Connectable Indoor Units</b>			64	64	64

**ARUV641LLS5 / ARUV661LLS5  
ARUV681LLS5**



HP		64	66	68	
<b>Model Name</b>	Combination Unit	ARUV641LLS5	ARUV661LLS5	ARUV681LLS5	
	Independent Unit	ARUV261LLS5 ARUV261LLS5 ARUV121LLS5	ARUV261LLS5 ARUV261LLS5 ARUV141LLS5	ARUV261LLS5 ARUV261LLS5 ARUV161LLS5	
<b>Capacity</b>	Cooling (Rated)	kW	179.2	184.8	190.4
		Btu/h	611,400	630,600	649,700
<b>Power Input</b>	Cooling	kW	50.5	52.2	53.5
<b>COP Cooling</b>			3.55	3.54	3.56
<b>Power Factor</b>	Rated		0.93	0.93	0.93
<b>Exterior</b>	Casing Color	Morning Gray / Dawn Gray	Morning Gray / Dawn Gray	Morning Gray / Dawn Gray	
	RAL code	RAL 7038 / RAL 7037	RAL 7038 / RAL 7037	RAL 7038 / RAL 7037	
<b>Heat Exchanger</b>		Wide Louver Plus	Wide Louver Plus	Wide Louver Plus	
<b>Compressor</b>	Type	Hermetically Sealed Scroll	Hermetically Sealed Scroll	Hermetically Sealed Scroll	
	Piston Displacement	cm <sup>3</sup> /rev	62.1 x 5	62.1 x 5	62.1 x 5
	Number of Revolution	rev/min	3,600 x 5	3,600 x 5	3,600 x 5
	Motor Output x Number	W x No.	5,300 x 5	5,300 x 5	5,300 x 5
	Starting Method		Inverter	Inverter	Inverter
	Oil Type		FW68L (PVE)	FW68L (PVE)	FW68L (PVE)
	Type		Propeller Fan	Propeller Fan	Propeller Fan
<b>Fan</b>	Motor Output x Number	W	(900 x 4) + (1,500 x 1)	(900 x 4) + (1,500 x 1)	900 x 6
	Air Flow Rate (High)	m <sup>3</sup> /min	(320 x 2) + (240 x 1)	(320 x 2) + (240 x 1)	320 x 3
	Drive		DC Inverter	DC Inverter	DC Inverter
	Discharge	Side / Top	TOP	TOP	TOP
<b>Pipe Connections For Heat Pump</b>	Liquid Pipe	mm (inch)	Ø 22.2 (7/8)	Ø 22.2 (7/8)	Ø 22.2 (7/8)
	Gas Pipe	mm (inch)	Ø 41.3 (1-5/8)	Ø 53.98 (2-1/8)	Ø 53.98 (2-1/8)
<b>Dimensions (W x H x D)</b>	mm	(1,240 x 1,690 x 760) x 2 + (930 x 1,690 x 760) x 1	(1,240 x 1,690 x 760) x 2 + (930 x 1,690 x 760) x 1	(1,240 x 1,690 x 760) x 3	
<b>Weight</b>	Net	kg	(256.5) + (256.5) + (164)	(256.5) + (256.5) + (180)	(256.5) + (256.5) + (195.5)
<b>Sound Pressure Level</b>	Cooling	dB (A)	68.5	68.6	68.7
<b>Communication Cable</b>		No. x mm <sup>2</sup> (VCTF-SB)	2 C x 1.0 - 1.5	2 C x 1.0 - 1.5	2 C x 1.0 - 1.5
<b>Refrigerant</b>	Refrigerant Name		R410A	R410A	R410A
	Precharged Amount in Factory	kg	26.7	29.5	28.5
	GWP		2,087.5	2,087.5	2,087.5
	t-CO <sub>2</sub> eq		55.7	61.6	59.5
	Control		Electronic Expansion Valve	Electronic Expansion Valve	Electronic Expansion Valve
<b>Power Supply</b>		V / Ø / Hz	380-415, 3, 50	380-415, 3, 50	380-415, 3, 50
<b>Number of Maximum Connectable Indoor Units</b>			64	64	64

1. Due to our policy of innovation some specifications may be changed without notification.  
 2. Wiring cable size must comply with the applicable local and national codes. And "Electric characteristics" chapter should be considered for electrical work and design. Especially the power cable and circuit breaker should be selected in accordance with that.  
 3. Power factor could vary less than ±1% according to the operating conditions.  
 4. Sound pressure level is measured on the rated condition in the anechoic rooms by ISO 3745 standard. Sound power level is measured on the rated condition in the reverberation rooms by ISO 3741 standard. Therefore, these values can be increased owing to ambient conditions during operation.  
 5. Performances are based on the following conditions - Cooling : Indoor Ambient Temp. 27°CDB / 19°CWB, Outdoor Ambient Temp. 35°CDB / 24°CWB  
 - Heating : Indoor Ambient Temp. 20°CDB / 15°CWB, Outdoor Ambient Temp. 7°CDB / 6°CWB  
 Interconnected Pipe Length is 7.5m and difference of Elevation (Outdoor - Indoor Unit) is Zero.  
 6. The numbers in parentheses means maximum connectable indoor units in accordance with outdoor units combination. The recommended ratio is 130%.  
 7. This product contains Fluorinated greenhouse gases. (R410A, GWP(Global warming potential) = 2,087.5)

1. Due to our policy of innovation some specifications may be changed without notification.  
 2. Wiring cable size must comply with the applicable local and national codes. And "Electric characteristics" chapter should be considered for electrical work and design. Especially the power cable and circuit breaker should be selected in accordance with that.  
 3. Power factor could vary less than ±1% according to the operating conditions.  
 4. Sound pressure level is measured on the rated condition in the anechoic rooms by ISO 3745 standard. Sound power level is measured on the rated condition in the reverberation rooms by ISO 3741 standard. Therefore, these values can be increased owing to ambient conditions during operation.  
 5. Performances are based on the following conditions - Cooling : Indoor Ambient Temp. 27°CDB / 19°CWB, Outdoor Ambient Temp. 35°CDB / 24°CWB  
 - Heating : Indoor Ambient Temp. 20°CDB / 15°CWB, Outdoor Ambient Temp. 7°CDB / 6°CWB  
 Interconnected Pipe Length is 7.5m and difference of Elevation (Outdoor - Indoor Unit) is Zero.  
 6. The numbers in parentheses means maximum connectable indoor units in accordance with outdoor units combination. The recommended ratio is 130%.  
 7. This product contains Fluorinated greenhouse gases. (R410A, GWP(Global warming potential) = 2,087.5)

**ARUV701LLS5 / ARUV721LLS5  
ARUV741LLS5**



HP		70	72	74	
<b>Model Name</b>	Combination Unit	ARUV701LLS5	ARUV721LLS5	ARUV741LLS5	
	Independent Unit	ARUV261LLS5 ARUV261LLS5 ARUV181LLS5	ARUV261LLS5 ARUV261LLS5 ARUV201LLS5	ARUV261LLS5 ARUV261LLS5 ARUV221LLS5	
<b>Capacity</b>	Cooling (Rated)	196.0	201.6	207.2	
		kW	668,800	687,900	707,000
<b>Power Input</b>	Cooling	53.9	55.7	58.4	
<b>COP Cooling</b>		3.64	3.62	3.55	
<b>Power Factor</b>	Rated	0.93	0.93	0.93	
<b>Exterior</b>	Casing Color	Morning Gray / Dawn Gray	Morning Gray / Dawn Gray	Morning Gray / Dawn Gray	
	RAL code	RAL 7038 / RAL 7037	RAL 7038 / RAL 7037	RAL 7038 / RAL 7037	
<b>Heat Exchanger</b>		Wide Louver Plus	Wide Louver Plus	Wide Louver Plus	
<b>Compressor</b>	Type	Hermetically Sealed Scroll	Hermetically Sealed Scroll	Hermetically Sealed Scroll	
	Piston Displacement	cm <sup>3</sup> /rev	(62.1 x 4) + (87.6)	(62.1 x 4) + (87.6)	(62.1 x 4) + (87.6)
	Number of Revolution	rev/min	3,600 x 5	3,600 x 5	3,600 x 5
	Motor Output x Number	W x No.	(5,300 x 4) + (7,500 x 1)	(5,300 x 4) + (7,500 x 1)	(5,300 x 4) + (7,500 x 1)
	Starting Method		Inverter	Inverter	Inverter
	Oil Type		FW68L (PVE)	FW68L (PVE)	FW68L (PVE)
<b>Fan</b>	Type	Propeller Fan	Propeller Fan	Propeller Fan	
	Motor Output x Number	W	900 x 6	900 x 6	900 x 6
	Air Flow Rate (High)	m <sup>3</sup> /min	320 x 3	320 x 3	320 x 3
	Drive		DC Inverter	DC Inverter	DC Inverter
<b>Pipe Connections For Heat Pump</b>	Liquid Pipe	mm (inch)	Ø 22.2 (7/8)	Ø 22.2 (7/8)	Ø 22.2 (7/8)
	Gas Pipe	mm (inch)	Ø 53.98 (2-1/8)	Ø 53.98 (2-1/8)	Ø 53.98 (2-1/8)
<b>Dimensions (W x H x D)</b>	mm	(1,240 x 1,690 x 760) x 3	(1,240 x 1,690 x 760) x 3	(1,240 x 1,690 x 760) x 3	
<b>Weight</b>	Net	kg	(256.5) + (256.5) + (205)	(256.5) + (256.5) + (221)	(256.5) + (256.5) + (221)
<b>Sound Pressure Level</b>	Cooling	dB (A)	69.0	69.2	69.5
<b>Communication Cable</b>		No. x mm <sup>2</sup> (VCTF-SB)	2 C x 1.0 - 1.5	2 C x 1.0 - 1.5	2 C x 1.0 - 1.5
<b>Refrigerant</b>	Refrigerant Name		R410A	R410A	R410A
	Precharged Amount in Factory	kg	28.5	29.5	29.5
	GWP		2,087.5	2,087.5	2,087.5
	t-CO <sub>2</sub> eq		59.5	61.6	61.6
	Control		Electronic Expansion Valve	Electronic Expansion Valve	Electronic Expansion Valve
<b>Power Supply</b>		V / Ø / Hz	380-415, 3, 50	380-415, 3, 50	380-415, 3, 50
<b>Number of Maximum Connectable Indoor Units</b>			64	64	64

1. Due to our policy of innovation some specifications may be changed without notification.  
 2. Wiring cable size must comply with the applicable local and national codes. And "Electric characteristics" chapter should be considered for electrical work and design. Especially the power cable and circuit breaker should be selected in accordance with that.  
 3. Power factor could vary less than ±1% according to the operating conditions.  
 4. Sound pressure level is measured on the rated condition in the anechoic rooms by ISO 3745 standard. Sound power level is measured on the rated condition in the reverberation rooms by ISO 3741 standard. Therefore, these values can be increased owing to ambient conditions during operation.  
 5. Performances are based on the following conditions - Cooling : Indoor Ambient Temp. 27°CDB / 19°CWB, Outdoor Ambient Temp. 35°CDB / 24°CWB  
 - Heating : Indoor Ambient Temp. 20°CDB / 15°CWB, Outdoor Ambient Temp. 7°CDB / 6°CWB  
 Interconnected Pipe Length is 7.5m and difference of Elevation (Outdoor - Indoor Unit) is Zero.  
 6. The numbers in parentheses means maximum connectable indoor units in accordance with outdoor units combination. The recommended ratio is 130%.  
 7. This product contains Fluorinated greenhouse gases. (R410A, GWP(Global warming potential) = 2,087.5)

**ARUV761LLS5 / ARUV781LLS5  
ARUV801LLS5**



HP		76	78	80	
<b>Model Name</b>	Combination Unit	ARUV761LLS5	ARUV781LLS5	ARUV801LLS5	
	Independent Unit	ARUV261LLS5 ARUV261LLS5 ARUV241LLS5	ARUV261LLS5 ARUV261LLS5 ARUV261LLS5	ARUV261LLS5 ARUV261LLS5 ARUV161LLS5 ARUV121LLS5	
<b>Capacity</b>	Cooling (Rated)	212.8	218.4	224.0	
		kW	726,100	745,200	764,300
<b>Power Input</b>	Cooling	59.8	62.4	62.4	
<b>COP Cooling</b>		3.56	3.50	3.59	
<b>Power Factor</b>	Rated	0.93	0.93	0.93	
<b>Exterior</b>	Casing Color	Morning Gray / Dawn Gray	Morning Gray / Dawn Gray	Morning Gray / Dawn Gray	
	RAL code	RAL 7038 / RAL 7037	RAL 7038 / RAL 7037	RAL 7038 / RAL 7037	
<b>Heat Exchanger</b>		Wide Louver Plus	Wide Louver Plus	Wide Louver Plus	
<b>Compressor</b>	Type	Hermetically Sealed Scroll	Hermetically Sealed Scroll	Hermetically Sealed Scroll	
	Piston Displacement	cm <sup>3</sup> /rev	62.1 x 6	62.1 x 6	62.1 x 6
	Number of Revolution	rev/min	3,600 x 6	3,600 x 6	3,600 x 6
	Motor Output x Number	W x No.	5,300 x 6	5,300 x 6	5,300 x 6
	Starting Method		Inverter	Inverter	Inverter
	Oil Type		FW68L (PVE)	FW68L (PVE)	FW68L (PVE)
<b>Fan</b>	Type	Propeller Fan	Propeller Fan	Propeller Fan	
	Motor Output x Number	W	900 x 6	900 x 6	(900 x 6) + (1,500 x 1)
	Air Flow Rate (High)	m <sup>3</sup> /min	320 x 3	320 x 3	(320 x 3) + (240 x 1)
	Drive		DC Inverter	DC Inverter	DC Inverter
<b>Pipe Connections For Heat Pump</b>	Liquid Pipe	mm (inch)	Ø 22.2 (7/8)	Ø 22.2 (7/8)	Ø 22.2 (7/8)
	Gas Pipe	mm (inch)	Ø 53.98 (2-1/8)	Ø 53.98 (2-1/8)	Ø 53.98 (2-1/8)
<b>Dimensions (W x H x D)</b>	mm	(1,240 x 1,690 x 760) x 3	(1,240 x 1,690 x 760) x 3	(1,240 x 1,690 x 760) x 3 + (930 x 1,690 x 760) x 1	
<b>Weight</b>	Net	kg	(256.5) + (256.5) + (256.5)	(256.5) + (256.5) + (256.5)	(256.5) + (256.5) + (195.5) + (164)
<b>Sound Pressure Level</b>	Cooling	dB (A)	69.8	69.8	69.2
<b>Communication Cable</b>		No. x mm <sup>2</sup> (VCTF-SB)	2 C x 1.0 - 1.5	2 C x 1.0 - 1.5	2 C x 1.0 - 1.5
<b>Refrigerant</b>	Refrigerant Name		R410A	R410A	R410A
	Precharged Amount in Factory	kg	33.0	33.0	33.2
	GWP		2,087.5	2,087.5	2,087.5
	t-CO <sub>2</sub> eq		68.9	68.9	69.3
	Control		Electronic Expansion Valve	Electronic Expansion Valve	Electronic Expansion Valve
<b>Power Supply</b>		V / Ø / Hz	380-415, 3, 50	380-415, 3, 50	380-415, 3, 50
<b>Number of Maximum Connectable Indoor Units</b>			64	64	64

1. Due to our policy of innovation some specifications may be changed without notification.  
 2. Wiring cable size must comply with the applicable local and national codes. And "Electric characteristics" chapter should be considered for electrical work and design. Especially the power cable and circuit breaker should be selected in accordance with that.  
 3. Power factor could vary less than ±1% according to the operating conditions.  
 4. Sound pressure level is measured on the rated condition in the anechoic rooms by ISO 3745 standard. Sound power level is measured on the rated condition in the reverberation rooms by ISO 3741 standard. Therefore, these values can be increased owing to ambient conditions during operation.  
 5. Performances are based on the following conditions - Cooling : Indoor Ambient Temp. 27°CDB / 19°CWB, Outdoor Ambient Temp. 35°CDB / 24°CWB  
 - Heating : Indoor Ambient Temp. 20°CDB / 15°CWB, Outdoor Ambient Temp. 7°CDB / 6°CWB  
 Interconnected Pipe Length is 7.5m and difference of Elevation (Outdoor - Indoor Unit) is Zero.  
 6. The numbers in parentheses means maximum connectable indoor units in accordance with outdoor units combination. The recommended ratio is 130%.  
 7. This product contains Fluorinated greenhouse gases. (R410A, GWP(Global warming potential) = 2,087.5)

**ARUV821LLS5 / ARUV841LLS5  
ARUV861LLS5**



HP		82	84	86
Model Name	Combination Unit	ARUV821LLS5	ARUV841LLS5	ARUV861LLS5
	Independent Unit	ARUV261LLS5 ARUV261LLS5 ARUV181LLS5 ARUV121LLS5	ARUV261LLS5 ARUV261LLS5 ARUV201LLS5 ARUV121LLS5	ARUV261LLS5 ARUV261LLS5 ARUV221LLS5 ARUV121LLS5
Capacity	Cooling (Rated)	kW 229.6	235.2	240.8
		Btu/h 783,400	802,500	821,600
Power Input	Cooling	kW 62.8	64.6	67.3
COP Cooling		3.66	3.64	3.58
Power Factor	Rated	0.93	0.93	0.93
Exterior	Casing Color	Morning Gray / Dawn Gray	Morning Gray / Dawn Gray	Morning Gray / Dawn Gray
	RAL code	RAL 7038 / RAL 7037	RAL 7038 / RAL 7037	RAL 7038 / RAL 7037
Heat Exchanger		Wide Louver Plus	Wide Louver Plus	Wide Louver Plus
	Type	Hermetically Sealed Scroll	Hermetically Sealed Scroll	Hermetically Sealed Scroll
Compressor	Piston Displacement	cm <sup>3</sup> /rev (62.1 x 5) + (87.6)	(62.1 x 5) + (87.6)	(62.1 x 5) + (87.6)
	Number of Revolution	rev/min 3,600 x 6	3,600 x 6	3,600 x 6
	Motor Output x Number	W x No. (5,300 x 5) + (7,500 x 1)	(5,300 x 5) + (7,500 x 1)	(5,300 x 5) + (7,500 x 1)
	Starting Method	Inverter	Inverter	Inverter
	Oil Type	FW68L (PVE)	FW68L (PVE)	FW68L (PVE)
	Fan	Type	Propeller Fan	Propeller Fan
Fan	Motor Output x Number	W (900 x 6) + (1,500 x 1)	(900 x 6) + (1,500 x 1)	(900 x 6) + (1,500 x 1)
	Air Flow Rate (High)	m <sup>3</sup> /min (320 x 3) + (240 x 1)	(320 x 3) + (240 x 1)	(320 x 3) + (240 x 1)
	Drive	DC Inverter	DC Inverter	DC Inverter
	Discharge	Side / Top TOP	TOP	TOP
Pipe Connections For Heat Pump	Liquid Pipe	mm (inch) Ø 22.2 (7/8)	Ø 22.2 (7/8)	Ø 22.2 (7/8)
	Gas Pipe	mm (inch) Ø 53.98 (2-1/8)	Ø 53.98 (2-1/8)	Ø 53.98 (2-1/8)
Dimensions (W x H x D)	mm	(1,240 x 1,690 x 760) x 3 + (930 x 1,690 x 760) x 1	(1,240 x 1,690 x 760) x 3 + (930 x 1,690 x 760) x 1	(1,240 x 1,690 x 760) x 3 + (930 x 1,690 x 760) x 1
Weight	Net	kg (256.5) + (256.5) + (205) + (164)	(256.5) + (256.5) + (221) + (164)	(256.5) + (256.5) + (221) + (164)
Sound Pressure Level	Cooling	dB (A) 69.4	69.6	69.8
Communication Cable	No. x mm <sup>2</sup> (VCTF-SB)	2 C x 1.0 - 1.5	2 C x 1.0 - 1.5	2 C x 1.0 - 1.5
Refrigerant	Refrigerant Name	R410A	R410A	R410A
	Precharged Amount in Factory	kg 33.2	34.2	34.2
	GWP	2,087.5	2,087.5	2,087.5
	t-CO <sub>2</sub> eq	69.3	71.4	71.4
	Control	Electronic Expansion Valve	Electronic Expansion Valve	Electronic Expansion Valve
Power Supply	V / Ø / Hz	380-415, 3, 50	380-415, 3, 50	380-415, 3, 50
Number of Maximum Connectable Indoor Units		64	64	64

1. Due to our policy of innovation some specifications may be changed without notification.  
 2. Wiring cable size must comply with the applicable local and national codes. And "Electric characteristics" chapter should be considered for electrical work and design. Especially the power cable and circuit breaker should be selected in accordance with that.  
 3. Power factor could vary less than ±1% according to the operating conditions.  
 4. Sound pressure level is measured on the rated condition in the anechoic rooms by ISO 3745 standard. Sound power level is measured on the rated condition in the reverberation rooms by ISO 3741 standard. Therefore, these values can be increased owing to ambient conditions during operation.  
 5. Performances are based on the following conditions - Cooling : Indoor Ambient Temp. 27°CDB / 19°CWB, Outdoor Ambient Temp. 35°CDB / 24°CWB  
 - Heating : Indoor Ambient Temp. 20°CDB / 15°CWB, Outdoor Ambient Temp. 7°CDB / 6°CWB  
 Interconnected Pipe Length is 7.5m and difference of Elevation (Outdoor - Indoor Unit) is Zero.  
 6. The numbers in parentheses means maximum connectable indoor units in accordance with outdoor units combination. The recommended ratio is 130%.  
 7. This product contains Fluorinated greenhouse gases. (R410A, GWP(Global warming potential) = 2,087.5)

**ARUV881LLS5 / ARUV901LLS5  
ARUV921LLS5**



HP		88	90	92
Model Name	Combination Unit	ARUV881LLS5	ARUV901LLS5	ARUV921LLS5
	Independent Unit	ARUV261LLS5 ARUV261LLS5 ARUV241LLS5 ARUV121LLS5	ARUV261LLS5 ARUV261LLS5 ARUV261LLS5 ARUV121LLS5	ARUV261LLS5 ARUV261LLS5 ARUV261LLS5 ARUV141LLS5
Capacity	Cooling (Rated)	kW 246.4	252.0	257.6
		Btu/h 840,700	859,800	879,000
Power Input	Cooling	kW 68.7	71.3	73.0
COP Cooling		3.59	3.53	3.53
Power Factor	Rated	0.93	0.93	0.93
Exterior	Casing Color	Morning Gray / Dawn Gray	Morning Gray / Dawn Gray	Morning Gray / Dawn Gray
	RAL code	RAL 7038 / RAL 7037	RAL 7038 / RAL 7037	RAL 7038 / RAL 7037
Heat Exchanger		Wide Louver Plus	Wide Louver Plus	Wide Louver Plus
	Type	Hermetically Sealed Scroll	Hermetically Sealed Scroll	Hermetically Sealed Scroll
Compressor	Piston Displacement	cm <sup>3</sup> /rev 62.1 x 7	62.1 x 7	62.1 x 7
	Number of Revolution	rev/min 3,600 x 7	3,600 x 7	3,600 x 7
	Motor Output x Number	W x No. 5,300 x 7	5,300 x 7	5,300 x 7
	Starting Method	Inverter	Inverter	Inverter
	Oil Type	FW68L (PVE)	FW68L (PVE)	FW68L (PVE)
	Fan	Type	Propeller Fan	Propeller Fan
Fan	Motor Output x Number	W (900 x 6) + (1,500 x 1)	(900 x 6) + (1,500 x 1)	(900 x 6) + (1,500 x 1)
	Air Flow Rate (High)	m <sup>3</sup> /min (320 x 3) + (240 x 1)	(320 x 3) + (240 x 1)	(320 x 3) + (240 x 1)
	Drive	DC Inverter	DC Inverter	DC Inverter
	Discharge	Side / Top TOP	TOP	TOP
Pipe Connections For Heat Pump	Liquid Pipe	mm (inch) Ø 22.2 (7/8)	Ø 22.2 (7/8)	Ø 22.2 (7/8)
	Gas Pipe	mm (inch) Ø 53.98 (2-1/8)	Ø 53.98 (2-1/8)	Ø 53.98 (2-1/8)
Dimensions (W x H x D)	mm	(1,240 x 1,690 x 760) x 3 + (930 x 1,690 x 760) x 1	(1,240 x 1,690 x 760) x 3 + (930 x 1,690 x 760) x 1	(1,240 x 1,690 x 760) x 3 + (930 x 1,690 x 760) x 1
Weight	Net	kg (256.5) + (256.5) + (256.5) + (164)	(256.5) + (256.5) + (256.5) + (164)	(256.5) + (256.5) + (256.5) + (180)
Sound Pressure Level	Cooling	dB (A) 70.1	70.1	70.2
Communication Cable	No. x mm <sup>2</sup> (VCTF-SB)	2 C x 1.0 - 1.5	2 C x 1.0 - 1.5	2 C x 1.0 - 1.5
Refrigerant	Refrigerant Name	R410A	R410A	R410A
	Precharged Amount in Factory	kg 37.7	37.7	40.5
	GWP	2,087.5	2,087.5	2,087.5
	t-CO <sub>2</sub> eq	78.7	78.7	84.5
	Control	Electronic Expansion Valve	Electronic Expansion Valve	Electronic Expansion Valve
Power Supply	V / Ø / Hz	380-415, 3, 50	380-415, 3, 50	380-415, 3, 50
Number of Maximum Connectable Indoor Units		64	64	64

1. Due to our policy of innovation some specifications may be changed without notification.  
 2. Wiring cable size must comply with the applicable local and national codes. And "Electric characteristics" chapter should be considered for electrical work and design. Especially the power cable and circuit breaker should be selected in accordance with that.  
 3. Power factor could vary less than ±1% according to the operating conditions.  
 4. Sound pressure level is measured on the rated condition in the anechoic rooms by ISO 3745 standard. Sound power level is measured on the rated condition in the reverberation rooms by ISO 3741 standard. Therefore, these values can be increased owing to ambient conditions during operation.  
 5. Performances are based on the following conditions - Cooling : Indoor Ambient Temp. 27°CDB / 19°CWB, Outdoor Ambient Temp. 35°CDB / 24°CWB  
 - Heating : Indoor Ambient Temp. 20°CDB / 15°CWB, Outdoor Ambient Temp. 7°CDB / 6°CWB  
 Interconnected Pipe Length is 7.5m and difference of Elevation (Outdoor - Indoor Unit) is Zero.  
 6. The numbers in parentheses means maximum connectable indoor units in accordance with outdoor units combination. The recommended ratio is 130%.  
 7. This product contains Fluorinated greenhouse gases. (R410A, GWP(Global warming potential) = 2,087.5)



**ARUV941LLS5 / ARU961LLS5  
ARUV981LLS5**



HP		94	96	98
Model Name	Combination Unit	ARUV941LLS5	ARUV961LLS5	ARUV981LLS5
	Independent Unit	ARUV261LLS5 ARUV261LLS5 ARUV261LLS5 ARUV161LLS5	ARUV261LLS5 ARUV261LLS5 ARUV261LLS5 ARUV181LLS5	ARUV261LLS5 ARUV261LLS5 ARUV261LLS5 ARUV201LLS5
Capacity	Cooling (Rated)	kW 263.2	kW 268.8	kW 274.4
		Btu/h 898,100	Btu/h 917,200	Btu/h 936,300
Power Input	Cooling	kW 74.3	kW 74.7	kW 76.5
COP Cooling		3.54	3.60	3.59
Power Factor	Rated	0.93	0.93	0.93
Exterior	Casing Color	Morning Gray / Dawn Gray	Morning Gray / Dawn Gray	Morning Gray / Dawn Gray
	RAL code	RAL 7038 / RAL 7037	RAL 7038 / RAL 7037	RAL 7038 / RAL 7037
Heat Exchanger		Wide Louver Plus	Wide Louver Plus	Wide Louver Plus
	Type	Hermetically Sealed Scroll	Hermetically Sealed Scroll	Hermetically Sealed Scroll
Compressor	Piston Displacement	cm <sup>3</sup> /rev 62.1 × 7	cm <sup>3</sup> /rev (62.1 × 6) + (87.6)	cm <sup>3</sup> /rev (62.1 × 6) + (87.6)
	Number of Revolution	rev/min 3,600 × 7	rev/min 3,600 × 7	rev/min 3,600 × 7
	Motor Output x Number	W x No. 5,300 × 7	W x No. (5,300 × 6) + (7,500 × 1)	W x No. (5,300 × 6) + (7,500 × 1)
	Starting Method	Inverter	Inverter	Inverter
	Oil Type	FW68L (PVE)	FW68L (PVE)	FW68L (PVE)
	Fan	Type	Propeller Fan	Propeller Fan
Fan	Motor Output x Number	W 900 × 8	W 900 × 8	W 900 × 8
	Air Flow Rate (High)	m <sup>3</sup> /min 320 × 4	m <sup>3</sup> /min 320 × 4	m <sup>3</sup> /min 320 × 4
	Drive	DC Inverter	DC Inverter	DC Inverter
	Discharge	Side / Top TOP	Side / Top TOP	Side / Top TOP
Pipe Connections For Heat Pump	Liquid Pipe	mm (inch) Ø 22.2 (7/8)	mm (inch) Ø 22.2 (7/8)	mm (inch) Ø 22.2 (7/8)
	Gas Pipe	mm (inch) Ø 53.98 (2-1/8)	mm (inch) Ø 53.98 (2-1/8)	mm (inch) Ø 53.98 (2-1/8)
Dimensions (W x H x D)	mm	(1,240 × 1,690 × 760) × 4	(1,240 × 1,690 × 760) × 4	(1,240 × 1,690 × 760) × 4
Weight	Net	kg (256.5) + (256.5) + (256.5) + (195.5)	kg (256.5) + (256.5) + (256.5) + (205)	kg (256.5) + (256.5) + (256.5) + (221)
Sound Pressure Level	Cooling	dB (A) 70.3	dB (A) 70.4	dB (A) 70.6
Communication Cable	No. x mm <sup>2</sup> (VCTF-SB)	2 C × 1.0 - 1.5	2 C × 1.0 - 1.5	2 C × 1.0 - 1.5
Refrigerant	Refrigerant Name	R410A	R410A	R410A
	Precharged Amount in Factory	kg 39.5	kg 39.5	kg 40.5
	GWP	2,087.5	2,087.5	2,087.5
	t-CO <sub>2</sub> eq	82.5	82.5	84.5
	Control	Electronic Expansion Valve	Electronic Expansion Valve	Electronic Expansion Valve
Power Supply	V / Ø / Hz	380-415, 3, 50	380-415, 3, 50	380-415, 3, 50
Number of Maximum Connectable Indoor Units		64	64	64

**ARUV1001LLS5 / ARUV1021LLS5  
ARUV1041LLS5**



HP		100	102	104
Model Name	Combination Unit	ARUV1001LLS5	ARUV1021LLS5	ARUV1041LLS5
	Independent Unit	ARUV261LLS5 ARUV261LLS5 ARUV261LLS5 ARUV221LLS5	ARUV261LLS5 ARUV261LLS5 ARUV261LLS5 ARUV241LLS5	ARUV261LLS5 ARUV261LLS5 ARUV261LLS5 ARUV261LLS5
Capacity	Cooling (Rated)	kW 280.0	kW 285.6	kW 291.2
		Btu/h 955,400	Btu/h 974,500	Btu/h 993,600
Power Input	Cooling	kW 79.2	kW 80.6	kW 83.2
COP Cooling		3.54	3.54	3.50
Power Factor	Rated	0.93	0.93	0.93
Exterior	Casing Color	Morning Gray / Dawn Gray	Morning Gray / Dawn Gray	Morning Gray / Dawn Gray
	RAL code	RAL 7038 / RAL 7037	RAL 7038 / RAL 7037	RAL 7038 / RAL 7037
Heat Exchanger		Wide Louver Plus	Wide Louver Plus	Wide Louver Plus
	Type	Hermetically Sealed Scroll	Hermetically Sealed Scroll	Hermetically Sealed Scroll
Compressor	Piston Displacement	cm <sup>3</sup> /rev (62.1 × 6) + (87.6)	cm <sup>3</sup> /rev 62.1 × 8	cm <sup>3</sup> /rev 62.1 × 8
	Number of Revolution	rev/min 3,600 × 7	rev/min 3,600 × 8	rev/min 3,600 × 8
	Motor Output x Number	W x No. (5,300 × 6) + (7,500 × 1)	W x No. 5,300 × 8	W x No. 5,300 × 8
	Starting Method	Inverter	Inverter	Inverter
	Oil Type	FW68L (PVE)	FW68L (PVE)	FW68L (PVE)
	Fan	Type	Propeller Fan	Propeller Fan
Fan	Motor Output x Number	W 900 × 8	W 900 × 8	W 900 × 8
	Air Flow Rate (High)	m <sup>3</sup> /min 320 × 4	m <sup>3</sup> /min 320 × 4	m <sup>3</sup> /min 320 × 4
	Drive	DC Inverter	DC Inverter	DC Inverter
	Discharge	Side / Top TOP	Side / Top TOP	Side / Top TOP
Pipe Connections For Heat Pump	Liquid Pipe	mm (inch) Ø 22.2 (7/8)	mm (inch) Ø 22.2 (7/8)	mm (inch) Ø 22.2 (7/8)
	Gas Pipe	mm (inch) Ø 53.98 (2-1/8)	mm (inch) Ø 53.98 (2-1/8)	mm (inch) Ø 53.98 (2-1/8)
Dimensions (W x H x D)	mm	(1,240 × 1,690 × 760) × 4	(1,240 × 1,690 × 760) × 4	(1,240 × 1,690 × 760) × 4
Weight	Net	kg (256.5) + (256.5) + (256.5) + (221)	kg (256.5) + (256.5) + (256.5) + (256.5)	kg (256.5) + (256.5) + (256.5) + (256.5)
Sound Pressure Level	Cooling	dB (A) 70.8	dB (A) 71.0	dB (A) 71.0
Communication Cable	No. x mm <sup>2</sup> (VCTF-SB)	2 C × 1.0 - 1.5	2 C × 1.0 - 1.5	2 C × 1.0 - 1.5
Refrigerant	Refrigerant Name	R410A	R410A	R410A
	Precharged Amount in Factory	kg 40.5	kg 44.0	kg 44.0
	GWP	2,087.5	2,087.5	2,087.5
	t-CO <sub>2</sub> eq	84.5	91.9	91.9
	Control	Electronic Expansion Valve	Electronic Expansion Valve	Electronic Expansion Valve
Power Supply	V / Ø / Hz	380-415, 3, 50	380-415, 3, 50	380-415, 3, 50
Number of Maximum Connectable Indoor Units		64	64	64

1. Due to our policy of innovation some specifications may be changed without notification.  
 2. Wiring cable size must comply with the applicable local and national codes. And "Electric characteristics" chapter should be considered for electrical work and design. Especially the power cable and circuit breaker should be selected in accordance with that.  
 3. Power factor could vary less than ±1% according to the operating conditions.  
 4. Sound pressure level is measured on the rated condition in the anechoic rooms by ISO 3745 standard. Sound power level is measured on the rated condition in the reverberation rooms by ISO 3741 standard. Therefore, these values can be increased owing to ambient conditions during operation.  
 5. Performances are based on the following conditions - Cooling : Indoor Ambient Temp. 27°CDB / 19°CWB, Outdoor Ambient Temp. 35°CDB / 24°CWB  
 - Heating : Indoor Ambient Temp. 20°CDB / 15°CWB, Outdoor Ambient Temp. 7°CDB / 6°CWB  
 Interconnected Pipe Length is 7.5m and difference of Elevation (Outdoor - Indoor Unit) is Zero.  
 6. The numbers in parentheses means maximum connectable indoor units in accordance with outdoor units combination. The recommended ratio is 130%.  
 7. This product contains Fluorinated greenhouse gases. (R410A, GWP(Global warming potential) = 2,087.5)

1. Due to our policy of innovation some specifications may be changed without notification.  
 2. Wiring cable size must comply with the applicable local and national codes. And "Electric characteristics" chapter should be considered for electrical work and design. Especially the power cable and circuit breaker should be selected in accordance with that.  
 3. Power factor could vary less than ±1% according to the operating conditions.  
 4. Sound pressure level is measured on the rated condition in the anechoic rooms by ISO 3745 standard. Sound power level is measured on the rated condition in the reverberation rooms by ISO 3741 standard. Therefore, these values can be increased owing to ambient conditions during operation.  
 5. Performances are based on the following conditions - Cooling : Indoor Ambient Temp. 27°CDB / 19°CWB, Outdoor Ambient Temp. 35°CDB / 24°CWB  
 - Heating : Indoor Ambient Temp. 20°CDB / 15°CWB, Outdoor Ambient Temp. 7°CDB / 6°CWB  
 Interconnected Pipe Length is 7.5m and difference of Elevation (Outdoor - Indoor Unit) is Zero.  
 6. The numbers in parentheses means maximum connectable indoor units in accordance with outdoor units combination. The recommended ratio is 130%.  
 7. This product contains Fluorinated greenhouse gases. (R410A, GWP(Global warming potential) = 2,087.5)

ARUV081LLS5 / ARUV101LLS5  
ARUV121LLS5 / ARUV141LLS5

[Unit : mm]

No.	Part Name	Description
1	Leakage test hole (Side)	∅ 22.2
2	Wire routing hole (Front)	2-∅ 30
3	Wire routing hole (Bottom)	2-∅ 22.2
4	Power cord routing hole (Front)	2-∅ 40
5	Power cord routing hole (Bottom)	2-∅ 50
6	Pipe routing hole (Front)	-
7	Pipe routing hole (Bottom)	2-∅ 66, ∅ 53.88

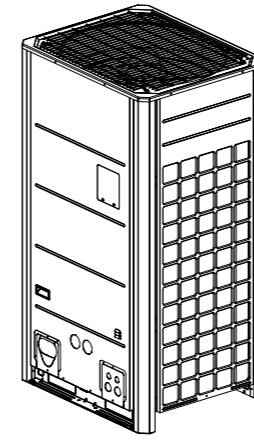

3D View

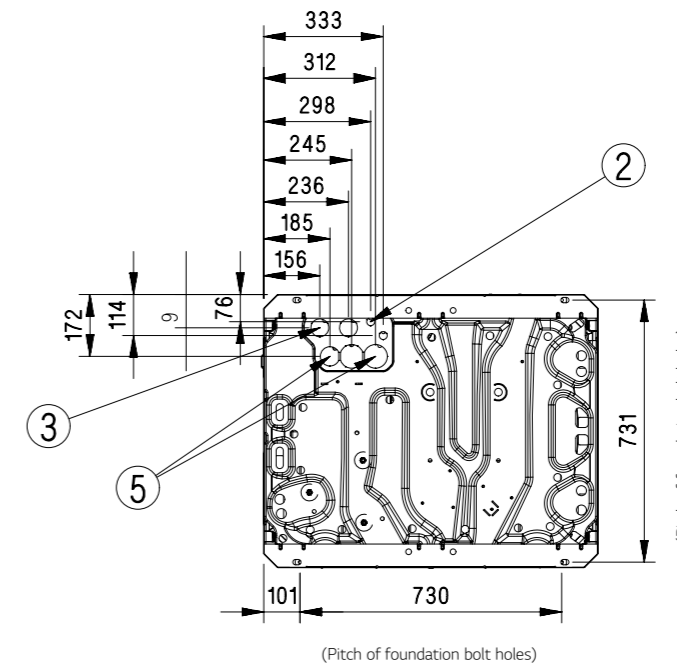
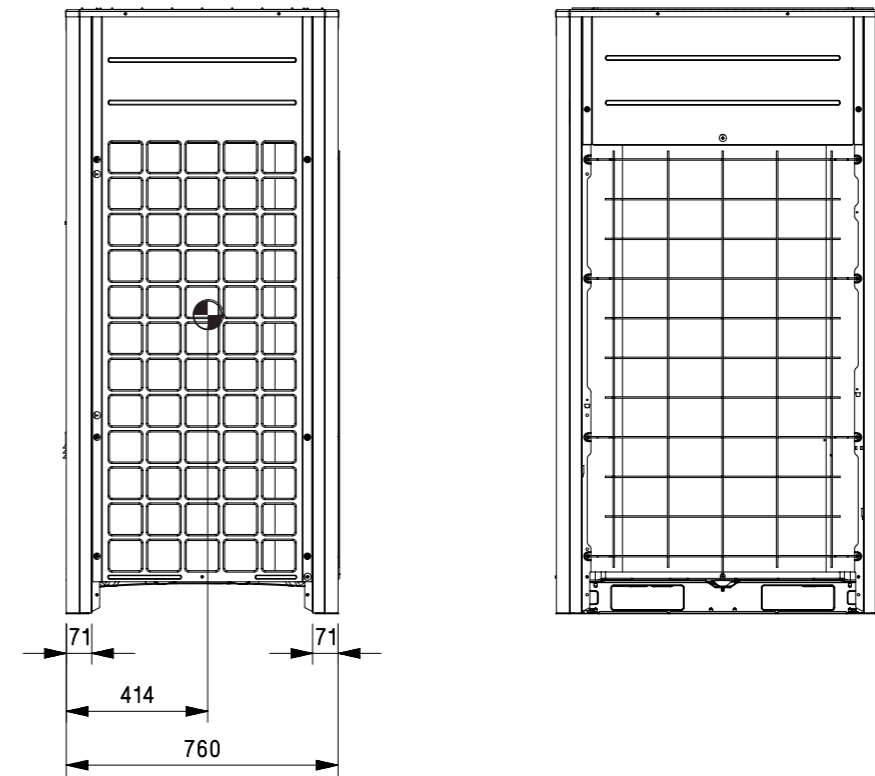
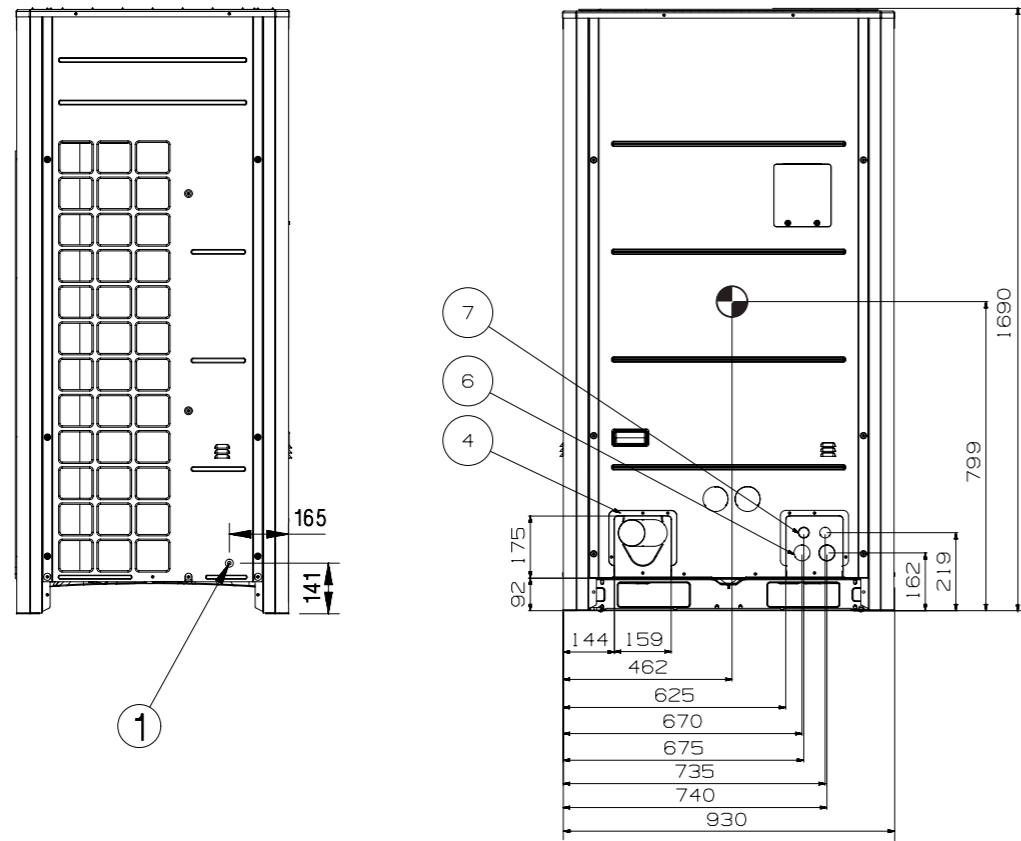
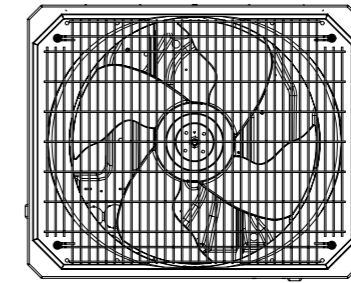

[Unit : mm]

System	Cooling Only	
	Liquid pipe	Gas pipe
8	∅ 9.52 (3/8)	∅ 19.05 (3/4)
10	∅ 9.52 (3/8)	∅ 22.2 (7/8)
12	∅ 12.7 (1/2)	∅ 28.58 (1-1/8)
14	∅ 12.7 (1/2)	∅ 28.58 (1-1/8)

Note

- Unit should be installed in compliance with the installation manual in the product box.
- Unit should be grounded in accordance with the local regulations or applicable national codes.
- All electrical components and materials to be supplied from the site must comply with the local regulations or international codes.
- Electrical characteristics chapter should be considered for electrical work and design. Especially the power cable and circuit breaker should be selected in accordance with that.

ARUV161LLS5 / ARUV181LLS5  
 ARUV201LLS5 / ARUV221LLS5  
 ARUV241LLS5 / ARUV261LLS5

[Unit : mm]

No.	Part Name	Description
1	Leakage test hole (Side)	∅ 22.2
2	Wire routing hole (Front)	2-∅ 30
3	Wire routing hole (Bottom)	2-∅ 22.2
4	Power cord routing hole (Front)	2-∅ 40
5	Power cord routing hole (Bottom)	2-∅ 50
6	Pipe routing hole (Front)	-
7	Pipe routing hole (Bottom)	2-∅ 66, ∅ 53.88

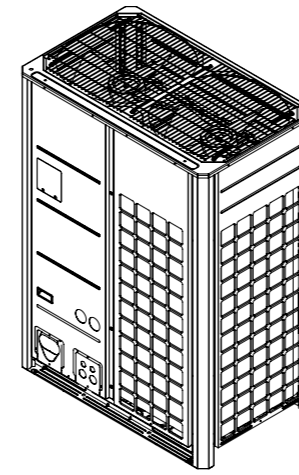

3D View

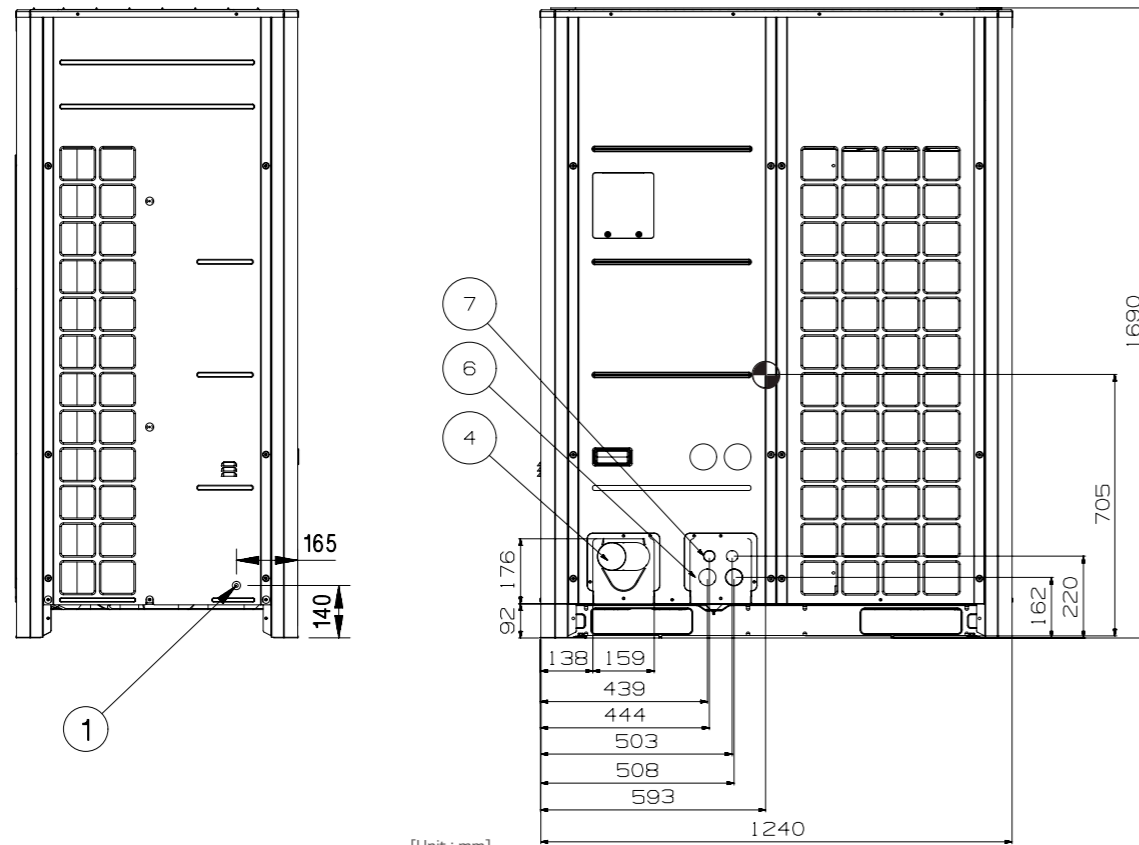
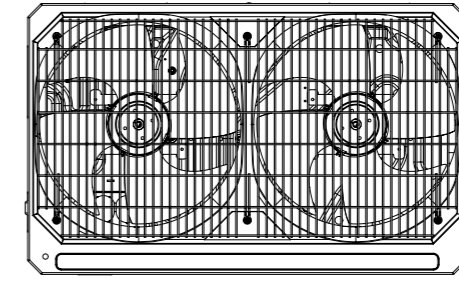

[Unit : mm]

System	Cooling Only	
	Liquid pipe	Gas pipe
HP		
16	∅ 12.7 (1/2)	∅ 28.58 (1-1/8)
18-20	∅ 15.88 (5/8)	∅ 28.58 (1-1/8)
22	∅ 15.88 (5/8)	∅ 28.58 (1-1/8)
24	∅ 15.88 (5/8)	∅ 34.9 (1-3/8)
26-34	∅ 19.05 (3/4)	∅ 34.9 (1-3/8)
36	∅ 19.05 (3/4)	∅ 41.3 (1-5/8)
38-40	∅ 19.05 (3/4)	∅ 41.3 (1-5/8)
42-60	∅ 19.05 (3/4)	∅ 41.3 (1-5/8)
62-64	∅ 22.2 (7/8)	∅ 41.3 (1-5/8)
66-96	∅ 22.2 (7/8)	∅ 53.98 (2-1/8)

Note

- Unit should be installed in compliance with the installation manual in the product box.
- Unit should be grounded in accordance with the local regulations or applicable national codes.
- All electrical components and materials to be supplied from the site must comply with the local regulations or international codes.
- Electrical characteristics chapter should be considered for electrical work and design. Especially the power cable and circuit breaker should be selected in accordance with that.

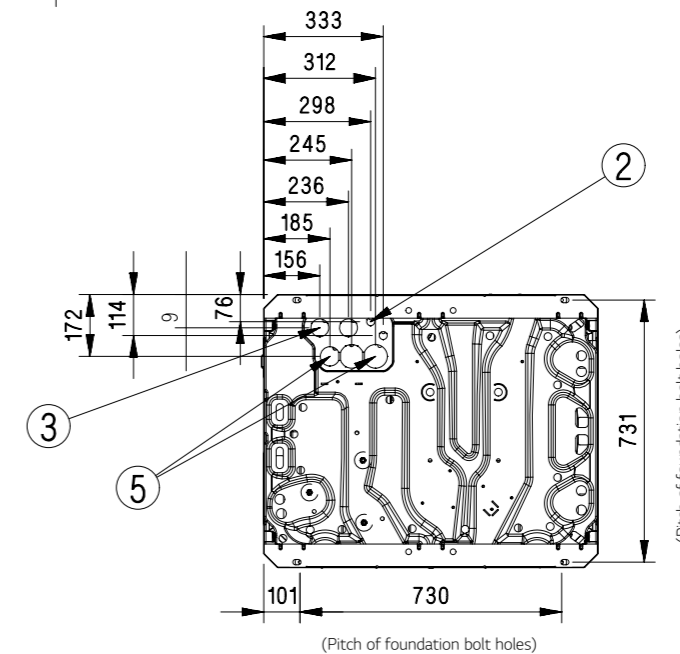
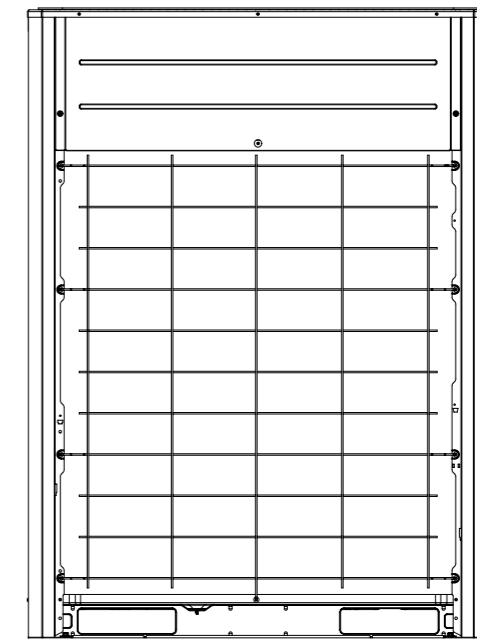
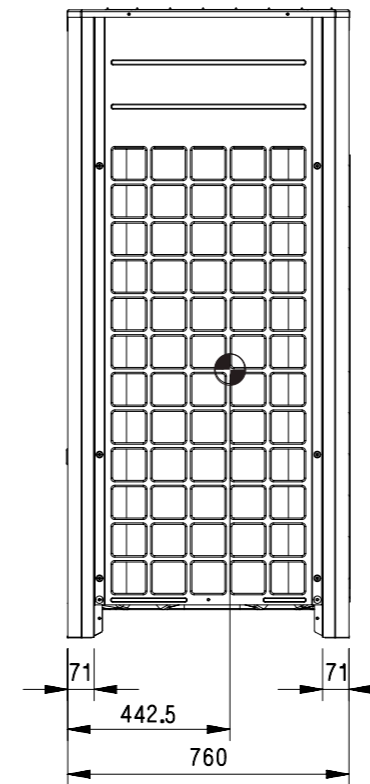

# Example Connection of Communication Cable

## Single Outdoor Unit

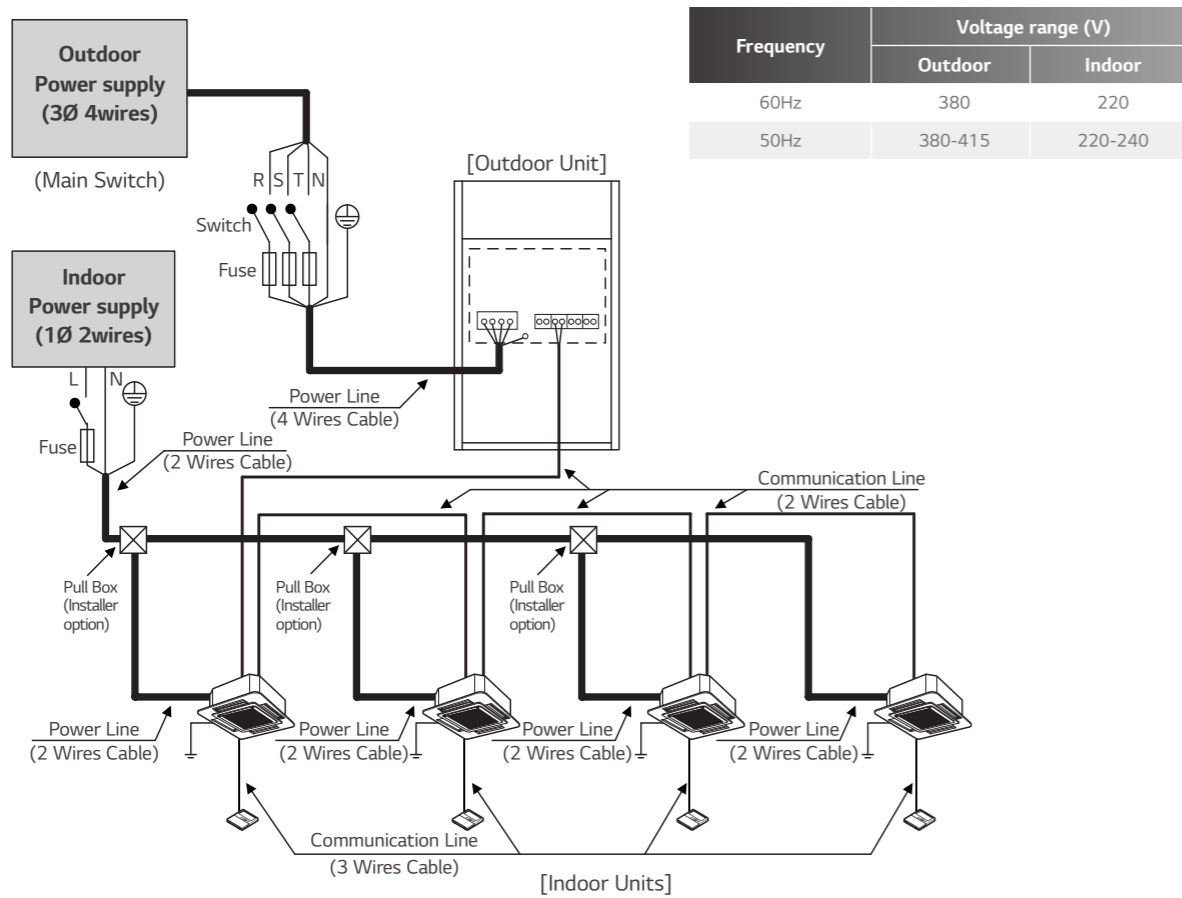

### Warning

- Installation site must require attachment of an earth leakage breaker. If no earth leakage breaker is installed, it may cause an electric shock.
- Indoor Unit ground Lines are required for preventing electrical shock accident during current leakage, Communication disorder by noise effect and motor current leakage (without connection to pipe).
- Don't install an individual switch or electrical outlet to disconnect each of indoor unit separately from the power supply.
- If individual power supply is necessary for each indoor unit, IPM (Independent Power Module) should be applied at each indoor unit. (optional)
- Install the main switch that can interrupt all the power sources in an integrated manner because this system consists of the equipment utilizing the multiple power sources.
- If there exists the possibility of reversed phase, lose phase, momentary blackout or the power goes on and off while the product is operating, attach a reversed phase protection circuit locally.
- Running the product in reversed phase may break the compressor and other parts.

Between Indoor and Master Outdoor unit

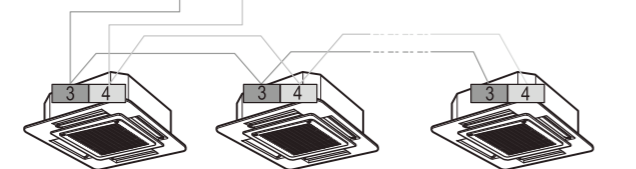
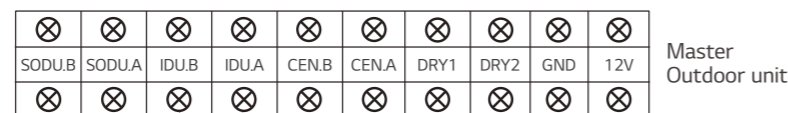

The GND terminal at the main PCB is a '-' terminal for day contact, it is not the point to make ground connection.

## Series Outdoor Unit

When the power source is connected in series between the units.

Frequency	Voltage range (V)	
	Outdoor	Indoor
60Hz	380	220
50Hz	380-415	220-240

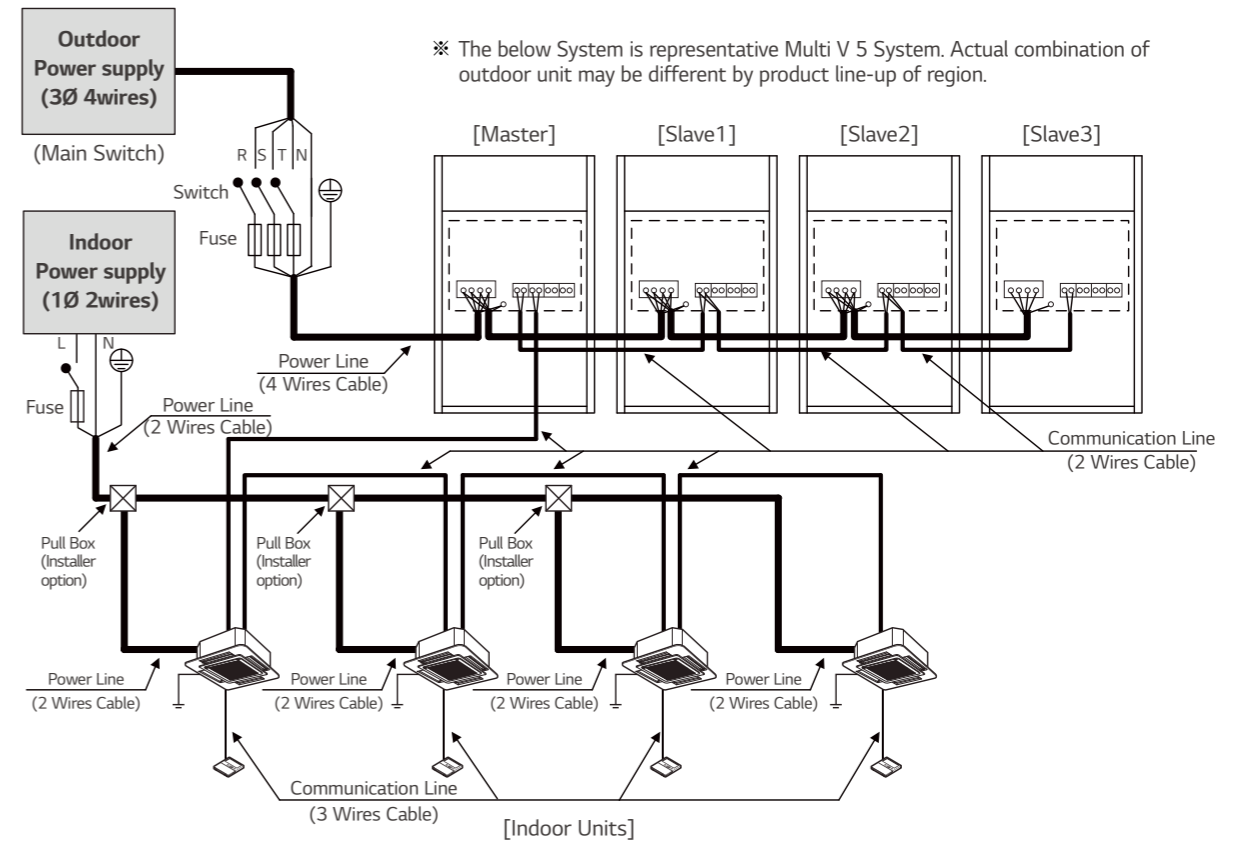

### Warning

When the total capacity is over than 68Hp, do not use single power source for connecting series units. The First terminal block could be burnt out.

When the power source is supplied to Each outdoor unit individually.

Frequency	Voltage range (V)	
	Outdoor	Indoor
60Hz	380	220
50Hz	380-415	220-240

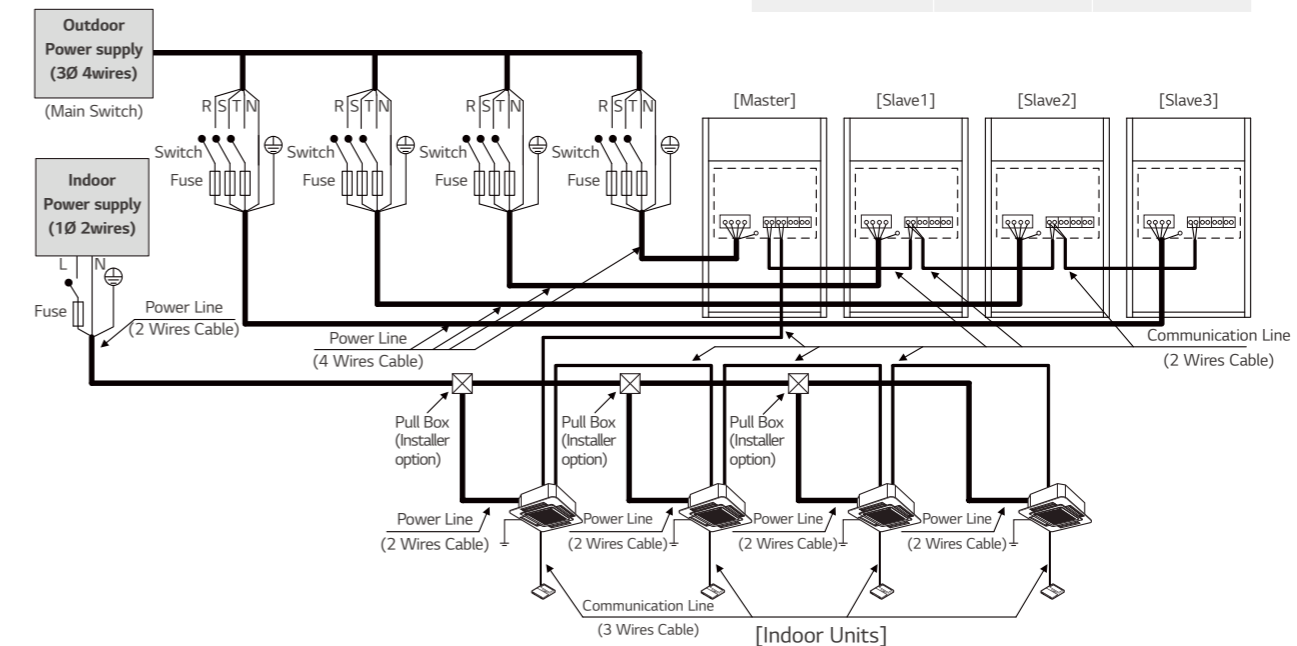

**Warning**

- Installation site must require attachment of an earth leakage breaker. If no earth leakage breaker is installed, it may cause an electric shock.
- Indoor Unit ground Lines are required for preventing electrical shock accident during current leakage, Communication disorder by noise effect and motor current leakage (without connection to pipe).
- Don't install an individual switch or electrical outlet to disconnect each of indoor unit separately from the power supply.
- If individual power supply is necessary for each indoor unit, IPM (Independent Power Module) should be applied at each indoor unit. (optional)
- Install the main switch that can interrupt all the power sources in an integrated manner because this system consists of the equipment utilizing the multiple power sources.
- If there exists the possibility of reversed phase, lose phase, momentary blackout or the power goes on and off while the product is operating, attach a reversed phase protection circuit locally.
- Running the product in reversed phase may break the compressor and other parts.

**Between Indoor and Master Outdoor unit**

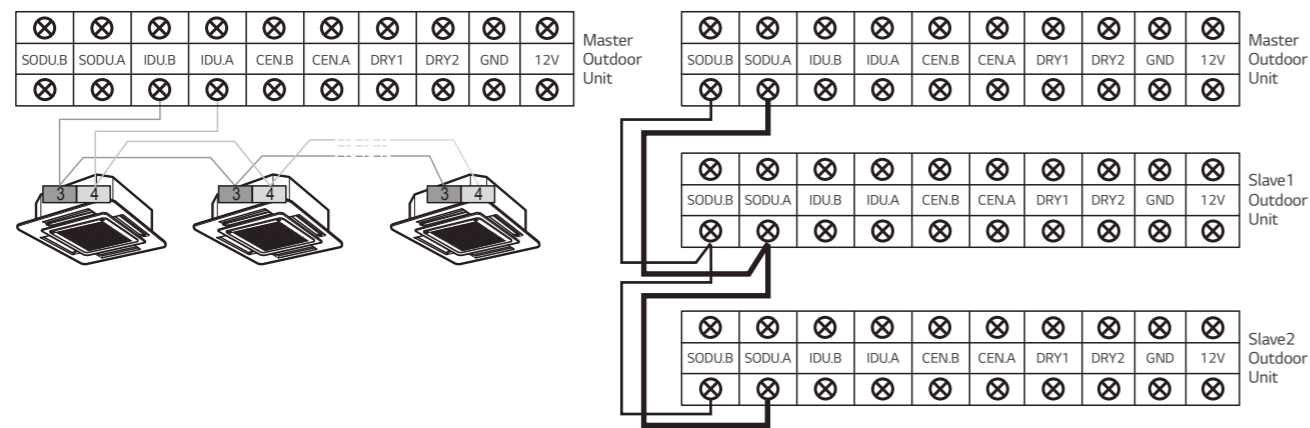

The GND terminal at the main PCB is a '-' terminal for dry contact. It is not the point to make ground connection.

- Make sure that terminal number of master and slave outdoor units are matched.(A-A,B-B)

**Example Connection of Communication Cable**

Connection of communication cable must be installed like below figure between indoor unit to outdoor unit.

Abnormal operation can be caused by communication defect, when connection of communication cable is installed like below figure.

BUS Type

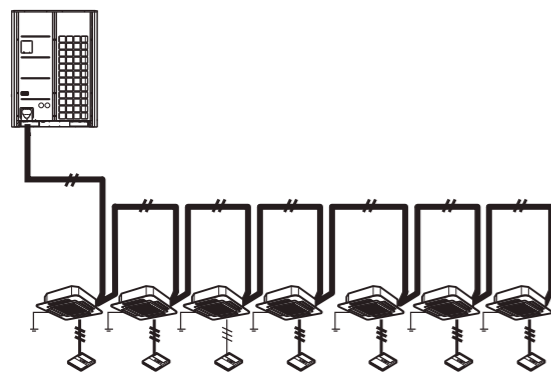

STAR Type

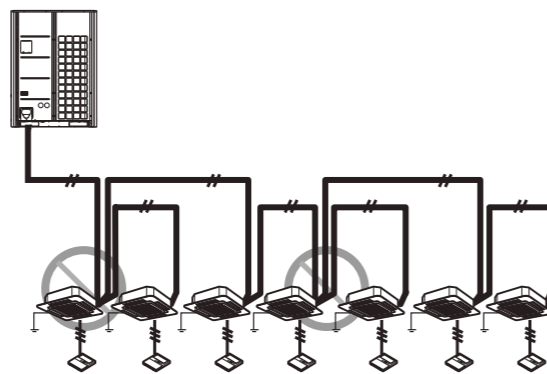

**Wiring of Main Power Supply and Equipment Capacity**

1. Use a separate power supply for the Outdoor Unit and Indoor Unit.
2. Bear in mind ambient conditions (ambient temperature,direct sunlight, rain liquid,etc.) when proceeding with the wiring and connections
3. The wire size is the minimum value for metal conduit wiring. The power cord size should be 1 rank thicker taking into account the line voltage drops. Make sure the power-supply voltage does not drop more than 10%.
4. Specific wiring requirements should adhere to the wiring regulations of the region.
5. Power supply cords of parts of appliances for outdoor use should not be lighter than polychloroprene sheathed flexible cord (design 60245 IEC57).
6. Don't install an individual switch or electrical outlet to disconnect each of indoor unit separately from the power supply.

**Warning**

- Follow ordinance of local regulation for technical standard related to electrical equipment, wiring regulations and guidance of each electric power company.
- Make sure to use specified wires for connections so that no external force is imparted to terminal connections. If connections are not fixed firmly, it may cause heating or fire.
- Make sure to use the appropriate type of overcurrent protection switch. Note that generated overcurrent may include some amount of direct current.
- Installation site must require attachment of an earth leakage breaker. If no earth leakage breaker is installed, it may cause an electric shock.

**Caution**

- Do not use anything other than breaker and fuse with correct capacity. Using fuse and wire or copper wire with too large capacity may cause a malfunction of unit or fire.

## Wiring of Main Power Supply and Equipment Capacity

Model	Unit			Power Supply			COMP		OFM	
	Hz	Volts	Voltage-range	MCA	TOCA	MFA	MSC	RLA(Cooling)		
8 HP	50	380-415	Min : 342, Max: 456	19.3	20.0	20.0	5.9	5.8	1.2	2.5
10 HP	50	380-415	Min : 342, Max: 456	23.3	24.0	25.0	5.9	8.6	1.2	2.5
12 HP	50	380-415	Min : 342, Max: 456	23.3	25.0	25.0	5.9	12.0	1.2	2.5
14 HP	50	380-415	Min : 342, Max: 456	26.1	29.0	32.0	5.9	14.8	1.2	2.5
16 HP	50	380-415	Min : 342, Max: 456	27.3	30.0	32.0	5.9	16.9	1.8	2.5
18 HP	50	380-415	Min : 342, Max: 456	31.8	35.0	35.0	7.5	17.6	1.8	2.5
20 HP	50	380-415	Min : 342, Max: 456	35.5	39.0	40.0	7.5	20.5	1.8	2.5
22 HP	50	380-415	Min : 342, Max: 456	37.8	42.0	45.0	7.5	24.9	1.8	2.5
24 HP	50	380-415	Min : 342, Max: 456	45.5	50.0	50.0	11.8	27.2	1.8	2.5
26 HP	50	380-415	Min : 342, Max: 456	54.5	60.0	60.0	11.8	31.5	1.8	2.5
28 HP	50	380-415	Min : 342, Max: 456	50.6	55.0	57.0	11.8	28.9	3.0	5.0
30 HP	50	380-415	Min : 342, Max: 456	55.1	60.0	60.0	13.4	29.6	3.0	5.0
32 HP	50	380-415	Min : 342, Max: 456	58.8	64.0	65.0	13.4	32.6	3.0	5.0
34 HP	50	380-415	Min : 342, Max: 456	61.1	67.0	70.0	13.4	36.9	3.0	5.0
36 HP	50	380-415	Min : 342, Max: 456	68.8	75.0	75.0	17.7	39.2	3.0	5.0
38 HP	50	380-415	Min : 342, Max: 456	77.8	85.0	85.0	17.7	43.5	3.0	5.0
40 HP	50	380-415	Min : 342, Max: 456	80.6	89.0	92.0	17.7	36.3	3.0	5.0
42 HP	50	380-415	Min : 342, Max: 456	81.8	90.0	92.0	17.7	48.4	3.6	5.0
44 HP	50	380-415	Min : 342, Max: 456	86.3	95.0	95.0	19.3	49.1	3.6	5.0
46 HP	50	380-415	Min : 342, Max: 456	90.0	99.0	100.0	19.3	52.0	3.6	5.0
48 HP	50	380-415	Min : 342, Max: 456	92.3	102.0	105.0	19.3	56.4	3.6	5.0
50 HP	50	380-415	Min : 342, Max: 456	100.0	110.0	110.0	23.6	58.7	3.6	5.0
52 HP	50	380-415	Min : 342, Max: 456	109.0	120.0	120.0	23.6	63.0	3.6	5.0
54 HP	50	380-415	Min : 342, Max: 456	105.1	115.0	117.0	23.6	60.4	4.8	7.5
56 HP	50	380-415	Min : 342, Max: 456	109.6	120.0	120.0	25.2	61.1	4.8	7.5
58 HP	50	380-415	Min : 342, Max: 456	113.3	124.0	125.0	25.2	64.0	4.8	7.5
60 HP	50	380-415	Min : 342, Max: 456	115.6	127.0	130.0	25.2	68.4	4.8	7.5
62 HP	50	380-415	Min : 342, Max: 456	123.3	135.0	135.0	29.5	70.7	4.8	7.5
64 HP	50	380-415	Min : 342, Max: 456	132.3	145.0	145.0	29.5	75.0	4.8	7.5
66 HP	50	380-415	Min : 342, Max: 456	135.1	149.0	152.0	29.5	77.8	4.8	7.5
68 HP	50	380-415	Min : 342, Max: 456	136.3	150.0	152.0	29.5	79.9	5.4	7.5
70 HP	50	380-415	Min : 342, Max: 456	140.8	155.0	155.0	31.1	80.6	5.4	7.5
72 HP	50	380-415	Min : 342, Max: 456	144.5	159.0	160.0	31.1	83.5	5.4	7.5
74 HP	50	380-415	Min : 342, Max: 456	146.8	162.0	165.0	31.1	87.9	5.4	7.5
76 HP	50	380-415	Min : 342, Max: 456	154.5	170.0	170.0	35.4	90.2	5.4	7.5
78 HP	50	380-415	Min : 342, Max: 456	163.5	180.0	180.0	35.4	94.5	5.4	7.5
80 HP	50	380-415	Min : 342, Max: 456	159.6	175.0	177.0	35.4	91.9	6.6	10.0
82 HP	50	380-415	Min : 342, Max: 456	164.1	180.0	180.0	37.0	92.6	6.6	10.0
84 HP	50	380-415	Min : 342, Max: 456	167.8	184.0	185.0	37.0	95.5	6.6	10.0
86 HP	50	380-415	Min : 342, Max: 456	170.1	187.0	190.0	37.0	99.9	6.6	10.0
88 HP	50	380-415	Min : 342, Max: 456	177.8	195.0	195.0	41.3	102.2	6.6	10.0

90 HP	50	380-415	Min : 342, Max: 456	186.8	205.0	205.0	41.3	106.5	6.6	10.0
92 HP	50	380-415	Min : 342, Max: 456	189.6	209.0	212.0	41.3	109.3	6.6	10.0
94 HP	50	380-415	Min : 342, Max: 456	190.8	210.0	212.0	41.3	111.4	7.2	10.0
96 HP	50	380-415	Min : 342, Max: 456	195.3	215.0	215.0	42.9	112.1	7.2	10.0
98 HP	50	380-415	Min : 342, Max: 456	199.0	219.0	220.0	42.9	115.0	7.2	10.0
100 HP	50	380-415	Min : 342, Max: 456	201.3	222.0	225.0	42.9	119.4	7.2	10.0
102 HP	50	380-415	Min : 342, Max: 456	209.0	230.0	230.0	47.2	121.7	7.2	10.0
104 HP	50	380-415	Min : 342, Max: 456	218.0	240.0	240.0	47.2	126.0	7.2	10.0

**Note**

1. Voltage supplied to the unit terminals should be within the minimum and maximum range.
2. Maximum allowable voltage unbalance between phase is 2%.
3. MSC means the Max. current during the starting of compressor.
4. MSC and RLA are measured as the compressor only test condition.
5. OFM are measured as the outdoor unit test condition.
6. TOCA means the total over current value of each outdoor unit.
7. Select the wire size based on the larger value among MCA or TOCA.
8. MFA is recommended fuse amps.
9. TOCA is minimum required amperes for selecting the circuit breaker and ground fault circuit interrupter. Please select the circuit breaker size equal or greater than TOCA. All installation site must require attachment of an earth leakage breaker.[Circuit breaker type is ELCB (Earth Leakage Circuit Breaker)].
10. Select the electrical equipment of combination unit according to the electrical characteristics of individual unit.

**Symbols**

- MCA** : Minimum Circuit Amperes (A)  
**TOCA** : Total Over Current Amperes (A)  
**MFA** : Maximum Fuse Amperes (A)  
**MSC** : Maximum Starting Current (A)  
**RLA** : Rated Load Amperes (A)  
**OFM** : Outdoor Fan Motor  
**kW** : Fan Motor rated output (kW)  
**FLA** : Full Load Amperes (A)









## LG ELECTRONICS VIETNAM

**Hanoi** 35F, Keangnam Landmark 72, Pham Hung str., Nam Tu Liem Dist. – Tel: 024 3934 5151

**Hochiminh** 12F Sofic Tower, 10 Mai Chi Tho str., Thu Thiem, Thu Duc City – Tel: 028 3925 6886

**Danang** 9F, Indochina Building, 74 Bach Dang str. – Tel: 0236 3691 307

**Nhatrang** 7F, Nha Trang Building, 42 Le Thanh Phuong str. – Tel: 0258 3813 468

**Halong** Shophouse, Lot D2 – 06, Ha Long Marine Plaza, Bai Chay – Tel: 0203 3900 369

**Hotline** 1800 1503

[www.lg.com/vn/business](http://www.lg.com/vn/business) | [www.partner.lge.com](http://www.partner.lge.com)



LG HVAC Vietnam



LG Viet Nam

\*For continual product development, LG reserves the right to change specifications or design without notice

**\*Note**

This product uses inverter technology, so it can generate harmonics. If local law or the Investor requires harmonic suppression at the construction site, please coordinate with the electrical design unit to take measures to suppress harmonics. Contact your supplier for more detailed information on the electrical characteristics of LG air conditioners.

