

LG Electronics









Ahead of the Expected
with LG HVAC Solutions



MULTI V™ i

Intelligent, Innovative, Interactive,
MULTI V™ i with AI Technology

OUTDOOR UNITS LINE-UP

Features	Appearance	8	10	12	14	16	18	20	22	24	
<p>MULTI VTM i</p> <ul style="list-style-type: none"> • Large capacity ODU (Up to 26 HP) • Powerful cooling / heating performance • Flexible ODU combination • AI efficiency / comfort / smart up • Scability to various application • Black Fin heat exchanger • Large space, Individual control building <div style="display: flex; justify-content: space-around; align-items: center;"> <div style="text-align: center;">  <p>Shopping mall</p> </div> <div style="text-align: center;">  <p>Education</p> </div> <div style="text-align: center;">  <p>Office</p> </div> </div>		●	●	●							
					●	●	●	●	●	●	●
											
											
											

● Heat Pump □ Cooling Only

26	28	30	32	34	36	38	40	42	44	46	48	50	52	54	56	58	60	62	64	66	68	70	72	74	76	78	80	...	96
●																													
	●	●	●	●	●	●	●	●	●	●	●																		
												●	●	●	●	●	●	●	●	●	●	●	●						
																								●	●	●	●	●	●

MULTI V™ i

Highlight



Higher Energy
Efficiency



Optimal
Comfort



Full Cooling
Performance up to 43°C



High
Reliability

- Energy Saving with AI Engine
- AI Smart Diagnosis
- Large Storage Black Box
- Remote Upgrade System
- Corrosion Resistance Exterior
- Flexible Combination of Outdoor Units





OUTDOOR UNITS

MULTI V ?

MARKET TREND IN ASIA

More energy efficient HVAC systems are required to significantly reduce energy consumption and to meet stricter energy regulations on buildings.



Necessity of Energy Saving

- Electricity prices are constantly rising
- Cooling is also estimated to account for almost 30% of its peak electricity demand by 2040

Growing demand for energy-efficient solutions

Electricity demand for ASEAN residential end uses

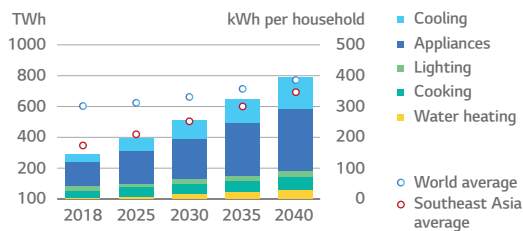

Source : IEA.org (Roadmap for Energy-Efficient Buildings and Construction in ASEAN)



Climate Neutrality

- To keep warming to 1.5 degrees, countries must cut carbon dioxide emissions by 45% compared to 2010 levels by 2030
- Global carbon dioxide emissions need to reach net-zero emissions by 2050.

The demand of environmentally friendly HVAC units is expected to rise for reducing carbon footprint

Asia's Race to Net-Zero by 2030

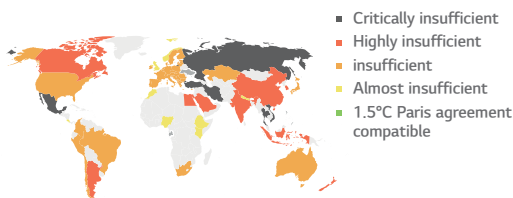

<https://climateactiontracker.org/countries/>



Advances in technology

- Smart HVAC technologies are becoming increasingly popular in building automation.
- HVAC technologies integrated with IoT are in high demand in the smart homes industry.

Growing demand for smart solutions in HVAC





LG

MULTI V

AV

MULTI V BRAND HISTORY

MULTI V is recognized for its technology and innovativeness.

AI Engine **NEW**

MULTI V™ i

Superior customer experience
with AI Technology

*i*ntelligent

*i*nnovative

*i*nteractive

Dual Sensing

MULTI V™ 5

Efficiency and Comfort
with dual sensing control

All Inverter



HISTORY OF MULTI V LEADERSHIP

2013

MULTI V™ IV

- Active Refrigerant Control
- Variable Heat Exchanger Circuit
- Smart Load Control
- Smart Oil Return
- Vapor Injection (Advanced)

2017

MULTI V™ 5

- Dual Sensing Control
- Ultimate Inverter Compressor
- Large Capacity ODU with Biomimetic Technology Fan
- Continuous Heating
- Ocean Black Fin

2023

MULTI V™ i

- Energy Saving with AI engine
- Corrosion Resistance Exterior
- Smart Diagnosis Reporting
- Remote Upgrade System
- Weather Reference Operation



LG Vietnam Air Conditioning Academy

In order to support partners and customers to learn about products, LG Commercial Air Conditioning industry has 3 Academy locations across the country.

Not only a space for product display and product experience, LG Academy also organizes frequent training programs, providing knowledge about design and installation for LG customers and partners, including but not limited to : investors, contractors, design and installation consultants, and refrigeration students in the community.

- Hanoi 27 Le Van Luong, Thanh Xuan District
- TPHCM 65 Truong Dinh, District 3
- Da Nang 89 Nguyen Thi Minh Khai, Hai Chau District

HI-M SOLUTEK VIETNAM

Hi-M Solutek Vietnam is LG subsidiary of LG Electronics that specializes in HVAC service and maintenance with nationwide coverage

Hi-M SOLUTEK provides the following services: Service and maintenance for VRF Multi V and Chiller; Remote maintenance management service on the Becon Cloud platform.

- Hanoi Floor 35, Keangnam Landmark 72, Cau Giay District
- Hai Phong Phuong Chu Dong, Truong Thanh Commune, An Lao District
- Da Nang Floor 9, Indochina Building, 74 Bach Dang, Hai Chau District
- Nha Trang Floor 7, Nha Trang Building, Phuong Sai District
- HCM 65 Truong Dinh, District 3

- LG Office
- LG Academy
- Hi-M Solutek

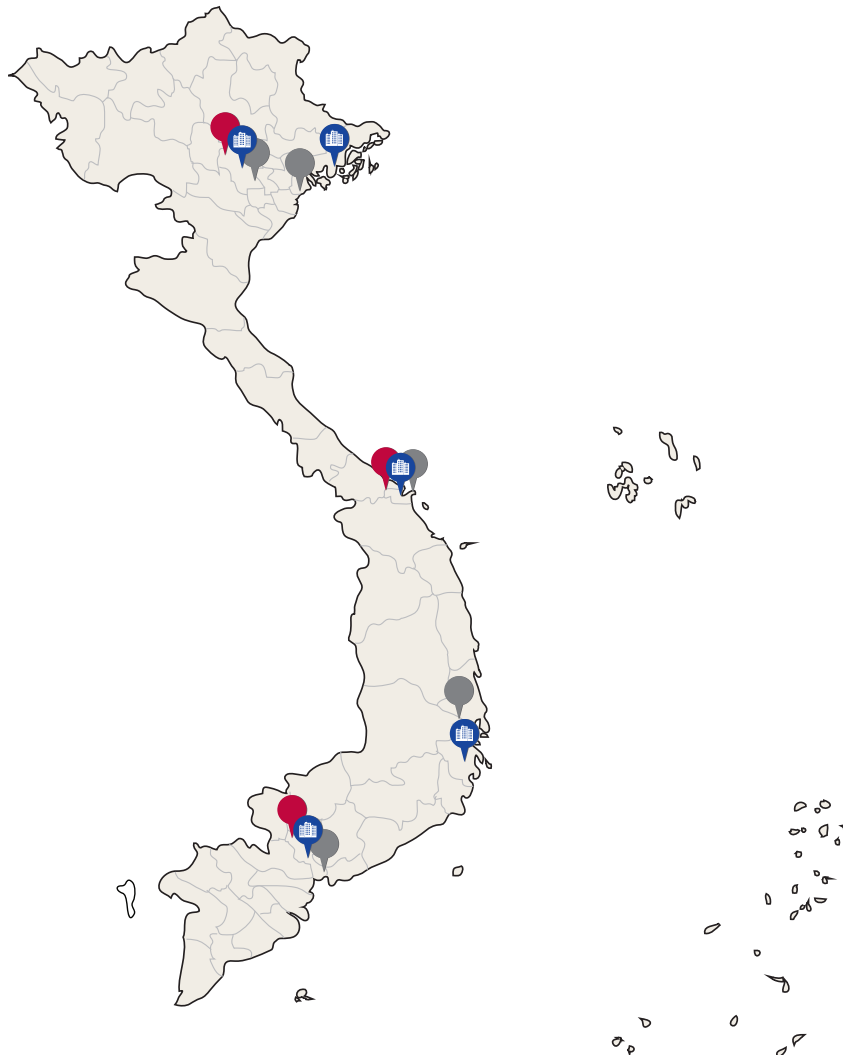

01 INTELLIGENT



Various Environment Recognition & Optimized Operation Itself with AI Engine

- Outstanding Energy Efficiency
- AI Smart Care
- AI Indoor Space Care
- AI Smart Metering
- AI Energy Management

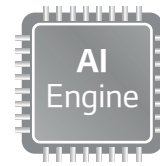

Superior Customer Experience with **AI technology**

02 INNOVATIVE

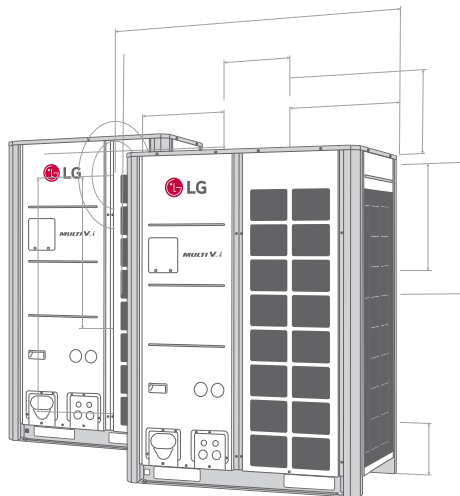

Innovative Energy Efficiency / Performance Realization

- Corrosion Resistance
- Widen Heat Exchanger
- HiPOR™
- Maximum 26 HP for a Single Outdoor Unit
- Compact Size with Larger Capacity
- Powerful Cooling Performance
- Newly Designed Fan & Orifice

03 INTERACTIVE

Upgrading & Evolutionary System according to Customer

- Flexible Combination of Outdoor Units
- Noise Target Control
- Weather Information Interlocking Control
- AI Smart Diagnosis
- Large Storage Black Box
- Auto Tuning System
- Remote Upgrade System
- LG BECON cloud
- Control Solution with MULTI V i
- Total Piping Length



Interlocking System

- **A/C**
(Air Conditioner)
- **LG AHU**
- **Valve / Pump**
AO (Analog Output)
- **Occupancy Sensor / Alarm / Key-tag**
DI (Digital Input)
- **Fan / Lighting / Switch**
DO (Digital Output)
- **Temperature / Humidity / CO₂ Sensor**
AI (Analog Input)



Outstanding Energy Efficiency

MULTI V *i* enables economical operation with excellent energy efficiency improved over previous version that was already unrivaled in the market.

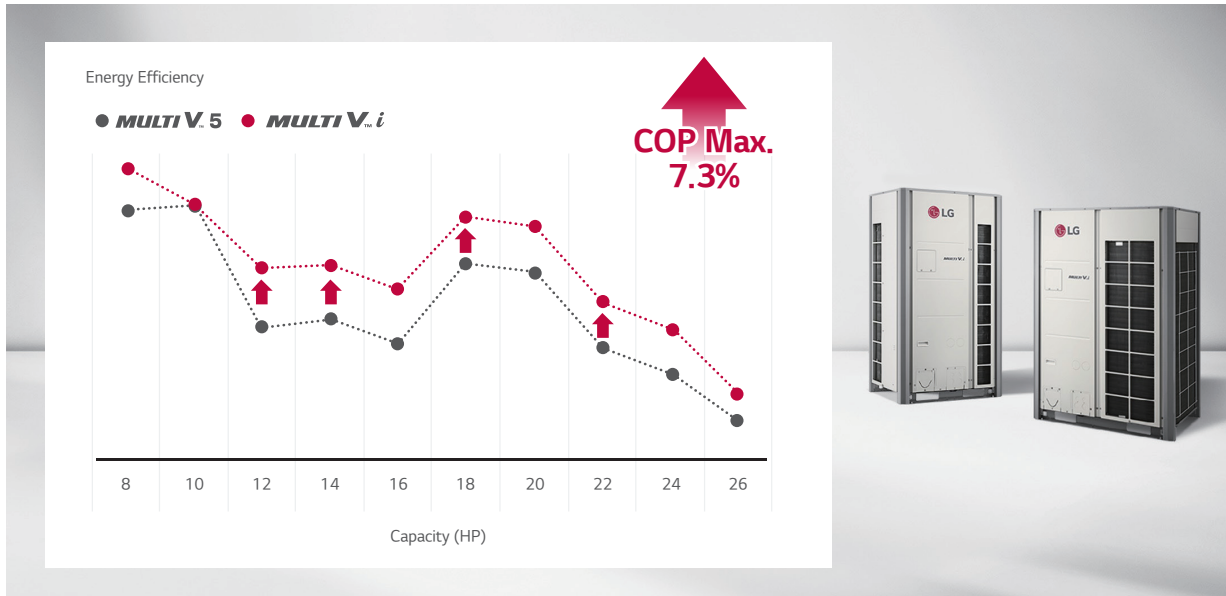

※ Cooling COP is EER (Energy Efficiency Ratio).
 ※ The 7.3% improvement is not for entire line up.
 ※ The 7.3% improvement is a comparison between ARUN120LTE5 (MULTI V 5) and ARUN120LTE6 (MULTI V *i*).

AI Smart Care

MULTI V *i* can control itself according to various situations for comfortable space and energy saving. MULTI V *i* is equipped with machine learning algorithms that enable it to self-learn.

Data Collecting and Saving from IDU & ODU

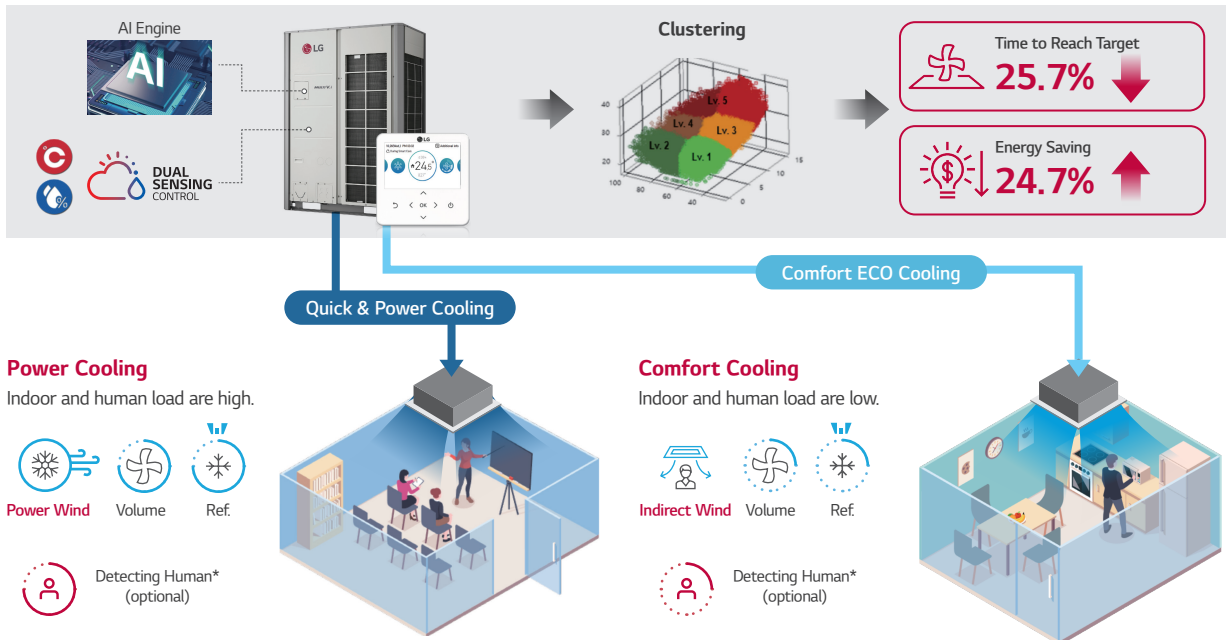

* The Human Detection Sensor is an optional accessory (PTVSA0).
 ※ This is the result from internal test that is followed KS Test Standard (24 HP model of MULTI V / KS B ISO 15042 : 2006).
 ※ The result may vary depending on the applied model, local temperature, and environment.
 ※ This function can be used only when all indoor units are either in cooling mode or in heating mode.
 ※ This function may or may not be applied depending on the indoor unit.

AI Indoor Space Care

Achieving balanced temperatures for space comfort, MULTI V i identifies adjacent indoor units and then defines a virtual group, they automatically turn on / off according to the load.

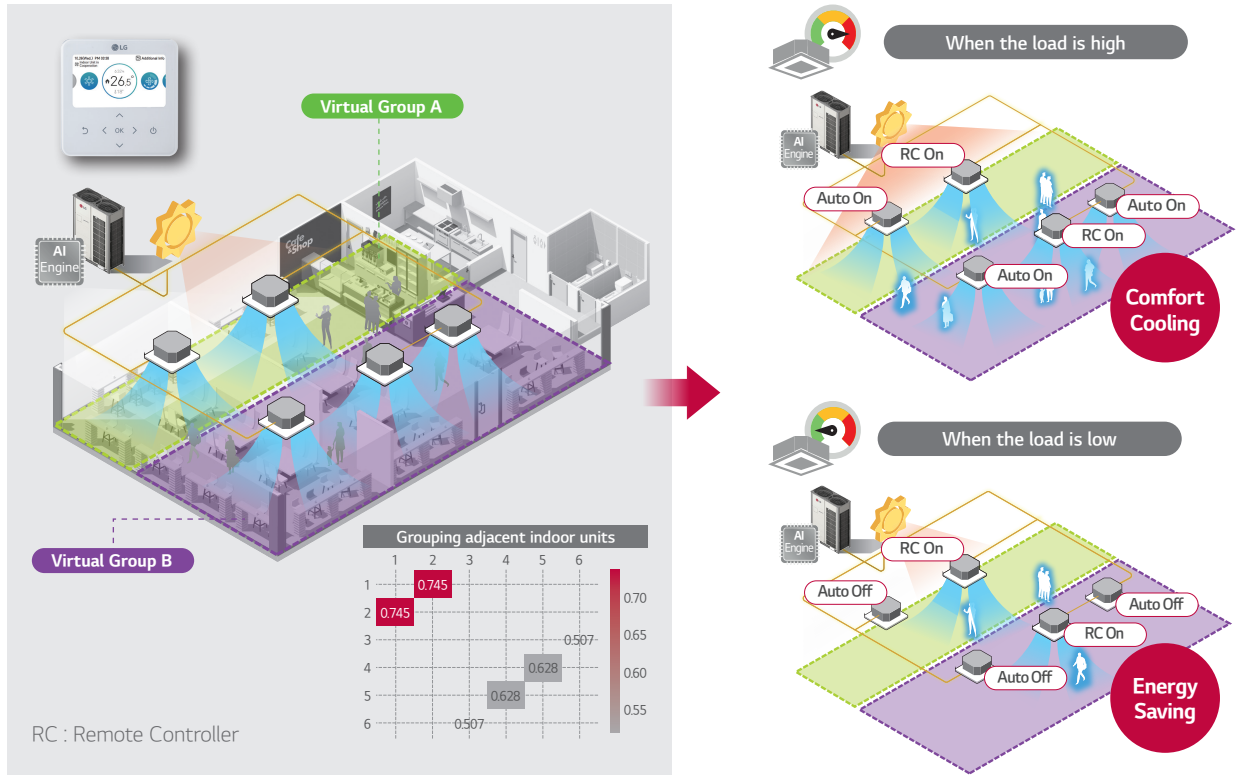

※ This function can be used only when all indoor units are either in cooling mode or in heating mode.
 ※ This function may operate differently depending on the indoor unit.
 ※ This function may or may not be applied depending on the indoor unit.

AI Smart Metering

It is possible to check the estimated energy savings of the system by using AI Smart Care.

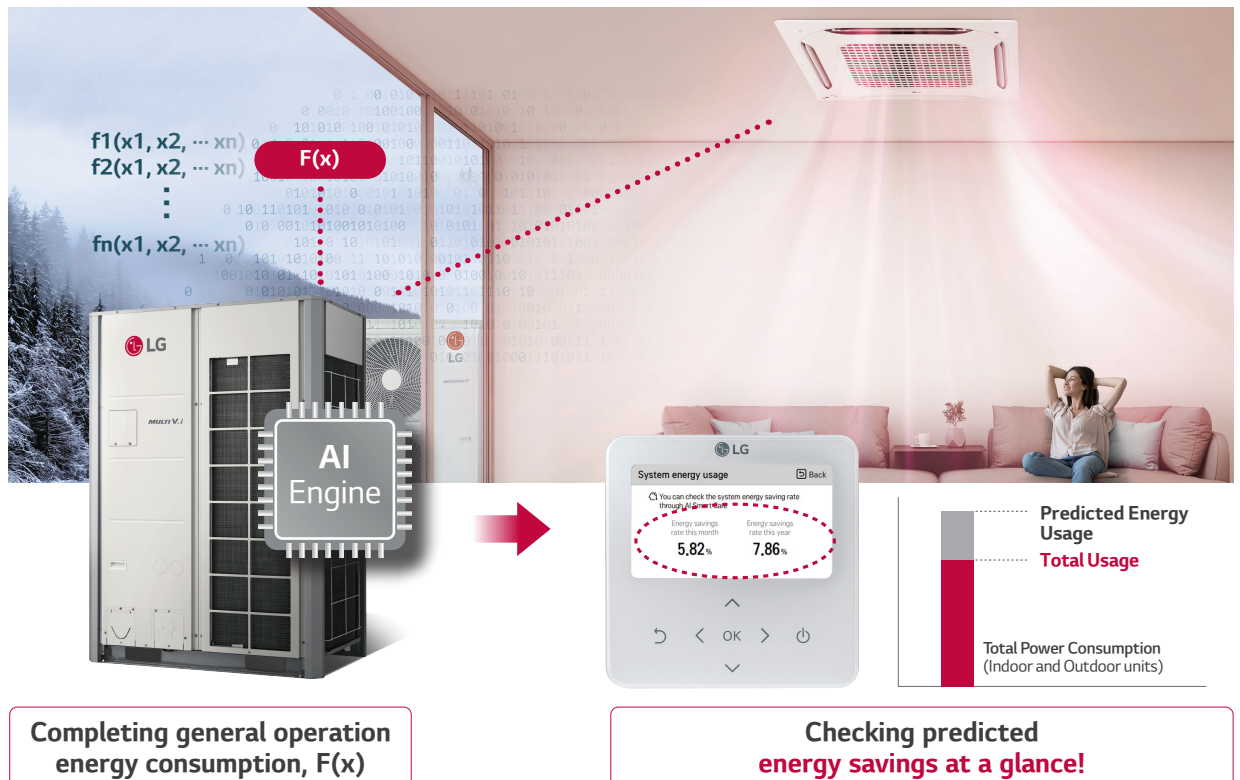

AI Energy Management

MULTI V *i* is able to preset monthly energy usage and consume power according to the target that has been previously set. By comparing and analyzing power consumption of the previous month and daily energy usage of current month, overuse of the HVAC system operational costs can be prevented by AI Energy management.

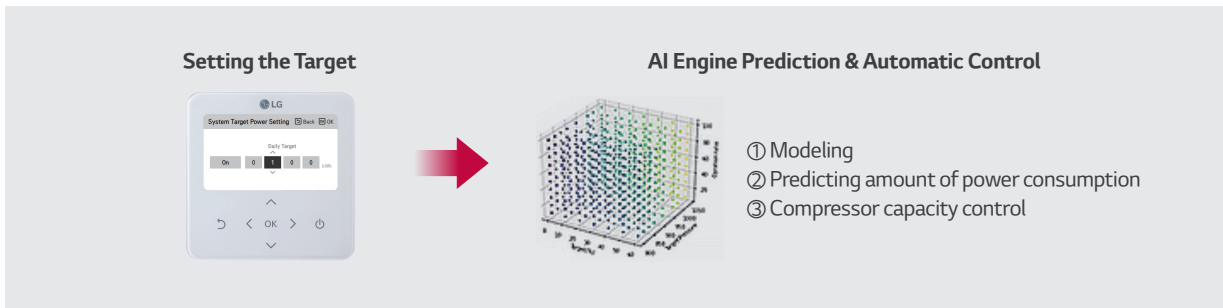

Monthly Usage

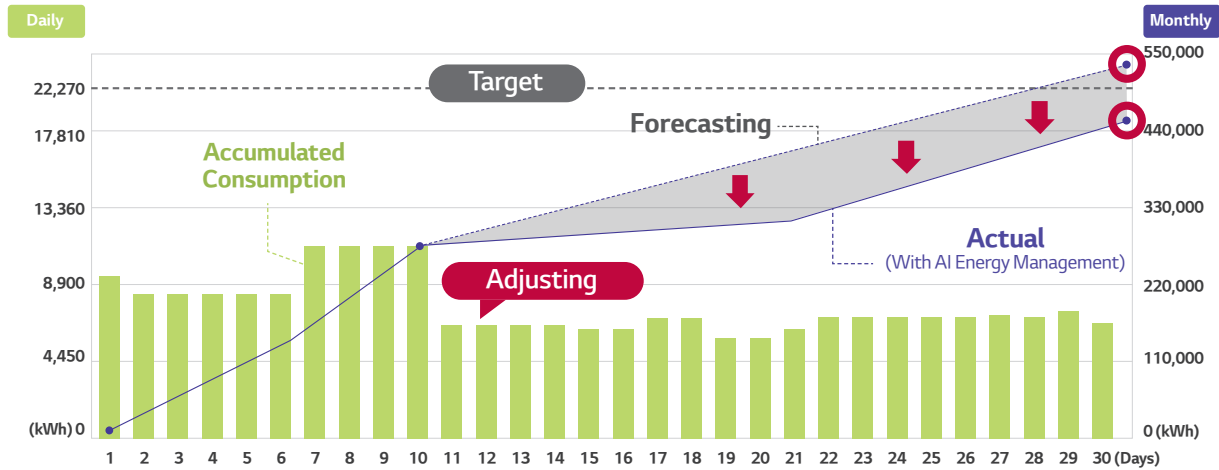

※ The above image is only for the better understanding.
 ※ If more accurate status for energy consumption is needed, ACP and PDI have to be installed.

Corrosion Resistance

“Corrosion Resistance Black Fin” heat exchanger is designed for improved corrosion resistance. Body panels are also designed for improved corrosion resistance. 2,000 hours for body panels and 10,000 hours for heat exchanger make the product more reliable for customers.

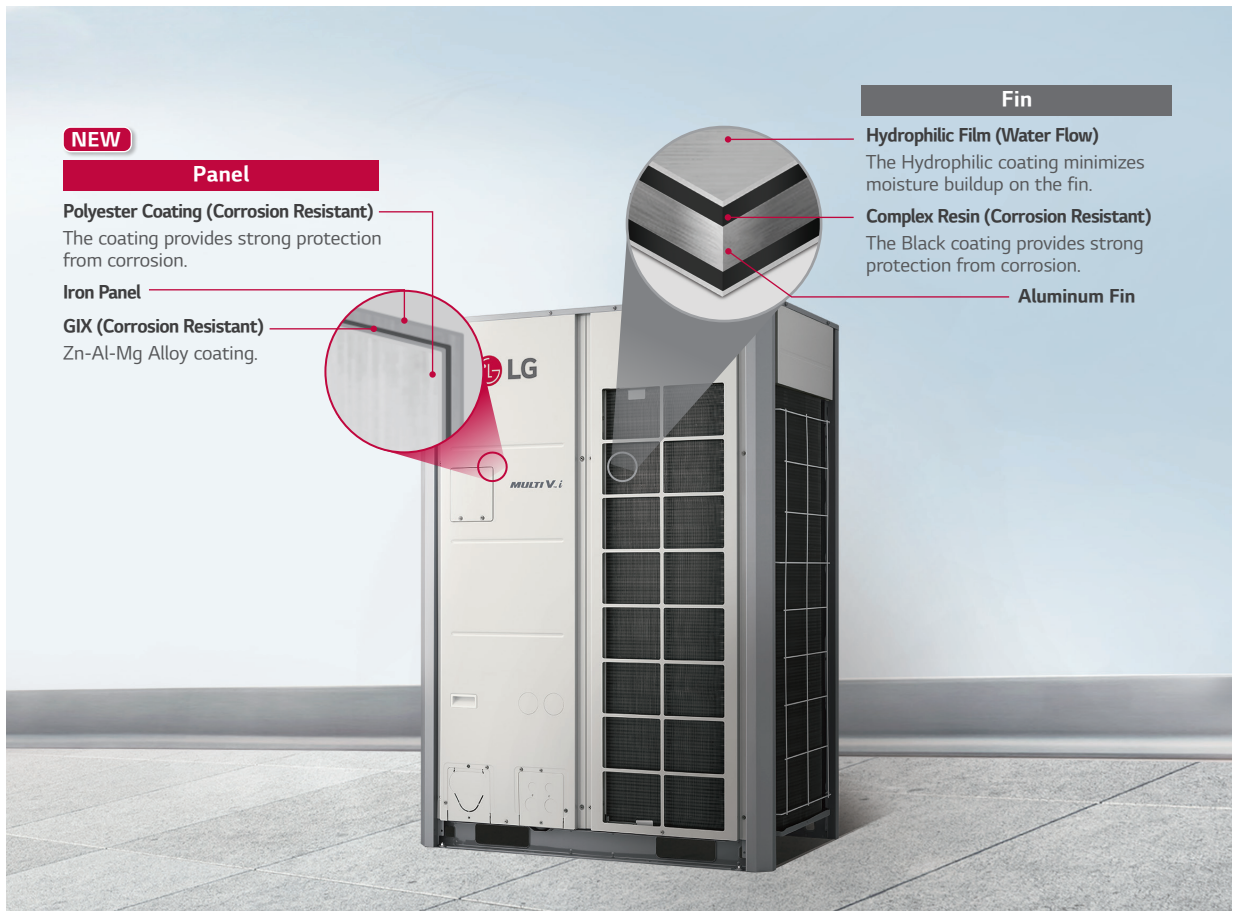

NEW

Panel

Polyester Coating (Corrosion Resistant)
The coating provides strong protection from corrosion.

Iron Panel

GIX (Corrosion Resistant)
Zn-Al-Mg Alloy coating.

Fin

Hydrophilic Film (Water Flow)

The Hydrophilic coating minimizes moisture buildup on the fin.

Complex Resin (Corrosion Resistant)

The Black coating provides strong protection from corrosion.

Aluminum Fin

Salt Spray Test for New Panel

Less than 0.05% area of defects compared to initial.



Fog¹⁾
(35°C, 24 hr)

※ Verification of corrosion resistance performance
- ASTM B117 : 2,000 hours (Last updated : Jul. 2022)
- Test Method B of ISO 9227

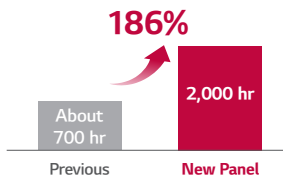

Test process is conducted according to ASTM B117
1) Salty water concentration : NaCl aqueous solution (5%)

Salt Spray Test for Black Fin

Less than 0.05% area of defects compared to initial.

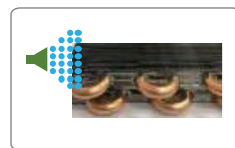

Fog¹⁾
(35°C, 24 hr)

※ Verification of corrosion resistance performance
- ASTM B117 : 10,000 hours (Last updated : Dec. 2020)
- Test Method B of ISO 9227



Test process is conducted according to ASTM B117.
1) Salty water concentration : NaCl aqueous solution (5%)

※ The product is not fully treated for anti-corrosion. To install near the sea, additional treatment must be required.

Widen Heat Exchanger

Energy Efficiency has been increased with a larger heat exchanger.

4-sided Heat Exchanger

Improved energy efficiency by increasing the heat exchanger area.

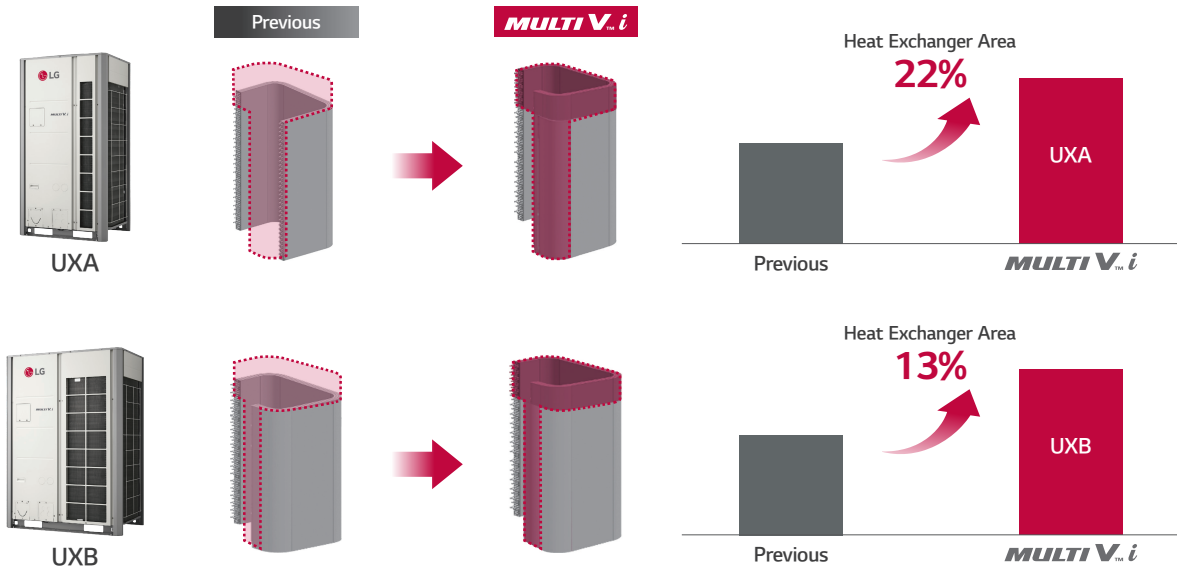

※ As a result of self-test according to KS test standard, it may differ depending on the actual use environment such as applied model and operating temperature.
 - Model : MULTI V 57 kW
 - Test condition : KS B ISO15042

HiPOR™

Advanced compressor reliability & efficiency

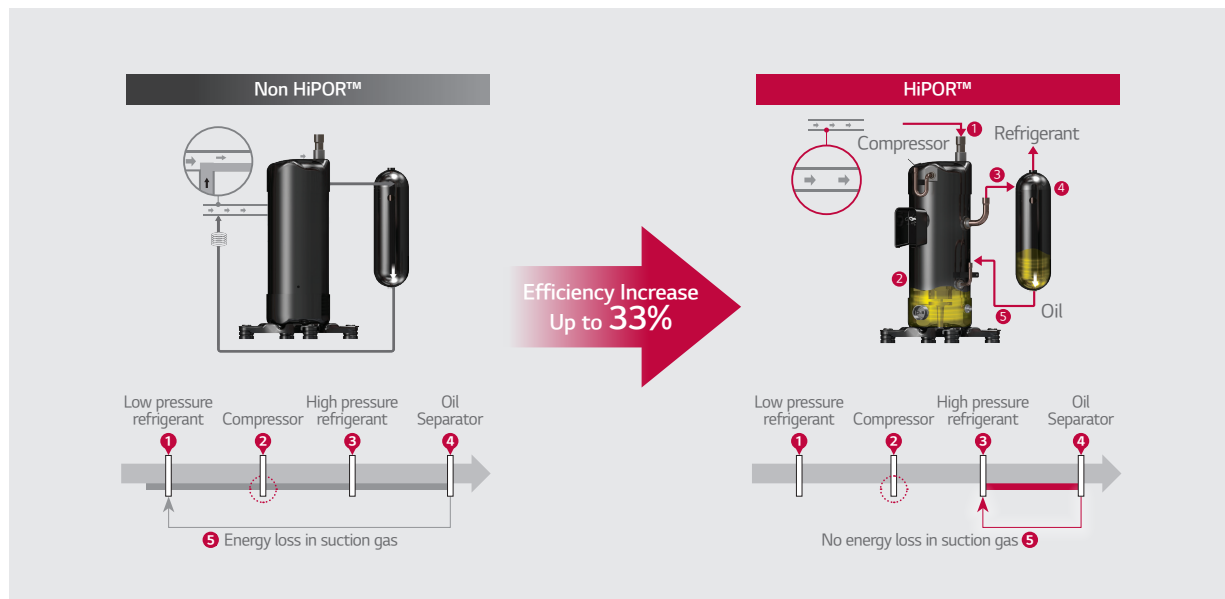

※ LG Internal Test result, Test condition - 15 HZ Rating Condition: Tc = 37.9°C, Te: 7.2°C

Maximum 26 HP for a Single Outdoor Unit

LG MULTI V *i* saves space, installation time and cost by offering a single outdoor unit with a maximum capacity of 26 HP.



Compact Size with Larger Capacity

More area for the gardening on the roof and less architecture structure by less installation area and lighter outdoor units.

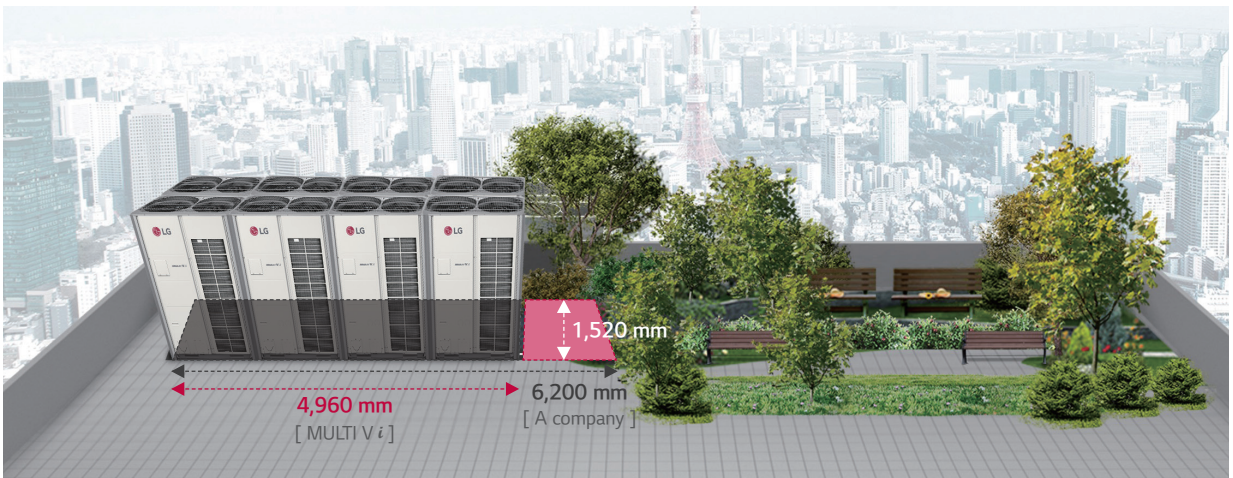

Install 196HP

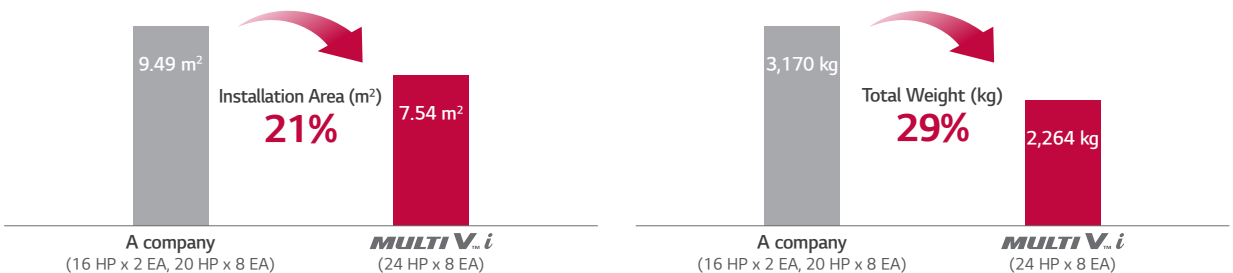

※ This scene is designed only for easier understanding.
 ※ The models of 8 to 24 HP are applicable to the standard combination.

Powerful Cooling Performance

Reliable cooling operation up to 52°C, with full performance at 43°C. End users are able to enjoy comfortable indoor environment even in case of extreme weather conditions outside.



Full Performance at 43°C



Cooling Performance

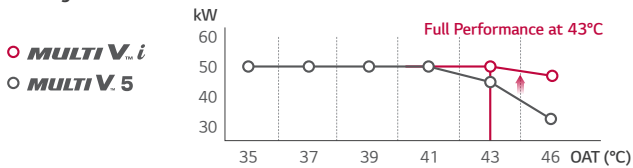

※ Performances are based on the following conditions. The result is from internal test.
- Cooling : Outdoor 43°C DB / Indoor 27°C DB, 19°C WB

Powerful & Stable Cooling Performance

	MULTI V.i	MULTI V.5
Cooling Operation Range	-15 ~ 52°C	-15 ~ 48°C
Performance at 43°C	Full	92%

Newly Designed Fan & Orifice

The design of a new biomimetic fan was inspired from nature. It brings more air volume and less noise with the same air flow rate compared to the previous system.

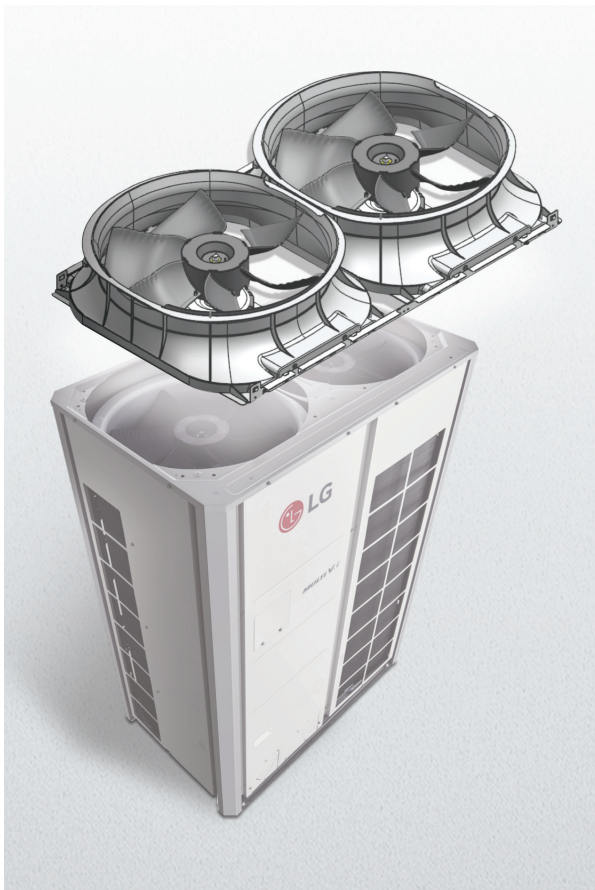

Fan Noise Level
2.6 dB ↓

Fan Power Consumption
12% ↓

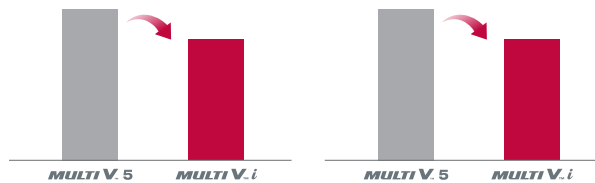

NEW Designed Biomimetic Fan

The new biomimetic fan has 6 blades that can reduce noise level and power consumption.

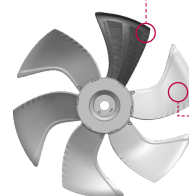

Humpback Whale Design

Increased Air Volume

Clam Shell Pattern

Reduced Noise Level

Compact Aero-Design

With an optimal air flow, the noise level and power consumption is reduced.

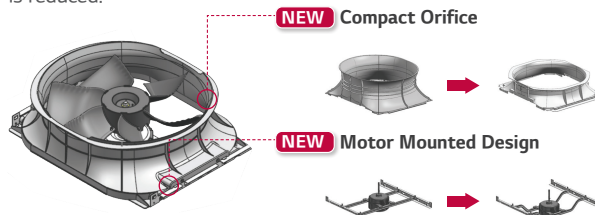

Flexible Combination of Outdoor Units

Flexible combination can contribute to realize faster delivery and installation. It provides more options for designing according to customers' preferences.

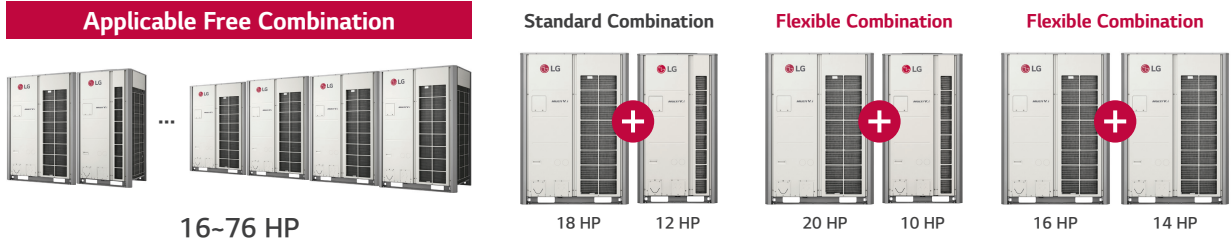

※ The model of 26 HP is not applicable to the free combination.
 ※ More detailed information can be checked in the LATS tool

Noise Target Control

The outdoor unit's noise can be restricted by the set sound level in advance, allowing customers to enjoy comfortable conditions while avoiding disturbing their neighbors and complying with the local noise regulations.



Controlled by a Remote Controller

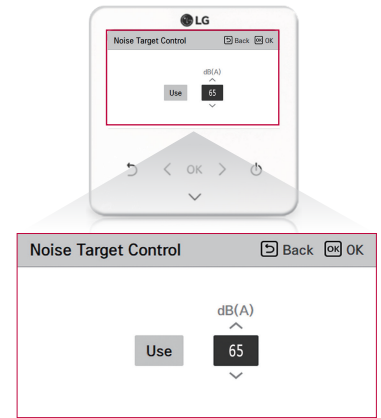

Available Setting
50 / 55 / 60 / 65 / 70 dB

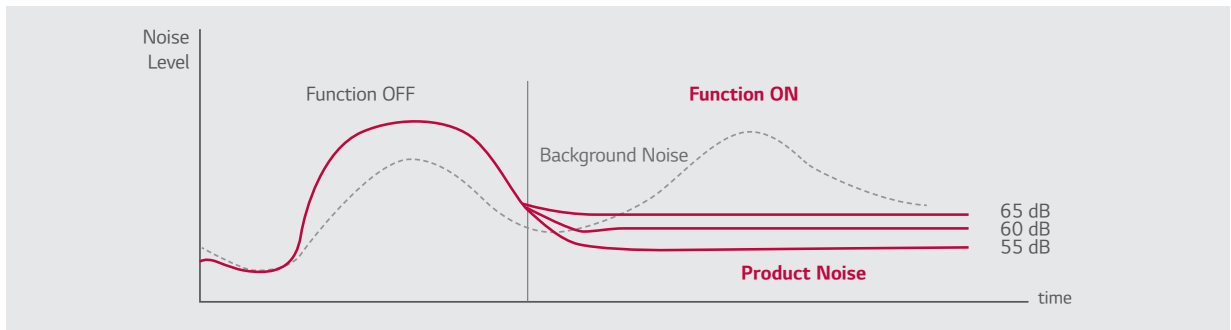

※ Be sure to select the model referring to the PDB (Product Data Book) because this function may cause a lack of capacity.
 ※ Results may vary depending on the environment.

Weather Information Interlocking Control

LG MULTI V *i* provides more comfort and convenience by checking ambient weather conditions.

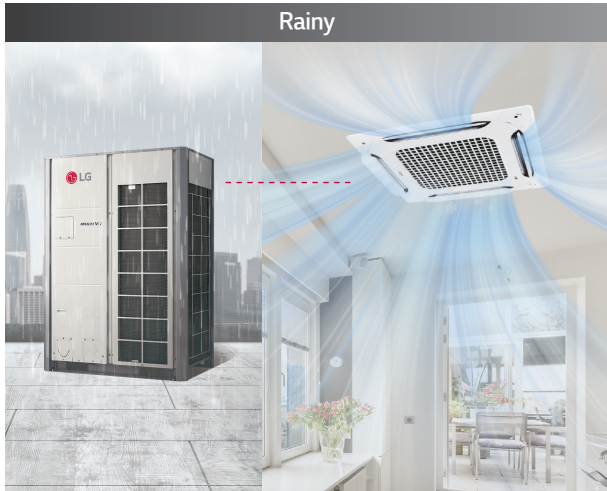
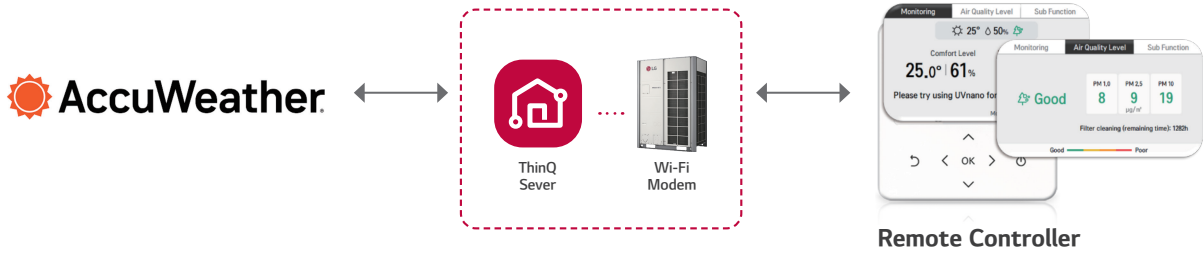

MULTI V *i*
Sensing Temperature & Humidity

Control Flow Amount of Refrigerant

Control Refrigerant Temperature



※ For this function, the air purification kit (accessory) must be applied to the indoor unit.

- ※ To use this function, it is necessary to connect the ThinQ server with AccuWeather.
- ※ To connect the MULTI V *i* to AccuWeather, an accessory such as a Wi-Fi modem is required to connect to the ThinQ server.
- ※ The operation is based on AccuWeather information.

AI Smart Diagnosis

The LGMV mobile application enables intelligent management by utilizing diagnostic reports that score the condition of the product. It saves service time and improves reliability by automatically analyzing and visually reporting the status.

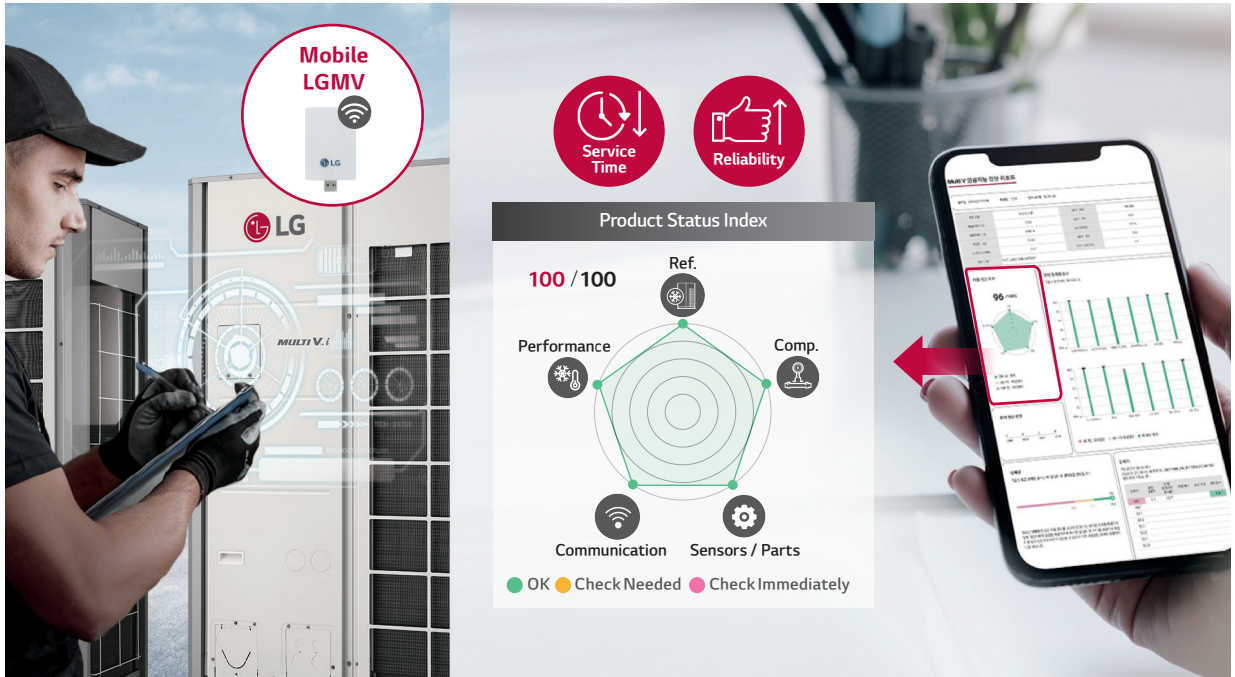

※ UI may be changed without notification.

Large Storage Black Box

Quick service can be provided thanks to the large storage black box in the AI engine, which stores up to a maximum of 6 months of operation data and 100 failure event information.

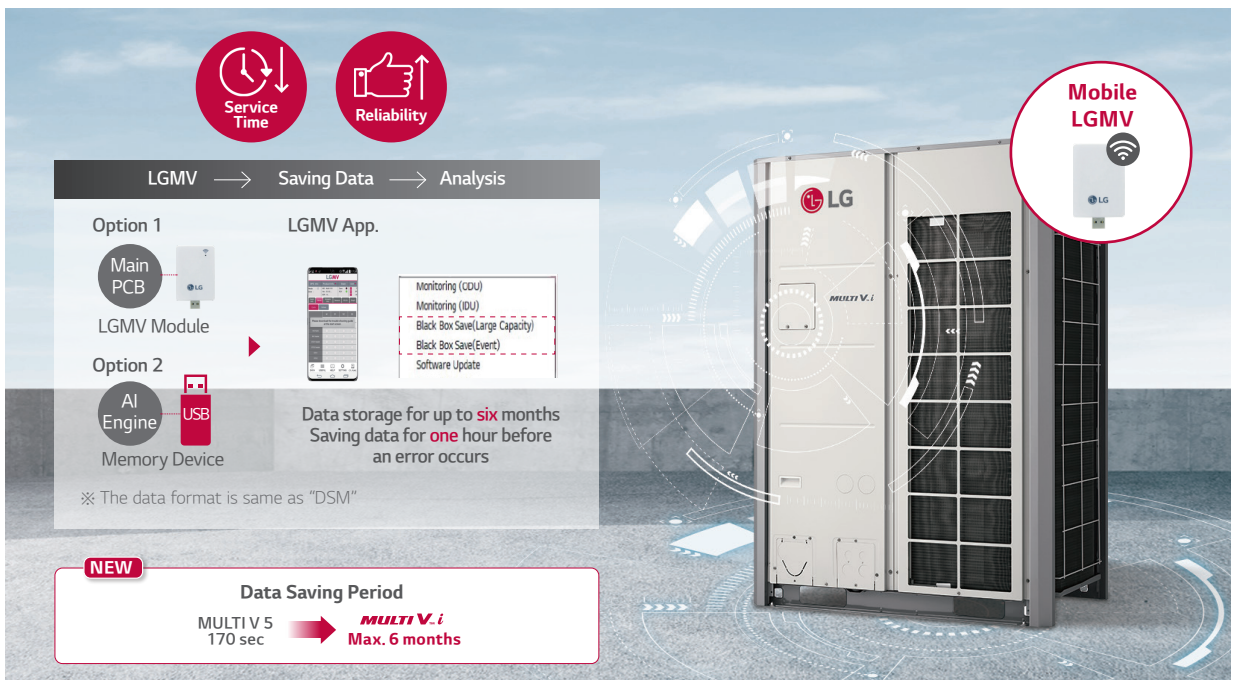

- ※ This function requires LGMV.
- ※ Available Devices: Windows PC, Android Phone / Tablet, iPhone / iPad
- ※ LGMV cycle data is saved at regular intervals. Default 1 Month, Max. 6-month (optional).

Auto Tuning System

LG MULTI V *i* provides customers with a new experience through faster and easier service. It automatically upgrades when the compressor and motor are replaced.

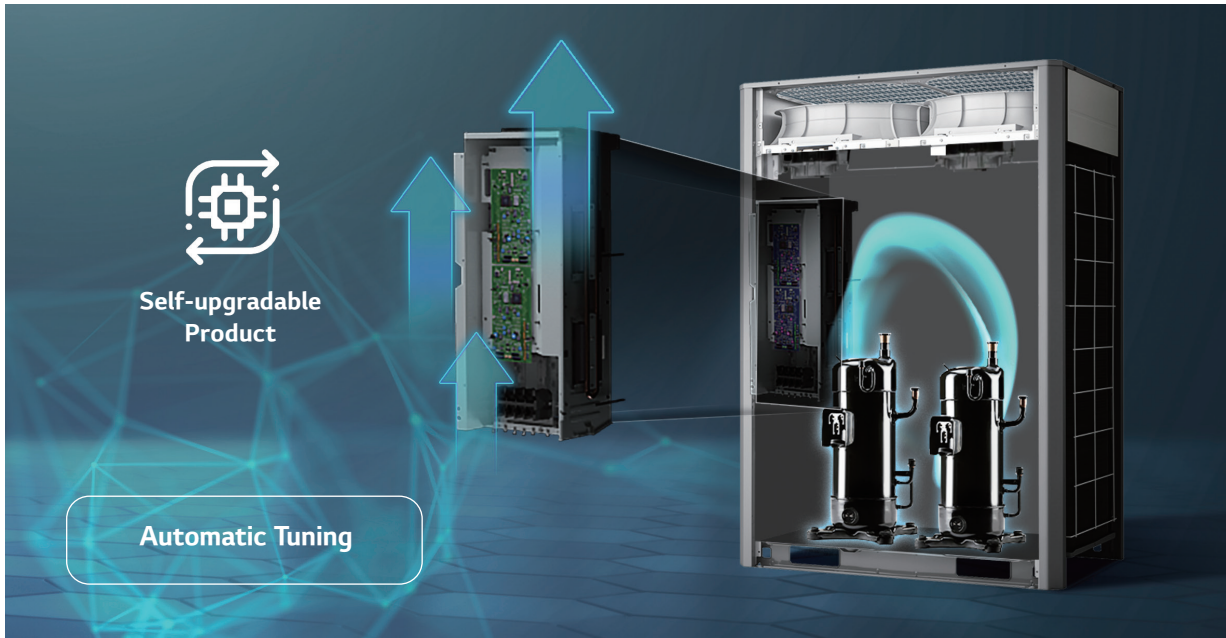

※ This function is to be applied to compressor and fan motor only for LG Multi V *i* or next generation.

Remote Upgrade System

Always use the latest version of your product. Connection with the BECON cloud keeps your product up to date by remotely updating not only the outdoor unit but also the AI engine.

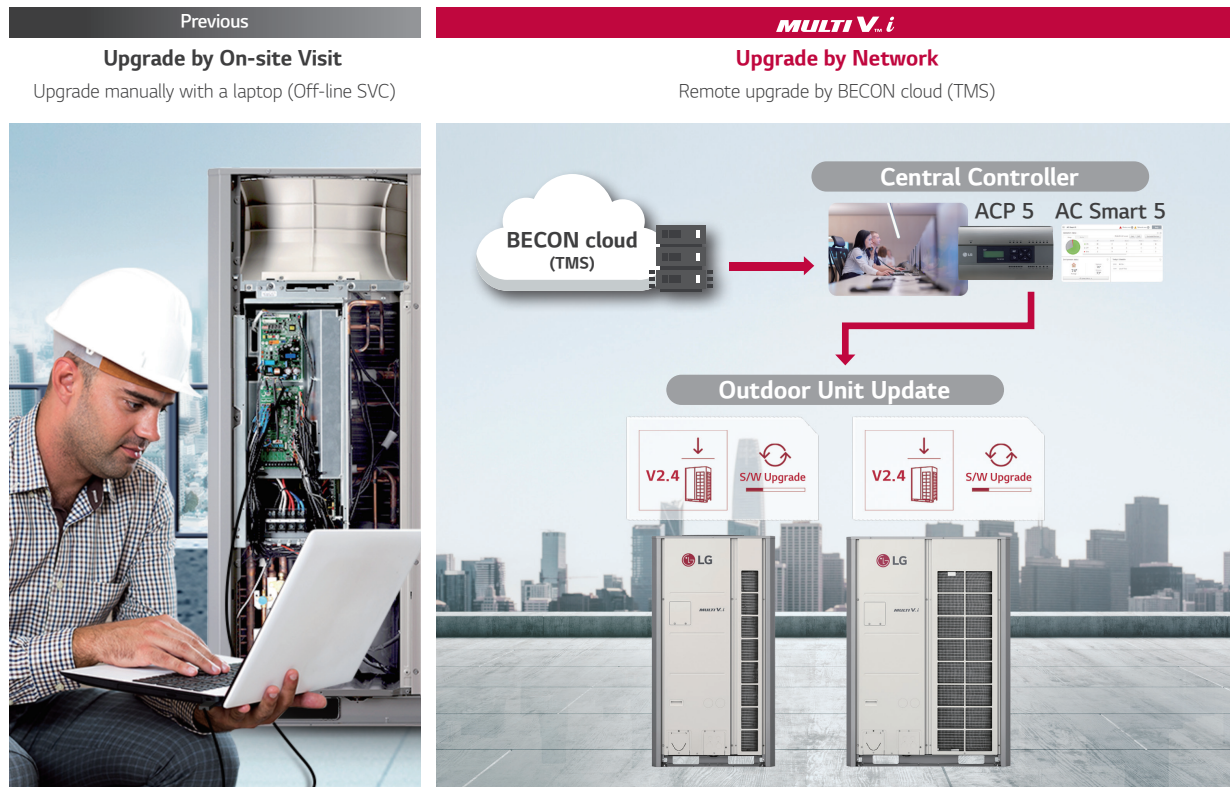

※ This function requires LG BECON cloud service.

LG BECON cloud

With the LG cloud-based remote system, LG provides differentiated solutions such as real-time monitoring, abnormality diagnosis, real-time care service, and energy management.

LG	USER
<ul style="list-style-type: none"> • Real-time Monitoring • Data Analysis & Report 	<ul style="list-style-type: none"> • Real-time Monitoring • Operation History Check

※ LG BECON : LG Building Energy CONTROL

Real-time Monitoring and Control

RCS Remote Control System

Mobile PC Tablet PC

Real-time Care Service

FMS LG Facility Maintenance System

Remote Check-up Group Management Big-data Analysis 24 / 7 Monitoring Check-up Reports

Smart Energy Saving

EMS Energy Management System

Energy Management by Comfort Level EMS Consulting Reports

Control Solution with MULTI V i

LG MULTI V i offers diverse range of effective control solutions that satisfy specific needs of each building and its user scene.

Hotel Room Solution

Application : Hotel, Resort, and etc.



Central Control Solution

Application : Office, Hospital, Hotel, Education, Retail, Dormitory, Shopping Mall, and etc.

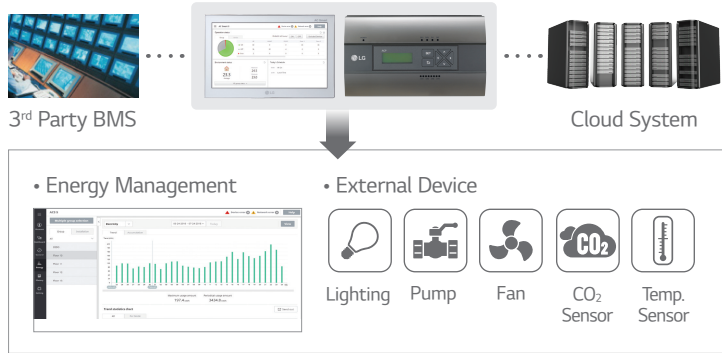

reddot award
User Interface Design

Integration Solution

Power Distribution Solution

Application : Apartment, Studio, Office, Retail Complex, Office Complex, and etc.



Individual Control Solution

Application : All



Small Central Control Solution

Application : Small Office, Education, Retail, and etc.



Total Piping Length

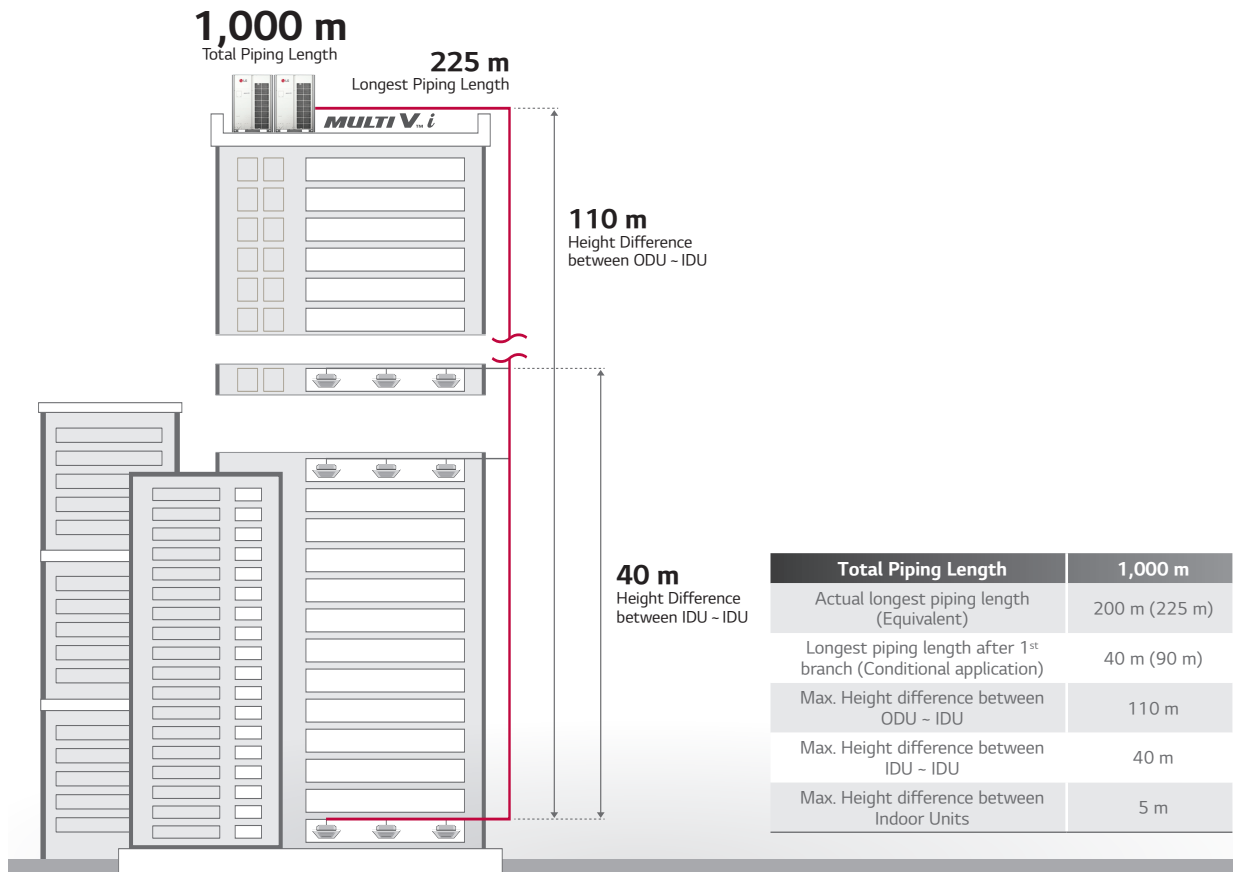

AI Function Application

Category	Sub Category	Tool	AI Function (IDU)						AI Function (ODU)	
			AI Smart Care	AI Indoor Space Care	AI Smart Metering	AI Energy Management	Noise Target Control	AccuWeather Interlocking Control	Smart Diagnosis	Big Capacity Black Box
Cassette	1 Way	TU / TT	●	●	●	●	●	●	●	●
	2 Way	TS	●	●	●	●	●	●	●	●
	Dual Vane 4 Way	TM-A / TP-B	●	●	●	●	●	●	●	●
	Round	TY	●	●	●	●	●	●	●	●
	Mini 4 Way	TQ / TR	●	●	●	●	●	●	●	●
Duct	Low Static	L1 / L2 / L3	●	X	●	●	●	●	●	●
	High Static	B8	●	X	●	●	●	●	●	●
	Mid Static	M1 / M2 / M3	●	X	●	●	●	●	●	●
Floor Standing	CE / CF	●	●	●	●	●	●	●	●	
Convertible*	Ceiling Suspended	VM1 / VM2	●	●	●	●	●	●	●	●
	Ceiling & Floor	VE	●	●	●	●	●	●	●	●
Console*		QA	●	●	●	●	●	●	●	●
Floor Standing (PAC)*		PT3, PF2	●	X	●	●	●	●	●	●
Wall Mounted*	Artcool, Standard	SJ / SK / SR	●	●	●	●	●	●	●	●

* These will be available from '24, August. These may be changed without notification.

Nomenclature

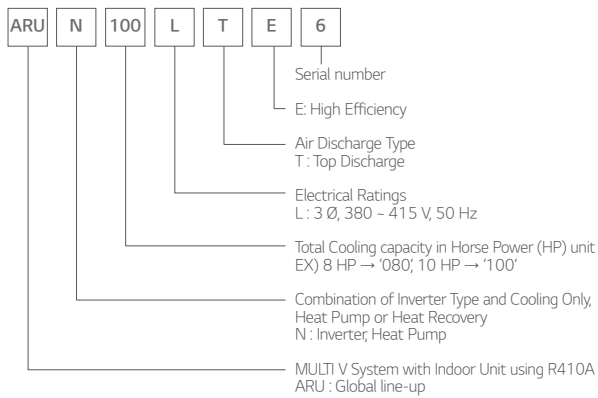

Outdoor Units Function

Category	Functions	Value
Reliability	Defrost / Deicing	○
	High Pressure Switch	○
	Phase Protection	○
	Restart Delay (3-minutes)	○
	Self Diagnosis	○
	Soft Start	○
	Compressor Balanced Operation	○
	Test Function	○
	Night Low Noise Operation	○
	Peak Control	○
Convenience	Mode Lock	○
	SLC (Smart Load Control)	○ (Advanced)
	Linear Bypass Cycle	X
	Noise Target Control	○
	Weather Information Interlocking Control	○
	Comfort Cooling	○
	ODU Dry Contact Function	○
	High Static Pressure Compensation	○
	Continuous Cooling	○
	Continuous Heating (Partial Defrost)	X
Convenient Energy Check	○	
Special Functions	Automatic Tuning Upgrade	○
	Remote Software Upgrade	○
	AI Smart Care	Accessory (AI Module required)
	AI Indoor Space Care	Accessory (AI Module required)
	AI Energy Target Control	Accessory (AI Module required)
	AI Smart Diagnosis	Accessory (AI Module required)

○: Applied, X: Not applied

- Accessory: Ordered and purchased separately the accessory package referring to the model name provided and install at field.

- Accessory line-ups varies by region, so check your local catalogue or local sales material.

Cooling / Heating Operation

Cooling

Outdoor Temperature (°C DB)

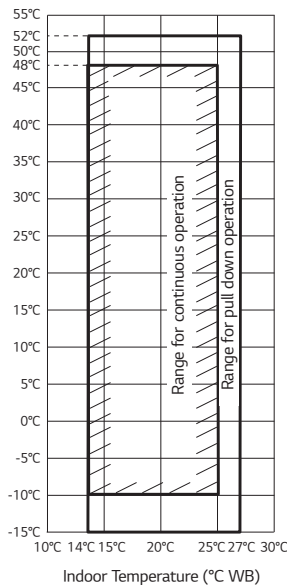

Heating

Outdoor Temperature (°C WB)

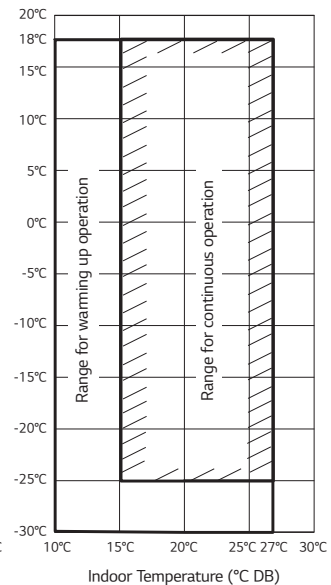

Note

- These figures assume the following operating conditions
: Equivalent piping length is standard condition, and level difference is 0 m.
- Range of pull down operation: If the relative humidity is too high, cooling capacity can be decreased by the sensible heat reduction.
- Warming up operation means that the outdoor (outside) unit operates to reach the range of continuous operating, however it may not operate continuously due to safety or protection logic.

ENGINEERING TOOLS & SUPPORT

From planning to design, installation, service & maintenance and retrofit, an architectural project goes through many stages from the beginning to the end of its lifecycle. Along those stages, various engineering tools are applied to solve the diverse issues happening in each stage, with the most optimal solution possible. Given the usage of such tools, buildings are effectively designed, built, supervised, and maintained throughout their lifecycle.

Dedicated to provide the best HVAC engineering support, LG Air Solution offers several engineering tools and solutions focused on the overall lifecycle of a building HVAC system. The LATS* Program has been developed to offer the best solution for LG HVAC systems, providing customers with a solution that allows for faster, easier and more accurate model selection, energy estimations and more.

* LATS : LG Air-conditioner Technical Solution

01 Model Selection

LATS HVAC

An integrated model selection program, enabling an accurate and quick selection on the best model suitable for each site. By providing detailed information on refrigerant piping and control design, design mistakes can be minimized.

- Various LG HVAC product design (MULTI V, MULTI, Single, ERV, AHU, DOAS and Central Controller)
- Calculate the diameter and length of refrigerant pipes
- Check design guide easily
- Simulate capacity and power input based on design condition
- Calculate the amount of additional refrigerant
- Provide engineering data in various formats such as report, submittal and equipment list

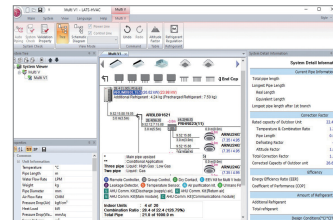

02 Design

LATS CAD (2D Drawing)

Easy, quick and accurate add-in design program for AutoCAD or ZWCAD.

- Selection for outdoor unit, indoor unit, accessories and controllers
- Design ref-pipe, control line and drain pipe
- Calculate the diameter and length of pipes and drains
- Check pipe rules
- Simulate capacity and power input based on design condition
- Calculate the amount of additional refrigerant
- Output of equipment schedules and reports
- Project information sharing with LATS HVAC

※ AutoCAD / ZWCAD program is required.

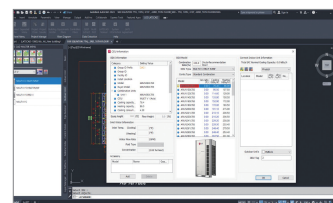

LATS REVIT / REVIT Family (3D Drawing)

An add-in program that provides a range of functions for designing LGE VRF in Autodesk Revit for Building Information Modeling (BIM).

The Revit family of LGE products features realistic shapes and specifications, making it easy for consultants and engineers to design and plan HVAC systems.

※ AutoCAD REVIT program is required.

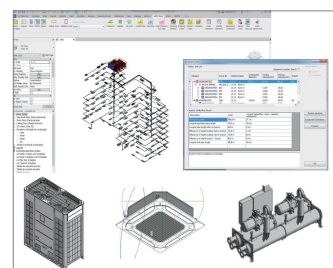

03 LATS LCC (Life Cycle Cost estimation)

LATS LCC simulates annual energy usage amount and life cycle cost based on whole year weather data and product performance data.

- Alternative system's Life Cycle Cost simulation
- Detail LCC analysis function
- Improved user input freedom (User can input directly)

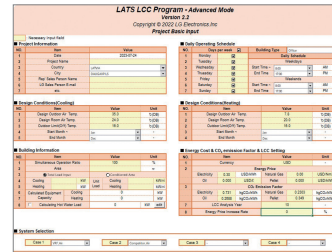

04 Mobile Application & Website

LG Energy Payback Application

Payback application provides a comparison of the payback period and Low Cycle Cost of LG inverter products.

- Life Cycle Cost comparison proposal for Each HVAC System
- Payback calculation of RAC/CAC products

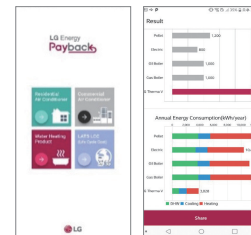

CAC Partner Application

Partner application provides technical and marketing materials for each model and various utility functions.

- Search and download technical and marketing materials
- Refrigerant amount calculation and error code search function, etc.

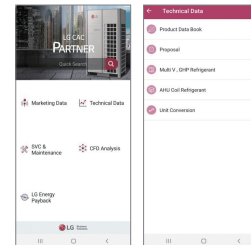

B2B Partner Portal

B2B partner portal provides technical data and various utilities, case studies by region and model.

- Search and download of PDB, catalogue, proposals, CAD files, etc.
- Provides various case studies for each segment

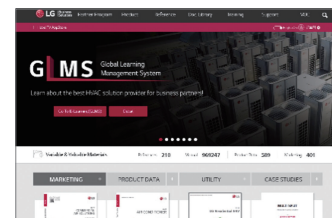

05 Environment Simulation

CFD Analysis

CFD analysis can review potential issues and provide optimal solution.

- Outdoor airflow analysis : Operability check
- Indoor airflow analysis : Airflow distribution
- Outdoor noise analysis : Environmental noise impact pre-study

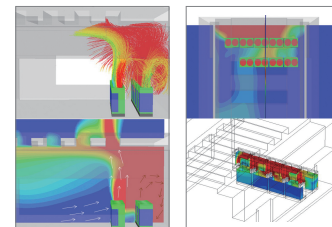

BENEFITS OF LG MULTI V *i*

Benefits for Building Owners



Efficient Management & Cost Reduction

- Fault Detection Diagnosis enables easy maintenance & no extra manpower for regular maintenance.
- Saves space, time, and installation costs by offering a larger capacity single outdoor unit
- More reliable cooling operation provides stable and powerful cooling condition at the unexpected extreme environment.



Reliability at Every Stage

- Ultimate Inverter Compressor developed and manufactured in Korea.
- Corrosion resistant Black Fin & Panel for harsh conditions operation.



Customized Comfort and Solution

- Preset monthly energy usage and consume power according to the target that has been previously set.
-



Benefits for Developers & Construction Companies



Green Solutions

- More environmentally friendly system & higher energy efficiency, less carbon emission.



Maximizing Space Utilization

- Large capacity in compact size enhances space utilization.



Smart Building Solutions

- Seamless integration with current Building Management Systems.
 - User friendly interface, flexible interlocking environment, energy management and smart individual controller for optimized controlling conditions and smart building management.
 - Expandable control system can makes building management smart by setting up logic optimized for the site.
-



Benefits for Consultants



Versatile Solutions

- Air-cooled, Water-cooled, Heating, ERV, and Air Handling Unit interlocking solutions.



Professional Design Support

- LATS (LG Air-conditioner Technical Solution) for draft energy estimation, model selection, HVAC design and 3D designing.
- CFD Analysis to ensure suitable solutions and prevent malfunctions.
- Energy simulation offered to find the optimal solution.



Optimized Convenience with HVAC Design

- Flexible combination provides more options for designing according to customers' preferences.
- The outdoor unit noise can be restricted by the set noise level in advance.

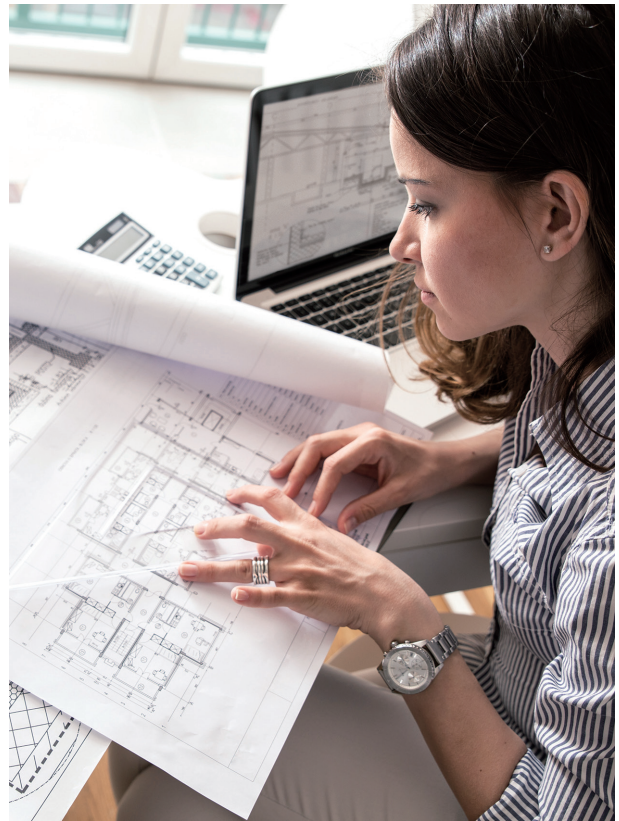

Benefits for End-users



Cost Saving Operation

- High efficiency guaranteed throughout product line-up.
- Prevent overuse of the HVAC system operational costs by AI Energy management.



Comfort Cooling & Heating

- MULTI V *i* is able to take control by itself in various situations through deep learning algorithms that enable it to self-learn.
- Automatic operation provides more comfort and convenience by checking ambient weather conditions.



Convenient Functions

- Low-noise operation provides a pleasant environment.



Interlocking Operation with ERV

LG ERV DX with humidification function interlock operation is a solution for humidifying and ventilating the indoor space while communicating with other IDUs and the ODU. They provide improved comfort conditions considering the indoor conditions without additional facility installation.

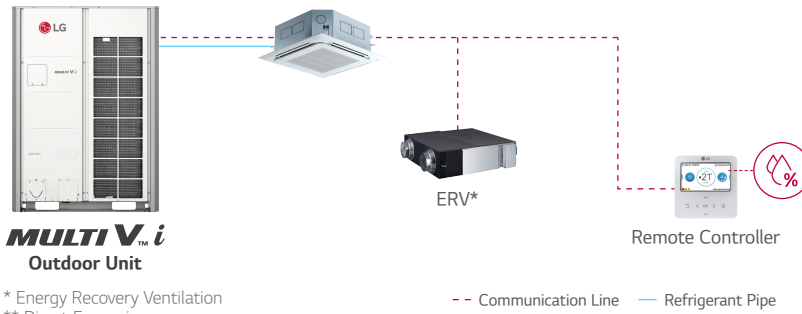

Various Applications

-  Hospital
-  Nursery Facility & School
-  Sanatorium

* Energy Recovery Ventilation
 ** Direct Expansion
 ※ This function will be available in 1Q, '24

Air Handling Unit (AHU) Solution

AHU is a suitable solution for cooling and heating in large spaces. With an LG AHU Comm. Kit (for both return air / supply air control) connected to the DX coil of the AHU, LG VRF system can be applied to deliver conditioned air.

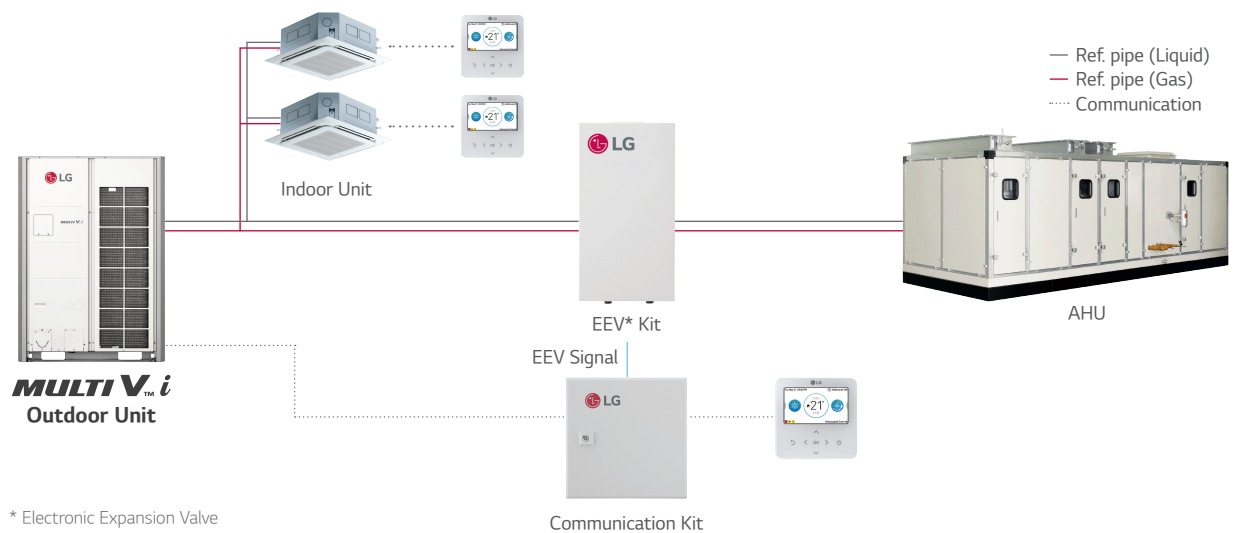

* Electronic Expansion Valve

Refrigerant Leak Detection Solution

LG leakage detector keep the indoor space safe and guarantees the customer's peace of mind.

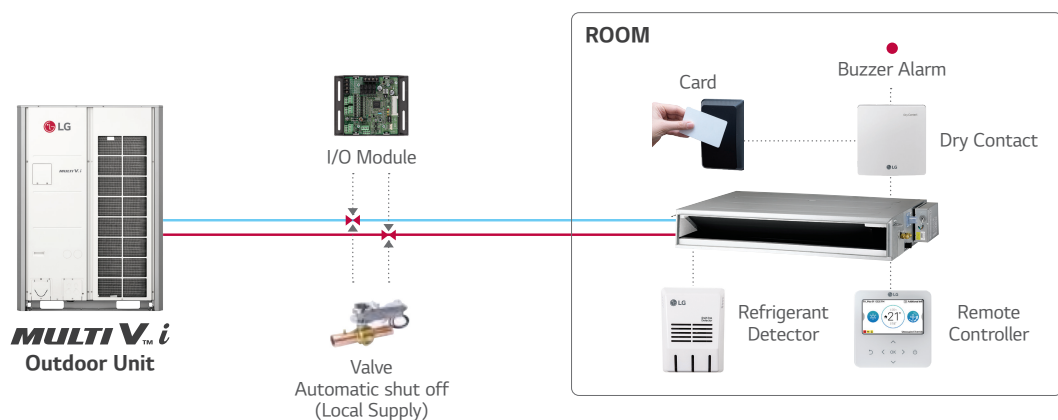

Power Consumption Distribution Solution

In case of shared power consumption in a building, a solution to distribute the power consumption amount per tenant might be necessary. Electricity charges can be billed to each tenant by using output from the LG Power Distributor Indicator (PDI). An administrator is able to check the power usage for each space and date as needed. If the PDI is used in conjunction with an LG central controller, the results can be exported in excel format.

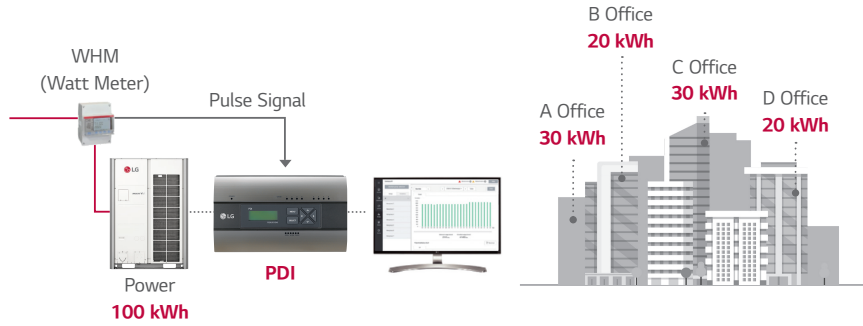

Total Control via Any Device

When managing multiple spaces, building administrators should be able to control systems from wherever they are. The LG central controller can be accessed from any web browser that supports HTML5. The interface has been adapted to look great and perform well on any device.



Energy Management Solution

Energy navigation function allows LG MULTI V i to preset monthly energy usage and consume what has been previously planned. By comparing and analyzing previous consumption and planned energy usage for the month, overuse of the HVAC system operational costs can be prevented with central controller.

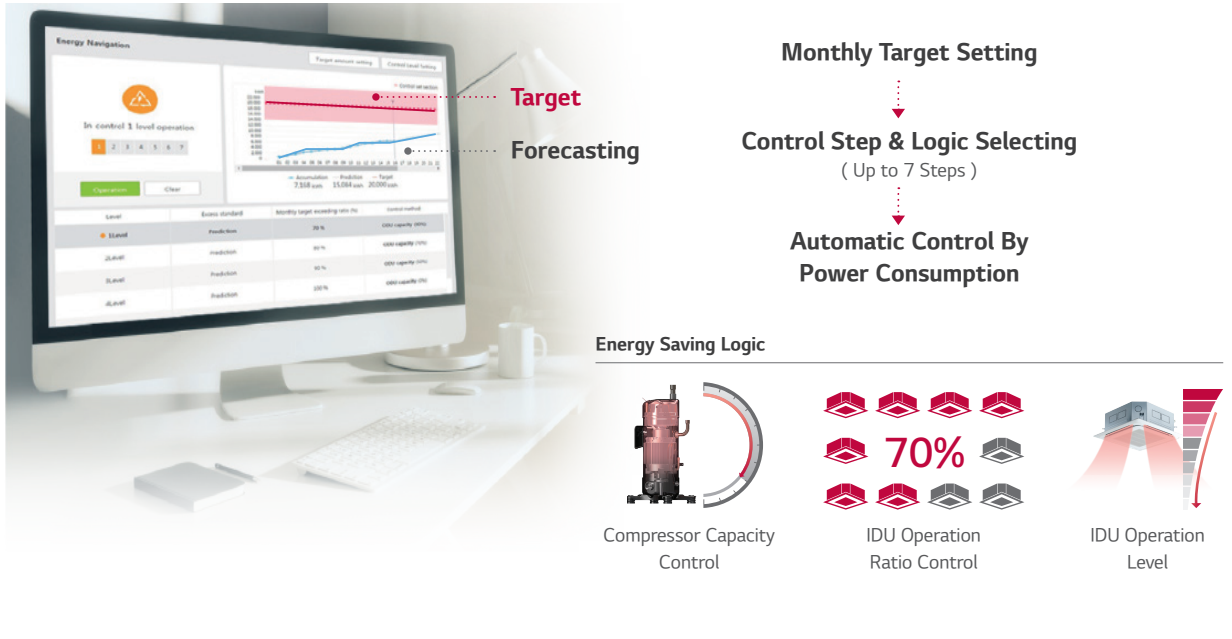

Integration Solution with BMS

There are many BMS protocols used for the control of buildings' various systems such as HVAC, lighting, power and security. LG has a wide range of gateway products for different protocols such as BACnet, Modbus. In addition, LG gateways include Stand-alone central control capability to act as a back-up controller of the BMS if needed.

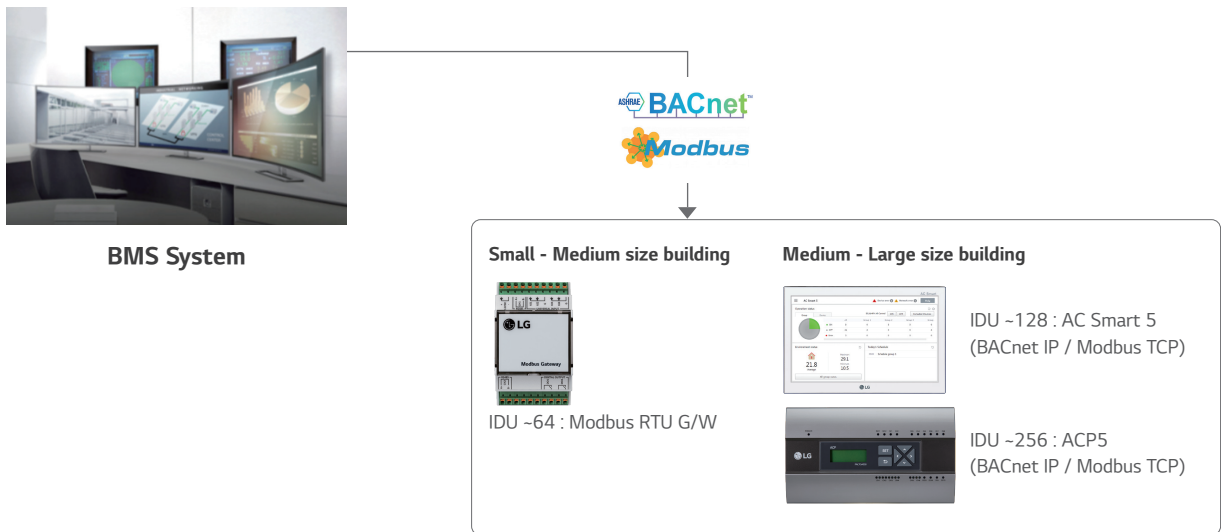

Interlocking Solution by Using ACU Module

It is costly to introduce a BMS system to control multiple devices or systems in a small building. With the ACU module, various IO contact points (DI, DO, UI, AO) can be interlocked and integrated, while control is possible from the LG central controller. This enables an efficient management of lighting, pumps and other devices in the building in conjunction with the HVAC system.

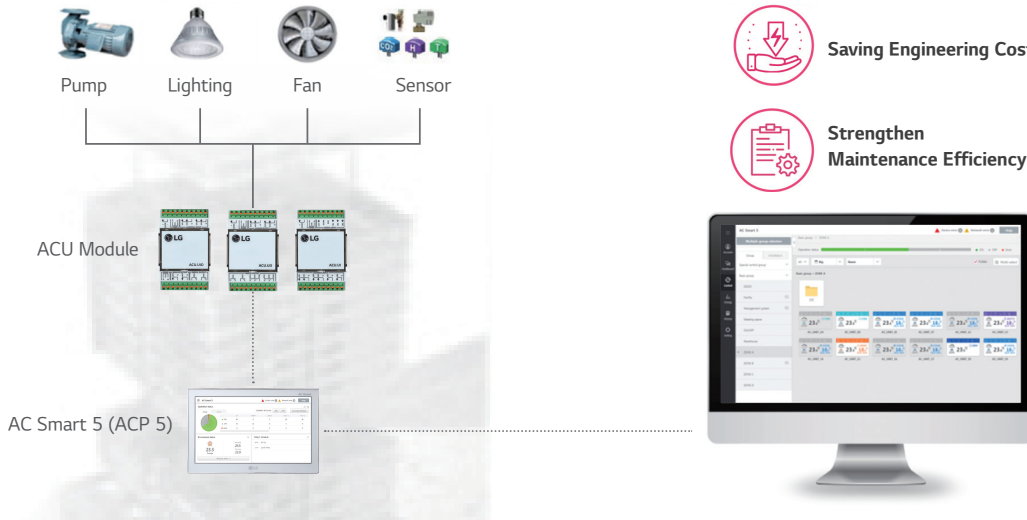

Interlocking Solution Using Dry Contact

3rd party thermostats can be used to control LG air conditioners in a room by using a multi point dry contact. The dry contact enables basic control of air conditioners as well as making it possible to report the status and any errors impacting the indoor unit.

The Standard III remote control has a DO port. With this DO port, it is possible to interlock the indoor unit with 3rd party devices such as lighting, a fan, or a radiator, based on parameters like operation mode or current temperature. The indoor unit can be interlocked with various types of input such as card key-tag, door sensor, human detection sensor etc. so that the air conditioner is automatically operated. In addition, the dry contact option settings enable operation of air conditioner to maintain proper temperature when the occupant is absent. This solution makes sure that the room does not overheat or become too cold when unoccupied so that energy cost can be saved.



**ARUN080LTE6 / ARUN100LTE6 / ARUN120LTE6
ARUN140LTE6 / ARUN160LTE6**



HP			8	10	12	14	16
Classification	Chassis	-	UXA	UXA	UXA	UXB	UXB
	Combination Unit	-	ARUN080LTE6	ARUN100LTE6	ARUN120LTE6	ARUN140LTE6	ARUN160LTE6
Power Supply	Case 1	V / Ø / Hz	380 - 415, 3, 50	380 - 415, 3, 50	380 - 415, 3, 50	380 - 415, 3, 50	380 - 415, 3, 50
	Limit Range of Voltage (Case 1)	V	342 - 456	342 - 456	342 - 456	342 - 456	342 - 456
	Case 2	V / Ø / Hz	380, 3, 60	380, 3, 60	380, 3, 60	380, 3, 60	380, 3, 60
	Limit Range of Voltage (Case 2)	V	342 - 418	342 - 418	342 - 418	342 - 418	342 - 418
Cooling Capacity	Rated	kW	22.40	28.00	33.60	39.20	44.80
	Rated	Btu/h	76,400	95,500	114,600	133,800	152,900
Heating Capacity	Rated	kW	25.20	31.50	37.80	44.10	50.40
	Rated	Btu/h	86,000	107,500	129,000	150,500	172,000
Power Input (Cooling)	Rated	kW	4.39	5.70	7.37	8.55	10.08
Power Input (Heating)	Rated	kW	4.67	5.78	7.60	9.30	10.80
Efficiency	COP Cooling	W/W	5.10	4.91	4.56	4.58	4.44
	COP Heating	W/W	5.40	5.45	4.97	4.74	4.67
Power Factor (Cooling / Heating)	Rated		0.93 / 0.93	0.93 / 0.93	0.93 / 0.93	0.93 / 0.93	0.93 / 0.93
Outdoor Fan	Type	-	Propeller Fan	Propeller Fan	Propeller Fan	Propeller Fan	Propeller Fan
	Air Flow Rate (High)	m ³ /min x No.	220 x 1	220 x 1	220 x 1	320 x 1	320 x 1
	Max. External Static Pressure	Pa	80	80	80	80	80
	Discharge Direction (Side / Top)		TOP	TOP	TOP	TOP	TOP
Outdoor Fan Motor	Drive	-	DC Inverter	DC Inverter	DC Inverter	DC Inverter	DC Inverter
	Output	W x No.	1,200 x 1	1,200 x 1	1,200 x 1	900 x 2	900 x 2
Compressor	Type	-	Hermetically Sealed Scroll	Hermetically Sealed Scroll	Hermetically Sealed Scroll	Hermetically Sealed Scroll	Hermetically Sealed Scroll
	Piston Displacement	cm ³ /rev	62.1	62.1	62.1	62.1	62.1
	Number of Revolution	rev./min	3,600	3,600	3,600	3,600	3,600
	Motor Output	W x No.	5,300 x 1	5,300 x 1	5,300 x 1	5,300 x 1	5,300 x 1
	Oil Type	-	FW68L (PVE)	FW68L (PVE)	FW68L (PVE)	FW68L (PVE)	FW68L (PVE)
Heat Exchanger	Fin Type	-	Wide Louver Plus	Wide Louver Plus	Wide Louver Plus	Wide Louver Plus	Wide Louver Plus
Dimensions	Net (W x H x D)	mm	930 x 1,745 x 760	930 x 1,745 x 760	930 x 1,745 x 760	1,240 x 1,745 x 760	1,240 x 1,745 x 760
Weight	Net	kg	201.0	201.0	201.0	217.0	217.0
Exterior	Color	-	Morning Gray / Dawn Gray	Morning Gray / Dawn Gray	Morning Gray / Dawn Gray	Morning Gray / Dawn Gray	Morning Gray / Dawn Gray
	RAL (Classic)	-	RAL 7038 / RAL 7037	RAL 7038 / RAL 7037	RAL 7038 / RAL 7037	RAL 7038 / RAL 7037	RAL 7038 / RAL 7037
Refrigerant	Type	-	R410A	R410A	R410A	R410A	R410A
	Precharged Amount	kg	9.0	9.0	9.0	11.0	11.0
	t-CO ₂ eq.	-	18.788	18.788	18.788	22.963	22.963
	Control Type	-	EEV	EEV	EEV	EEV	EEV
Connecting Pipe	Liquid	mm (inch)	Ø 9.52(3/8)	Ø 9.52(3/8)	Ø 12.7(1/2)	Ø 12.7(1/2)	Ø 12.7(1/2)
	Gas	mm (inch)	Ø 19.05(3/4)	Ø 22.2(7/8)	Ø 28.58(1-1/8)	Ø 28.58(1-1/8)	Ø 28.58(1-1/8)
Sound Pressure Level (Outdoor Unit)	Cooling / Heating	dB (A)	57.0 / 58.0	57.5 / 58.5	59.0 / 60.0	60.0 / 61.0	60.5 / 61.5
Connecting Cable	Communication Cable (VCTF-SB)	mm ² x cores	1.0 - 1.5 x 2 C	1.0 - 1.5 x 2 C	1.0 - 1.5 x 2 C	1.0 - 1.5 x 2 C	1.0 - 1.5 x 2 C
Connectable Indoor Units Number	Max. (Conditional)	EA	13 (20)	16 (25)	20 (30)	23 (35)	26 (40)

**ARUN180LTE6 / ARUN200LTE6 / ARUN220LTE6
ARUN240LTE6 / ARUN260LTE6**



HP			18	20	22	24	26
Classification	Chassis	-	UXB	UXB	UXB	UXB	UXB
	Combination Unit	-	ARUN180LTE6	ARUN200LTE6	ARUN220LTE6	ARUN240LTE6	ARUN260LTE6
Power Supply	Case 1	V / Ø / Hz	380 - 415, 3, 50	380 - 415, 3, 50	380 - 415, 3, 50	380 - 415, 3, 50	380 - 415, 3, 50
	Limit Range of Voltage (Case 1)	V	342 - 456	342 - 456	342 - 456	342 - 456	342 - 456
	Case 2	V / Ø / Hz	380, 3, 60	380, 3, 60	380, 3, 60	380, 3, 60	380, 3, 60
	Limit Range of Voltage (Case 2)	V	342 - 418	342 - 418	342 - 418	342 - 418	342 - 418
Cooling Capacity	Rated	kW	50.40	56.00	61.60	67.20	72.80
	Rated	Btu/h	172,000	191,100	210,200	229,300	248,400
Heating Capacity	Rated	kW	56.70	63.00	69.30	74.30	74.30
	Rated	Btu/h	193,500	215,000	236,500	253,400	253,400
Power Input (Cooling)	Rated	kW	10.40	11.72	14.10	15.90	18.67
Power Input (Heating)	Rated	kW	11.20	14.60	16.70	18.00	18.30
Efficiency	COP Cooling	W/W	4.85	4.78	4.37	4.23	3.90
	COP Heating	W/W	5.06	4.32	4.15	4.13	4.06
Power Factor (Cooling / Heating)	Rated		0.93 / 0.93	0.93 / 0.93	0.93 / 0.93	0.93 / 0.93	0.93 / 0.93
Outdoor Fan	Type	-	Propeller Fan	Propeller Fan	Propeller Fan	Propeller Fan	Propeller Fan
	Air Flow Rate (High)	m ³ /min x No.	320 x 1	320 x 1	320 x 1	320 x 1	320 x 1
	Max. External Static Pressure	Pa	80	80	80	80	80
	Discharge Direction (Side / Top)		TOP	TOP	TOP	TOP	TOP
Outdoor Fan Motor	Drive	-	DC Inverter	DC Inverter	DC Inverter	DC Inverter	DC Inverter
	Output	W x No.	900 x 2	900 x 2	900 x 2	900 x 2	900 x 2
Compressor	Type	-	Hermetically Sealed Scroll	Hermetically Sealed Scroll	Hermetically Sealed Scroll	Hermetically Sealed Scroll	Hermetically Sealed Scroll
	Piston Displacement	cm ³ /rev	62.1 x 2	62.1 x 2	62.1 x 2	62.1 x 2	62.1 x 2
	Number of Revolution	rev./min	3,600 x 2	3,600 x 2	3,600 x 2	3,600 x 2	3,600 x 2
	Motor Output	W x No.	5,300 x 2	5,300 x 2	5,300 x 2	5,300 x 2	5,300 x 2
	Oil Type	-	FW68L (PVE)	FW68L (PVE)	FW68L (PVE)	FW68L (PVE)	FW68L (PVE)
Heat Exchanger	Fin Type	-	Wide Louver Plus	Wide Louver Plus	Wide Louver Plus	Wide Louver Plus	Wide Louver Plus
Dimensions	Net (W x H x D)	mm	1,240 x 1,745 x 760	1,240 x 1,745 x 760	1,240 x 1,745 x 760	1,240 x 1,745 x 760	1,240 x 1,745 x 760
Weight	Net	kg	263.0	263.0	283.0	283.0	283.0
Exterior	Color	-	Morning Gray / Dawn Gray	Morning Gray / Dawn Gray	Morning Gray / Dawn Gray	Morning Gray / Dawn Gray	Morning Gray / Dawn Gray
	RAL (Classic)	-	RAL 7038 / RAL 7037	RAL 7038 / RAL 7037	RAL 7038 / RAL 7037	RAL 7038 / RAL 7037	RAL 7038 / RAL 7037
Refrigerant	Type	-	R410A	R410A	R410A	R410A	R410A
	Precharged Amount	kg	13.0	13.0	16.0	16.0	16.0
	t-CO ₂ eq.	-	27.138	27.138	33.400	33.400	33.400
	Control Type	-	EEV	EEV	EEV	EEV	EEV
Connecting Pipe	Liquid	mm (inch)	Ø 15.88 (5/8)	Ø 15.88 (5/8)	Ø 15.88 (5/8)	Ø 15.88 (5/8)	Ø 19.05 (3/4)
	Gas	mm (inch)	Ø 28.58 (1-1/8)	Ø 28.58 (1-1/8)	Ø 28.58 (1-1/8)	Ø 34.9 (1-3/8)	Ø 34.9 (1-3/8)
Sound Pressure Level (Outdoor Unit)	Cooling / Heating	dB (A)	61.0 / 62.0	62.0 / 63.5	64.5 / 64.5	65.0 / 66.0	65.0 / 66.0
Connecting Cable	Communication Cable (VCTF-SB)	mm ² x cores	1.0 - 1.5 x 2 C	1.0 - 1.5 x 2 C	1.0 - 1.5 x 2 C	1.0 - 1.5 x 2 C	1.0 - 1.5 x 2 C
Connectable Indoor Units Number	Max. (Conditional)	EA	29 (45)	32 (50)	35 (56)	39 (61)	42 (64)

**ARUN280LTE6 / ARUN300LTE6 / ARUN320LTE6
ARUN340LTE6 / ARUN360LTE6**



HP			28	30	32	34	36
Classification	Chassis	-	UXB + UXA	UXB + UXA	UXB + UXA	UXB + UXA	UXB + UXA
	Combination Unit	-	ARUN160LTE6 ARUN120LTE6	ARUN180LTE6 ARUN120LTE6	ARUN200LTE6 ARUN120LTE6	ARUN220LTE6 ARUN120LTE6	ARUN240LTE6 ARUN120LTE6
Power Supply	Case 1	V / Ø / Hz	380 - 400 - 415, 3, 50	380 - 400 - 415, 3, 50	380 - 400 - 415, 3, 50	380 - 400 - 415, 3, 50	380 - 400 - 415, 3, 50
	Limit Range of Voltage (Case 1)	V	342 - 456	342 - 456	342 - 456	342 - 456	342 - 456
	Case 2	V / Ø / Hz	380, 3, 60	380, 3, 60	380, 3, 60	380, 3, 60	380, 3, 60
	Limit Range of Voltage (Case 2)	V	342 - 418	342 - 418	342 - 418	342 - 418	342 - 418
Cooling Capacity	Rated	kW	78.4	84.0	89.6	95.2	100.8
	Rated	Btu/h	267,500	286,600	305,700	324,800	343,900
Heating Capacity	Rated	kW	88.2	94.5	100.8	107.1	112.1
	Rated	Btu/h	301,000	322,500	344,000	365,500	382,400
Power Input (Cooling)	Rated	kW	17.45	17.77	19.09	21.47	23.27
Power Input (Heating)	Rated	kW	18.40	18.80	22.20	24.30	25.60
Efficiency	COP Cooling	W/W	4.49	4.73	4.69	4.43	4.33
	COP Heating	W/W	4.79	5.03	4.54	4.41	4.38
Power Factor (Cooling / Heating)	Rated		0.93 / 0.93	0.93 / 0.93	0.93 / 0.93	0.93 / 0.93	0.93 / 0.93
Outdoor Fan	Type	-	Propeller Fan	Propeller Fan	Propeller Fan	Propeller Fan	Propeller Fan
	Air Flow Rate (High)	m ³ /min x No.	(320 x 1) + (220 x 1)	(320 x 1) + (220 x 1)	(320 x 1) + (220 x 1)	(320 x 1) + (220 x 1)	(320 x 1) + (220 x 1)
	Max. External Static Pressure	Pa	80	80	80	80	80
	Discharge Direction (Side / Top)		Top	Top	Top	Top	Top
Outdoor Fan Motor	Drive	-	Direct	Direct	Direct	Direct	Direct
	Output	W x No.	(900 x 2) + (1,200 x 1)	(900 x 2) + (1,200 x 1)	(900 x 2) + (1,200 x 1)	(900 x 2) + (1,200 x 1)	(900 x 2) + (1,200 x 1)
Compressor	Type	-	Hermetically Sealed Scroll	Hermetically Sealed Scroll	Hermetically Sealed Scroll	Hermetically Sealed Scroll	Hermetically Sealed Scroll
	Piston Displacement	cm ³ /rev	62.1 x 2	62.1 x 3	62.1 x 3	62.1 x 3	62.1 x 3
	Number of Revolution	rev./min	3,600 x 2	3,600 x 3	3,600 x 3	3,600 x 3	3,600 x 3
	Motor Output	W x No.	5,300 x 2	5,300 x 3	5,300 x 3	5,300 x 3	5,300 x 3
	Oil Type	-	FW68L (PVE)	FW68L (PVE)	FW68L (PVE)	FW68L (PVE)	FW68L (PVE)
Heat Exchanger	Fin Type	-	Wide Louver Plus	Wide Louver Plus	Wide Louver Plus	Wide Louver Plus	Wide Louver Plus
Dimensions	Net (W x H x D)	mm	((1,240 x 1,745 x 760) x 1) + ((930 x 1,745 x 760) x 1)	((1,240 x 1,745 x 760) x 1) + ((930 x 1,745 x 760) x 1)	((1,240 x 1,745 x 760) x 1) + ((930 x 1,745 x 760) x 1)	((1,240 x 1,745 x 760) x 1) + ((930 x 1,745 x 760) x 1)	((1,240 x 1,745 x 760) x 1) + ((930 x 1,745 x 760) x 1)
Weight	Net	kg	217 + 201	263 + 201	263 + 201	283 + 201	283 + 201
Exterior	Color	-	Morning Gray / Dawn Gray	Morning Gray / Dawn Gray	Morning Gray / Dawn Gray	Morning Gray / Dawn Gray	Morning Gray / Dawn Gray
	RAL (Classic)	-	RAL 7038 / RAL 7037	RAL 7038 / RAL 7037	RAL 7038 / RAL 7037	RAL 7038 / RAL 7037	RAL 7038 / RAL 7037
Refrigerant	Type	-	R410A	R410A	R410A	R410A	R410A
	Precharged Amount	kg	20.0	22.0	22.0	25.0	25.0
	t-CO ₂ eq.	-	41.750	45.925	45.925	52.188	52.188
	Control Type	-	EEV	EEV	EEV	EEV	EEV
Connecting Pipe	Liquid	mm (inch)	Ø 19.05 (3/4)	Ø 19.05 (3/4)	Ø 19.05 (3/4)	Ø 19.05 (3/4)	Ø 19.05 (3/4)
	Gas	mm (inch)	Ø 34.9 (1-3/8)	Ø 34.9 (1-3/8)	Ø 34.9 (1-3/8)	Ø 34.9 (1-3/8)	Ø 41.3 (1-5/8)
Sound Pressure Level (Outdoor Unit)	Cooling / Heating	dB (A)	62.8 / 63.8	63.1 / 64.1	63.8 / 65.1	65.6 / 65.8	66.0 / 67.0
Connecting Cable	Communication Cable (VCTF-SB)	mm ² x cores	1.0 - 1.5 x 2 C	1.0 - 1.5 x 2 C	1.0 - 1.5 x 2 C	1.0 - 1.5 x 2 C	1.0 - 1.5 x 2 C
Connectable Indoor Units Number	Max. (Conditional)	EA	45 (56)	49 (60)	52 (64)	55 (64)	58 (64)

**ARUN380LTE6 / ARUN400LTE6
ARUN420LTE6**



HP			38	40	42
Classification	Chassis	-	UXB + UXB	UXB + UXB	UXB + UXB
	Combination Unit	-	ARUN240LTE6 ARUN140LTE6	ARUN240LTE6 ARUN160LTE6	ARUN240LTE6 ARUN180LTE6
Power Supply	Case 1	V / Ø / Hz	380 - 400 - 415, 3, 50	380 - 400 - 415, 3, 50	380 - 400 - 415, 3, 50
	Limit Range of Voltage (Case 1)	V	342 - 456	342 - 456	342 - 456
	Case 2	V / Ø / Hz	380, 3, 60	380, 3, 60	380, 3, 60
	Limit Range of Voltage (Case 2)	V	342 - 418	342 - 418	342 - 418
Cooling Capacity	Rated	kW	106.4	112.0	117.6
	Rated	Btu/h	363,100	382,200	401,300
Heating Capacity	Rated	kW	118.4	124.7	131.0
	Rated	Btu/h	403,900	425,400	446,900
Power Input (Cooling)	Rated	kW	24.45	25.98	26.30
Power Input (Heating)	Rated	kW	27.30	28.80	29.20
Efficiency	COP Cooling	W/W	4.35	4.31	4.47
	COP Heating	W/W	4.34	4.33	4.49
Power Factor (Cooling / Heating)	Rated		0.93 / 0.93	0.93 / 0.93	0.93 / 0.93
Outdoor Fan	Type	-	Propeller Fan	Propeller Fan	Propeller Fan
	Air Flow Rate (High)	m³/min x No.	(320 × 1) + (320 × 1)	(320 × 1) + (320 × 1)	(320 × 1) + (320 × 1)
	Max. External Static Pressure	Pa	80	80	80
	Discharge Direction (Side / Top)		Top	Top	Top
Outdoor Fan Motor	Drive	-	Direct	Direct	Direct
	Output	W x No.	(900 × 2) + (900 × 2)	(900 × 2) + (900 × 2)	(900 × 2) + (900 × 2)
Compressor	Type	-	Hermetically Sealed Scroll	Hermetically Sealed Scroll	Hermetically Sealed Scroll
	Piston Displacement	cm³/rev	62.1 × 3	62.1 × 3	62.1 × 4
	Number of Revolution	rev./min	3,600 × 3	3,600 × 3	3,600 × 4
	Motor Output	W x No.	5,300 × 3	5,300 × 3	5,300 × 4
	Oil Type	-	FW68L (PVE)	FW68L (PVE)	FW68L (PVE)
Heat Exchanger	Fin Type	-	Wide Louver Plus	Wide Louver Plus	Wide Louver Plus
Dimensions	Net (W x H x D)	mm	(1,240 × 1,745 × 760) × 2	(1,240 × 1,745 × 760) × 2	(1,240 × 1,745 × 760) × 2
Weight	Net	kg	283 + 217	283 + 217	283 + 263
Exterior	Color	-	Morning Gray / Dawn Gray	Morning Gray / Dawn Gray	Morning Gray / Dawn Gray
	RAL (Classic)	-	RAL 7038 / RAL 7037	RAL 7038 / RAL 7037	RAL 7038 / RAL 7037
Refrigerant	Type	-	R410A	R410A	R410A
	Precharged Amount	kg	270	270	290
	t-CO ₂ eq.	-	56.363	56.363	60.538
	Control Type	-	EEV	EEV	EEV
Connecting Pipe	Liquid	mm (inch)	Ø 19.05 (3/4)	Ø 19.05 (3/4)	Ø 19.05 (3/4)
	Gas	mm (inch)	Ø 41.3 (1-5/8)	Ø 41.3 (1-5/8)	Ø 41.3 (1-5/8)
Sound Pressure Level (Outdoor Unit)	Cooling / Heating	dB (A)	66.2 / 67.2	66.3 / 67.3	66.5 / 67.5
Connecting Cable	Communication Cable (VCTF-SB)	mm² × cores	1.0 - 1.5 × 2 C	1.0 - 1.5 × 2 C	1.0 - 1.5 × 2 C
Connectable Indoor Units Number	Max. (Conditional)	EA	61 (64)	64	64

**ARUN440LTE6 / ARUN460LTE6
ARUN480LTE6**



HP			44	46	48
Classification	Chassis	-	UXB + UXB	UXB + UXB	UXB + UXB
	Combination Unit	-	ARUN240LTE6 ARUN200LTE6	ARUN240LTE6 ARUN220LTE6	ARUN240LTE6 ARUN240LTE6
Power Supply	Case 1	V / Ø / Hz	380 - 400 - 415, 3, 50	380 - 400 - 415, 3, 50	380 - 400 - 415, 3, 50
	Limit Range of Voltage (Case 1)	V	342 - 456	342 - 456	342 - 456
	Case 2	V / Ø / Hz	380, 3, 60	380, 3, 60	380, 3, 60
	Limit Range of Voltage (Case 2)	V	342 - 418	342 - 418	342 - 418
Cooling Capacity	Rated	kW	123.2	128.8	134.4
	Rated	Btu/h	420,400	439,500	458,600
Heating Capacity	Rated	kW	137.3	143.6	148.6
	Rated	Btu/h	468,400	489,900	506,800
Power Input (Cooling)	Rated	kW	27.62	30.00	31.80
Power Input (Heating)	Rated	kW	32.60	34.70	36.00
Efficiency	COP Cooling	W/W	4.46	4.29	4.23
	COP Heating	W/W	4.21	4.14	4.13
Power Factor (Cooling / Heating)	Rated		0.93 / 0.93	0.93 / 0.93	0.93 / 0.93
Outdoor Fan	Type	-	Propeller Fan	Propeller Fan	Propeller Fan
	Air Flow Rate (High)	m ³ /min x No.	(320 × 1) + (320 × 1)	(320 × 1) + (320 × 1)	(320 × 1) + (320 × 1)
	Max. External Static Pressure	Pa	80	80	80
	Discharge Direction (Side / Top)		Top	Top	Top
Outdoor Fan Motor	Drive	-	Direct	Direct	Direct
	Output	W x No.	(900 × 2) + (900 × 2)	(900 × 2) + (900 × 2)	(900 × 2) + (900 × 2)
Compressor	Type	-	Hermetically Sealed Scroll	Hermetically Sealed Scroll	Hermetically Sealed Scroll
	Piston Displacement	cm ³ /rev	62.1 × 4	62.1 × 4	62.1 × 4
	Number of Revolution	rev./min	3,600 × 4	3,600 × 4	3,600 × 4
	Motor Output	W x No.	5,300 × 4	5,300 × 4	5,300 × 4
	Oil Type	-	FW68L (PVE)	FW68L (PVE)	FW68L (PVE)
Heat Exchanger	Fin Type	-	Wide Louver Plus	Wide Louver Plus	Wide Louver Plus
Dimensions	Net (W x H x D)	mm	(1,240 × 1,745 × 760) × 2	(1,240 × 1,745 × 760) × 2	(1,240 × 1,745 × 760) × 2
Weight	Net	kg	283 + 263	283 + 283	283 + 283
Exterior	Color	-	Morning Gray / Dawn Gray	Morning Gray / Dawn Gray	Morning Gray / Dawn Gray
	RAL (Classic)	-	RAL 7038 / RAL 7037	RAL 7038 / RAL 7037	RAL 7038 / RAL 7037
Refrigerant	Type	-	R410A	R410A	R410A
	Precharged Amount	kg	29.0	32.0	32.0
	t-CO ₂ eq.	-	60.538	66.800	66.800
	Control Type	-	EEV	EEV	EEV
Connecting Pipe	Liquid	mm (inch)	Ø 19.05 (3/4)	Ø 19.05 (3/4)	Ø 19.05 (3/4)
	Gas	mm (inch)	Ø 41.3 (1-5/8)	Ø 41.3 (1-5/8)	Ø 41.3 (1-5/8)
Sound Pressure Level (Outdoor Unit)	Cooling / Heating	dB (A)	66.8 / 67.9	67.8 / 68.4	68.0 / 69.0
Connecting Cable	Communication Cable (VCTF-SB)	mm ² × cores	1.0 - 1.5 × 2 C	1.0 - 1.5 × 2 C	1.0 - 1.5 × 2 C
Connectable Indoor Units Number	Max. (Conditional)	EA	64	64	64

**ARUN500LTE6 / ARUN520LTE6
ARUN540LTE6**



HP			50	52	54
Classification	Chassis	-	UXB + UXB + UXA	UXB + UXB + UXA	UXB + UXB + UXA
	Combination Unit	-	ARUN240LTE6 ARUN140LTE6 ARUN120LTE6	ARUN240LTE6 ARUN160LTE6 ARUN120LTE6	ARUN240LTE6 ARUN180LTE6 ARUN120LTE6
Power Supply	Case 1	V / Ø / Hz	380 - 400 - 415, 3, 50	380 - 400 - 415, 3, 50	380 - 400 - 415, 3, 50
	Limit Range of Voltage (Case 1)	V	342 - 456	342 - 456	342 - 456
	Case 2	V / Ø / Hz	380, 3, 60	380, 3, 60	380, 3, 60
	Limit Range of Voltage (Case 2)	V	342 - 418	342 - 418	342 - 418
Cooling Capacity	Rated	kW	140.0	145.6	151.2
	Rated	Btu/h	477,700	496,800	515,900
Heating Capacity	Rated	kW	156.2	162.5	168.8
	Rated	Btu/h	532,900	554,400	575,900
Power Input (Cooling)	Rated	kW	31.82	33.35	33.67
Power Input (Heating)	Rated	kW	34.90	36.40	36.80
Efficiency	COP Cooling	W/W	4.40	4.37	4.49
	COP Heating	W/W	4.48	4.46	4.59
Power Factor (Cooling / Heating)	Rated		0.93 / 0.93	0.93 / 0.93	0.93 / 0.93
Outdoor Fan	Type	-	Propeller Fan	Propeller Fan	Propeller Fan
	Air Flow Rate (High)	m ³ /min x No.	(320 x 1) + (320 x 1) + (220 x 1)	(320 x 1) + (320 x 1) + (220 x 1)	(320 x 1) + (320 x 1) + (220 x 1)
	Max. External Static Pressure	Pa	80	80	80
	Discharge Direction (Side / Top)		Top	Top	Top
Outdoor Fan Motor	Drive	-	Direct	Direct	Direct
	Output	W x No.	(900 x 2) + (900 x 2) + (1,200 x 1)	(900 x 2) + (900 x 2) + (1,200 x 1)	(900 x 2) + (900 x 2) + (1,200 x 1)
Compressor	Type	-	Hermetically Sealed Scroll	Hermetically Sealed Scroll	Hermetically Sealed Scroll
	Piston Displacement	cm ³ /rev	62.1 x 4	62.1 x 4	62.1 x 5
	Number of Revolution	rev./min	3,600 x 4	3,600 x 4	3,600 x 5
	Motor Output	W x No.	5,300 x 4	5,300 x 4	5,300 x 5
Heat Exchanger	Oil Type	-	FW68L (PVE)	FW68L (PVE)	FW68L (PVE)
Heat Exchanger	Fin Type	-	Wide Louver Plus	Wide Louver Plus	Wide Louver Plus
Dimensions	Net (W x H x D)	mm	((1,240 x 1,745 x 760) x 2) + ((930 x 1,745 x 760) x 1)	((1,240 x 1,745 x 760) x 2) + ((930 x 1,745 x 760) x 1)	((1,240 x 1,745 x 760) x 2) + ((930 x 1,745 x 760) x 1)
Weight	Net	kg	283 + 217 + 201	283 + 217 + 201	283 + 263 + 201
Exterior	Color	-	Morning Gray / Dawn Gray	Morning Gray / Dawn Gray	Morning Gray / Dawn Gray
	RAL (Classic)	-	RAL 7038 / RAL 7037	RAL 7038 / RAL 7037	RAL 7038 / RAL 7037
Refrigerant	Type	-	R410A	R410A	R410A
	Precharged Amount	kg	36.0	36.0	38.0
	t-CO ₂ eq.	-	75.150	75.150	79.325
	Control Type	-	EEV	EEV	EEV
Connecting Pipe	Liquid	mm (inch)	Ø 19.05 (3/4)	Ø 19.05 (3/4)	Ø 19.05 (3/4)
	Gas	mm (inch)	Ø 41.3 (1-5/8)	Ø 41.3 (1-5/8)	Ø 41.3 (1-5/8)
Sound Pressure Level (Outdoor Unit)	Cooling / Heating	dB (A)	66.9 / 68.0	67.1 / 68.1	67.2 / 68.2
Connecting Cable	Communication Cable (VCTF-SB)	mm ² x cores	1.0 - 1.5 x 2 C	1.0 - 1.5 x 2 C	1.0 - 1.5 x 2 C
Connectable Indoor Units Number	Max. (Conditional)	EA	64	64	64

**ARUN560LTE6 / ARUN580LTE6
ARUN600LTE6**



HP			56	58	60
Classification	Chassis	-	UXB + UXB + UXA	UXB + UXB + UXA	UXB + UXB + UXA
	Combination Unit	-	ARUN240LTE6 ARUN200LTE6 ARUN120LTE6	ARUN240LTE6 ARUN220LTE6 ARUN120LTE6	ARUN240LTE6 ARUN240LTE6 ARUN120LTE6
Power Supply	Case 1	V / Ø / Hz	380 - 400 - 415, 3, 50	380 - 400 - 415, 3, 50	380 - 400 - 415, 3, 50
	Limit Range of Voltage (Case 1)	V	342 - 456	342 - 456	342 - 456
	Case 2	V / Ø / Hz	380, 3, 60	380, 3, 60	380, 3, 60
	Limit Range of Voltage (Case 2)	V	342 - 418	342 - 418	342 - 418
Cooling Capacity	Rated	kW	156.8	162.4	168.0
	Rated	Btu/h	535,000	554,100	573,200
Heating Capacity	Rated	kW	175.1	181.4	186.4
	Rated	Btu/h	597,400	618,900	635,800
Power Input (Cooling)	Rated	kW	34.99	37.37	39.17
Power Input (Heating)	Rated	kW	40.20	42.30	43.60
Efficiency	COP Cooling	W/W	4.48	4.35	4.29
	COP Heating	W/W	4.36	4.29	4.28
Power Factor (Cooling / Heating)	Rated		0.93 / 0.93	0.93 / 0.93	0.93 / 0.93
Outdoor Fan	Type	-	Propeller Fan	Propeller Fan	Propeller Fan
	Air Flow Rate (High)	m ³ /min x No.	(320 × 1) + (320 × 1) + (220 × 1)	(320 × 1) + (320 × 1) + (220 × 1)	(320 × 1) + (320 × 1) + (220 × 1)
	Max. External Static Pressure	Pa	80	80	80
	Discharge Direction (Side / Top)		Top	Top	Top
Outdoor Fan Motor	Drive	-	Direct	Direct	Direct
	Output	W x No.	(900 × 2) + (900 × 2) + (1,200 × 1)	(900 × 2) + (900 × 2) + (1,200 × 1)	(900 × 2) + (900 × 2) + (1,200 × 1)
Compressor	Type	-	Hermetically Sealed Scroll	Hermetically Sealed Scroll	Hermetically Sealed Scroll
	Piston Displacement	cm ³ /rev	62.1 × 5	62.1 × 5	62.1 × 5
	Number of Revolution	rev./min	3,600 × 5	3,600 × 5	3,600 × 5
	Motor Output	W x No.	5,300 × 5	5,300 × 5	5,300 × 5
	Oil Type	-	FW68L (PVE)	FW68L (PVE)	FW68L (PVE)
Heat Exchanger	Fin Type	-	Wide Louver Plus	Wide Louver Plus	Wide Louver Plus
Dimensions	Net (W × H × D)	mm	((1,240 × 1,745 × 760) × 2) + ((930 × 1,745 × 760) × 1)	((1,240 × 1,745 × 760) × 2) + ((930 × 1,745 × 760) × 1)	((1,240 × 1,745 × 760) × 2) + ((930 × 1,745 × 760) × 1)
Weight	Net	kg	283 + 263 + 201	283 + 283 + 201	283 + 283 + 201
Exterior	Color	-	Morning Gray / Dawn Gray	Morning Gray / Dawn Gray	Morning Gray / Dawn Gray
	RAL (Classic)	-	RAL 7038 / RAL 7037	RAL 7038 / RAL 7037	RAL 7038 / RAL 7037
Refrigerant	Type	-	R410A	R410A	R410A
	Precharged Amount	kg	38.0	41.0	41.0
	t-CO ₂ eq.	-	79.325	85.588	85.588
	Control Type	-	EEV	EEV	EEV
Connecting Pipe	Liquid	mm (inch)	Ø 19.05 (3/4)	Ø 19.05 (3/4)	Ø 19.05 (3/4)
	Gas	mm (inch)	Ø 41.3 (1-5/8)	Ø 41.3 (1-5/8)	Ø 41.3 (1-5/8)
Sound Pressure Level (Outdoor Unit)	Cooling / Heating	dB (A)	67.4 / 68.6	68.3 / 68.9	68.5 / 69.5
Connecting Cable	Communication Cable (VCTF-SB)	mm ² × cores	1.0 - 1.5 × 2 C	1.0 - 1.5 × 2 C	1.0 - 1.5 × 2 C
Connectable Indoor Units Number	Max. (Conditional)	EA	64	64	64

**ARUN620LTE6 / ARUN640LTE6
ARUN660LTE6**



HP			62	64	66
Classification	Chassis	-	UXB + UXB + UXB	UXB + UXB + UXB	UXB + UXB + UXB
	Combination Unit	-	ARUN240LTE6 ARUN240LTE6 ARUN140LTE6	ARUN240LTE6 ARUN240LTE6 ARUN160LTE6	ARUN240LTE6 ARUN240LTE6 ARUN180LTE6
Power Supply	Case 1	V / Ø / Hz	380 - 400 - 415, 3, 50	380 - 400 - 415, 3, 50	380 - 400 - 415, 3, 50
	Limit Range of Voltage (Case 1)	V	342 - 456	342 - 456	342 - 456
	Case 2	V / Ø / Hz	380, 3, 60	380, 3, 60	380, 3, 60
	Limit Range of Voltage (Case 2)	V	342 - 418	342 - 418	342 - 418
Cooling Capacity	Rated	kW	173.6	179.2	184.8
	Rated	Btu/h	592,400	611,500	630,600
Heating Capacity	Rated	kW	192.7	199.0	205.3
	Rated	Btu/h	657,300	678,800	700,300
Power Input (Cooling)	Rated	kW	40.35	41.88	42.20
Power Input (Heating)	Rated	kW	45.30	46.80	47.20
Efficiency	COP Cooling	W/W	4.30	4.28	4.38
	COP Heating	W/W	4.25	4.25	4.35
Power Factor (Cooling / Heating)	Rated		0.93 / 0.93	0.93 / 0.93	0.93 / 0.93
Outdoor Fan	Type	-	Propeller Fan	Propeller Fan	Propeller Fan
	Air Flow Rate (High)	m ³ /min x No.	(320 x 1) + (320 x 1) + (320 x 1)	(320 x 1) + (320 x 1) + (320 x 1)	(320 x 1) + (320 x 1) + (320 x 1)
	Max. External Static Pressure	Pa	80	80	80
	Discharge Direction (Side / Top)		Top	Top	Top
Outdoor Fan Motor	Drive	-	Direct	Direct	Direct
	Output	W x No.	(900 x 2) + (900 x 2) + (900 x 2)	(900 x 2) + (900 x 2) + (900 x 2)	(900 x 2) + (900 x 2) + (900 x 2)
Compressor	Type	-	Hermetically Sealed Scroll	Hermetically Sealed Scroll	Hermetically Sealed Scroll
	Piston Displacement	cm ³ /rev	62.1 x 5	62.1 x 5	62.1 x 6
	Number of Revolution	rev./min	3,600 x 5	3,600 x 5	3,600 x 6
	Motor Output	W x No.	5,300 x 5	5,300 x 5	5,300 x 6
Oil Type	-	FW68L (PVE)	FW68L (PVE)	FW68L (PVE)	
Heat Exchanger	Fin Type	-	Wide Louver Plus	Wide Louver Plus	Wide Louver Plus
Dimensions	Net (W x H x D)	mm	(1,240 x 1,745 x 760) x 3	(1,240 x 1,745 x 760) x 3	(1,240 x 1,745 x 760) x 3
Weight	Net	kg	283 + 283 + 217	283 + 283 + 217	283 + 283 + 263
Exterior	Color	-	Morning Gray / Dawn Gray	Morning Gray / Dawn Gray	Morning Gray / Dawn Gray
	RAL (Classic)	-	RAL 7038 / RAL 7037	RAL 7038 / RAL 7037	RAL 7038 / RAL 7037
Refrigerant	Type	-	R410A	R410A	R410A
	Precharged Amount	kg	430	430	45.0
	t-CO ₂ eq.	-	89.763	89.763	93.938
	Control Type	-	EEV	EEV	EEV
Connecting Pipe	Liquid	mm (inch)	Ø 22.2 (7/8)	Ø 22.2 (7/8)	Ø 22.2 (7/8)
	Gas	mm (inch)	Ø 41.3 (1-5/8)	Ø 41.3 (1-5/8)	Ø 53.98 (2-1/8)
Sound Pressure Level (Outdoor Unit)	Cooling / Heating	dB (A)	68.6 / 69.7	68.7 / 69.7	68.8 / 69.8
Connecting Cable	Communication Cable (VCTF-SB)	mm ² x cores	1.0 - 1.5 x 2 C	1.0 - 1.5 x 2 C	1.0 - 1.5 x 2 C
Connectable Indoor Units Number	Max. (Conditional)	EA	64	64	64

**ARUN680LTE6 / ARUN700LTE6
ARUN720LTE6**



HP			68	70	72
Classification	Chassis	-	UXB + UXB + UXB	UXB + UXB + UXB	UXB + UXB + UXB
	Combination Unit	-	ARUN240LTE6 ARUN240LTE6 ARUN200LTE6	ARUN240LTE6 ARUN240LTE6 ARUN220LTE6	ARUN240LTE6 ARUN240LTE6 ARUN240LTE6
Power Supply	Case 1	V / Ø / Hz	380 - 400 - 415, 3, 50	380 - 400 - 415, 3, 50	380 - 400 - 415, 3, 50
	Limit Range of Voltage (Case 1)	V	342 - 456	342 - 456	342 - 456
	Case 2	V / Ø / Hz	380, 3, 60	380, 3, 60	380, 3, 60
	Limit Range of Voltage (Case 2)	V	342 - 418	342 - 418	342 - 418
Cooling Capacity	Rated	kW	190.4	196.0	201.6
	Rated	Btu/h	649,700	668,800	687,900
Heating Capacity	Rated	kW	211.6	217.9	222.9
	Rated	Btu/h	721,800	743,300	760,200
Power Input (Cooling)	Rated	kW	43.52	45.90	47.70
Power Input (Heating)	Rated	kW	50.60	52.70	54.00
Efficiency	COP Cooling	W/W	4.38	4.27	4.23
	COP Heating	W/W	4.18	4.13	4.13
Power Factor (Cooling / Heating)	Rated		0.93 / 0.93	0.93 / 0.93	0.93 / 0.93
Outdoor Fan	Type	-	Propeller Fan	Propeller Fan	Propeller Fan
	Air Flow Rate (High)	m ³ /min x No.	(320 x 1) + (320 x 1) + (320 x 1)	(320 x 1) + (320 x 1) + (320 x 1)	(320 x 1) + (320 x 1) + (320 x 1)
	Max. External Static Pressure	Pa	80	80	80
	Discharge Direction (Side / Top)		Top	Top	Top
Outdoor Fan Motor	Drive	-	Direct	Direct	Direct
	Output	W x No.	(900 x 2) + (900 x 2) + (900 x 2)	(900 x 2) + (900 x 2) + (900 x 2)	(900 x 2) + (900 x 2) + (900 x 2)
Compressor	Type	-	Hermetically Sealed Scroll	Hermetically Sealed Scroll	Hermetically Sealed Scroll
	Piston Displacement	cm ³ /rev	62.1 x 6	62.1 x 6	62.1 x 6
	Number of Revolution	rev./min	3,600 x 6	3,600 x 6	3,600 x 6
	Motor Output	W x No.	5,300 x 6	5,300 x 6	5,300 x 6
Oil Type	-	FW68L (PVE)	FW68L (PVE)	FW68L (PVE)	
Heat Exchanger	Fin Type	-	Wide Louver Plus	Wide Louver Plus	Wide Louver Plus
Dimensions	Net (W x H x D)	mm	(1,240 x 1,745 x 760) x 3	(1,240 x 1,745 x 760) x 3	(1,240 x 1,745 x 760) x 3
Weight	Net	kg	283 + 283 + 263	283 + 283 + 283	283 + 283 + 283
Exterior	Color	-	Morning Gray / Dawn Gray	Morning Gray / Dawn Gray	Morning Gray / Dawn Gray
	RAL (Classic)	-	RAL 7038 / RAL 7037	RAL 7038 / RAL 7037	RAL 7038 / RAL 7037
Refrigerant	Type	-	R410A	R410A	R410A
	Precharged Amount	kg	45.0	48.0	48.0
	t-CO ₂ eq.	-	93.938	100.200	100.200
	Control Type	-	EEV	EEV	EEV
Connecting Pipe	Liquid	mm (inch)	Ø 22.2 (7/8)	Ø 22.2 (7/8)	Ø 22.2 (7/8)
	Gas	mm (inch)	Ø 53.98 (2-1/8)	Ø 53.98 (2-1/8)	Ø 53.98 (2-1/8)
Sound Pressure Level (Outdoor Unit)	Cooling / Heating	dB (A)	69.0 / 70.1	69.6 / 70.4	69.8 / 70.8
Connecting Cable	Communication Cable (VCTF-SB)	mm ² x cores	1.0 - 1.5 x 2 C	1.0 - 1.5 x 2 C	1.0 - 1.5 x 2 C
Connectable Indoor Units Number	Max. (Conditional)	EA	64	64	64

**ARUN740LTE6 / ARUN760LTE6
ARUN780LTE6**



HP			74	76	78
Classification	Chassis	-	UXB + UXB + UXB + UXA	UXB + UXB + UXB + UXA	UXB + UXB + UXB + UXA
	Combination Unit	-	ARUN240LTE6 ARUN240LTE6 ARUN140LTE6 ARUN120LTE6	ARUN240LTE6 ARUN240LTE6 ARUN160LTE6 ARUN120LTE6	ARUN240LTE6 ARUN240LTE6 ARUN180LTE6 ARUN120LTE6
Power Supply	Case 1	V / Ø / Hz	380 - 400 - 415, 3, 50	380 - 400 - 415, 3, 50	380 - 400 - 415, 3, 50
	Limit Range of Voltage (Case 1)	V	342 - 456	342 - 456	342 - 456
	Case 2	V / Ø / Hz	380, 3, 60	380, 3, 60	380, 3, 60
	Limit Range of Voltage (Case 2)	V	342 - 418	342 - 418	342 - 418
Cooling Capacity	Rated	kW	207.2	212.8	218.4
	Rated	Btu/h	707,000	726,100	745,200
Heating Capacity	Rated	kW	230.5	236.8	243.1
	Rated	Btu/h	786,300	807,800	829,300
Power Input (Cooling)	Rated	kW	47.72	49.25	49.57
Power Input (Heating)	Rated	kW	52.90	54.40	54.80
Efficiency	COP Cooling	W/W	4.34	4.32	4.41
	COP Heating	W/W	4.36	4.35	4.44
Power Factor (Cooling / Heating)	Rated		0.93 / 0.93	0.93 / 0.93	0.93 / 0.93
Outdoor Fan	Type	-	Propeller Fan	Propeller Fan	Propeller Fan
	Air Flow Rate (High)	m ³ /min x No.	(320 × 1) + (320 × 1) + (320 × 1) + (220 × 1)	(320 × 1) + (320 × 1) + (320 × 1) + (220 × 1)	(320 × 1) + (320 × 1) + (320 × 1) + (220 × 1)
	Max. External Static Pressure	Pa	80	80	80
	Discharge Direction (Side / Top)	-	Top	Top	Top
Outdoor Fan Motor	Drive	-	Direct	Direct	Direct
	Output	W x No.	(900 × 2) + (900 × 2) + (900 × 2) + (1,200 × 1)	(900 × 2) + (900 × 2) + (900 × 2) + (1,200 × 1)	(900 × 2) + (900 × 2) + (900 × 2) + (1,200 × 1)
Compressor	Type	-	Hermetically Sealed Scroll	Hermetically Sealed Scroll	Hermetically Sealed Scroll
	Piston Displacement	cm ³ /rev	62.1 × 6	62.1 × 6	62.1 × 7
	Number of Revolution	rev./min	3,600 × 6	3,600 × 6	3,600 × 7
	Motor Output	W x No.	5,300 × 6	5,300 × 6	5,300 × 7
Oil Type	-	FW68L (PVE)	FW68L (PVE)	FW68L (PVE)	
Heat Exchanger	Fin Type	-	Wide Louver Plus	Wide Louver Plus	Wide Louver Plus
Dimensions	Net (W x H x D)	mm	((1,240 × 1,745 × 760) × 3) + ((930 × 1,745 × 760) × 1)	((1,240 × 1,745 × 760) × 3) + ((930 × 1,745 × 760) × 1)	((1,240 × 1,745 × 760) × 3) + ((930 × 1,745 × 760) × 1)
Weight	Net	kg	283 + 283 + 217 + 201	283 + 283 + 217 + 201	283 + 283 + 263 + 201
Exterior	Color	-	Morning Gray / Dawn Gray	Morning Gray / Dawn Gray	Morning Gray / Dawn Gray
	RAL (Classic)	-	RAL 7038 / RAL 7037	RAL 7038 / RAL 7037	RAL 7038 / RAL 7037
Refrigerant	Type	-	R410A	R410A	R410A
	Precharged Amount	kg	520	520	540
	t-CO ₂ eq.	-	108.550	108.550	112.725
	Control Type	-	EEV	EEV	EEV
Connecting Pipe	Liquid	mm (inch)	Ø 22.2 (7/8)	Ø 22.2 (7/8)	Ø 22.2 (7/8)
	Gas	mm (inch)	Ø 53.98 (2-1/8)	Ø 53.98 (2-1/8)	Ø 53.98 (2-1/8)
Sound Pressure Level (Outdoor Unit)	Cooling / Heating	dB (A)	69.1 / 70.1	69.2 / 70.2	69.2 / 70.2
Connecting Cable	Communication Cable (VCTF-SB)	mm ² x cores	1.0 - 1.5 x 2 C	1.0 - 1.5 x 2 C	1.0 - 1.5 x 2 C
Connectable Indoor Units Number	Max. (Conditional)	EA	64	64	64

**ARUN800LTE6 / ARUN820LTE6
ARUN840LTE6**



HP			80	82	84
Classification	Chassis	-	UXB + UXB + UXB + UXA	UXB + UXB + UXB + UXA	UXB + UXB + UXB + UXA
	Combination Unit	-	ARUN240LTE6 ARUN240LTE6 ARUN200LTE6 ARUN120LTE6	ARUN240LTE6 ARUN240LTE6 ARUN220LTE6 ARUN120LTE6	ARUN240LTE6 ARUN240LTE6 ARUN240LTE6 ARUN120LTE6
Power Supply	Case 1	V / Ø / Hz	380 - 400 - 415, 3, 50	380 - 400 - 415, 3, 50	380 - 400 - 415, 3, 50
	Limit Range of Voltage (Case 1)	V	342 - 456	342 - 456	342 - 456
	Case 2	V / Ø / Hz	380, 3, 60	380, 3, 60	380, 3, 60
	Limit Range of Voltage (Case 2)	V	342 - 418	342 - 418	342 - 418
Cooling Capacity	Rated	kW	224.0	229.6	235.2
	Rated	Btu/h	764,300	783,400	802,500
Heating Capacity	Rated	kW	249.4	255.7	260.7
	Rated	Btu/h	850,800	872,300	889,200
Power Input (Cooling)	Rated	kW	50.89	53.27	55.07
Power Input (Heating)	Rated	kW	58.20	60.30	61.60
Efficiency	COP Cooling	W/W	4.40	4.31	4.27
	COP Heating	W/W	4.29	4.24	4.23
Power Factor (Cooling / Heating)	Rated		0.93 / 0.93	0.93 / 0.93	0.93 / 0.93
Outdoor Fan	Type	-	Propeller Fan	Propeller Fan	Propeller Fan
	Air Flow Rate (High)	m ³ /min x No.	(320 × 1) + (320 × 1) + (320 × 1) + (220 × 1)	(320 × 1) + (320 × 1) + (320 × 1) + (220 × 1)	(320 × 1) + (320 × 1) + (320 × 1) + (220 × 1)
	Max. External Static Pressure	Pa	80	80	80
	Discharge Direction (Side / Top)	-	Top	Top	Top
Outdoor Fan Motor	Drive	-	Direct	Direct	Direct
	Output	W x No.	(900 × 2) + (900 × 2) + (900 × 2) + (1,200 × 1)	(900 × 2) + (900 × 2) + (900 × 2) + (1,200 × 1)	(900 × 2) + (900 × 2) + (900 × 2) + (1,200 × 1)
Compressor	Type	-	Hermetically Sealed Scroll	Hermetically Sealed Scroll	Hermetically Sealed Scroll
	Piston Displacement	cm ³ /rev	62.1 × 7	62.1 × 7	62.1 × 7
	Number of Revolution	rev./min	3,600 × 7	3,600 × 7	3,600 × 7
	Motor Output	W x No.	5,300 × 7	5,300 × 7	5,300 × 7
Heat Exchanger	Oil Type	-	FW68L (PVE)	FW68L (PVE)	FW68L (PVE)
	Fin Type	-	Wide Louver Plus	Wide Louver Plus	Wide Louver Plus
Dimensions	Net (W x H x D)	mm	((1,240 × 1,745 × 760) × 3) + ((930 × 1,745 × 760) × 1)	((1,240 × 1,745 × 760) × 3) + ((930 × 1,745 × 760) × 1)	((1,240 × 1,745 × 760) × 3) + ((930 × 1,745 × 760) × 1)
Weight	Net	kg	283 + 283 + 263 + 201	283 + 283 + 283 + 201	283 + 283 + 283 + 201
Exterior	Color	-	Morning Gray / Dawn Gray	Morning Gray / Dawn Gray	Morning Gray / Dawn Gray
	RAL (Classic)	-	RAL 7038 / RAL 7037	RAL 7038 / RAL 7037	RAL 7038 / RAL 7037
Refrigerant	Type	-	R410A	R410A	R410A
	Precharged Amount	kg	54.0	57.0	57.0
	t-CO ₂ eq.	-	112.725	118.988	118.988
	Control Type	-	EEV	EEV	EEV
Connecting Pipe	Liquid	mm (inch)	Ø 22.2 (7/8)	Ø 22.2 (7/8)	Ø 22.2 (7/8)
	Gas	mm (inch)	Ø 53.98 (2-1/8)	Ø 53.98 (2-1/8)	Ø 53.98 (2-1/8)
Sound Pressure Level (Outdoor Unit)	Cooling / Heating	dB (A)	69.4 / 70.5	70.0 / 70.7	70.1 / 71.1
Connecting Cable	Communication Cable (VCTF-SB)	mm ² × cores	1.0 - 1.5 × 2 C	1.0 - 1.5 × 2 C	1.0 - 1.5 × 2 C
Connectable Indoor Units Number	Max. (Conditional)	EA	64	64	64

**ARUN860LTE6 / ARUN880LTE6
ARUN900LTE6**



HP			86	88	90
Classification	Chassis	-	UXB + UXB + UXB + UXB	UXB + UXB + UXB + UXB	UXB + UXB + UXB + UXB
	Combination Unit	-	ARUN240LTE6 ARUN240LTE6 ARUN240LTE6 ARUN140LTE6	ARUN240LTE6 ARUN240LTE6 ARUN240LTE6 ARUN160LTE6	ARUN240LTE6 ARUN240LTE6 ARUN240LTE6 ARUN180LTE6
Power Supply	Case 1	V / Ø / Hz	380 - 400 - 415, 3, 50	380 - 400 - 415, 3, 50	380 - 400 - 415, 3, 50
	Limit Range of Voltage (Case 1)	V	342 - 456	342 - 456	342 - 456
	Case 2	V / Ø / Hz	380, 3, 60	380, 3, 60	380, 3, 60
	Limit Range of Voltage (Case 2)	V	342 - 418	342 - 418	342 - 418
Cooling Capacity	Rated	kW	240.8	246.4	252.0
	Rated	Btu/h	821,700	840,800	859,900
Heating Capacity	Rated	kW	267.0	273.3	279.6
	Rated	Btu/h	910,700	932,200	953,700
Power Input (Cooling)	Rated	kW	56.25	57.78	58.10
Power Input (Heating)	Rated	kW	63.30	64.80	65.20
Efficiency	COP Cooling	W/W	4.28	4.26	4.34
	COP Heating	W/W	4.22	4.22	4.29
Power Factor (Cooling / Heating)	Rated		0.93 / 0.93	0.93 / 0.93	0.93 / 0.93
Outdoor Fan	Type	-	Propeller Fan	Propeller Fan	Propeller Fan
	Air Flow Rate (High)	m ³ /min x No.	(320 x 1) + (320 x 1) + (320 x 1) + (320 x 1)	(320 x 1) + (320 x 1) + (320 x 1) + (320 x 1)	(320 x 1) + (320 x 1) + (320 x 1) + (320 x 1)
	Max. External Static Pressure	Pa	80	80	80
	Discharge Direction (Side / Top)	-	Top	Top	Top
Outdoor Fan Motor	Drive	-	Direct	Direct	Direct
	Output	W x No.	(900 x 2) + (900 x 2) + (900 x 2) + (900 x 2)	(900 x 2) + (900 x 2) + (900 x 2) + (900 x 2)	(900 x 2) + (900 x 2) + (900 x 2) + (900 x 2)
Compressor	Type	-	Hermetically Sealed Scroll	Hermetically Sealed Scroll	Hermetically Sealed Scroll
	Piston Displacement	cm ³ /rev	62.1 x 7	62.1 x 7	62.1 x 8
	Number of Revolution	rev./min	3,600 x 7	3,600 x 7	3,600 x 8
	Motor Output	W x No.	5,300 x 7	5,300 x 7	5,300 x 8
Oil Type	-	FW68L (PVE)	FW68L (PVE)	FW68L (PVE)	
Heat Exchanger	Fin Type	-	Wide Louver Plus	Wide Louver Plus	Wide Louver Plus
Dimensions	Net (W x H x D)	mm	(1,240 x 1,745 x 760) x 4	(1,240 x 1,745 x 760) x 4	(1,240 x 1,745 x 760) x 4
Weight	Net	kg	283 + 283 + 283 + 217	283 + 283 + 283 + 217	283 + 283 + 283 + 263
Exterior	Color	-	Morning Gray / Dawn Gray	Morning Gray / Dawn Gray	Morning Gray / Dawn Gray
	RAL (Classic)	-	RAL 7038 / RAL 7037	RAL 7038 / RAL 7037	RAL 7038 / RAL 7037
Refrigerant	Type	-	R410A	R410A	R410A
	Precharged Amount	kg	590	590	610
	t-CO ₂ eq.	-	123.163	123.163	127.338
	Control Type	-	EEV	EEV	EEV
Connecting Pipe	Liquid	mm (inch)	Ø 22.2 (7/8)	Ø 22.2 (7/8)	Ø 22.2 (7/8)
	Gas	mm (inch)	Ø 53.98 (2-1/8)	Ø 53.98 (2-1/8)	Ø 53.98 (2-1/8)
Sound Pressure Level (Outdoor Unit)	Cooling / Heating	dB (A)	70.2 / 71.2	70.3 / 71.3	70.3 / 71.3
Connecting Cable	Communication Cable (VCTF-SB)	mm ² x cores	1.0 - 1.5 x 2 C	1.0 - 1.5 x 2 C	1.0 - 1.5 x 2 C
Connectable Indoor Units Number	Max. (Conditional)	EA	64	64	64

**ARUN920LTE6 / ARUN940LTE6
ARUN960LTE6**



HP			92	94	96
Classification	Chassis	-	UXB + UXB + UXB + UXB	UXB + UXB + UXB + UXB	UXB + UXB + UXB + UXB
	Combination Unit	-	ARUN240LTE6 ARUN240LTE6 ARUN240LTE6 ARUN200LTE6	ARUN240LTE6 ARUN240LTE6 ARUN240LTE6 ARUN220LTE6	ARUN240LTE6 ARUN240LTE6 ARUN240LTE6 ARUN240LTE6
Power Supply	Case 1	V / Ø / Hz	380 - 400 - 415, 3, 50	380 - 400 - 415, 3, 50	380 - 400 - 415, 3, 50
	Limit Range of Voltage (Case 1)	V	342 - 456	342 - 456	342 - 456
	Case 2	V / Ø / Hz	380, 3, 60	380, 3, 60	380, 3, 60
	Limit Range of Voltage (Case 2)	V	342 - 418	342 - 418	342 - 418
Cooling Capacity	Rated	kW	257.6	263.2	268.8
	Rated	Btu/h	879,000	898,100	917,200
Heating Capacity	Rated	kW	285.9	292.2	297.2
	Rated	Btu/h	975,200	996,700	1,013,600
Power Input (Cooling)	Rated	kW	59.42	61.80	63.60
Power Input (Heating)	Rated	kW	68.60	70.70	72.00
Efficiency	COP Cooling	W/W	4.34	4.26	4.23
	COP Heating	W/W	4.17	4.13	4.13
Power Factor (Cooling / Heating)	Rated		0.93 / 0.93	0.93 / 0.93	0.93 / 0.93
Outdoor Fan	Type	-	Propeller Fan	Propeller Fan	Propeller Fan
	Air Flow Rate (High)	m ³ /min x No.	(320 × 1) + (320 × 1) + (320 × 1) + (320 × 1)	(320 × 1) + (320 × 1) + (320 × 1) + (320 × 1)	(320 × 1) + (320 × 1) + (320 × 1) + (320 × 1)
	Max. External Static Pressure	Pa	80	80	80
	Discharge Direction (Side / Top)	-	Top	Top	Top
Outdoor Fan Motor	Drive	-	Direct	Direct	Direct
	Output	W x No.	(900 × 2) + (900 × 2) + (900 × 2) + (900 × 2)	(900 × 2) + (900 × 2) + (900 × 2) + (900 × 2)	(900 × 2) + (900 × 2) + (900 × 2) + (900 × 2)
Compressor	Type	-	Hermetically Sealed Scroll	Hermetically Sealed Scroll	Hermetically Sealed Scroll
	Piston Displacement	cm ³ /rev	62.1 x 8	62.1 x 8	62.1 x 8
	Number of Revolution	rev./min	3,600 x 8	3,600 x 8	3,600 x 8
	Motor Output	W x No.	5,300 x 8	5,300 x 8	5,300 x 8
Heat Exchanger	Oil Type	-	FW68L (PVE)	FW68L (PVE)	FW68L (PVE)
	Fin Type	-	Wide Louver Plus	Wide Louver Plus	Wide Louver Plus
Dimensions	Net (W x H x D)	mm	(1,240 x 1,745 x 760) x 4	(1,240 x 1,745 x 760) x 4	(1,240 x 1,745 x 760) x 4
Weight	Net	kg	283 + 283 + 283 + 263	283 + 283 + 283 + 283	283 + 283 + 283 + 283
Exterior	Color	-	Morning Gray / Dawn Gray	Morning Gray / Dawn Gray	Morning Gray / Dawn Gray
	RAL (Classic)	-	RAL 7038 / RAL 7037	RAL 7038 / RAL 7037	RAL 7038 / RAL 7037
Refrigerant	Type	-	R410A	R410A	R410A
	Precharged Amount	kg	61.0	64.0	64.0
	t-CO ₂ eq.	-	127.338	133.600	133.600
	Control Type	-	EEV	EEV	EEV
Connecting Pipe	Liquid	mm (inch)	Ø 22.2 (7/8)	Ø 22.2 (7/8)	Ø 22.2 (7/8)
	Gas	mm (inch)	Ø 53.98 (2-1/8)	Ø 53.98 (2-1/8)	Ø 53.98 (2-1/8)
Sound Pressure Level (Outdoor Unit)	Cooling / Heating	dB (A)	70.4 / 71.5	70.9 / 71.7	71.0 / 72.0
Connecting Cable	Communication Cable (VCTF-SB)	mm ² x cores	1.0 - 1.5 x 2 C	1.0 - 1.5 x 2 C	1.0 - 1.5 x 2 C
Connectable Indoor Units Number	Max. (Conditional)	EA	64	64	64

1. Due to our policy of innovation some specifications may be changed without notification.
2. Capacities are based on the following conditions :
 - Cooling : Indoor 27°C DB / 19°C WB Outdoor 35°C DB / 24°C WB
 - Heating : Indoor 20°C DB / 15°C WB Outdoor 7°C DB / 6°C WB
 - Piping Length : Interconnected Pipe Length = 7.5 m
 - Elevation Difference (Outdoor ~ Indoor Unit) is 0 m.
3. Wiring cable size must comply with the applicable local and national codes.
And "Electric characteristics" should be considered for electrical work and design.
Especially the power cable and circuit breaker should be selected in accordance with that.
4. Power factor could vary less than $\pm 1\%$ according to the operating conditions.
5. Sound pressure level is measured on the rated condition in the anechoic rooms by ISO 3745 standard. Refer to the model specifications for nominal conditions. (Power source and Ambient temperature, etc)
Sound levels can be increased in accordance with installation and operating conditions. (Operating conditions include some functional condition like Static Pressure mode, air guide use, Room target temperature setting, etc and these functions are different in accordance with each model.)
Sound level will vary depending on a range of factors such as the construction (Acoustic absorption coefficient) of particular room in which the equipment is installed.
Sound values of combination model are calculated values based on sound results of independent models. Sound values can be increased owing to ambient or installation conditions during operation.

<Measurement Scene>

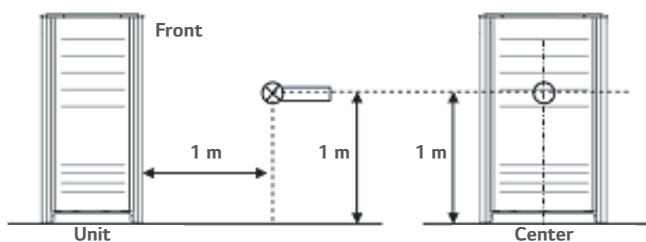

※ External appearance of unit could be different by each model.

6. Sound power level is measured on the rated condition in the semi-anechoic rooms by ISO 9614 standard.
7. Explanation of terms
 - EER : Energy Efficiency Ratio (Cooling)
 - Cooling COP (=EER) : Coefficient Of Performance (Cooling)
 - COP : Coefficient Of Performance (Heating)
 - Heating COP : Coefficient Of Performance (Heating)
8. This product contains Fluorinated greenhouse gas. (R410A, GWP (Global warming potential) = 2,087.5)

ARUN080LTE6 / ARUN100LTE6
ARUN120LTE6

[Unit : mm]

No.	Part Name	Description
1	Leakage test hole (Side)	Ø 22.2
2	Wire routing hole (Front)	2-Ø 30
3	Wire routing hole (Bottom)	2-Ø 22.2
4	Power cord routing hole (Front)	2-Ø 45
5	Power cord routing hole (Bottom)	2-Ø 50
6	Pipe routing hole (Front)	-
7	Pipe routing hole (Bottom)	-

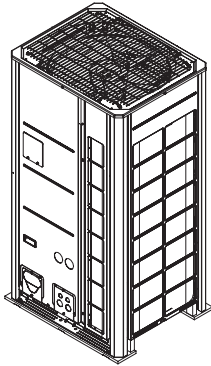

3D View

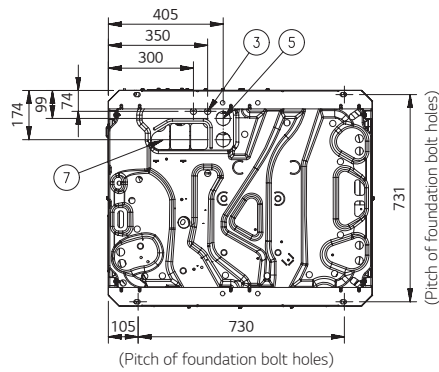
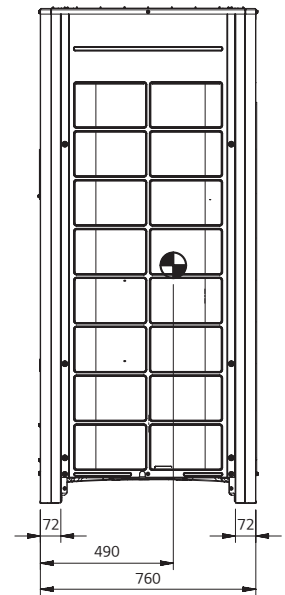
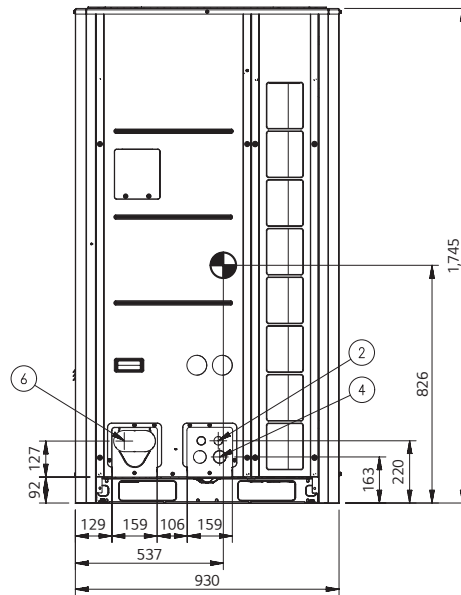
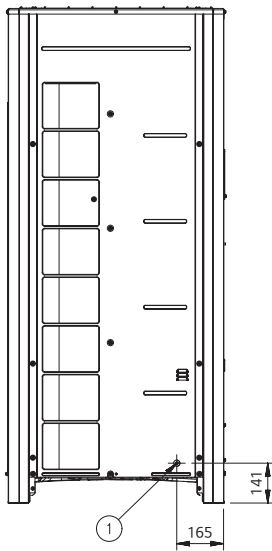
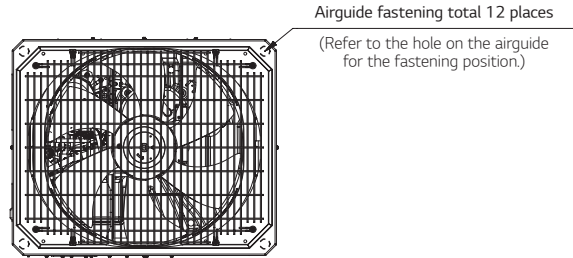

ARUN140LTE6 / ARUN160LTE6
 ARUN180LTE6 / ARUN200LTE6
 ARUN220LTE6 / ARUN240LTE6
 ARUN260LTE6

[Unit : mm]

No.	Part Name	Description
1	Leakage test hole (Side)	Ø 22.2
2	Wire routing hole (Front)	2-Ø 30
3	Wire routing hole (Bottom)	2-Ø 22.2
4	Power cord routing hole (Front)	2-Ø 45
5	Power cord routing hole (Bottom)	2-Ø 50
6	Pipe routing hole (Front)	-
7	Pipe routing hole (Bottom)	-

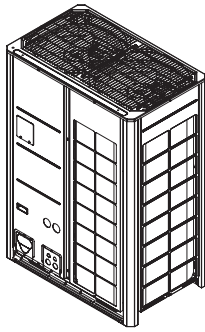

3D View

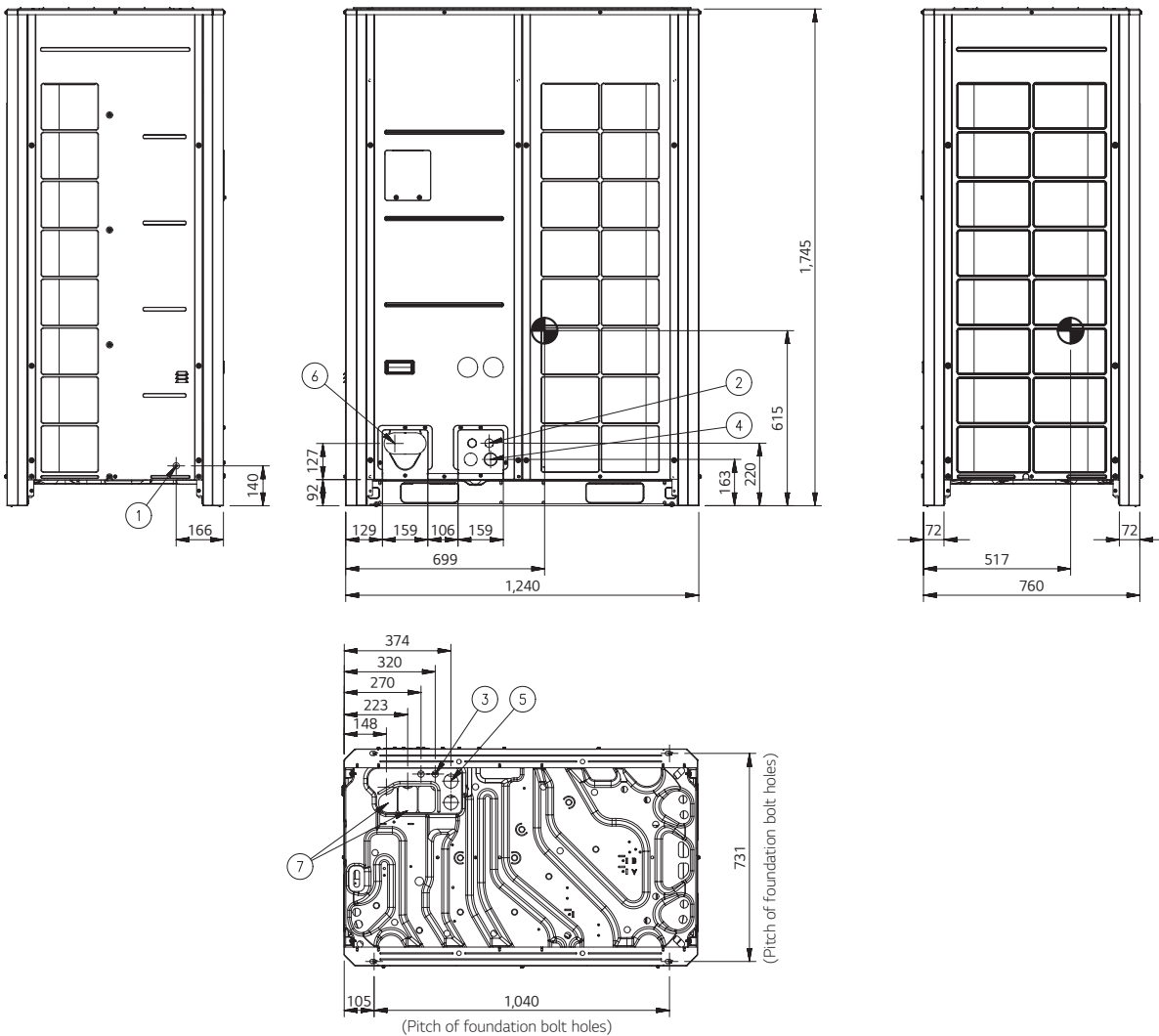
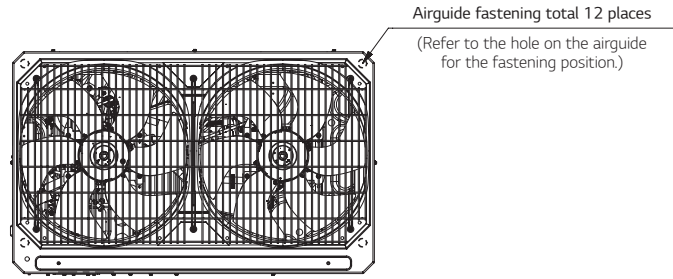

General Instruction

Wiring of Main Power Supply

- Bear in mind ambient conditions (ambient temperature, direct sunlight, rain liquid, etc.) when proceeding with the wiring and connections
- The wire size is the minimum value for metal conduit wiring. The power cord size should be 1 rank thicker taking into account the line voltage drops. Make sure the power-supply voltage does not drop more than 10%.
- Specific wiring requirements should adhere to the wiring regulations of the region.
- Power supply cords of parts of appliances for outdoor use should not be lighter than polychloroprene sheathed flexible cord (design 60245 IEC57).
- Don't install an individual switch or electrical outlet to disconnect each of indoor unit separately from the power supply.

Warning

- Make sure to use specified wires for connections so that no external force is imparted to terminal connections. If connections are not fixed firmly, it may cause heating or fire.
- Make sure to use the appropriate type of overcurrent protection switch. Note that generated overcurrent may include some amount of direct current.
- All Installation site must require attachment of an earth leakage breaker. If no earth leakage breaker is installed, it may cause an electric shock.
- Do not use anything other than breaker and fuse with correct capacity. Using fuse and wire or copper wire with too large capacity may cause a malfunction of unit or fire.

Schematic Diagram of Series Wiring

!! This System is representative Example.
 !! * : Actual combination of outdoor unit may be different by Product line-up of region or Product Type.

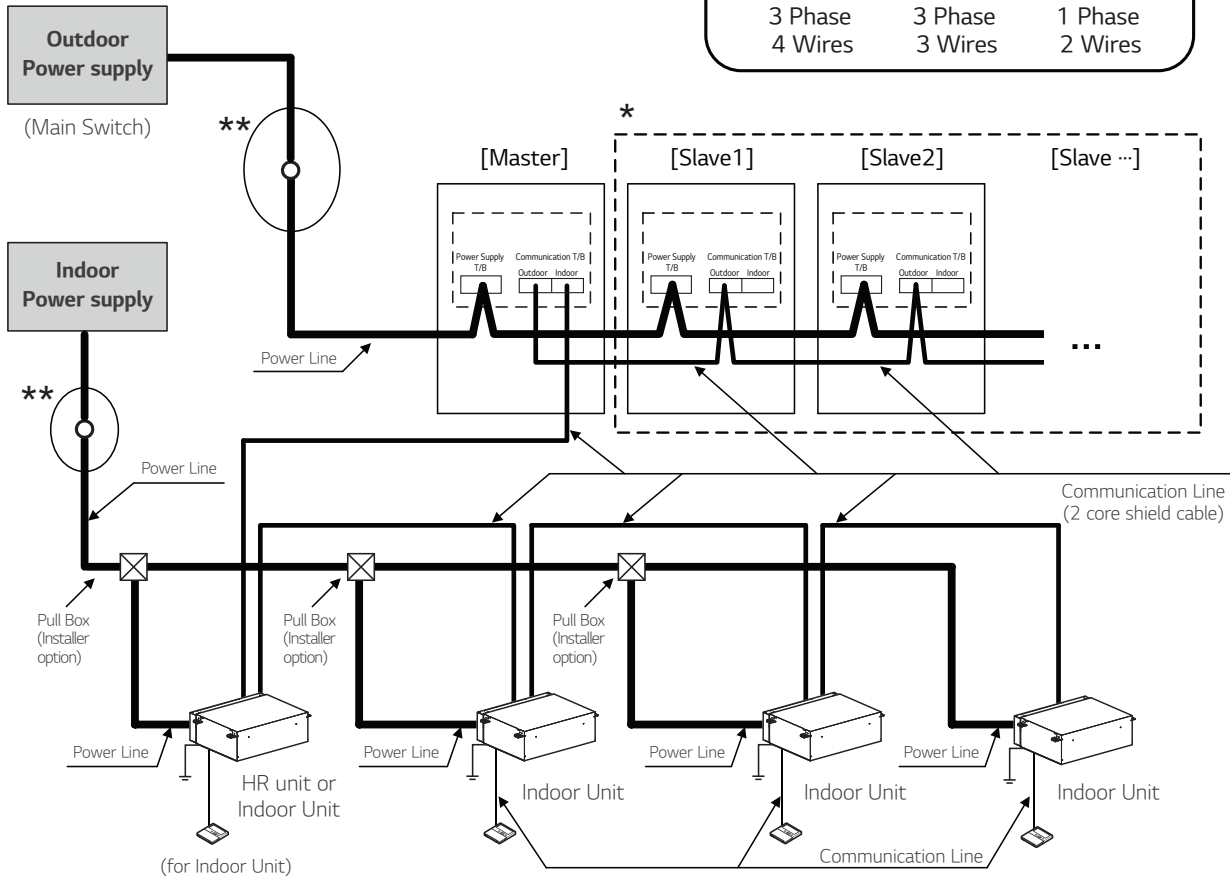
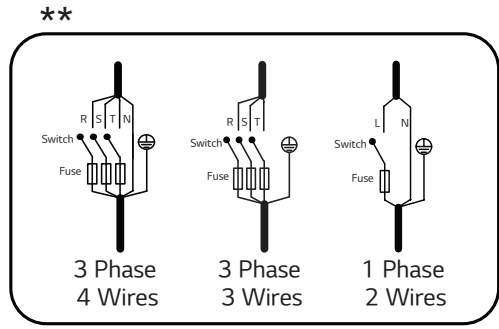

Connecting Power and communication cable

- Indoor Unit ground Lines are required for preventing electrical shock accident during current leakage, communication disorder by noise effect and motor current leakage (without connection to pipe).
- Don't install an individual switch or electrical outlet to disconnect each of indoor unit separately from the power supply
- If individual power supply is necessary for each indoor unit, MPM (Multi-tenant Power Module) should be applied at each indoor unit. (Optional Accessory)
- Install the main switch that can interrupt all the power sources in an integrated manner because this system consists of the equipment utilizing the multiple power sources.
- If there exists the possibility of reversed phase, lose phase, momentary blackout or the power goes on and off product is operating, attach a reversed phase protection circuit locally.
- Running the product in reversed phase may break the compressor and other parts.

⚠ Warning

- The First terminal block ampacity must be checked for single source series connection. The ampacity of First terminal block(of Master unit) must be over the total ampacity of connected outdoor units (Master and Slave units,ALL).

Otherwise, the First terminal block could be burnt out.

!! This System is representative Example.
 !! * : Actual combination of outdoor unit may be different by Product line-up of region or Product Type.

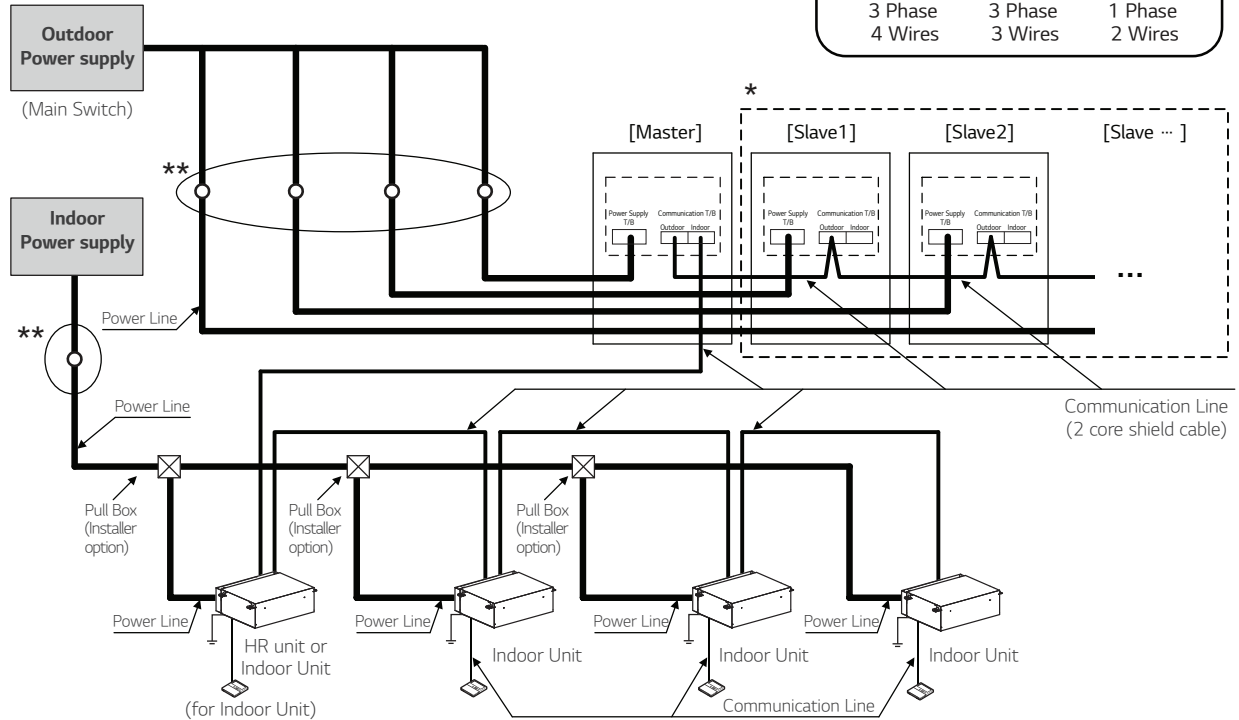
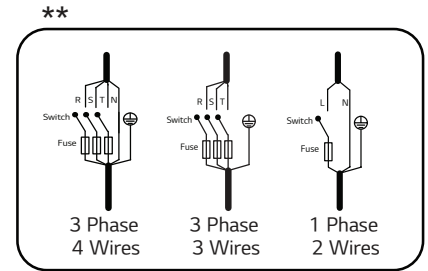

Connecting Power and communication cable

- Indoor Unit ground Lines are required for preventing electrical shock accident during current leakage, communication disorder by noise effect and motor current leakage (without connection to pipe).
- Don't install an individual switch or electrical outlet to disconnect each of indoor unit separately from the power supply. If individual power supply is necessary for each indoor unit, MPM (Multi-tenant Power Module) should be applied at each indoor unit. (Optional Accessory)
- Install the main switch that can interrupt all the power sources in an integrated manner because this system consists of the equipment utilizing the multiple power sources.
- If there exists the possibility of reversed phase, lose phase, momentary blackout or the power goes on and a product is operating, attach a reversed phase protection circuit locally
- Running the product in reversed phase may break the compressor and other parts.

⚠ Warning

When the total capacity is over than 68Hp, do not use single power source for connecting series units. The First terminal block could be burnt out.

Example Connection of Communication Cable

BUS Type

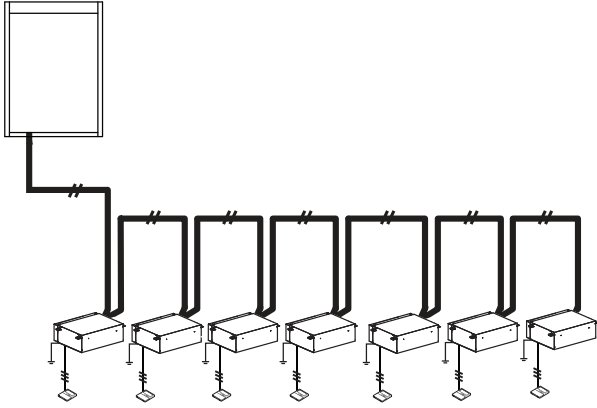

Connection of communication cable must be installed like this figure between indoor unit to outdoor unit.

STAR Type

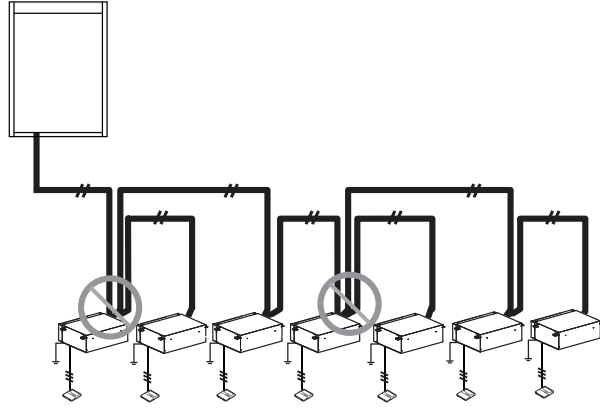

Abnormal operation can be caused by communication defect, when connection of communication cable is installed like below figure.



LG ELECTRONICS VIETNAM

Hanoi 35F, Keangnam Landmark 72, Pham Hung str., Nam Tu Liem Dist. – Tel: 024 3934 5151

Hochiminh 12F Sofic Tower, 10 Mai Chi Tho str., Thu Thiem, Thu Duc City – Tel: 028 3925 6886

Danang 9F, Indochina Building, 74 Bach Dang str. – Tel: 0236 3691 307

Nhatrang 7F, Nha Trang Building, 42 Le Thanh Phuong str. – Tel: 0258 3813 468

Halong Shophouse, Lot D2 – 06, Ha Long Marine Plaza, Bai Chay – Tel: 0203 3900 369

Hotline 1800 1503

www.lg.com/vn/business | www.partner.lge.com



LG HVAC Vietnam



LG Việt Nam

*For continual product development, LG reserves the right to change specifications or design without notice

***Note**

This product uses inverter technology, so it can generate harmonics. If local law or the Investor requires harmonic suppression at the construction site, please coordinate with the electrical design unit to take measures to suppress harmonics. Contact your supplier for more detailed information on the electrical characteristics of LG air conditioners.

