

37" CLASS (37.0" MEASURED DIAGONALLY)

37LD330H

32" CLASS (31.5" MEASURED DIAGONALLY)

32LD330H

LCD TV

LCD Commercial Widescreen

Pro:Centric™ Single Tuner™ HDTV
with Integrated Pro:Idiom®



 EcoSmart™
Dynamic Power Savings
Static Power Savings

 RoHS COMPLIANT

INTEGRATED Pro:Idiom

Pro:Centric SINGLE TUNER
(Java/Flash)

MPEG-2/MPEG-4 H.264 DECODING

DYNAMIC CONTRAST RATIO
60,000:1

MPI™ PORT

NATIVE DISPLAY RESOLUTION
1920 x 1080 Full HD (37" class)
1366 x 768 (32" class)

BUILT-IN ATSC/NTSC/QAM CLEAR TUNER

INVISIBLE SPEAKER SYSTEM
Hidden speaker grilles

LG'S EXCLUSIVE XD ENGINE®

USB 2.0 MEDIA HOST FOR PHOTOS AND MUSIC

USB CLONING

CLEAR VOICE II

NEW! STAND W/BUILT-IN SECURITY PLATE
(mounting hardware parts included)

SPLASH IMAGE ON START UP

NEW! REMOTE MANAGEMENT OF TELEVISION
SETTINGS USING Pro:Centric SERVER (PCS150R) OR
FREE-TO-GUEST MANAGEMENT APPLIANCE (FMA-LG 101)
(FMA management requires optional Z9 card)

REAL CINEMA™

2 HDMI™ INPUTS WITH HDCP
V.1.3 with deep color

2 YEAR LIMITED WARRANTY
(parts and labor)

**ENERGY
GUIDE**

The estimated annual energy cost determined in accordance with 16 CFR Part 305.5 for models 37LD330H and 32LD330H are \$18 and \$14 respectively.

"Your energy cost depends on your utility rates and use. The estimated cost is based on 11 cents per kWh and 5 hours of use per day. For more information, visit www.ftc.gov/energy."¹

¹FTC Television labeling rule (18 CFR Part 305, as added by 76 Fed. Reg. 1038 (Jan 6, 2011)).

LGsolutions.com

 **LG**
Life's Good



green LIFE'S GOOD...

WHEN IT'S GREEN.

LG is committed to improving product development, manufacturing and usage to meet the demand for environmentally friendlier products.

The LD330H series has technologies to reduce power consumption and in return increase **cost savings** per room. We've also placed limits on the amounts of harmful materials used in these televisions.

• EcoSmart

Dynamic Power Savings - Using built-in algorithms, the TV will automatically reduce the power consumption based on incoming video, while maximizing picture performance.

Static Power Savings - Picture brightness level can be set at the preferred power consumption level to reduce power and increase energy savings.

• RoHS Compliant

Meets directive on restriction of hazardous substances.

APPLICATION ACCESSORIES

Pro:Centric

Interactive Guestroom Experience

An industry leading Pay-Per-View (PPV) compatible television to include an embedded applications platform, LG's new LD330H series allows hoteliers to customize the in-room experience. Pro:Centric provides an easy way for the LD330H series to interface with interactive program guides, games and internet data feeds, as well as applications designed to connect guests to hotel services such as room service menus, spa services and golf course scheduling.

Electronic Program Guide

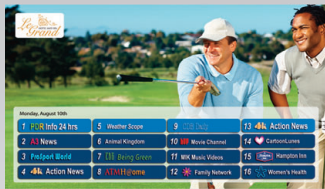

Pro:Centric PLATFORM*



* May require optional software, hardware, third party subscription service/contract, and customization at an additional cost.

Pro:Centric SYSTEM OVERVIEW (example for illustrative purpose only)

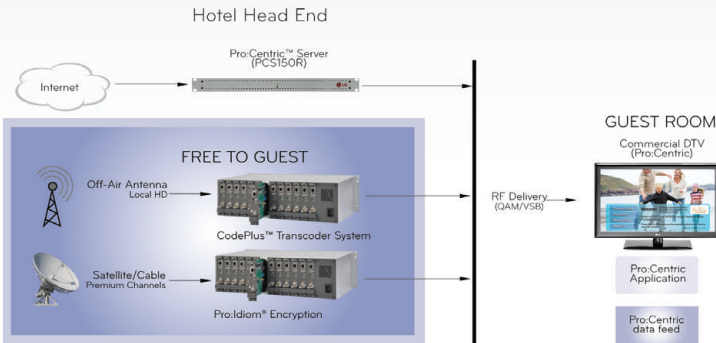

LG'S FREE-TO-GUEST COST EFFECTIVE SOLUTION

When using LG televisions in For Free-To-Guest hotel installations there are now two options for remote management of TV settings such as virtual channel mapping, cloning of installer menu settings, and other settings:

1. LG's Pro:Centric server (PCS150R)
2. b-LAN compatible with optional LMT7Z9 card, plus LG's Free-To-Guest Management System (FMA)

HOTEL COSTS FOR FREE-TO-GUEST CHANNEL MANAGEMENT

	Estimated Labor Costs	*MAP price	Total	Savings over other brand
Other brand	\$20 (est.) x 2 times per year (to update channels) x 100 rooms x 5 years		\$20,000	
LG Pro:Idiom TV with Pro:Centric Server		\$2,500	\$2,500	\$17,500
LG Pro:Idiom TV with b-LAN integration plus FMA & Z9 card		\$1,999 (\$49 Z9 card)	\$1,999 (\$2,048)	\$18,001

* MAP price subject to change.

FREE-TO-GUEST REMOTE MANAGEMENT DEVICES

PCS150R HEAD-END SYSTEM



Remote management functions also supported via the Pro:Centric server. The Pro:Centric Application software can be remotely added at a later date to deliver the benefits of LG's Applications features (Weather, EPG, Billboards...)

FMA-LG101 HEAD-END SYSTEM



Manages channel line-up changes, channel label changes, designates a startup channel, cloning of commercial installer menu settings, and can set the time/date, and broadcast that information to all the terminals on a regular basis. Also, enables Pro:Idiom tuning for Pro:Idiom encrypted content.

MPEG-4 TECHNOLOGY (Moving Picture Experts Group)

MPEG-4 decodes and delivers high-definition programming it receives via satellite. The advanced coding system is compatible with national and local HD channels, along with digital HD channels currently launched by satellite companies. LG built this technology into its LD330H series TVs to deliver pure HD without the need for an external box*.

* Certain functions, such as Pay-Per-View, may require a set-top box.

Pro:Idiom

DIGITAL RIGHTS MANAGEMENT SYSTEM

The Pro:Idiom system's high-quality security unlocks access to premium content availability to help assure rapid, broad deployment of HDTV and other high value digital content. Pro:Idiom has been designed specifically for industries that use premium HDTV content from cable, satellite or video on demand (VOD) services and as such, could result in lower costs, and reduced maintenance. This system is one of the leading DRM systems embraced by content providers for both of these key programming sources. By using this embedded approach, security is provided and helps eliminate the possibility of customers tampering with or removing needed components.

XD[®] ENGINE

SHARPER
BRIGHTER
CLEARER



Dramatization



Dramatization

Six distinct processes contribute to picture improvement. LG's XD Engine takes the low resolution of analog signals to near HD levels by improving brightness, contrast, detail and enhancing color as well as reducing signal noise.

invisible SPEAKER

SOUND IS HEARD, NOT SEEN

Enjoy a combination of smart technology and stylish design with the invisible speaker system custom tuned by audio expert Mr. Mark Levinson. This unique system provides a clean, polished look and an enhanced auditory experience by increasing the sweet spot and providing a wider sound field.



USB CLONING

USB cloning will allow for easy transfer of Commercial Installer Menu Settings from the "Master TV" to an unlimited number of same type televisions.

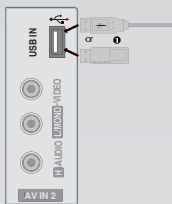

MOUNTING HOLES ON STAND FOR ATTACHMENT TO FURNITURE

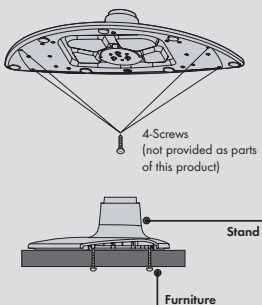

DIMENSIONS

37LD330H

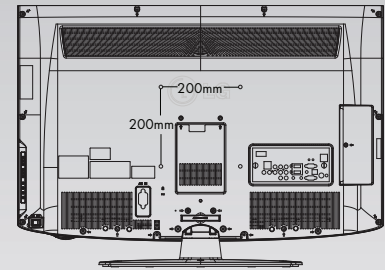
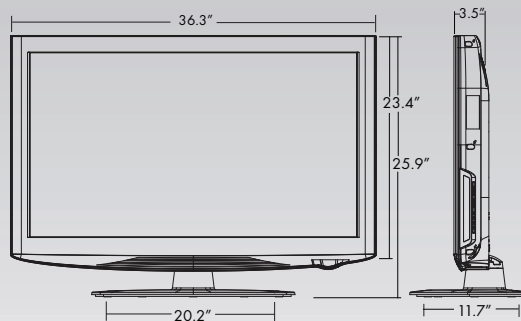

32LD330H

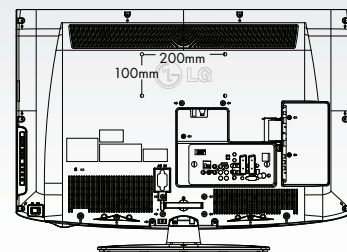
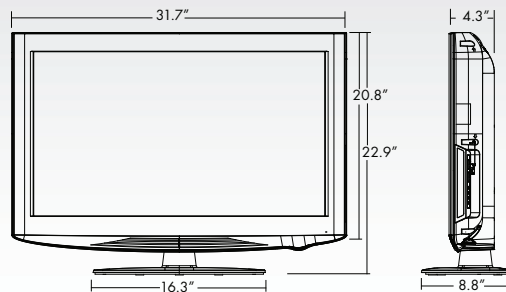

REAR JACK PANEL

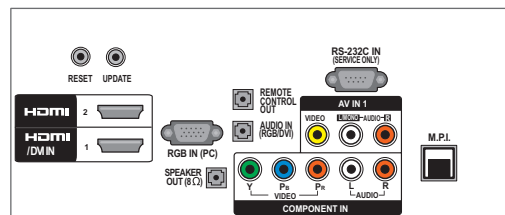

SIDE JACK PANEL

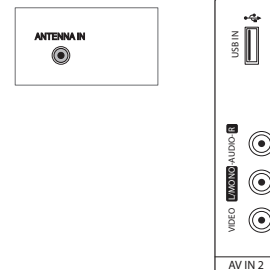

37LD330H

37" CLASS (37.0" MEASURED DIAGONALLY)

32LD330H

32" CLASS (31.5" MEASURED DIAGONALLY)

SPECIFICATIONS

LCD SPECIFICATION

Screen Size (Class)	37" class (37.0" measured diagonally) 32" class (31.5" measured diagonally)
Native Display Resolution	1920 x 1080 (37"), 1366 x 768 (32")
Dynamic Contrast Ratio	60,000:1
Viewing Angle	178°/178°
Color Reproduction	8 Bit
Response Time	4ms
Life Span (Typical)	60,000 hrs

BROADCASTING SYSTEM

Analog	Yes
ATSC/NTSC/Clear QAM	Yes

VIDEO

XD Engine	Yes
Video Codec	MPEG-2/4
Aspect Ratio	16:9
Aspect Ratio Correction	5 Modes
Just Scan 0% over scan	
HDMI/Component:	HD/DTV
Enhanced Noise Reduction (Video Noise Filter)	Yes, 3D NR/MPEG NR
Digital Comb Filter	Yes (3D)
Color Temperature Control	3 Modes (Medium, Warm, Cool)
Black Stretcher	Yes
24p Real Cinema	Yes
Cinema 3:2/2:2 Mode	Yes
Picture Reset	Yes
EZ Picture/PSM	Yes (6 mode)
xvYCC (richer color)	Yes
DTV Signal Strength Indicator	Yes
Video Reset/Initializing	Yes

AUDIO

Mono/Stereo/Dual (MTS/SAP)	Yes
Audio Output Power	10W x 2
Invisible Speaker System Details	1 Way 2 Speaker
Dolby Digital 5.1 Decoder	Yes
Surround System Type	Infinite Sound
Bass/Treble/Balance Controls	Yes
Clear Voice II	Yes
Auto Volume Leveler	Yes
EZ Sound Mode/SSM	5 Modes

SPECIAL FEATURES

Integrated Pro:Idiom	Yes
Pro:Centric Single Tuner	Yes
Backlight Control	Yes
USB Cloning	Yes
MPI Slot	Yes
T080p Source Input	
HDMI	60f/30f/24f
Component	60f/30f/29f
Auto Screen Adjust	Yes
Fresh White	Yes
Flashback (Previous Channel)	Yes
Quick Setup Guide	Yes
Parental Control w/W-Chip	Yes
Key Lock/Child Lock	Yes
Customizable Closed Caption/Sub-title	Yes

CONVENIENCE FEATURES

Language	English/Spanish/French/Korean
Alvin UI	Yes
Commercial Function Menu	Yes
Auto Tuning/Programming	Yes
Channel Add/Delete	Yes
Auto/Manual Clock	Yes
On/Off Timer	Yes
Sleep Timer	Yes

AUDIO/VIDEO INPUTS/OUTPUTS

RF In (Antenna/Cable)	1
L/R Audio/Composite Video In	1 (rear), 1 (side)
HD Component Video In (Y, Pb, Pr) + L/R Audio	1
HDMI/HDCP Input (V1.3 with Deep Color)	2 (1 port PC mode)
RGB In (D-Sub 15pin) - PC	1 (up to WXGA)
PC Audio Input	1
RS-232c In (Service Only)	1
USB 2.0 Input	1 (Side) Media Host (jpeg, mp3), Cloning, Service

Remote Control Port out	1
MPI Port	Yes

CABINET/ACCESSORIES

Cabinet Color	Glossy Black
Swivel Stand (degrees)	90°/90°
Stand w/Built-in Security Plate	Yes
Fire Retardant Cabinet Material	Yes
Kensington Security System Slot	Yes
Security Screws (TORX)	Yes (optional use)
VESA® Compliant (WxH)	200mm x 200mm, M6 screw (37") 200mm x 100mm, M4 screw (32")

Remote Control	Yes
Cloning Capable	USB input, opt. TLL-1100A

POWER

Voltage, Hz	100V - 240V, 50/60 Hz
Stand-by Mode	Less than 1W
Dynamic/Static Power Savings	Yes
Power Consumption (with Power Saving Modes disabled)	Max. 150 (32") 200 (37") Typ. 80 (32") 90 (37")
RoHS Compliant	Yes

DIMENSIONS & WEIGHT

TV without stand (WxHxD)	31.7" x 20.8" x 4.3" (32") 36.3" x 23.4" x 3.5" (37")
TV with stand (WxHxD)	31.7" x 22.9" x 8.8" (32") 36.3" x 25.9" x 11.7" (37")
Shipping Dimensions (WxHxD)	38.8" x 24.4" x 7.6" (32") 47.0" x 25.9" x 9.0" (37")

TV without stand weight	25.1 lbs (32") 29.0 lbs (37")
TV with stand weight	27.7 (32") 33.0 (37")

Shipping Weight	32.3 (32") 40.0 (37")
-----------------	--------------------------

SERVICE/LIMITED WARRANTY

UPC CODE	
37LD330H	7 19192 90350 0
32LD330H	7 19192 90351 7

LGsolutions.com

LG Electronics U.S.A., Inc.
HE B2B Division
2000 Millbrook Drive
Lincolnshire, IL 60069

Customer Service: 888.865.3026
www.LGsolutions.com/support

Contact your LG Regional Sales Representative:
Channel: 800.897.8871
Hospitality: 800.228.1236
E-mail: info@LGsolutions.com

SPEC_32_37LD330H_021204_PR



All screen images are simulated. Dimensions and weights are approximate. Design, features and specifications subject to change without notice.

© Copyright 2012 LG Electronics USA, Inc. All Rights Reserved. "LG Life's Good" is a registered trademark of LG Corp. XD Engine, Pro:Centric and EcoSmart are registered trademarks or trademarks of LG Electronics, Inc. Pro:Idiom is a registered trademark of Zenith Electronics Corp. SRS and the SRS symbol and TruSurround XT are trademarks or registered trademarks of SRS Labs, Inc. VESA is a trademark of Video Electronics Standards Association. ENERGY STAR is a registered trademark of the U.S. Environmental Protection Agency. All other product and brand names are trademarks or registered trademarks of their respective companies.

Printed in the USA. February 2012

