

ONE DISPLAY.  
BRILLIANTLY SIMPLE.

# ABSOLUTELY BREATHTAKING.

The LG Direct View LED Ultimate Business Display



## IN A NEW LIGHT

Due to the lowering price point and increased product availability, direct view LED is becoming the preferred choice for corporate lobbies, conference centers, auditoriums, sports arenas, houses of worship, and airports. Characterized by their ability to provide bright, sharp images, these impressive displays can captivate viewers with breath-taking realism, indoors or out.

---

**Leave it to LG to create a direct view LED display so easy to select and purchase that it could work for virtually any business.**

Available in various sizes and performance levels, the LG Direct View LED ultimate business display takes the guesswork out of configuring a display that's right for your business. From 2K to 8K resolutions with 16:9 screen sizes from 81" to a showstopping 325" (measured diagonally), this display comes with all the components you need to dynamically deliver your content on a jawdroppingly vibrant, magnificent screen.

# THE LG DIFFERENCE

## **Impressive direct view LED displays are only the beginning of this story.**

When creating this display, LG took everything into consideration. This fully-kitted display includes all of the components and an LG intelligent controller to make system operations a breeze. All SMD system components ship in custom-designed, wheeled flight cases so that everything arrives securely with no need for fork trucks or pallet jacks to bring the display inside.

## **A sophisticated controller and the LG webOS™ operating system deliver advanced multi-view options and simplified system integration.**

The LG webOS™ can execute several tasks to provide smooth content playback from connected base-band high-resolution video sources, the built-in media player, or video streaming decoder. The included LG controllers have 3.6GB of storage for applications and content. For added convenience, certain models have a remote control with an intuitive user interface puts system and image control in the palm of your hand.

### ***This display includes an advanced controller that gives users added features and system control.***

- Onscreen user-interface to simplify system control
- Automatic brightness adjustment based on ambient lighting (light sensor included)
- Onboard CMS (storage, scheduling, playback)
- Built-in AV-over-IP decoder can simultaneously display up to four 4K RTSP video streams
- Screen sharing on many models (Miracast® and WiDi Wireless Display)
- Remote control (adjust brightness, picture mode, CMS configurations, Multi-view settings, etc. on select models)

## **SuperSign® compatible.**

A comprehensive content management software solution simplifies content creation and distribution, saves service time, and enables efficient operations across locations.

## **Compatibility with popular AV control systems.**

Corporate meeting areas will appreciate how this display can seamlessly integrate with most professional AV control systems.

## **This display is backed by LG limited warranty coverage, on-site training, LG TotalCare Support and ConnectedCare® subscription.**

***Learn more on pages 30-31.***



# THE LG ULTIMATE BUSINESS DISPLAY THAT'S **RIGHT FOR YOU**

LG has simplified the selection process so you can simply select by **ENVIRONMENT** (indoor or outdoor), **RESOLUTION**, and **DISPLAY SIZE**.

**ENVIRONMENT.** The LG direct view LED ultimate business display comes in both indoor and outdoor options to make sure there is a solution that fits for your business needs. Ask your LG representative for more information about outdoor display options.

**RESOLUTION.** This display is available in 2K Full HD, 4K UHD and 8K XHD resolution options. If your needs call for a 32:9 display, LG offers several different 32:9 Ultra Stretch options that deliver twice the viewing area of their 16:9 counterparts.

**DISPLAY SIZE.** This resolution has the best resolutions at the most popular screen sizes, ranging from 81" to 325" at 16:9 aspect ratio and 147" up to 589" at 32:9 aspect ratio.

*The LG MAGNIT DVLED panels deliver content in stunning detail and depth.*

---

The LG MAGNIT panels comprise of a colorful mosaic of MicroLED chips that can deliver stunning images as the content creator intended. Vivid colors, breathtaking contrast, and ultra-fine detail combine to produce eye-catching images that immerse viewers and create a memorable experience. Bring your imagination to life with LG MAGNIT.

*The LG Value Series panels deliver amazing performance at an incredible price.*

---

The LG LSBB, LSBE and LSBF series panels provide flexibility, performance and affordability unparalleled in the Ultimate Business Display lineup.

*The LG UltraThin DVLED panels blend seamlessly into most environments.*

---

The LG Ultra Slim display features a slim 37.5mm deep cabinet that blends seamlessly virtually any environment. Pixel-pitch options of 1.5mm, 1.8mm, and 2.5mm are chosen to optimize viewing based on screen size and viewing distance.

*All-in-One Series Displays offer simple, fully-kitted solution.*

---

Available in two sizes - 136" and 163" in 16:9 aspect ratio.

# LG SIMPLIFIES CHOOSING THE RIGHT DIRECT VIEW LED DISPLAY

From dynamic video presentations, brand messaging and informational content, direct view LED displays can be deployed in many diverse applications. The products in this catalog aim to simplify the selection process by creating pre-configured complete displays to satisfy a broad range of use scenarios for the vast majority of businesses.

## SPEAKING DIRECT VIEW LED

Direct View LED displays differ from their LCD counterparts in many ways. Understanding these key specifications will help guide you through the selection process of choosing the LG display that's right for your needs.



## DIMENSIONS

The width, height, and diagonal length represent a display's total dimensions, which are shown in inches, feet, and millimeters. LG offers direct view LED displays in many sizes to meet the needs of your installation requirements.



**LED PACKAGE TYPE** Surface Mount Diode (SMD) pixels (a.k.a. 3-in-1 diodes) are composed of modularly packaged color diodes mounted directly on the PCB surface, hence the name. Chip on Board (COB), MicroLED pixels are mounted directly on the circuit board with multiple protective layers, allowing for durability impact ratings up to IK10.



**DIAGONAL** A subset of the display's dimensions, a screen's diagonal size is the length, in inches, from one corner of the display to the opposite diagonal corner.

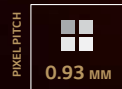

**PIXEL PITCH** The distance between the individual pixels from center to center defines the display's pixel-pitch. LG offers solutions in many sizes and pixel-pitches to help ensure that each display delivers optimal performance regardless of installation criteria.



**RESOLUTION | ASPECT RATIO** Resolution is defined by two numbers, the width and the height of the display measured in pixels. As an example, a 4K UHD display could have a resolution of 3840 x 2160. Aspect ratio directly compares the width of the display to its height. For example, a display with a resolution of 3840 x 2160 has a 16:9 aspect ratio.



**BRIGHTNESS** Measured in "Nits," brightness refers to the display's maximum potential brightness when set to 100% brightness while showing a full-white test pattern. The display can be set to any relative brightness less than this to best suit the space in which it is installed.



**MINIMUM RECOMMENDED VIEWING DISTANCE** The minimum distance LG recommends between the viewer and the screen to clearly decipher text legibility based on pixel pitch.



**ENVIRONMENT** Environmental conditions help define which direct view LED display will perform well in various locations. For example, one measure of durability for outdoor displays is Ingress Protection, with ratings for solid ingress (scaled from 0 to 6) and water ingress (scaled from 0 to 9)..



**PANEL ARRAY | SERVICE ACCESS** A DVLED display is comprised of an array of panels. Panel Array defines the number of panels within the array. Service Access tells whether the finished display can be serviced from the front, from the back or both when maintenance is required.



# TABLE OF CONTENTS

<b>2K FULLHD INDOOR SIZES</b>	<b>6-12</b>
2K FullHD 81" (0.9mm) .....	8
dual2K Ultra Stretch 147" (2 x 81") (0.9mm) .....	9
2K FullHD 108" (1.2mm) .....	10
dual2K Ultra Stretch 196" (2 x 108") (1.2mm) .....	11
2K FullHD 136" (1.5mm) .....	12
dual2K Ultra Stretch 245" (2 x 136") (1.5mm) .....	13
2K FullHD 163" (1.8mm) .....	14
dual2K Ultra Stretch 294" (2 x 163") (1.8mm) .....	15
2K FullHD 217" (2.5mm) .....	16
dual2K Ultra Stretch 393" (2 x 217") (2.5mm) .....	17
SIZE COMPARISON .....	18
<b>4K ULTRAHD INDOOR SIZES</b>	<b>14-19</b>
4K UltraHD 136" (0.9mm) .....	15
4K UltraHD 163" (0.9mm) .....	16
dual4K Ultra Stretch 294" (2 x 163") (0.9mm) .....	17
4K UltraHD 217" (1.2mm) .....	18
dual4k Ultra Stretch 393" (2 x 217") (1.2mm) .....	19
4K UltraHD 271" (1.5mm) .....	20
dual4K Ultra Stretch 490" (2 x 271") (1.5mm) .....	21
4K UltraHD 325" (1.8mm) .....	22
dual4K Ultra Stretch 589" (2 x 163") (1.8mm) .....	23
<b>8K XHD INDOOR SIZES</b>	<b>20-23</b>
8K XHD 325" (0.9mm) .....	22
8K XHD 271" (0.7mm) .....	23
<b>21:9 FORMAT SIZES</b>	<b>24-28</b>
FHD Teams 102" .....	26
FHD All-in-One 171" .....	27
FHD Teams 178" .....	28
CUSTOM WHEELED FLIGHT CASES .....	29
WARRANTY AND SERVICE BUNDLE .....	30
<b>ALL-IN-ONE DISPLAY SERIES</b>	<b>31-33</b>
MicroLED Expandable Boxed Set & DVLED Boxed Set .....	33



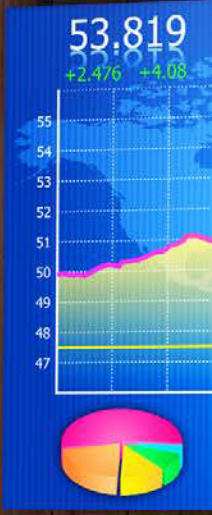



# 2K FULLHD SIZES

NOT ALL 2K DISPLAYS  
ARE CREATED EQUAL

*The LG direct view fine-pitch LED delivers 2K with breathtaking realism.*

With a total of ten display sizes from which to choose, there is a 2K option that will almost certainly suit your needs. Rest assured, however, that no matter which one you select, your audience will be captivated by the brilliance, high contrast ratio, and broad color spectrum of an LG LED display.

Choose from the variety of LG SMD display panels that blend seamlessly into virtually any environment or the LG MAGNIT MicroLED display panels with Deep Black Technology and impressive contrast ratios.

If your needs call for two displays, LG offers Dual2K Ultra Stretch Ultra Stretch configurations that can be mounted as one large display that provides a seamless, double-wide viewing experience or two separate displays that could be mounted separately to provide better coverage to large audiences.



2K FULLHD 81" (COB 0.9MM)



DUAL2K ULTRA STRETCH 147" (2 X 81") (COB 0.9MM)



## 2K FULLHD 81"

1920 x 1080 (16:9)

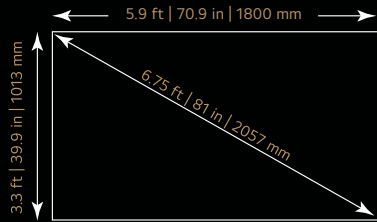

SKU	LSAB-F081C	LSAB-F081GV	LSBB-F081C
LED Package Type	COB		Single SMD
TAA	NO	TAA	NO
Pixel Pitch	0.94 mm		
Panel Array W x H (Panel Quantity)	3 x 3 (9 Panels)		
Max Brightness	600 nits	600 nits	600 nits
Max Power Consumption	540 Watts	540 Watts	1260 Watts
Min Viewing Distance	5-7 feet		
Service Access	Front & Rear		Front
webOS Version	webOS 4.1		webOS 4.0
Controller SKU	CSAD		CVBA



## dual2K <sup>ultra stretch</sup> 147" (2 X 81")

3840 x 1080 (32:9)



SKU	LSAB-G147C	LSAB-G147GV	LSBB-G147C
LED Package Type	COB		Single SMD
TAA	NO	TAA	NO
Pixel Pitch	0.94 mm		
Panel Array W x H (Panel Quantity)	6 x 3 (18 Panels)		
Max Brightness	600 nits	600 nits	600 nits
Max Power Consumption	1080 Watts	1080 Watts	2520 Watts
Min Viewing Distance	5-7 feet		
Service Access	Front & Rear		Front
webOS Version	webOS 4.1		webOS 4.0
Controller SKU	CSAD		CVBA

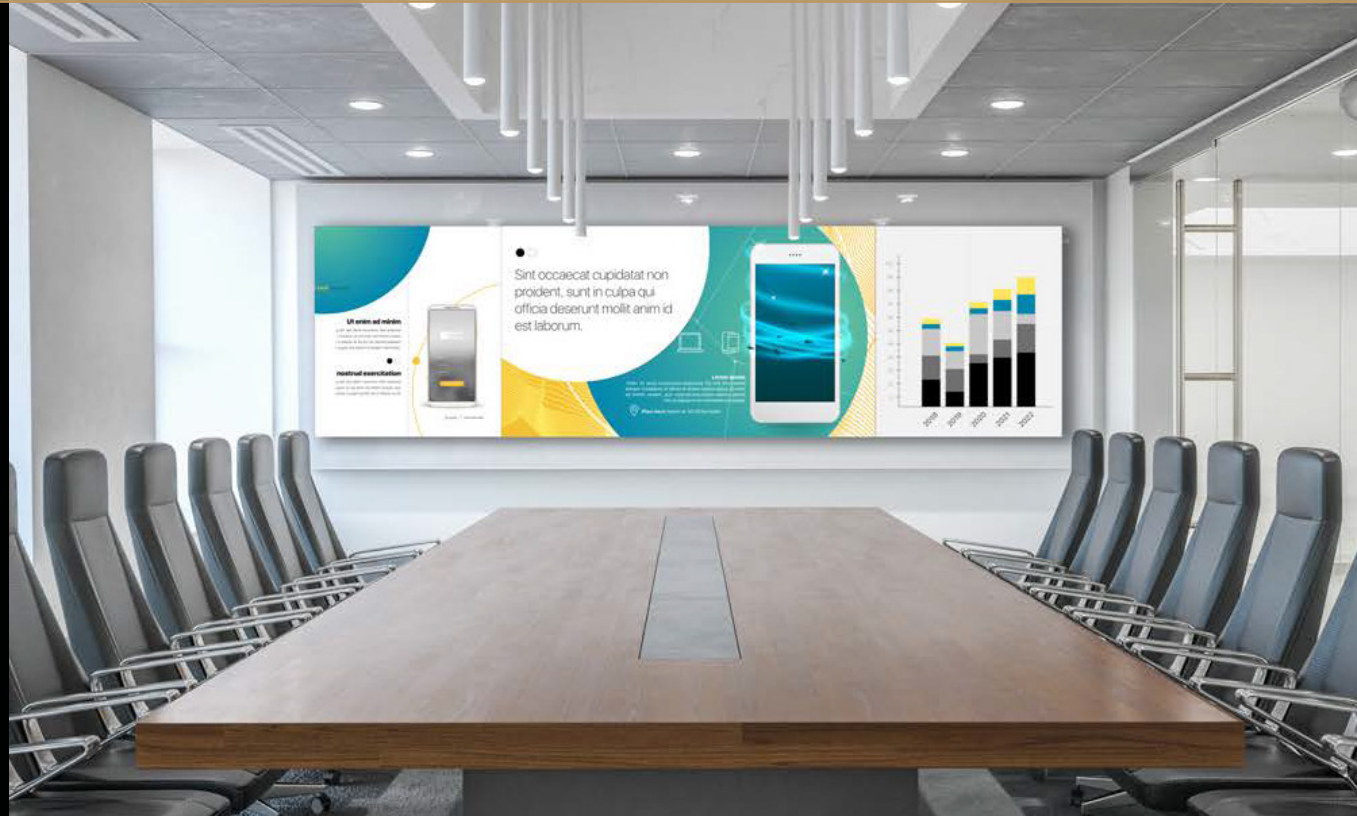



## 2K FULLHD 108"

1920 x 1080 (16:9)

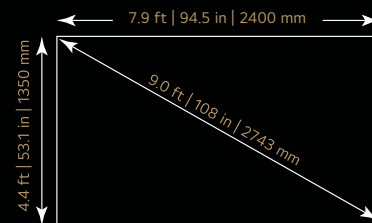

SKU	LSAB-F108GV	LSCB-F108C	LSBB-F108C	LSBF-F108GV
LED Package Type	COB	Single SMD		
TAA	TAA	No	TAA	
Pixel Pitch	1.25 mm			
Panel Array W x H (Panel Quantity)	4 x 4 (16 Panels)	4 x 4 (16 Panels)		2 x 2 (4 Panels)
Max Brightness	800 nits	800 nits	600 nits	600 nits
Max Power Consumption	960 Watts	2400 Watts	1920 Watts	2320 Watts
Min Viewing Distance	6-9 feet			
Service Access	Front & Rear	Front		
webOS Version	webOS 4.1	webOS 4.0		
Controller SKU	CSAD	CVCA	CVBA	



## dual2K<sup>ultra stretch</sup> 196" (2 X 108")

3840 x 1080 (32:9)

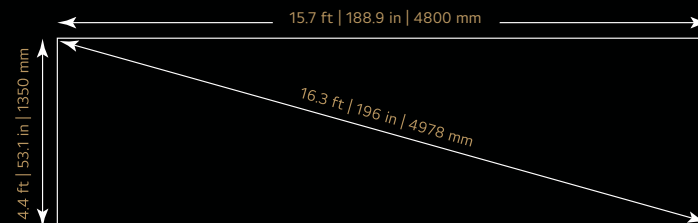

SKU	LSAB-G196GV	LSCB-G196C	LSBB-G196C	LSBF-G196GV
LED Package Type	COB	Single SMD		
TAA	TAA	NO	TAA	
Pixel Pitch	1.25 mm			
Panel Array W x H (Panel Quantity)	8 x 4 (32 Panels)			4 x 2 (8 Panels)
Max Brightness	800 nits	800 nits	600 nits	600 nits
Max Power Consumption	1920 Watts	4800 Watts	3840 Watts	4640 Watts
Min Viewing Distance	6-9 feet			
Service Access	Front and Rear	Front		
webOS Version	webOS 4.1	webOS 4.0		
Controller SKU	CSAD	CVCA	CVBA	



## 2K FULLHD 136"

1920 x 1080 (16:9)

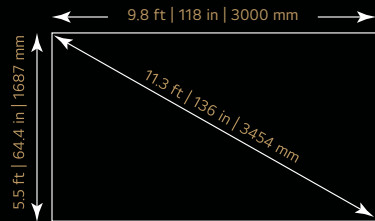

SKU	LSCB-F136C	LSBB-F136C	LSBE-F136GV
LED Package Type	Single SMD		
TAA	NO		TAA
Pixel Pitch	1.56 mm		
Panel Array W x H (Panel Quantity)	5 x 5 (25 Panels)		
Max Brightness	800 nits	600 nits	600 nits
Max Power Consumption	3750 Watts	3000 Watts	2675 Watts
Min Viewing Distance	8-11 feet		
Service Access	Front		
webOS Version	webOS 4.0		
Controller SKU	CVCA	CVBA	



## dual2K<sup>ultra stretch</sup> 245" (2 X 136")

3840 x 1080 (32:9)

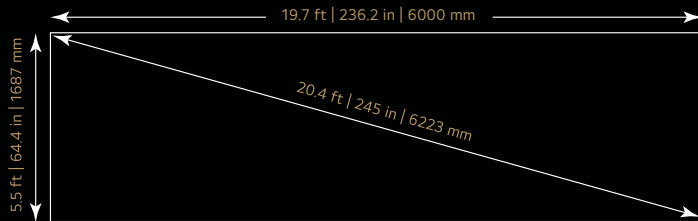

SKU	LSCB-G245C	LSBB-G245C	LSBE-G245GV
LED Package Type	Single SMD		
TAA	NO		TAA
Pixel Pitch	1.56 mm		
Panel Array W x H (Panel Quantity)	10 x 5 (50 Panels)		
Max Brightness	800 nits	600 nits	600 nits
Max Power Consumption	7500 Watts	6000 Watts	5350 Watts
Min Viewing Distance	8-11 feet		
Service Access	Front		
webOS Version	webOS 4.0		
Controller SKU	CVCA	CVBA	







## 2K FULLHD 163"

1920 x 1080 (16:9)

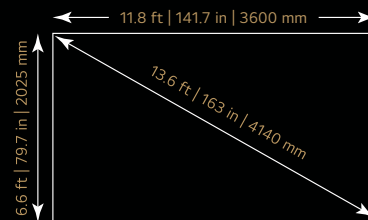

SKU	LSCB-F163C	LSBB-F163C	LSBF-F163GV
LED Package Type	Single SMD		
TAA	No		TAA
Pixel Pitch	1.88 mm		
Panel Array W x H (Panel Quantity)	6 x 6 (36 Panels)		3 x 3 (9 Panels)
Max Brightness	800 nits	600 nits	600 nits
Max Power Consumption	5400 Watts	4320 Watts	4590 Watts
Min Viewing Distance	9-13 feet		
Service Access	Front		
webOS Version	webOS 4.0		
Controller SKU	CVCA	CVBA	



## dual2K <sup>ultra stretch</sup> 294" (2 X 163")

3840 x 1080 (32:9)

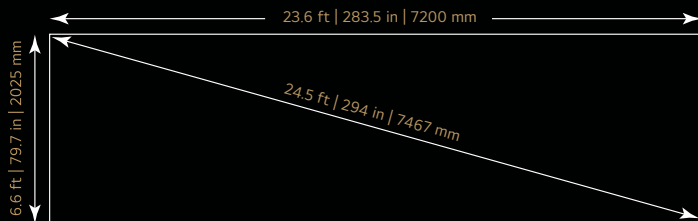

SKU	LSCB-G294C	LSBB-G294C	LSBF-G294GV
LED Package Type	Single SMD		
TAA	NO		TAA
Pixel Pitch	1.88 mm		
Panel Array W x H (Panel Quantity)	12 x 6 (72 Panels)		6 x 3 (18 Panels)
Max Brightness	800 nits	600 nits	600 nits
Max Power Consumption	10800 Watts	8640 Watts	9180 Watts
Min Viewing Distance	9-13 feet		
Service Access	Front		
webOS Version	webOS 4.0		
Controller SKU	CVCA	CVBA	



## 2K FULLHD 217"

1920 x 1080 (16:9)

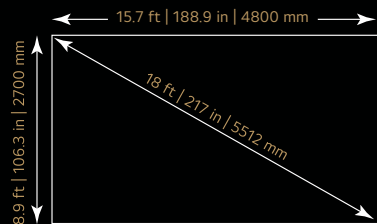

SKU	LSCB-F217C	LSBF-F217GV
LED Package Type	Single SMD	
TAA	No	TAA
Pixel Pitch	2.50 mm	
Panel Array W x H (Panel Quantity)	8 x 8 (64 Panels)	4 x 4 (16 Panels)
Max Brightness	800 nits	600 nits
Max Power Consumption	6400 Watts	7360 Watts
Min Viewing Distance	13-18 feet	
Service Access	Front	
webOS Version	webOS 4.0	
Controller SKU	CVCA	CVBA



## dual2K<sup>ultra stretch</sup> 393" (2 X 217")

3840 x 1080 (32:9)

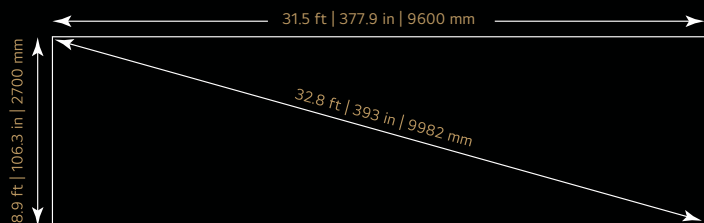

SKU	LSCB-G393C	LSBF-G393GV
LED Package Type	Single SMD	
TAA	NO	TAA
Pixel Pitch	2.50 mm	
Panel Array W x H (Panel Quantity)	16 x 8 (128 Panels)	8 x 4 (32 Panels)
Max Brightness	800 nits	600 nits
Max Power Consumption	12800 Watts	14720 Watts
Min Viewing Distance	13-18 feet	
Service Access	Front	
webOS Version	webOS 4.0	
Controller SKU	CVCA	CVBA



# LG ULTIMATE BUSINESS DISPLAY

## SCREEN SIZES

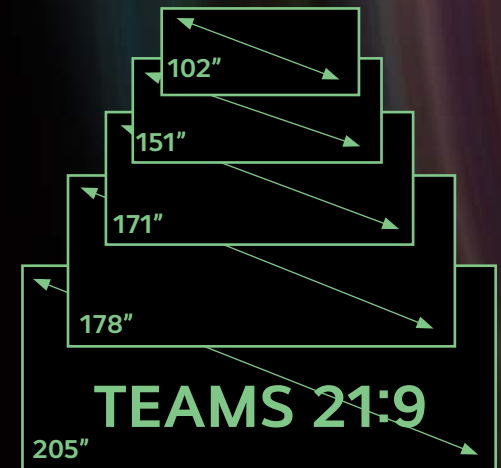
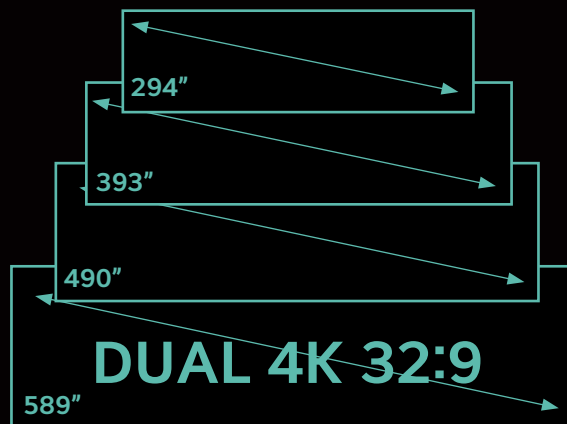
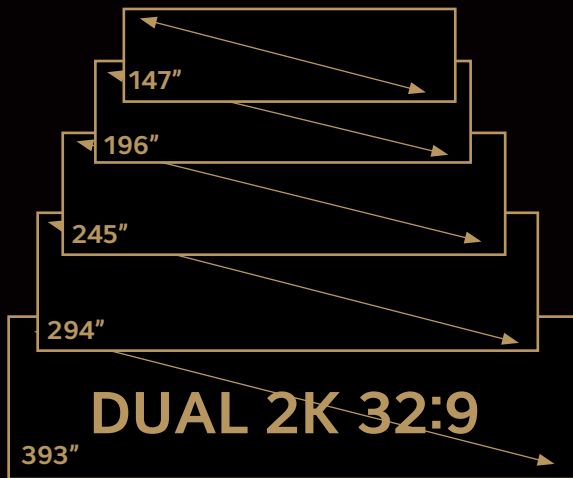
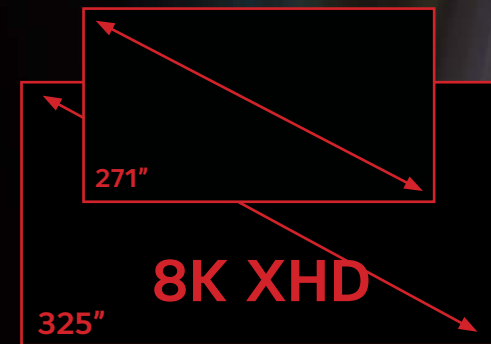
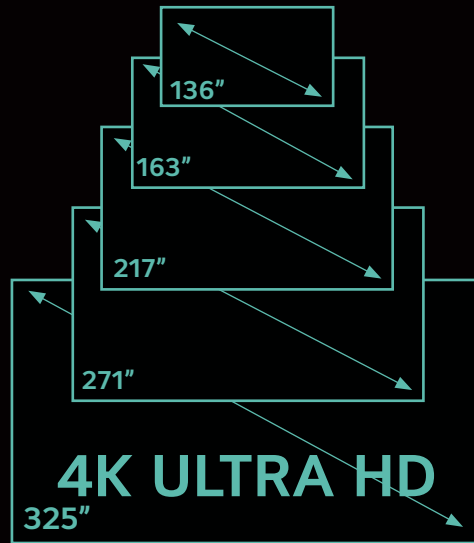
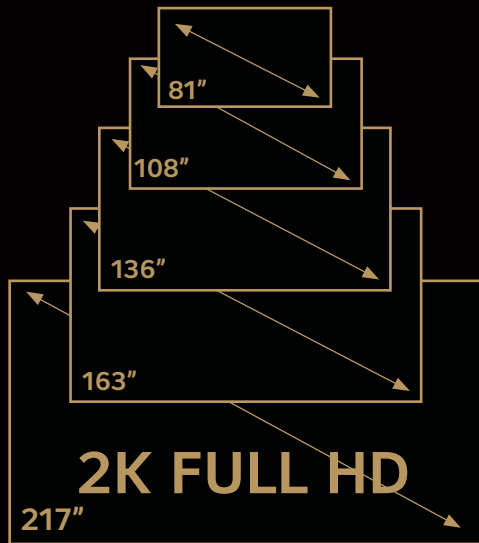





TEAM & NAME	P	W	D	L	PFS	FORM
Team 1	10	10	0	0	0	1000000
Team 2	10	10	0	0	0	1000000
Team 3	10	10	0	0	0	1000000
Team 4	10	10	0	0	0	1000000
Team 5	10	10	0	0	0	1000000
Team 6	10	10	0	0	0	1000000
Team 7	10	10	0	0	0	1000000
Team 8	10	10	0	0	0	1000000
Team 9	10	10	0	0	0	1000000
Team 10	10	10	0	0	0	1000000
Team 11	10	10	0	0	0	1000000
Team 12	10	10	0	0	0	1000000
Team 13	10	10	0	0	0	1000000
Team 14	10	10	0	0	0	1000000
Team 15	10	10	0	0	0	1000000
Team 16	10	10	0	0	0	1000000
Team 17	10	10	0	0	0	1000000
Team 18	10	10	0	0	0	1000000
Team 19	10	10	0	0	0	1000000
Team 20	10	10	0	0	0	1000000

Laps 3/4  
Current: 0:29.31  
Best: 4:48.06  
Target: 4:50.00  
Sector: -1.91

Lap R 4:48





DUAL4K ULTRA STRETCH 589" (2 X 325")  
(SMD 1.8MM)

# 4K ULTRAHD SIZES

## 4K DISPLAY SIZES THAT CHALLENGE CONVENTION

The LG 4K direct view fine-pitch direct view LED sizes bring home the WOW factor.

With a total of ten display sizes from which to choose, there is a 4K option that will almost certainly suit your needs. Rest assured, however, that no matter which one you select, your audience will be captivated by the brilliance, high contrast ratio, and broad color spectrum of an LG LED display.

Choose from the variety of LG SMD display panels that blend seamlessly into virtually any environment or the LG MAGNIT<sup>®</sup> MicroLED display panels with Deep Black Technology and impressive contrast ratios.

If your needs call for two displays, LG offers Dual4K Ultra Stretch Ultra Stretch configurations that can be mounted as one large display that provides a seamless, double-wide viewing experience or two separate displays that could be mounted separately to provide better coverage to large audiences.

### 4K Ultra HD 136"

3840 x 2160 (16:9)

SKU	LSAB-U136GV
LED Package Type	COB
TAA	TAA
Pixel Pitch	0.7 mm
Panel Array W x H (Panel Quantity)	5 x 5 (25 Panels)
Max Brightness	500 nits
Max Power Consumption	1500 Watts
Min Viewing Distance	4-5 feet
Service Access	Front and Rear
webOS Version	webOS 4.1
Controller SKU	CSAD



## 4K ULTRAHD 163"

3840 x 2160 (16:9)

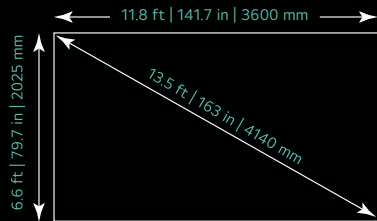

SKU	LSAB-U163GV	LSAB-U163C	LSBB-U163C
LED Package Type	COB		Single SMD
TAA	TAA	NO	
Pixel Pitch	0.94 mm		
Panel Array W x H (Panel Quantity)	6 x 6 (36 Panels)		
Max Brightness	600 nits	600 nits	600 nits
Max Power Consumption	2160 Watts	2160 Watts	5040 Watts
Min Viewing Distance	5-7 feet		
Service Access	Front and Rear		Front
webOS Version	webOS 4.1		webOS 4.0
Controller SKU	CSAD		CVBA



## dual4K<sup>ultra stretch</sup> 294" (2 X 163")

7680 x 2160 (32:9)

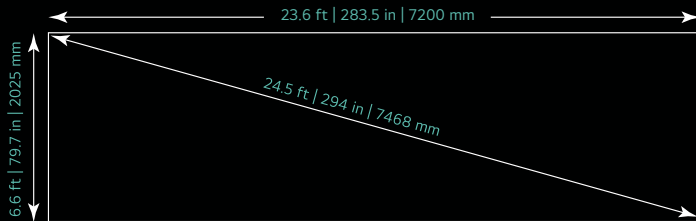

SKU	LSAB-V294C	LSAB-V294GV	LSBB-V294C
LED Package Type	COB		Single SMD
TAA	NO	TAA	NO
Pixel Pitch	0.94 mm		
Panel Array W x H (Panel Quantity)	12 x 6 (72 Panels)		
Max Brightness	600 nits	600 nits	600 nits
Max Power Consumption	4320 Watts	4320 Watts	10080 Watts
Min Viewing Distance	5-7 feet		
Service Access	Front and Rear		Front
webOS Version	webOS 4.1		webOS 4.0
Controller SKU	CSAD		CVBA







### 4K ULTRAHD 217"

3840 x 2160 (16:9)

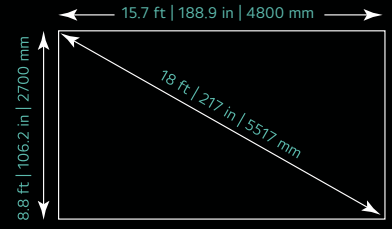

SKU	LSAB-U217GV	LSCB-U217C	LSBB-U217C	LSBF-U217GV
LED Package Type	COB	Single SMD		
TAA	TAA	No	TAA	
Pixel Pitch	1.25 mm			
Panel Array W x H (Panel Quantity)	8 x 8 (64 Panels)	8 x 8 (64 Panels)		4 x 4 (16 Panels)
Max Brightness	800 nits	800 nits	600 nits	600 nits
Max Power Consumption	3840 Watts	9600 Watts	7680 Watts	9280 Watts
Min Viewing Distance	6-9 feet			
Service Access	Front and Rear	Front		
webOS Version	webOS 4.1	webOS 4.0		
Controller SKU	CSAD	CVCA	CVBA	



### dual4K<sup>ultra stretch</sup> 393" (2 X 163")

7680 x 2160 (32:9)

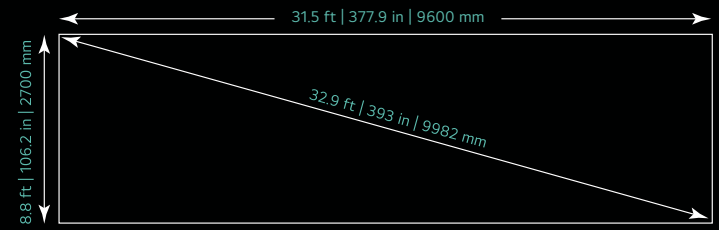

SKU	LSAB-V393GV	LSCB-V393C	LSBB-V393C	LSBF-V393GV
LED Package Type	COB	Single SMD		
TAA	TAA	NO	TAA	
Pixel Pitch	1.25 mm			
Panel Array W x H (Panel Quantity)	16 x 8 (128 Panels)			8 x 4 (32 Panels)
Max Brightness	800 nits	800 nits	600 nits	600 nits
Max Power Consumption	7680 Watts	19200 Watts	15360 Watts	18560 Watts
Min Viewing Distance	6-9 feet			
Service Access	Front and Rear	Front		
webOS Version	webOS 4.1	webOS 4.0		
Controller SKU	CSAD	CVCA	CVBA	



## 4K ULTRAHD 271"

3840 x 2160 (16:9)

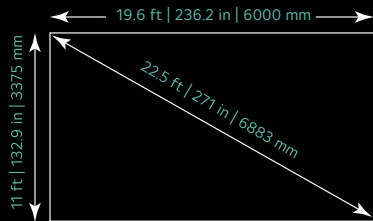

SKU	LSCB-U271C	LSBB-U271C	LSBF-U271GV
LED Package Type	Single SMD		
TAA	NO		TAA
Pixel Pitch	1.56 mm		
Panel Array W x H (Panel Quantity)	10 x 10 (100 Panels)		5 x 5 (25 Panels)
Max Brightness	800 nits	600 nits	600 nits
Max Power Consumption	15000 Watts	12000 Watts	13250 Watts
Min Viewing Distance	8-11 feet		
Service Access	Front		
webOS Version	webOS 4.0		
Controller SKU	CVCA	CVBA	



## dual4K<sup>ultra stretch</sup> 490" (2 X 271")

7680 x 2160 (32:9)

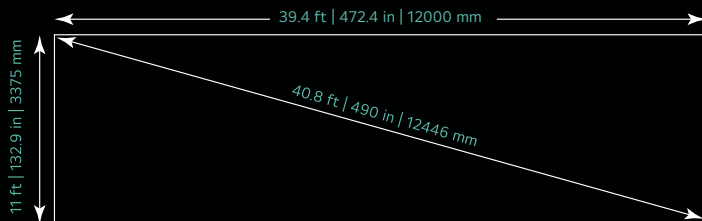

SKU	LSCB-V490C	LSBB-V490C	LSBF-V490GV
LED Package Type	Single SMD		
TAA	NO		TAA
Pixel Pitch	1.56 mm		
Panel Array W x H (Panel Quantity)	20 x 10 (200 Panels)		10 x 5 (50 Panels)
Max Brightness	800 nits	600 nits	600 nits
Max Power Consumption	30000 Watts	24000 Watts	26500 Watts
Min Viewing Distance	8-11 feet		
Service Access	Front		
webOS Version	webOS 4.0		
Controller SKU	CVCA	CVBA	

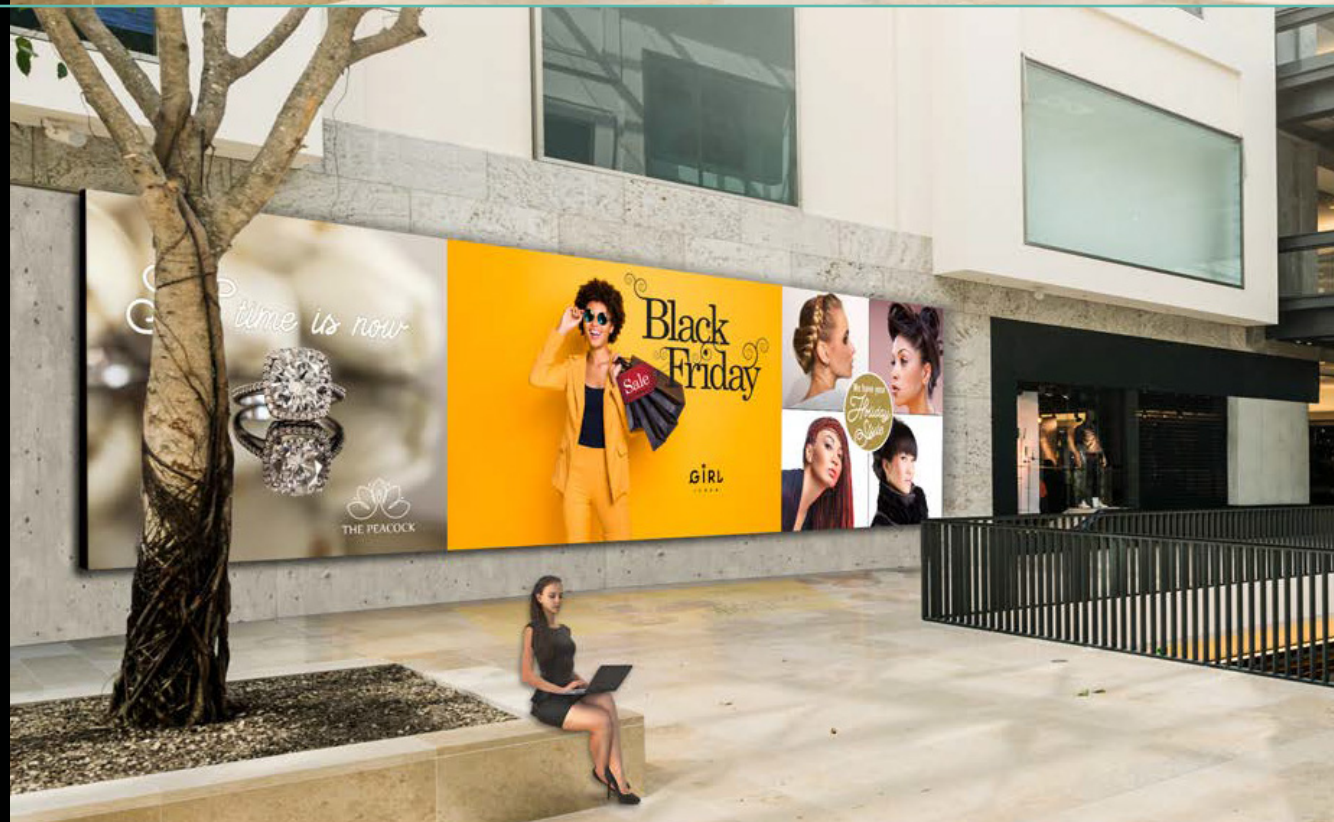





## 4K ULTRAHD 325"

3840 x 2160 (16:9)

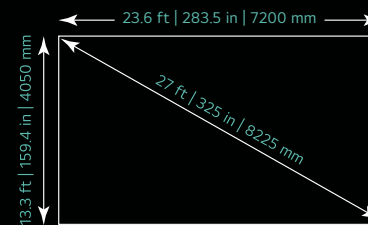

SKU	LSCB-U325C	LSBB-U325C
LED Package Type	Single SMD	
TAA	NO	NO
Pixel Pitch	1.88 mm	
Panel Array W x H (Panel Quantity)	12 x 12 (144 Panels)	
Max Brightness	800 nits	600 nits
Max Power Consumption	21600 Watts	17280 Watts
Min Viewing Distance	9-13 feet	
Service Access	Front	
webOS Version	webOS 4.0	
Controller SKU	CVCA	CVBA



## dual4K<sup>ultra stretch</sup> 589" (2 X 325")

7680 x 2160 (32:9)

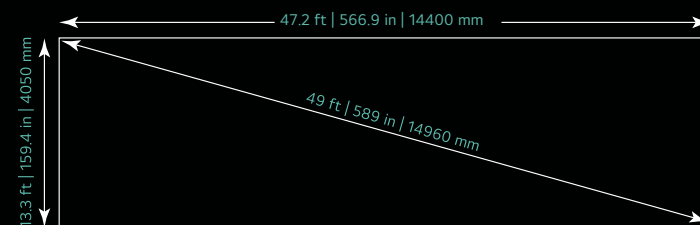

SKU	LSCB-V589C	LSBF-V589GV	LSBB-V589C
LED Package Type	Single SMD		
TAA	NO	TAA	NO
Pixel Pitch	1.88 mm		
Panel Array W x H (Panel Quantity)	24x12 (288 Panels)	12 x 6 (72 Panels)	24 x 12 (288 Panels)
Max Brightness	800 nit	600 nits	600 nits
Max Power Consumption	43200 Watts	36720 Watts	34560 Watts
Min Viewing Distance	9-13 feet		
Service Access	Front		
webOS Version	webOS 4.0		
Controller SKU	CVCA	CVBA	



8K XHD 325" (0.9MM)





# 8K MAGNIT

## THE UNCOMPROMISED DIRECT VIEW LED DISPLAY

*The LG MAGNIT LED 8K ultimate business display delivers "LARGER THAN LIFE" images in stunning detail.*

The LG MAGNIT is the perfect choice for businesses looking to create a "larger than life" atmosphere, thanks to the incredible impact of an 8K display with a massive 325" screen. The LG MAGNIT panels feature a pixel-pitch of just 0.93mm, the LG Deep Black Technology, and an impressive contrast ratio of 40,000:1 (@10 lux). Add in the power of an Alpha 7 processor and the LG HDR10 Pro2, and you'll see images as the content creator intended, with vivid colors, breathtaking contrast, and ultra-fine detail.

Installing an ultimate business display with the LG MAGNIT panels on your corporate campus will create a lasting impression on clients and employees.

**8K XHD 325"**  
7680 x 4320 (16:9)

SKU	LSAB-X325C	LSAB-X325GV
LED Package	COB	
TAA	NO	TAA
Pixel Pitch	0.94 mm	
Panel Array W x H (Panel Quantity)	12 x 12 (144 Panels)	12 x 12 (144 Panels) 7680 x 4320
Max Brightness	600 nits	600 nits
Max Power Consumption	8640 Watts	8640 Watts
Min Viewing Distance	5-7 feet	
Service Access	Front and Rear	
webOS Version	webOS 4.1	
Controller SKU	CSAD	

**8K XHD 271"**  
7680 x 4320 (16:9)

SKU	LSAB-X271GV
LED Package	COB
TAA	TAA
Pixel Pitch	0.7 mm
Panel Array W x H (Panel Quantity)	10 x 10 (100 Panels)
Max Brightness	500 nits
Max Power Consumption	6000 Watts
Min Viewing Distance	4-5 feet
Service Access	Front and Rear
webOS Version	webOS 4.1
Controller SKU	CSAD



**ALPHA 7 INTELLIGENT PROCESSOR  
OPTIMIZES IMAGE QUALITY**

The AI-Powered a7 processor recognizes and analyzes the original content and optimizes image clarity and sharpness. It also works with an image sensor to optimize the display brightness level to changing ambient light conditions.

**DEEP BLACK TECHNOLOGY  
DELIVERS AMAZING CONTRAST  
AND VIVID COLORS**

MAGNIT display panels apply the LG full black coating technology to deliver deeper black levels than conventional package LED displays. This advancement can reveal enhanced color reproduction and more precise detail, thanks to an impressive contrast ratio of up to 40,000:1 @10 lux.







IMAGINE WATCHING YOUR FAVORITE  
MOVIE OR SPORTING EVENT IN  
8K MAGNIFICENCE  
ON A MASSIVE  
**325"**  
**SCREEN!**



VIVID COLOR EXPRESSION  
POWERED BY HDR10 AND  
ENHANCED BY THE LG  
HDR10 PRO<sup>2</sup>

The LG HDR10 Pro<sup>2</sup> adds enhanced dynamic tone mapping to deliver a color spectrum of over one billion color possibilities.

---

WIDE 160° HORIZONTAL AND VERTICAL VIEWING ANGLES  
GIVE EVERYONE THE "BEST SEAT IN THE HOUSE."

Wide 160° horizontal and vertical viewing angles minimize off-axis viewing color distortions and ensure that viewers will see an immersive image virtually anywhere they sit.

RUGGED DESIGN FOR ADDED PEACE OF MIND

Several coated film layers help protect the LED chips from dust, static electricity, or physical impact. This rugged design also reduces glare and fingerprints.

CRESTRON COMPATIBLE AND ADVANCED CONTROLLER MODULE.

The LG MAGNIT is Certified Crestron Connected® and is compatible with various professional AV control systems to provide virtually seamless integration and network-based control, making it easier to set up and run meetings. It also features a 4K UHD LED Controller Module, remote control, video scaling, 3.6GB memory, and Wi-Fi for screen sharing.

1:15 PM

## LG Meeting Room

### AGENDA

Introduction to Office Meeting Mode

### NOTE

15:00 - 16:00 Introduction to the Office Meeting Mode App

16:00 - 17:00 Office Meeting Mode Demonstration







# 21:9 UltraWide® DIRECT VIEW LED

LG 21:9 ULTRAWIDE™ DIRECT VIEW LED ULTIMATE BUSINESS DISPLAY SHOWCASES YOUR CONTENT AND YOUR TEAM DURING MEETINGS

With both MicroLED and SMD versions available, LG offers six different sizes with over a dozen SKU variants to maximize budget or performance. These displays provide an immersive viewing experience with the wider viewing area than a 16:9 display. This display is particularly well-suited for the Microsoft Teams™ Front Row experience.

## 2K FHD Teams 102"

2560 x 1080 (21:9)

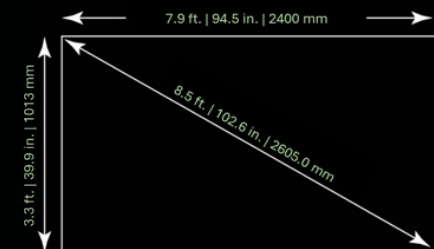

SKU	LSAB-T102GV	LSAB-TEAM102	LSBB-TEAM102
TAA	TAA	NO	
LED Package	COB		Single SMD
Pixel Pitch	0.94 mm		
Panel Array W x H (Panel Quantity)	4 x 3 (12 Panels)		
Max Brightness	600 nits		
Max Power Consumption	720 Watts	720 Watts	1680 Watts
Min Viewing Distance	5-7 feet		
Service Access	Front and Rear		Front
webOS Version	webOS 4.1		webOS 4.0
Controller SKU	CSAD		CVBA





## 2K FHD Teams 151"

2880 x 1080 (21:9)

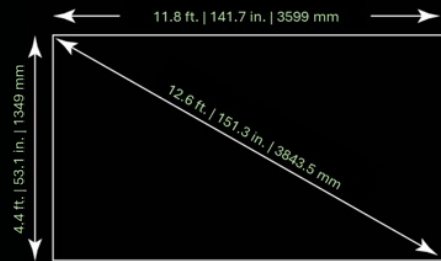

SKU	LSAB-T151GV	LSCB-TEAM151	LSBB-TEAM151	LSBF-T151GV
TAA	TAA	NO		TAA
LED Package	COB	Single SMD		
Pixel Pitch	1.25 mm			
Panel Array W x H (Panel Quantity)	6 x 4 (24 Panels)		3 x 2 (6 Panels)	
Max Brightness	800 nits		600 nits	
Max Power Consumption	1440 Watts	3600 Watts	2800 Watts	3480 Watts
Min Viewing Distance	6-9 feet			
Service Access	Front and Rear	Front		
webOS Version	webOS 4.1	webOS 4.0		
Controller SKU	CSAD	CVCA	CVBA	



## 5K UW5K Teams 178"

5376 x 2160 (21:9)

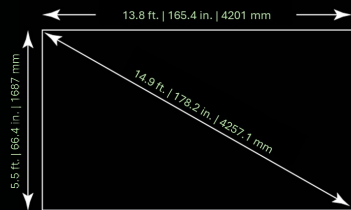

SKU	LSAB-T178GV
TAA	TAA
LED Package	COB
Pixel Pitch	0.7 mm
Panel Array W x H (Panel Quantity)	7 x 5 (35 Panels)
Max Brightness	500 nits
Max Power Consumption	2100 Watts
Min Viewing Distance	4-5 feet
Service Access	Front and Rear
webOS Version	webOS 4.1
Controller SKU	CSAD







## 2K FHD Teams 178"

2688 x 1080 (21:9)

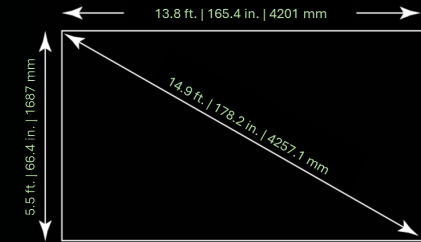

SKU	LSCB-TEAM178	LSBB-TEAM178	LSBF-T178GV
TAA	NO		TAA
LED Package	Single SMD		
Pixel Pitch	1.56 mm		
Panel Array W x H (Panel Quantity)	7 x 5 (35 Panels)		
Max Brightness	800 nits	600 nits	
Max Power Consumption	5250 Watts	4200 Watts	3735 Watts
Min Viewing Distance	8-11 feet		
Service Access	Front		
webOS Version	webOS 4.0		
Controller SKU	CVCA	CVBA	



## 2K FHD Teams 205"

2560 x 1080 (21:9)

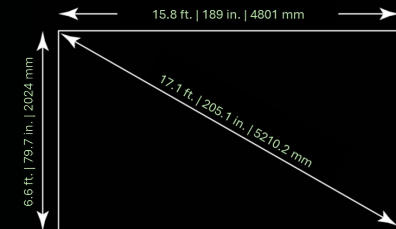

SKU	LSCB-TEAM205	LSBB-TEAM205	LSBF-T205GV
TAA	NO		TAA
LED Package	Single SMD		
Pixel Pitch	1.88 mm		
Panel Array W x H (Panel Quantity)	8 x 6 (48 Panels)		4 x 3 (12 Panels)
Max Brightness	800 nits	600 nits	
Max Power Consumption	7200 Watts	5760 Watts	6120 Watts
Min Viewing Distance	9-13 feet		
Service Access	Front		
webOS Version	webOS 4.0		
Controller SKU	CVCA	CVBA	

MAKING A COMPELLING CASE  
FOR A **COMPELLING**  
**DISPLAY**

While some may say **CUSTOM WHEELED FLIGHT CASES** are overkill, LG believes they make perfect sense. After all, the ultimate business display deserves premium treatment. All of the Ultimate Business Displays with SMD pixel technology ship in protective flight cases that feature custom packaging designed to maximize the chances that your system arrives without issues.. LG even considered each case's exterior, using customized badging that reflects the quality of the system contained within.





# WARRANTY AND SERVICE

DESIGNED TO KEEP YOUR  
SYSTEM RUNNING SMOOTHLY

This display is backed by LG limited warranty coverage, on-site training, LG TotalCare Support and ConnectedCare subscription.

- LG limited warranty coverage lasts for three years, with the option of increasing up to 5 years.
- LG on-site installation support by LG authorized professionals is included up to three days with the option to purchase more.
- LG annual TotalCare health checks for 3 years are included with the option to purchase up to 5 years with 2 visits per year.
- LG ConnectedCare system surveillance software subscription is provided for three years with the option to extend the license term.

## YOUR BUNDLE SHIPS COMPLETE TO SIMPLIFY SYSTEM SETUP.

Each bundle ships with the required LG components. We also include 5% ADDITIONAL SPARE PARTS, including modules, receiving cards, power supplies, and HUB boards. We also include a service tool to make installation and maintenance a breeze.





LG







# All-in-One Display Series

LG OFFERS AN EVEN SIMPLER WAY TO PURCHASE A DIRECT VIEW LED SCREEN. OUR ALL-IN-ONE SERIES SHIPS IN DIFFERENT VARIETIES THAT ARE ALL EASY TO ORDER, SHIP AND INSTALL.

The LG Boxed Set variant of our All-in-One Series comes with the following product and service highlights:

#### *Key Differentiators from the Ultimate Business Display*

- Built-in Speaker
- Built-in DVLED Controller
- Faster & Simpler Installation
- Ships in Single Wheeled Box

#### *Hardware:*

- 7% Spare Modules for LABA
- 5% Spare Modules for LAAA
- Spare boards and parts
- 4K LG Controller

#### *Features:*

- Screen Sharing (Miracast/WiDi)
- LG webOS User Interface
- 3.6GB Flash Storage

#### *Accessories:*

- Basic Wall Mount Kit Included\*
- Trim Kits Included
- Custom Wheeled Box

#### *Warranty*

- 3 Year Limited Included
- Up to 2 Additional Years with ExtendedCare Purchase

#### *TotalCare Health Checks:*

- 3 Years Included

#### *ConnectedCare Subscription:*

- 3 Years Included

#### *On-Site Field Support:*

- 1 Day Included for FHD systems
- 2 Days Included for UHD systems

\*Basic Wall Mount and Trim Kit are included in All-in-One systems. Additional mount and trim components are needed if Display Stacking/Expansion is used.



## MicroLED Expandable Boxed Set

136" (16.9) and 163" (16.9)

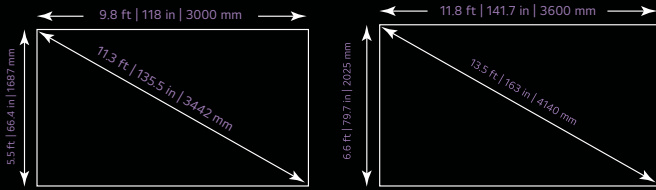

SKU	LAAA-F136GV	LAAA-U136GV	LAAA-U163GV
Size	136"	136"	163"
Resolution	1920 x 1080	3840 x 2160	3840 x 2160
TAA	TAA		
LED Package	COB		
Pixel Pitch	1.56 mm	0.78 mm	0.94 mm
Panel Array W x H (Panel Quantity)	5 x 1 (5 Panels)		
Max Brightness	500 nits		
Max Power Consumption	1050 Watts	1300 Watts	1450 Watts
Min Viewing Distance	8-11 feet	4-5 feet	5-7 feet
Service Access	Front		
webOS Version	webOS 4.1		
Controller SKU	Embedded		
Expandable	Expandable		



## DVLED Boxed Set

136" (16.9)

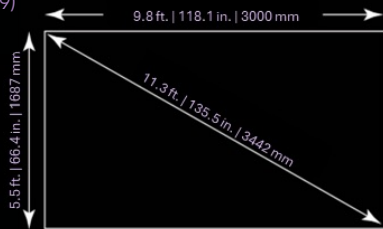

SKU	LAAA-F136GV
Size	136"
Resolution	1920 x 1080
TAA	TAA
LED Package	SMD
Pixel Pitch	1.58 mm
Panel Array W x H (Panel Quantity)	5 Columns of 5 Panels (Columns are Pre-assembled)
Max Brightness	500 nits
Max Power Consumption	1600 Watts
Min Viewing Distance	8-11 feet
Service Access	Front or Rear
webOS Version	webOS 4.1
Controller SKU	Embedded
Expandable	Single Only





1 Based on the LG conventional LED Signage

2 HDR10 Pro is the LG HDR solution for processing HDR signal by using enhanced dynamic tone mapping.

© Copyright 2024 ©LG Electronics USA, Inc. All rights reserved. LG and the LG logo are registered trademarks of LG Corp. All other trademarks are the property of their respective owners. Prices, promotions, and availability may vary by dealer. The information contained herein is subject to change without notice. All screen images are simulated. All screen sizes are measured diagonally.  
CAT\_DVLED\_UltimateBusinessDisplay\_0724\_17.0A

