



# STB-3500

(webOS 2.0)

## HD Commercial Interface Set-top Box

---

# Commercial Mode Setup Guide

Interactive Pro:Centric® •  
Functionality

RF or IP Content Delivery •

### EXPERIENCED INSTALLER

EZ-Manager Wizard  
pages 17 – 26

Custom Master STB Setup  
pages 42 – 44

Cloning Procedures  
pages 45 – 51

**Note:** Screen examples and procedural text in Revisions G and later of this document correspond to the webOS 2.0 operating system, which is available with CPU v4.10.50 and later software. Please refer to earlier revisions of this document for sample screens and text pertaining to webOS 1.0.

For Customer Support/Service, please call:

**1-888-865-3026**

The latest product information and documentation is available online at:

**www.lg.com/us/commercial**

MODEL and SERIAL NUMBER

The model and serial numbers of this STB are located on the back of the cabinet. For future reference, LG suggests that you record those numbers here:

Model No. \_\_\_\_\_ Serial No. \_\_\_\_\_



**WARNING:**

TO REDUCE THE RISK OF ELECTRIC SHOCK DO NOT REMOVE COVER (OR BACK). NO USER-SERVICEABLE PARTS INSIDE. REFER TO QUALIFIED SERVICE PERSONNEL.



The lightning flash with arrowhead symbol, within an equilateral triangle, is intended to alert the user to the presence of uninsulated "dangerous voltage" within the product's enclosure that may be of sufficient magnitude to constitute a risk of electric shock to persons.



The exclamation point within an equilateral triangle is intended to alert the user to the presence of important operating and maintenance (servicing) instructions in the literature accompanying the appliance.

**WARNING:**

TO PREVENT FIRE OR SHOCK HAZARDS, DO NOT EXPOSE THIS PRODUCT TO RAIN OR MOISTURE.

**WARNING:**

This product contains chemicals known to the State of California to cause cancer and birth defects or other reproductive harm. **Wash hands after handling.**

**NOTE TO CABLE/TV INSTALLER:**

This reminder is provided to call the cable TV system installer's attention to Article 820-40 of the National Electrical Code (U.S.A.). The code provides guidelines for proper grounding and, in particular, specifies that the cable ground shall be connected to the grounding system of the building, as close to the point of the cable entry as practical.

**REGULATORY INFORMATION:**

This equipment has been tested and found to comply with the limits for a Class B digital device, pursuant to Part 15 of the FCC Rules. These limits are designed to provide reasonable protection against harmful interference when the equipment is operated in a residential installation. This equipment generates, uses and can radiate radio frequency energy and, if not installed and used in accordance with the instruction manual, may cause harmful interference to radio communications. However, there is no guarantee that interference will not occur in a particular installation. If this equipment does cause harmful interference to radio or television reception, which can be determined by turning the equipment off and on, the user is encouraged to try to correct the interference by one or more of the following measures:

- Reorient or relocate the receiving antenna.
- Increase the separation between the equipment and receiver.
- Connect the equipment to an outlet on a circuit different from that to which the receiver is connected.
- Consult the dealer or an experienced radio/TV technician for help.

**CAUTION:**

Do not attempt to modify this product in any way without written authorization from LG Electronics U.S.A., Inc. Unauthorized modification could void the user's authority to operate this product.

**COMPLIANCE:**

The responsible party for this product's compliance is: LG Electronics U.S.A., Inc.  
1000 Sylvan Avenue, Englewood Cliffs, NJ 07632, USA • Phone: 1-201-816-2000

Marketed and Distributed in the United States by LG Electronics U.S.A., Inc.  
1000 Sylvan Avenue, Englewood Cliffs, NJ 07632

# IMPORTANT SAFETY INSTRUCTIONS

1. Read these instructions.
2. Keep these instructions.
3. Heed all warnings.
4. Follow all instructions.
5. Do not use this apparatus near water.
6. Clean only with dry cloth.
7. Do not block any ventilation openings. Install in accordance with the manufacturer's instructions.
8. Do not install near any heat sources, such as radiators, heat registers, stoves, or other apparatus (including amplifiers) that produce heat.
9. Do not defeat the safety purpose of the polarized or grounding-type plug. A polarized plug has two blades with one wider than the other. A grounding-type plug has two blades and a third grounding prong. The wide blade or the third prong are provided for your safety. If the provided plug does not fit into your outlet, consult an electrician for replacement of the obsolete outlet.
10. Protect the power cord from being walked on or pinched, particularly at plugs, convenience receptacles, and the point where it exits from the apparatus.
11. Only use attachments/accessories specified by the manufacturer.
12. Use only with the cart, stand, tripod, bracket, or table specified by the manufacturer or sold with the apparatus. When a cart is used, use caution when moving the cart/apparatus combination in order to avoid injury from tip-over.



13. Refer all servicing to qualified service personnel. Servicing is required when the apparatus has been damaged in any way, such as power-supply cord or plug is damaged, liquid has been spilled or objects have fallen into the apparatus, the apparatus has been exposed to rain or moisture, does not operate normally, or has been dropped.
14. Never touch this apparatus or antenna during a thunder or lightning storm.
15. When mounting an STB on the wall, make sure that none of the electrical cabling bears any of the weight of the STB. Install in accordance with the manufacturer's instructions.

## 16. Power Cord

**Caution: Check the STB specifications in the Owner's Manual to determine power requirements.**

Periodically examine the cord of your appliance, and if its appearance indicates damage or deterioration, unplug it, discontinue use of the appliance, and have the cord replaced with an exact replacement part by an authorized servicer. Protect the power cord from physical or mechanical abuse, such as twisting, kinking, or pinching or being closed in a door or walked upon. Pay particular attention to plugs, wall outlets, and the point where the cord exits the appliance.

Do not use a damaged or loose power cord. Be sure to grasp the plug when unplugging the power cord. Do not pull on the power cord to unplug the STB.

Do not stick metal objects or any other conductive material into the power cord. Do not touch the end of the power cord while it is plugged in.

## 17. Overloading

Do not connect too many appliances to the same AC power outlet as this could result in fire or electric shock. Do not overload wall outlets. Overloaded wall outlets, loose or damaged wall outlets, extension cords, frayed power cords, or damaged or cracked wire insulation are dangerous. Any of these conditions could result in fire or electric shock.

## 18. Outdoor Use/Wet Location



**Warning: To reduce the risk of fire or electrical shock, do not expose this product to rain, moisture or other liquids.**

Do not touch the STB with wet hands. Do not install this product near flammable objects such as gasoline or candles or expose the STB to direct air conditioning.

Do not expose to dripping or splashing and do not place objects filled with liquids, such as vases, cups, etc., on or over the apparatus (e.g., on shelves above the unit).

## 19. Grounding

(Except for devices that are not grounded) Ensure that you connect the earth ground wire to prevent possible electric shock (i.e., an STB with a three-prong grounded AC plug must be connected to a three-prong grounded AC outlet). If grounding methods are not possible, have a qualified electrician install a separate circuit breaker. Do not try to ground the unit by connecting it to telephone wires, lightning rods, or gas pipes.

## 20. Disconnect Device

The power plug is the disconnecting device. The power plug must remain readily accessible.

As long as this unit is connected to the AC wall outlet, it is not disconnected from the AC power source even if the unit is turned off.

(Continued on next page)

# IMPORTANT SAFETY INSTRUCTIONS

(Continued from previous page)

## 21. Outdoor Antenna Grounding

If an outside antenna or cable system is connected to the product, follow the precautions below.

An outdoor antenna system should not be located in the vicinity of overhead power lines or other electric light or power circuits or where it can come into contact with such power lines or circuits as death or serious injury can occur.

Be sure the antenna system is grounded so as to provide some protection against voltage surges and built-up static charges.

Article 810 of the National Electrical Code (NEC) in the U.S.A. provides information with respect to proper grounding of the mast and supporting structure, grounding of the lead-in wire to an antenna-discharge unit, size of grounding conductors, location of antenna-discharge unit, connection to grounding electrodes, and requirements for the grounding electrode.

### Antenna Grounding According to NEC, ANSI/NFPA 70

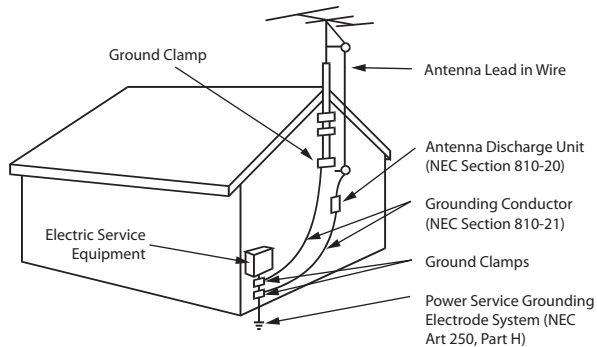

## 22. Cleaning

When cleaning, unplug the power cord and wipe gently with a soft cloth to prevent scratching. Do not spray water or other liquids directly on the STB as electric shock may occur. Do not clean with chemicals such as alcohol, thinners or benzene.

## 23. Transporting Product

Make sure the STB is turned Off and unplugged and that all cables have been removed. Do not press against or put stress on the STB.

## 24. Ventilation

Install the STB where there is proper ventilation. Do not install in a confined space such as a bookcase. Do not cover the STB with cloth or other materials (e.g., plastic) while it is plugged in. Do not install in excessively dusty places.

25. If you smell smoke or other odors coming from the STB or hear strange sounds, unplug the power cord, and contact an authorized service center.

26. Keep the product away from direct sunlight.

27. Do not install this product on a wall if it could be exposed to oil or oil mist. This may damage the product and cause it to fall.

28. Do not allow an impact shock or any objects to fall into the product.

29. Do not touch the ventilation openings, as they may become hot while the STB is operating. This does not affect the performance of the product or cause defects in the product.

30. Do not use high voltage electrical equipment near the STB (e.g., a bug zapper). This may result in product malfunction.

# Table of Contents

Safety Warnings . . . . .	2	Exporting a Clone File . . . . .	45
Important Safety Instructions . . . . .	3–4	Importing a Clone File . . . . .	47
Table of Contents . . . . .	5	<b>FTG File Manager Utilities Overview</b> . . . . .	52–57
<b>STB-3500 Introduction / Setup Checklist</b> . . . . .	6	Creating an FTG Configuration File . . . . .	52
Introduction . . . . .	6	FTG File Manager Main Screen . . . . .	54
Setup Checklist . . . . .	6	FTG Channel Map Configuration Utility . . . . .	55
<b>STB-3500 Cabling Connections</b> . . . . .	7–9	FTG Channel Map Editor . . . . .	56
Before You Begin . . . . .	7	FTG Installer Menu Configuration Utility . . . . .	57
Connect the STB to the Display Panel . . . . .	7	<b>IP Environment Setup</b> . . . . .	58–65
STB-3500 Cabling Diagram . . . . .	9	Accessing the IP Environment Menu . . . . .	58
<b>Commercial Mode Overview</b> . . . . .	10–13	Network Configuration . . . . .	58
Pass-through Mode . . . . .	10	Pro:Centric Setup . . . . .	62
FTG Mode . . . . .	11	Media Share Setup . . . . .	64
Determining the STB Operating Mode . . . . .	13	Pre-loaded Applications . . . . .	65
<b>Pro:Centric Operation</b> . . . . .	14–15	<b>References</b>	
Pro:Centric Interactive Menu Features . . . . .	14	Updating STB Software using a USB Memory	
Pro:Centric Interactive Menu Navigation . . . . .	14	Device . . . . .	66–67
Pro:Centric Setup . . . . .	15	Display Panel Specifications . . . . .	68
<b>Setting the Video Output Resolution</b> . . . . .	16	STB Aux Input Configuration . . . . .	69
<b>EZ-Manager Wizard</b> . . . . .	17–26	b-LAN Setup & Overview . . . . .	70
Before You Begin . . . . .	17	FTG Mode via EBL (Local Configuration) . . . . .	71
Initiate Configuration or Exit the EZ-Manager Wizard . .	18	Auto Input(s) Sensing Feature . . . . .	72
STB Configuration Options . . . . .	19	Restoring Factory Defaults on the STB(s) . . . . .	73
Zones and Room Number Assignments . . . . .	19	Using the STB's Zoning Features . . . . .	74–77
Configure Pro:Centric Settings . . . . .	21	Using Media Share Features . . . . .	78–82
USB Configuration . . . . .	25	STB-3500 Jack Panels . . . . .	83
<b>Ez Download Utility</b> . . . . .	27–30	External IR Receiver Specifications . . . . .	84
Before You Begin . . . . .	27	External Audio Line Out Specifications . . . . .	85
Accessing and Using the Ez Download Utility . . . . .	27	Installer Remote Typical Key Functions . . . . .	86
<b>Installer Menu</b> . . . . .	31–41	STB Installer Remote . . . . .	87
Accessing the Installer Menu . . . . .	31	Troubleshooting . . . . .	88–90
Using the Installer Menu . . . . .	32	General Troubleshooting . . . . .	88
Exiting the Installer Menu and Activating Settings . . . .	32	STB Quick Check . . . . .	89
<b>Custom Master STB Setup</b> . . . . .	42–44	Commercial Mode Check / FTG Operation	
Before You Begin . . . . .	42	Troubleshooting . . . . .	90
Clonable STB Setup Menu Features . . . . .	42	Glossary of Terms . . . . .	91
Custom Master STB Setup Procedure . . . . .	43	Document Revision History / Open Source Software Notice	92
<b>Cloning Procedures</b> . . . . .	45–51	Back Cover . . . . .	93

## Notes

- Installer Menu content is intended for use primarily by qualified TV electronics technicians.
- Refer to the STB-3500 Owner's Manual for additional information on STB installation, specifications, maintenance, and safety instructions.
- Design and specifications subject to change without prior notice. This document provides examples of typical screen displays. Your displays may vary from those shown in this document.

# STB-3500 Introduction / Setup Checklist

---

## Introduction

The STB-3500 set-top box is designed to be connected to a compatible commercial display panel to create a system that can provide Pro:Centric<sup>®</sup> functionality, as well as either RF or IP content delivery. The STB-3500 may be used with LG Commercial Hospitality TVs (LP645H, LT670H, etc.) that support Multiple Protocol Interface (MPI), or the STB-3500 may be used with LG Commercial Public Display TVs (LD450C, LT560C, etc.) or LG Commercial Monitors (M3203CCBA, M3204C, etc.) that support the TV-Link Monitor (TLM) interface. The STB-3500 may also be used with commercial non-LG TVs that support SONIFI's Multiple Television Interface (MTI) protocol.

## Setup Checklist

See also the STB-3500 Owner's Manual for information on STB installation and hardware and cable connections.

### Installation and Setup

\_\_\_ Unpack the STB and all accessories.

Accessories provided:

- AC/DC Power Adapter
- HDMI Cable
- MPI/MTI Cable (proprietary cable for LG MPI or SONIFI MTI control of display panel)
- TLM Cable (proprietary cable for LG TLM control of display panel)
- A/V Adapter Cable

\_\_\_ Obtain an LG Installer Remote for configuration purposes.

If you are connecting the STB to an LG display panel, the LG remote provided with the display should be sufficient. If you are connecting the STB to a non-LG display panel or if you intend to use multiple STBs/displays in a single room installation environment, an LG Installer Remote dedicated to STB control is available for purchase. For additional information and/or to purchase an STB Installer Remote, contact your LG service representative. See also Reference section, "STB Installer Remote."

\_\_\_ Determine the installation location for the STB and display panel stand or mount.

\_\_\_ Determine mounting and installation requirements, for example, AC power source outlet, antenna/cable service connectors, any external equipment required for system operation, all necessary cables, wires, and connectors, and any other additional required hardware, etc.

\_\_\_ Install the display panel on VESA mount or stand.

**Note:** It may be advisable to make all cable connections before installing on VESA mount or stand.

### Hardware Connections

\_\_\_ Install any additional hardware as appropriate to your institution, LAN, etc.

### Cable Connections

\_\_\_ Make all required connections to the STB jack panels, as described in this document.

### Commercial Mode Setup

\_\_\_ Complete appropriate procedures as described in this document for Commercial Mode operation.

This section describes how to connect the STB-3500 to establish communication with a compatible commercial display panel (LG Hospitality TV, LG Public Display TV, LG Commercial Monitor, or commercial non-LG TV with MTI support).

## Before You Begin

Refer to the appropriate subsection(s) below before proceeding to connect the STB. In particular, make sure each display panel is in the proper, known state.

### LG Display Panel Prerequisites

- The display panel should be in a known state. That is, the display panel should be either in a factory default state or custom configured (in its default mode) with selected settings, for example, the aspect ratio, that you wish to use in conjunction with the STB (see also bullet below).
- If you are using the STB with a commercial LG display panel that supports the Data Channel Auto Search feature (for example, LT777H, LP870H, etc.), set Installer Menu item 119 DATA CHANNEL on the display panel to 0 before connecting the STB.
- For newer LG Public Display TVs, when you power ON the TV for the first time, a Welcome Wizard will be displayed, and you will need to complete the first two steps of the wizard before you can successfully connect the STB. First, you will need to select the Language (Step 1), and then you will need to select the Mode Setting (Step 2). For Step 2, you MUST select "Home Use." After this, you can either continue with the wizard and select additional desired configuration settings, or you can use the EXIT key on the remote to exit the wizard.

### Commercial Non-LG Display Panel Prerequisites

- The display panel must be in a known state; however, note that you may need to perform initial steps to configure the display (i.e., the TV) and/or its MTI port for MTI communication. Refer to the manufacturer's documentation for further information.
- It is highly recommended that you set the display's start channel/Power On source to HDMI1 since the STB default configuration automatically sends Television/Display Control commands to switch the connected display panel to its HDMI1 input. Because some non-LG displays default to an RF channel at turn ON (or at loss of communication), setting the Power On source to HDMI1 will eliminate the potential for momentary signal interruption from the STB each time the STB/display is turned ON. This will also eliminate the potential for temporary signal interruption from the STB when the STB's PTC is being updated.

### LG Installer Remote

- An LG Installer Remote (not supplied) is required to complete the procedure below, as well as STB/display panel configuration procedures in this document. If you are connecting the STB to an LG display panel, the LG remote provided with the display should be sufficient. However, if you are connecting the STB to a non-LG display panel or if you wish to take advantage of the STB's multi-code feature, LG's STB-dedicated Installer Remote will be required. See Reference sections, "Installer Remote Typical Key Functions" and "STB Installer Remote," for further information.

# STB-3500 Cabling Connections (Cont.)

---

## Connect the STB to the Display Panel

This procedure only describes the essential STB/display panel connections. See Reference section, “STB-3500 Jack Panels,” for further information on the additional jack panel ports and connectors.

1. Turn ON the display panel.
2. Refer to the STB-3500 Cabling diagram on page 9, and complete the following connections:
  - a) Make the appropriate Television/Display Control connection between the STB-3500 and the display panel. (See also \* on following page.)
    - For LG Hospitality TVs: Use the MPI/MTI cable provided to connect MPI/MTI TELEVISION CONTROL on the STB-3500 front jack panel to the MPI port on the rear jack panel of the display.
    - For LG Public Display TVs or LG Commercial Monitors: Use the TLM cable provided to connect RS-232C TELEVISION CONTROL on the STB-3500 rear jack panel to the DB9 RS-232 CONTROL connector on the rear jack panel of the display.
    - For commercial non-LG TVs: Use the MPI/MTI cable provided to connect MPI/MTI TELEVISION CONTROL on the STB-3500 front jack panel to the MTI (typically labeled “DATA”) port on the rear jack panel of the display.
  - b) Use the HDMI cable provided to connect HDMI OUT on the STB-3500 rear jack panel to the HDMI1 input connector on the rear jack panel of the display. (See also \*\* on following page.)
  - c) For RF delivered content, connect a 75 ohm coaxial wire from the Antenna/CATV wall jack to ANTENNA/CABLE IN on the STB-3500 rear jack panel. For IP delivered content, connect an RJ-45 Ethernet (CAT5) cable from the institution’s network to the LAN port on the STB-3500 rear jack panel.
  - d) Insert the DC power plug of the AC/DC power adapter provided into the POWER connector on the rear jack panel of the STB-3500, and then plug the AC/DC adapter into a standard 120V 60 Hz AC power outlet.

Once power is applied to the STB-3500, the LED on the STB’s front jack panel will light steadily, indicating that the STB is in standby mode. Also, the display panel will be turned OFF by the STB as soon as the STB is powered and establishes Television/Display Control communication with the display.

**Note:** Once Television/Display Control communication is established between the STB-3500 and the display panel, the STB-3500 will be in control of the display panel, and certain resident panel functions, like panel buttons, typically will no longer operate.

3. Use the Installer Remote to turn ON the STB/display panel.

While the STB is turning ON and sending the turn ON command to the display, the STB LED blinks at a constant rate. Once both the STB and the display panel are ON, the STB LED remains lit but blinks off twice in rapid succession every five seconds. The first image you should see on the display panel is a prompt to select the video output resolution (see “Setting the Video Output Resolution” on page 16).

4. Select the video output resolution (i.e., the STB’s video output format), and complete the appropriate Commercial Mode setup procedures, as described in this document.

**Note:** It is recommended that you complete STB-3500 Commercial Mode setup procedures before you make external equipment connections to the STB-3500.



# STB-3500 Cabling Connections (Cont.)

## STB-3500 Cabling Diagram

See also step 2 of procedure above.

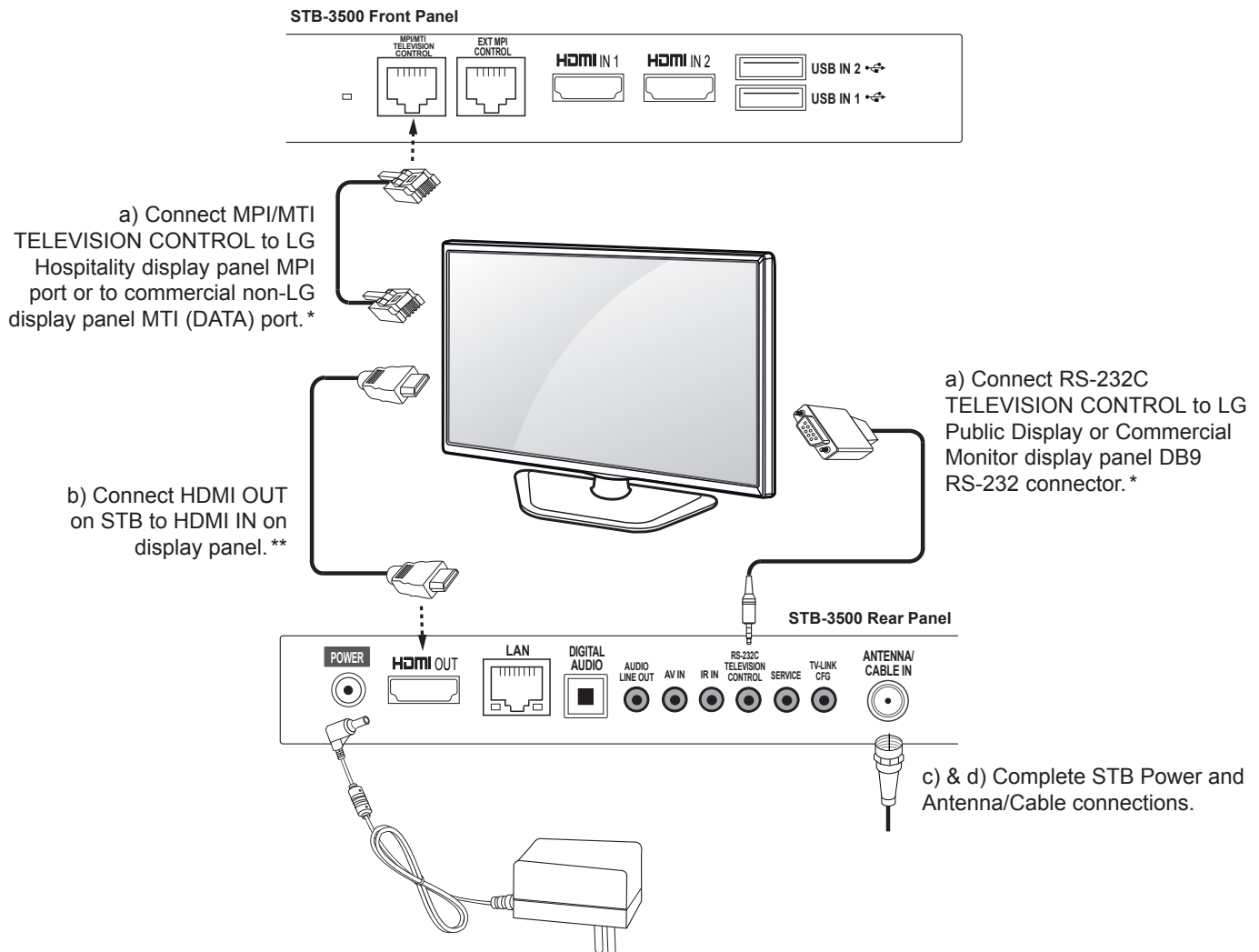

\* Only one Television/Display Control connection should be used. The proper connection depends on the type of display panel to be controlled. Also, note that on early STB-3500 models, the RS-232C TELEVISION CONTROL jack is labeled "DISPLAY CONTROL 1" and the MPI/MTI TELEVISION CONTROL port is labeled "DISPLAY CONTROL 2."

\*\* The STB default configuration automatically sends Television/Display Control commands to switch the connected display panel to its HDMI1 input.

# Commercial Mode Overview

---

This document describes how to set up the STB-3500 for Commercial Mode operation. STB-3500 functionality is based on “ownership” of the Channel Map; that is, the Channel Map resides in the STB’s CPU, Protocol Translator Card (PTC), or embedded *b*-LAN™ (EBL) module, or it resides externally from the STB (i.e., in a device from the solution provider). The STB-3500 is capable of Free-To-Guest (FTG) Mode operation via the STB CPU. Alternatively, the EBL module can be configured either for Pass-through Mode (default) or FTG Mode. When neither the CPU nor EBL is in FTG Mode, the STB-3500 may also be controlled externally via its EXT MPI CONTROL port (on early STB-3500 models, labeled “MPI”).

## Pass-through Mode

This mode allows you to configure individual STBs for Pro:Centric and/or FTG Mode via CPU operation. This mode also allows external control via the EXT MPI CONTROL port on the STB jack panel. There are two methods for configuring individual STBs that are currently in Pass-through Mode: either using the EZ-Manager Wizard or the Custom Master STB Setup procedure.

### EZ-Manager Wizard

When the STB is in a factory default state, the EZ-Manager Wizard provides automated and manual options for configuring essential items for Pro:Centric operation and also provides an option for using a USB memory device to configure the STB. Use the Installer Remote to make selections and complete each step. See “EZ-Manager Wizard” on pages 17 to 26 for detailed information.

### Custom Master STB Setup

The Custom Master STB Setup procedure enables you to create a customized Master STB Setup for Pass-through Mode or FTG Mode via CPU configuration purposes. Use the Installer Remote to configure Installer Menu items as required for STB operation and set up STB features (Picture, Sound, Channels, etc.). See “Custom Master STB Setup” on pages 42 to 44 for detailed information.

#### *Installer Menu*

To create a Master STB Setup, you will need to know how to access the commercial controller (PTC) Installer Menu and make changes to the default values as required. If necessary, familiarize yourself with the Installer Menu and how to make and save changes. Refer to pages 31 to 41 for information on accessing the Installer Menu and for detailed descriptions of the Installer Menu items.

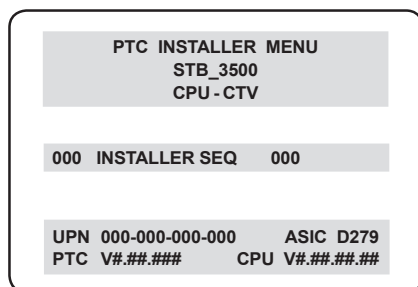

Typical Installer Menu

### STB Setup Menus

On-screen setup menus control the features of the STB/display. Use the Installer Remote to access the STB setup menus, and set the STB/display features to the desired configuration for the end user.

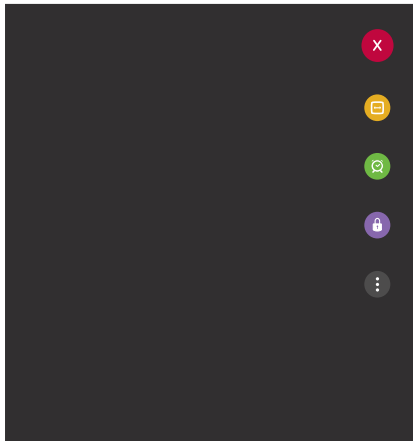

STB Setup Menu (Quick Settings)

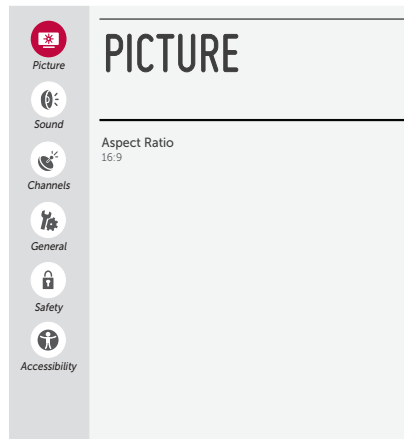

STB Setup Menu (Advanced Settings)

### Cloning

Cloning refers to the process of using a Master STB Setup to configure a Target STB. Both STBs must be identical models. The Master STB's clonable setup menu features should be configured as part of the Master STB Setup. If there are features in the Master STB's setup—channel icons or labels, digital font options, etc.—that are not set or that are set incorrectly, those features also will not be set or will be set incorrectly in the Target STBs. Refer to pages 45 to 51 for detailed information on cloning requirements and procedures.

### External MPI Control

To control the STB using an external MPI control device, you must use the STB's EXT MPI CONTROL port for communication purposes. Installer Menu item 118 POWER SAVINGS controls the power circuitry for both the embedded *b*-LAN module and the EXT MPI CONTROL port; therefore, to ensure that the EXT MPI CONTROL port circuitry is powered, thus enabling MPI communication, Installer Menu item 118 POWER SAVINGS must be set appropriately. See Installer Menu item descriptions as well as Reference section, "*b*-LAN Setup & Overview," for further information.

**Note:** The STB-3500 is not equipped with an MPI card slot.

### FTG Mode

In this mode, an FTG Channel Map enables the decryption of each Pro:Idiom<sup>®</sup> encrypted channel. The FTG Channel Map also provides logical channel mapping of physical RF channels (analog and digital), IP channels, and Aux inputs. The method for creating the FTG Channel Map is ultimately determined by which element of the STB will "own" the FTG Channel Map—the CPU or the EBL.

For the STB-3500, there are two FTG Modes—FTG Mode via CPU and FTG Mode via EBL—which are separate and distinct FTG Modes of operation, each with its own unique advantages and requirements, as outlined on the following page.

# Commercial Mode Overview (Cont.)

---

When the STB CPU is configured with an FTG Channel Map, the CPU controls and restricts the tuning operation of the STB, and when the EBL is configured with an FTG Channel Map, the EBL controls and restricts the tuning operation of the STB. Depending on the types of channels included in the FTG Channel Map, FTG Mode via CPU also provides the option to select either logical or physical tuning (see notes below) during configuration. You must determine which element of the STB will own the FTG Channel Map before you can begin configuration.

**Note:** Logical channel mapping of physical RF channels eliminates dash tuning (for example, physical 19-3 can be mapped to logical channel 9). It also allows physical RF channels, IP channels, and Aux inputs to be listed in any order, not only in physical numeric ascending order. Physical channel tuning requires that you include the dash when direct entering RF channel numbers and Aux inputs (the latter designated by 130-0 through 137-0).

**Note:** Physical channel tuning is not available when IP channels are included in the FTG Channel Map.

---

## FTG Mode via CPU

This mode provides the following features:

- Logical or physical tuning of physical RF channels and Aux inputs.
- Logical tuning of IP channels.
- Mapping of RF channels with minor (program) numbers up to 999.
- FTG Channel Map of up to 600 channels.
- Start Channel set for RF, Aux input, or IP delivered content.
- Pro:Centric data delivery over RF or IP.
- TV Zoning and Wi-Fi Zoning options for location-specific configuration.

LG's FTG File Manager PC software enables you to create an FTG Configuration (.tlx) file, which may be used to configure the CPU for FTG Mode. You can also create a Clone (.tlx) file from a Master STB Setup that may be used to configure the CPU for FTG Mode. In this mode, the CPU is the owner of the FTG Channel Map and must be configured with an FTG Channel Map and FTG Installer Menu settings using one of the following processes:

- Local: Configure an individual STB-3500 via its USB port using a USB memory device / ".tlx" file. The file may be either a Clone file (see "Cloning Procedures" on pages 45 to 51) or an FTG Configuration file (see "FTG File Manager Utilities Overview" on pages 52 to 57).
- Remote: Configure all STB-3500s at the site using a Pro:Centric server head end device (Example: PCS200S). Refer to the **Pro:Centric Server Admin Client User Guide** for further information.

## FTG Mode via EBL

This mode provides the following features:

- Logical tuning of physical RF channels and Aux inputs.
- Mapping of RF channels with minor (program) numbers up to 255.
- FTG Channel Map of up to 141 logical channels.
- Start Channel set for RF or Aux input delivered content.
- Pro:Centric data delivery over RF.

LG's FTG Device Configuration Application PC software is required to configure the EBL. In this mode, the EBL is the owner of the FTG Channel Map and must be configured with an FTG Channel Map and FTG Installer Menu settings using one of the following processes:

- Local: Configure an individual STB-3500's EBL via its TV-LINK CFG jack using a direct PC-to-STB (EBL) connection and the FTG Device Configuration Application. See Reference section, "FTG Mode via EBL (Local Configuration)," for information on the "Write" process for an FTG Channel Map and FTG Installer Menu settings.
- Remote: Configure all STB-3500 EBLs at the site using a Free-To-Guest Management Appliance (FMA) head end device (Example: FMA-LG101). Refer to the **Free-To-Guest (FTG) Device Configuration Application User Guide** and/or the Installation & Configuration Guide for the FMA device for further information.

While the STB is in FTG Mode:

- Users can still access the Installer Menu using an LG Installer Remote; however, all Installer Menu items will be read-only.
- FTG Mode via CPU configuration changes must be made using a “.tlx” file (typically edited in the FTG File Manager), while FTG Mode via EBL configuration changes must be made using the FTG Device Configuration Application. FTG Channel Map Configuration and FTG Installer Menu Configuration utilities in both PC applications enable you to make changes, respectively, to the FTG Channel Map and FTG Installer Menu settings as necessary. Based on the initial method used to configure the STB for FTG Mode operation (via CPU or EBL), all subsequent changes must be transferred to either the STB CPU or the EBL via a process that is in accordance or compatible with that method (see information on local configuration in this document or refer to documentation for the head end device/server for information on remote management).
- If it becomes necessary to restore the STB to Pass-through Mode, there are several options that will enable you to do so. See Reference section, “Restoring Factory Defaults on the STB(s),” for further information.

Pages 52 to 57 provide overviews of the utilities that comprise the FTG File Manager. Refer to the **Free-To-Guest (FTG) File Manager User Guide** for further information on the FTG File Manager. Refer to the **Free-To-Guest (FTG) Device Configuration Application User Guide** for information on the FTG Device Configuration Application.

## Remote Management in FTG Mode

When the STB is configured for FTG Mode via CPU, remote management of the FTG Channel Map and FTG Installer Menu settings is provided by a Pro:Centric server, via a Clone/Configuration (.tlx) file loaded on the Pro:Centric server Admin Client. See the **Pro:Centric Server Admin Client User Guide** for further information.

When the STB is configured for FTG Mode via EBL, the *b*-LAN module, which is internal to the STB, allows hotel/institution head end equipment (for example, an FMA-LG101) with *b*-LAN technology to provide remote management of the FTG Channel Map and FTG Installer Menu settings. See Reference section, “*b*-LAN Setup & Overview,” for further information.

## Determining the STB Operating Mode

To determine the operating mode of the STB, press **MENU** on the Installer Remote. The menu displayed depends on the operating mode. See examples below. If the Function Menu appears, the STB is in a mode (FTG, PPV, etc.) that does not allow the end user to change the fundamental STB setup. If the STB setup menus appear, the STB is in Pass-through Mode.

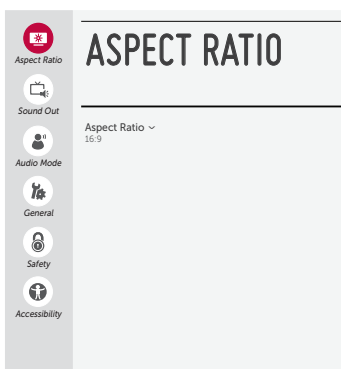

### Function Menu

Indicates the STB is not in Pass-through Mode. While the STB is in this mode, Installer Menu settings can be accessed as read-only.

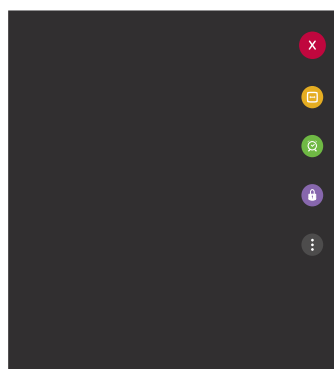

### STB Setup Menus

Shows that the STB is in Pass-through Mode.

# Pro:Centric Operation

---

## Pro:Centric Interactive Menu Features

LG's Pro:Centric application enables guests to locate and select television entertainment using an interactive channel guide, check the daily weather, and view hotel and surrounding amenities via custom billboards and points-of-interest maps.

Pro:Centric application features include:

- Portal and information screens/pages (including a "Welcome" page) that include branding logos.
- An optional customized user interface (custom "skins").
- Billboards and points-of-interest maps that can be customized to focus on hotel amenities, local attractions and businesses, restaurants, news, events, etc.
- An optional Weather billboard that includes a local radar map, current conditions, and a four day forecast.
- An interactive channel guide that provides a channel list with channel icons. An electronic program guide (EPG) is an optional feature that displays up to three days of programming information viewable by channel and time.
- Video spooling that enables the hotel to deliver a video file to guest TVs for promotion and information purposes.

The Pro:Centric server Admin Client web editor/content wizard is provided for customer configuration of portal messages and billboards/maps.

**Note:** Customized content is typically defined by the service integrator and/or hotel administrators. LG does not provide hotel-specific content.

## Pro:Centric Interactive Menu Navigation

An LG Pro:Centric-capable remote control provides access to both interactive menus and regular STB/display features. Press **PORTAL** on the remote to access the interactive menus.

**Note:** Interactive menu options may vary, depending on Pro:Centric features enabled for the site. The following are default interactive menus.



### Channel Guide

Shows available TV networks and logical channels. When available, EPG data provides additional channel and program information.

### Information

Typically displays information on hotel amenities, for example, restaurants, in-room dining, business centers, facilities, etc., as well as information on local weather and attractions.

### Help

Provides help for navigating the interactive menus.

### Watch TV

Removes the interactive menu from the screen and returns to the previously tuned TV channel.

## Pro:Centric Setup

Administration and management options for the Pro:Centric server are described in detail in the **Pro:Centric Server Admin Client User Guide**. This document describes only those settings that must be specified on the STB to enable Pro:Centric remote management and/or the Pro:Centric application.

- Remote management (E-Z Installation): The Pro:Centric server Admin Client provides remote management facilities for downloading software/firmware updates as well as facilities for downloading a Clone/Configuration (.tlx) file for FTG Mode via CPU configuration.
- Pro:Centric application: The application, which operates in conjunction with FTG and PPV Modes, comprises the Pro:Centric interactive menus/features described on the previous page. Pro:Centric application settings are managed via the Pro:Centric server Admin Client.

The Pro:Centric server settings can be configured using one of the methods described below.

### STB in Factory Default State

When the STB is in a factory default state, the EZ-Manager Wizard provides automated or manual options for configuring the Pro:Centric server settings.

The EZ-Manager Wizard also provides a USB Configuration option that enables you to configure an STB for FTG Mode via CPU using a Clone/Configuration (.tlx) file stored on a USB memory device. The “.tlx” file incorporates FTG Installer Menu settings, including Installer Menu items 098 PRO:CENTRIC and 119 DATA CHANNEL, which are used to set up the STB’s Pro:Centric feature.

Refer to “EZ-Manager Wizard” on pages 17 to 26 for further information on the EZ-Manager Wizard options.

**Note:** If Pro:Centric data delivery will be over IP and there is a Domain Name System (DNS) server at the site, you can create a “procentric.local” DNS entry for the Pro:Centric server that will enable automated Pro:Centric IP configuration via the EZ-Manager. If there is no DNS entry for procentric.local, you will need to manually enter the Pro:Centric server IP address and port number during configuration.

### STB in Pass-through Mode

If the STB is in Pass-through Mode, either:

- Set Installer Menu items 098 PRO:CENTRIC and 119 DATA CHANNEL to the appropriate values. See Installer Menu information on pages 31 to 41 for further details. Also, as necessary, refer to “Custom Master STB Setup” on pages 42 to 44 and/or cloning information on pages 45 to 51.
- Configure the appropriate Pro:Centric server settings in the IP Environment / Pro:Centric Menu. You must use this option, in particular, if you wish to configure IP settings for the Pro:Centric server. See “Accessing the IP Environment Menu” on page 58 and “Pro:Centric Setup” on pages 62 to 63 for further information.

**Note:** When the STB is in either Pass-through Mode or FTG Mode via CPU, you can also leave Installer Menu item 119 DATA CHANNEL set to its default value (255) to enable the STB’s Data Channel Auto Search feature to set the DATA CHANNEL value. See item 119 description on page 40 for additional information.

### STB in FTG Mode

If the STB is in FTG Mode (via CPU or EBL), use the appropriate FTG application software to update Installer Menu items #98 Pro:Centric and #119 Data Channel (along with their affiliated fields). Then, transfer the FTG Installer Menu settings to the STB in accordance with the FTG Mode of configuration. Refer to the FTG Mode overview on pages 11 to 13 for further information on FTG Mode operation and configuration. Also—for FTG Mode via CPU only—see note above regarding the option to use the STB’s Data Channel Auto Search feature to set the DATA CHANNEL value.

# Setting the Video Output Resolution

---

The first time you turn ON the STB/display panel, a Please Select Video Output Resolution menu will be displayed, and you will need to select the appropriate option—720p, 1080p, or 1366 x 768—for the STB’s video output format. You cannot proceed with STB configuration until you make a selection.

**Note:** After it is turned ON, the STB begins an initialization process, and it may take several minutes for the Please Select Video Output Resolution menu to be displayed.

Refer to documentation for the applicable display panel(s) to determine the appropriate setting. The selected resolution should be compatible with the display panel’s native video resolution.

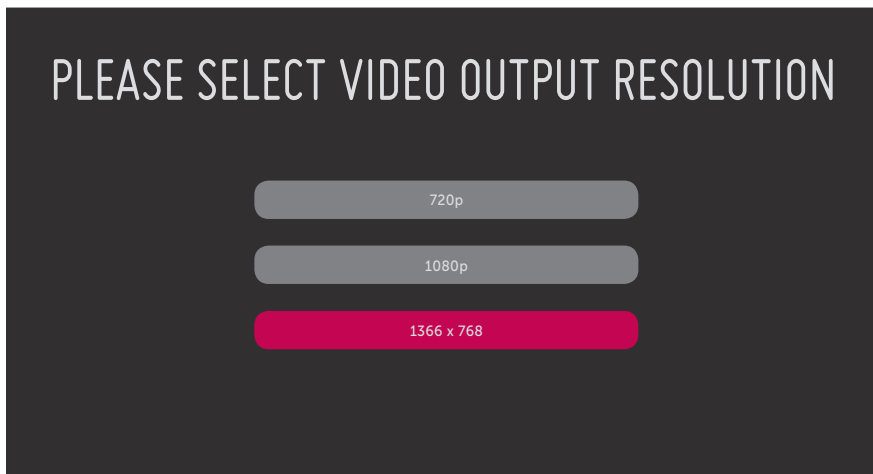

1. Use the Up/Down arrows on the Installer Remote to select the appropriate video output resolution option, and then press **OK**.

The STB’s default video output resolution is 720p. If you select this option, the Please Select Video Output Resolution menu will close and the EZ-Manager Wizard Welcome screen will be displayed (see pages 17 to 26 for information on the EZ-Manager Wizard). Proceed with Commercial Mode setup as required.

If you select one of the other two resolution options (1366 x 768 is selected/highlighted as the recommended resolution), a Changing Video Output Resolution message will be displayed, and the STB will reboot within a few seconds to change the resolution per your selection. Continue with step 2.

2. When the STB reboot is complete (it may take a few minutes), you will be prompted to confirm the new video output resolution. Use the arrow keys on the Installer Remote to select **YES** in the confirmation screen, and then press **OK** on the Installer Remote.

**Note:** If there is no user interaction within 10 seconds, or if you select “NO” in the confirmation screen, the STB will reboot and revert to the default resolution. After this reboot is complete, the Please Select Video Output Resolution menu will be redisplayed.

Once you select and confirm the video output resolution, the EZ-Manager Wizard will be displayed. Proceed with Commercial Mode setup as required.

**Note:** If required at a later time, you can also change the video output resolution in the STB Installer Menu (item 105 VID OUT FORMAT) or via USB memory device / “.ttx” file. In either case, the STB will need to reboot. See item 105 description on page 39 for additional information, including requirements for changing this setting when the STB is configured for FTG Mode via EBL.



The primary purpose of the EZ-Manager Wizard is to guide you through the process (automated or manual) of configuring the essential Installer Menu items for Pro:Centric operation. The wizard is initiated once the video output resolution is set (see previous page) and subsequently each time the STB/display panel is turned ON, until one of its configuration methods has been completed or the wizard is exited. Use the Installer Remote to make selections and complete each wizard step.

While the EZ-Manager Wizard is intended primarily for Pro:Centric-related configuration, the wizard also offers Zoning as well as USB configuration options.

- STB-3500s support the TV Zoning and Wi-Fi Zoning features, both of which enable location-specific settings (see Reference section, “Using the STB’s Zoning Features,” for further information). The EZ-Manager Wizard enables you to set the TV Zone # and/or the Wi-Fi Zone # in the STB as part of the configuration process.
- The EZ-Manager Wizard also enables you to access the STB Manager / USB download options as part of the configuration process, if desired, to perform USB configuration and/or update functions.



**Caution: Do NOT unplug the STB power cord or remove the antenna cable or, if applicable, the LAN cable during the configuration process, as doing so will interrupt the current step and may corrupt the configuration data.**

## Before You Begin

- If you plan to create a Master STB Setup using the procedure described on pages 42 to 44, be sure to exit the EZ-Manager Wizard in order to avoid setting modes that may restrict the custom setup procedure. See also “Initiate Configuration or Exit the EZ-Manager Wizard” on the following page.
- If it has been completed or exited and therefore does not display, the EZ-Manager Wizard can be reactivated; however, this requires that you restore the STB to a factory default condition. See Reference section, “Restoring Factory Defaults on the STB(s),” for further information.
- Each wizard step is allotted a time frame after which the wizard proceeds without user interaction. If the Pro:Centric server is configured on the system and if no location-specific settings are required in the STB, for example, TV Zone, Wi-Fi Zone, Label, and/or Room Number settings, you can simply turn ON the STB/display, and once initiated, the wizard will proceed through each of the configuration steps with no further user interaction.
- If any of the configuration steps fails, you will see a “Diagnostics” screen with an indication of the failure. You will then have the opportunity to reinitiate the configuration process from the previous screen or exit the EZ-Manager Wizard.
- If you would like to enable the DIAL and/or SoftAP Media Share feature on an STB that will eventually be configured for FTG Mode, you will need to use the IP Environment Menu to do so before the STB is configured for FTG Mode. Refer to “IP Environment Setup” on pages 58 to 65 for information on the IP Environment Menu. See also “Custom Master STB Setup” on pages 42 to 44.

# EZ-Manager Wizard (Cont.)

---

## Initiate Configuration or Exit the EZ-Manager Wizard

The Welcome screen provides a brief introduction to the EZ-Manager Wizard.



**Note:** If there is no user action in this screen within 10 seconds, the wizard will proceed to the first configuration step. Once the wizard has proceeded, it is not possible to return to the Welcome screen; however, if you simply wish to exit the wizard, you can do so by selecting the “EXIT” option from the subsequent screen(s).

From the Welcome screen, you have the following options:

- To proceed with the EZ-Manager Wizard, use the arrow keys on the Installer Remote to select/highlight **NEXT**, and then press **OK**. Then, continue to the “STB Configuration Options” section on the following page.
- To exit the wizard, but retain the use of the Pro:Centric remote management feature on this STB (i.e., Installer Menu item 119 DATA CHANNEL set to 255) in the future, use the arrow keys on the Installer Remote to select/highlight **EXIT**, and then press **OK**. In the confirmation pop-up window, select **OK**, and then press **OK** once more on the Installer Remote.
- If you do not intend to install a Pro:Centric server on this system and you do not wish to use the wizard’s Zoning or USB configuration options, exit the wizard as follows: Use the arrow keys on the Installer Remote to select/highlight **NO PRO:CENTRIC**, and then press **OK**. This will disable the Pro:Centric feature of this STB (i.e., Installer Menu item 119 DATA CHANNEL will be set to 0) and exit the wizard. In the confirmation pop-up window, select **OK**, and then press **OK** once more on the Installer Remote.

## STB Configuration Options

From the STB Configuration Options screen, you can choose how to proceed with the configuration of this STB/display (assuming you do not opt to exit the wizard, which you may also do at any time).



**Note: If you intend to use the Zoning feature(s) on the STB for location-specific configuration purposes, select the “Zones & Room Number” option from this screen and assign the appropriate TV Zone # and/or the Wi-Fi Zone # in the STB BEFORE you continue with additional configuration.**

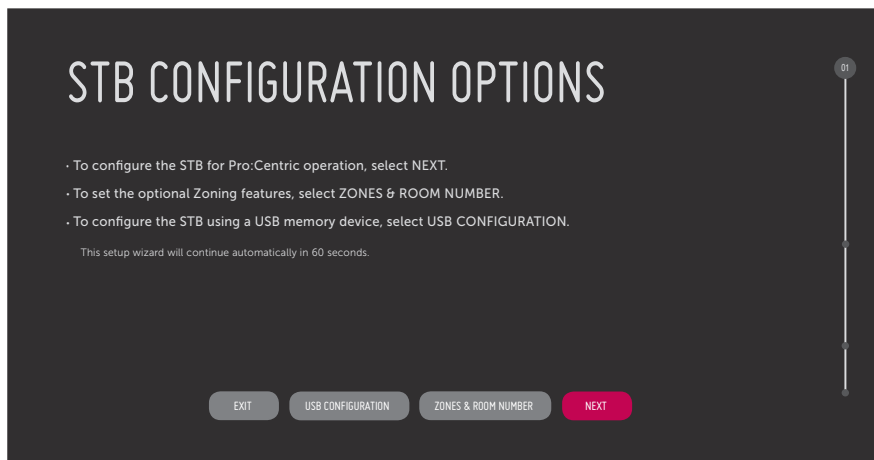

**Note:** If there is no user action in this screen within one minute, the wizard will automatically continue to the next configuration step.

Use the Left/Right arrow keys on the Installer Remote to navigate between options on this screen. Each time you select/highlight one of the following options, the screen text and fields will change in accordance with your selection.

- To continue with Pro:Centric configuration, select **NEXT** (default) and press **OK** on the Installer Remote. Refer to “Configure Pro:Centric Settings” on pages 21 to 25 for additional information.
- To set the Zoning feature(s) on the STB, select **ZONES & ROOM NUMBER**. See “Zones and Room Number Assignments” below for further information.
- To access the STB Manager / USB download options, select **USB CONFIGURATION**. See “USB Configuration” on pages 25 to 26 for further information.

**Note:** If you choose to exit the EZ-Manager Wizard from this point on, you will have the option to save any settings made by selecting **SAVE & EXIT** in the exit confirmation pop-up window. Or, you can exit the wizard without saving any settings by simply selecting **OK** in the confirmation pop-up window.

## Zones and Room Number Assignments

You may complete one or more of the fields in the Zones, Label, and Room Number screen or leave them at their default settings (TV Zone and Wi-Fi Zone) or blank (Label and Room Number), as desired. However, if you intend to use either of the Zoning features—TV Zoning and/or Wi-Fi Zoning—on this STB, you **MUST** specify the appropriate values in the TV Zone and/or Wi-Fi Zone fields as described on the following page. See also Reference section, “Using the STB’s Zoning Features,” for further information.

# EZ-Manager Wizard (Cont.)

**Note:** Zoning features are only applicable for STBs that will be configured using a TLX file (local or remote configuration).

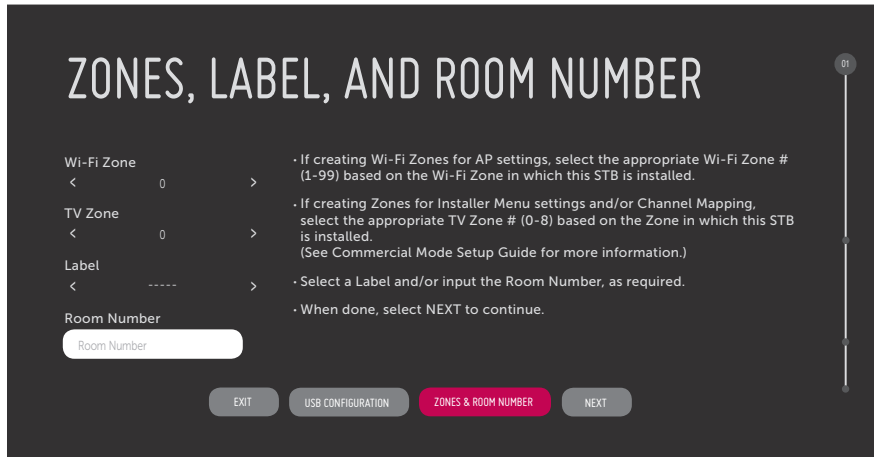

1. Complete the appropriate field(s) as described below. Use the Left/Right arrow keys on the Installer Remote to navigate between each of the fields.
  - **Wi-Fi Zone:** Enables you to set a Wi-Fi Zone # so that the STB can be configured with a particular access point's login data for wireless networking. Login data (i.e., SSID, security type, and security key) may be provided in a Clone/Configuration (.tlx) file.  
To assign a Wi-Fi Zone, navigate to the Wi-Fi Zone field at the top left of the screen, and use the Left/Right arrow keys to specify the desired Wi-Fi Zone # (1–99).
  - **TV Zone:** Enables you to set a TV Zone # so that the STB can be configured with Installer Menu and/or TV Setup Menu settings intended only for the assigned Zone. The Installer Menu and/or TV Setup Menu settings may be provided in a Clone/Configuration (.tlx) file. If the STB is being configured for FTG Mode via CPU, the TV Zone # setting also allows the STB to omit channels that have been restricted in the FTG Channel Map.  
To change the TV Zone from its default value (0), navigate to the TV Zone field, and use the Left/Right arrow keys to specify the desired TV Zone # (1–8).
  - **Label:** Allows you to select a North, South, East, or West text label for this STB. In the Label field, use the Left/Right arrow keys to select the applicable label.
  - **Room Number:** Allows you to specify the number of the room—up to 16 characters—in which the TV is located. To enter a room number, navigate to the Room Number field and press **OK**. You can then use the number keys on the Installer Remote to direct enter a room number, or you can use the arrow keys to select the appropriate alphanumeric character(s) from the pop-up virtual keyboard at the bottom of the screen. When you are done, select **Enter** from the virtual keyboard, and then press **OK** on the Installer Remote.
2. When you are ready to continue, select the appropriate option, as follows:
  - To proceed to the next EZ-Manager screen, use the arrow keys to select **NEXT**, and then press **OK** on the Installer Remote. Continue to the “Configure Pro:Centric Settings” section on the following page.
  - To use a USB memory device to complete the configuration, continue to “USB Configuration” on pages 25 to 26.

### Configure Pro:Centric Settings

Once you select “NEXT” from the STB Configuration Options screen, the Searching for Pro:Centric Server screen is displayed.

**Note:** Select the “BACK” button, where available, to check previous settings, as necessary.

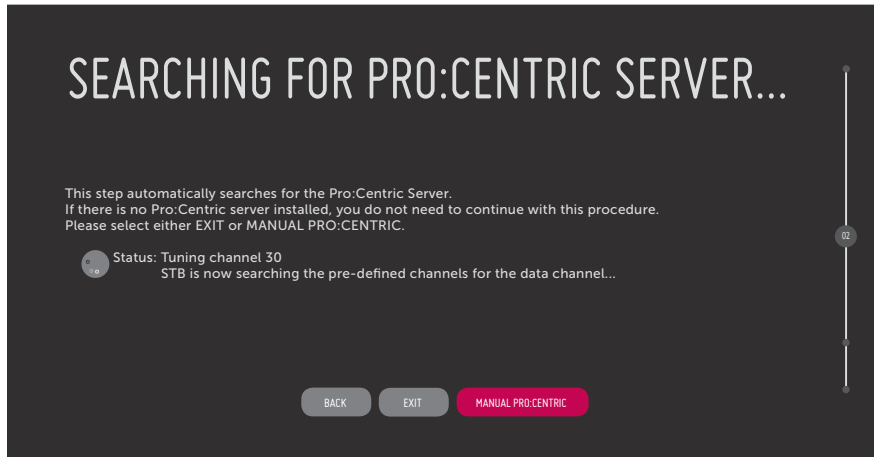

You have the following options:

- You can allow the EZ-Manager Wizard to proceed with a series of automated steps to configure the STB for Pro:Centric operation and then to look for the Pro:Centric application and maintenance (E-Z Installation) files to download. In this case, the wizard uses a search algorithm to determine the Data Channel and the Pro:Centric Application Mode to set in the STB.

Continue with the “Automated Pro:Centric Configuration” subsection below.

- If you already know the settings (i.e., Data Channel and Pro:Centric Application Mode) that need to be configured in order for the STB to connect to the Pro:Centric server and/or if the Pro:Centric server is not yet installed, you may expedite the setup process by entering this data manually.

Continue with the “Manual Pro:Centric Configuration” subsection on page 23.

### Automated Pro:Centric Configuration

**Note:** If the server is not yet configured on the system, use the manual configuration option to configure the Pro:Centric operation. See also note below.

**Note:** If Pro:Centric data delivery will be over IP and there is a DNS server at the site, you can create a DNS entry “procentric.local” for the Pro:Centric server that will enable automated Pro:Centric IP configuration via the EZ-Manager. If there is no DNS entry for procentric.local, you must use the manual configuration option to configure the Pro:Centric IP operation.

Once the Pro:Centric data channel is found (a Pro:Centric Server Was Found screen will be displayed) and the Pro:Centric Application Mode is determined, the wizard will advance to the Processing the Pro:Centric Configuration screen, which shows the progress of the data downloads (see example on following page). Note that some steps may require a few minutes.

(Continued on next page)

## EZ-Manager Wizard (Cont.)

---

(Continued from previous page)

If the process is successful, no further user interaction is required, though, in some instances, where the option (for example “NEXT”) is available, you may manually move forward to subsequent steps within the wizard to speed up the process.

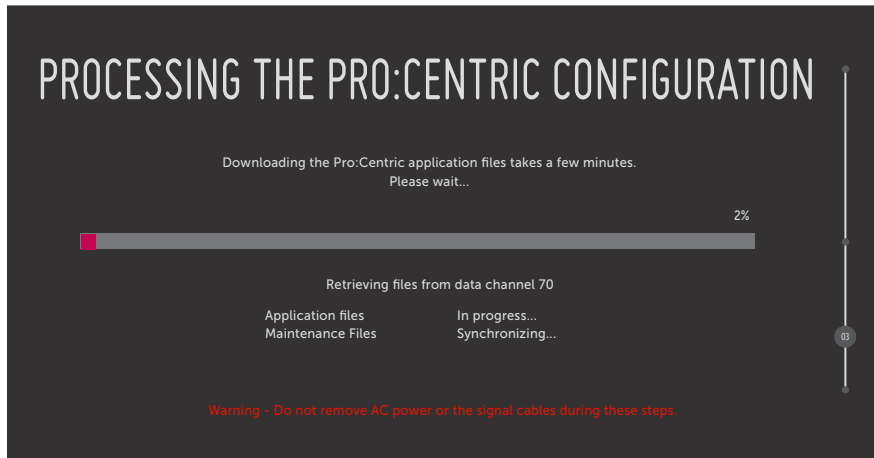

**Note:** If, after completing the search, the STB is unable to find the Pro:Centric data channel (while the Searching for Pro:Centric Server screen is on display), the wizard will stop and show a Diagnostics screen that enables you to manually return to the previous screen (to reinitiate the configuration) or exit the wizard.

When the Pro:Centric Configuration is complete, an EZ-Manager Configuration Complete screen is displayed (see example below), and after 10 seconds, the wizard exits, and the STB turns OFF.

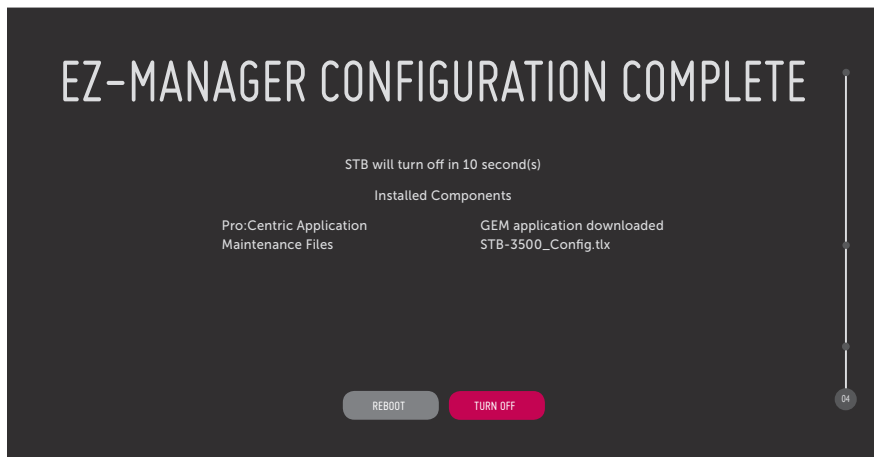

**Note:** With the EZ-Manager Configuration Complete screen on display, you can also manually turn off or reboot the STB. If desired, select **TURN OFF** or **REBOOT**, respectively, and then press **OK** on the Installer Remote.

## Manual Pro:Centric Configuration

1. With the Searching for Pro:Centric Server screen on display, use the Left/Right arrow keys on the Installer Remote to select **MANUAL PRO:CENTRIC** at the bottom right of the screen, and then press **OK**.

In the Pro:Centric Manual Configuration screen (see examples below), you will be able to configure the appropriate Pro:Centric settings in the STB. Use the Up/Down arrow keys on the Installer Remote to navigate between fields.

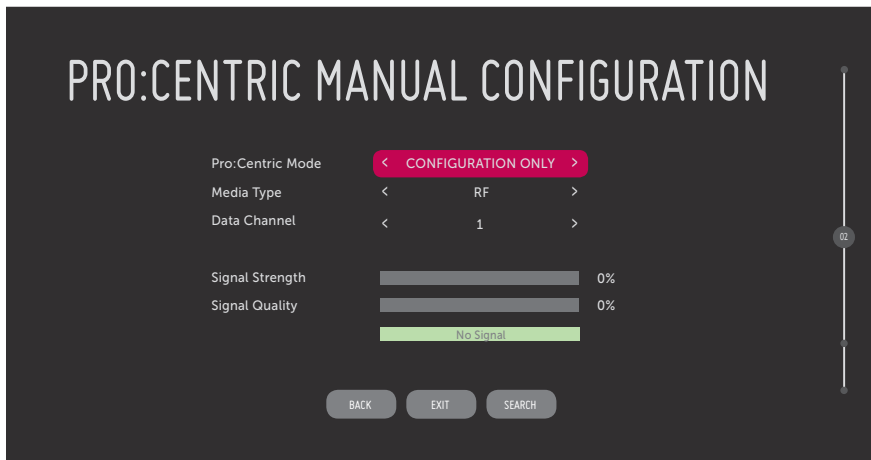

Pro:Centric Manual Configuration Screen with RF Media Fields

**Note:** By default, the Pro:Centric Manual Configuration screen initially shows RF configuration fields.

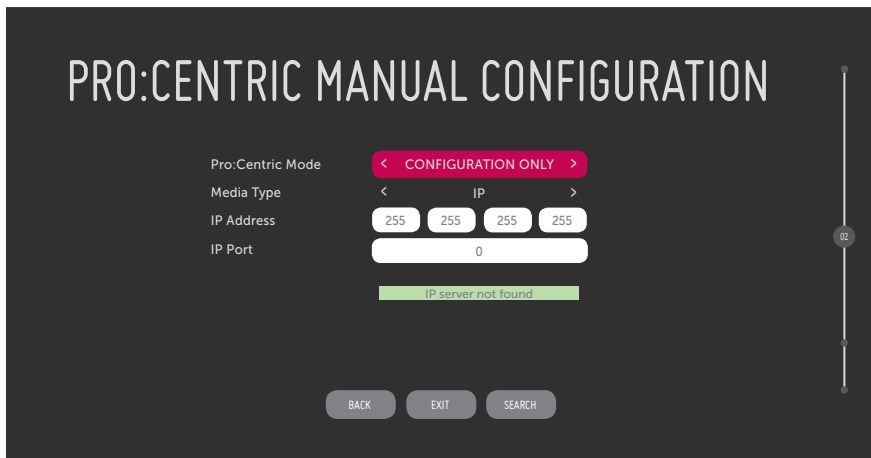

Pro:Centric Manual Configuration Screen with IP Media Fields

2. In the Pro:Centric Mode field, use the Left/Right arrow keys to select the appropriate Pro:Centric Application Mode—FLASH, GEM, HTML, or CONFIGURATION ONLY.

**Note:** For remote management only, select **CONFIGURATION ONLY**. The STB will search for E-Z Installation data downloads; however, Pro:Centric application data will not be downloaded, i.e., Installer Menu item 098 PRO:CENTRIC will be set to 0.

3. Refer to the appropriate subsection below, depending on the Pro:Centric server configuration, to complete the remaining fields.

(Continued on next page)

# EZ-Manager Wizard (Cont.)

---

(Continued from previous page)

## RF Configuration

- a) In the Media Type field, use the Left/Right arrow keys to select **RF**.
- b) In the Data Channel field, use the Left/Right arrow keys to select the RF channel number that will be used by the Pro:Centric server as its data channel. The Data Channel value can be set from 1 to 135.\*

## IP Configuration

- a) In the Media Type field, use the Left/Right arrow keys to select **IP**.  
**Note:** When you select “IP” as the Media Type, the default RF Data Channel and Signal Strength/Quality fields are replaced with IP Address and IP Port fields.
- b) Enter the Pro:Centric server IP address and port number in the IP Address and IP Port fields, respectively. The IP address must match the IPv4 multicast address and the port number must match the port number that is set in the Pro:Centric server.

For each data entry field: Use the arrow keys to select the field and press **OK**. Then, you can either use the number keys on the Installer Remote to directly enter data values, or you can use the arrow keys to select the appropriate number(s) from the pop-up virtual keyboard displayed at the bottom of the screen. When you are done, select **Enter** from the virtual keyboard, and then press **OK** on the Installer Remote.

4. Once all fields are completed as required, you have two options:
  - To save the data entered and exit the wizard, use the arrow keys to select **EXIT** and then press **OK**. In the subsequent pop-up confirmation window, select **SAVE & EXIT**, and then press **OK** once more. The Pro:Centric application and/or E-Z Installation data will be downloaded to the STB at a later time. This option is useful, in particular, if the Pro:Centric server has not yet been configured.
  - To initiate a real-time download of Pro:Centric application and/or E-Z Installation data, use the arrow keys to select **SEARCH** and press **OK** to verify the configuration data provided in step 3. When the data is verified, the “SEARCH” button becomes a “NEXT” button. Select **NEXT** and press **OK** to continue (see also note below).

**Note:** With RF configuration, Pro:Centric server data must be present on the RF channel selected as the STB’s Data Channel in order for you to select “NEXT” (you will see a “data channel found” message below the Signal Quality indicator). With IP configuration, Pro:Centric server data must be present via the wired LAN cable connection in order for you to select “NEXT” (you will see a “IP server found” message below the IP Port field).

If you opt to initiate a real-time download in the last step, the EZ-Manager Wizard will proceed with the Pro:Centric application and/or E-Z Installation data downloads (see Processing the Pro:Centric Configuration screen example on page 22). When the Pro:Centric configuration is complete, an EZ-Manager Configuration Complete screen (see example on page 22) is displayed, and after 10 seconds, the wizard exits, and the STB turns OFF.

**Note:** With the EZ-Manager Configuration Complete screen on display, you can also manually turn off or reboot the STB. If desired, select **TURN OFF** or **REBOOT**, respectively, and then press **OK** on the Installer Remote.

\* PCS150R and later Pro:Centric servers do not support HRC or IRC cable channel frequencies.



## USB Configuration

The STB Manager / USB download options enable you to download configuration or software files individually from a USB memory device to the STB. You can also use the Ez Download utility available from the menu to select one of each type of file to be downloaded at one time using one process.

Each of the STB download functions requires that you have the appropriate file(s) loaded on a USB memory device. If you wish to perform a software update, the software update file(s) must be stored in a folder named "LG\_DTV" in the root directory of the USB memory device. Clone/Configuration (.tlx) files should simply be stored in the root directory of the USB device.

The procedure below assumes the desired file(s) is/are already loaded onto the USB device. For further information on the STB Manager / USB download options and file requirements, and/or for information on creating Clone/Configuration (.tlx) files, refer to the appropriate section(s) in this document.

### Before You Begin

- If you intend to use the Zoning feature(s) on this STB, make sure to assign the appropriate TV Zone # and/or Wi-Fi Zone # in the EZ-Manager's Zones, Label, and Room Number screen BEFORE continuing with USB Configuration. See "STB Configuration Options" on page 19 for further information.
- Ensure the USB device to be used has been formatted with FAT format.
- When creating files to be downloaded, avoid using special characters (?, &, @, etc.) in filenames.
- Refer to "Ez Download Utility" on pages 27 to 30 for further information on the Ez Download utility.
- Refer to "Custom Master STB Setup" on pages 42 to 44 for information on creating a Clone (.tlx) file, and/or refer to "Creating an FTG Configuration File" on pages 52 to 53 for information on creating a FTG Configuration (.tlx) file for FTG Mode via CPU configuration.
- See Reference section, "Updating STB Software using a USB Memory Device," for further information on software updates.

### USB Configuration via EZ-Manager Wizard

With either the STB Configuration Options or the Zones, Label, and Room Number screen on display, proceed as follows to configure the STB/display using the USB memory device.

1. Insert the USB memory device with the appropriate file(s) into either of the STB's USB ports.
2. Use the arrow keys on the Installer Remote to select **USB CONFIGURATION**, and then press **OK**.

You will be redirected to the STB Manager / USB download options (see example below).

**Note:** You can select the **EXIT** button and press **OK** on the Installer Remote at any time to return to the EZ-Manager Wizard.

**Note:** Ez Download is always selected by default when you initially access the STB Manager. Also note that Diagnostics is for service use only.

(Continued on next page)

# EZ-Manager Wizard (Cont.)

(Continued from previous page)

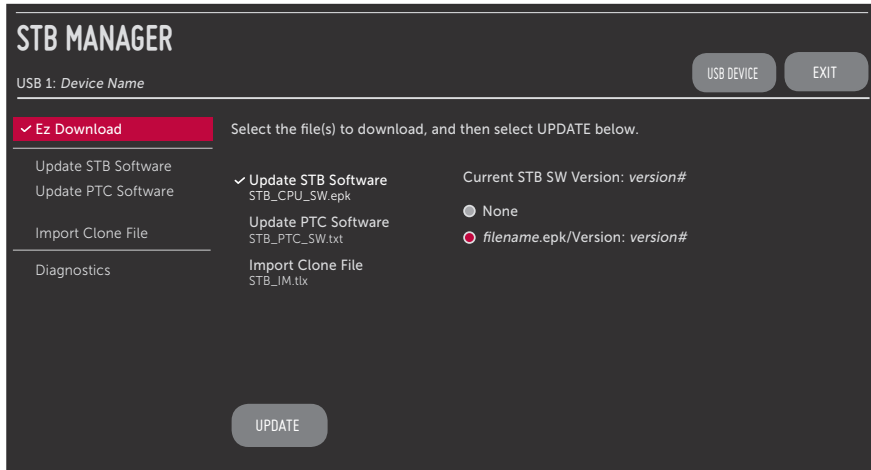

3. If more than one USB memory device is currently connected to the STB, be sure to select the USB device that contains the file(s) you wish to use. If necessary, use the arrow keys on the Installer Remote to select/highlight the **USB DEVICE** button at the top right of the screen and press **OK**. Then, use the Up/Down arrow keys to select the appropriate USB device from the pop-up list of USB devices displayed at the top of the screen.
4. Select the appropriate option from the STB Manager, and initiate the desired download(s).  
Update progress will be shown on the screen. Do NOT remove the USB device while updates are in progress. When the update process is complete, the STB will reboot. Upon restart, depending on the type of update(s) completed, either the EZ-Manager STB Configuration Options screen will be redisplayed (only software was updated) or the STB will tune according to the Start Channel setting in the Installer Menu (the STB was configured with a Clone/Configuration file).  
**Note:** If the STB Configuration Options screen is redisplayed (only software was updated), you can either proceed with configuration via the EZ-Manager Wizard or exit the EZ-Manager Wizard, as required.  
**Note:** If you updated the STB configuration with a Clone/Configuration file that included a change to Installer Menu item 105 VID OUT FORMAT, when the reboot is complete, you will be prompted to confirm the new video output resolution. See item 105 description on page 39 for further information.
5. Remove the USB memory device, and verify that the appropriate configuration/update(s) is/are resident on the STB.

The Ez Download utility, available from the STB Manager, enables you to select multiple files (one of each file type) at one time from the files loaded on a USB memory device. You may use this utility to download any one or all of the following to an STB: a Clone or FTG Configuration (.tlx) file, an STB (CPU) software update, a PTC software update.

## Before You Begin

- Ensure the USB device has been formatted with FAT format.
- Software update files must be stored in a folder named “LG\_DTV” in the root directory of the USB memory device. Clone/Configuration (.tlx) files should simply be stored in the root directory of the USB device.
- If the EZ-Manager Wizard appears on the screen when you turn ON the STB/display, you can use the wizard’s “USB Configuration” option to access the Ez Download utility (see “STB Configuration Options” and/or “USB Configuration” on pages 19 and 25, respectively, as necessary).
- If the STB is currently in Pass-through Mode and you intend to use the Zoning feature(s) on this STB for location-specific configuration purposes, make sure to assign the appropriate TV Zone # and/or Wi-Fi Zone # in the STB when directed to do so in the procedure below.
- When creating files to be downloaded, avoid using special characters (?, &, @, etc.) in filenames.
- Refer to “Custom Master STB Setup” on pages 42 to 44 for information on creating a Clone (.tlx) file, and/or refer to “Creating an FTG Configuration File” on pages 52 to 53 for information on creating an FTG Configuration (.tlx) file for FTG Mode via CPU configuration.
- See Reference section, “Updating STB Software using a USB Memory Device,” for further information on software updates.



**Caution: Do not unplug the STB power cord or remove the USB memory device during a data download, as doing so may cause the STB to malfunction or harm the USB device, respectively.**

## Accessing and Using the Ez Download Utility

1. If it is not ON already, turn ON the STB/display panel.
2. The next step depends on whether the EZ-Manager Wizard appears on the screen when you turn ON the STB/display:
  - If the wizard is displayed, you can access the Ez Download utility via the wizard, as indicated above (see “Before You Begin”). However, to continue with this procedure and access the Ez Download utility from the STB menus, exit the EZ-Manager Wizard. Then, continue with step 3.
  - If the wizard is not displayed, go directly to step 3.
3. If the STB is currently in Pass-through Mode, you would like to transfer (import) a “.tlx” file to the STB via the Ez Download utility, and you intend to use one or both of the STB’s Zoning feature(s), assign the appropriate TV Zone # and/or Wi-Fi Zone # in the STB at this time. See Reference section, “Using the STB’s Zoning Features,” for further information.



**Note: In order for the proper location-specific TV Zone and/or Wi-Fi Zone profile data to be applied, the Zone designation(s) must be assigned in the Target STB(s) BEFORE you continue with the Ez Download utility.**

(Continued on next page)

# Ez Download Utility (Cont.)

(Continued from previous page)

4. Insert the USB memory device with the appropriate file(s) into either of the STB's USB ports.
5. To access the STB Manager from the STB menus:
  - Press **MENU** on the Installer Remote to display the STB setup menus (STB is in Pass-through Mode) or the Function Menu (STB is not in Pass-through Mode).
  - If the Quick Settings Menu is displayed at the right of the screen (i.e., the STB is in Pass-through Mode), select the **Advanced** ⓘ menu icon and press **OK** to access the advanced STB setup menus.
  - Use the arrow navigation keys to select/highlight either the **General** menu icon from the STB setup menus or the **Safety** menu icon from the Function Menu. Then, press the number "7" key a total of seven times.

**Note:** Ez Download is always selected by default when you initially access the STB Manager. Also note that Diagnostics is for service use only.

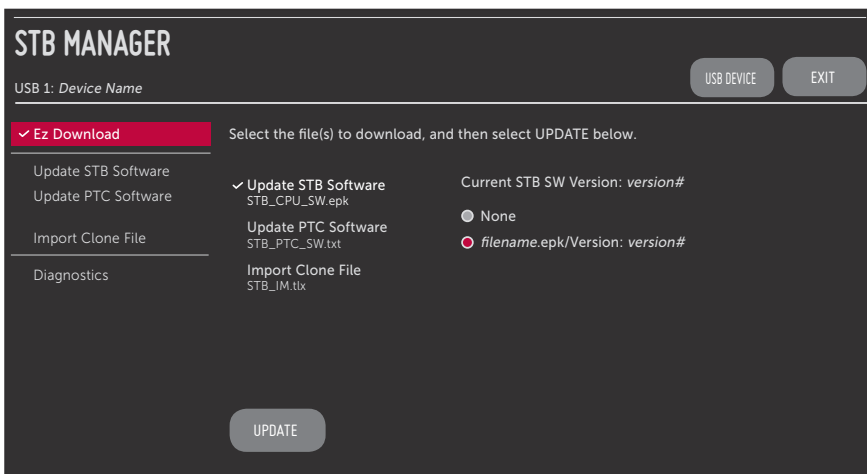

6. If more than one USB memory device is currently connected to the STB, be sure to select the USB device that contains the file(s) you wish to use. If necessary, use the arrow keys on the Installer Remote to select/highlight the **USB DEVICE** button at the top right of the screen and press **OK**. Then, use the Up/Down arrow keys to select the appropriate USB device from the pop-up list of USB devices displayed at the top of the screen.



7. If it is not currently selected, use the arrow keys to select **Ez Download**, and then press **OK**.

(Continued on next page)

(Continued from previous page)

As illustrated above, when Ez Download is selected, a list of up to three files is displayed on the screen, one each of the STB Software (CPU) and PTC Software files stored in the LG\_DTV folder and the Clone/Configuration (.tlx) files stored in the root directory on the USB device.

**Note:** Press **↵** on the Installer Remote or select **EXIT** in the top right corner of the screen to exit the STB Manager (if accessed from the STB menus, you may also press **EXIT** on the Installer Remote to exit). If you accessed the STB Manager via the EZ-Manager Wizard, you will be returned to the last screen on display before you selected the “USB Configuration” option. If you accessed the STB Manager via the STB menus, you will be returned to program viewing.

8. To select a file:

- Use the arrow keys on the Installer Remote to select/highlight the appropriate file type field, and then press **OK**. A list of available files will be displayed to the right of the file type fields.
- Then, use the arrow keys to select the desired file.

**Note:** The utility will only allow you to select one of each file type for downloading. For example, if there are two files in the Ez Download “Import Clone File” list, you can only select one or the other of those two files.

**Note:** The initial default value for each file type is “None.” After the Ez Download utility is run, a file is automatically created and stored on the USB device that was used. The file, which will have a “.dzm” file extension, maintains a history of the file(s) previously used with the Ez Download utility. The next time(s) you use this USB device with the Ez Download utility, the file(s) selected for the last download will be pre-selected for the current download, thus facilitating the process of configuring additional STB-3500s using the same USB device.

**Note:** The current STB software (CPU) or PTC software version is always displayed above the listing of available STB software and PTC software files, respectively. Ensure the software version of the selected file is the correct version before applying the update to this STB.

9. If a Clone/Configuration (.tlx) file that includes an FTG Channel Map is selected, a Channel Tuning / Channel Banner Display field will be displayed at the right of the screen. If the FTG Channel Map comprises RF channels and Aux inputs *only* (the latter designated by 130-0 through 137-0), you can choose the format for the channel tuning/banner display. Use the arrow keys on the Installer Remote to select **Logical** tuning or **Physical** tuning. A checkmark will appear at the left of the selected option. Logical tuning is selected by default.

**Note:** If an FTG Channel Map includes IP channels, only logical tuning is available. Also, if the selected “.tlx” file does not include an FTG Channel Map, the message, “No Channel Map in Clone file,” will be displayed at the right of the screen.

10. When you are ready to continue, use the arrow keys on the Installer Remote to select **UPDATE**, and then press **OK**.

Update progress will be shown in a new screen. Do NOT remove the USB device while updates are in progress. When the Ez Download process is complete, an overview of the results will briefly be displayed and then, the STB will reboot.

(Continued on next page)

## Ez Download Utility (Cont.)

---

(Continued from previous page)

11. Remove the USB memory device, and verify that the appropriate configuration/update(s) is/are resident on the STB.

**Note:** If you updated the STB configuration with a Clone/Configuration file, upon restart (and, if applicable, confirmation of new video output resolution—see note below), the STB tunes according to the Start Channel setting in the Installer Menu. If a Start Channel is specified, the STB will tune to that channel, though in the case of FTG Mode via CPU configuration, a channel banner will only be displayed if the Start Channel is included in the FTG Channel Map (depending on your selection in step 9, the channel banner will display either the Start Channel's logical channel number or physical RF channel number). Otherwise, the STB will either return to the last channel tuned (STB in Pass-through Mode) or tune to the first channel in the FTG Channel Map (STB in FTG Mode via CPU). In the latter case, remember that the channels in the FTG Channel Map are always arranged in logical order, regardless of your selection in step 9.

**Note:** If you updated the STB configuration with a Clone/Configuration file that included a change to Installer Menu item 105 VID OUT FORMAT, when the reboot is complete, you will be prompted to confirm the new video output resolution. See item 105 description on page 39 for further information.

Use the Installer Menu to set up, change, or view operational settings. This section describes how to access, use, and exit the Installer Menu on location; however, you should also refer to the Installer Menu descriptions in this document if you are configuring the STB CPU using an FTG Configuration (.tlx) file created using LG's FTG File Manager software or configuring the EBL locally (.rml) or remotely (via FMA-LG101 / .fma) using the FTG Device Configuration Application software.

Refer to the table on pages 33 to 35 for brief descriptions of Installer Menu items. More detailed descriptions follow the table listing.

## Accessing the Installer Menu

1. Turn ON the STB/display panel.

If the EZ-Manager Wizard appears on the screen when you turn ON the STB/display, exit the wizard.

2. Using an Installer Remote, press **MENU** repeatedly until the on-screen display of the setup menus (if the STB is in Pass-through Mode) or the Function Menu (if the STB is not in Pass-through Mode) no longer toggles, and then press the STB Installer Menu entry sequence (e.g., **9-8-7-6**) + **EXIT** to access the STB Installer Menu.

**Note:** The default Installer Menu entry sequence is "9876"; however, if Installer Menu item 000 INSTALLER SEQUENCE has been modified, the entry sequence may be one of three additional options. See Installer Menu detailed descriptions for further information.

The Installer Menu opens with item 000 INSTALLER SEQ 000.

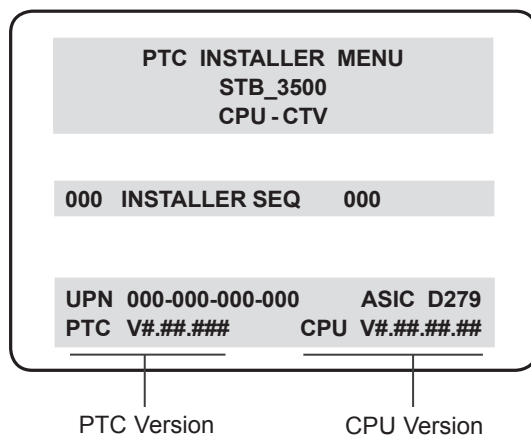

### Typical Installer Menu

The menu header identifies this as the STB-3500 Installer Menu. In the Installer Menu footer, you can see the current software versions of the STB, as indicated.

**Note:** If the password (entry sequence) is not entered or registered correctly, you will see the message "ENTER STB PASSWORD 0000" at the top of the screen instead of the STB Installer Menu header. Once you re-enter the correct password (e.g., press 9-8-7-6 + EXIT), the STB Installer Menu will display.

**Note:** If an LG Hospitality TV (for example, LP645H, LT670H, etc.) is being used as the display panel (connected to MPI/MTI TELEVISION CONTROL on the STB) and you press the TV Installer Menu entry sequence + OK, you will access the TV's Installer Menu instead of the STB's Installer Menu. The TV's Installer Menu is accessible as read-only.

**Note:** If the STB is not in Pass-through Mode, the Installer Menu is accessible as read-only. Also, the TV Zone # will be indicated in the Installer Menu header under the configuration mode indicator described on the following page.

## Installer Menu (Cont.)

---

As part of the Installer Menu header (in all modes), two 3-character acronyms are displayed to indicate the STB's current configuration mode. The table below lists all possible mode identifiers for the STB-3500.

Acronym	Description
CPU-CTV	Pass-through Mode with Channel Lineup in CPU
CPU-FTG	FTG Mode via CPU
CPU-P:C	Application Tuning Mode via CPU
EBL-FTG	FTG Mode via EBL
EBL-LNT	SONIFI PPV Mode
MPI-EXT	External MPI Control
PTC-CTV	Pass-through Mode with Channel Map in PTC

### Using the Installer Menu

Refer to the table starting on the next page for an overview of the available Installer Menu items, including their item numbers, functions, value ranges, and default values.

Installer Menu items not relevant to the STB are not present in the Installer Menu; therefore, some numbers are missing. For example, item 006 will not appear. In addition, items that are dependent on other Installer Menu item settings will not be initially accessible. For example, item 046 STRT AUX SRCE will not display in the Installer Menu unless item 004 STRT CHANNEL is set to 0. See Installer Menu detailed descriptions for further information.

### Navigation within the Installer Menu

Use the Up/Down arrow keys on the Installer Remote to sequence through the available menu items, or access an item directly by keying in the item number and then pressing **MENU**. For example, to access the SLEEP TIMER option, which is item 015, press 0-1-5 + MENU.

### Changing Installer Menu Settings

To change an Installer Menu item value, use the Left/Right arrow keys on the Installer Remote, or enter a valid value directly. To save the new setting, press **OK**, or use the Up/Down arrow keys to navigate to a new Installer Menu item if you have additional items to edit. Note that invalid values will not be saved.

### Exiting the Installer Menu and Activating Settings

After you have adjusted all required Installer Menu item settings, press **OK** once on the Installer Remote to save your changes; then, press **OK** again to exit the Installer Menu. Any changes you make will be stored in non-volatile memory.

**Note:** Each time you exit the Installer Menu in Pass-through Mode, all V-Chip (Parental Control) settings in the STB are reset to their default values; that is, the Lock System, if previously enabled from the Safety Menu, will now be disabled, and the individual Parental Control settings will be restored to default values.



**Caution: Installer Menu settings may affect options available from the STB setup menus or the Function Menu.**



# Installer Menu (Cont.)

## Installer Menu Items 000 through 069

Item	Function	Value Range	Default Value	Brief Description of Function
000	INSTALLER SEQ	0–3	0	Leave default set to 0.
001	POWER MANAGE	0–7	0	Selects the number of hours of inactivity allowed before the STB automatically turns itself OFF. Set to 0 to disable Power Management.
002	AC ON	0–3	0	Set to 1 to enable STB/display panel to turn ON when AC power is applied. Set to 2 or 3 to enable Instant ON when AC power is applied. (See detailed descriptions.)
003	BAND/AFC	0–3	1	Selects Tuning Band: 0=Broadcast, 1=CATV, 2=HRC, 3=IRC
004	STRT CHANNEL	0–127, 253, 255	255	Channel tuned when STB/display panel is turned ON. (Set to 255 to tune to channel tuned before STB/display turned OFF.)
005	CHAN LOCK	0 / 1	0	If set to 1, cannot tune from current channel.
007	STRT VOLUME	0–63, 255	255	Volume level when STB/display panel is turned ON. (Set to 255 to use volume level before STB/display turned OFF.)
008	MIN VOLUME	0–63	0	Sets minimum allowable volume setting.
009	MAX VOLUME	0–63	63	Sets maximum allowable volume setting.
010	MUTE DISABLE	0 / 1	0	Set to 1 to disable Mute Function.
011	KEY DEFEAT	0 / 1	0	If set to 1, menu navigation buttons/functions on LG Hospitality and commercial non-LG display panels are not functional/available. N/A for LG Public Displays or LG Commercial Monitors.
015	SLEEP TIMER	0 / 1	1	Set to 1 to enable Sleep Timer.
016	EN. TIMER	0 / 1	0	Set to 1 to enable On/Off Timers.
017	ALARM	0 / 1	1	Set to 1 to enable Alarm.
020	FEATURE LEVEL	0, 16–24	0	Determines an additional IR code scheme to which the STB will respond.
021	V-CHIP	0 / 1	1	Set to 1 to enable V-Chip (Parental Control) functions.
022	MAX BLK HRS	0–99	12	Sets number of V-Chip blocking hours.
023	CAPTION LOCK	0 / 1	0	Set to 1 to retain caption setting set before STB/display panel turned OFF.
028	CH. OVERRIDE	0 / 1	1	If set to 0, user access to channel settings in the STB setup menus is restricted and users can only tune to channels that are included in the channel lineup.
029	OLD OCV	0 / 1	0	Set to 1 to remap the PTC's direct tune channels for Aux inputs from 13x to 9x.
030	ACK MASK	0 / 1	0	If set to 1, enables ACK feature of MPI.
031	POLL RATE	20–169	94	Selects poll rate for MPI.
032	TIMING PULSE	186–227	207	Sets baud rate for MPI.
035	HDMI1 ENABLE	0–2	1	Set to 0 to disable HDMI 1. Set to 1 (DTV Mode) or 2 (PC Mode), as applicable, to enable HDMI 1.
039	REAR AUX EN.	0 / 1	1	Set to 1 to enable display panel AV input jack.
041	SIMPLINK EN	0 / 1	0	Determines the status of the SIMPLINK feature. (See detailed descriptions.)
042	AUTO INPUTS	0–255	0	Determines the Aux inputs for which auto-sensing is enabled. (See detailed descriptions.)
046	STRT AUX SRCE	1, 3, 5, 255	255	Sets the starting Aux source (if item 004 STRT CHANNEL is set to 0).
047	AUX STATUS	0 / 1	0	Set to 1 for MPI Aux source to be reported as a channel number instead of Channel 0.
049	DIS. AUDIO M.	0–9*	0	Determines the availability of the Sound Out (Audio) Menu in the STB menus, as well as the default Audio Mode when STB is turned ON. (See detailed descriptions.)
053	DIS. CH-TIME	0 / 1	0	Set to 1 to disable the STB's native Channel-Time display.
069	EN. CH-T COL.	0 / 1	1	Set to 1 to enable custom color for MPI display characters.

\* Values 8 & 9 applicable with PTC v2.00.004 or later.

# Installer Menu (Cont.)

## Installer Menu Items 070 through 118

Item	Function	Value Range	Default Value	Brief Description of Function
070	FOR. CH-TIME	0–7	2	Chooses custom foreground color for MPI display characters.
071	BCK. CH-TIME	0–7	2	Chooses custom background color for MPI display characters.
073	CH NOT AVBLE	0 / 1	0	If set to 1 and item 028 CH. OVERRIDE is set to 0, a “CHANNEL NOT AVAILABLE” message is displayed if user attempts to direct tune a channel that is not included in the channel lineup.
075	REVERT CH	0 / 1	0	If set to 1 and loss of MPI communication occurs, STB tunes to Start Channel.
078	UPN MSB	0–255	0	User programmable number, most significant byte.
079	UPN MSB-1	0–255	0	User programmable number, most significant byte - 1.
080	UPN MSB-2	0–255	0	User programmable number, most significant byte - 2.
081	UPN LSB	0–255	0	User programmable number, least significant byte.
082	CHKSM ERROR	0 / 1	1	Enforces rigid MPI checksum.
083	HANDSHK TIME	0–5	5	Relaxes MPI timing to be compatible with PC-based Windows-controlled systems.
084	PERMANENT BLK	0 / 1	0	Removes block hours setting for Parental Control and makes block permanent.
086	V. MUTE TIME	0–50	0	Use to extend the normal video mute time during channel change.
088	EN NOISE MUTE	0 / 1	1	(Analog channels only) If set to 1, audio is muted if no signal is present.
090	KEY LOCK	0 / 1	1	If set to 1, all LG Hospitality and commercial non-LG display panel button functions are locked. N/A for LG Public Displays or LG Commercial Monitors.
091	HDMI2 ENABLE	0–2	1	Set to 0 to disable HDMI 2. Set to 1 (DTV Mode) or 2 (PC Mode), as applicable, to enable HDMI 2.
094	SAP MENU EN	0 / 1	1	Set to 1 to enable SAP feature in Function Menu.
096	DEF. ASP. RATIO	0–4	2	Sets default aspect ratio at power up. See detailed descriptions and item 106.
097	AUDIO OUTPUT	0, 8, 9*	9	Set as required in accordance with external audio equipment connected to the STB. (See detailed descriptions.)
098	PRO:CENTRIC	0 ~ 3	0	Set to 0 to disable Pro:Centric operation. Set to 1 for Flash Mode. Set to 2 for GEM (Java Application) Mode. Set to 3 for HTML Mode.
100	VIDEO INTERFAC	3–5	3	Selects HDMI connection for display panel: 3 = HDMI1, 4 = HDMI2, 5 = HDMI3
101	IR FEEDBACK	0 / 2	0	Set to 2 to disable the STB's MMR feature.
102	ATSC BAND	0 ~ 4	4	Selects ATSC band.
103	ATSC TUNE MODE	0 / 1	1	Set to 1 (default) for Physical Channel scan. Set to 0 for Virtual Channel scan.
104	START MINOR CH	0–255	0	Selects Minor Start Channel. Set to 0 for NTSC.
105	VID OUT FORMAT	1, 4, 5	1	Sets format for video output: 1 = 720p, 4 = 1080p, 5 = 1366 x 768
106	ASP RATIO LOCK	0 / 1	0	To retain set aspect ratio on power cycle, set to 1. Set to 0 for default ratio on power cycle.
107	BANNER SELECT**	0 / 1	1	Selects the type of banner to display during channel change.
108	PANEL COM	0–3	2	Sets display panel baud rate: 0 = 1200, 1 = 2400, 2 = 9600, 3 = 115200
110	PANEL DELAY	0–15	8	Sets the display panel communication delay time.
111	PANEL VOL PRE	0–100	100	Determines a preset fixed volume level to set in the display panel.
113	PANEL TYPE	0–4	4	Sets display panel communication command set. (See detailed descriptions.)
116	VIDEO MUTE EN	0 / 1	0	(Analog channels only) If set to 1, video mutes (blank screen) when no signal is present.
117	FACT DEFAULT	0 / 1	0	Set to 1 to restore the factory default settings of all Installer Menu items.
118	POWER SAVINGS	1, 3, 7	3	Determines the powered status of the embedded b-LAN module and the EXT MPI CONTROL port. (See detailed descriptions.)

\* Value 8 applicable with PTC v2.00.004 or later.

\*\* Applicable with CPU v4.10.50 or later and PTC v2.00.004 or later.

## Installer Menu Items 119 through 122

Item	Function	Value Range	Default Value	Brief Description of Function
119	DATA CHANNEL	0–135, 253, 255	255	Set to 0 to disable. Set from 1 to 135 to match the RF channel number used by the Pro:Centric server as its data channel. Set to 255 to use Auto Search to find the Pro:Centric RF channel. (See detailed descriptions.)
121	UPDATE TIME HR	0–23, 128	128	Sets the Wake For Update hour. The value “128” is displayed as “OFF.” Directly entering 128 turns the Wake For Update feature OFF.
122	UPDATE TIME MN	0–59, 255	0	Sets the minute for Wake For Update. (See detailed descriptions.)

## Detailed Descriptions of Installer Menu Items

### 000 - INSTALLER SEQUENCE

Specifies entry sequence to the Installer Menu.

0 = 9876                      1 = 4321  
2 = 1478                      3 = 3698

### 001 - POWER MANAGE (Power Management)

Energy saving feature. Determines the number of hours, in the range 1 to 7, of inactivity allowed, either at the display control panel or from the remote, before the STB automatically turns itself OFF. If set to 0, Power Management is disabled.

### 002 - AC ON (AC Power Switchable)

Set to 0 (default) for standard STB/display turn ON/OFF operation.

If set to 1, this allows the STB/display panel to turn ON when AC power is applied. Pressing the POWER button is not necessary. This is desirable if the STB is plugged into a switched AC outlet. Though, with PTC v2.00.004 or later, note that if the Pro:Centric application is loaded (i.e., item 098 PRO:CENTRIC is not set to 0), the STB will reboot and initiate an update event once every 24 hours. During the update event, the STB checks for and downloads any available updates from the Pro:Centric server (item 119 DATA CHANNEL set from 1 to 135 or 253). The time at which this event occurs depends on the setting of item 121 UPDATE TIME HR. See item 119 and 121 descriptions for further information. Once the update cycle is complete, the STB completes the reboot and resumes its ON state.

**Note:** If set to 1, the STB does not respond to ON/OFF commands from the remote, and the SLEEP TIMER is also nonfunctional.

Set to 2 or 3 to enable the Instant ON feature (see additional information below).

The Instant ON feature allows the STB to turn ON when AC power is applied, while the display panel remains OFF. The STB retains its ON status, and the POWER button only toggles the display On and Off.

- If this item is set to 2, the STB will reboot and, if applicable (i.e., item 119 set from 1 to 135 or 253), check for and download any available updates from the Pro:Centric server each time the display panel is turned OFF. This setting is not recommended if the STB will be configured with a resident application.

- If this item is set to 3, the STB will not reboot to check for and download updates each time the display panel is turned OFF, with the following exception: the first time the display is turned OFF after this item is set to 3, the STB will reboot and initiate an update event (Data Channel Auto Search and/or check for and download of updates—see also paragraph below). This setting is recommended if the STB will be configured with a resident application. In this mode, the standard check for and download of updates is under application control. Refer to your site-specific documentation for further information on configuring the STB with a resident application.

When this item is set to 2 or 3, the STB also will reboot and initiate an update event once every 24 hours. During the update event, the STB, as applicable, performs a Data Channel Auto Search (item 119 set to 255) and/or checks for and downloads any available updates from the Pro:Centric server (item 119 set from 1 to 135 or 253). The time at which this event occurs depends on the setting of item 121. See item 119 and 121 descriptions for further information. Once the update cycle is complete, the STB completes the reboot and resumes its ON state with the display panel OFF.

### 003 - BAND/AFC (Band/Automatic Frequency Control)

There are four possible settings for this option:

0 = Broadcast                      1 = CATV (default)  
2 = HRC                              3 = IRC

If some channels were not found by Auto Tuning (Channel Search), select the appropriate Band setting here, and add the channels using the Channel Edit option in the Channel Menu.

### 004 - STRT CHANNEL (Start Channel)

If active, this function allows you to determine the initial Major Start Channel number when the STB/display panel is turned ON. This feature is useful for an in-house information channel, since the STB/display would always select that channel when it is turned ON. If set to 255, the last channel tuned before the STB/display was turned OFF will be the channel tuned when the STB/display is turned ON again.

**Note:** For a digital Start Channel, always remember to set item 104 to the Minor Start Channel number.

# Installer Menu (Cont.)

0 = Aux  
1 ~ 125 = Major Ch. #  
126 = Map to Major CH 3  
127 = Map to Major CH 4  
253 = IP Start Channel  
255 = Last Channel

**Note:** 126 and 127 are mapped only in SONIFI PPV Mode.

**Note:** If setting this item to 0 (Aux), make sure to also set item 046 STRT AUX SRCE to the appropriate value.

**Note:** The IP Start Channel shown above can only be set in the FTG File Manager, which is used to configure STB CPUs for FTG Mode. The same applies for the additional Major Channel number range of 128–135 in Physical tuning and 128–999 in Virtual tuning mode. This means that these values, if set, will only be visible in the read-only Installer Menu when the STB is in FTG Mode. The read-only display also will show additional information about the channel, for example, the IP address and port number, etc.

## 005 - CHAN LOCK (Channel Lock)

Channel Lock is ideal if the system must always be on the same channel. Changing channels with the Channel Up/Down or keypad numbers is impossible. Channel Lock is inactive if set to 0 (default).

Generally, this feature is used in connection with item 004 STRT CHANNEL where the Start Channel may, for example, be set to 3 or 4. If the Start Channel is 3, then the STB will remain locked on channel 3.

### NOTE: For items 007, 008, and 009

For legacy reasons, the scale used is 0–63. The PTC software will translate this to the 0–100 scale used by the STB.

To translate an STB volume level to the Installer Menu value, use the following formula:

$$\text{Installer Value} = \frac{\text{STB Value} \times 63}{100}$$

Enter only the whole number (disregard fractions).

## 007 - STRT VOLUME (Start Volume)

This function allows the Installer to determine the initial volume level setting when the STB/display panel is turned ON. This feature is useful for an in-house information channel, since the STB/display will always select that volume level when it is turned ON. The range of values is 0 to 63, 255. If set to 255, the last volume level before the STB/display was turned OFF will be the current volume level when the STB/display is turned ON again.

## 008 - MIN VOLUME (Minimum Volume)

This function determines the minimum volume level allowable with the Volume (VOL) Up/Down control. In this way, for example, someone cannot set the volume too low to hear. The value range is from 0 to 63. The factory default is 0, which provides the full range of volume control, if item 009 MAX VOLUME is set to 63. It is recommended to set the same value on every STB.

**Note:** The minimum volume level cannot have a value setting higher than the maximum volume level (described below).

## 009 - MAX VOLUME (Maximum Volume)

This function determines the maximum volume level allowable with the Volume (VOL) Up/Down control. In this way, for example, someone cannot set the volume level high enough to disturb others. The value range is 0 to 63, with 63 as the default, which gives the user the full range of volume control, if item 008 MIN VOLUME is set to 0. It is recommended to set the same value on every STB.

**Note:** The maximum volume level cannot have a value setting lower than the minimum volume level (described above).

## 010 - MUTE DISABLE

Enables or disables sound mute function. If set to 1, sound cannot be muted. If set to 0, sound can be muted.

## 011 - KEY DEFEAT

Applicable for LG Hospitality and commercial non-LG display panels only. If set to 1, Key Defeat is enabled, which means that end users cannot access or navigate within the STB's on-screen menu(s) from the display panel; i.e., menu navigation buttons will not function. Set to 0 to disable Key Defeat. Note that all IR features remain functional regardless of this setting; users can always access the STB's menus by pressing MENU on the remote.

**Note:** This feature does not apply to LG Public Displays or LG Commercial Monitors since the STB will always disable those displays' panel buttons and the processing of IR.

## 015 - SLEEP TIMER

If set to 1, the Sleep Timer feature may be used. If set to 0, the Sleep Timer is not available.

## 016 - EN. TIMER (Enable On/Off Timers)

If set to 1, the Timer function is available to the end user and enabled continuously. Set to 0 to disable On/Off timers.

**Note:** The STB clock must be set in order for timers to be used.

## 017 - ALARM

Gives the installer the option of making the Alarm function available to the end user. If set to 1, the Alarm function is available to the end user. Set to 0 to disable the Alarm function.

**Note:** The STB clock must be set before the Alarm function will work.

## 020 - FEATURE LEVEL

Determines an additional IR code scheme to which the STB will respond, allowing for the use of unique IR codes based on "bed number" in a multi-STB/display single room installation. First determine the IR mode; then select the bed number.

Values	IR Mode	Bed #
0	Disabled	N/A
16–24	Multi-code Remote	1–9

**Note:** The STB-dedicated Installer Remote is required for use of this feature. For further information, see Reference section, "STB Installer Remote."

## 021 - V-CHIP (Parental Control)

Set to 1 to activate V-Chip (Parental Control) and have it available to the end user to filter and control or otherwise restrict programming content that can appear. Set to 0 to turn the V-Chip feature Off (not available to user); no programming restrictions can be set.

## 022 - MAX BLK HRS (Maximum Block Hours)

Sets hours from 0 to 99 for the maximum V-Chip (Parental Control) block hours. Default setting is for 12 blocking hours.

**Note:** This item is not available in the Installer Menu when item 021 V-CHIP is set to 0 or when item 084 PERMANENT BLK is set to 1.

## 023 - CAPTION LOCK

If set to 0, captions are OFF when the STB/display panel is turned ON. Set to 1 to use the caption setting configured before the STB/display was turned OFF when the STB/display is turned ON.

## 028 - CH. OVERRIDE (Channel Override)

This item either allows or restricts tuning of channels that are NOT in the PTC Channel Map. If set to 1, end users can tune channels that are not in the PTC Channel Map by direct keypad entry. If set to 0, users are restricted to only the channels that are in the PTC Channel Map. In the case of CPU-CTV Mode, there are no channels in the PTC Channel Map; therefore, direct keypad entry is not available. Also, when this item is set to 0, the PTC Channel Map (PTC-CTV Mode)/CPU channel lineup (CPU-CTV Mode) is locked, and user access to channel settings in the STB setup menus is restricted.

**Note:** This item is not applicable when the STB is in FTG Mode.

## 029 - OLD OCV (On Command Video™)

Set to 1 to remap the PTC's direct tune channels for Aux inputs from 13x to 9x. This allows 2-digit only tuning systems (i.e., legacy OCV) to direct tune Aux inputs. See also Reference section, "STB Aux Input Configuration."

## 030 - ACK MASK

MPI Communication Parameter. When set to 1, enables ACK feature of MPI.

## 031 - POLL RATE

MPI Communication Parameter. Selects poll rate for MPI. Step size of 16 ms. Changing from default may affect communication via MPI.

## 032 - TIMING PULSE

MPI Communication Parameter. Sets baud rate for MPI. Step size of 4.3 uS. Changing from default may affect communication via MPI.

## 035 - HDMI1 ENABLE

Set to 1 to enable HDMI 1 input in DTV Mode. Set to 2 to enable HDMI 1 input in PC Mode. Set to 0 to disable display panel HDMI 1 input.

## 039 - REAR AUX EN. (Rear Aux Enable)

Set to 1 to enable display panel rear Aux (AV) input. Set to 0 to disable display panel rear Aux (AV) input.

## 041 - SIMPLINK EN

Set to 0 to disable the SIMPLINK feature. Set to 1 to enable SIMPLINK functionality (does not enable remote control access to the SIMPLINK Menu).

**Note:** When both this item *and* item 042 AUTO INPUTS are enabled in the Installer Menu, HDMI inputs will be detected by SIMPLINK, but the Auto Input(s) Sensing Feature will not function.

## 042 - AUTO INPUTS

Determines the Aux inputs for which auto-sensing is enabled. Set to 0 to disable auto-sensing for all available inputs. Set to 255 to enable auto-sensing for all available inputs. For information on options for individual input settings, see Reference section, "Auto Input(s) Sensing Feature."

**Note:** In order for auto-sensing to be enabled for an input, that input must also be enabled in the Installer Menu. For example, to enable auto-sensing for HDMI 1, item 035 HDMI1 ENABLE must also be set to 1 or 2. Also, see note above regarding STB operation when both this item and item 041 SIMPLINK EN are enabled.

## 046 - STRT AUX SRCE (Start Aux Source)

Sets the starting Aux source. When turned ON, the STB/display panel will tune to starting Aux source if item 004 STRT CHANNEL is set to 0.

1 = AV	3 = HDMI 1
5 = HDMI 2	255 = Last Aux (default)

**Note:** Above is applicable only if all Aux sources are enabled.

**Note:** This item is not available in the Installer Menu unless item 004 STRT CHANNEL is set to 0.

## 047 - AUX STATUS

Set to 1 for MPI Aux source to be reported as a channel number instead of channel 0. Set to 0 to disable Aux identification change. Controls MPI status channel response for Aux inputs.

## 049 - DIS. AUDIO M. (Disable Audio Menu)

Determines the availability of the Sound Out (Audio) Menu in the STB menus. Also determines the default Audio Mode when STB is turned ON. See the table below and set as required.

**Note:** If a SIMPLINK-enabled device is connected to the STB and item 041 SIMPLINK EN is set to 1 (enabled), the SIMPLINK device Audio Mode will have priority over the setting of this item when the STB/display is turned ON.

**Note:** When this item is set to 6 or 7, the Bluetooth Sound Sync Media Share feature is not available. If Bluetooth Sound Sync is currently enabled in the IP Environment / Media Share Menu, it will be disabled.

# Installer Menu (Cont.)

Value	Sound Out Menu Status	Default Audio Mode at STB Turn ON
0 (default)	Enabled	Display Speaker
1	Disabled	Display Speaker
2	Enabled	External Speaker (Optical**/HDMI ARC**)
3	Disabled	External Speaker (Optical**/HDMI ARC**)
4	Enabled	LG Sound Sync (Optical**)
5	Disabled	LG Sound Sync (Optical**)
6	Enabled	LG Sound Sync (Wireless**)
7	Disabled	LG Sound Sync (Wireless**)
8*	Enabled	Display Speaker + Audio Out (Optical**)
9*	Disabled	Display Speaker + Audio Out (Optical**)

\* Values 8 & 9 only applicable with PTC v2.00.004 or later.

\*\* Connect to/via STB.

## 053 - DIS. CH-TIME (Disable Channel-Time Display)

Set to 1 to disable the STB's native Channel-Time display, when a custom channel label/channel information will be provided by the MPI command. Set to 0 to enable the STB's native Channel-Time display.

## 069 - EN. CH-T COL. (Enable Display Characters Custom Color)

Set to 1 to enable custom color for MPI display characters. Set to 0 to disable custom color for MPI display characters.

## 070 - FOR. CH-TIME (Display Characters Foreground Color)

Set the foreground color for MPI display characters according to the following color chart:

0 = Black      2 = Green      4 = Red      6 = Yellow  
1 = Blue      3 = Cyan      5 = Violet      7 = White

If foreground color and background color for display characters are the same, the background will be transparent.

**Note:** This item and item 071 BCK. CH-TIME also apply to the "Channel Not Available" message if item 073 CH NOT AVBLE is set to 1 (enabled).

**Note:** Items 070 FOR. CH-TIME and 071 BCK. CH-TIME are only available in the Installer Menu when item 069 EN. CH-T COL. is set to 1.

## 071 - BCK. CH-TIME (Display Characters Background Color)

See description for item 070 FOR. CH-TIME above. The color chart is the same for both items.

## 073 - CH NOT AVBLE (Channel Not Available)

If set to 1 and item 028 CH. OVERRIDE is set to 0, a "CHANNEL NOT AVAILABLE" message is displayed when a user attempts to direct tune a channel that is not included in the channel lineup.

**Note:** This item is not available in the Installer Menu when item 028 CH. OVERRIDE is set to 1.

**Note:** This item is only applicable when the STB is in PTC-CTV Mode.

## 075 - REVERT CH (Revert to Start Channel)

If set to 1 and loss of MPI communication occurs, the STB automatically tunes to the specified Start Channel.

**Note:** This item is not available in the Installer Menu when item 004 STRT CHANNEL is set to 255.

## 078 - UPN MSB (UPN Most Significant Byte)

User programmable number, most significant byte readable by MPI command. Note: Not linked to serial number.

## 079 - UPN MSB-1 (UPN Most Significant Byte-1)

User programmable number, most significant byte-1 readable by MPI command. Note: Not linked to serial number.

## 080 - UPN MSB-2 (UPN Most Significant Byte-2)

User programmable number, most significant byte-2 readable by MPI command. Note: Not linked to serial number.

## 081 - UPN LSB (UPN Least Significant Byte)

User programmable number, least significant byte readable by MPI command. Note: Not linked to serial number.

## 082 - CHKSM ERROR (Checksum Error)

Enforces rigid MPI checksum validation. Set to 1 for validation. Set to 0 to disable (does not check checksum on MPI async port). SPI is always checked.

## 083 - HANDSHK TIME (Handshake Time)

Adds an additional delay to the handshake time which is 64 msec, thus relaxing MPI timing requirements to be compatible with PC-based Windows controlled systems. Range is 0 - 5. (Timeout = 25.5MS + [25.5 MS\* Handshake time].)

## 084 - PERMANENT BLK (Permanent Block)

Allows Lock (Parental Control) blocking schemes to be permanent by disabling the blocking hours function. Set to 1 to install Parental Control restrictions permanently. Set to 0 for user-specified hours control of blocking schemes.

**Note:** This item is not available in the Installer Menu when item 021 V-CHIP is set to 0.

## 086 - V. MUTE TIME (Video Mute Time)

Use to extend the normal video mute time during channel change. For example, you may wish to extend the normal video mute time to prevent the display of encrypted video (i.e., from a Pro:Idiom encrypted channel) that has not yet been decrypted. When set to 0, the normal video mute time is not extended. Set from 1 to 50 to increase the normal video mute time in 100 ms step increments up to a maximum of 5 seconds (e.g., the value of 25 represents 2.5 seconds, or 25 x 100 ms = 2.5 seconds).

## 088 - EN NOISE MUTE (Enable Noise Mute)

Applicable for analog channels only. If set to 1, audio mutes if no signal is present.

## 090 - KEY LOCK

Applicable for LG Hospitality and commercial non-LG display panels only. If set to 1 (default), Key Lock is enabled, which means that all display panel button functions will be locked, i.e., non-functional. Set to 0 to disable Key Lock.

**Note:** This feature does not apply to LG Public Displays or LG Commercial Monitors since the STB will always disable those displays' panel buttons and the processing of IR.

## 091 - HDMI2 ENABLE

Set to 1 to enable HDMI 2 input in DTV Mode. Set to 2 to enable HDMI 2 input in PC Mode. Set to 0 to disable display panel HDMI 2 input.

## 094 - SAP MENU EN (2nd Audio Program)

Set to 1 to enable the SAP feature in the Function Menu, when the Function Menu is available (i.e., STB is not in Pass-through Mode). Set to 0 to disable the SAP feature in the Function Menu, when the Function Menu is available.

## 096 - DEF. ASP. RATIO (Default Aspect Ratio)

Selects default aspect ratio at power up:

0 = Set By Program            1 = 4:3  
2 = 16:9 (default)            3 = Just Scan  
4 = Zoom

**Note:** This item is not available in the Installer Menu unless item 106 ASP RATIO LOCK is set to 0.

## 097 - AUDIO OUTPUT

(Value 8 only applicable with PTC v2.00.004 or later) Determines availability of the analog audio output to be used by external audio equipment connected to the Audio Line Out jack on the STB. Set to 0 to disable audio output. Set to 8 to enable volume control of audio output. Set to 9 (default) to enable fixed line level (typically 400 mVrms ± 100 mVrms @10KΩ) output. See also Reference section, "External Audio Line Out Specifications."

## 098 - PRO:CENTRIC

Selects the Pro:Centric Application Mode. Set to 0 (default) to disable the Pro:Centric application. Set to 1 for Flash Mode. Set to 2 for GEM (Java Application) Mode. Set to 3 for HTML Mode.

In order to retrieve the Pro:Centric application, when enabled (for Flash, GEM, or HTML Mode), the STB must be turned OFF/ON two times. Once you exit the Installer Menu, turn OFF the STB/display panel for at least one minute. When you turn the STB/display back ON, the STB will start the appropriate library based on the setting of this item. Wait until TV programming appears on the display, and then turn the STB/display back OFF, this time for a few minutes, to initiate the application download. When you turn the STB/display back ON, press the PORTAL key on the Installer Remote, and verify that the Pro:Centric application appears on the display.

**Note:** This item is not available in the Installer Menu when item 119 DATA CHANNEL is set to 0.

## 100 - VIDEO INTERFAC

Selects the HDMI port on the display panel to be used for HDMI input from the STB. Set to 3 for HDMI 1 (default). Set to 4 for HDMI 2. Set to 5 for HDMI 3.

If you change the value of this item, make sure to reconnect the HDMI cable from the STB to the appropriate HDMI port on the display panel once you have exited the Installer Menu.

## 101 - IR FEEDBACK

If set to 0, the STB's MMR (Magic Motion Remote) feature is enabled (default), and a compatible LG MMR (not supplied) may be used with the STB. If set to 2, the MMR feature is disabled.

## 102 - ATSC BAND

Sets up STB to receive different types of incoming signals.

0 = Broadcast            1 = CATV            2 = HRC  
3 = IRC                    4 = Same as NTSC

## 103 - ATSC TUNE MODE

Sets ATSC tuning mode. Default set to 1 for Physical Channel scan. Set to 0 for Virtual Channel scan.

## 104 - START MINOR CHANNEL

Sets Minor Start Channel number at power up. 0 = NTSC. If not 0, number selected is the digital channel's Minor Start Channel number.

**Note:** This item is not available in the Installer Menu when item 004 STRT CHANNEL is set to 0 or 255.

## 105 - VID OUT FORMAT

Selects the format for video output (i.e., the resolution):

1 = 720p (default)            4 = 1080p            5 = 1366 x 768

If you change the video output format on location, once you exit the STB Installer Menu, a Changing Video Output Resolution pop-up banner will appear at the bottom of the display screen, and then the STB will reboot to change the resolution per your selection. When the reboot is complete, a confirmation pop-up banner for the new video output resolution will be displayed. To confirm the new video output resolution, use the arrow keys on the Installer Remote to select **YES** in the confirmation banner, and then press **OK** on the Installer Remote.

If there is no user interaction within 10 seconds of the prompt for confirmation, or if you select "NO" in the confirmation banner, the STB will reboot and revert to the former resolution.

**Note:** If this item is updated via a Clone/Configuration (.tlx) file loaded on a Pro:Centric server, no confirmation is required.

**Note:** If the STB is currently in FTG Mode via EBL and you wish to change the video output format, this may only be accomplished via local configuration. Do NOT attempt to change this setting using broadcast configuration of the EBL via FMA, as confirmation of the new video output resolution will be required at each STB—as described above. See Reference section, "FTG Mode via EBL (Local Configuration)," for information on local configuration.

# Installer Menu (Cont.)

---

**Note:** Refer to documentation for the applicable display panel(s) to determine the appropriate resolution setting. The selected resolution should be compatible with the display panel's native video output resolution. If necessary/desired, you can use TV Zone designations to create multiple profiles to differentiate item 105 settings by display panel brand. See Reference section, "Using the STB's Zoning Features," for further information on TV Zones.

## 106 - ASP RATIO LOCK (Aspect Ratio Lock)

Set to 1 to retain previous aspect ratio with power off. Set to 0 to retain default aspect ratio with power off. See item 096 DEF. ASP. RATIO above.

## 107 - BANNER SELECT

(Applicable with CPU v4.10.50 or later and PTC v2.00.004 or later) Selects the type of banner to display during channel change. Set to 1 for channel label display, plus channel information (full banner). Set to 0 for channel label display only (small banner).

## 108 - PANEL COM (Panel Communication)

Sets the display panel baud rate:

0 = 1200	1 = 2400
2 = 9600 (default)	3 = 115200

## 110 - PANEL DELAY

After the STB sends the turn ON command to the display panel, the display panel requires time to complete its power on sequence before it begins accepting commands from the STB. This item sets the time, in seconds, to delay the STB's initial communication with the display panel. The default value is 8 seconds.

**Note:** The amount of time required for the display's power on sequence varies by display panel brand/model. Thus, depending on the brand/model of display panel connected to the STB, you may be able to decrease or you may need to increase the Panel Delay value, accordingly. For example, if you are using the STB with an LG PW1000 or PW1500 projector, it is recommended that you set the delay to 10 or more seconds.

**Note:** This item does not apply to LG Hospitality display panels.

## 111 - PANEL VOL PRE (Panel Volume Preset)

Determines a preset fixed volume level (gain) to set in the display panel. The audio signal (volume level) is dynamically controlled in the STB. The default value is 100 to provide a typical 1:1 ratio of volume level to sound output when the STB is connected to an LG display panel.

**Note:** Sound output may vary by display panel brand/model. Thus, depending on the brand/model of display panel connected to the STB, you may need to adjust the preset volume level to achieve the desired sound output.

## 113 - PANEL TYPE

Sets the TLM command set to communicate with the display panel. This setting is only applicable for LG Public Display TVs and Commercial Monitors that use the RS-232C TELEVISION CONTROL port for STB-to-display panel communication. The default value (4) will be appropriate for most current display models. See Reference section, "Display Panel Specifications," to determine the appropriate setting for the display panel being used.

## 116 - VIDEO MUTE EN (Video Mute Enable)

Applicable for analog channels only. If set to 1, video mutes (blank screen) when no signal is present.

## 117 - FACT DEFAULT (Factory Default)

Set to 1 and press OK to restore the factory default settings of all Installer Menu items. Once complete, the value returns to 0.



**Caution: If set to 1, this clears all STB Installer Menu custom settings and restores the factory default settings. It also clears the channel lineup, including any assigned channel icons and custom text labels.**

**Note:** See also Reference section, "Restoring Factory Defaults on the STB(s)," for further information.

## 118 - POWER SAVINGS

Default set to 3—the power circuitry for both the embedded *b*-LAN module and the EXT MPI CONTROL port is only powered when the TV is turned ON. When the TV is turned OFF, the embedded *b*-LAN and the EXT MPI CONTROL port are not powered.

Note that the TV must be turned ON in order to communicate with the embedded *b*-LAN module for configuration and control when POWER SAVINGS is set to 3. If POWER SAVINGS is set to 1, the *b*-LAN module is always powered.

Similarly, if MPI communication is required for external MPI control, POWER SAVINGS should be set to 1 so that the EXT MPI CONTROL port circuitry is always powered.

**Note:** See Reference section, "*b*-LAN Setup & Overview," for further information.



**Caution: POWER SAVINGS should NEVER be set to 7. This setting is intended for factory use only.**

## 119 - DATA CHANNEL

Set to 0 to disable. Set from 1 to 135 to match the RF channel number that will be used by the Pro:Centric server as its data channel.\*

For STBs in Pass-through Mode or FTG Mode via CPU, if left at the default value (255), the STB's Data Channel Auto Search feature will be enabled (see additional information below).

\* PCS150R and later Pro:Centric servers do not support HRC or IRC cable channel frequencies.



**Note:** The Data Channel Auto Search feature is not available when the STB's EBL is in FTG Mode. If the DATA CHANNEL value is 255 when the STB is configured for FTG Mode via EBL, DATA CHANNEL is defaulted to 0.

Data Channel Auto Search feature: When this item is set to 255 (default), once every 24 hours, the STB will initiate a search of 10 predefined channels (10, 20, 30, ... 100) and then, if necessary, perform a complete search of the RF channels (1 to 135) in an attempt to find the RF channel used by the Pro:Centric server as its data channel. If the Pro:Centric RF channel is found, the DATA CHANNEL value will be changed from 255 to match the server's RF channel number. The time at which the Auto Search occurs depends on the setting of item 121 UPDATE TIME HR. See item 121 description for further information.

**Note:** Pro:Centric updates are downloaded from the Pro:Centric server to the STB when the STB/display panel is turned OFF. While Pro:Centric updates are in progress, it is not possible to turn ON the STB/display.

**Note:** The Data Channel is automatically set to "253" if Media Type is set to "IP" either in the EZ-Manager Wizard or in the STB's IP Environment / Pro:Centric Menu (see "EZ-Manager Wizard" on pages 17 to 26 or "Pro:Centric Setup" on pages 62 to 63, respectively) or if Installer Menu item #119 Data Channel is set to "IP Address" in the FTG File Manager, which is used to configure STB CPUs for FTG Mode operation. It is not possible to change the value to "253" directly in the Installer Menu.

## 121 - UPDATE TIME HR

Based on the settings of this item and item 122 UPDATE TIME MN, the Wake For Update feature wakes the STB once daily to check for and, if applicable, download updates from the Pro:Centric server.

Set the Wake For Update hour from 0 to 23. This item uses the 24-hour clock format. The value "128" (default) is displayed as "OFF." Directly entering 128 resets the default value (OFF) for this item, though note that this setting does not mean the STB will not initiate update events—see additional information below.

Under standard STB/display panel OFF/ON operating conditions (i.e., item 002 AC ON is set to 0), a Wake For Update event occurs when the STB/display is OFF and causes the STB to temporarily turn ON, perform the update cycle, and then turn back OFF, all while the display remains OFF. If item 002 AC ON is set to 2 or 3 for Instant ON, then the STB is always ON and Wake For Update occurs when the display is OFF. The Wake for Update event causes the STB to reboot in order to perform the update cycle and then return to its ON state with the display panel OFF. See also description for item 002.

Random Distribution of Update Time: If this item is set to 128 (OFF), the time at which a Data Channel Auto Search (item 119 set to 255) and/or an Instant ON update (item 002 set to 2 or 3) occurs is determined as follows: Each STB initiates the search and/or checks for updates during the 2 AM hour (if the STB clock is set) or after two hours of elapsed time from when AC power was applied (if the STB clock is not set). Also, in this case, a fixed update time minute from 0 to 59 that has been assigned to each STB is used. (The intention of this feature is to prevent all of the installed STBs from performing updates at the same time; however, note that in installations that have a large quantity of STBs with this feature, there will be some STBs that have the same update minute assignments.) The update time for the STB is displayed at the right of this item in the Installer Menu, for example:

121 UPDATE TIME HR OFF 02:34

If the display is ON when a Wake For Update is to occur, the update will take place the next time the display is turned OFF.

**Note:** This item is not available in the Installer Menu when item 119 DATA CHANNEL is set to 0, except when item 002 AC ON is set to 2 or 3 for Instant ON.

**Note:** The STB clock must be set in order for a Wake For Update event to occur at the precise time of day in accordance with item 121 and item 122 settings.

## 122 - UPDATE TIME MN

Set the Wake For Update minute from 0 to 59. If item 121 is NOT set to 128 and you wish to invoke the "random" minute assignment on the STB, set this item to 255. See also description for item 121 UPDATE TIME HR above.

**Note:** This item is not available in the Installer Menu unless item 121 UPDATE TIME HR is set from 0 to 23.

**Note:** The STB clock must be set in order for a Wake For Update event to occur at the precise time of day in accordance with item 121 and item 122 settings.

# Custom Master STB Setup

---

This section describes how to create a customized Master STB Setup for cloning purposes when the STB is in Pass-through Mode. All cloning (export and import) processes on the STB are performed via USB memory device / “.tlx” file. The Master STB Setup may be exported to a Clone (.tlx) file, which can then be used (i.e., imported) to configure either STBs that are to remain in Pass-through Mode or STBs that are to be configured for FTG Mode.

Cloning requirements and procedures are described in detail on pages 45 to 51.

**Note:** You can also use the FTG File Manager to create an FTG Configuration (.tlx) file for FTG Mode via CPU configuration/cloning purposes, if desired (see pages 52 to 53). However, it is not possible to customize STB setup menu settings in the FTG File Manager. If you wish to include customized STB setup menu settings in the STB configuration, in addition to the channel lineup and Installer Menu settings, perform the Master STB Setup procedure to create a Clone (.tlx) configuration file.

## Before You Begin

- It is recommended that you disconnect all Aux inputs if you intend to run Auto Tuning (Channel Search). Under certain conditions, Auto Tuning is disabled if there is an Aux input active.
- A Clone (.tlx) file comprises Installer Menu settings, IP Environment Menu settings (with the exception of unique STB attributes and settings), and all STB sources’ (analog, digital, AV1, HDMI, etc.) clonable setup menu settings. See also “Clonable STB Setup Menu Features” list below.
- If the “.tlx” file (either a Clone or FTG Configuration file) to be imported on the Target STB(s) contains an FTG Channel Map, the Target STB(s) will be configured for FTG Mode via CPU after, though as part of the import process, depending on the types of channels included in the Channel Map, you may have the option to select either logical or physical channel tuning. If you would like the Target STB(s) to remain in Pass-through Mode, the “.tlx” file should not include an FTG Channel Map.

## Clonable STB Setup Menu Features

<b>Sound</b> Sound Out	<b>General</b> Language Time & Date – Clock Mode (Auto/Manual) – Time Zone Timers (No Signal Power Off) SIMPLINK	<b>Accessibility</b> Pointer Options Closed Captions Audio Guidance
<b>Channels</b> Channel Tuning Channel Manager Channel Label		

**Note:** Some menu options vary between analog and digital channels and Aux inputs.

**Note:** The Quick Settings Menu is initially displayed when you press the **MENU** key on the Installer Remote. Select the **Advanced** ⓘ menu icon to access the advanced STB setup menus. Several advanced settings are duplicated in the Quick Settings Menu.

## Custom Master STB Setup Procedure

### 1. Turn ON the STB/display panel.

The next step depends on whether the EZ-Manager Wizard appears on the screen when you turn ON the STB/display:

- If the wizard is displayed, the STB is in the required factory default state. Exit the wizard, and then continue with step 2.
- If the wizard is not displayed, restore the STB to a factory default condition before continuing with this procedure. See Reference section, “Restoring Factory Defaults on the STB(s),” as necessary, for further information.

### 2. Set Installer Menu items.

This step provides specific instruction only on the Installer Menu items that should be set on a Master STB. Refer to pages 31 to 41 for detailed information on all Installer Menu items.

- a) Use the Installer Remote to access the PTC Installer Menu (see “Accessing the Installer Menu” on page 31 for further information).
- b) Set Installer Menu item **003 BAND/AFC**, as appropriate.
  - Broadcast: Set to 0.
  - CATV: Set to 1 (default).
  - HRC: Set to 2.
  - IRC: Set to 3.
- c) Set any other Installer Menu items that affect your TV programming network to the required configuration. For example, set the panel display type (if applicable), enable/disable Aux inputs, set a Start Channel, etc.
- d) After you have adjusted all Installer Menu item settings as required, and if you do not need to configure any IP Environment settings (see note below), press **OK** once on the Installer Remote to save your changes; then, press **OK** again to exit the menu.

**Note:** If you intend to configure settings in the IP Environment Menu, which is accessible from the Installer Menu, you can proceed directly to step 3. All Installer Menu settings will be saved automatically when you access the IP Environment Menu.

### 3. Configure IP Environment settings.

**Note:** You cannot return directly to the Installer Menu from the IP Environment Menu; thus, you may wish to set all Installer Menu items as needed before you access the IP Environment Menu. Otherwise, you will need to reaccess the Installer Menu to set additional items.

Navigate to Installer Menu item 119 DATA CHANNEL, and press **2-5-3 + MENU** to launch the IP Environment Menu. Then, complete network configuration as required. In particular, if you intend to use the Wi-Fi Zoning feature, you must configure the wireless network connection as part of the Master STB Setup. See “IP Environment Setup” on pages 58 to 65 for further information.

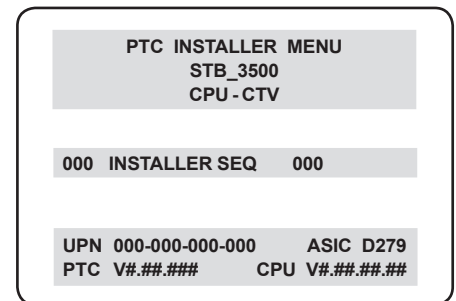

Typical Installer Menu

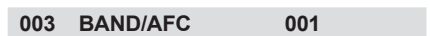

Adjust the value for this Installer Menu item, as required.

(Continued on next page)

# Custom Master STB Setup (Cont.)

(Continued from previous page)

## 4. Set up STB/display panel features.

On-screen setup menus control the features of the STB/display. Press **MENU** on the Installer Remote, and select the **Advanced**  menu icon from the Quick Settings Menu to access the advanced STB setup menus. Then, set Picture, Sound, Channels, etc. options to the desired configurations. See “Clonable STB Setup Menu Features” list on page 42 and also notes below.

**Note:** If you intend to use the Zoning feature(s) on this STB, make sure to assign the appropriate TV Zone # and/or Wi-Fi Zone # at this time as described in Reference section, “Using the STB’s Zoning Features.”

**Note:** If desired and if appropriate, you can run Auto Tuning (see step 5) prior to completing this step.

## 5. (Optional) Run Auto Tuning.

If you are creating a Master STB Setup for cloning purposes and you want the Target STB(s) to remain in Pass-through Mode, do NOT run Auto Tuning. If you export a Master STB Setup that includes an auto-tuned/edited channel lineup, thereby creating a Clone (.tlx) file with an FTG Channel Map, and then import the Clone file to a Target STB, this will put the Target STB in FTG Mode via CPU.

**Note:** When you import a Clone/Configuration (.tlx) file that contains an FTG Channel Map on a Target STB (for FTG Mode via CPU configuration), depending on the types of channels included in the Channel Map, you may have the option to select either logical or physical channel tuning. For either selection, the channel sequence will be based on the order in which the channels appear in the FTG Channel Map. You can view and/or edit the channel sequence in the FTG File Manager, as required.

- a) Use the Installer Remote to access the Channels Menu. Then, select **Channel Tuning** and follow the on-screen instructions to search for all available analog and digital channels.
- b) Use the **Channel Manager** option in the Channels Menu to edit the channel lineup, as necessary. Add/delete channels per your system requirements.

## 6. Verify the STB/display panel setup.

Make sure the STB/display features are set per your requirements. Also, if applicable, verify that the channel lineup is correct.

The Master STB Setup is now ready to be saved (exported) to a USB memory device. See “Cloning Procedures” on pages 45 to 51.

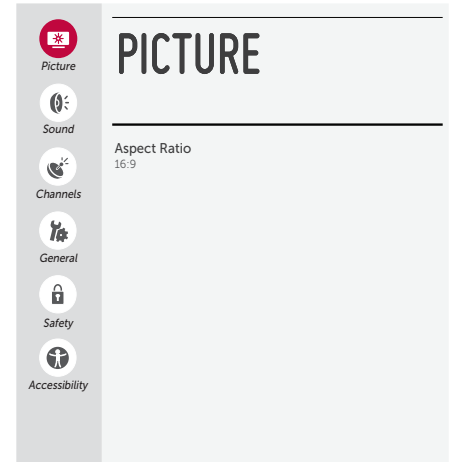

Use the STB setup menus to set the display features to the desired configuration for the end user. This example illustrates the advanced STB setup menus.

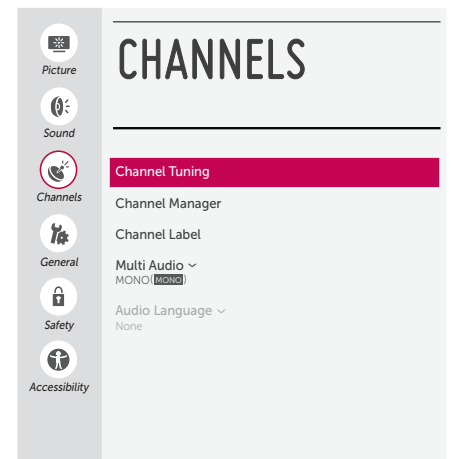

(Optional) Use Channels Menu options to run Auto Tuning and edit the channel lineup.

Cloning typically refers to the process of using a Master STB Setup to configure a Target STB. This section describes how to save (export) a Master STB Setup and transfer (import) it to a Target STB using a USB memory device / Clone (.tlx) file.

You can also create an FTG Configuration (.tlx) file using the FTG File Manager and then use the Import Clone File procedure to transfer the configuration to Target STBs. Refer to “Creating an FTG Configuration File” on pages 52 to 53, as necessary.

## Exporting a Clone File

This section describes how to use the STB Manager “Export Clone File” option to export Master STB Setup configuration to a USB memory device / Clone (.tlx) file.

### Before You Begin

- Ensure the USB device has been formatted with FAT format.
- If the STB is not already in FTG Mode via CPU, complete the Custom Master STB Setup procedure (see pages 42 to 44).
- If you would like the Target STB(s) to remain in Pass-through Mode after the Clone file is imported, ensure the Master STB does not have an auto-tuned/edited channel lineup; otherwise, importing the exported file will result in the Target STB(s) being configured for FTG Mode via CPU.
- If you intend to use the STB Zoning feature(s), make sure to assign the appropriate TV Zone # and/or Wi-Fi Zone # as described in Reference section, “Using the STB’s Zoning Features,” BEFORE performing the procedure below. Also, for Wi-Fi Zoning in particular, the STB’s wireless network connection settings should be configured in the IP Environment Menu before exporting is initiated.
- It is not possible to clone a Master STB’s clock. Either set a Target STB’s clock manually, or use the Auto Clock setting in the STB setup menus.
- Since the Expert Clone File process retrieves the channel lineup from the CPU, if the STB is currently in FTG Mode via EBL (FTG Channel Map resides in EBL), it is not possible to export an FTG Channel Map.



**Caution: Do not unplug the STB power cord or remove the USB memory device while exporting is in progress, as doing so may cause the STB to malfunction or harm the USB device, respectively.**

### Export Clone File Procedure

1. Ensure the Master STB/display panel is set up completely and turned ON.
2. Insert the USB memory device into either of the USB ports on the Master STB.
3. Press **MENU** on the Installer Remote to display the STB setup menus (STB is in Pass-through Mode) or the Function Menu (STB is already in FTG Mode).
4. (STB in Pass-through Mode only) From the Quick Settings Menu displayed at the right of the screen, select the **Advanced**  menu icon and press **OK** to access the advanced STB setup menus.

(Continued on next page)

# Cloning Procedures (Cont.)

(Continued from previous page)

5. Use the arrow navigation keys to select/highlight either the **General** menu icon from the STB setup menus or the **Safety** menu icon from the Function Menu. Then, press the number “7” key a total of seven times to display the STB Manager.

**Note:** Ez Download is always selected by default when you initially access the STB Manager. Also, note that Diagnostics is for service use only.

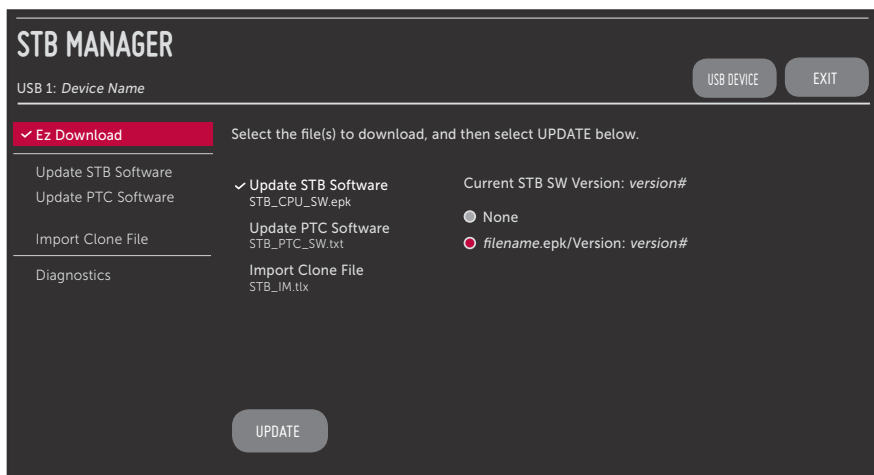

6. If more than one USB memory device is currently connected to the STB, be sure to select the USB device on which you wish to save the Clone file. If necessary, use the arrow keys on the Installer Remote to select/highlight the **USB DEVICE** button in the top right corner of the screen and press **OK**. Then, use the Up/Down arrow keys to select the appropriate USB device from the pop-up list of USB devices displayed at the top of the screen.



7. To gain access to the “Export Clone File” option in the STB Manager, key in the following number sequence on the Installer Remote: **9-8-7-6**.
8. Use the Up/Down arrow keys to select **Export Clone File**, and then press **OK**. Clone filename parameters will be displayed on the screen (see example on following page).
9. Modify the filename, as required. While the STB model element of the filename may not be changed, you can differentiate this Clone file from other STB-3500 Clone files by changing the numeric assignment appended to the end of the filename. Select/highlight the filename, and then use the Up/Down arrow keys on the Installer Remote to scroll through numeric assignments until the desired number is shown.

(Continued on next page)

(Continued from previous page)

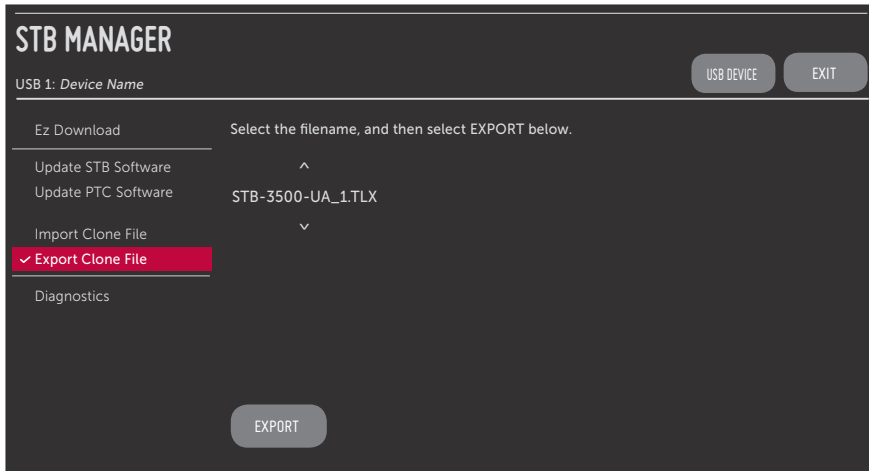

10. When you are ready to continue, i.e., when you have selected the desired filename, press **OK** on the Installer Remote to select/activate the **EXPORT** button at the bottom of the screen, and then press **OK** on the Installer Remote once more to export the file.

Export progress will be displayed on the screen. This process may take a few minutes. Do NOT remove the USB device while exporting is in progress. When the export process is complete, an EXPORT COMPLETE pop-up banner will be displayed at the bottom of the screen.

11. Press **OK** to return to STB Manager screen. To return to program viewing, select **EXIT** at the top right corner of the screen.
12. Remove the USB memory device from the Master STB.

 **Note:** If the Master STB has a channel lineup, during the export process, logical channel numbers are automatically assigned in ascending order, starting with 0 (zero), to the physical RF channels of the STB channel lineup to create an FTG Channel Map. See also note below.

 **Note:** If the exported Clone file is to be used for FTG Mode configuration (i.e., it contains an FTG Channel Map), it is highly recommended that you open the file in the FTG File Manager—BEFORE transferring (importing) the file to any Target STBs—to verify FTG Channel Map and FTG Installer Menu settings. This will also enable you to confirm channels and add channel attributes, labels, etc.

## Importing a Clone File

This section describes how to transfer (import) a Clone or Configuration (.tlx) file from a USB memory device to an STB using the STB Manager “Import Clone File” option. The “.tlx” file may be created either from a Master STB Setup that was saved (exported) from a Master STB or in the FTG File Manager.

# Cloning Procedures (Cont.)

---

## Before You Begin

- Ensure the USB device has been formatted with FAT format.
- Avoid using special characters, such as ?, &, @, etc., in the Clone/Configuration (.tlx) filename.
- If the EZ-Manager Wizard appears on the screen when you turn ON the Target STB/display panel, you can use the wizard's "USB Configuration" option to access the STB Manager / USB Download Menu and complete the import procedure (see "STB Configuration Options" and/or "USB Configuration" on pages 19 and 25, respectively, as necessary).
- You may also use the Ez Download utility to import the Clone/Configuration (.tlx) file. See "Ez Download Utility" on pages 27 to 30 for further information.
- If the Target STB is currently in Pass-through Mode and you intend to use the STB's Zoning feature(s)—i.e., the Clone/Configuration (.tlx) file you are importing contains an FTG Channel Map and/or FTG profile(s) with TV Zone and/or Wi-Fi Zone assignments—make sure to assign the appropriate TV Zone # and/or Wi-Fi Zone # in the STB when directed to do so in the procedure below. See Reference section, "Using the STB's Zoning Features," for further information.
- If you would like the Target STB(s) to remain in Pass-through Mode after the Clone/Configuration (.tlx) file is imported, ensure the ".tlx" file does not contain an FTG Channel Map; otherwise, the import procedure will result in the Target STB(s) being configured for FTG Mode via CPU.
- If a Clone (.tlx) file (exported Master STB Setup) contains an FTG Channel Map, the physical RF channels in the FTG Channel Map have been assigned logical channel numbers (see "Exporting a Clone File" above). When you import the Clone file with the FTG Channel Map to the Target STB(s), you will have the option to select either logical or physical channel tuning. Even if you select physical channel tuning, the (list of) physical RF channels in the FTG Channel Map will remain in logical order.
- If an FTG Configuration (.tlx) file (created in the FTG File Manager) contains an FTG Channel Map, each logical channel number in the FTG Channel Map has been assigned a physical RF channel, an IP channel, or an Aux input (the latter designated by 130-0 through 137-0—see also Reference section, "STB Aux Input Configuration").

**Note:** If the FTG Channel Map includes RF channels and Aux inputs *only*, when you import the FTG Configuration file on the Target STB(s) you will have the option to select either logical or physical channel tuning. If you select physical channel tuning, the physical RF channels and Aux inputs in the FTG Channel Map will remain in logical order. Physical channel tuning is not available when the FTG Channel Map includes IP channels.

- If the Target STB EBL is already in FTG Mode, you cannot use this procedure to make changes to the FTG Channel Map and FTG Installer Menu settings. You must use a direct PC-to-STB connection as described in Reference section, "FTG Mode via EBL (Local Configuration)," or an FMA head end device to reconfigure the EBL.
- If the preceding condition applies, but you wish to switch the STB to FTG Mode via CPU, see Reference section, "Restoring Factory Defaults on the STB(s)," for further information before proceeding.
- If the Clone/Configuration (.tlx) file was edited/created in the FTG File Manager, it may contain multiple zoned FTG Installer Menu profiles for different STB/TV models. Make sure it includes the appropriate Installer Menu profile(s) for the Target STB(s) before performing the procedure below.



**Caution: Do not unplug the STB power cord or remove the USB memory device while importing is in progress, as doing so may cause the STB to malfunction or harm the USB device, respectively.**



## Import Clone File Procedure

1. Turn ON the Target STB/display panel.
2. The next step depends on whether the EZ-Manager Wizard appears on the screen when you turn ON the STB/display:
  - If the wizard is displayed, you can complete the import procedure via the wizard, as indicated above (see “Before You Begin”). However, to continue with this procedure and access the “Import Clone File” option from the STB menus, exit the EZ-Manager Wizard. Then, continue with step 3.
  - If the wizard is not displayed, go directly to step 3.
3. If applicable (see also “Before You Begin” above), make sure to assign the appropriate Zone designation(s) in the Target STB at this time.



**Note: In order for the proper location-specific TV Zone and/or Wi-Fi Zone profile data to be applied, the Zone designation(s) must be assigned in the Target STB(s) BEFORE importing is initiated.**

4. Insert the USB memory device with the Clone/Configuration (.tlx) file into either of the USB ports on the Target STB.
5. Press **MENU** on the Installer Remote to display the STB setup menus (STB is in Pass-through Mode) or the Function Menu (STB is already in FTG Mode).
6. (STB in Pass-through Mode only) From the Quick Settings Menu displayed at the right of the screen, select the **Advanced**  menu icon and press **OK** to access the advanced STB setup menus.
7. Use the arrow navigation keys to select/highlight either the **General** menu icon from the STB setup menus or the **Safety** menu icon from the Function Menu. Then, press the number “7” key a total of seven times to display the STB Manager.

**Note:** Ez Download is always selected by default when you initially access the STB Manager. Also note that Diagnostics Menu is for service use only.

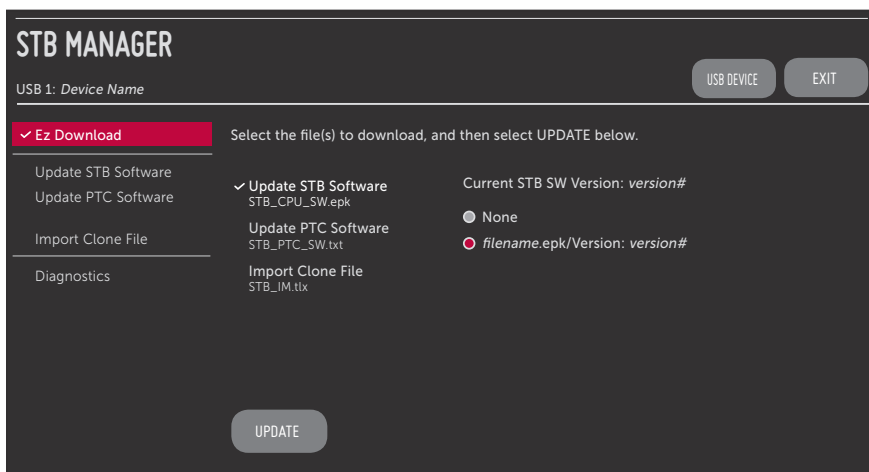

(Continued on next page)

## Cloning Procedures (Cont.)

(Continued from previous page)

- If more than one USB memory device is currently connected to the STB, be sure to select the USB device that contains the “.tlx” file you wish to use. If necessary, use the arrow keys on the Installer Remote to select/highlight the **USB DEVICE** button in the top right corner of the screen and press **OK**. Then, use the Up/Down arrow keys to select the appropriate USB device from the pop-up list of USB devices displayed at the top of the screen.



- Use the Up/Down arrow keys to select **Import Clone File**, and then press **OK**.  
A list of the “.tlx” files stored in the root folder of the USB memory device will be displayed on the screen.

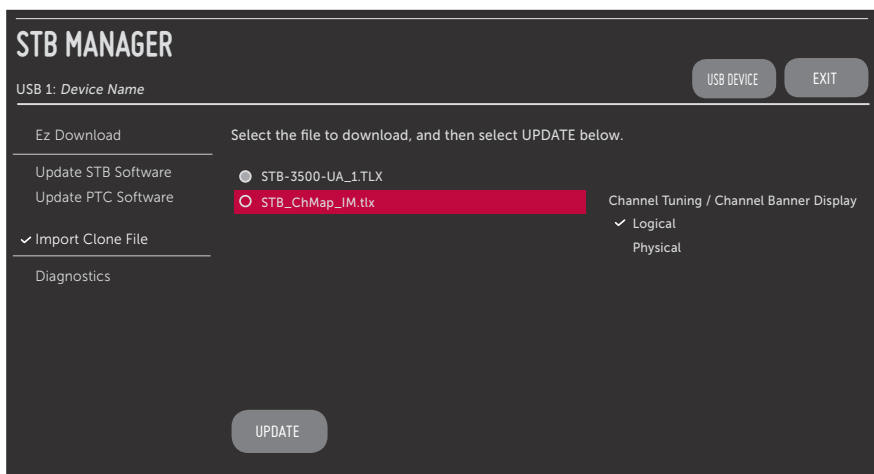

- Use the arrow keys on the Installer Remote to select/highlight the “.tlx” file to import, and then press **OK**.

**Note:** Filenames of exported Clone files are comprised of the STB model and a numeric element, for example, STB-3500-UA\_1.TLX.

- If the Clone/Configuration (.tlx) file includes an FTG Channel Map with RF channels and Aux inputs *only*, you can choose the format for the channel tuning/banner display. Use the arrow keys to select the desired Channel Tuning / Channel Banner Display option—either Logical or Physical—at the right side of the screen. A checkmark will appear at the left of the selected option. Logical tuning is selected by default.

**Note:** If an FTG Channel Map includes IP channels, only logical tuning is available. Also, if the “.tlx” file does not include an FTG Channel Map, the message, “No Channel Map in Clone file,” will be displayed at the right of the screen.

(Continued on next page)

(Continued from previous page)

12. When you are ready to continue, select **UPDATE** on the screen and then press **OK** on the Installer Remote.

Import progress will be displayed on the screen. This process may take a few minutes. Do NOT remove the USB device while importing is in progress. When the import process is complete, an IMPORT COMPLETE pop-up banner will briefly be displayed at the bottom of the screen, and then, the STB will reboot.

13. Remove the USB memory device from the Target STB, and verify that the appropriate configuration is now resident on the Target STB.

**Note:** If the Target STB was previously in Pass-through Mode, and the Clone/Configuration (.tlx) file that was imported contained an FTG Channel Map, the Target STB is now in FTG Mode via CPU. Upon restart (and, if applicable, confirmation of new video output resolution—see note below), the STB tunes according to the Start Channel setting in the Installer Menu. If a Start Channel is specified, the STB will tune to that channel, though, in the case of FTG Mode via CPU configuration, a channel banner will only be displayed if the Start Channel is included in the FTG Channel Map (depending on your selection in step 11, the channel banner will display either the Start Channel's logical channel number or physical RF channel number). Otherwise, the STB will either return to the last channel tuned (STB in Pass-through Mode) or tune to the first channel in the FTG Channel Map (STB in FTG Mode via CPU). If the latter, remember that the channels in the FTG Channel Map are always arranged in logical order, regardless of your selection in step 11.

**Note:** If you updated the STB configuration with a Clone/Configuration (.tlx) file that included a change to Installer Menu item 105 VID OUT FORMAT, when the reboot is complete, you will be prompted to confirm the new video output resolution. See item 105 description on page 39 for further information.

# FTG File Manager Utilities Overview

---

As indicated in the introduction to this document, there are two separate and distinct methods for configuring an STB-3500 for FTG Mode of operation: one method is to configure the STB CPU for FTG Mode operation, while the other is to configure the STB EBL for FTG Mode operation. FROM A LOCAL CONFIGURATION STANDPOINT, EACH OF THESE METHODS IS MUTUALLY EXCLUSIVE. IF THE CPU IS IN FTG MODE, THE EBL CANNOT BE SWITCHED TO FTG MODE. LIKEWISE, IF THE EBL IS IN FTG MODE, THE CPU CANNOT BE SWITCHED TO FTG MODE.

This section provides an overview of the FTG File Manager, which is used for FTG Mode via CPU configuration. The software is available online at: [www.lg.com/us/commercial/display-solutions/ftg](http://www.lg.com/us/commercial/display-solutions/ftg).

## Creating an FTG Configuration File

The procedure below describes how to use the FTG File Manager utilities (see sample screens on pages 54 to 57) to create an FTG Configuration (.tlx) file that can be saved to a USB memory device. In order to enable decryption of Pro:Idiom encrypted channels, it is recommended that you create or view/edit an FTG Configuration file using the FTG File Manager.

**Note:** There is also an option to save (export) FTG Configuration from an STB, which may be desirable or required if you want to save customized STB setup menu settings to the FTG Configuration file and/or if you do not know the RF channels at the site. See “Exporting a Clone File” on pages 45 to 47 for further information.

This procedure provides an overview of the steps required to create the FTG Configuration (.tlx) file. Refer to the *Free-To-Guest (FTG) File Manager User Guide* for further information.

1. Install (if necessary) and launch the FTG File Manager (v1.2.4 or later) on the PC that will be used to create the FTG Configuration (.tlx) file.
2. You have a number of options:
  - To view and/or base a new FTG Configuration file on an existing FTG Configuration (.tlx) file, click the **Open** button in the TLX File command section of the FTG File Manager main screen, and select/double-click on the desired “.tlx” file.

A list of the file’s contents will be displayed in the TLX File Contents window. Either double-click on an individual item to copy it, or click the **Copy All** button directly above the TLX File Contents window to automatically copy all the contents of the opened file to the FTG Configuration List and, if applicable, TV Setup Menu List. Note, though, that while setup menu settings can be included in the new FTG Configuration file, the setup menu settings are not available for editing.

Edit the configuration of the items in the FTG Configuration List as well as the FTG Configuration List itself and/or the TV Setup Menu List, as necessary, to create a new file. Then, proceed to step 3 when you are ready to continue.
  - To open an existing FTG Configuration (.rml) file created in the FTG Device Configuration Application to use its FTG Channel Map and/or FTG Installer Menu settings, click **File** and then **Open** from the FTG File Manager menu bar, and select/double-click on the desired “.rml” file.

Edit channels and/or settings as necessary. Then, proceed to step 3 when you are ready to continue.
  - Create a new FTG Channel Map using the FTG Channel Map Editor in the FTG Channel Map Configuration Utility. Up to 600 logical channels (combined total of both RF and IP mapped channels) can be defined in the FTG Channel Map.

When you are ready to continue, click **Configure** and then **FTG File Manager** from the FTG File Manager menu bar to return to the FTG File Manager main screen, and then proceed to step 3.

(Continued on next page)

## FTG File Manager Utilities Overview (Cont.)

---

(Continued from previous page)

**Note:** To remove an individual item from the FTG Configuration List or the TV Setup Menu List, click on/highlight the item to be removed, and then click the **Remove Item** button directly above the applicable “List” window. To clear both the current FTG Configuration List and TV Setup Menu List contents, click the **Clear** button in the List command section of the FTG File Manager main screen.

**Note:** To clear the current TLX File Contents, click the **New** button in the TLX File command section of the FTG File Manager main screen (above the TLX File Contents window).

3. To add an FTG Channel Map to the FTG Configuration List, click **>>** under FTG Channel Map. This will copy the current mapped RF and IP channels to the FTG Configuration List.

**Note:** If you make any change(s) in the FTG Channel Map Configuration Utility to the current data to be included in the FTG Configuration List, you will need to recopy the FTG Channel Map to the FTG Configuration List.

4. (Optional) Load default FTG Installer Menu settings for the STB. In the Installer Menu Templates section of the FTG File Manager main screen:

- If it is not already selected, click the down arrow at the right of the Region field, and select **North America**. Then, click the down arrow at the right of the Chassis field, and select **STB-3500** from the drop-down list of available models.
- Click the **Load** button.
- Use the FTG Installer Menu Configuration Utility to modify settings, if necessary, including Media Share settings, Wi-Fi Zoning settings, etc. Then, return to the FTG File Manager main screen.

5. If you wish to change the Zone assignment for the current FTG Installer Menu settings, click on the down arrow at the right of the Zone field (below the FTG Installer Menu Settings field), and select the appropriate Zone (0–8). See Reference section, “Using the STB’s Zoning Features,” for further information on the TV Zoning feature and setting the TV Zone # in the STB(s).

6. To add FTG Installer Menu settings to the FTG Configuration List, click **>>** under FTG Installer Menu Settings. This will copy the selected model settings to the FTG Configuration List.

**Note:** If you make any change(s) in the FTG Installer Menu Configuration Utility to the current data to be included in the FTG Configuration List, you will need to recopy the FTG Installer Menu settings to the FTG Configuration List.

**Note:** Above both the FTG Configuration List and TV Setup Menu List windows, an Edit Zone field enables you to change the Zone assignment for each STB Installer Menu and/or TV Setup Menu profile, if desired. Select/highlight the desired profile, and then click on the down arrow at the right of the applicable Edit Zone field to select the appropriate Zone.

7. Click the **Save** button in the List command section of the FTG File Manager main screen to save the FTG Configuration List and, if present, TV Setup Menu List contents to an FTG Configuration (.tlx) file on the PC’s hard drive for later use.

In the Save As pop-up window, name the file (avoid using special characters, such as ?, &, @, etc.) and click **Save**. The default folder path is C:\Program Files\Zenith\FTG\TLX. Note that the FTG Configuration file will have a “.tlx” file extension.

**Note:** To remove an individual item from the FTG Configuration List or the TV Setup Menu List before saving the new file, click on/highlight the item to be removed, and then click the **Remove Item** button directly above the applicable window. To clear both the current FTG Configuration List and TV Setup Menu List contents, click the **Clear** button in the List command section of the FTG File Manager main screen.

8. Transfer the FTG Configuration (.tlx) file to a USB memory device, and proceed to “Importing a Clone File” on pages 47 to 51 to transfer the FTG Configuration file to an STB-3500.

# FTG File Manager Utilities Overview (Cont.)

## FTG File Manager Main Screen

The FTG File Manager main screen enables you to compile, modify, and save FTG Configuration (.tlx) files. It also allows you to change the Zone assignment for each Installer Menu profile, if desired (see Reference section, "Using the STB's Zoning Features," for further information).

The screenshot shows the FTG File Manager interface with the following callouts:

- FTG CONFIGURATION LIST**: Data to be saved in FTG Configuration (.tlx) file.
- CLEAR/SAVE**: FTG Configuration and TV Setup Menu List options.
- NEW/OPEN**: TLX File options.
- Filename of opened FTG Configuration (.rml) file created using FTG Device Configuration Application.**: Points to the FTG File input field.
- Copy FTG Channel Map to and from FTG Configuration List.**: Points to the FTG Channel Map section.
- Copy FTG Installer Menu settings to and from FTG Configuration List. Assign Zone as applicable.**: Points to the FTG Installer Menu Settings section.
- Load default FTG Installer Menu for STB-3500.**: Points to the Installer Menu Templates section.
- TV SETUP MENU LIST**: STB Setup Menu data to be saved in FTG Configuration file.
- TLX FILE CONTENTS**: Data contained in opened FTG Configuration (.tlx) file.



**Note:** The data referenced in the FTG Configuration List is only a snapshot of the current FTG Channel Map and FTG Installer Menu settings when copied to the list. If you make any change(s) to the current data to be included in the FTG Configuration List, you will need to recopy Channel Map and Installer Menu settings to the FTG Configuration List.



# FTG File Manager Utilities Overview (Cont.)

## FTG Channel Map Editor

The FTG Channel Map Editor shows a single Logical Channel's data and the FTG Channel Map.

### LOGICAL CHANNEL MAPPING

Select a Logical Channel number. Then, assign the RF, Major, and Minor channel numbers to complete the mapping.

### CUSTOM CHANNEL LABELS/ICONS

Enter custom labels and select icons by name on menu or by number.

### SET CHANNEL ATTRIBUTES

Check/select Encrypted, OSD, or Blank Video.

Logical	RF	Major	Minor	Label	ICON	Attribute	Restricted
1	84	84	1	CBS	14 - CBS	EO	
2	20	20	5	NBC	15 - NBC	EO	
3	81	81	1	CNN	5 - CNN	EO	
4	18	18	1	ABC	13 - ABC	EO	
5	19	19	3	PBS	17 - PBS	EO	
6	68	68	1	MAX	47 - Cinemax	EO	
7	81	81	2	ESPN	2 - ESPN	EO	
9	61	61	1	HDNet	161 - HDNet	EO	
10	64	64	1	Nat Geo	145 - National Geographic Channel	EO	
18	65	65	1	Comedy	36 - Comedy Central	EO	
19	62	62	2	TBS	3 - TBS	EO	
20	19	19	1	WGN	89 - WGN	EO	
23	86	86	3	TNT	4 - TNT	EO	
24	62	62	2	HBO2	168 - HBO 2	EO	
25	59	59	2	HBO	12 - HBO	EO	

### ZONE RESTRICTION

Set Zone restriction(s) per channel. See Reference section, "Using the STB's Zoning Features," for further information.

### ADD

After defining a new Logical Channel, click to add channel to the FTG Channel Map.

### EXIT

Click to exit editor and return to FTG Channel Map Configuration Utility.

### UPDATE

After editing an existing Logical Channel's data, click to commit the changes in the FTG Channel Map.

### DELETE

Click to remove highlighted channel from FTG Channel Map.



## FTG Installer Menu Configuration Utility

### CONFIGURATION SETTINGS

Select tabs for categories of Installer Menu items to set up STB.

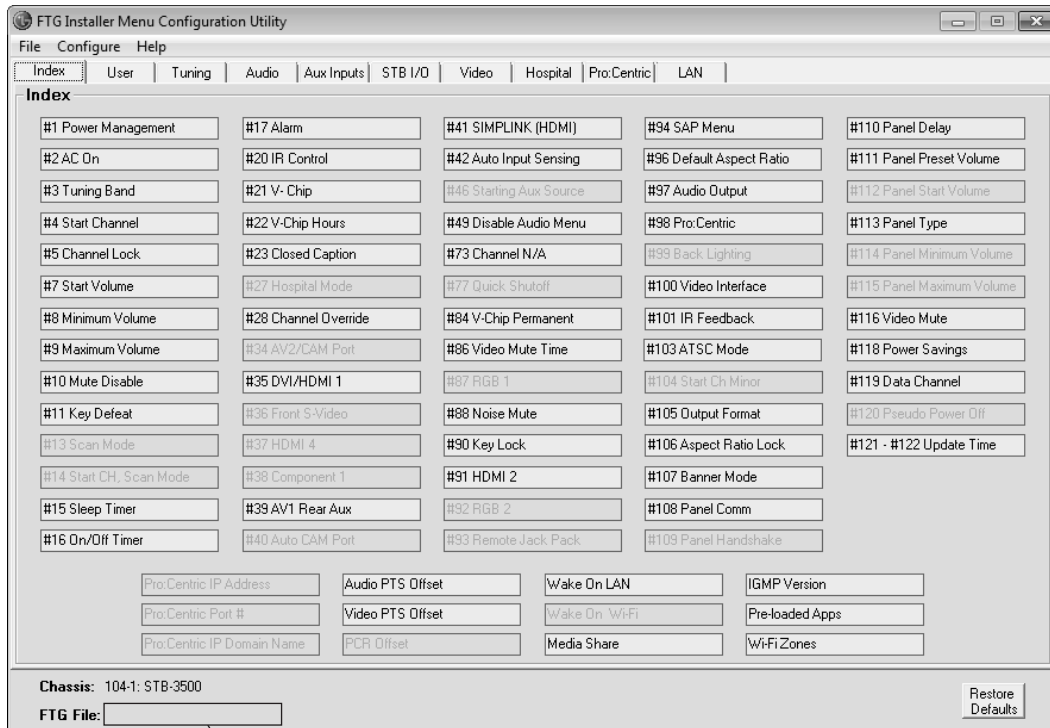

Filename of opened FTG Configuration (.rml) file created using FTG Device Configuration Application.

### Notes:

- The STB I/O tab enables you to set up selected display panel video parameters; the Pro:Centric tab enables you to set up Pro:Centric-specific parameters; and the LAN tab enables you to set up a variety of LAN features, including the Wi-Fi Zoning feature. Refer to the **Free-To-Guest (FTG) File Manager User Guide** for further information. Also, see Reference section, “Using the STB’s Zoning Features,” for additional information on Wi-Fi Zoning.
- Hospital parameters are not applicable for the STB-3500.

# IP Environment Setup

The IP Environment Menu enables you to set up the network features of the STB. If you intend to create a Master STB Setup for cloning purposes (see Master STB Setup procedure on pages 42 to 44), all IP Environment settings, with the exception of Wired Network Connection settings, the STB name (editable in the Media Share Menu), DIAL, and SoftAP settings, may be cloned.

**Note:** With the exception of Network Setting configuration, the IP Environment settings are editable (with the Installer Remote) only if the STB is in Pass-through Mode and read-only when the STB is not in Pass-through Mode.

## Accessing the IP Environment Menu

**Note:** When you enter the IP Environment Menu, the Installer Menu is exited (all current settings are saved automatically upon exit). If you are also in the process of updating Installer Menu items, you may wish to set all items as needed before you access the IP Environment Menu. Otherwise, after exiting the IP Environment Menu, you will need to reaccess the Installer Menu to set additional items.

1. Use the Installer Remote to access the Installer Menu (see “Accessing the Installer Menu” on page 31 for further information).
2. Navigate to Installer Menu item 119 DATA CHANNEL, and press **2-5-3 + MENU** to launch the IP Environment Menu.

Use the Up/Down arrow keys on the Installer Remote to select the desired menu option and then press **OK**. Refer to the following sections for information on each of the IP Environment setup options.

**When you have completed your IP Environment configuration as required**, press **EXIT** or **↵** on the Installer Remote to exit the IP Environment Menu.

## Network Configuration

This section describes each of the options available in the Network Menu (see example at right). Refer to the appropriate subsection(s) on the following pages.

 **Note: If you intend to use the Wi-Fi Zoning feature with cloning configuration, you must configure the wireless network connection as part of the Master STB Setup. See “Configuring a Wi-Fi Network Connection” on page 60 for further information.**

### Accessing the Network Menu

With the IP Environment Menu on display, use the arrow keys on the Installer Remote to select the **Network** menu option. Then, press **OK**.

**Note:** The STB's MAC address is displayed at the top of the Network Menu screen and cannot be modified.



## Configuring a Wired Network Connection

**Note:** If desired, you can configure both wired and wireless connections. However, note that a wired connection is always prioritized over a wireless connection. That is, when the STB is turned OFF and then back ON, if a LAN cable is detected between the STB and the network, the STB will default to the wired connection. If the LAN cable is removed, the STB will then attempt to establish the wireless connection. Whenever the LAN cable is reconnected, the STB will re-establish the wired connection.

1. Connect the appropriate cable between the STB and the network.
2. With the Network Menu on display, use the arrow keys on the Installer Remote to select **Network Setting**. Then, press **OK**. A second Network screen (see example at right), with Wired and Wi-Fi Connection setup options, will be displayed.

By default, the STB uses DHCP, and if a LAN cable is detected, the STB will attempt to connect to the network as soon as you select “Network Setting” above. If the STB is able to connect to the network, a “Connected to Internet” message will be displayed below the Wired Connection field.

3. If the network is not configured for DHCP or you want to specify static configuration data or you would like to change the network configuration from Manual to Automatic, edit the IP configuration for this STB as follows:
  - In the second Network screen, select **Wired Connection** and press **OK**. Then, in the Wired screen, select **Edit** (if not already selected) and press **OK**.
  - In the Edit IP screen, select or de-select the “Set Automatically” checkbox, as required. A checkmark indicates that Automatic configuration is enabled.
  - To manually edit the IP configuration, for each data entry field: Use the arrow keys on the Installer Remote to select the field and press **OK**. You can use the number keys on the Installer Remote to direct enter numeric values or use the arrow keys to select the appropriate numbers from the pop-up virtual keyboard displayed at the bottom of the screen. (Note, however, that you must use the dot “.” key from the virtual keyboard to separate each octet of an IP address.) When you are done, select **Enter** from the virtual keyboard, and then press **OK** on the Installer Remote.
  - When all Edit IP fields are set as required, use the arrow keys on the Installer Remote to select **Connect** and press **OK**.

At the top of the screen, you will see a progress display that indicates status as each network element is confirmed (see example at right).

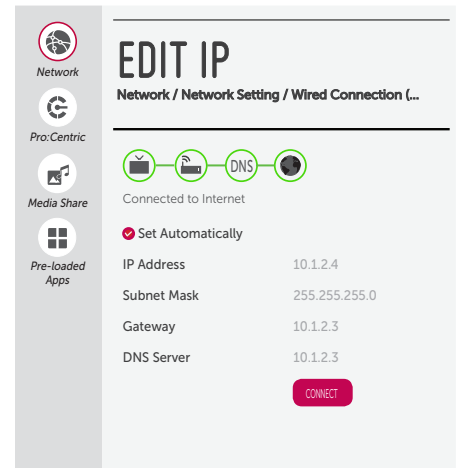
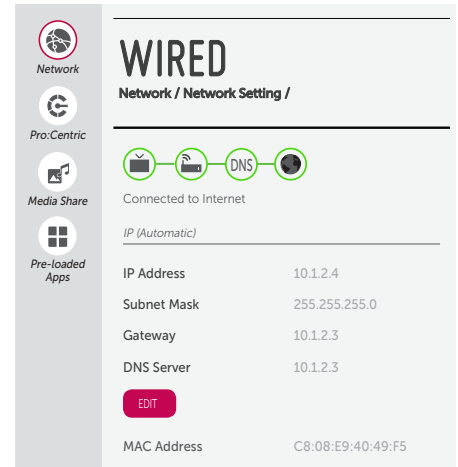
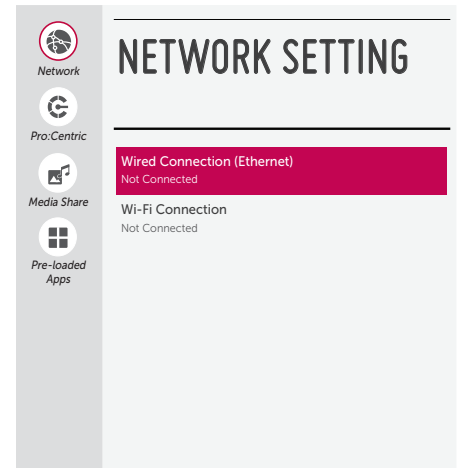

(Continued on next page)

# IP Environment Setup (Cont.)

(Continued from previous page)

If the network is connected successfully, a “Connected to Internet” message will appear just below the progress display. If the network connection is not successful, the progress display will identify the network element in which the connection failed. Check your cabling and/or verify the configuration data, as necessary.

- Once the wired network configuration is complete, use the arrow keys on the Installer Remote to return to the IP Environment Menu, as necessary, or press  $\leftarrow$  to return to the previous Network Menu level(s) and/or exit the IP Environment Menu.

## Configuring a Wi-Fi Network Connection

- With the Network Menu on display, use the arrow keys on the Installer Remote to select **Network Setting**. Then, press **OK**.
- A second Network screen (see example at right), with Wired and Wi-Fi Connection setup options, will be displayed. Select **Wi-Fi Connection** and press **OK**.
- In the Wi-Fi screen, available access points are listed in the top half, while additional menu options are listed in the bottom half, of the screen. Use the arrow keys on the Installer Remote to select the desired access point, or select the type of wireless connection to configure (see descriptions below). Then, press **OK**.
  - Add a hidden wireless network: Direct enter the SSID of an access point whose SSID has not been enabled for broadcast (i.e., the access point does not appear in the list of access points).
  - WPS PBC: Connect to a network via an access point that is enabled for PBC.
  - WPS PIN: Complete network/PIN verification via the access point web interface.

Make sure you have the network security password/PIN available if you are attempting to connect to a secured network.

- Follow the on-screen instructions to complete the appropriate network configuration. Use the Installer Remote to navigate between fields and make entries, etc.

**Note:** As with a wired connection, you will have the option to specify the IP configuration for this network connection. Once the initial connection is established, you can select **Advanced Settings** (initially greyed out) at the bottom of the Wi-Fi screen to view the IP configuration data. In the Advanced screen, select **Edit** and press **OK**, and then modify the IP data, as required. See step 3 of the wired connection procedure above for further information on the Edit IP screen fields.

- Once the wireless network configuration is complete, use the arrow keys on the Installer Remote to return to the IP Environment Menu, as necessary, or press  $\leftarrow$  to return to the previous Network Menu level(s) and/or exit the IP Environment Menu.

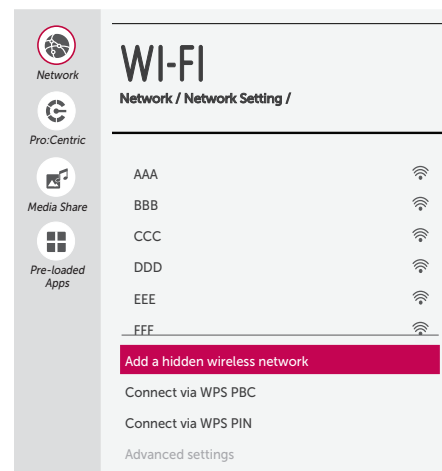
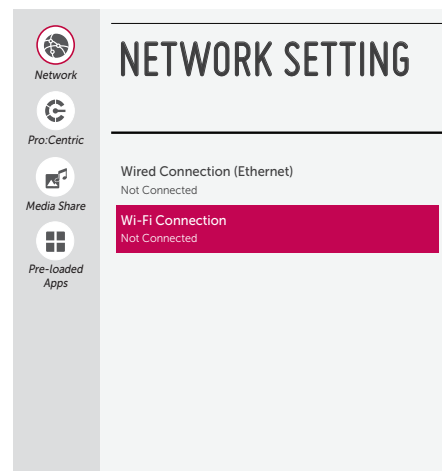

## IP Stream Control

If necessary, due to an audio and/or video stream delay, IP Stream Control options enable you to compensate for synchronization irregularities by allowing audio PTS and video PTS offset modifications. This menu also enables you to specify the IGMP version (2 or 3). Note that any modifications to these settings should be performed by qualified personnel only.

1. With the Network Menu on display, use the arrow keys on the Installer Remote to select **IP Stream Control**. Then, press **OK**.
2. In the IP Stream Control screen, use the Up/Down arrow keys on the Installer Remote to select/highlight the appropriate field—Audio PTS Offset, Video PTS Offset, or IGMP Version—and then press **OK**.
3. If you are modifying an offset value, use the Left/Right arrow keys to select the appropriate value for the selected field. Offset values represent offset time in milliseconds (ms) and can be adjusted from -500 ms to +500 ms in 10 ms increments. When you are done, press **OK** on the Installer Remote.

If you are modifying the IGMP version, use the Up/Down arrow keys to select the appropriate version number and press **OK**.

4. Once all modifications are completed as required, use the arrow keys on the Installer Remote to return to the IP Environment Menu, as necessary, or press ↵ to return to the Network Menu and/or exit the IP Environment Menu.



## Wake On LAN Setup

The Wake On LAN feature enables the STB to receive software updates and/or be powered ON upon receipt of Wake Up Frame packets and/or Magic Packet data via the wired LAN. To facilitate use of this feature, note that the appropriate wired connection must be made. This menu option enables you to specify Wake On LAN parameters.

1. With the Network Menu on display, use the arrow keys on the Installer Remote to select **Wake On LAN**. Then, press **OK**.
2. In the Wake On LAN screen, use the Up/Down arrow keys on the Installer Remote to select/highlight the desired field and press **OK**. Then, use the arrow keys to select the desired setting—Disabled, Update, or Power On—from the drop-down list of options.
3. Once all fields are completed as required, use the arrow keys on the Installer Remote to return to the IP Environment Menu, as necessary, or press ↵ to return to the Network Menu and/or exit the IP Environment Menu.

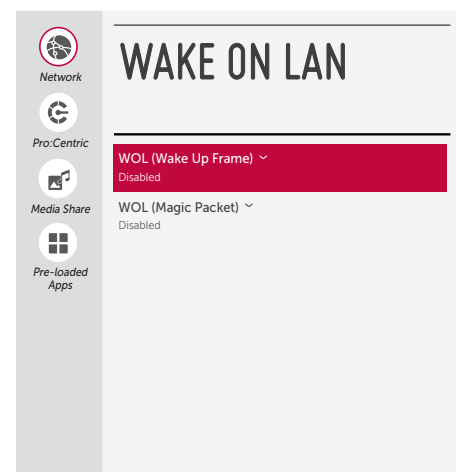

# IP Environment Setup (Cont.)

## Pro:Centric Setup

Pro:Centric options enable you to configure the STB with the appropriate settings to connect to the Pro:Centric server. Use the Up/Down arrow keys on the Installer Remote to navigate between fields.

1. With the IP Environment Menu on display, use the arrow keys on the Installer Remote to select the **Pro:Centric** menu option. Then, press **OK**.
2. Select/highlight the **Media Type** field and press **OK** on the Installer Remote to display the drop-down list of options. Then use the Up/Down arrow keys to select either **RF** or **IP**, as applicable.

**Note:** If the Media Type has already been set in the EZ-Manager Wizard, the specified value will be reflected in this field.

**Note:** By default, the Pro:Centric Menu shows RF configuration fields initially. When “IP” is selected as the Media Type, IP Address and Port Number fields appear on the screen (in place of the Data Channel field).

3. Refer to the appropriate subsection below to configure the STB's Pro:Centric settings to match those of the Pro:Centric server.

While the Pro:Centric application itself is an additional feature (see step 4), the appropriate Pro:Centric server configuration must be completed to enable E-Z Installation (configuration and software/firmware) data downloads and, if configured, the Pro:Centric application download.

### RF Configuration

For STBs in Pass-through Mode or FTG Mode via CPU, if the Data Channel is left at its default value (AUTO), the STB's Data Channel Auto Search feature will be enabled. See Installer Menu item 119 DATA CHANNEL description on page 40 for further information.

- To toggle between AUTO or MANUAL settings for the Data Channel, select/highlight the **Data Channel** field and press **OK**.
- When the Data Channel field is set to “MANUAL,” a data entry field is available on the screen, and you can specify the RF channel number that will be used by the Pro:Centric server as its data channel. The Data Channel value can be set from 0 (disabled) to 135.\*

Use the arrow keys on the Installer Remote to select the Data Channel data entry field and press **OK**. You can then use the number keys on the Installer Remote to direct enter the Data Channel, or you can use the arrow keys to select the appropriate number(s) from the pop-up virtual keyboard displayed at the bottom of the screen. When you are done, select **Enter** from the virtual keyboard, and then press **OK** on the Installer Remote.

**Note:** If the Data Channel has already been set in the Installer Menu (Installer Menu item 119) or in the EZ-Manager Wizard, the specified channel will appear in the Data Channel data entry field. If you change the Data Channel in this menu, Installer Menu item 119 will now show the value you entered here.

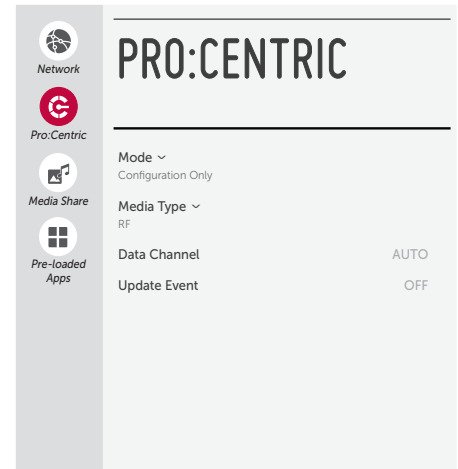

(Continued on next page)

\* PCS150R and later Pro:Centric servers do not support HRC or IRC cable channel frequencies.

(Continued from previous page)

### IP Configuration

Enter the Pro:Centric server IP address and port number in the IP Address and Port Number fields, respectively. The IP address must match the IPv4 multicast address and the port number must match the port number that is set in the Pro:Centric server.

For each data entry field: Use the arrow keys to select the field and press **OK**. Then, you can either use the number keys on the Installer Remote to direct enter data values, or you can use the arrow keys to select the appropriate number(s)/alphanumeric character(s) from the pop-up virtual keyboard displayed at the bottom of the screen. When you are done, select **Enter** from the virtual keyboard, and then press **OK** on the Installer Remote.

**Note:** If the server IP address and port number have already been set in the EZ-Manager Wizard, the specified data will be reflected in the fields displayed.

**Note:** Setting the Media Type to "IP" automatically sets item 119 DATA CHANNEL in the Installer Menu to 253. You cannot alter this setting unless you revert Media Type to "RF." Also, it is not possible to direct enter "253" in the Installer Menu.

4. Select/highlight the **Mode** field and press **OK** on the Installer Remote to display the drop-down list of options. Then, use the Up/Down arrow keys to select the appropriate Pro:Centric Application Mode setting—**Configuration Only**, **FLASH**, **GEM**, or **HTML**. If the Pro:Centric Application Mode is set to "Configuration Only," Pro:Centric application data will not be downloaded.

**Note:** If the mode has already been set in the Installer Menu (item 098 PRO:CENTRIC) or in the EZ-Manager Wizard, the specified mode will be reflected in this field. If you change the mode in this menu, Installer Menu item 098 will now reflect the value you selected here.

5. Select/specify the appropriate Update Event setting(s), as required. Based on Update Time settings, the Wake For Update feature wakes the STB once daily to check for, and if applicable, download updates from the Pro:Centric server. See Installer Menu item 121 UPDATE TIME HR description on page 41 for additional information on Wake For Update functionality.
  - To toggle between ON and OFF in this menu, select/highlight the **Update Event** field and press **OK** on the Installer Remote. When Update Event is set to "ON," an Update Time field is displayed on the screen.
  - If Update Event is ON, set the Update Time as required. Use the arrow keys on the Installer Remote to select/highlight the Update Time field, and then press **OK**. Hour, Minute, and Meridiem fields will be displayed. Select each field in turn and specify the appropriate Wake For Update time, as desired. Note that the Update Time set in this menu is based on a 12-hour clock. Ensure the meridiem (AM/PM) specification is set accordingly.
6. Once all fields are completed as required, use the arrow keys on the Installer Remote to return to the IP Environment Menu, as necessary, or press **↵** to exit the IP Environment Menu.

# IP Environment Setup (Cont.)

## Media Share Setup

The Media Share Menu allows you to enable the following Media Share features on this STB:

- LG Smart Share®: Allows guests to use the STB/display panel to access and view data shared either by wired DLNA Certified® devices connected to the same LAN as the STB or by wireless LG devices using LG's Smart Share application with Wi-Fi Direct®.
- Screen Share: Enables screen sharing with a Miracast® or Wireless Display (WiDi) capable device (e.g., a laptop with Intel® hardware).
- Media Renderer: Enables the STB to act as a media renderer device to receive content from DLNA Certified devices on the same network.
- Bluetooth Sound Sync: Allows guests to listen to audio from a Bluetooth-enabled mobile device through the display panel's speakers.
- DIAL (Discovery and Launch): Allows guests to play selected application media on the STB/display panel from a device with DIAL capability. The device may be used to cast any application for which an STB-compatible application has been created/selected for inclusion in the Pre-loaded Apps Menu (for example, YouTube—see also following page). Note that the device must be connected to the same network as the STB.
- SoftAP: Enables the STB to function as a 2.4 GHz wireless access point for up to five devices. Note that a wired network connection MUST be established in order for guests to use SoftAP.

**Note:** See also Reference section, "Using Media Share Features," for additional information on these features.

1. With the IP Environment Menu on display, use the arrow keys on the Installer Remote to select **Media Share**. Then, press **OK**.
2. In the Media Share screen, all features with the exception of SoftAP may be toggled from DISABLE to ENABLE and vice versa as follows: Use the Up/Down arrow keys on the Installer Remote to select/highlight the desired feature, and then press **OK**. (See also notes at right regarding Wi-Fi Direct requirement and Bluetooth Sound Sync confirmation.)
3. If you would like to enable SoftAP, complete the SoftAP access configuration as follows:
  - Select/highlight **SoftAP** and press **OK** on the Installer Remote.
  - When you initially access the SoftAP screen, the OFF/ON toggle button at the top right of the screen is selected/highlighted by default. Press **OK** on the Installer Remote to turn SoftAP ON.
  - To enable use of a randomly generated security key for SoftAP access, set the Use Default field to "Enable" (the Security Key field will subsequently be grayed out and the random security key will be displayed).

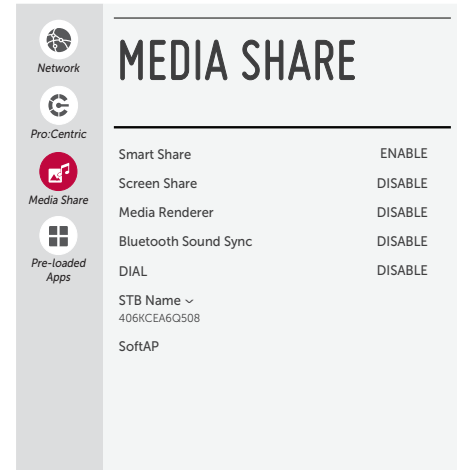

### Notes:

- With webOS 2.0, Screen Share MUST be enabled in addition to Smart Share in order for guests to use Wi-Fi Direct.
- Bluetooth Sound Sync is only available with CPU v3.00.18 or later.
- If you enable Bluetooth Sound Sync, a pop-up confirmation banner will be displayed since enabling Bluetooth Sound Sync renders Wireless LG Sound Sync unavailable. Select **Confirm** to continue.
- DIAL is only available with CPU v4.10.50 or later.

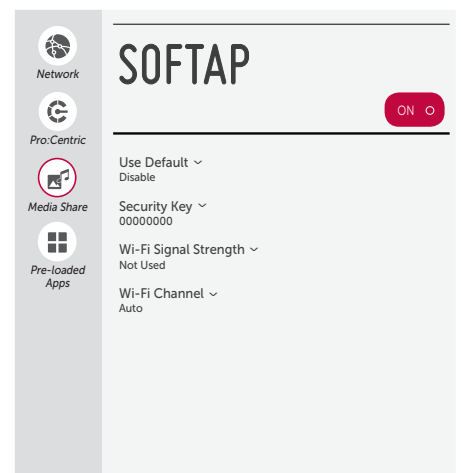

(Continued on next page)



(Continued from previous page)

- To specify your own security key for SoftAP access, set the Use Default field to “Disable.” Then, select the **Security Key** field and press **OK**. In the data entry field, you can use the number keys on the Installer Remote to direct enter a numeric security key, or you can use the arrow keys to select the appropriate alphanumeric characters—at least eight, but no more than 64—from the pop-up virtual keyboard displayed at the bottom of the screen. Note that the security key may not contain any special characters (:, /, \, @, etc.). When you are done, select **Enter** from the virtual keyboard, and then press **OK** on the Installer Remote.
  - Select the appropriate values in the Wi-Fi Signal Strength, and Wi-Fi Channel fields, as required.
4. If desired, you can specify a name for this STB so that it is easy to identify and differentiate from other STBs/TVs for which sharing has been/will be enabled.  
To edit the STB name (default: STB’s serial number), use the Up/Down arrow keys to select the **STB Name** field, and then press **OK**. You can then use the number keys on the Installer Remote to direct enter a numeric STB name, or you can use the arrow keys to select the appropriate alphanumeric character(s) from the pop-up virtual keyboard at the bottom of the screen. When you are done, select **Enter** from the virtual keyboard, and then press **OK** on the Installer Remote.
  5. Once all fields are completed as required, use the arrow keys on the Installer Remote to return to the IP Environment Menu, as necessary, or press ↵ to exit the IP Environment Menu.

**Note:** While Smart Share, Screen Share, Media Renderer, and Bluetooth Sound Sync settings are clonable, DIAL and SoftAP settings, as well as the STB name cannot be cloned.

## Pre-loaded Applications

This option allows you to select which of the pre-loaded application icons to display in the STB’s Smart Launcher, which appears along the bottom of the screen.

When the Pro:Centric application is disabled, the Smart Launcher is available to end users via the PORTAL button on the remote control. Depending on the remote control being used, the Smart Launcher may also be available to end users via a SMART button.

1. With the IP Environment Menu on display, use the arrow keys on the Installer Remote to select **Pre-loaded Apps**. Then, press **OK**.
2. In the Pre-loaded Apps Menu, a list of available application options is displayed. Use the Up/Down arrow keys to highlight each application you wish to select or de-select, and press **OK** on the Installer Remote. When an application is selected, a checkmark is displayed at the left of the application name.

**Note:** Though not included in the application list on this screen, all Screen Share applications are available in the Smart Launcher once they are enabled in the Media Share Menu. See “Media Share Setup” above.

3. When you are done selecting the pre-loaded application icons to be displayed in the Smart Launcher, as required, use the arrow keys on the Installer Remote to return to the IP Environment Menu, as necessary, or press ↵ to exit the IP Environment Menu.

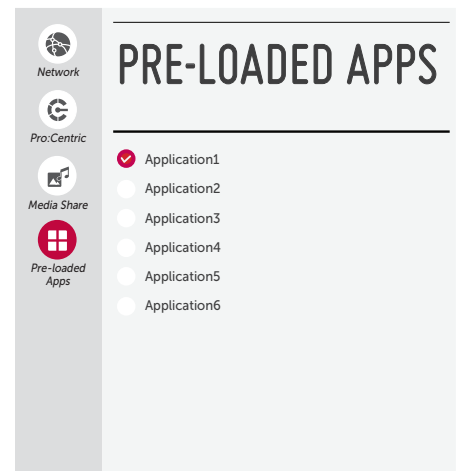

**Note:** Make sure to select any application(s) that may be used in conjunction with the DIAL feature, if applicable.

# Reference: Updating STB Software using a USB Memory Device

---

This section describes how to update STB (CPU) and/or PTC software using the STB Manager “Update STB Software” and/or “Update PTC Software” option(s), respectively, though you may also use the Ez Download utility to update software, if desired. See “Ez Download Utility” on pages 27 to 30 for further information.

## Before You Begin

- Software update files must be stored in a folder named “LG\_DTV” in the root directory of the USB memory device.
- Ensure the USB device has been formatted with FAT format.

## Update the STB/PTC Software

**Note:** You can check the STB/PTC software versions by accessing the Installer Menu with the Installer Remote. See “Accessing the Installer Menu” on page 31 for further information. PTC and CPU versions are displayed in the Installer Menu footer.

**Note for STB CPU Software Update only:** If the STB detects a software file on the USB device, it will automatically display an Update STB Software screen, and if the file contains a later version of software than is currently running on the STB, you can start the software update from this screen (select **UPDATE** and press **OK**). Otherwise, you can exit the screen (select **CANCEL** and press **OK**), and access the STB Manager as described below.

1. Turn ON the STB/display panel, and then insert the USB memory device into either of the USB ports on the STB.
2. Press **MENU** on the Installer Remote to display the STB setup menus (STB is in Pass-through Mode) or the Function Menu (STB is not in Pass-through Mode).
3. (STB in Pass-through Mode only) From the Quick Settings Menu displayed at the right of the screen, select the **Advanced** ⓘ menu icon and press **OK** to access the advanced STB setup menus.
4. Use the arrow navigation keys to select/highlight either the **General** menu icon from the STB setup menus or the **Safety** menu icon from the Function Menu. Then, press the number “7” key a total of seven times to display the STB Manager (see example on following page).

**Note:** Ez Download is always selected by default when you initially access the STB Manager. Also note that Diagnostics is for service use only.

5. If more than one USB memory device is currently connected to the STB, be sure to select the USB device that contains the software file you wish to use. If necessary, use the arrow keys on the Installer Remote to select/highlight the **USB DEVICE** button in the top right corner of the screen and press **OK**. Then, use the Up/Down arrow keys to select the appropriate USB device from the pop-up list of USB devices displayed at the top of the screen.



(Continued on next page)

# Reference: Updating STB Software using a USB Memory Device (Cont.)

(Continued from previous page)

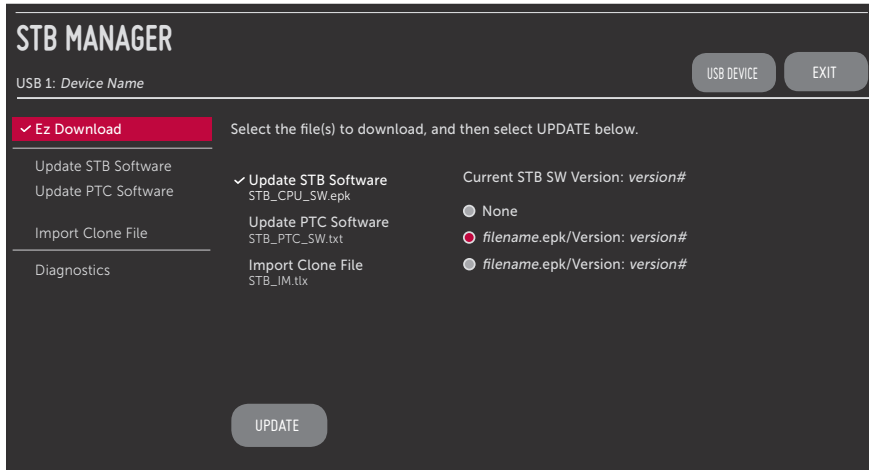

6. Use the Up/Down arrow keys to select **Update STB Software** or **Update PTC Software**, as applicable, and press **OK**.

Depending on your selection, a list of either STB or PTC software files stored in the LG\_DTV folder on the USB memory device will be displayed on the screen. Above the listing of files, you can also see the current version of STB or PTC software. The following screen sample illustrates an Update STB Software screen.

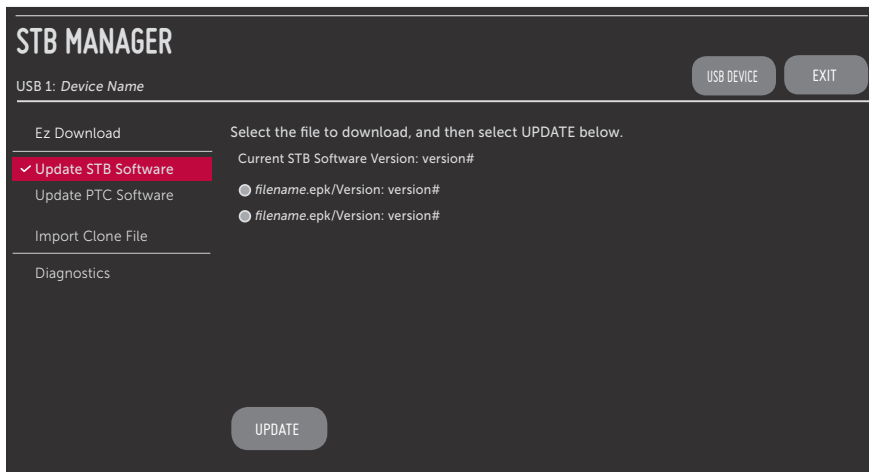

7. Use the arrow keys to select/highlight the update file to download, and then press **OK**.
8. When you are ready to download the update, select **UPDATE** on the screen, and then press **OK** on the Installer Remote.

Software update progress will be displayed on the screen. Do NOT remove the USB device until the software update is complete. When the software update is complete, an UPDATE COMPLETE pop-up banner will briefly be displayed at the bottom of the screen, and then, the STB will reboot.

# Reference: Display Panel Specifications

---

This section describes the types of commercial display panels that may be used with the STB-3500.

## LG Hospitality TV Panels

The STB-3500 may be used with LG Hospitality TVs (LP645H, LT670H, etc.) that support Multiple Protocol Interface (MPI).

Use the MPI/MTI cable provided to connect the RJ-12 MPI/MTI TELEVISION CONTROL port on the STB-3500 front jack panel to the MPI port on the rear jack panel of the display.\*

## LG Commercial Monitors & Public Display TV Panels

The STB-3500 may be used with LG Commercial Monitors (M3203CCBA, M3204C, etc.) or Public Display TVs (LD450C, LT560C, etc.) that support the TV-Link Monitor (TLM) interface.

Use the 3.5 mm-to-DB9 TLM cable provided to connect the 3.5 mm RS-232C TELEVISION CONTROL jack on the STB-3500 rear jack panel to the RS-232 CONTROL connector on the rear jack panel of the display.\*

Note that when you use these model display panels, you must set Installer Menu item 113 PANEL TYPE appropriately. For example, if you are using an LG Commercial Monitor or Public Display TV that does not support an xb Input Select command, set Installer Menu item 113 to 2. If you are using an LG Commercial Monitor or Public Display TV that does support an xb Input Select command, set Installer Menu item 113 to 4 (default).

**Note:** Installer Menu item 113 values 0, 1, and 3 are available to support legacy panel types.

## Commercial Non-LG TV Panels

The STB-3500 may be used with commercial non-LG TVs that support SONIFI's Multiple Television Interface (MTI) protocol.

Use the MPI/MTI cable provided to connect the RJ-12 MPI/MTI TELEVISION CONTROL port on the STB-3500 front jack panel to the MTI (typically labeled "DATA") port on the rear jack panel of the display.\*

Note that some MTI interface configuration may be required on non-LG TVs. Refer to the TV manufacturer's documentation to determine if any configuration is required.

\* On early STB-3500 models, the RS-232C TELEVISION CONTROL jack is labeled "DISPLAY CONTROL 1" and the MPI/MTI TELEVISION CONTROL port is labeled "DISPLAY CONTROL 2."

## Reference: STB Aux Input Configuration

DIRECT ACCESS Tuning *		STB		ENABLE					MPI DATA				Installer Menu Item 046 START AUX SRCE (Start Aux Source) Value
				Installer Menu			MPI DATA STATUS TYPE 0x41 SOURCES ENABLED (R/W)		DATA STATUS TYPE 0xD2 CURRENT AV SOURCE (R)		DATA STATUS TYPE 0x0D AUX SOURCE (R)		
Installer Menu Item 029 OLD OCV = 0	Installer Menu Item 029 OLD OCV = 1	Aux Input	Input Mode	Item	Function	Value	Enable Bit	Label	Value	Value	Description		
131-0	91-0	AV (Rear)	CV	39	REAR AUX EN	1	1	Rear Video (Aux)	1	0	VIDEO	1	
132-0	92-0	HDMI2	DTV	91	HDMI2 ENABLE	1	2	S-Video Rear	2	0	VIDEO	5	
			PC			2				2	COMPUTER		
133-0	93-0	HDMI1	DTV	35	HDMI1 ENABLE	1	3	Front Computer	3	0	VIDEO	3	
			PC			2				2	COMPUTER		

\* Use Installer Remote to enter channel number indicated based on OLD OCV Installer Menu setting.

## Reference: *b*-LAN Setup & Overview

---

The *b*-LAN module is internal to the STB. It allows hotel/institution head end equipment with *b*-LAN technology to communicate, via the institution's RF distribution system, with the STB for configuration and control.

Installer Menu item 118 POWER SAVINGS controls the power circuitry for both the embedded *b*-LAN module and the EXT MPI CONTROL port (on early STB-3500 models, labeled "MPI"). The default value is 3—the *b*-LAN module is only powered when the STB is turned ON. See chart below.

POWER SAVINGS	STB OFF	STB ON
	<i>b</i> -LAN & EXT MPI CONTROL Port Power	<i>b</i> -LAN & EXT MPI CONTROL Port Power
1	On	On
3 (default)	Off	On

A *b*-LAN enabled head end device, such as an LG FMA-LG101, broadcasts over the RF distribution system to communicate to multiple STBs. When the STB is first installed, it must be turned ON in order for its embedded *b*-LAN module to receive communication from the head end device. At this point, if it is desired for the *b*-LAN module to always be powered, including while the STB is turned OFF, set Installer Menu item 118 POWER SAVINGS to 1.

Also, if MPI communication is required for external MPI control, set Installer Menu item 118 POWER SAVINGS to 1 so that the EXT MPI CONTROL port circuitry is always powered.

 **Caution: POWER SAVINGS should NEVER be set to 7. This setting is intended for factory use only.**

## Reference: FTG Mode via EBL (Local Configuration)

The following steps outline local FTG configuration of individual STB EBLs using a direct PC-to-STB connection. Refer to the **Free-To-Guest (FTG) Device Configuration Application User Guide** for further information. FTG Device Configuration Application software is available online at: [www.lg.com/us/commercial/display-solutions/ftg](http://www.lg.com/us/commercial/display-solutions/ftg).

**Note:** If the STB CPU is already in FTG Mode, you cannot use this procedure to make changes to the FTG Channel Map and FTG Installer Menu settings. Refer to FTG Mode information on pages 11 to 13 for further details. If you wish to switch the STB to FTG Mode via EBL, see Reference section, “Restoring Factory Defaults on the STB(s),” for further information before proceeding.

**Note:** If you wish to change the STB’s video output format, you MUST use the following procedure. Do NOT attempt to change this setting using broadcast configuration of the EBL via FMA, as confirmation of the new video output resolution will be required at each STB. See item 105 description on page 39 for additional information.

1. Install (if necessary) and launch the FTG Device Configuration Application (v5.4.9 or later) on the PC that will be used to configure the EBL.
2. Build an FTG Channel Map using the FTG Channel Map Editor in the FTG Channel Map Configuration Utility (or, if applicable, open an existing FTG Configuration [.rml] file).  
**Note:** Up to 141 logical channels can be defined in the FTG Channel Map.
3. Connect the PC to the TV-LINK CFG jack on the STB’s rear jack panel using a USB-to-TTL serial cable (TTL-232R-5V-AJ). If necessary, install the device driver on the PC.
4. Turn ON the STB/display panel.  
**Note:** If Installer Menu item 118 POWER SAVINGS is set to 3 (default), the STB must be ON in order for steps 5 and 6 below to be successful.
5. “Write” the FTG Channel Map to the EBL (switches the EBL from Pass-through Mode to FTG Mode).  
**Note:** After a “Write” of new data, a green text banner that shows the EBL firmware version and release date will briefly be displayed on the screen.
6. “Read” the current FTG Installer Menu settings from the EBL using the FTG Installer Menu Configuration Utility. If necessary to make changes to Installer Menu items, “Write” them back to the EBL in FTG Mode.
7. Save the FTG Channel Map and FTG Installer Menu settings to an FTG Configuration (.rml) file for future use.
8. Tune the STB to a logical channel in the FTG Channel Map.

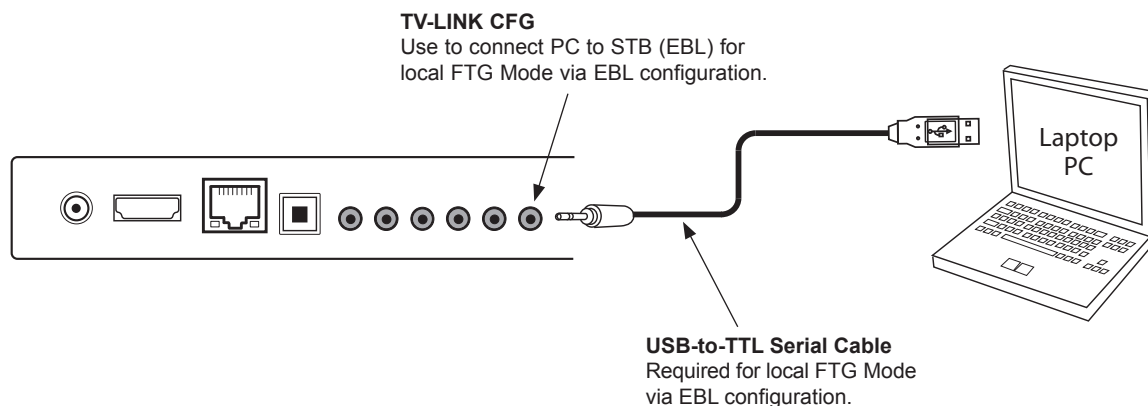

# Reference: Auto Input(s) Sensing Feature

This section provides detailed settings information for Installer Menu item 042 AUTO INPUTS.

**Note:** When both item 042 AUTO INPUTS *and* item 041 SIMPLINK EN are enabled in the Installer Menu, HDMI inputs will be detected by SIMPLINK, but the Auto Input(s) Sensing Feature will not function.

In the Installer Menu, an informational code is displayed at the right of each Auto Inputs value, for example:

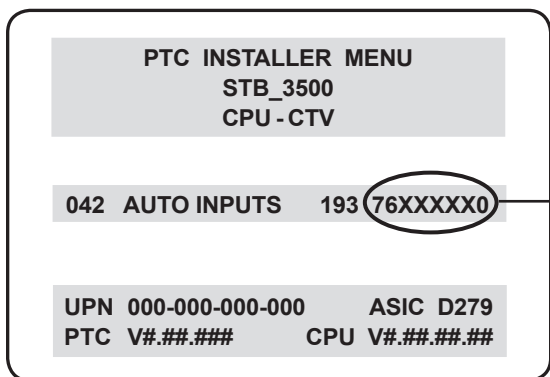

### AUTO INPUTS Display Code

This example illustrates Installer Menu item 042 value 193, which enables auto-sensing for all available Aux inputs. The input #s in the display code (7, 6, 0 in this example) identify the enabled Aux inputs. See first table below for a listing of the STB-3500 Aux inputs and their corresponding display code input #s. The second table below shows the display codes for all item 042 values.

Each code consists of eight characters that identify the Aux input(s) for which auto-sensing is enabled. The following table identifies the Installer Menu display code Input # for each Aux input that is available on the STB-3500. The table also identifies the Installer Menu item associated with each Aux input. Remember that in order for auto-sensing to be enabled for an input, that input must also be enabled in the Installer Menu.

Installer Menu Display Code Input #	Aux Input	Installer Menu	
		Item	Function
0	AV	039	REAR AUX EN
6	HDMI 1	035	HDMI1 ENABLE
7	HDMI 2	091	HDMI2 ENABLE

To disable auto-sensing for all available Aux inputs, set item 042 to 0. To enable auto-sensing for all available Aux inputs, set item 042 to 255. All other available settings (i.e., settings for individual inputs), are listed in the table below.

Item 042 Value	Inputs			Installer Menu Display
	AV	HDMI 1	HDMI 2	
001	Enabled	Disabled	Disabled	DDXXXXX0
064	Disabled	Enabled	Disabled	D6XXXXXD
065	Enabled	Enabled	Disabled	D6XXXXX0
128	Disabled	Disabled	Enabled	7DXXXXXD
129	Enabled	Disabled	Enabled	7DXXXXX0
192	Disabled	Enabled	Enabled	76XXXXXD
193	Enabled	Enabled	Enabled	76XXXXX0

X = Aux input source is Disabled or Not Available (i.e., on this STB model)

D = Auto-sensing for input is Disabled

Input # = Auto-sensing for input is Enabled



# Reference: Restoring Factory Defaults on the STB(s)

---

This section describes how to restore all factory defaults or just the Installer Menu factory defaults either on a single STB that is currently in Pass-through or FTG Mode or on multiple STBs that are currently in FTG Mode.

## Restore All Factory Defaults

This section describes how to restore a single STB, regardless of its mode, to a factory default condition. The following procedure requires that you contact LG technical support to obtain a predefined value/password for Installer Menu item 117 FACT DEFAULT that enables access to initiate a factory “IN-STOP” process, which restores all factory defaults. This procedure will also reactivate the EZ-Manager Wizard.

1. Use the Installer Remote to access the STB’s Installer Menu.
2. Navigate to Installer Menu item 117 FACT DEFAULT, and key in the value provided by technical support. Then, press **OK**.
3. At the prompt for confirmation, key in the password provided by technical support. This will initiate the IN-STOP that restores the factory defaults on the STB.

## Installer Menu Item 117 FACT DEFAULT

If the STB is currently in Pass-through Mode, you can set Installer Menu item 117 FACT DEFAULT to 1 to restore the Installer Menu factory defaults and clear the PTC Channel Map, including any assigned channel icons and custom text labels. Note, however, that if a complete restoration of the STB’s factory defaults is required, see “Restore All Factory Defaults” above.

## Additional FTG Mode via CPU Options

There are two additional options for restoring Pass-through Mode/Installer Menu factory defaults on STBs that are in FTG Mode via the CPU. The first enables you to restore a single STB to Pass-through Mode, while the second enables you to restore multiple STBs to Pass-through Mode at one time. However, both options require that you create a “Zero Mapped Channels” FTG Configuration (.tlx) file, i.e., an FTG Configuration file with no data. Refer to the *Free-To-Guest (FTG) File Manager User Guide* for further information.

- Using a USB memory device, import a “Zero Mapped Channels” FTG Configuration (.tlx) file to the STB. Refer to “Importing a Clone File” on pages 47 to 51 for further information on the import procedure.
- If your system uses a Pro:Centric server for remote management, use the Pro:Centric server Admin Client to load a “Zero Mapped Channels” FTG Configuration (.tlx) file on the Pro:Centric server. Refer to the *Pro:Centric Server Admin Client User Guide* for further information.

## Additional FTG Mode via EBL Options

There are two additional options for restoring Pass-through Mode/factory defaults on STBs that are in FTG Mode via the EBL. The first enables you to restore a single STB to Pass-through Mode, while the second enables you to restore multiple STBs to Pass-through Mode at one time.

 **Note:** While the IN-STOP process described above will clear both the PTC and the CPU, both options below only clear the PTC. Thus, the current Channel Map and STB setup menu settings will remain in the CPU after the reset is completed.

- Using a direct PC-to-STB connection, “Write” an unpopulated Channel Map—that is, a Channel Map with 0 (zero) channels—to the STB. See Reference section, “FTG Mode via EBL (Local Configuration),” and/or the *Free-To-Guest (FTG) Device Configuration Application User Guide* for further information.
- If your system uses an FMA for remote management/broadcast configuration, configure the FMA device with an FMA Configuration (.fma) file that only contains a “0 Mapped Channels” FTG Channel Map to broadcast to the STB EBL(s). Refer to the *Free-To-Guest (FTG) Device Configuration Application User Guide* and/or the Installation & Configuration Guide for the FMA device for further information.

# Reference: Using the STB's Zoning Features

---

This section describes the TV Zoning and Wi-Fi Zoning features available with the STB-3500. These features are primarily intended for use when the STB is configured for FTG Mode via CPU operation; however, Wi-Fi Zoning, along with selected elements of TV Zoning (Installer Menu and TV [STB] Setup Menu profile Zone assignments), may also be used with STB cloning processes using a USB memory device / “.tlx” file. Refer to the appropriate section(s) below for further information on the Zoning features and how to set the TV Zone # or Wi-Fi Zone # in an STB that is currently in Pass-through Mode.

## TV Zoning Feature

The TV Zoning feature enables you to create localized configurations for STBs/displays in selected locations, or “Zones,” within the installation environment, for example, a hotel lobby, fitness center, restaurant, etc.

### Using the TV Zoning Feature with FTG Mode via CPU Configuration

The FTG File Manager may be used to create an FTG Configuration (.tlx) file that contains multiple Installer Menu and TV Setup Menu profiles, each with its own Zone assignment. Up to nine unique Zones can be designated for STB-3500 FTG Installer Menu and/or TV Setup Menu profiles. Zone restrictions can also be placed on individual channels in the FTG Channel Map. Thus, for example, you may create an FTG Installer Menu and/or TV Setup Menu profile to specifically configure an STB/display in the hotel lobby and also restrict the channels that are available to be tuned on that STB/display.

The TV Zone # must be set appropriately on each STB in order for the STBs to be configured correctly. See “Set the TV Zone # and/or Wi-Fi Zone # in the STB” on page 76, and set the TV Zone # in all the STBs in a select area, so that the STBs/displays are configured with corresponding FTG Installer Menu and/or TV Setup Menu settings and/or can omit channels that have been restricted in the FTG Channel Map. TV Zone 0 is the default TV Zone #.

The following subsections briefly describe how to assign Zone designations in the FTG File Manager. Refer to the ***Free-To-Guest (FTG) File Manager User Guide*** for further information.

#### *FTG Installer Menu Profile Zone Assignments*

The FTG File Manager main screen enables you to change the Zone assignment (default = Zone 0) for each Installer Menu profile to be included in an FTG Configuration (.tlx) file. For example, you may wish to create one STB-3500 Installer Menu profile for the hotel lobby and another STB-3500 Installer Menu profile for the fitness center, both of which are different from the Installer Menu profile used for standard guest rooms. The TV Zoning feature enables you to save multiple STB-3500 FTG Installer Menu profiles, each with its own Zone assignment, in one FTG Configuration file. If each STB in the aforementioned locations (Zones) has had its TV Zone # set appropriately, as described in the procedure on page 76 or via the EZ-Manager Wizard, the STB(s) will only be configured by the Installer Menu profile that matches its(their) Zone setting.

In the FTG File Manager main screen, you can also edit the Zone assignment for each Installer Menu profile and/or TV Setup Menu profile already present in the FTG Configuration List and TV Setup Menu List windows.

**Note:** See also the FTG File Manager main screen overview on page 54. In addition, note that TV Setup Menu profiles cannot be created in the FTG File Manager; they must be saved (exported) from a TV/STB.

#### *FTG Channel Map Zone Restrictions*

The FTG Channel Map Editor in the FTG File Manager's FTG Channel Map Configuration Utility enables you to place Zone restrictions on individual channels that may be prohibited or deemed unsuitable for certain locations. In the FTG Channel Map Editor, one or more Zone restrictions (1–8) may be placed on each channel that is to be restricted. For example, if you wish to restrict a channel from Zones 2 and 4, select both “Zone 2” and “Zone 4” in the Zone Restriction section of the FTG Channel Map Editor screen when defining or editing that channel.

## Reference: Using the STB's Zoning Features (Cont.)

---

**Note:** While a channel can be restricted from up to eight Zones, an STB can only ever be in (set for) one Zone. See also the FTG Channel Map Editor overview on page 56.

At the same time, keep in mind that the TV Zone designations are not mutually exclusive. That is, you may opt to place Zone restrictions on selected channels in the FTG Channel Map, but at the same time, you can choose to configure all STBs/displays at the site with the same Installer Menu and/or TV Setup Menu settings. For example, an FTG Configuration (.tlx) file being used to configure the STBs/displays at a site may contain multiple Installer Menu and TV Setup Menu profiles with different Zone assignments, as well as an FTG Channel Map with Zone restrictions on several channels. Each STB that still has the default TV Zone 0 setting will *only* be configured by the Installer Menu and/or TV Setup Menu profile(s) with a Zone 0 designation. If, on the other hand, the TV Zone # is set to 1, the STB will first look in the file for the STB-3500 Installer Menu and/or TV Setup Menu profile(s) with a Zone 1 designation. If none of the STB-3500 Installer Menu and/or TV Setup Menu profiles has a Zone 1 designation, the STB will then look for the STB-3500 profile(s) with a Zone 0 designation. For the FTG Channel Map configuration, when the TV Zone # is set to 0, the STB will ignore any Zone restrictions (1–8) that may be placed on channels in the FTG Channel Map. However, when the TV Zone # is set to 1, the STB will omit any channels that have been restricted from Zone 1 in the FTG Channel Map.

### Using the TV Zoning Feature with Cloning Configuration

A location-specific configuration / Clone (.tlx) file may be saved (exported) from a Master STB and then be used to configure Target STBs. For example, if the TV Zone # in the Master STB is set to 3 before the Clone file export is initiated, the Master STB's Installer Menu and TV Setup Menu profiles will be saved with the TV Zone 3 assignment. In order to configure the Target STBs with the Zone 3 Installer Menu and TV Setup Menu profiles exported from the Master STB, you must set the TV Zone # accordingly in the Target STBs before importing the Clone file. See "Set the TV Zone # and/or Wi-Fi Zone # in the STB" on the following page. Also, see "Cloning Procedures" on pages 45 to 51 for additional information on the cloning processes. TV Zone 0 is the default TV Zone #.

### Wi-Fi Zoning Feature

The Wi-Fi Zoning feature enables you to use a Clone/Configuration (.tlx) file to configure an individual STB or group of STBs with a particular Wi-Fi access point's login data to create "Wi-Fi Zones" within the installation environment.

### Using the Wi-Fi Zoning Feature with FTG Mode via CPU Configuration

The FTG File Manager may be used to create an FTG Configuration (.tlx) file with an FTG Installer Menu profile that contains login data for multiple Wi-Fi access points, each assigned a Wi-Fi Zone #. Up to 100 Wi-Fi Zones can be designated within each FTG Installer Menu profile, thus allowing for distribution of the Wi-Fi network load. For example, if a site has 50 STB-3500s within close proximity, you may wish to create 10 Wi-Fi Zones, each with its own access point that has unique login data, so that no more than five of the STBs are connected to one access point at any given time.

In order for an STB to be configured by the proper Installer Menu profile with the desired Wi-Fi access point login data for wireless networking (i.e., SSID, security type, and security key), you must set both the TV Zone # and the Wi-Fi Zone # in the STB (see "Set the TV Zone # and/or Wi-Fi Zone # in the STB" on the following page for further information). If the Wi-Fi Zone # in the STB is set to 0 (default), the STB will not obtain access point login data from the Installer Menu profile with which it is configured unless the profile contains the global Wi-Fi Zone 100. Any STB that does not find its matching Wi-Fi Zone # in the FTG Configuration file, but that does find the global Wi-Fi Zone 100, will be configured with the global access point login data.

Refer to the **Free-To-Guest (FTG) File Manager User Guide** for further information on defining Wi-Fi Zones in the FTG File Manager.

## Reference: Using the STB's Zoning Features (Cont.)

---

### Using the Wi-Fi Zoning Feature with Cloning Configuration

A location-specific Wi-Fi configuration / Clone (.tx) file may be saved (exported) from a Master STB and then be used to configure Target STBs. First, the wireless network (i.e., the access point login data) must be configured in the Master STB's IP Environment Menu (see "Configuring a Wi-Fi Network Connection" on page 62). Then, a Wi-Fi Zone # must be set in the Master STB (see "Set the TV Zone # and/or Wi-Fi Zone # in the STB" below). If desired, a TV Zone # may also be set in the Master STB.

For example, if the Wi-Fi Zone # is set to 4 and the TV Zone # is set to 5 before the Clone file export is initiated, the Master STB's Installer Menu profile will be saved with the Zone 5 assignment, and within that Installer Menu profile, the access point login data for wireless networking (i.e., SSID, security type, and security key) will be saved with a Wi-Fi Zone 4 assignment. In order to configure the Target STBs with the proper Installer Menu profile and access point login data, you must set both the TV Zone # and the Wi-Fi Zone # in the Target STBs accordingly before importing the Clone file. See "Set the TV Zone # and/or Wi-Fi Zone # in the STB" below. Also, see "Cloning Procedures" on pages 45 to 51 for additional information on the cloning processes. If the Wi-Fi Zone # in the STB is set to 0 (default), the STB will not obtain access point login data from the Installer Menu profile with which it is configured unless the profile contains the global Wi-Fi Zone 100. Any STB that does not find its matching Wi-Fi Zone # in the Clone file, but that does find the global Wi-Fi Zone 100, will be configured with the global access point login data.

### Set the TV Zone # and/or Wi-Fi Zone # in the STB

You can set the TV Zone # and/or the Wi-Fi Zone # in the EZ-Manager Wizard (see "EZ-Manager Wizard" on pages 17 to 26) or, if the STB is in Pass-through Mode, via the STB's setup menus as described below. Note that the following procedure can only be performed while the STB is in Pass-through Mode. You will also be able to specify a Label (North, South, East, West) and Room Number for this STB, if desired.

1. Turn ON the STB/display panel.
2. Press **MENU** on the Installer Remote, and use the arrow navigation keys to select/highlight the **General** menu icon. Then, press **OK**.
3. In the General Menu, use the Up/Down arrow keys to select **Room Info**, and then press **OK**.
4. In the Room Info screen, complete the appropriate fields as described below. Use the Up/Down arrow keys on the Installer Remote to navigate between each of the fields.
  - **Wi-Fi Zone:** Enables you to set a Wi-Fi Zone # so that the STB can be configured with a particular access point's login data for wireless networking. Login data (i.e., SSID, security type, and security key) may be provided in a Clone/Configuration (.tx) file.  
To assign a Wi-Fi Zone, select/highlight the **Wi-Fi Zone** field and press **OK**. Then, use the Left/Right arrow keys to specify the desired Wi-Fi Zone # (1–99). Press **OK** when you are finished.
  - **TV Zone:** Enables you to set a TV Zone # so that the STB can be configured with Installer Menu and/or STB Setup Menu settings intended only for the assigned Zone. The Installer Menu and/or STB Setup Menu settings may be provided in a Clone/Configuration (.tx) file. If the STB is being configured for FTG Mode via CPU, the TV Zone # setting also allows the STB to omit channels that have been restricted in the FTG Channel Map (see "FTG Channel Map Zone Restrictions" on page 74).  
To change the TV Zone, select/highlight the **TV Zone** field and press **OK**. Then, use the Left/Right arrow keys to specify the desired TV Zone # (0–8). Press **OK** when you are finished.

(Continued on next page)

## Reference: Using the STB's Zoning Features (Cont.)

(Continued from previous page)

- **Label:** Allows you to select a North, South, East, or West text label for this STB. Select/highlight the **Label** field and press **OK**. Then, use the Up/Down arrow keys to select the applicable label. Press **OK** when you are finished.
  - **Room Number:** Allows you to specify the number of the room—up to 16 characters—in which the STB is located. To enter a room number, use the Up/Down arrow keys to select/highlight the **Room Number** field and press **OK**. You can then use the number keys on the Installer Remote to direct enter a room number, or you can use the arrow keys to select the appropriate alphanumeric character(s) from the pop-up virtual keyboard at the bottom of the screen. When you are done, select **Enter** from the virtual keyboard, and then press **OK** on the Installer Remote.
5. When you have completed the fields as necessary, press **↵** to return to and/or exit the STB menus, or press **MENU** to return to program viewing.

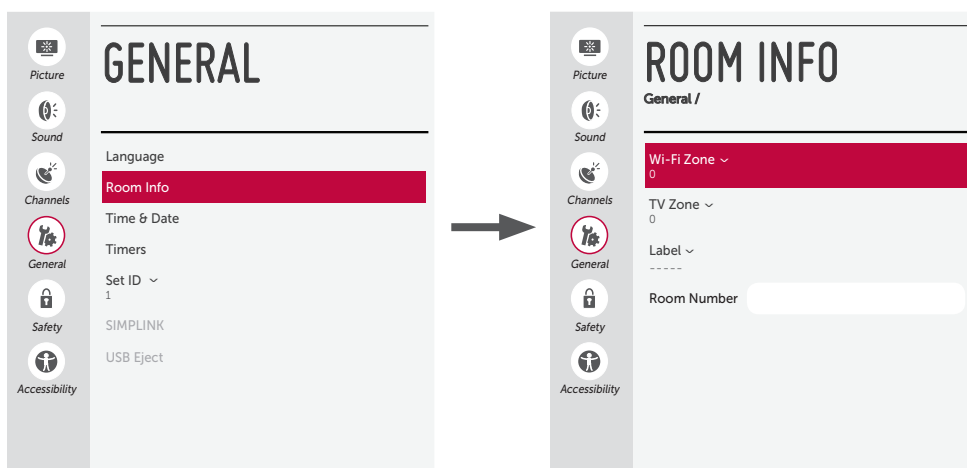

# Reference: Using Media Share Features

---

When the appropriate Media Share options are enabled in the IP Environment / Media Share Menu (see “Media Share Setup” on pages 64 to 65, as necessary), guests have the ability to use one or more of the following Media Share features:

- **Smart Share:** Allows guests to use the STB/display panel to access and view media files (photos, videos, music, etc.) shared either by wired DLNA Certified devices (the devices must be connected to the same LAN as the STB) or by wireless LG devices using LG’s Smart Share application with Wi-Fi Direct.
- **Screen Share:** Allows guests to select a Miracast or WiDi capable device, whose screen can be displayed on the display panel screen.
- **Bluetooth Sound Sync:** Allows guests to listen to audio from a Bluetooth-enabled mobile device through the display panel’s speakers.
- **DIAL:** Allows guests to play selected application media on the STB/display panel from a device with DIAL capability. The device may be used to cast any application for which an STB-compatible application has been created/selected for inclusion in the Pre-loaded Apps Menu (see “Pre-loaded Applications” on page 65).
- **SoftAP:** Allows guests to use the STB as a 2.4 GHz wireless access point for up to five devices.

This section provides an overview of the Smart Share, Screen Share, Bluetooth Sound Sync, DIAL, and SoftAP functionality.



**Note:** Typically, only one Media Share feature may be used at a time. If one feature is currently in use, you may have to exit or turn it OFF in order to use/turn ON another. In some cases, you will be prompted to confirm your action. Follow the display prompts as necessary.

## Smart Share

Refer to the subsections below for information on using the Smart Share features.

### Smart Share with DLNA Certified Devices

The following steps describe how to access and use the Smart Share feature with wired DLNA Certified devices on the same LAN as the STB.

1. Turn ON the STB/display panel, and then use one of the following methods to access media files/folders, depending on the current configuration of the STB:
  - If the Pro:Centric application is not loaded, press **PORTAL** on the Installer Remote, and use the Left/Right arrow keys to select **Smart Share** from the STB’s Smart Launcher.
  - If the Pro:Centric application is loaded, press **MENU** on the Installer Remote to display the Function Menu, use the Up/Down arrow keys to select/highlight the **General** menu icon, and then press **OK**. In the General Menu, use the Up/Down arrow keys to select **SmartShare**.

**Note:** Depending on the remote control being used (in any mode), you may also access the Smart Launcher via the SMART button.

2. In the Smart Share screen, select the desired Smart Share device, and then select the desired media category to view files.

## Reference: Using Media Share Features (Cont.)

### Smart Share with Wi-Fi Direct

The following steps describe how to access and use Wi-Fi Direct (i.e., to connect to a wireless LG device). Remember that you must also turn ON Wi-Fi Direct and launch the Smart Share application on the LG device.

**Note:** Screen Share MUST be enabled in the Media Share Menu in addition to Smart Share in order for guests to use Wi-Fi Direct (see “Media Share Setup” on pages 64 to 65).

1. Turn ON the STB/display panel, and press **MENU** on the Installer Remote to display the STB menus (either the setup menus or the Function Menu depending on whether the STB is or is not in Pass-through Mode).
2. Use the Up/Down arrow keys to select/highlight the **General** menu icon, and then press **OK**.
3. In the General Menu, use the Up/Down arrow keys to select **Wi-Fi Direct**, and then press **OK**.



**Note:** The example at left shows the General Menu when the STB is in Pass-through Mode. The Wi-Fi Direct screen is the same whether the STB is or is not in Pass-through Mode.

**Note:** If Wi-Fi Direct is currently grayed out, you may need to exit/turn OFF another Media Share feature in order to use Wi-Fi Direct. For example, make sure that SoftAP is turned OFF. See also note on previous page regarding simultaneous use of Media Share features.

4. When you access the Wi-Fi Direct screen, the STB will automatically initiate a search for all available Wi-Fi Direct enabled wireless devices, including mobile devices, laptops, etc. Devices found will be listed in the lower half of the screen.

**Note:** If the search does not initially locate any devices, you can select **REFRESH LIST** and press **OK** to rescan.

5. Use the Up/Down arrow keys to select/highlight the device with which you wish to share, and then press **OK**.

The share request will be sent to the targeted device. The user of that device may choose to allow or not allow the share connection. Similarly, other devices may request share connections with this STB (pop-up share requests typically appear in the bottom right of the display panel screen).

6. Use one of the following methods to access media files/folders, depending on the current configuration of the STB:

(Continued on next page)

## Reference: Using Media Share Features (Cont.)

---

(Continued from previous page)

- If the Pro:Centric application is not loaded, press **PORTAL** on the Installer Remote, and use the Left/Right arrow keys to select **SmartShare** from the STB's Smart Launcher.
- If the Pro:Centric application is loaded, use the Up/Down arrow keys to select **SmartShare** from the General Menu.

**Note:** Depending on the remote control being used (in any mode), you may also access the Smart Launcher via the SMART button.

7. In the Smart Share screen, select the desired Smart Share device, and then select the desired media category to view files.

### Screen Share (Miracast / WiDi)

The following steps describe how to access and use the Miracast / WiDi features.

1. Turn ON the STB/display panel, and then use one of the following methods to access the Screen Share application, depending on the current configuration of the STB:
  - If the Pro:Centric application is not loaded, press **PORTAL** on the Installer Remote, and use the Left/Right arrow keys to select **Screen Share** from the STB's Smart Launcher.
  - If the Pro:Centric application is loaded, press **MENU** on the Installer Remote to display the Function Menu, use the Up/Down arrow keys to select/highlight the **General** menu icon, and then press **OK**. In the General Menu, use the Up/Down arrow keys to select **Input**. In the Input Menu, use the Up/Down arrow keys to select **Screen Share**.

**Note:** Depending on the remote control being used (in any mode), you may also access the Smart Launcher via the SMART button.

**Note:** If Screen Share is currently not available in the Smart Launcher or in the Input Menu (the latter applicable to FTG Mode only), you may need to turn OFF another Media Share feature in order to use Screen Share. For example, access the General Menu and make sure that SoftAP is turned OFF. See also note on page 75 regarding simultaneous use of Media Share features.

2. Follow the on-screen instructions to initiate the Miracast / WiDi connection from your Miracast / WiDi device. Note that you may be prompted to enter a PIN number that appears on the display panel screen into your Miracast / WiDi connection window to complete the connection.

Once the connection is established, the STB display may be used as a second screen for the Miracast / WiDi device.

### Bluetooth Sound Sync

The following steps describe how to access and use the Bluetooth Sound Sync feature.

**Note:** Bluetooth Sound Sync is only accessible from the STB's Smart Launcher. If the Pro:Centric application is loaded, you will need a remote with a SMART button in order to display the Smart Launcher.

1. Turn ON the STB/display panel, and then use one of the following methods to display the STB's Smart Launcher, depending on the current configuration of the STB:

(Continued on next page)



## Reference: Using Media Share Features (Cont.)

---

(Continued from previous page)

- If the Pro:Centric application is not loaded, press **PORTAL** on the Installer Remote.
  - If the Pro:Centric application is loaded, press **SMART** on the Installer Remote (see note above regarding remote with SMART button).
2. Use the Left/Right arrow keys on the Installer Remote to select **Bluetooth Sound Sync**, and then press **OK**.
  3. Follow the on-screen instructions to initiate and confirm pairing between your device and the STB.

Once Bluetooth pairing is successful, audio from the device may be heard through the display panel's speakers. (Make sure the STB volume is at the appropriate level.)

### DIAL

The following steps describe how to access and use DIAL. Remember that the device used **MUST** be connected to the same network as the STB.

**Note:** DIAL may only be used with device applications for which a STB-compatible application (for example, YouTube) has been created/selected for inclusion in the Pre-loaded Apps Menu (see "Pre-loaded Applications" on page 65).

**Note:** The applications that may be used in conjunction with DIAL are only accessible from the STB's Smart Launcher. If the Pro:Centric application is loaded, you will need a remote with a SMART button in order to display the Smart Launcher.

1. Turn ON the STB/display panel, and then use one of the following methods to display the STB's Smart Launcher, depending on the current configuration of the STB:
  - If the Pro:Centric application is not loaded, press **PORTAL** on the Installer Remote.
  - If the Pro:Centric application is loaded, press **SMART** on the Installer Remote (see note above regarding remote with SMART button).
2. Use the Left/Right arrow keys on the Installer Remote to select the desired application, and then press **OK**.
3. On your device, launch the same application, and use the appropriate options (typically available via Settings) to initiate a connection/pairing with the STB. You may also need to access the Settings options from the application on the STB to complete the pairing operation. Follow the on-screen instructions.

Once the connection/pairing is successful, you will be able to view media from the application on the STB/display panel.

### SoftAP

The following steps describe how to access and use the SoftAP feature.

1. Turn ON the STB/display panel, and press **MENU** on the Installer Remote to display the STB menus (either the setup menus or the Function Menu depending on whether the STB is or is not in Pass-through Mode).

(Continued on next page)

## Reference: Using Media Share Features (Cont.)

(Continued from previous page)

2. Use the Up/Down arrow keys to select/highlight the **General** menu icon, and then press **OK**.

3. In the General Menu, use the Up/Down arrow keys to select **SoftAP**, and then press **OK**.

**Note:** If SoftAP is currently grayed out, make sure a wired LAN connection has been established.

4. When you initially access the SoftAP screen, the OFF/ON toggle button at the top right of the screen is selected/highlighted by default. If SoftAP is currently OFF, press **OK** on the Installer Remote to turn SoftAP ON. When SoftAP is ON, the SoftAP access information, including the SSID and security key, is displayed in the lower half of the screen.

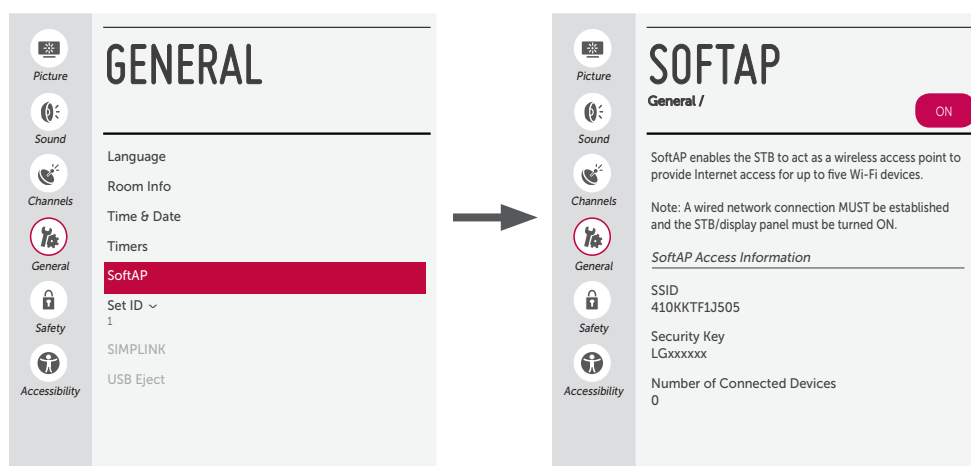

**Note:** The example at left shows the General Menu when the STB is in Pass-through Mode. The SoftAP screen is the same whether the STB is or is not in Pass-through Mode.

5. Make sure Wi-Fi is turned ON on your device, and then look for the STB's SSID in the list of available Wi-Fi networks. Initiate the connection, and enter the security key as requested.

Once a device is connected successfully to the STB's network, you can use it to access the Internet. Up to five devices may be connected at a time; the Number of Connected Devices field in the SoftAP screen shows the number of devices currently connected to the STB Wi-Fi access point.

**Note:** A wired network connection MUST be established in order for guests to use SoftAP. Also, the SoftAP feature may only be used while the STB/display panel is turned ON.

**Note:** If the Wi-Fi frequency is not automatically detected, set the frequency in the device(s) to 2.4 GHz.

# Reference: STB-3500 Jack Panels

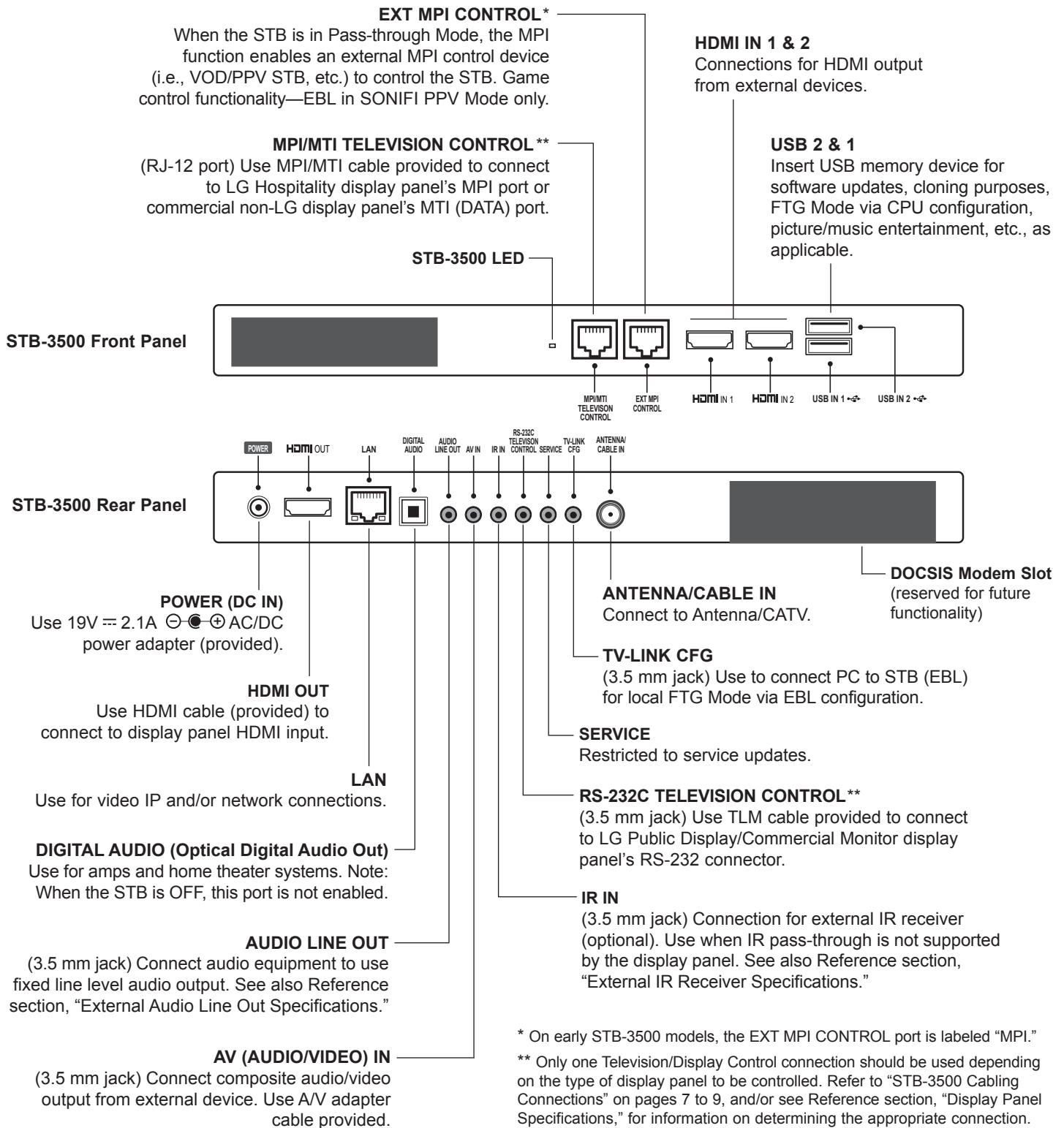

\* On early STB-3500 models, the EXT MPI CONTROL port is labeled "MPI."

\*\* Only one Television/Display Control connection should be used depending on the type of display panel to be controlled. Refer to "STB-3500 Cabling Connections" on pages 7 to 9, and/or see Reference section, "Display Panel Specifications," for information on determining the appropriate connection. Also, note that on early STB-3500 models, the RS-232C TELEVISION CONTROL jack is labeled "DISPLAY CONTROL 1" and the MPI/MTI TELEVISION CONTROL port is labeled "DISPLAY CONTROL 2."

## Reference: External IR Receiver Specifications

---

The IR IN 3.5 mm stereo jack on the rear panel of the STB-3500 provides an input for an optional external IR receiver (Example: Sung Nam Electronics EAD61273113). The jack provides external IR VCC of 3.5 volts. Refer to the following diagram for pinout details.

 **Caution: Do NOT plug in a mono connector, as this may damage the STB.**

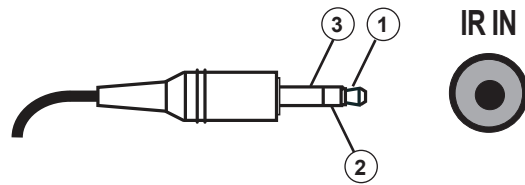

---

1	+3.5 v (VCC)
2	IR SIGNAL (VOUT)
3	GND

---

## Reference: External Audio Line Out Specifications

---

The AUDIO LINE OUT 3.5 mm stereo jack on the rear panel of the STB-3500 provides stereo analog audio output for external audio equipment. Installer Menu item 097 AUDIO OUTPUT must be set to either 8 or 9 to make analog audio output available. See Installer Menu item 097 AUDIO OUTPUT description on page 39 for additional information. Also, refer to the following diagram for pinout details.

 **Caution: Do NOT plug in a mono connector, as this may damage the STB.**

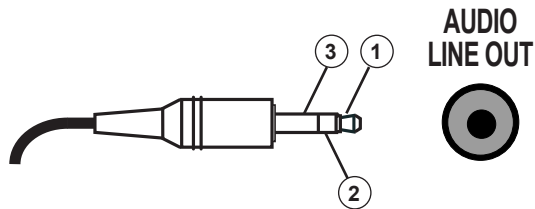

- 
- |   |                 |
|---|-----------------|
| 1 | LEFT (Tip)      |
| 2 | RIGHT (Ring)    |
| 3 | GROUND (Sleeve) |
-

# Reference: Installer Remote Control Typical Key Functions

An LG Installer Remote is required to set up and operate the STB/display panel. The LG Installer Remote illustrated below shows typical remote control functions and is provided for reference only.

**⏻ (POWER)**  
Turns the STB/display ON or OFF

**SMART**  
Displays the STB's Smart Launcher.

**TV DVD INPUT TIMER**  
Select the remote's operating mode: TV or DVD.

**INPUT**  
Displays available Aux inputs.

**TIMER**  
Sets the amount of time before the STB automatically turns itself OFF.

**Numbers (0 - 9) & DASH**  
Use to enter a channel or program number. Dash is used for sub-channel numbers such as 2-1, 2-2, etc.

**FLASHBK (FLASHBACK)**  
Returns to the previously tuned channel or input.

**VOLUME UP/DOWN**  
Increases/decreases sound level.

**CC**  
Activates subtitles.

**VD/\***  
Enables VD function. Also enables SAP feature (Analog Mode: Selects MTS sound [Mono, Stereo, or SAP]. DTV Mode: Changes audio program language, if additional languages are available).\*

**MUTE**  
Switches sound ON or OFF.

**CHANNEL/PAGE UP/DOWN**  
Changes channels based on channels in the channel lineup. Moves to previous or next screen in Pro:Centric channel guide.

**Color buttons** access special functions in some menus.

**DVD/USB buttons**  
Use to control DVD player or view USB memory device content.

**SMART**  
Displays the STB's Smart Launcher.

**TV/DVD**  
Select the remote's operating mode: TV or DVD.

**INPUT**  
Displays available Aux inputs.

**TIMER**  
Sets the amount of time before the STB automatically turns itself OFF.

**Arrows (Up/Down/Left/Right) & OK**  
Use to navigate on-screen menus, direct tune channels, and adjust STB settings.

**MENU SETTINGS**  
Displays and removes the STB setup menu (or, if applicable, the Function Menu).

**PORTAL**  
Displays and removes the Pro:Centric interactive menu.

**INFO**  
Displays channel information.

**GUIDE**  
Displays and removes the Pro:Centric channel guide/EPG.

**↶ (RETURN)**  
Returns one level to the previous menu/display.

**EXIT**  
Clears all on-screen displays and returns to program viewing.

**\* SAP notes:**

- If SAP is selected and no SAP is provided, sound may not be heard on channel.
- Each channel may have its own SAP setting.
- Each time digital channels are tuned, the STB attempts to locate the default audio program language. If the default audio program language is not available, the STB will use the first available audio program.

If you are using an LG display panel, the LG remote provided with the display panel should be sufficient. However, if you are using a commercial non-LG display panel or if you intend to use multiple STBs/displays in a single room installation environment, an LG Installer Remote dedicated to STB control (see example at right) is available for purchase.

The STB Installer Remote illustrated on the right shows typical remote control functions and is provided for reference only.

For additional information and/or to purchase an STB Installer Remote, please contact your LG service representative.

### Installer Remote Functionality

The STB Installer Remote provides the same standard configuration functionality as a typical LG Installer Remote, along with multi-code capability. See also “Installer Remote Control Typical Key Functions” information on the previous page.

### Set the STB Installer Remote IR Code Scheme (Multi-code Feature)

This section describes how to set the STB Installer Remote to send unique IR codes based on “bed number” in a multi-STB/display single room installation. The remote may be set from Bed 1 to Bed 9.

**Note:** The STB will always respond to the standard LG Installer Remote IR code scheme, i.e., you can always use an LG TV Installer Remote with the STB, regardless of its multi-code IR setting.

The following procedure describes how to set the bed number in the STB Installer Menu and in the STB Installer Remote.

1. Installer Menu item 020 FEATURE LEVEL determines the additional IR code scheme to which the STB will respond. Access the STB Installer Menu, and set item 020 to the desired value (16–24).

The STB Installer Remote must now be set to match the FEATURE LEVEL setting. That is, if item 020 is set to 17 for Bed 2, the STB Installer Remote must also be set to multi-code Bed 2.

**Note:** By default, the STB Installer Remote IR code scheme is the same as the standard LG TV Installer Remote IR code scheme.

2. On the STB Installer Remote, press and hold **OK** along with the desired (bed) number key (1–9).

The TV LED at the top left of the remote will light for three seconds and then turn OFF.

3. Once the TV LED turns OFF, release both keys on the remote.
4. Verify that the STB Installer Remote now controls the STB/display, based on your settings.

**Note:** If necessary, you can restore the STB Installer Remote IR code scheme to the standard LG Installer Remote IR code scheme by pressing and holding **OK** on the remote along with the “0” key.

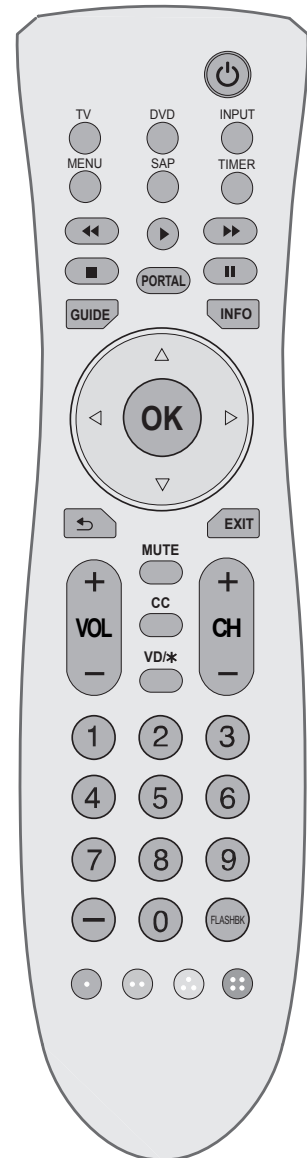

# Troubleshooting

## General Troubleshooting (Some Quick and Easy Tips for Resolving Problems)

### Installation

Symptom	Possible Cause(s)	Possible Solution(s)
Cannot direct enter channel number.	(STB in Pass-through Mode) Installer Menu item 028 CH. OVERRIDE is set to 0, i.e., disabled (recommended setting).	If Installer Menu item 028 CH. OVERRIDE is set to 0, only channels that are active in the STB's channel lineup can be selected. Set item 028 to 1 to allow access for direct keypad entry to all channels.
	(STB in FTG Mode) The channel entered is not included in the FTG Channel Map.	Channel access is restricted to channels included in the FTG Channel Map. If necessary, make changes to the FTG Channel Map using the appropriate LG FTG software.

### Power

Symptom	Possible Cause(s)	Possible Solution(s)
No power.	See STB Quick Check flow chart on following page.	

### Picture Reception and Sound

Symptom	Possible Cause(s)	Possible Solution(s)
No picture.  * See also STB Quick Check flow chart on following page. ** See "STB Cabling Connections" on pages 7 to 9.	Display panel is turned OFF.*	<ul style="list-style-type: none"> <li>• Check the Television/Display Control cabling.**</li> <li>• Check that the display panel is connected to its AC power source.</li> </ul>
	Display panel is not receiving signal from STB or is not displaying STB content.*	<ul style="list-style-type: none"> <li>• Check the HDMI cabling.** If you are not using HDMI1 on the display panel, make sure Installer Menu item 100 VIDEO INTERFAC is set correctly.</li> <li>• (TLM or MTI connection only) Check that Installer Menu item 110 PANEL DELAY is set appropriately.</li> </ul>
	Antenna/cable not connected.	Connect antenna/cable signal to STB.
	Encrypted program.	Try another channel.
	Wrong tuning band.	Adjust Installer Menu settings.
Normal picture, poor or no sound.	Audio muted.	Press MUTE or use Volume Up key to increase sound level.
	Broadcast problem.	Try a different channel.

### Erratic Operation

Symptom	Possible Cause(s)	Possible Solution(s)
Installer Menu setup.	Wrong Installer Menu settings.	Adjust Installer Menu settings as required.

### Installer Remote (not supplied with STB)

Symptom	Possible Cause(s)	Possible Solution(s)
Remote doesn't work.	Television/Display Control not connected properly.	Use appropriate Television/Display Control cable (provided) to connect the STB to the display panel. See "STB Cabling Connections" on pages 7 to 9.
	Remote not in TV Mode.	Use MODE key to select "TV"; puts remote into TV Mode.
	Not aimed at IR receiver.	Point remote at IR receiver on display panel.
	Remote too far from IR receiver or IR path is obstructed.	Move remote closer to IR receiver on display panel, darken room, and/or remove obstructions.
	MPI not connected.	If applicable, connect MPI cable to MPI device.
	Weak batteries.	Replace batteries.
	Wrong battery polarity.	Check that "+" and "-" match in battery compartment.
	Too much light in room.	Dim room light.
Wrong Installer Remote.	Requires compatible LG Installer Remote (see examples in this document). Contact your LG representative.	



This flowchart assumes that you have installed the STB/display panel in accordance with the STB Cabling Connections procedure on pages 7 to 9 and a subsequent functionality and/or communication failure has occurred.

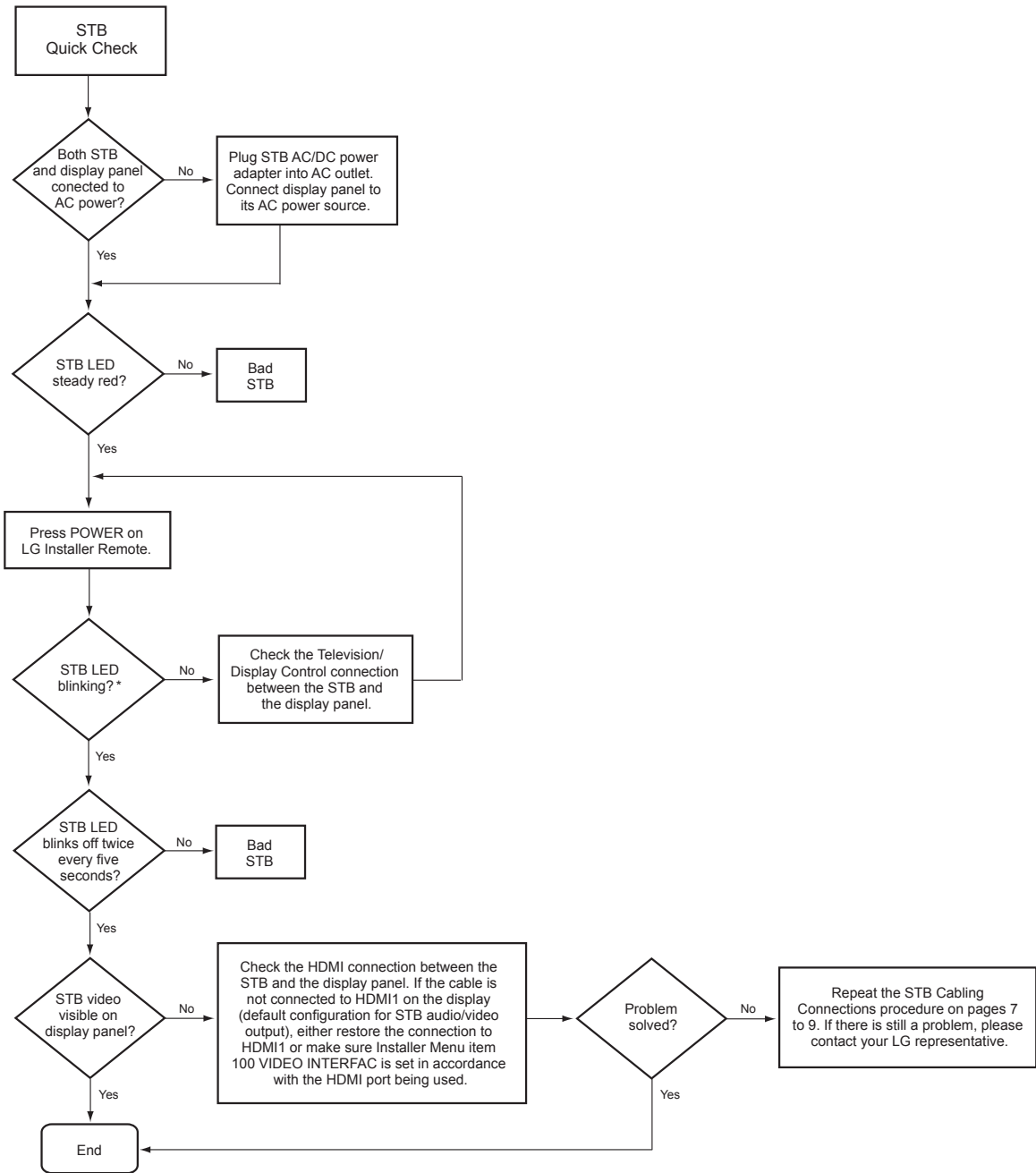

\* While the STB is turning ON and sending commands to turn ON the display panel, the LED on the STB's front panel blinks at a constant rate. Once both the STB and the display panel are ON, the STB LED remains lit but blinks off twice in rapid succession every five seconds.

# Troubleshooting (Cont.)

## Commercial Mode Check / FTG Operation Troubleshooting

### Commercial Mode Check

Use this flowchart to determine whether the STB is currently in Commercial Mode.

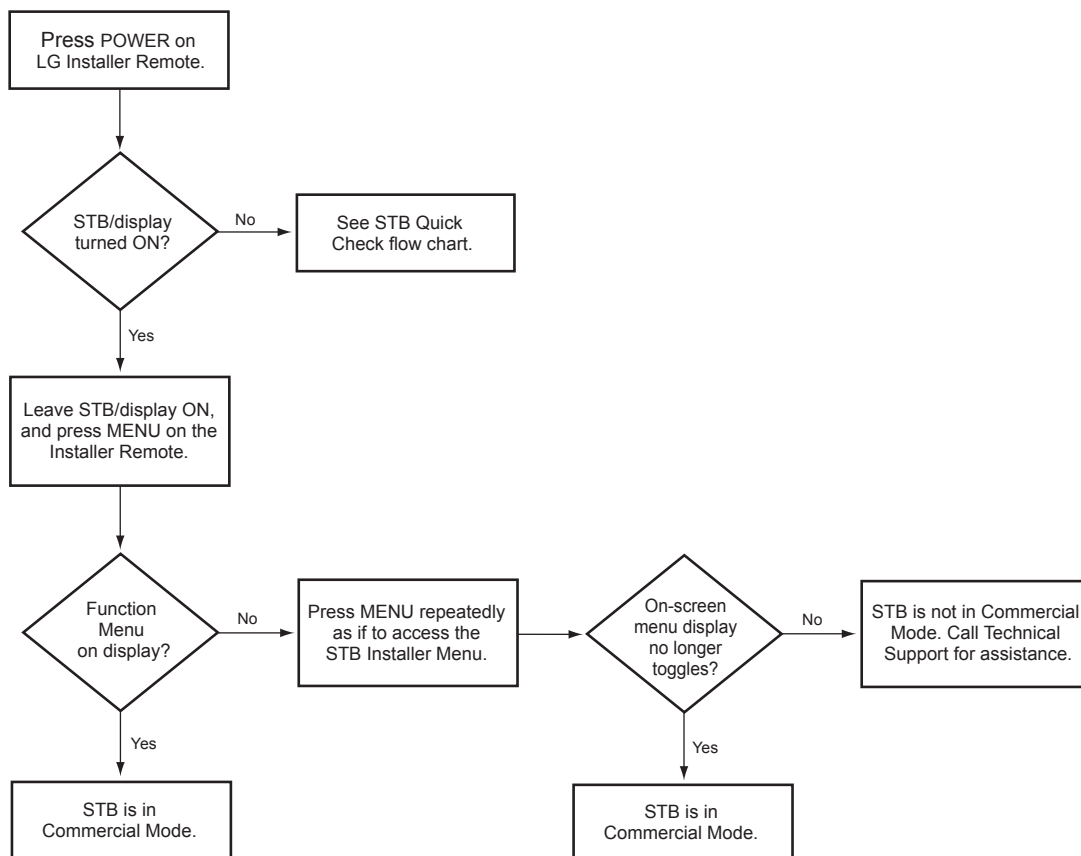

### FTG Operation Troubleshooting

The following table provides troubleshooting information for when the EBL is configured for FTG Mode operation.

Symptom	Possible Cause(s)	Solution(s)
Communication Error ("Communications Timeout")	Cable(s) not connected.	Check and connect communication cables.
	STB not powered.	Check/connect the STB power cord.
	STB not turned ON.	STB needs to be turned ON (default setting of Installer Menu item 118 POWER SAVINGS).
	Wrong COM (communication) port.	In the FTG Device Configuration Application, select the correct COM port for the cable being used.

## **b-LAN**

SONIFI Solutions, Inc. proprietary RF communication system used to configure/control STB via RF distribution system.

## **Channel Lineup**

Channels set in the STB memory, via Auto Tuning/manual editing.

## **Cloning**

The process of capturing a Master STB Setup and transferring it to a Target STB using a USB memory device.

## **Commercial Mode**

A mode of operation that provides a broad range of commercial STB features based on control (settings) provided by the PTC and/or an MPI control device.

## **CPU**

The STB's Central Processing Unit. Responsible for the presentation of video and audio from content received via the STB's tuner or Aux inputs.

## **E-Z Installation**

Enables STB configuration and software/firmware file downloads to selected STB models from a Pro:Centric server. Managed and administered via the Pro:Centric Admin Client.

## **EBL**

Embedded *b*-LAN module. See also *b*-LAN.

## **EZ-Manager Wizard**

Lodging model STB configuration wizard that provides configuration options for Pro:Centric operation as well as an option for using a USB memory device to configure an STB.

## **FTG Channel Map**

Typically refers to a logical channel mapping of physical RF channels. This allows digital channels, like analog channels, to be tuned without requiring the dash key. Also, channels (analog or digital) can be arranged in any order that seems logical for customer tuning/viewing.

## **FTG Mode**

LG commercial STB mode that enables decryption of Pro:Idiom encrypted channels and logical channel mapping. Implementation and STB operation is based on the "owner" of the FTG Channel Map—the CPU or the EBL. STBs may be configured locally using

LG's proprietary PC software or remotely using an applicable head end device.

## **Function Menu**

Available via Installer Remote "MENU" key. Indicates the STB is not in Pass-through Mode. Restricts menu options to a subset of the STB setup menus, allowing users to retain functional control, while disabling setup options.

## **Installer Menu**

Defines commercial STB functionality based on the parameters set.

## **LG Free-To-Guest (FTG)**

Refers to a particular commercial mode of operation within an LG STB. See also FTG Mode.

## **Logical Channel Number**

A number assigned to either a physical or virtual channel number in a Logical Channel Map.

## **Major Channel Number**

Typically, the RF channel number assigned to a digital video stream.

## **Master STB**

An STB whose Channel Map and Installer Menu and STB setup menu settings have been configured as a Master STB Setup for cloning purposes.

## **Minor Channel Number**

A sub-channel or program number assigned to the content embedded in the digital video stream.

## **MPI**

Multiple Protocol Interface. An EXT MPI CONTROL port or, for some STB models, an MPI card slot provides external control options for solution providers.

## **MTI**

Multiple Television Interface. SONIFI Solutions, Inc. proprietary protocol used for STB configuration/control via an MTI (typically labeled "DATA") port.

## **Pass-through Mode**

The STB's factory default mode of operation. STBs can be configured for stand-alone use or as Master STBs for cloning purposes, and/or STBs may be controlled externally in this mode.

## **Physical Channel Number**

The major channel number assigned to represent a specific 6 MHz RF band as specified by either the broadcast or CATV channel plan. See CEA (formerly EIA) or NCTA specifications for further information.

## **Pro:Centric Application**

LG content delivery and communication interface that provides interactive entertainment, weather, amenities, etc. information for end users. (Powered by Pro:Centric server.)

## **Pro:Centric Admin Client**

Web editor/content wizard provided for service provider and customer configuration of Pro:Centric application and management elements.

## **Pro:Idiom**

Zenith proprietary security software that unlocks access to premium content to help assure rapid, broad deployment of HDTV and other high-value digital content.

## **PTC**

Protocol Translator Card. The commercial controller (microprocessor) of the commercial STB.

## **Target STB**

An STB to which a Master STB Setup will be transferred.

## **STB Setup Menus**

Available via Installer Remote "MENU" key in Pass-through Mode only. Menus provide access to setup and functional features of the STB.

## **USB Memory Device**

A USB flash drive or USB storage device, etc. that can be used for STB configuration purposes (typically cloning or FTG Mode via CPU configuration) or for updating STB software.

## **Virtual Channel Number**

An alias (virtual) channel number provided in the data stream, by the broadcaster, of a digital broadcast channel to be displayed by consumer STBs in place of the physical channel number. The major number is the same as the original analog channel number and the minor number is the nth program available in that digital video stream.

# Document Revision History / Open Source Software Notice

---

## Document Revision History

<b>Date</b>	<b>Description</b>
April 2015	Revision A: New document
June 2015	Revision B: Cabling connections and labeling updates
July 2015	Revision C: Teach To STB (TLX) and Media Share updates
October 2015	Revision D: STB cable connections update
November 2015	Revision E: Bluetooth Sound Sync added
March 2016	Revision F: Installer Menu item 049 update
May 2016	Revision G: Updates for webOS 2.0
January 2017	Revision H: IM item 119 setup update

Product documentation is available online at: [www.lg.com/us/commercial](http://www.lg.com/us/commercial).

---

## Open Source Software Notice

To obtain the source code under GPL, LGPL, MPL and other open source licenses, that is contained in this product, please visit <http://opensource.lge.com>. In addition to the source code, all referenced license terms, warranty disclaimers and copyright notices are available for download. LG Electronics will also provide open source code to you on CD-ROM for a charge covering the cost of performing such distribution (such as the cost of media, shipping and handling) upon e-mail request to [opensource@lge.com](mailto:opensource@lge.com). This offer is valid for three (3) years from the date on which you purchased the product.



---

For Customer Support/Service, please call:

**1-888-865-3026**

[www.lg.com/us/commercial](http://www.lg.com/us/commercial)

Pro:Idiom is a registered trademark of Zenith Electronics LLC. Pro:Centric, Smart Share, and the "LG" logo are registered trademarks of LG Electronics Inc. *b*-LAN is a trademark of SONIFI Solutions, Inc. DLNA Certified is a registered trademark of Digital Living Network Alliance. Intel is a registered trademark of Intel Corporation in the U.S. and/or other countries. Wi-Fi Direct and Miracast are registered trademarks of Wi-Fi Alliance. All other trademarks or registered trademarks are the property of their respective owners.