



website:<http://www.lgservice.com>

LRSC 26945TT

LRSC 26944TT

LRSC 26930TT

LRSC 26922TT

LRSC 26920TT

LRSC 26911TT

LRSC 26910TT

LRSC 26944SW

LRSC 26930SW

LRSC 26922SW

LRSC 26920SW

LRSC 26911SW

LRSC 26910SW

REFRIGERATOR

User's Guide

Please read this guide thoroughly before operating and keep it handy for reference at all times.

REFRIGÉRATEUR

Manuel d'utilisation

Prière de lire attentivement le présent manuel avant d'utiliser le réfrigérateur.

Conserver à portée de main pour pouvoir le

FRIGORÍFICO

Guía de usuario

Lea detenidamente estas instrucciones antes utilizar el frigorífico y guárdelas como referencia para el futuro.

Table of Contents

Introduction	Entry	3
	Important Safety Instruction	3
	Identification of Parts	4
Installation	Where to Install	5
	Door Removal	6
	Door Replacement	7
	Water Pipe Installation	7
	Water Connection Instruction Guide	8
	Operation Instruction Guide	10
	Height Adjustment	12
Operation	Starting	13
	Adjusting the Temperatures and functions (Dispenser/Automatic Icemaker)	13
	Shelf	19
	Wine Holder	19
	Can Server Adjustment	19
	Egg Bin	20
	Humidity Control in the Vegetable Compartment	20
	Convert Into a Vegetable or Meat Compartment	20
	Optichill Temperature Transition Corner	21
	Temperature Change at Optichill	21
	Optichill	21
Suggestion on Food Storage	Location of Foods	22
	Storing Foods	23
Care and Maintenance	How to Dismantle Parts	24
	General Information	26
	Cleaning	26
	Troubleshooting	27

Entry

The model and serial numbers are found on the inner case or back of refrigerator compartment of this unit. These numbers are unique to this unit and not available to others. You should record requested information here and retain this guide as a permanent record of your purchase. Staple your receipt here.

Date of purchase : _____
 Dealer : _____
 Dealer address : _____
 Dealer phone no. : _____
 Model no. : _____
 Serial no. : _____

Important safety instruction

Before use, this refrigerator must be properly installed and located in accordance with the installation instructions in this manual.

Never unplug your refrigerator by pulling on the power cord. Always grip the plug firmly and pull it straight out from the outlet.

When moving your appliance away from the wall, be careful not to roll over the power cord or to damage it in any way. Do not crush or damage the water line.

After your refrigerator is in operation, do not touch the cold surfaces in the freezer compartment, particularly when your hands are damp or wet. Skin could adhere to these extremely cold surfaces.

Unplug the power cord from the power outlet for cleaning or other requirements. Never touch it with wet hands because you can get an electric shock or be injured.

Never damage, bend, kink, pull out, or twist the power cord because damage to the power cord can cause product failure, fire, or electric shock. If you have doubts the appliance is properly grounded, consult a qualified electrician.

Never place glass products in the freezer because they may be broken from expansion when their contents are frozen.

Never put your hands within the ice storage bin of the automatic icemaker. You can be injured by the operation of the automatic icemaker.

The appliance is not intended for use by young children without supervision.

Young children should be supervised to ensure that they do not play with the appliance.

Never allow anyone to climb, sit, stand, or hang on the door. These actions may damage the refrigerator and even tip it over, causing severe personal injury.

Before you move your refrigerator into its final location, it is important to make sure you have the proper electrical connection:

A 115 Volt, 60 Hz., AC only 15, or 20 ampere fused, grounded electrical supply is required. It is recommended that a separate circuit serving only your refrigerator be provided. Use an outlet that cannot be turned off by a switch. Do not use an extension cord.

The refrigerator-freezer should be so positioned that the supply plug is accessible for quick disconnection in the event of an emergency.

If the supply cord is damaged, it must be replaced by the manufacturer or its service agent or a similarly qualified person in order to avoid any hazard.

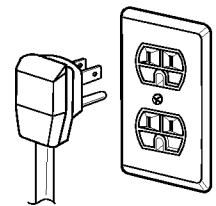

**Recommended
Grounding
Method**

**Accessibility of
Supply Plug
Supply Cord
Replacement**

Child Entrapment Warning

DANGER: Risk of child entrapment.

Before you throw away your old refrigerator or freezer:

Take off the doors but leave the shelves in place so that children may not easily climb inside.

The appliance is not intended for use by young children without supervision.

Young children should be supervised to ensure that they do not play with the appliance.

Don't Store

Don't store or use gasoline or other flammable vapor and liquids in the vicinity of this or any other appliance.

Grounding (Earthing)

In the event of an electric short circuit, grounding (earthing) reduces the risk of electric shock by providing an escape wire for the electric current.

In order to prevent possible electric shock, this appliance must be grounded.

Improper use of the grounding plug can result in an electric shock. Consult a qualified electrician or service person if the grounding instructions are not completely understood, or if you have doubts on whether the appliance is properly grounded.

Identification of Parts

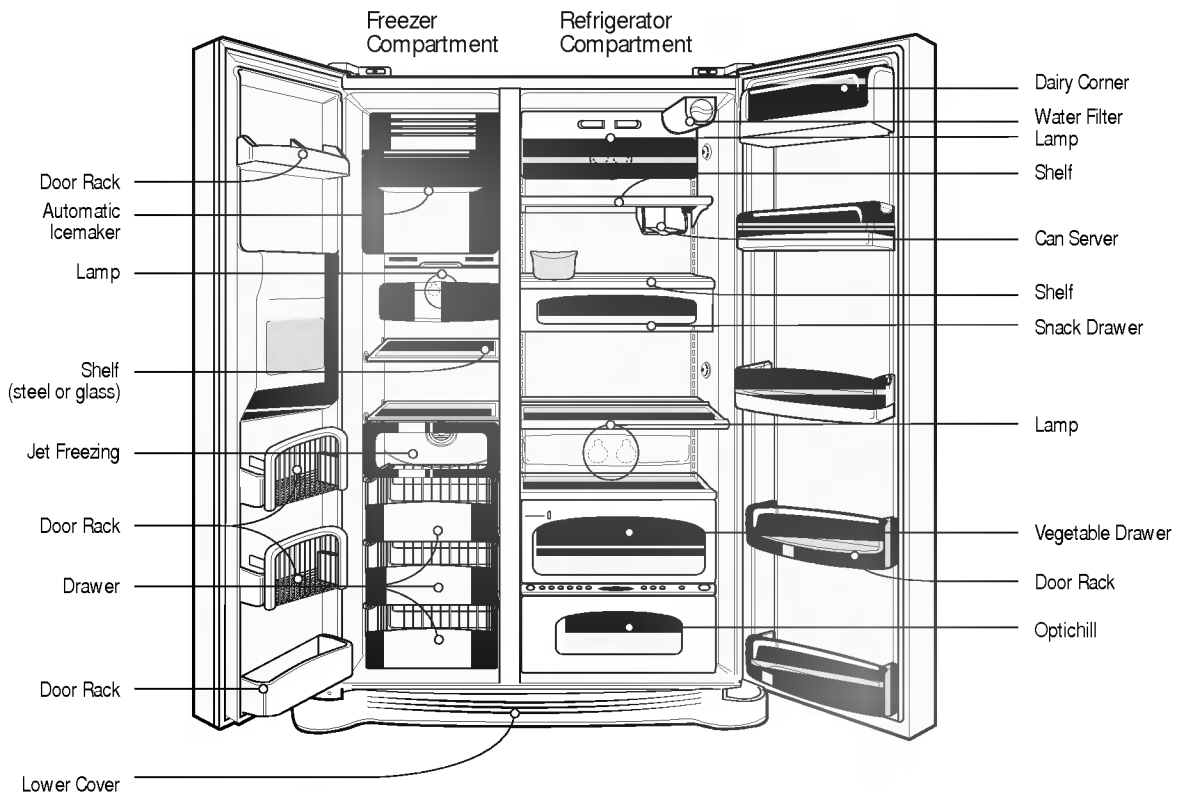

NOTE

- If you found some parts missing or different from your unit, they may be parts only used in other models. (i.e. the Optichill is not included in all models)

Select a Good Location

Where to Locate

1. Place your appliance where it is easy to use.
2. Avoid placing the unit near heat sources, direct sunlight, or moisture.
3. To avoid vibrations, the appliance must be leveled.
4. Do not install this refrigerator in areas where the ambient temperature is below 41°F. It will have an adverse effect on performance.

Warning

Remove Lower Cover and Water Feed Tube

Remove the Freezer Compartment Door

Remove the Refrigerator Door

Door removal

Electric Shock Hazard

Disconnect electrical supply to refrigerator before installing. Failure to do so could result in death or serious injury.

If your entrance door is too narrow for the refrigerator to pass through, remove the refrigerator door and pass the refrigerator laterally.

Remove the lower cover by lifting upward, and then pull up the water feed tube while pressing area ① shown in the figure to the right.

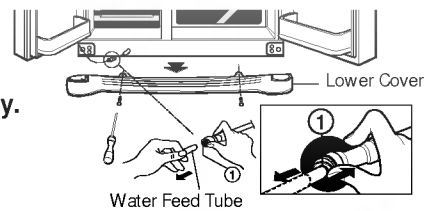

NOTE

- If a tube end is deformed or abraded, trim the part away. Disconnecting the tube under the door causes about 1.5 liters water to flow out. Please put up a big container to prevent it.

1) Removing the hinge cover by loosening the screws. Disconnect all connections except the ground line.



2) Remove the keeper by rotating it counter clockwise ① and then lifting the upper hinge up ②.

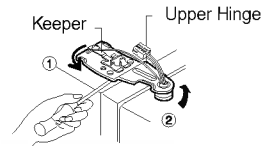

NOTE

- When removing the upper hinge, be careful that the door does not fall forward.

3) Remove the freezer compartment door by lifting it upward. This time, the door should be lifted enough for the water feed tube to be completely pulled out.



NOTE

- After removing the door, take it into the kitchen where you are installing the refrigerator. Lay it down on a blanket and be careful to avoid damaging the water feed tube.

1) Loosen the hinge cover screws and remove the cover. Remove connection wire, if any, except for the ground line.

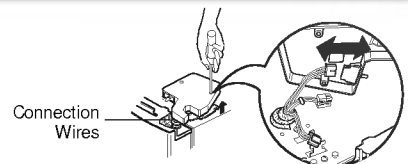

2) Remove keeper by rotating it clockwise ① and then remove the upper hinge by lifting it up ②.

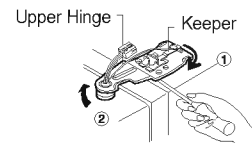

3) Remove the refrigerator compartment door by lifting it up.

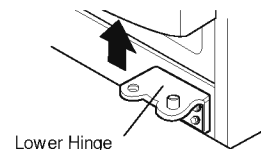

Move the Refrigerator

Push the refrigerator sideways through the entrance door as shown in the right picture.

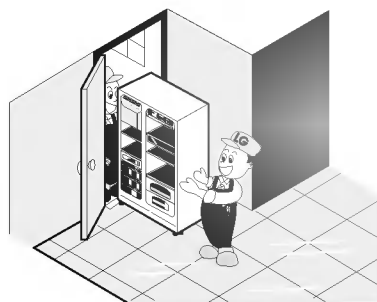

Door replacement

Mount the doors in the reverse order of removal after the refrigerator is brought to the installation area.

Feed water tube installation

Before Installation

- Automatic icemaker operation needs water pressure of 21.3~121psi(lb/inch²) (That is, an instant paper cup (7oz) will be fully filled within 3 sec.).
- If water pressure does not reach the rating 21.3psi(lb/inch²) or below, it is necessary to purchase a separate pressure pump for normal automatic icemaking and cool water feed.
- Keep the total length of the water feed tube within 40 feet and be careful not to bend or kink the tube. If the tube is longer than 40 feet, the icemaker and water dispenser will not operate properly.
- Install the water feed tube at a place free from heat.

Warning

- Connect to potable water supply only.
- Refer to instructions with water filter kit for installation.

Connecting the Refrigerator to a Water Source

Warning

Water Connection Instruction Guide

Read all directions carefully before you begin.

Connect to potable water supply only.

IMPORTANT

- If operating the refrigerator before installing the water connection, turn icemaker to the **OFF** position to prevent operation without water.
- All installations must be in accordance with local plumbing code requirements.
- Use copper tubing and check for leaks.
- Install copper tubing only in areas where temperatures will remain above freezing.
- It may take up to 24 hours for your icemaker to begin producing ice.

Tools Required

- Standard screwdriver
- 7/16-inch and 1/2-inch open-end wrenches or two adjustable wrenches
- 1/4-inch nut driver
- 1/4-inch drill bit
- Hand drill or electric drill (properly grounded)

NOTE

- Your refrigerator dealer has a kit available with a 1/4-inch saddle-type shut-off valve, a union, and copper tubing. Before purchasing, make sure a saddle-type valve complies with your local plumbing codes. Do not use a piercing-type or 3/16-inch saddle valve which reduces water flow and clogs more easily.

Cold Water Supply

The icemaker water valve contains a flow washer which is used as a water pressure regulator.

The icemaker needs to be connected to a cold water line with water pressure 30~120psi(lb/inch²)

Connect the Tubing to Water Line

1. Unplug refrigerator or disconnect power.
2. Turn OFF main water supply. Turn on the nearest faucet to relieve the pressure on the line. It may help to open an outside hydrant to allow the water to drain from the line in the house.
3. Find a 1/2-inch to 1-1/4-inch vertical COLD water pipe near the refrigerator.

NOTE

- Horizontal pipe will work, but the following precaution must be taken: Drill on the top of the pipe, not the bottom. This will help keep water away from the drill. This also keeps normal sediment from collecting in the valve.

4. To determine the length of copper tubing you will need, measure from the connection on the lower left rear of the refrigerator to the water pipe. Add 7 feet (2.1m) to allow for moving refrigerator for cleaning. Use 1/4-inch O.D. (outside diameter) copper tubing. Be sure both ends of copper tubing are cut square.
5. Using a drill, drill a 1/4-inch hole in the cold water pipe you have selected.
6. Fasten shut-off valve to cold water pipe with pipe clamp. Be sure outlet end is solidly in the 1/4-inch drilled hole in the water pipe and that the washer is under the pipe clamp. Tighten packing nut. Tighten the pipe clamp screws carefully and evenly so washer makes a watertight seal. Do not overtighten or you may crush the copper tubing, especially if soft (coiled) copper tubing is used. Now you are ready to connect the copper tubing.
7. Slip compression sleeve and compression nut on copper tubing as shown. Insert end of tubing into outlet end squarely as far as it will go. Screw compression nut onto outlet end with adjustable wrench. Do not over tighten.
8. Place the free end of the tubing into a container or sink, and turn ON main water supply and flush out tubing until water is clear. Turn OFF shutoff valve on the water pipe. Coil the copper tubing as shown below.

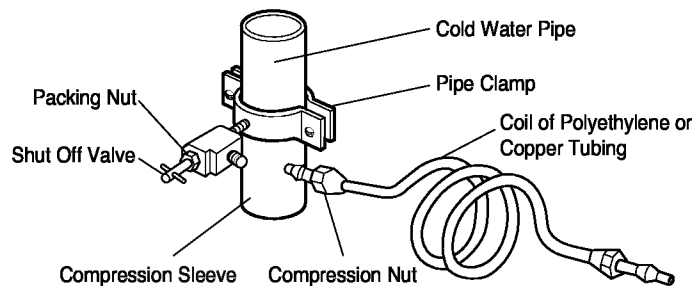

Operation Instruction Guide

Connect the Tubing to the Refrigerator

Before making the connection to the refrigerator, be sure the refrigerator power cord is not plugged into the wall outlet.

- If your refrigerator does not have a water filter, we recommend installing one. If your water supply has sand or particles that could clog the screen of the refrigerator's water valve. Install the filter in the water line near the refrigerator. Remove the plastic flexible cap from the refrigerator connection.

1. Remove the plastic flexible cap from the water valve.
2. Place the compression nut and ferrule (sleeve) onto the end of the tubing as shown.
3. Insert the end of the copper tubing into the connection as far as possible. While holding the tubing, tighten the fitting.

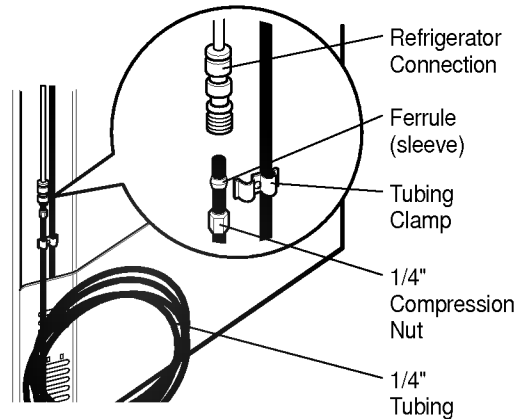

Turn the Water On at the Shutoff Valve

Tighten any connections that leak.

■ Plug In the Refrigerator

Arrange the coil of copper tubing behind the refrigerator so it does not vibrate against the back of the refrigerator or against the wall. Push the refrigerator back to the wall.

■ Start the Icemaker

Set the icemaking stop switch to the ON position. The icemaker will not begin to operate until it reaches its operating temperature of 15 °F (-9 °C). It will then begin operation automatically if the icemaking stop switch is in the ON position.

Automatic Ice maker

- The automatic icemaker makes 8 cubes at a time, 120/150 pieces per day. But these quantities may vary according to circumstance, including ambient temperature, door openings, freezer load, etc.
- The Icemaker stops when the bin is full.

When Icemaker Does Not Operate Smoothly

Ice is clumped together

- When ice is clumped together, take the ice clumps out of the ice storage bin, break them into small pieces, and then place them into the ice storage bin again.
- When the icemaker produces too small or clumped ice, the amount of water supplied to the ice maker must be adjusted. Contact the service center.
- If ice is not used frequently, it may clump together.

Power failure

- Water may drop into the freezer compartment. Take the ice storage bin out and discard all the ice. Dry the bin and replace it.

The unit is newly installed

- It takes about 12 hours for a newly installed refrigerator to make ice.

CAUTION

Throw away the ice.

The first ice and water may include particles or odor from the feed water pipe or feed water box.

This is also necessary if the refrigerator has not been used for a long time.

Never store beverage cans or other foods in ice storage bin for the purpose of rapid cooling.

Such actions may damage the automatic ice maker.

Never remove the icemaker cover.

Shake the bin occasionally to cause the ice to settle.

Ice may pile up just around the icemaker causing the icemaker to think that the ice storage bin is full.

If discolored ice is dispensed, contact an Authorized Service Center immediately. Do not use the ice or water until the problem is corrected.

Height Adjustment

If the freezer compartment door is lower than the refrigerator compartment door

Level the door by inserting flat (- type) driver into the groove of the left height adjusting screw and rotating it clockwise ①.

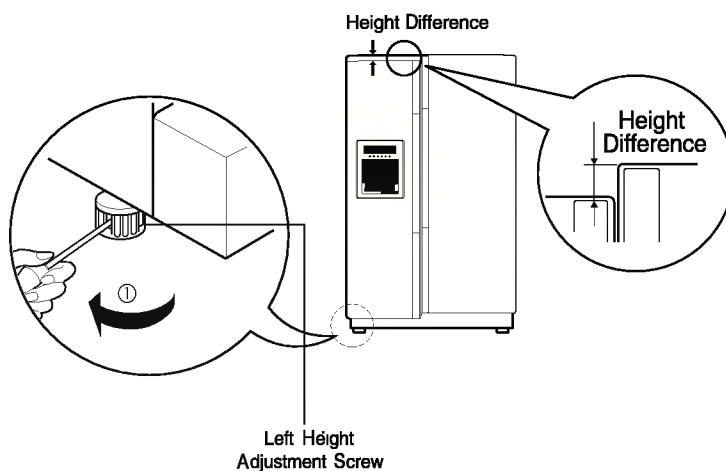

If the freezer compartment door is higher than the refrigerator compartment door

Level the door by inserting flat (- type) driver into the groove of the right height adjusting screw and rotating it clockwise ①.

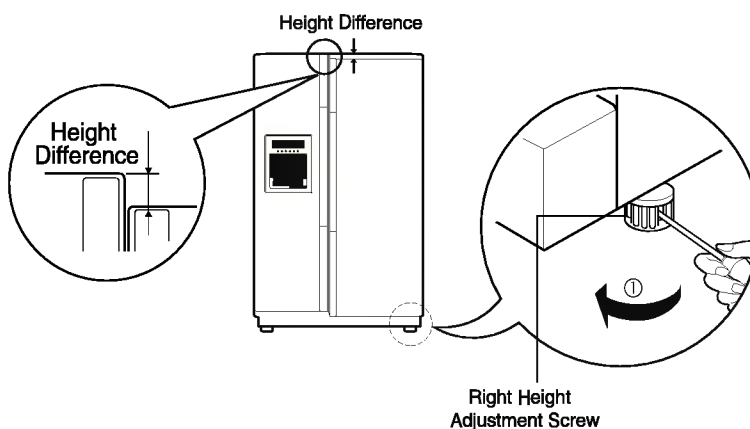

After leveling the door height

The refrigerator doors will close smoothly by adjusting the height adjusting screw. If the doors do not close correctly, performance may be affected.

Next

1. Wipe off all dust accumulated during shipping and clean your appliance thoroughly.
2. Install accessories such as the ice cube box, cover evaporating tray, etc., in their proper places. They are packed together to prevent possible damage during shipping.
3. Connect the power supply cord (or plug) to the outlet. Use this appliance on a single-outlet circuit.

Starting

When your refrigerator is first installed, allow it to stabilize at normal operating temperatures for 2-3 hours prior to filling it with fresh or frozen foods. If operation is interrupted, wait 5 minutes before restarting.

Adjusting The Temperatures and Functions

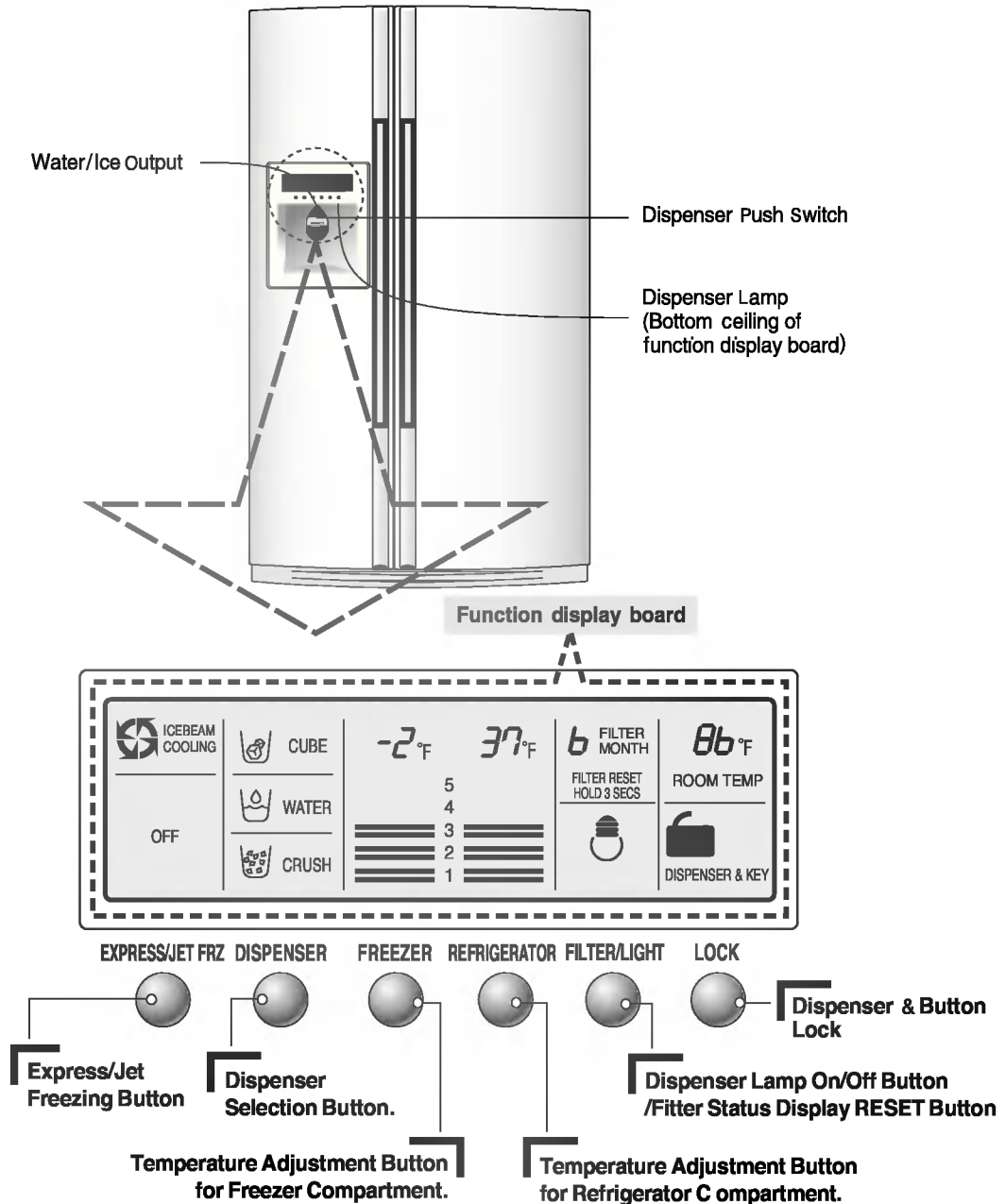

- **JET FRZ** : APPLICABLE TO SOME MODEL ONLY.
- When the button is pushed, the buzzer sounds.

You can adjust temperature of freezer room and refrigerator Compartment.

How to adjust the temperature in the freezer compartment

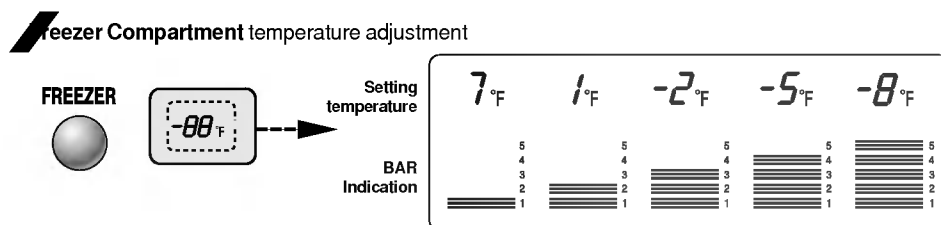

How to adjust the temperature in the refrigerator compartment

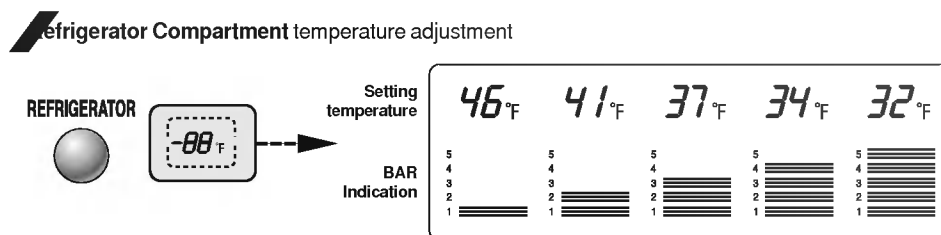

* Whenever pressing button, setting is repeated in the order of (Middle) → (Middle Strong) → (Strong) → (Weak) → (Middle Weak).

- The actual inner temperature varies depending on the food status, as the indicated setting temperature is the target temperature, not actual temperature within refrigerator.
- Refrigeration function is weak in the initial time. Please adjust temperature as above after using refrigerator for minimum 2~3 days.

Dispenser selection

You can select water or ice.

- * Please select water, Crushed ice, or cubed ice by pressing **DISPENSER** button as you desire.
- * Please press the button gently by pushing in cup.
 - You will hear a clap when the ice door closes after ice is dispensed.

- **Reference** : Hold your cup in place for a couple of seconds after dispensing ice or water so the last few drips go in your cup instead of on the floor.

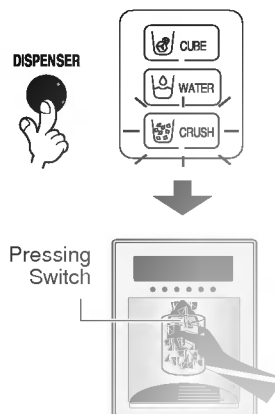

Automatic Icemaker

- The automatic icemaker can automatically make 8 cubes at a time, 120~150 pieces per day. This quantity may vary by circumstance, including ambient temperature, door opening, freezer load. etc.
- Icemaking stops when the ice storage bin is full.
- If you don't want to use automatic icemaker, turn the icemaker switch to OFF.
If you want to use automatic ice-maker again, change the switch to ON.

NOTE

- It is normal that a noise is produced when ice made drops into the ice storage bin.

When ice maker does not operate smoothly

Ice is lumped together

- If the ice lumps together, take it out, break it apart, and put it back into the storage bin.
- When the ice maker produces too small or lumped together ice, the amount of water supplied to the ice maker needs to adjusted. Contact the service center.
- ※ If ice is not used frequently, it may lump together.

Power failure

- Ice may drop into the freezer compartment. Take the ice storage bin out and discard all the ice then dry it and place it back. After the machine is powered again, crushed ice will be automatically selected.

The unit is newly installed

- It takes about 12 hours for a newly installed refrigerator to make ice.

Jet Freezer

Please select this function for prompt freezer.

- "OFF→ EXPRESS FRZ→ JET FRZ→ OFF" or "OFF→ ON→ OFF" is repeated whenever pressing  button.
- The arrow mark graphic remains at the On status after flickering 4 times when selecting Special Refrigeration On
- Prompt freezer function automatically turns off after a fixed time passes.
- JET FRZ : Applicable to some model only.

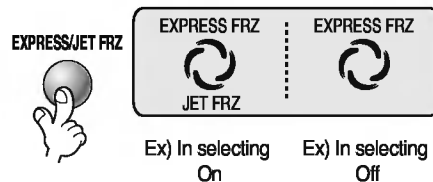

Lock

This button stops operation of different button and dispenser function.

- Locking or Release is repeated whenever the  is pressed more than 3 seconds.
- If you use the LOCK button, none of the other buttons will work until you unlock them.



The Other Functions

Ambient Temperature Display Window.

- Temperature is displayed only between 16°F ~ 120°F.
- Temperature less than 15°F is indicated with LO and temperature more than 121°F is indicated with HI.



Door open warning

- A warning tone will sound 3 times at thirty-second intervals if the refrigerator or freezer door is left open for more than sixty seconds.
- Please contact with the local service center if warning continue to sound even after closing the door.

Diagnosis (failure detection) function

- Diagnosis function automatically detects failure when failure is found in product during the use of refrigerator.
- If your refrigerator fails, do not turn off the power. Instead, contact a local Authorized service center or call our support line for assistance. Turning off the appliance will make it more difficult for the service technician to determine the problem.

How Ice/Cold Water is Supplied

Water is cooled while stored in the water tank in freezer door, and then sent to the dispenser.

Ice is made in the automatic icemaker and sent to the dispenser divided into crushed or cubed ice.

How to Use Dispenser

- Select among crushed ice, water, and cubed ice and press the push switch with a glass or other container.

Water

Light the water lamp by pressing the selection button.

- Water will be dispensed by pressing the push switch with a glass.

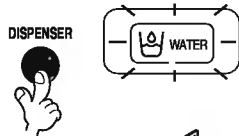

Crushed Ice

Light the crushed ice lamp by pressing the selection button.

- Crushed ice will be dispensed by pressing the push switch with a glass.

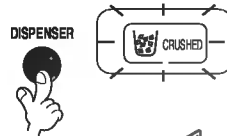

Cubed Ice

Light the cubed ice lamp by pressing the selection button.

- Cubed ice will be dispensed by pressing the push switch with a glass.

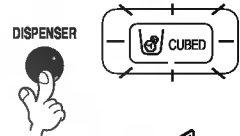

Automatic Ice Maker

NOTE

- Crushed ice will be automatically selected after a power failure or when the power plug is connected again.
- Place glasses or other containers near the ice outlet otherwise ice is likely to be dropped on the floor.
- A snap sound will be heard 5 seconds after ice is fully dispensed. This sound is made when the ice outlet is closed.
- Please leave your glass near the ice outlet for 2-3 seconds after releasing your glass from pressing the push switch to allow any left over water or ice to be dispensed.
- Please wipe away water dropped below the dispenser by removing the water collector cover.
- If cubed ice is selected following crushed ice, there may still be some left over crushed ice dispensed.

- The automatic icemaker can automatically make 8 cubes at a time, 120-150 pieces per day. This quantity may vary by circumstance, including ambient temperature, door openings, freezer load. etc.
- Icemaking stops when the ice storage bin is full.
- If you don't want to use automatic icemaker, turn the icemaker switch to OFF. If you decide you want to use the icemaker, turn the switch to ON.

NOTE

- It is normal that a noise is produced when ice made is dropped into the ice storage bin.

When Ice Maker Does Not Operate Smoothly

Ice is lumped together

- When ice is lumped together, take the ice out of the ice storage bin, break it into small pieces, and then place them into the ice storage bin again.
 - When the ice maker produces too small or lumped together ice, the amount of water supplied to the ice maker need to adjusted. Contact the service center.
- * If ice is not used frequently, it may lump together.

Power failure

- Ice may drop into the freezer compartment. Take the ice storage bin out and discard all the ice then dry it and place it back. After the machine is powered again, crushed ice will be automatically selected.

The unit is newly installed

- It takes about 12 hours for a newly installed refrigerator to make ice in the freezer compartment.

Dispenser Light

- Dispenser switch or dispenser light button turn the dispenser light in the dispenser on and off.
- The dispenser light Function is repeated following below whenever pressing "FILTER RESET/LIGHT" button.



- If dispenser light continuously turns on more than 7 minutes with dispenser light button, the dispenser light turns off automatically by compulsion.

6 Filter Condition (filter replacement cycle) Display Function



LCD(GR-267AV(T)BA Model)

- As demonstrated below, it displays the months left in units of 30 days or about 4,700 seconds of using water filter until the filter replacement is required, starting from when the refrigerator power usage is first begun.
- After 6 months, the following sentence and  will appear on the filter condition part of the LCD. **FILTER LIGHT 3SECS.**
- After 6 months have passed, and if the filter has been replaced or you want to reset the filter condition display, press the filter replacement button more than 3 seconds and it will reset to the initial Power On state.

Classification	In Initial Power On	Pass of a month	Pass of 2 months	Pass of 3 months	Pass of 4 months	Pass of 5 months	Pass of 6 months
Filter Status Display	6 FILTER MONTH	5 FILTER MONTH	4 FILTER MONTH	3 FILTER MONTH	2 FILTER MONTH	1 FILTER MONTH	0 FILTER MONTH 

LED(GR-L267AV(T)BA other Model)

- There is a replacement indicator light for the water filter cartridge on the dispenser.
- Water filter needs replacement once six months or about 28,000 seconds of using water filter.
- FILTER RESET HOLD 3SECS text turn on to tell you need to replace the filter soon.
- After replace the filter, press and hold the lock button more than 3seconds. FILTER RESET HOLD 3SECS text turn off with reset status.

Classification	In Initial Power On / Filter RESET	Replace Indicator light on
Filter Status Display		

Cautions

Throw away the ice (about 20 pieces) and water (about 7 glasses) first made after refrigerator installation.

This is also necessary when the refrigerator has not been used for a long time.

Keep children away from the dispenser.

Children may play with or damage the controls.

Be careful that food does not block the ice passage.

If foods are placed at the entrance of ice passage, the dispenser may malfunction. The passage may also become blocked with frost if only crushed ice is used. Remove the frost that accumulates.

Storing cans or other items in the ice bin may damage the icemaker or the container may burst.

Never use thin crystal glass or crockery to collect ice.

Such glasses or containers may be broken.

Put ice first into a glass before filling water or other beverages.

Water may be splashed if ice is added to existing liquid in a glass.

Keep your hands and tools out of the ice door and passage.

You might break something or injure yourself.

Never remove the ice maker cover.

Shake the ice bin occasionally to level the ice in it.

Sometimes the ice piles up near the icemaker, causing the icemaker to misread the bin level and stop producing ice.

If discovered ice or water is dispensed, contact an Authorized service center immediately and discontinue use until the problem is corrected.

Never use too narrow or deep glass.

Ice may be jammed in ice passage and, thus, the refrigerator may be failed.

Keep the glass at a proper distance from ice outlet.

A glass too close to the outlet may hinder ice from coming out.

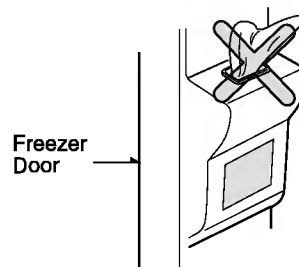

Shelf Height Adjustment

Shelf

The refrigerator compartment shelf is movable so that you can place it at a height according to space requirement of foods.

How to separate a shelf :

Lift the shelf in the direction of Arrow ①, then remove it from the rack by pulling it in the direction of Arrow ② .

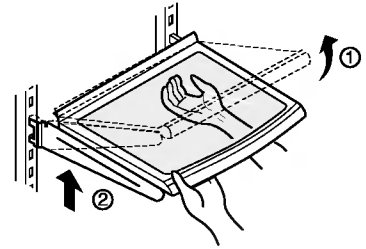

How to install a shelf :

Holding the shelf up at the front, insert the tab at the desired height and lower the shelf into place.

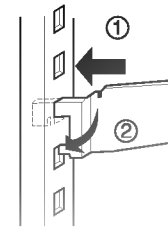

Wine Holder Adjustment

Wine Holder (Applicable to some models only)

Bottles can be stored on their sides in this wine rack. It can be attached to any shelf.

Wine holder adjustment :

Wine holder can be separated by pulling it straight out and installed by placing it at the end of the shelf you want and pushing it inward.

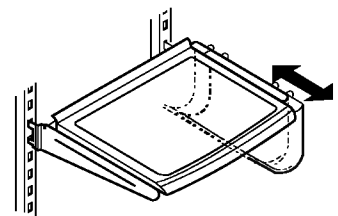
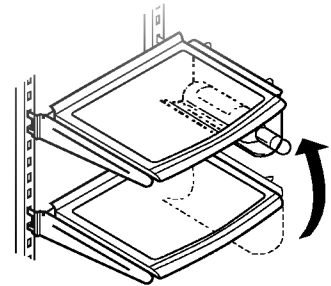

Can Server Adjustment

Can Server adjustment (Applicable to some models only)

Cans be stored on their sides out of the way using the can-server. It can be attached to an upper shelf only.

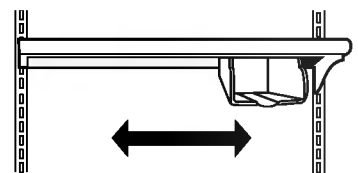

Egg Bin (Applicable to some models only)

You can place the egg box to wherever you want it.

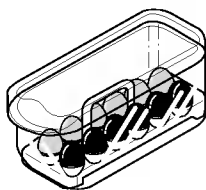

[Normal]

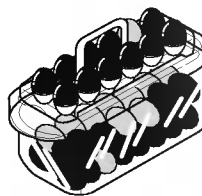

[For Many Eggs]

NOTE

- Never use the egg box as an ice storage bin. It can be broken.
- Never store the egg box in the freezer compartment or fresh compartment.

Humidity control in the vegetable compartment

The humidity can be controlled by adjusting the humidity control switch to the left or right when storing vegetables or fruits.

High humidity

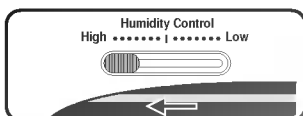

Low humidity

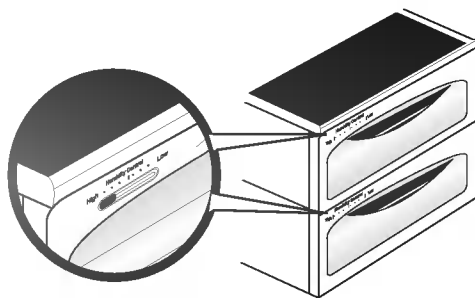
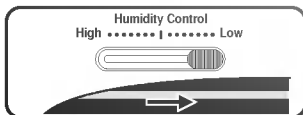

Convert into a vegetable or meat compartment (Applicable to some models only)

- The bottom drawer in the refrigerator can be converted into a vegetable or meat compartment

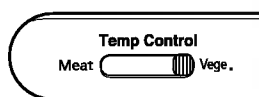

Vegetable compartment

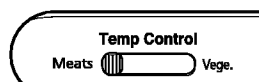

Meat compartment

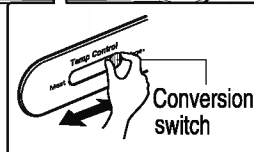

Be sure to check the conversion switch before storing foods.

The meat compartment maintains the temperature at a lower point than the refrigerator compartment so that meat or fish can be stored fresh longer.

NOTE

- Vegetables or fruits are frozen if the conversion switch is set to meats compartment. Be sure to check it before storing foods.

OptiChill Temperature Transition Corner (Applicable to some models only)

By pressing the button, store vegetables, fruits or other types of food such as meat to be defrosted, raw fish, etc.



Temperature Change at OptiChill

Method to Use

You can select optimum temperature range depending on types of foods stored.

- four steps of temperature selection are available, including 27°F, 30°F, 39°F and 50°F. Vegetables, fruits, cold storage items requiring humidity maintenance, meats, and fishes can be stored under optimal conditions by selecting the correct storage temperature for the foods being stored.

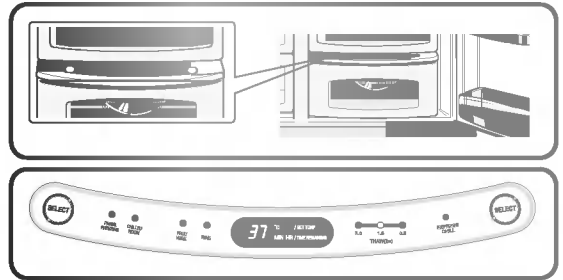

- When using the OptiChill to store meats or fishes, fruits, or vegetables may be frozen.
- When using the OptiChill to store fruits or vegetables, meats and fishes must be stored in the freezer compartments.
- If you open the refrigerator door, an indicator lamp shows the status of the Optichill. The lamp goes off when the door is closed.
- Press the left SELECT button to cycle through FRUIT VEGE(39°F)→ CHILLED ROOM(30°F)→ PARTIAL FREEZING(27°F)→ WINE(50°F_Option)→ FRUIT VEGE(39°F).
- Press the right SELECT button to cycle between EXPRESS CHILL→ THAW(Optional).
- The thawing setting can be adjusted by the weight of the meats being thawed.
- The THAW and the EXPRESS CHILL operations are cancelled when you press left button.

OptiChill

When Removing OptiChill

- First, remove the vegetable bin.
- After holding back and front of the OptiChill ① and ② pull it outward.

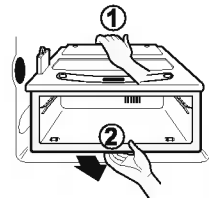





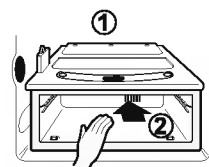



When Installing OptiChill

- Fit the OptiChill case on to the ledge ① and gently slide it in ②.
- When forced, the connecting parts can be damaged.

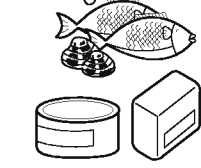
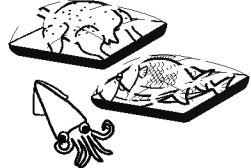

Location of Foods

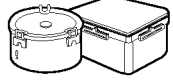
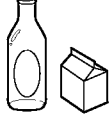
(Refer to Identification of Parts)

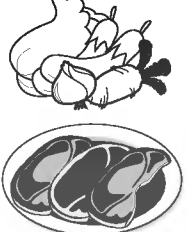
Wine Holder	Store wine.	
Snack Drawer	Store small foods such as bread, snacks, etc.	
Freezer Compartment Shelf	Store various frozen foods such as meat, fish, ice cream, frozen snacks, etc.	
Freezer Compartment Door Rack	<ul style="list-style-type: none">▪ Store small packed frozen food.▪ Temperature is likely to increase as door opens. So, do not store long-term food such as ice cream, etc.	
Freezer Compartment Drawer	<ul style="list-style-type: none">▪ Store meat, fish, chicken, etc. after wrapping them with thin foil.▪ Store dry.	
Milk Product Corner	Store milk products such as butter, cheese, etc.	
Egg Bin	Place this egg box in the proper location.	
Refreshment Center	Store foods of frequent use such as beverage, etc.	
Refrigerator Compartment Shelf	Store side dishes or other foods at a proper distance.	
Refrigerator Compartment Door Rack	Store small packed food or beverages such as milk, juice, beer, etc.	
Vegetable Drawer	Store vegetables or fruits.	
Vegetable Drawer /Meat Drawer Conversion Corner	Store vegetable, fruits, meat to thaw, raw fish, etc. setting the conversion switch as necessary. Be sure to check the conversion switch setting before storing foods.	

Storing Foods

- Store fresh food in the refrigerator compartment. How food is frozen and thawed is an important factor in maintaining its freshness and flavor.
- Do not store food which spoils easily at low temperatures, such as bananas and melons.
- Allow hot food to cool prior to storing, placing hot food in the refrigerator could spoil other food, and lead to higher energy consumption.
- When storing the food, cover it with vinyl wrap or store in a container with a lid. This prevents moisture from evaporating, and helps food to keep its taste and nutrients.
- Do not block air vents with food. Smooth circulation of chilled air keeps refrigerator temperatures even.
- Do not open the door frequently. Opening the door lets warm air enter the refrigerator, and cause temperatures to rise.
- Never keep too much food in door rack because they may push against by inner racks so that the door cannot be fully closed.

Freezer Compartment

- Do not store bottles in the freezer compartment - they may break when frozen.
- Do not refreeze food that has been thawed. This causes loss of taste and nutrient.
- When storing frozen food like ice cream for a long period, place it on the freezer shelf, not in the door rack.

Refrigerator Compartment

- Avoid placing moist food in top refrigerator shelves, it could freeze from direct contact with chilled air.
- Always clean food prior to refrigeration. Vegetables and fruits should be washed and wiped, and packed food should be wiped, to prevent adjacent food from spoiling.
- When storing eggs in their storage rack or box, ensure that they are fresh, and always store them in an upright position, which keeps them fresh longer.

NOTE

- If you keep the refrigerator in a hot and humid place, frequent opening of the door or storing a lot of vegetables in it may cause condensation to form which has no effect on its performance. Remove the condensation with dust cloth free from care.

How to Dismantle Parts

NOTE

- Dismantling is done in the reverse sequence of assembly.
Be sure to unplug the power plug before dismantling and assembly.
Never apply severe force to dismantle parts. Parts may be damaged.

Freezer Compartment Lamp

Separate the lamp by pulling it out ③ while slightly striking ① and rotating ② the lamp cover. Turn the bulb counterclockwise. Max. 40 W bulb for refrigerator is used and can be purchased at a service center.

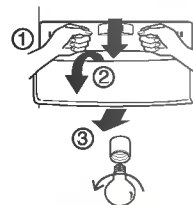

Dispenser Lamp

Separate the lamp by pulling it out, and then remove the lamp. Max. 15 W bulb for refrigerator is used and can be purchased at a service center.

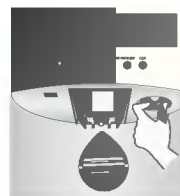

Freezer Compartment Shelf

To remove a shelf, lift the left part of the shelf a bit, push it to the direction ①, lift the right part to the direction ②, and take it out.

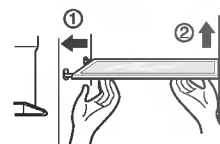

Door Rack and Support

Lift the door rack holding both sides ① and pull it out to ② direction.



Ice Storage Bin

Hold the ice storage bin as shown in the right figure and pull it out ② while slightly lifting it ①.

- It is recommended not to dismantle the ice storage bin unless it is necessary.
- Use both hands to remove the ice bin to avoid dropping it.
- If the ice bin does not slide into place easily, twist the drive device slightly.

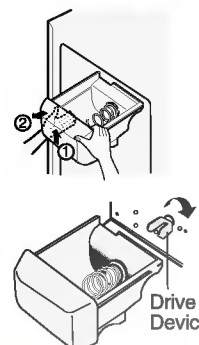

After Dispenser Is Used

The water collector has no self-drainage function. It should be cleaned regularly. Remove the cover by pulling the front side of water collector cover and dry it with a cloth.

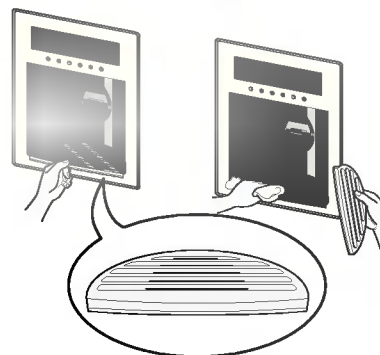

Lamp in Refrigerator Compartment

To remove the lamp cover, press the protrusion under the lamp cover to the front and then pull the lamp cover out. Turn the bulb counterclockwise. Max. 40 W bulb for refrigerator is used and can be purchased at a service center.

NOTE

- Be sure to remove parts from the refrigerator door when removing the vegetable compartment, snack drawer, and refreshment center cover.

Vegetable Compartment Cover

- To remove the vegetable compartment cover, pull out the vegetable compartment a bit to the front ①, lift the front part of the vegetable compartment cover as shown by ②, and take it out.

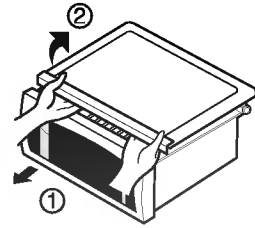

General Information

Vacation Time	<p>During average length vacations, you will probably find it best to leave the refrigerator in operation. Place freezable items in freezer for longer life.</p> <p>When you plan to store the refrigerator, remove all food, disconnect the power cord, clean the interior thoroughly, and Block the doors open to prevent mold and mildew. Be certain the stored refrigerator does not present a child entrapment danger.</p>
Power Failure	<p>Most power failures that are corrected in an hour or two will not affect your refrigerator temperatures.</p> <p>However, you should minimize the number of door openings while the power is off.</p>
If You Move	<p>Remove or securely fasten down all loose items inside the refrigerator.</p> <p>To avoid damaging the height adjusting screws, turn them all the way into the base.</p>
Anti-Condensation Pipe	<p>The outside wall of the refrigerator cabinet may sometimes get warm, especially just after installation.</p> <p>Don't be alarmed. This is due to the anti-condensation pipe, which pumps hot refrigerant to prevent sweating on the outer cabinet wall.</p>

Cleaning

It is important that your refrigerator be kept clean to prevent undesirable odors. Spilled food should be wiped up immediately, since it may acidify and stain plastic surfaces if allowed to settle.

Exterior	Use a lukewarm solution of mild soap or detergent to clean the durable finish of your refrigerator. Wipe with a clean damp cloth and then dry.
Interior	Regular cleaning is recommended. Wash all compartments a baking soda solution or a mild detergent and warm water. Rinse and dry.
After Cleaning	Please verify that the power cord is not damaged, power plug is not overheated, or power plug is well inserted into the power consent.
Warning	<p>Always remove power cord from the wall outlet prior to cleaning in the vicinity of electrical parts (lamps, switches, controls, etc.).</p> <p>Wipe up excess moisture with a sponge or cloth to prevent water or liquid from getting into any electrical part and causing an electric shock.</p> <p>Never use metallic scouring pads, brushes, coarse abrasive cleaners, strong alkaline solutions, flammable or toxic cleaning liquids on any surface.</p> <p>Do not touch frozen surfaces with wet or damp hands, because damp object will stick or adhere to extremely cold surfaces.</p>

Troubleshooting

Before calling for service, review this list. It may save you both time and expense. This list includes common occurrences that are not the result of defective workmanship or materials in this appliance.

Runing of refrigerator

Refrigerator compressor does not run.	Refrigerator control is off.	Set refrigerator control. See setting the controls.
	Refrigerator is in defrost cycle.	This is normal for a fully automatic defrosting refrigerator. The defrost cycle occurs periodically.
	Plug at wall outlet is disconnected.	Make sure plug is tightly pushed into outlet.
	Power outage. Check house lights.	Call local electric company.
Refrigerator runs too much or too long	Refrigerator is larger than the previous one you owned.	This is normal. Larger, more efficient units run longer in these conditions.
	Room or outside weather is hot.	It is normal for the refrigerator to work longer under these conditions.
	Refrigerator has recently been disconnected for a period of time.	It takes some hours for the refrigerator to cool down completely.
	Large amounts of warm or hot food may have been stored recently.	Warm food will cause the refrigerator to run longer until the desired temperature is reached.
	Doors are opened too frequently or too long.	Warm air entering the refrigerator causes it to run longer. Open the door less often.
	Refrigerator or freezer door may be slightly open.	Make sure the refrigerator is level. Keep food and containers from blocking door. See problem section. OPENING/CLOSING of doors.
	Refrigerator control is set too cold.	Set the refrigerator control to a warmer setting until the refrigerator temperature is satisfactory.
	Refrigerator or freezer gasket is dirty, worn, cracked, or poorly fitted.	Clean or change gasket. Leaks in the door seal will cause refrigerator to run longer in order to maintain desired temperatures.
	Thermostat is keeping the refrigerator at a constant temperature.	This is normal. Refrigerator goes on and off to keep the temperature constant.

Refrigerator compressor does not run.

Thermostat is keeping the refrigerator at a constant temperature.

This is normal. The refrigerator goes on and off to keep the temperature constant.

Temperatures are too cold

Temperature in the freezer is too cold but the refrigerator temperature is satisfactory.

Freezer control is set too cold

Set the freezer control to a warmer setting until the freezer temperature is satisfactory.

Temperature in the refrigerator is too cold and the freezer temperature is satisfactory.

Refrigerator control is set too cold.

Set the refrigerator control to a warmer setting

Food stored in drawers freezes.

Refrigerator control is set too cold.

See above solution.

Meat stored in fresh meat drawer freezes.

Meat should be stored at a temperature just below the freezing point of water (32°F, 0°C) for maximum fresh storage time.

It is normal for ice crystals to form due to the moisture content of meat.

Temperatures are too warm

Temperatures in the refrigerator or freezer are too warm.

Freezer control is set too warm.

Set the freezer or refrigerator control to a colder setting until the freezer or refrigerator temperature is satisfactory.

Refrigerator control is set too warm. Refrigerator control has some effect on freezer temperature.

Set the freezer or refrigerator control to a colder setting until the freezer or refrigerator temperature is satisfactory.

Doors are opened too frequently or too long.

Warm air enters the refrigerator/ freezer whenever the door is opened. Open the door less often.

Door is slightly open.

Close the door completely.

Large amounts of warm or hot food may have been stored recently.

Wait until the refrigerator or freezer has a chance to reach its selected temperature.

Refrigerator has recently been disconnected for a period of time.

A refrigerator requires some hours to cool down completely.

Temperature in the refrigerator is too warm but the freezer temperature is satisfactory.

Refrigerator control is set too warm.

Set the refrigerator control to a colder setting.

Sound and noise

Louder sound levels when refrigerator is on.	Today's refrigerators have increased storage capacity and maintain more even temperatures.	It is normal for sound levels to be higher.
Louder sound levels when compressor comes on.	Refrigerator operates at higher pressures during the start of the ON cycle.	This is normal. The sound will level off as the refrigerator continues to run.
Vibrating or rattling noise.	Floor is uneven or weak. Refrigerator rocks on the floor when it is moved slightly.	Be sure floor is level and solid and can adequately support refrigerator.
	Items placed on the top of the refrigerator are vibrating.	Remove items.
	Dishes are vibrating on the shelves in the refrigerator.	It is normal for dishes to vibrate slightly. Move dishes slightly. Make sure refrigerator is level and firmly set on floor.
	Refrigerator is touching wall or cabinets.	Move refrigerator so that it does not touch the wall or refrigerator.

Water/Moisture/Ice inside refrigerator

Moisture collects on the inside walls of the refrigerator.	The weather is hot and humid which increases the rate of frost buildup and internal sweating.	This is normal.
	Door is slightly open.	See problem section opening/closing of doors.
	Door is opened too often or too long.	Open the door less often.

Water/Moisture/Ice outside refrigerator

Moisture forms on the outside of the refrigerator or between doors.	Weather is humid.	This is normal in humid weather. When humidity is lower, the moisture should disappear.
	Door is slightly open, causing cold air from the inside the refrigerator to meet warm air from the outside.	This time, close the door completely.

Odors in refrigerator

	Interior needs to be cleaned.	Clean interior with sponge,warm water and baking soda.
	Food with strong odor is in the refrigerator.	Cover food completely.
	Some containers and wrapping materials produce odors.	Use a different container or brand of wrapping materials.

Opening/Closing of doors/Drawers

Door(s) will not close.	Food package is keeping door open.	Move packages that keep door from closing.
Door(s) will not close.	Door was closed too hard, causing other door to open slightly.	Close both doors gently.
	Refrigerator is not level. It rocks on the floor when it is moved slightly.	Adjust the height adjusting screw.
	Floor is uneven or weak. Refrigerator rocks on the floor when it is moved slightly.	Be sure floor is level and can adequately support refrigerator. Contact carpenter to correct sagging or sloping floor.
	Refrigerator is touching wall or cabinets.	Move refrigerator..
Drawers are difficult to move.	Food is touching shelf on top of the drawer	Keep less food in drawer.
	Track that drawer slides on is dirty.	Clean drawer and track.

Dispenser

Dispenser will not dispense ice	Ice storage bin is empty.	When the first supply of ice is dropped into the bin, the dispenser should operate.
	Freezer temperature is set too warm.	Turn the freezer control to a higher setting so that ice cubes will be made. When the first supply of ice is made, the dispenser should operate.
	Household water line valve is not open.	Open household water line valve and allow sufficient time for ice to be made. When ice is made, dispenser should operate.
	Refrigerator or freezer door is not closed.	Be sure both doors are closed.

Dispenser will not dispense ice.	Ice has melted and frozen around auger due to infrequent use, temperature fluctuations and/or power outages.	Remove ice storage bin, and thaw and the contents. Clean bin, wipe dry and replace in proper position. When new ice is made, dispenser should operate.
Ice dispenser is jammed.	Ice cubes are jammed between the ice maker arm and back of the bin.	Remove the ice cubes that are jamming the dispenser.
	Ice cubes are frozen together.	Use the dispenser often so that cubes do not freeze together.
	Ice cubes that have been purchased or made in some other way have been used in the dispenser.	Only the ice cubes made by the ice maker should be used with the dispenser.
Dispenser will not dispense water.	Household water line valve is not open. See problem Icemaker is not making any ice.	Open household water line valve.
	Refrigerator or freezer door is not closed.	Be sure both doors are closed.
Water has an odd taste and/or odor.	Water has been in the tank for too long.	Draw and discard 7 glasses of water to freshen the supply. Draw and discard an additional 7 glasses to completely rinse out tank.
	Unit not properly connected to cold water line.	Connect unit to cold water line which supplies water to kitchen faucet.
Sound of ice dropping	This sound is normally made when automatically made ice is dropped into ice storage bin. Volume may vary according to refrigerator's location.	
Sound of water supply	This sound is normally made when ice maker is supplied with water after dropping the automatically made ice.	
Other	Please thoroughly read Automatic icemaker and dispenser in this manual.	

CUSTOMER ASSISTANCE NUMBERS:

<http://www.lgservice.com>

- To Prove Warranty Coverage
Retain your Sales Receipt to prove date of purchase.
A copy of your Sales Receipt must be submitted at the time warranty service is provided.
- To Obtain Product, Customer or Service Assistance
Call Toll-free for Customer Service
Tel : 1-877-714-7486
- To Obtain Nearest Authorized Service Center
Call 1-877-714-7486, push option #1, 24 hours a day, 7days per week.
Please have your product type (Monitor, TV, VCR, MWO, Refrigerator) and ZIP code ready.



LG Electronics Inc.

LG Twin Tower, 20, Yoido-Dong,
Youngdungpo-Gu, Seoul, 150-721, Korea.
<http://www.lge.com>